



Sistemi elettronici e accensione,
Electronic systems and ignition,
Elektronische Systeme und Zündung,
Systèmes électroniques et allumage,
Sistemas electrónicos y de encendido,
Sistemas eletrônicos e ignição,
Συστήματα ψεκασμού & αναφλέξης κινητήρα,
Systemy elektroniczne i zapłon,
Электронные системы и зажигание,
Elektronik sistemler ve ateşleme

Indice
Contents
Inhaltsverzeichnis
Sommaire
Índice
Índice
Περιεχόμενα
Spis treści
Содержание
Índeks

Indice costruttori
 Manufacturers index
 Herstellerverzeichnis
 Sommaire par marques
 Índice constructores
 Índice de montadoras
 Ευρετήριο κατασκευαστών
 Indeks producentów
 Индекс изготовителей
 Üreticiler

4

Legenda
 Legend
 Legende
 Légende
 Leyenda
 Legenda
 Υπόμνημα
 Legenda
 Легенда
 Semboller

7

Applicazione per marca e veicolo
 Vehicle application guide
 Zuordnung nach Marke und Fahrzeug
 Affectations par marques et véhicules
 Aplicación por marca y vehículo
 Aplicação por marca e veículo
 Εφαρμογή ανά μοντέλο
 Zastosowanie dla marki i pojazdu
 Применение по марке и модели
 Marka ve araca göre uygulama

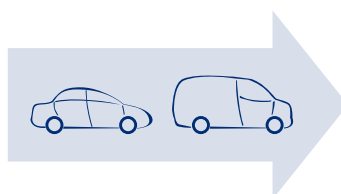

13

Applicazione per codice
 Buyers guide
 Zuordnung nach Bestellnummer
 Affectations par références
 Aplicación por referencia
 Aplicação por código
 Εφαρμογές ανά κωδικό
 Zastosowanie dla kodu
 Применение по коду
 Koda göre uygulama

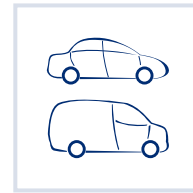

1245

GROUP	DESCRIPTION	TYPE	
A	CENTRALINA CONTROLLO CAMBIO - <i>TRANSMISSION CONTROL UNIT</i>	A3	1247
	CENTRALINA CONTROLLO MOTORE - <i>ENGINE CONTROL UNIT</i>	A1	1247
	CENTRALINA CONTROLLO MOTORE RIGENERATA - <i>ENGINE CONTROL UNIT REMANUFACTURED</i>	A2	1271
B	ATTUATORE CONTROLLO MINIMO - <i>IDLE SPEED CONTROL ACTUATOR KIT</i>	B1	1272
	CABLAGGIO PER 54DTS3 - <i>CABLE FOR THROTTLE BODY 54DTS3</i>	B2	1290
	COLLETTORE CONTROLLO MOTORE - <i>ENGINE COLLECTOR BODY</i>	B2	1291
	CORPO FARFALLATO - <i>THROTTLE BODY</i>	B3	1292
	KIT ELETTROVALVOLA CANISTER - <i>CANISTER VALVE KIT</i>	B2	1314
	REGOLATORE ARIA MOTORE - <i>CONTROL FLAP - AIR SUPPLY</i>	B3	1316
	SENSORE MASSA ARIA - <i>AIR MASS SENSOR</i>	B4	1318
	SENSORE PEDALE ACCELERATORE - <i>ACCELERATOR PEDAL SENSOR</i>	B5	1333
	SENSORE POSIZIONE FARFALLA - <i>THROTTLE POSITION SENSOR</i>	B6	1338
	TUBO CONN. CANINSTER - <i>TUBE CONNECTING CANISTER VALVE</i>	B2	1362
VALVOLA DI REGOLAZIONE - <i>IDLE CONTROL VALVE</i>	B2	1362	
C	INIETTORE - <i>FUEL INJECTOR</i>	-	1363
	KIT INIETTORE - <i>FUEL INJECTOR KIT</i>	-	1380
D	SENSORE PRESSIONE ASSOLUTA - <i>MAP SENSOR</i>	-	1381
	SENSORE PRESSIONE SCARICO - <i>EXHAUST PRESSURE SENSOR</i>	-	1439
E	REGOLATORE PRESSIONE CARBURANTE - <i>FUEL PRESSURE REGULATOR</i>	-	1441
	REGOLATORE PRESSIONE CARBURANTE KIT - <i>FUEL PRESSURE REGULATOR KIT</i>	-	1451
F	KIT SENSORE TEMPERATURA ACQUA - <i>WATER TEMPERATURE SENSOR KIT</i>	F1	1453
	SENSORE TEMPERATURA ACQUA - <i>WATER TEMPERATURE SENSOR</i>	F1	1454
	SENSORE TEMPERATURA ARIA - <i>AIR TEMPERATURE SENSOR</i>	F2	1460
	SENSORE TEMPERATURA OLIO - <i>OIL TEMPERATURE SENSOR</i>	F3	1497
	SENSORE TEMPERATURA REFRIGERANTE - <i>COOLANT TEMPERATURE SENSOR</i>	F1	1503
	TERMOCONTATTO - VENTOLA RADIATORE - <i>FAN TEMPERATURE SWITCH</i>	F2	1623
G	INTERRUTTORE PRESSIONE OLIO - <i>OIL PRESSURE SWITCH</i>	-	1627
	MANOCONTATTO - <i>OIL PRESSURE SWITCH</i>	-	1650
	SENSORE PRESSIONE OLIO - <i>OIL PRESSURE SWITCH</i>	-	1651

GROUP	DESCRIPTION	TYPE	
H	SENSORE ACQUA CARBURANTE - <i>WATER SENSOR - FUEL SYSTEM</i>	H4	1682
	SENSORE DETONAZIONE - <i>KNOCK SENSOR</i>	H3	1684
	SENSORE GIRI / FASE - ALBERO MOTORE - <i>CRANKSHAFT POSITION SENSOR</i>	H1	1727
	SENSORE POSIZIONE ALBERO A CAM - <i>CAMSHAFT POSITION SENSOR</i>	H2	1876
I	BOBINA D'ACCENSIONE - <i>IGNITION COIL</i>	-	1963
J	COMANDO INDICATORE LIVELLO CARBURANTE - <i>FUEL LEVEL SENDER</i>	J3	2045
	GRUPPO ASPIRAZIONE CARBURANTE - <i>FUEL SUPPLY UNIT</i>	J2	2073
	POMPA CARBURANTE - <i>FUEL PUMP</i>	J1	2161
	POMPA CARBURANTE (CON VASO ANTIROLLIO) - <i>FUEL PUMP</i>	J1	2202
	POMPA CARBURANTE KIT - <i>FUEL PUMP KIT</i>	J1	2203

Tavole di comparazione OE/IAM
 OE/IAM cross reference guide
 Gegenüberstellung OE/IAM
 Table de correspondance OE/IAM
 Tabla de equivalencias OE/IAM
 Tabela de equivalências OE/IAM
 Πίνακας αντιστοιχιών OE/IAM
 Tabela porównawcza OE/IAM
 Кросс-таблица с OE/IAM номерами
 OE/IAM çapraz referans tablosu



Indice costruttori
Manufacturers index
Herstellerverzeichnis
Sommaire par marques
Índice constructores
Índice de montadoras
Ευρετήριο κατασκευαστών
Indeks producentów
Индекс изготовителей
Üreticiler

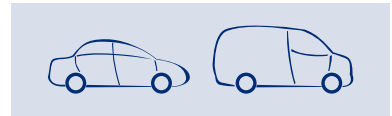

ALFA ROMEO	15
ALPINA.....	42
AUDI.....	42
AUTOBIANCHI	146
BENTLEY	146
BMW.....	146
CADILLAC.....	190
CHEVROLET.....	192
CHRYSLER.....	194
CITROËN	194
DACIA.....	258
DAEWOO	260
DAIHATSU.....	266
DODGE	270
FERRARI.....	270
FIAT	272
FORD	343



HONDA.....	444
HYUNDAI	452
INFINITI.....	464
INNOCENTI.....	464
ISUZU.....	464
IVECO	464
JAGUAR.....	478
JEEP.....	480
KIA.....	482
LADA	488
LANCIA.....	490
LAND ROVER	508
LEXUS.....	512
MARUTI.....	512
MASERATI	512
MAZDA.....	514
MERCEDES-BENZ	528
MG.....	660
MINI.....	662
MITSUBISHI.....	666
NISSAN	676
OPEL.....	694
PEUGEOT	788
PORSCHE.....	866
PROTON	870



RENAULT	872
ROLLS-ROYCE.....	946
ROVER.....	946
SAAB	952
SEAT	964
SKODA.....	990
SMART	1014
SSANGYONG	1018
SUBARU.....	1018
SUZUKI	1022
TOYOTA	1026
VAUXHALL.....	1050
VOLKSWAGEN	1100

Legenda
Legend
Legende
Légende
Leyenda
Legenda
Υπόμνημα
Legenda
Легенда
Semboller

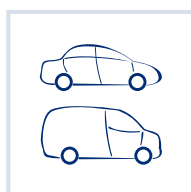

Costruttore e modello
 Make and model
 Hersteller und Modell
 Marque et modèle
 Constructor y modelo
 Montadora e modelo
 Μάρκα και μοντέλο
 Marka i model
 Производитель и модель
 Üretici ve model



Informazioni tecniche
 Technical information
 Technische Informationen
 Informations techniques
 Información técnica
 Informaçoes técnicas
 Τεχνικές πληροφορίες
 Informacje techniczne
 Техническая информация
 Teknik bilgiler



Anno di produzione
 Manufacturing year
 Baujahr
 Année de production
 Año de fabricación
 Ano de fabricação
 Έτος παραγωγής
 Rok produkcji
 Год производства
 Üretim yılı



Codice costruttore
 OE/IAM Reference
 Herstellernummer
 Référence Origine (OE/IAM)
 Código constructor
 Código de montadora
 Κωδικός κατασκευαστή
 Kod OE/IAM
 Оригинальные номера
 Üretici kodu



Codici Magneti Marelli
 Magneti Marelli references
 Magneti Marelli Nr.
 Références Magneti Marelli
 Códigos Magneti Marelli
 Códigos Magneti Marelli
 Κωδικοί Magneti Marelli
 Kody Magneti Marelli
 Коды Магнети Марелли
 Magneti Marelli kodları



Tipo di carburante
 Type of fuel
 Kraftstoffart
 Type de carburant
 Tipo de gasolina
 Tipo de combustível
 Τύπος Καυσίμου
 Тип paliwa
 Вид топлива
 Yakıt tipi

KW

Potenza kW
Output kW
Leistung kW
Puissance kW
Potencia kW
Potência kW
Απόδοση kW
Мос kW
Мощность кВт
Güç kW

TYPE

Tipo
Type
Art
Type
Tipo
Tipo
Τύπος
Typ
Тип
Típi

ENGINE: ... →

Dal numero di motore
From engine n°
Ab Motor-Nr.
Depuis le moteur numéro
Desde número de motor
A partir do n° de motor
Από αριθμό κινητήρα
Od numeru silnika
От номера двигателя
Motor başlangıç numarası

CHASSIS: ... →







Da n° telaio
From chassis n°
Ab Chassis-Nr. ...
Depuis châssis numéro...
Desde n° de chasis
A partir do chassi n°
Από πλαίσιο...
Od numeru podwozia...
От номера шасси...
Şasi başlangıç numarası



ENGINE: → ...

Fino al numero di motore
To engine n°
Bis Motor-Nr.
Jusqu'au moteur numéro
Hasta número de motor
Até o motor n°
Μέχρι αριθμό κινητήρα
Do numeru silnika
До номера двигателя
Motor bitiş numarası

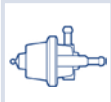
CHASSIS: → ...

Fino a n° telaio
To chassis n°
Bis Chassis-Nr. ...
Jusqu'au châssis numéro:
Hasta n° de chasis
Até o chassi n° ...
Μέχρι πλαίσιο...
Do numeru podwozia...
До номера шасси
Şasi bitiş numarası

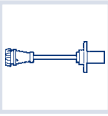
GROUP	MAGNETI MARELLI READING PART NUMBER	DESCRIPTION	TYPE
A 		Centralina elettronica iniezione • Injection electronic control unit • Motorsteuergerat • Calculateur d'injection • Centralita de inyección electrónica • Central eletrônica de injeção • Ηλεκτρονική Μονάδα Ελέγχου ψεκασμού • Sterownik wtrysku • Электронный блок управления впрыском • Enjeksiyon elektronik kontrol ünitesi	
	CFCxxx	CENTRALINA CONTROLLO CAMBIO TRANSMISSION CONTROL UNIT	A3
	IAWxxx - MJDxxx	CENTRALINA CONTROLLO MOTORE ENGINE CONTROL UNIT	A1
	IAWxxxR	CENTRALINA CONTROLLO MOTORE RIGENERATA ENGINE CONTROL UNIT REMANUFACTURED	A2
B 		Corpo farfallato • Throttle body • Drosselklappenkörper • Corps papillon • Cuerpo mariposa Corpo de borboleta • Σώμα πεταλούδας • Korpus przepustnicy • Корпус дроссельной заслонки • Gaz kelebeği	
	Bxxx	ATTUATORE CONTROLLO MINIMO IDLE SPEED CONTROL ACTUATOR KIT	B1
	(VAExxx = valvola regolazione - <i>idle control valve</i> , KITECxxx = valvola Caninster - <i>Canister valve</i> , KBLCF01 = cablaggio per corpo farfallato 54DTS3 - <i>cable for throttle body</i> , KITBLOW = tubo Caninster - <i>tube connecting Canister</i> , CAD141 = collettore motore - <i>engine collector body</i>)	VARIE ELETTRONICA VARIOUS	B2
	1xxx - 3xxx - 4xxx - 5xxx - 6xxx - Sxxx - TBxxx	CORPO FARFALLATO THROTTLE BODY	B3
	AMMxxx	SENSORE MASSA ARIA AIR MASS SENSOR	B4
	PASxxx	SENSORE PEDALE ACCELERATORE ACCELERATOR PEDAL SENSOR	B5
	CAxxx - CPxxx - IPFxxx - PFxxx - SVFxxx	SENSORE POSIZIONE FARFALLA THROTTLE POSITION SENSOR	B6
C 		Iniettores • Fuel Injector • Einspritzventil • Injecteur • Inyector • Injetor de combustível • Μπεκ ψεκασμού • Wtryskiwacz • Форсунка • Yakit enjektörü	
	FEIxxx - IPMxxx - IWPxxx	INIETTORE FUEL INJECTOR	
D 		Sensore pressione assoluta • Manifold absolute pressure sensor • Absolutdrucksensor • Capteur de pression absolue • Sensor de presión absoluta • Sensor pressão absoluta • Αισθητήρας Απόλυτης Πίεσης • Czujnik ciśnienia w kolektorze dolotowym • Датчик давления во впускном коллекторе • Mutlak basınç sensörü	
	APSxxx - PRTxxx - (KITLDF6T - KITPRT05/2 = sensore pressione assoluta - <i>manifold absolute pressure sensor</i> , SPSxxx = sensore pressione scarico - <i>exhaust pressure sensor</i>)	SENSORE PRESSIONE ASSOLUTA (ARIA) MAP SENSOR	
E 		Regolatore pressione carburante • Fuel pressure regulator • Kraftstoffdruckregler • Régulateur de pression carburant • Regulador de presión de combustible • Regulador de pressão de combustível • Ρυθμιστής Πίεσης Καυσίμου • Regulator ciśnienia paliwa • Регулятор давления топлива • Yakit basınç regülatörü	
	RPxxx - (DPR04 = regolatore pressione - <i>pressure regulator</i>)	REGOLATORE PRESSIONE CARBURANTE FUEL PRESSURE REGULATOR	
F 		Sensore temperatura • Temperature sensor • Temperatursensor • Capteur de temperature • Sensor temperatura • Sensor da temperatura • Αισθητήρας Θερμοκρασίας • Czujnik temperatury • Датчик температуры • Sicaklık sensörü	
	SZAxxx - SPAxx - (816001633701 - WTS05-1 = sensore temperatura acqua - <i>water temperature sensor</i>)	SENSORE TEMPERATURA ACQUA/REFRIGERANTE WATER TEMPERATURE SENSOR/COOLANT	F1
	ATSxxx - IATSxx - (SSA042 = termocontatto ventola radiatore - <i>fan temperature switch</i>)	SENSORE TEMPERATURA ARIA AIR TEMPERATURE SENSOR	F2
SGAxxx	SENSORE TEMPERATURA OLIO OIL TEMPERATURE SENSOR	F3	

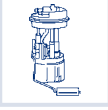
GROUP	MAGNETI MARELLI READING PART NUMBER	DESCRIPTION	TYPE	
G		Sensore pressione olio • oil pressure switch • Öldruckschalter • Capteur de pression d'huile • Sensor de presión de aceite • sensor de pressão de óleo • Αισθητήρας Πίεσης Λαδιού • Czujnik ciśnienia oleju • Датчик давления масла • Yağ basıncı anahtarı		
		SAAXxx	SENSORE PRESSIONE OLIO OIL PRESSURE SWITCH	
H		Sensore giri • TDC Sensor • Drehzahlsensor • Capteur de régime • Sensor de RPM • Sensor de rotação • Αισθητήρας Στροφών • Czujnik prędkości obrotowej • Датчик положения коленвала • TDC sensörü		
		CVxxx - CWxxx - SAGxxx - SENxxx - (SAC010 = *sensore giri - TDC sensor)	SENSORE GIRI / FASE - ALBERO MOTORE CRANKSHAFT POSITION SENSOR	H1
		SACxxx	SENSORE POSIZIONE ALBERO A CAM CAMSHAFT POSITION SENSOR	H2
		SADxxx	SENSORE DETONAZIONE KNOCK SENSOR	H3
		SAFxxx	SENSORE ACQUA CARBURANTE WATER SENSOR - FUEL SYSTEM	H4
I		Bobina accensione • Ignition coil • Zündspule • Bobine d'allumage • Bobina de encendido • Bobina de ignição • Πολλαπλασιαστής Ανάφλεξης • Cewka zapłonowa • Катушка зажигания • Ateşleme bobini		
		BAExxx - (BK2A - BZ600A = bobina - ignition coil)	BOBINA D'ACCENSIONE IGNITION COIL	
J		Pompa carburante • Fuel pump • Kraftstoffpumpe • Pompe à carburant • Bomba de combustible • Bomba de combustível • Αντλία Καυσίμου • Pompa paliwa • Топливный насос • Yakıt pompası		
		ESSxxx - Pxxx - (SUA484 - SUA486 - SUA487 - SUA507 = *pompa carburante - fuel pump)	POMPA CARBURANTE FUEL PUMP	J1
		Gaxxx - (SUA130 / 133 / 142 / 149 / 373 / 376 / 377 / 378 / 380 / 381 / 390 / 393 / 398 / 417 / 421 / 422 / 431 / 444 / 446 / 454 / 455 / 460 / 461 / 462 / 463 / 464 / 467 / 468-1 / 470 / 471 / 472 / 476 / 478 / 493 / 494 / 495 / 521 / 523 / 524 / 525 / 526 / 527 / 528 / 529 / 530 / 531 / 532 / 533 / 534 / 535 / 536 / 537 / 538 / 539 / 540 / 541 / 542 / 543 / 544 / 545 / 547 / 548 / 549 / 550 / 551 / 554 / 557 / 558 / 559 = *gruppo aspirazione carburante - fuel supply unit)	GRUPPO ASPIRAZIONE CARBURANTE FUEL SUPPLY UNIT	J2
		SUAxxx	COMANDO INDICATORE LIVELLO CARBURANTE FUEL LEVEL SENDER	J3
CILC Comando indicatore livello carburante • Fuel level sensor • Tankgeber • Transmetteur niveau carburant • Aforador de combustible • Comando indicador de nivel de combustível				
GA (R) Gruppo aspirazione (cilc+pompa+regolatore) • Fuel supply unit (cilc+fuel pump+regulator) • Ansauggruppe (cilc+benzinpumpe+regler) • Groupe complet pompe a carburant (cilc+pompe+regulateur) • Grupo de aspiración de combustible (afador+bomba+regulador) • Grupo de aspiração (cilc+bomba+regulador)				
PB Pompa benzina • Fuel pump • Benzinpumpe • Pompe a carburant • Bomba de gasolina • Bomba de combustível				
GA Comando indicatore livello carburante + pompa • Fuel level sensor + fuel pump • Tankgeber und pompe • Transmetteur niveau carburant + pompe • Aforador de combustible con bomba • Comando indicador de nivel de combustible + bomba				
GA (F/R) Gruppo aspirazione (cilc+pompa+filtro + regolatore) • Fuel supply unit (cilc+fuel pump+filter+regulator) • Ansauggruppe (cilc+benzinpumpe+filter+regler) • Groupe complet pompe a carburant (cilc+pompe+filtre+regulateur) • Grupo de aspiración de combustible (afador+bomba+filtro+regulador) • Grupo de aspiração (cilc+bomba+filtro+regulador)				
PB/KIT Pompa benzina + kit • Fuel pump + kit • Benzinpumpe + kit • Pompe a carburant + kit • Bomba de gasolina + kit • Bomba de combustível + kit				
GA (F) Gruppo aspirazione (cilc+pompa+filtro) • Fuel supply unit (cilc+fuel pump+filter) • Ansauggruppe (cilc+benzinpumpe+filter) • Groupe complet pompe a carburant (cilc+pompe+filtre) • Grupo de aspiración de combustible (afador+bomba+filtro) • Grupo de aspiração (cilc+bomba+filtro)				

Magneti Marelli After Market Parts and Services S.p.A. ha curato con particolare attenzione la stesura del presente catalogo; declina comunque ogni responsabilità per eventuali errori od omissioni relativi a schemi, disegni, immagini, corrispondenze con i codici O.E. ecc. e si riserva il diritto di apportare modifiche al contenuto senza l'obbligo di darne preventiva comunicazione. Sono particolarmente graditi, da parte degli utenti, commenti, segnalazioni di inesattezze e qualsiasi altro suggerimento atto a rendere più efficace la prossima edizione del catalogo.

Magneti Marelli After Market Parts and Services S.p.A. has devoted its best attention to the editing of this catalogue; it nevertheless declines any responsibility for possible mistakes or omissions regarding figures, drawings, pictures, correspondence with O.E. codes etc. and it reserves the right to modify the contents without prior notice. Users' comments, reports of inaccuracies or any other suggestions which may in any way improve the next edition of this catalogue are warmly welcomed.

Magneti Marelli After Market Parts and Services S.p.A. hat diesen Katalog sorgfältig verfasst. Die Firma enthebt sich jeglicher Verantwortung für eventuelle Fehler oder Auslassungen hinsichtlich Schemen, Darstellungen, Bilder, Zeichnungen, Übereinstimmungen, mit O.E. Codes usw. und behält sich das Recht vor, ohne Ankündigung, am Inhalt Veränderungen vorzunehmen. Anmerkungen, Fehlerhinweise und weitere Anregungen seitens der Kunden werden gerne entgegengenommen, um die nächste Ausgabe des Katalogs effizienter zu gestalten.

Magneti Marelli After Market Parts and Services S.p.A. a soigné avec une attention particulière la rédaction de ce catalogue; elle décline cependant toute responsabilité pour toute erreur ou omission éventuelle dans les schémas, les dessins, les images, les correspondances avec les codes O.E., etc. et se réserve le droit d'en modifier le contenu sans obligation de communication préalable. Les commentaires, les signalisations d'inexactitudes et toute autre suggestion des utilisateurs susceptibles de rendre la prochaine rédaction du catalogue plus efficace seront particulièrement appréciés.

Magneti Marelli After Market Parts and Services S.p.A. ha cuidado con especial atención la redacción del presente catálogo; de todas maneras declina toda responsabilidad por eventuales errores u omisiones relativos a esquemas, diseños, fotos, correspondencia con los códigos O.E., etc., y se reserva el derecho de aportar modificaciones al contenido sin la obligación de previo aviso. Se agradecen especialmente los comentarios, las indicaciones al contenido sin la obligación de previo aviso. Se agradecen especialmente los comentarios, las indicaciones de inexactitudes y cualquier otra sugerencia por parte de los usuarios que sean útiles para hacer más eficaz la próxima edición del catálogo.

A Magneti Marelli After Market Parts and Services S.p.A. cuidou com particular atenção a redação do presente catálogo; como quer que seja, rejeita qualquer responsabilidade face a eventuais erros o omissões relacionados aos esquemas, desenhos, imagens, correspondências aos códigos O.E. etc. e reserva-se o direito de introduzir alterações ao seu conteúdo sem a obrigação de comunicação prévia das mesmas. São particularmente bem aceitos, comentários, sinalizações de inexatidões e qualquer outra sugestão idónea a tornar mais eficaz a próxima edição do catálogo.

Η Magneti Marelli φροντίσε με κάθε λεπτομερεια την ορθότητα των στοιχειων αυτου του καταλογου, δεν φερει ομως καμια ευθυνη για τυχον λαθη ή παραληψεις που σχετιζονται με σχηματα, σχεδια, εικόνες, αντι-στοιχίες με γνησια νουμερα κτλ. και επιφυλασσειται του δικαιωματος να αλλαξει το περιεχομενο του καταλογου οποιαδηποτε στιγμή χωρις προτερη ενημερωση. Οποιαδηποτε σχολια η παρατηρησεις, με στοχο την βελτιωση του καταλογου, ειναι ευπροσδεκτα.

Firma Magneti Marelli After Market Parts and Services S.p.A dołożyła szczególnych starań przy opracowywaniu niniejszego katalogu. Nie ponosi ona jednak żadnej odpowiedzialności za ewentualne błędy lub braki dotyczące schematów, rysunków, zgodności z kodami O.E., itp. u. Firma Magneti Marelli After Market Parts and Services S.p.A zastrzega sobie prawo do wprowadzania zmian bez obowiązku uprzedniego powiadomienia o tym. Szczególnie mile widziane są komentarze i sygnały dotyczące nieprawidłowości oraz jakiegokolwiek inne sugestie zgłaszane przez klientów, mające na celu udoskonalenie następnych edycji katalogu.

Magneti Marelli After Market Parts and Services S.p.A. уделила особое внимание созданию этого каталога. Но, несмотря на это, мы не несем ответственности за возможные ошибки или неточности в цифрах, изображениях или кросс-номерах. Также мы оставляем за собой право вносить любые изменения в содержание каталога без предварительного уведомления. Мы приветствуем любые ваши замечания и комментарии, которые обязательно учтем при подготовке следующих выпусков каталога.

Magneti Marelli After Market S.p.A. Parts and Services, mevcut katalogdaki yazıyı çok özenli bir şekilde hazırlamıştır; O.E. vs. şifrelerine karşılık gelen her türlü model ve tasarım ile ilgili olası eksiklikler ve hatalar ile ilgili sorumluluğunun altını çizer ve öncesinde haber verme zorunluluğu olmaksızın değişiklik yapma hakkını saklı tutar. Kullanıcı tarafından yorumların, eksikliklerin ve her türlü önerilerin belirtilmesi, bir sonraki katalog baskısını daha etkili hale getirecektir.

È vietata la riproduzione, anche parziale, del contenuto del presente catalogo senza preventiva autorizzazione scritta della Magneti Marelli After Market Parts and Services S.p.A., che tutelerà i propri diritti a termine di legge.

It is forbidden to reproduce, even partially, the contents of this catalogue without prior written consent from Magneti Marelli After Market Parts and Services S.p.A., who will protect its rights in accordance with the law.

Die Vervielfältigung, auch teilweise, des urheberrechtlich geschützten Inhalts des vorliegenden Katalogs ist ohne schriftliche Genehmigung durch Magneti Marelli After Market Parts and Services S.p.A. untersagt.

Il est interdit de reproduire même partiellement le contenu de ce catalogue sans autorisation écrite préalable de Magneti Marelli After Market Parts and Services S.p.A., qui protégera ses droits selon les termes de la loi.

Está prohibida la reproducción, total o parcial, del contenido del presente catálogo sin previa autorización escrita de Magneti Marelli After Market Parts and Services S.p.A., que protegerá sus propios derechos con arreglo a la ley.

É proibida a reprodução, também parcial, do conteúdo do presente catálogo sem a prévia autorização escrita de Magneti Marelli After Market Parts and Services S.p.A., que defenderá os próprios direitos, nos termos de lei.

Απαγορεύεται η αναπαραγωγή, ολική ή μερική, του περιεχομένου του παρόντος καταλόγου χωρίς την γραπτή εξουσιοδότηση της Magneti Marelli After Market Parts and Services S.p.A.

Zabroniona jest nawet częściowa reprodukcja zawartości katalogu bez uprzedniej pisemnej autoryzacji ze strony firmy Magneti Marelli After Market Parts and Services S.p.A., która chroni swą własność zgodnie z przepisami prawa.

Запрещается полная или частичная перепечатка содержания каталога без предварительного письменного разрешения Magneti Marelli After Market Parts and Services S.p.A. Компания будет отстаивать свои интересы в соответствии с законом.

Tüm yasal hakların sahibi olan Magneti Marelli After Market Parts and Services S.p.A. 'in yazılı izni olmaksızın mevcut katalogun kısmen de olsa çoğaltılması yasaktır.

La corrispondenza dovrà essere inviata a:
Correspondence should be sent to:
Der Briefverkehr ist zu senden an:
Envoyer la correspondance à:
La correspondencia debe ser enviada a:
La correspondência deverá ser enviada a:
Η αλληλογραφία θα πρέπει να αποστέλεται:
Korespondencję należy przesyłać na adres:
Соответствующую корреспонденцию просим присылать по адресу:
Ticari yazışmalar şu adrese gönderilmelidir:

**MAGNETI MARELLI AFTER MARKET
PARTS AND SERVICES S.p.A.**
Viale Aldo Borletti, 61/63
20011 Corbetta (Milano) Italia
Tel. +39 02 92815111
Fax +39 02 97227234

Applicazione per marca e veicolo
Vehicle application guide
Zuordnung nach Marke und Fahrzeug
Affectations par marques et véhicules
Aplicación por marca y vehículo
Aplicação por marca e veículo
Εφαρμογή ανά μοντέλο
Zastosowanie dla marki i pojazdu
Применение по марке и модели
Marka ve araca göre uygulama

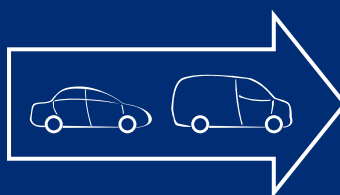



KW



TYPE



TYPE

ALFA ROMEO

145 (930)

1.4 i.e.	Petrol	66	07/94 → 12/96				B02	B1
1.4 i.e.	Petrol	66	07/94 → 12/96				KITPF1C	B6
1.6 16V T.S.	Petrol	82	02/99 → 12/00					
1.6 i.e.	Petrol	76	10/94 → 12/94				SVF015	B6
1.6 i.e.	Petrol	76	10/94 → 12/96					
1.6 i.e.	Petrol	76	10/94 → 12/96	ENGINE: → D16Y3-E199999				
1.6 i.e.	Petrol	76	01/95 → 12/96					
1.7 i.e. 16V	Petrol	95	10/94 → 12/96				SVF015	B6
1.8 i.e. 16V	Petrol	106	03/98 → 01/01					
1.8 i.e. 16V	Petrol	106	03/98 → 01/01					
1.8 i.e. 16V	Petrol	106	05/98 → 01/01					
1.8 i.e. 16V	Petrol	106	05/98 → 12/00					
1.9 JTD	Diesel	77	02/99 → 01/01					
1.9 JTD	Diesel	77	02/99 → 12/00					
1.9 TD	Diesel	66	05/98 → 02/99					
1.9 TD	Diesel	66	10/94 → 02/99					
2.0 16V Quadrifoglio	Petrol	114	03/98 → 01/01					
2.0 16V Quadrifoglio	Petrol	114	03/98 → 01/01					
2.0 16V Quadrifoglio	Petrol	114	05/98 → 01/01					
2.0 16V Quadrifoglio	Petrol	114	05/98 → 12/00					
2.0 16V T.S.	Petrol	110	10/95 → 01/01				B3393	B1
2.0 16V T.S.	Petrol	110	10/95 → 04/98				SVF015	B6
2.0 16V T.S.	Petrol	110	11/96 → 04/98					

146 (930)

1.4 i.e.	Petrol	66	12/94 → 12/96				B02	B1
1.4 i.e.	Petrol	66	12/94 → 12/96				KITPF1C	B6
1.6 16V T.S.	Petrol	82	02/99 → 12/00					
1.6 i.e.	Petrol	76	12/94 → 12/96					
1.6 i.e.	Petrol	76	12/94 → 12/96	ENGINE: → D16Y3-E199999				
1.6 i.e.	Petrol	76	05/95 → 12/96					
1.7 i.e. 16V	Petrol	95	12/94 → 12/96				SVF015	B6
1.8 i.e. 16V T.S.	Petrol	106	03/98 → 01/01					
1.8 i.e. 16V T.S.	Petrol	106	03/98 → 01/01					
1.8 i.e. 16V T.S.	Petrol	106	05/98 → 01/01					
1.8 i.e. 16V T.S.	Petrol	106	05/98 → 12/00					
1.9 JTD	Diesel	77	02/99 → 01/01					
1.9 JTD	Diesel	77	02/99 → 12/00					
1.9 TD	Diesel	66	05/98 → 02/99					
1.9 TD	Diesel	66	12/94 → 02/99					
2.0 16V Quadrifoglio	Petrol	114	03/98 → 01/01					
2.0 16V Quadrifoglio	Petrol	114	03/98 → 01/01					
2.0 16V Quadrifoglio	Petrol	114	05/98 → 01/01					
2.0 16V Quadrifoglio	Petrol	114	05/98 → 12/00					
2.0 16V T.S.	Petrol	110	10/95 → 01/01				B3393	B1



TYPE

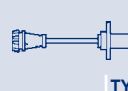

TYPE



TYPE

			SZA107	F1		SEN8I3	H1	BAE800B		
								BAE680DD		
	APS45								ESS0039A	J1
			SPA104	F1						
			SPA115	F1						
			SPA104	F1						
						SAC059	H2			
						SAD016	H3			
						SAG122	H1			
								BAE680DD		
	APS31		SPA103	F1		SEN8U	H1		ESS0066A	J1
						SAC088	H2			
	APS31		SPA103	F1		SAC088	H2			
						SEN8U	H1			
						SAC059	H2			
						SAD016	H3			
						SAG122	H1			
								BAE680DD		
			SPA164	F1		SAD009	H3			
						SAC049	H2			
								BAE680DC		
			SZA107	F1		SEN8I3	H1	BAE800B		
								BAE680DD		
	APS45								ESS0039A	J1
			SPA104	F1						
			SPA115	F1						
			SPA104	F1						
						SAC059	H2			
						SAD016	H3			
						SAG122	H1			
								BAE680DD		
	APS31		SPA103	F1		SEN8U	H1		ESS0066A	J1
						SAC088	H2			
	APS31		SPA103	F1		SAC088	H2			
						SEN8U	H1			
						SAC059	H2			
						SAD016	H3			
						SAG122	H1			
								BAE680DD		
			SPA164	F1		SAD009	H3			



KW

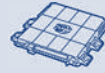

TYPE



TYPE

ALFA ROMEO

146 (930)

2.0 16V T.S.	Petrol	110	10/95 → 04/98					SVF015	B6
--------------	--------	-----	---------------	--	--	--	--	--------	----

147 (937)

1.6 16V T.SPARK (937AXB1A)	Petrol	88	01/01 → 03/10						
1.6 16V T.SPARK (937AXB1A)	Petrol	88	01/01 → 03/10						
1.6 16V T.SPARK (937AXB1A)	Petrol	88	01/01 → 03/10	ENGINE: 3636740 →					
1.6 16V T.SPARK (937AXB1A)	Petrol	88	01/01 → 03/02						
1.6 16V T.SPARK (937AXB1A)	Petrol	88	03/02 → 03/10						
1.6 16V T.SPARK ECO (937AXA1A)	Petrol	77	01/01 → 03/10						
1.6 16V T.SPARK ECO (937AXA1A)	Petrol	77	01/01 → 03/10						
1.6 16V T.SPARK ECO (937AXA1A)	Petrol	77	01/01 → 03/10	ENGINE: 3613608 →					
1.6 16V T.SPARK ECO (937AXA1A)	Petrol	77	01/01 → 03/02						
1.6 16V T.SPARK ECO (937AXA1A)	Petrol	77	03/02 → 03/10						
1.9 JTD	Diesel	74	06/03 → 03/10					TB0018	B3
1.9 JTD	Diesel	74	06/03 → 10/06						
1.9 JTD (937AXD1A)	Diesel	85	04/01 → 03/10					48CPD8	B3
1.9 JTD (937AXD1A)	Diesel	85	04/01 → 03/10	ENGINE: 2705194 →					
1.9 JTD (937AXD1A)	Diesel	85	04/01 → 07/01						
1.9 JTD (937AXD1A)	Diesel	85	04/01 → 03/05						
1.9 JTD 16V	Diesel	100	10/04 → 03/10					TB0017	B3
1.9 JTD 16V	Diesel	103	11/02 → 03/10					TB0017	B3
1.9 JTD 16V	Diesel	93	09/03 → 09/04					TB0017	B3
1.9 JTD 16V	Diesel	100	10/04 → 03/10						
1.9 JTD 16V	Diesel	103	11/02 → 03/10						
1.9 JTD 16V	Diesel	93	09/03 → 09/04						
1.9 JTD 16V	Diesel	103	11/02 → 09/03						
1.9 JTDM	Diesel	85	10/04 → 03/10					TB0017	B3
1.9 JTDM	Diesel	85	12/05 → 03/10						
1.9 JTDM 16V	Diesel	110	09/04 → 03/10					TB0017	B3
1.9 JTDM 16V	Diesel	110	09/04 → 03/10						
1.9 JTDM 16V	Diesel	110	09/04 → 03/10	ENGINE: 937A5000					
1.9 JTDM 8V	Diesel	88	07/05 → 03/10					TB0017	B3
2.0 16V T.SPARK (937AXC1_)	Petrol	110	01/01 → 03/10						
2.0 16V T.SPARK (937AXC1_)	Petrol	110	01/01 → 03/10						
2.0 16V T.SPARK (937AXC1_)	Petrol	110	01/01 → 03/10	ENGINE: 3649575 →					
2.0 16V T.SPARK (937AXC1_)	Petrol	110	01/01 → 03/02						
2.0 16V T.SPARK (937AXC1_)	Petrol	110	03/02 → 03/10						
3.2 GTA	Petrol	184	02/03 → 03/10						
3.2 GTA	Petrol	184	02/03 → 03/10						



TYPE

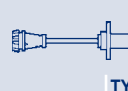

TYPE



TYPE

						SAC049	H2	BAE680DC		
						SAC059	H2	BAE680DE		
						SAD016	H3			
						SAG102	H1			
									SUA539	J2
									SUA545	J2
						SAC059	H2	BAE680DE		
						SAD016	H3			
						SAG102	H1			
									SUA539	J2
									SUA545	J2
	APS23					SAC088	H2			
									SUA539	J2
						SAC088	H2		GA2119	J2
	APS23									
	APS31									
									SUA539	J2
	APS36	ATS20	F2			SAC068	H2		SUA532	J2
		ATS20	F2			SAC068	H2			
		ATS20	F2			SAC068	H2		SUA532	J2
						SAG133	H1			
						SAG133	H1			
						SAG133	H1			
									SUA532	J2
	APS36	ATS20	F2							
									SUA539	J2
	APS36	ATS20	F2			SAC068	H2			
						SAG133	H1			
									SUA532	J2
	APS36	ATS20	F2			SAC088	H2		SUA539	J2
						SAC059	H2	BAE680DE		
						SAD016	H3			
						SAG102	H1			
									SUA539	J2
									SUA545	J2
						SAC029	H2	BAE680AP	SUA545	J2
						SAG039	H1			



KW

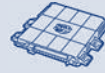

TYPE



TYPE

ALFA ROMEO

155 (167)

1.7 T.S.	Petrol	83	04/93 → 04/96				SVF015	B6
1.7 T.S. (167.A4D, 167.A4H)	Petrol	85	04/93 → 04/96				SVF015	B6
1.8 T.S.	Petrol	95	02/92 → 06/93				SVF015	B6
1.8 T.S. Sport (167.A4A, 167.A4C, 167.A4E)	Petrol	93	01/92 → 04/96				SVF015	B6
1.8 T.S. Sport (167.A4A, 167.A4C, 167.A4E)	Petrol	93	01/92 → 12/96					
1.8 T.S. Sport (167.A4A, 167.A4C, 167.A4E)	Petrol	93	02/92 → 04/96					
1.8 T.S. Sport (167.A4A, 167.A4C, 167.A4E)	Petrol	93	01/92 → 04/96					
1.9 TD (167.A3)	Diesel	66	04/93 → 12/97					
2.0 16V Turbo Q4	Petrol	140	01/92 → 12/97					
2.0 16V Turbo Q4	Petrol	140	01/92 → 12/97					
2.0 16V Turbo Q4	Petrol	140	01/92 → 12/97					
2.0 16V Turbo Q4	Petrol	140	01/93 → 12/97					
2.0 16V Turbo Q4 (167.A2B, 167.A2C, 167.A2E)	Petrol	137	01/92 → 12/97					
2.0 16V Turbo Q4 (167.A2B, 167.A2C, 167.A2E)	Petrol	137	01/92 → 12/97					
2.0 16V Turbo Q4 (167.A2B, 167.A2C, 167.A2E)	Petrol	137	01/92 → 12/97					
2.0 16V Turbo Q4 (167.A2B, 167.A2C, 167.A2E)	Petrol	137	01/93 → 12/97					
2.0 T.S. (167.A2)	Petrol	106	02/92 → 04/93				SVF015	B6
2.0 T.S. (167.A2A)	Petrol	104	04/93 → 02/95				SVF015	B6
2.0 T.S. (167.A2A)	Petrol	104	01/93 → 02/95					
2.0 T.S. (167.A2A)	Petrol	104	03/93 → 02/95					
2.0 T.S. 16V (167.A2G)	Petrol	110	03/95 → 12/97				B3393	B1
2.0 T.S. 16V (167.A2G)	Petrol	110	03/95 → 10/97				SVF015	B6
2.0 T.S. 16V (167.A2G)	Petrol	110	03/95 → 12/96					
2.0 T.S. 16V (167.A2G)	Petrol	110	05/96 → 12/97					
2.0 T.S. 16V (167.A2G)	Petrol	110	03/95 → 10/97					
2.5 TD (167.A1A)	Diesel	92	04/93 → 12/97					
2.5 TD (167.A1A)	Diesel	92	04/93 → 04/96					
2.5 V6 (167.A1)	Petrol	121	02/92 → 04/96				SVF015	B6
2.5 V6 (167.A1)	Petrol	121	02/92 → 09/96					
2.5 V6 (167.A1)	Petrol	121	02/92 → 04/96					
2.5 V6 (167.A1C, 167.A1E)	Petrol	120	05/96 → 12/97				SVF015	B6
2.5 V6 (167.A1C, 167.A1E)	Petrol	120	10/92 → 10/97					
2.5 V6 (167.A1C, 167.A1E)	Petrol	120	10/92 → 12/97					
2.5 V6 (167.A1C, 167.A1E)	Petrol	120	04/96 → 10/97					

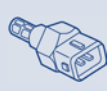
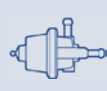

TYPE

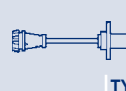

TYPE



TYPE

						SAG040	H1	BAE680AG	ESS531	J1
			SPA104	F1		SAG040	H1	BAE680AG	ESS531	J1
			SPA104	F1		SAG040	H1	BAE680AG	ESS531	J1
						SAG040	H1			
			SPA104	F1						
								BAE680AG		
									ESS531	J1
						SEN8U	H1			
		RP7/01	ATS04-1	F2				BAE800B		
			SZA103	F1						
			WTS05-1	F1						
						SEN8I	H1			
		RP7/01	ATS04-1	F2				BAE800B		
			SZA103	F1						
			WTS05-1	F1						
						SEN8I	H1			
			SPA104	F1		SAG040	H1	BAE680AG	ESS531	J1
						SAG040	H1	BAE680AG		
			SPA104	F1						
									ESS531	J1
						SAD009	H3		ESS0174A	J1
						SAC049	H2	BAE680DC		
			SPA104	F1						
			SPA164	F1						
									ESS531	J1
			SPA164	F1						
						SAG047	H1			
						SAG040	H1	BAE680W		
									ESS0174A	J1
									ESS531	J1
						SAG040	H1			
								BAE680W		
									ESS0174A	J1
									ESS531	J1



KW

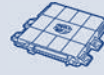

TYPE



TYPE

ALFA ROMEO

156 (932)

1.6 16V T.SPARK	Petrol	82	04/98 → 09/00					
1.6 16V T.SPARK (932A4)	Petrol	88	09/97 → 09/05				B3393	B1
1.6 16V T.SPARK (932A4)	Petrol	88	09/97 → 12/01					
1.6 16V T.SPARK (932A4)	Petrol	88	01/02 → 09/05					
1.6 16V T.SPARK (932A4)	Petrol	88	01/02 → 09/05	ENGINE: 3636740 →				
1.6 16V T.SPARK (932A4)	Petrol	88	09/00 → 09/05					
1.6 16V T.SPARK (932A4)	Petrol	88	10/97 → 05/99					
1.6 16V T.SPARK (932A4)	Petrol	88	09/97 → 09/00	ENGINE: AR67601				
1.6 16V T.SPARK (932A4)	Petrol	88	09/97 → 09/00	ENGINE: AR67601-AR32102				
1.6 16V T.SPARK (932A4)	Petrol	88	02/03 → 09/05	ENGINE: AR32104				
1.6 16V T.SPARK (932A4)	Petrol	88	08/00 → 02/03	ENGINE: AR32104-AR67601				
1.8 16V T.SPARK (932A3)	Petrol	106	09/97 → 10/00					
1.8 16V T.SPARK (932A3)	Petrol	106	09/97 → 10/00					
1.8 16V T.SPARK (932A3)	Petrol	106	09/97 → 10/00					
1.8 16V T.SPARK (932A3)	Petrol	106	10/97 → 09/00					
1.8 16V T.SPARK (932A3)	Petrol	106	09/97 → 09/00					
1.8 16V T.SPARK (932A31__)	Petrol	103	10/00 → 12/01					
1.8 16V T.SPARK (932A31__)	Petrol	103	10/00 → 09/05					
1.8 16V T.SPARK (932A31__)	Petrol	103	10/00 → 09/05					
1.8 16V T.SPARK (932A31__)	Petrol	103	10/00 → 09/05	ENGINE: → 3649574				
1.8 16V T.SPARK (932A31__)	Petrol	103	01/02 → 09/05	ENGINE: 3649575 →				
1.8 16V T.SPARK (932A31__)	Petrol	103	10/00 → 02/03					
1.8 16V T.SPARK (932A31__)	Petrol	103	02/03 → 09/05	ENGINE: AR32205(M5)				
1.9 JTD	Diesel	100	11/02 → 11/04				TB0017	B3
1.9 JTD	Diesel	93	11/03 → 09/05				TB0017	B3
1.9 JTD	Diesel	110	07/04 → 09/05					
1.9 JTD (932A2B, 932A2C)	Diesel	85	05/01 → 09/05	ENGINE: 2705194 →				
1.9 JTD (932A2B, 932A2C)	Diesel	85	05/01 → 12/01					
1.9 JTD (932A2B, 932A2C)	Diesel	85	01/02 → 09/05					
1.9 JTD (932A2B, 932A2C)	Diesel	85	05/01 → 09/05					
1.9 JTD (932A2B, 932A2C)	Diesel	85	12/01 → 09/05					
1.9 JTD (932A2B__)	Diesel	81	10/00 → 05/01				TB0018	B3
1.9 JTD (932A2B__)	Diesel	81	10/00 → 05/01	ENGINE: 2705194 →				
1.9 JTD (932A2B__)	Diesel	81	10/00 → 05/01					
1.9 JTD (932B2)	Diesel	77	09/97 → 10/00					
1.9 JTD (932B2)	Diesel	77	09/97 → 10/00	ENGINE: → 1415540				
1.9 JTD 16V	Diesel	103	11/02 → 09/05				TB0017	B3
1.9 JTD 16V	Diesel	103	11/02 → 09/05					
2.0 16V T.SPARK (932A2)	Petrol	114	09/97 → 10/00					
2.0 16V T.SPARK (932A2)	Petrol	114	09/97 → 10/00					
2.0 16V T.SPARK (932A2)	Petrol	114	09/97 → 10/00					
2.0 16V T.SPARK (932A2)	Petrol	114	10/97 → 09/00					
2.0 16V T.SPARK (932A2)	Petrol	114	09/97 → 09/00					
2.0 16V T.SPARK (932A21__)	Petrol	110	10/00 → 03/02					

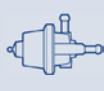

TYPE

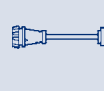

TYPE



TYPE

								BAE680DD		
						SAD009	H3			
						SAC049	H2			
						SAC059	H2			
						SAG102	H1			
								BAE680DE		
								BAE680DC		
									SUA538	J2
									SUA536	J2
									SUA547	J2
									SUA540	J2
			SPA103	F1		SAC059	H2			
						SAD016	H3			
						SAG122	H1			
								BAE680DD		
									SUA536	J2
			SPA103	F1						
						SAC059	H2	BAE680DE		
						SAD016	H3			
						SAG122	H1			
						SAG102	H1			
									SUA540	J2
									SUA547	J2
						SAG133	H1			
						SAG133	H1			
						SAG133	H1			
APS23										
			SPA103	F1						
						SAC088	H2			
									ESS0066A	J1
									SUA526	J2
			SPA103	F1		SAC088	H2		ESS0066A	J1
APS23										
									SUA526	J2
APS31			SPA101	F1		SAC088	H2		ESS0066A	J1
			SPA103	F1						
						SAC068	H2		SUA533	J2
						SAG133	H1			
						SAC059	H2			
						SAD016	H3			
						SAG122	H1			
								BAE680DD		
									SUA536	J2
						SAC059	H2	BAE680DE		



KW

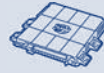

TYPE



TYPE

ALFA ROMEO

156 (932)

2.0 16V T.SPARK (932A21__)	Petrol	110	10/00 → 03/02					
2.0 16V T.SPARK (932A21__)	Petrol	110	10/00 → 03/02	ENGINE: → 3649574				
2.0 16V T.SPARK (932A21__)	Petrol	110	01/02 → 03/02	ENGINE: 3649575 →				
2.0 16V T.SPARK (932A21__)	Petrol	110	10/00 → 12/01					
2.0 JTS (932AXA)	Petrol	122	03/02 → 09/05					
2.0 JTS (932AXA)	Petrol	122	03/02 → 09/05					
2.0 Twin Spark	Petrol	118	11/97 → 04/00					
2.4 JTD	Diesel	129	10/03 → 09/05				TB0017	B3
2.4 JTD	Diesel	120	06/03 → 09/05					
2.4 JTD	Diesel	129	10/03 → 09/05					
2.4 JTD (932A1B__)	Diesel	103	10/00 → 12/01					
2.4 JTD (932A1B__)	Diesel	103	10/00 → 09/05					
2.4 JTD (932A1B__)	Diesel	103	10/00 → 12/01					
2.4 JTD (932AXC)	Diesel	110	03/02 → 09/05				TB0018	B3
2.4 JTD (932AXC)	Diesel	110	03/02 → 09/05					
2.4 JTD (932B1)	Diesel	100	09/97 → 09/03					
2.4 JTD (932B1)	Diesel	100	09/97 → 09/03	ENGINE: → 1283804				
2.4 JTD (932B1)	Diesel	100	09/97 → 10/00					
2.5 V6 24V (932A1)	Petrol	140	09/97 → 12/01					
2.5 V6 24V (932A1)	Petrol	140	10/97 → 09/00					
2.5 V6 24V (932A1)	Petrol	140	09/97 → 09/00					
2.5 V6 24V (932A11_)	Petrol	141	10/00 → 09/05					
2.5 V6 24V (932A11_)	Petrol	141	01/02 → 09/05					
2.5 V6 24V (932A11_)	Petrol	141	01/02 → 09/05					
2.5 V6 24V (932A11_)	Petrol	141	02/03 → 09/05					
2.5 V6 24V (932A11_)	Petrol	141	12/01 → 02/03					
3.2 GTA (932AXB)	Petrol	184	03/02 → 09/05					
3.2 GTA (932AXB)	Petrol	184	03/02 → 09/05					
3.2 GTA (932AXB)	Petrol	184	03/02 → 02/03					
3.2 GTA (932AXB)	Petrol	184	02/03 → 09/05					

156 Sportwagon (932)

1.6 16V T.SPARK. (932A4)	Petrol	88	05/00 → 05/06				B3393	B1
1.6 16V T.SPARK. (932A4)	Petrol	88	05/00 → 12/01					
1.6 16V T.SPARK. (932A4)	Petrol	88	01/02 → 05/06					
1.6 16V T.SPARK. (932A4)	Petrol	88	01/02 → 05/06	ENGINE: 3636740 →				
1.6 16V T.SPARK. (932A4)	Petrol	88	06/00 → 12/05					
1.6 16V T.SPARK. (932A4)	Petrol	88	05/00 → 09/00	ENGINE: AR67601				
1.6 16V T.SPARK. (932A4)	Petrol	88	02/03 → 12/05	ENGINE: AR67601-AR32102-AR32104-AR32103				
1.6 16V T.SPARK. (932A4)	Petrol	88	08/00 → 02/03	ENGINE: AR32104-AR67601				
1.8 16V T.SPARK (932A3)	Petrol	106	05/00 → 10/00					
1.8 16V T.SPARK (932A3)	Petrol	106	05/00 → 10/00					
1.8 16V T.SPARK (932A3)	Petrol	106	05/00 → 10/00					
1.8 16V T.SPARK (932A3)	Petrol	106	06/00 → 09/00					



TYPE

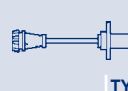

TYPE



TYPE

							SAD016	H3				
							SAG122	H1				
							SAG102	H1				
											SUA540	J2
	APS55						SAC059	H2	BAE680AT		SUA543	J2
							SAG102	H1				
									BAE680DD		SUA536	J2
							SAC068	H2			SUA533	J2
							SAG133	H1				
							SAG133	H1				
	APS31		SPA103	F1			SAC088	H2				
											ESS0066A	J1
											SUA526	J2
	APS23						SAC088	H2			ESS0066A	J1
											SUA526	J2
	APS31						SAC088	H2			ESS0066A	J1
			SPA103	F1								
			SPA101	F1								
			SPA164	F1			SAD013	H3				
										BAE680AP		
											SUA536	J2
			SPA164	F1								
							SAC029	H2	BAE680AP			
							SAG039	H1				
											SUA547	J2
											SUA540	J2
							SAC029	H2	BAE680AP			
							SAG039	H1				
											SUA540	J2
											SUA547	J2
							SAD009	H3				
							SAC049	H2				
							SAC059	H2				
							SAG102	H1				
										BAE680DE		
											SUA536	J2
											SUA547	J2
											SUA540	J2
			SPA103	F1			SAC059	H2				
							SAD016	H3				
							SAG122	H1				
										BAE680DE		



KW



TYPE



TYPE

ALFA ROMEO

156 Sportwagon (932)

1.8 16V T.SPARK (932A3)	Petrol	106	05/00 → 09/00					
1.8 16V T.SPARK (932B31__)	Petrol	103	10/00 → 12/01					
1.8 16V T.SPARK (932B31__)	Petrol	103	10/00 → 05/06					
1.8 16V T.SPARK (932B31__)	Petrol	103	10/00 → 05/06					
1.8 16V T.SPARK (932B31__)	Petrol	103	10/00 → 05/06	ENGINE: → 3649574				
1.8 16V T.SPARK (932B31__)	Petrol	103	01/02 → 05/06	ENGINE: 3649575 →				
1.8 16V T.SPARK (932B31__)	Petrol	103	10/00 → 12/05					
1.8 16V T.SPARK (932B31__)	Petrol	103	10/00 → 02/03					
1.8 16V T.SPARK (932B31__)	Petrol	103	02/03 → 12/05	ENGINE: AR32205(M5)				
1.9 JTD	Diesel	100	11/02 → 11/04			TB0017		B3
1.9 JTD	Diesel	93	11/03 → 05/06			TB0017		B3
1.9 JTD	Diesel	110	03/05 → 05/06					
1.9 JTD	Diesel	110	03/05 → 12/05					
1.9 JTD (932B2)	Diesel	77	05/00 → 10/00					
1.9 JTD (932B2)	Diesel	77	05/00 → 10/00	ENGINE: → 1415540				
1.9 JTD (932B2B, 932B2C)	Diesel	85	05/01 → 05/06	ENGINE: 2705194 →				
1.9 JTD (932B2B, 932B2C)	Diesel	85	05/01 → 12/01					
1.9 JTD (932B2B, 932B2C)	Diesel	85	01/02 → 05/06					
1.9 JTD (932B2B, 932B2C)	Diesel	85	05/01 → 05/06					
1.9 JTD (932B2B, 932B2C)	Diesel	85	12/01 → 12/05					
1.9 JTD (932B2B__)	Diesel	81	10/00 → 05/01			TB0018		B3
1.9 JTD (932B2B__)	Diesel	81	10/00 → 05/01	ENGINE: 2705194 →				
1.9 JTD (932B2B__)	Diesel	81	10/00 → 05/01					
1.9 JTD 16V	Diesel	103	11/02 → 05/06			TB0017		B3
1.9 JTD 16V	Diesel	103	11/02 → 05/06					
1.9 JTD 16V	Diesel	103	11/02 → 12/05					
1.9 JTD 16V Q4	Diesel	110	07/04 → 05/06			TB0017		B3
1.9 JTD 16V Q4	Diesel	110	07/04 → 05/06					
1.9 JTD 16V Q4	Diesel	110	09/04 → 12/05					
2.0	Petrol	119	03/02 → 12/05					
2.0	Petrol	119	03/02 → 12/05					
2.0 16V T.SPARK (932A2)	Petrol	114	05/00 → 06/02					
2.0 16V T.SPARK (932A2)	Petrol	114	05/00 → 06/02					
2.0 16V T.SPARK (932A2)	Petrol	114	05/00 → 06/02					
2.0 16V T.SPARK (932A2)	Petrol	114	06/00 → 09/00					
2.0 16V T.SPARK (932A2)	Petrol	114	05/00 → 09/00					
2.0 16V T.SPARK (932B21__)	Petrol	110	10/00 → 03/02					
2.0 16V T.SPARK (932B21__)	Petrol	110	10/00 → 03/02					
2.0 16V T.SPARK (932B21__)	Petrol	110	10/00 → 03/02	ENGINE: → 3649574				
2.0 16V T.SPARK (932B21__)	Petrol	110	01/02 → 03/02	ENGINE: 3649575 →				
2.0 16V T.SPARK (932B21__)	Petrol	110	10/00 → 12/01					
2.0 JTS (932BXA)	Petrol	122	03/02 → 05/06					
2.0 JTS (932BXA)	Petrol	122	03/02 → 05/06					
2.0 JTS (932BXA)	Petrol	122	03/02 → 12/05					

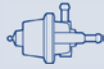

TYPE



TYPE



TYPE

								SUA536	J2
			SPA103	F1					
						SAC059	H2		
						SAD016	H3		
						SAG122	H1		
						SAG102	H1		
								BAE680DE	
								SUA540	J2
								SUA547	J2
						SAG133	H1		
						SAG133	H1		
						SAG133	H1		
								SUA533	J2
	APS31		SPA101	F1		SAC088	H2		ESS0066A
			SPA103	F1					
	APS23								
			SPA103	F1					
						SAC088	H2		
								ESS0066A	J1
								SUA526	J2
			SPA103	F1		SAC088	H2		ESS0066A
	APS23								
								SUA526	J2
						SAC068	H2		
						SAG133	H1		
								SUA533	J2
						SAC068	H2		
						SAG133	H1		
								SUA533	J2
								BAE680AT	
								SUA543	J2
						SAC059	H2		
						SAD016	H3		
						SAG122	H1		
								BAE680DE	
								SUA536	J2
						SAC059	H2	BAE680DE	
						SAD016	H3		
						SAG122	H1		
						SAG102	H1		
								SUA540	J2
	APS55					SAC059	H2		
						SAG102	H1		
								BAE680AT	



KW



TYPE



TYPE

ALFA ROMEO

156 Sportwagon (932)

2.0 JTS (932BXA)	Petrol	122	03/02 → 12/05					
2.4 JTD	Diesel	129	10/03 → 05/06				TB0017	B3
2.4 JTD	Diesel	120	06/03 → 05/06					
2.4 JTD	Diesel	129	10/03 → 05/06					
2.4 JTD	Diesel	129	10/03 → 12/05					
2.4 JTD (932B1)	Diesel	100	05/00 → 09/03					
2.4 JTD (932B1)	Diesel	100	05/00 → 09/03	ENGINE: → 1283804				
2.4 JTD (932B1)	Diesel	100	05/00 → 10/00					
2.4 JTD (932B1B_)	Diesel	103	10/00 → 12/01					
2.4 JTD (932B1B_)	Diesel	103	10/00 → 05/06					
2.4 JTD (932B1B_)	Diesel	103	10/00 → 12/01					
2.4 JTD (932BXC)	Diesel	110	03/02 → 05/06				TB0018	B3
2.4 JTD (932BXC)	Diesel	110	03/02 → 10/05					
2.5 V6 24V (932A1)	Petrol	140	05/00 → 08/03					
2.5 V6 24V (932A1)	Petrol	140	06/00 → 09/00					
2.5 V6 24V (932A1)	Petrol	140	05/00 → 09/00					
2.5 V6 24V (932B11_)	Petrol	141	10/00 → 05/06					
2.5 V6 24V (932B11_)	Petrol	141	01/02 → 05/06					
2.5 V6 24V (932B11_)	Petrol	141	01/02 → 05/06					
2.5 V6 24V (932B11_)	Petrol	141	10/00 → 10/05					
2.5 V6 24V (932B11_)	Petrol	141	10/00 → 02/03					
2.5 V6 24V (932B11_)	Petrol	141	02/03 → 10/05	ENGINE: AR32405(M15)				
3.2 GTA (932BXB)	Petrol	184	03/02 → 05/06					
3.2 GTA (932BXB)	Petrol	184	03/02 → 05/06					
3.2 GTA (932BXB)	Petrol	184	03/02 → 10/05					
3.2 GTA (932BXB)	Petrol	184	03/02 → 02/03					
3.2 GTA (932BXB)	Petrol	184	02/03 → 10/05					

159 (939)

1.8 MPI	Petrol	103	03/07 → 11/11					
1.8 MPI	Petrol	103	03/07 → 11/11					
1.9 JTDM 16V	Diesel	100	09/05 → 11/11	ENGINE: 937A8000,939A8000			CAD191	B2
1.9 JTDM 16V	Diesel	110	09/05 → 11/11	ENGINE: 939A2000			CAD191	B2
1.9 JTDM 16V	Diesel	110	09/05 → 11/11				48CPD4	B3
1.9 JTDM 16V	Diesel	100	09/05 → 11/11					
1.9 JTDM 16V	Diesel	110	09/05 → 11/11					
1.9 JTDM 16V	Diesel	100	09/05 → 11/11					
1.9 JTDM 8V	Diesel	85	09/05 → 11/11				48CPD1	B3
1.9 JTDM 8V	Diesel	88	09/05 → 11/11					
1.9 JTDM 8V	Diesel	88	09/05 → 11/11					
1.9 JTS	Petrol	118	09/05 → 11/11					
1.9 JTS	Petrol	118	09/05 → 11/11					
2.0 JTDM	Diesel	100	06/10 → 11/11					
2.0 JTDM	Diesel	125	05/09 → 11/11					
2.0 JTDM	Diesel	120	05/09 → 11/11					

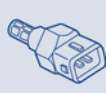
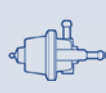

TYPE

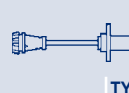

TYPE



TYPE

									SUA543	J2
									SAC068	H2
									SAG133	H1
									SAG133	H1
									SUA533	J2
	APS31								SAC088	H2
			SPA103	F1					ESS0066A	J1
			SPA101	F1						
	APS31		SPA103	F1					SAC088	H2
									ESS0066A	J1
									SUA526	J2
	APS23								SAC088	H2
									ESS0066A	J1
									SUA526	J2
			SPA164	F1					SAD013	H3
									BAE680AP	
									SUA536	J2
			SPA164	F1						
									SAC029	H2
									SAG039	H1
									BAE680AP	
									SUA540	J2
									SUA547	J2
									SAC029	H2
									SAG039	H1
									BAE680AP	
									SUA540	J2
									SUA547	J2
									SAC062	H2
									SAD033	H3
	APS36		ATS20	F2					SAC068	H2
	APS36								SAF001	H4
									SAG133	H1
									SAG133	H1
									SAC088	H2
	APS36		ATS20	F2					SAC088	H2
									SAF001	H4
									SAC092	H2
									SAD004	H3
	APS36								SAF001	H4
	APS36								SAF001	H4
									SAF001	H4



KW



TYPE



TYPE

ALFA ROMEO

159 (939)

2.2 JTS	Petrol	136	09/05 → 11/11					
2.2 JTS	Petrol	136	09/05 → 11/11					
2.4 JTDM	Diesel	147	09/05 → 11/11					
2.4 JTDM	Diesel	154	05/07 → 11/11					
2.4 JTDM	Diesel	147	09/05 → 11/11					
2.4 JTDM	Diesel	147	09/05 → 11/11					
2.4 JTDM Q4	Diesel	154	05/07 → 11/11					
3.2 JTS Q4	Petrol	191	12/05 → 11/11					

159 Sportwagon (939)

1.8 MPI	Petrol	103	03/07 → 11/11					
1.8 MPI	Petrol	103	03/07 → 11/11					
1.9 JTDM 16V	Diesel	100	03/06 → 11/11	ENGINE: 937A8000		CAD191	B2	
1.9 JTDM 16V	Diesel	110	03/06 → 11/11	ENGINE: 939A2000		CAD191	B2	
1.9 JTDM 16V	Diesel	110	03/06 → 11/11			48CPD4	B3	
1.9 JTDM 16V	Diesel	100	03/06 → 11/11					
1.9 JTDM 16V	Diesel	110	03/06 → 11/11					
1.9 JTDM 16V	Diesel	100	03/06 → 11/11					
1.9 JTDM 16V	Diesel	110	03/06 → 11/11					
1.9 JTDM 8V	Diesel	88	03/06 → 11/11					
1.9 JTDM 8V	Diesel	85	03/06 → 11/11					
1.9 JTDM 8V	Diesel	88	03/06 → 11/11					
1.9 JTS	Petrol	118	03/06 → 11/11					
1.9 JTS	Petrol	118	03/06 → 11/11					
2.0 JTDM	Diesel	100	06/10 → 11/11					
2.0 JTDM	Diesel	125	05/09 → 11/11					
2.0 JTDM	Diesel	120	05/09 → 11/11					
2.2 JTS	Petrol	136	03/06 → 11/11					
2.2 JTS	Petrol	136	03/06 → 11/11					
2.4 JTDM	Diesel	147	03/06 → 11/11					
2.4 JTDM	Diesel	154	05/07 → 11/11					
2.4 JTDM	Diesel	147	03/06 → 11/11					
2.4 JTDM	Diesel	147	03/06 → 11/11					
2.4 JTDM Q4	Diesel	154	05/07 → 11/11					
3.2 JTS Q4	Petrol	191	03/06 → 11/11					

164 (164)

2.0 T.S. (164.A2C, 164.A2L)	Petrol	105	06/87 → 09/92					
2.0 T.S. (164.H3)	Petrol	106	09/92 → 09/98			SVF015	B6	
2.0 Turbo	Petrol	128	10/87 → 12/92					
2.0 Turbo	Petrol	128	10/87 → 09/98					
2.0 V6 Turbo (164.A2G, 164.A2F)	Petrol	150	03/91 → 09/92					
2.0 V6 Turbo (164.K3)	Petrol	148	09/92 → 09/98					
2.5 TD (164.K2A, 164.K2B)	Diesel	92	09/92 → 09/98					
3.0	Petrol	145	10/94 → 08/97					

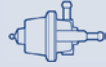

TYPE



TYPE



TYPE

							SAC092	H2		
							SAD004	H3		
		APS36		ATS20	F2		SAC068	H2		
		APS36					SAF001	H4		
							SAF001	H4		
							SAG133	H1		
		APS36					SAF001	H4		
							SAD004	H3		
							SAC062	H2		
							SAD033	H3		
		APS36					SAC068	H2		
		APS36					SAF001	H4		
							SAF001	H4		
							SAG133	H1		
							SAG133	H1		
		APS36					SAC088	H2		
							SAC088	H2		
							SAF001	H4		
							SAC092	H2		
							SAD004	H3		
		APS36					SAF001	H4		
		APS36					SAF001	H4		
							SAF001	H4		
							SAC092	H2		
							SAD004	H3		
		APS36					SAC068	H2		
		APS36					SAF001	H4		
							SAF001	H4		
							SAG133	H1		
		APS36					SAF001	H4		
							SAD004	H3		
							ESS0174A		J1	
				SPA104	F1			BAE680AG		
				SPA104	F1					
							SEN8D	H1		
				SPA129	F1		SAD009	H3		
				SPA129	F1		SAD009	H3		
				SPA164	F1		SAG047	H1		
								BAE680W		



KW



TYPE



TYPE

ALFA ROMEO

164 (164)

3.0	Petrol	145	10/94 → 08/95					
3.0	Petrol	168	04/93 → 02/95					
3.0	Petrol	170	03/95 → 08/97					
3.0 24V (164.K1)	Petrol	155	09/92 → 09/98				SVF015	B6
3.0 24V Q4 (164.K1M, 164.K1C)	Petrol	170	02/94 → 09/98				SVF015	B6
3.0 24V QV (164.H1)	Petrol	171	09/92 → 09/98				SVF015	B6
3.0 24V QV Trazione integrale	Petrol	171	12/93 → 10/97					
3.0 i.e. QV (164.AG)	Petrol	147	09/90 → 09/92				SVF009	B6
3.0 V6 (164.A)	Petrol	141	06/87 → 09/92				SVF009	B6
3.0 V6 (164.AD, 164.AH, 164.AB)	Petrol	135	04/88 → 09/92				SVF009	B6
3.0 V6 (164.AD, 164.AH, 164.AB)	Petrol	135	06/87 → 09/92					
3.0 V6 (164.H1A, 164.H1B, 164.K1P)	Petrol	132	09/92 → 09/98				SVF015	B6

166 (936)

2.0 T.Spark (936A3A__)	Petrol	114	09/98 → 10/00					
2.0 T.Spark (936A3A__)	Petrol	114	09/98 → 10/00					
2.0 T.Spark (936A3A__)	Petrol	114	09/98 → 10/00					
2.0 T.Spark (936A3A__)	Petrol	114	10/98 → 09/00					
2.0 T.Spark (936A3B__)	Petrol	110	10/00 → 06/07					
2.0 T.Spark (936A3B__)	Petrol	110	10/00 → 06/07					
2.0 T.Spark (936A3B__)	Petrol	110	10/00 → 06/07	ENGINE: 3649575 →				
2.0 V6 (936A3__)	Petrol	151	09/98 → 10/00					
2.0 V6 (936A3__)	Petrol	151	09/98 → 10/00					
2.0 V6 (936A3__)	Petrol	151	10/98 → 10/00					
2.4 JTD	Diesel	110	04/02 → 06/07				TB0017	B3
2.4 JTD	Diesel	129	10/03 → 06/07				TB0017	B3
2.4 JTD	Diesel	129	10/03 → 06/07					
2.4 JTD	Diesel	132	07/06 → 06/07					
2.4 JTD	Diesel	136	07/05 → 06/07					
2.4 JTD (936A2A__)	Diesel	100	09/98 → 10/00					
2.4 JTD (936A2A__)	Diesel	100	09/98 → 10/00					
2.4 JTD (936A2B__)	Diesel	103	10/00 → 06/07				TB0018	B3
2.4 JTD (936A2B__)	Diesel	103	10/00 → 06/07					
2.5 V6 24V (936A2__)	Petrol	140	09/98 → 10/00					
2.5 V6 24V (936A2__)	Petrol	140	09/98 → 10/00					
2.5 V6 24V (936A21__)	Petrol	138	10/00 → 06/07					
2.5 V6 24V (936A21__)	Petrol	138	10/00 → 06/07					
3.0 V6 24V (936A1__)	Petrol	166	09/98 → 10/00					
3.0 V6 24V (936A1__)	Petrol	166	09/98 → 10/00					
3.0 V6 24V (936A1__)	Petrol	166	10/98 → 09/00					
3.0 V6 24V (936A11__)	Petrol	162	10/00 → 06/07					
3.0 V6 24V (936A11__)	Petrol	162	10/00 → 06/07					



KW



TYPE



TYPE

ALFA ROMEO

166 (936)

3.2 V6 24V	Petrol	176	10/03 → 06/07				
3.2 V6 24V	Petrol	176	10/03 → 06/07				

33 (905)

1.3 i.e.	Petrol	66	01/86 → 12/89			B06	B1
1.7 i.e. (905.A3D)	Petrol	77	09/88 → 12/89				

33 (907A)

1.4 i.e. (907.A3A, 907.A3B)	Petrol	65	01/92 → 09/94				
1.4 i.e. (907.A3A, 907.A3B)	Petrol	66	01/92 → 09/94				
1.4 i.e. (907.A3A, 907.A3B)	Petrol	65	06/91 → 09/94				
1.4 i.e. (907.A3A, 907.A3B)	Petrol	66	06/91 → 09/94				
1.5 i.e.	Petrol	71	04/92 → 09/94			SVF015	B6
1.5 i.e.	Petrol	71	01/90 → 09/94				
1.5 i.e. (907A2A)	Petrol	74	07/90 → 08/91				
1.7 16V (907.A1B)	Petrol	101	01/90 → 03/92				
1.7 16V (907.A1C)	Petrol	95	01/90 → 09/94				
1.7 16V (907.A1C)	Petrol	97	01/90 → 03/92				
1.7 16V 4x4 (907.A1G)	Petrol	97	01/90 → 09/94				
1.7 16V 4x4 (907A1F)	Petrol	101	01/90 → 09/94				
1.7 i.e. (907.A1A)	Petrol	77	04/92 → 09/94			SVF015	B6
1.7 i.e. (907.A1A)	Petrol	79	01/90 → 09/94				
1.7 i.e. 4x4	Petrol	79	01/90 → 03/92				

33 Sportwagon (905A)

1.7 i.e.	Petrol	77	09/88 → 12/89				
----------	--------	----	---------------	--	--	--	--

33 Sportwagon (907B)

1.4 i.e.	Petrol	65	01/92 → 09/94				
1.4 i.e.	Petrol	66	01/92 → 09/94				
1.4 i.e.	Petrol	65	06/91 → 09/94				
1.4 i.e.	Petrol	66	06/91 → 09/94				
1.4 i.e. 4x4	Petrol	66	01/92 → 09/94				
1.4 i.e. 4x4	Petrol	66	06/91 → 09/94				
1.5 i.e.	Petrol	71	04/92 → 09/94			SVF015	B6
1.5 i.e.	Petrol	71	01/90 → 09/94				
1.7 16V	Petrol	101	01/90 → 03/92				
1.7 16V (907.B1G)	Petrol	95	01/90 → 09/94				
1.7 16V (907.B1G)	Petrol	97	01/90 → 09/94				
1.7 16V 4x4 (907.B1H)	Petrol	95	01/90 → 09/94				
1.7 16V 4x4 (907.B1H)	Petrol	97	01/90 → 03/92				
1.7 i.e. (907.B1A)	Petrol	77	04/92 → 09/94			SVF015	B6
1.7 i.e. (907.B1A)	Petrol	79	01/90 → 03/92				
1.7 i.e. 4x4 (907.B1E)	Petrol	79	01/90 → 03/92				

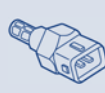

TYPE

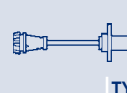

TYPE



TYPE

SAC029 H2 BAE680AP

SAG039 H1

PI024 J1

PRT03/04 SZA107 F1 SEN8E H1 BAE800B

PRT03/04 SZA107 F1 SEN8E H1 BAE800B

SPA104 F1 PI024 J1

SPA104 F1 PI024 J1

SPA104 F1 PI024 J1

SPA104 F1 PI024 J1

SPA104 F1 PI024 J1

SPA104 F1 PI024 J1

SPA104 F1 PI024 J1

SPA104 F1 PI024 J1

SPA104 F1 PI024 J1

SPA104 F1 PI024 J1

SPA104 F1 PI024 J1

SPA104 F1 PI024 J1

PI024 J1

PRT03/04 SZA107 F1 SEN8E H1 BAE800B

PRT03/04 SZA107 F1 SEN8E H1 BAE800B

SPA104 F1 PI024 J1

SPA104 F1 PI024 J1

PRT03/04 SZA107 F1 SEN8E H1 BAE800B

SPA104 F1 PI024 J1

SPA104 F1 PI024 J1

SPA104 F1 PI024 J1

SPA104 F1 PI024 J1

SPA104 F1 PI024 J1

SPA104 F1 PI024 J1

SPA104 F1 PI024 J1

SPA104 F1 PI024 J1

SPA104 F1 PI024 J1

SPA104 F1 PI024 J1



KW

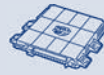

TYPE



TYPE

ALFA ROMEO

75 (162B)

1.6 (162.B2B, 162.B2C) Cat.	Petrol	81	05/89 → 02/92						
1.8 (162.B1H)	Petrol	90	08/89 → 02/92				SVF009	B6	
1.8 (162.B1H)	Petrol	95	08/89 → 02/92				SVF009	B6	
1.8 (162.B1L, 162.B1F)	Petrol	88	09/88 → 02/92				SVF009	B6	
1.8 Turbo (162.B1C, 162.B1D, 162.B1G)	Petrol	110	09/86 → 02/92						
1.8 Turbo i.e. (162.B1E)	Petrol	114	02/86 → 01/90						
2.0 T.S (162.B4A) Cat.	Petrol	109	01/88 → 02/92						
2.0 T.S (162.B4A) Cat.	Petrol	109	05/85 → 02/92						
2.0 T.S. (162.4CB, 162.B4, 162.B4A)	Petrol	107	01/88 → 02/92						
2.0 T.S. (162.4CB, 162.B4, 162.B4A)	Petrol	107	01/87 → 02/92						
2.0 T.S. (162.B4A)	Petrol	109	01/88 → 12/88						
2.5 V6 (162.B3)	Petrol	115	05/85 → 08/86						
2.5 V6 Cat.	Petrol	113	09/86 → 04/89						
3.0 V6 (162.B6A)	Petrol	136	01/87 → 12/90						
3.0 V6 (162.B6A)	Petrol	136	01/88 → 12/90						
3.0 V6 (162.B6A) Cat.	Petrol	136	01/87 → 02/92						
3.0 V6 (162.B6A) Cat.	Petrol	136	01/88 → 12/91						
3.0 V6 (162.B6C)	Petrol	141	02/90 → 02/92				SVF009	B6	
3.0 V6 (162.B6C)	Petrol	141	02/90 → 12/91						

90 (162)

2.0 i.e. (162.A2A, 162.A2E)	Petrol	94	10/84 → 07/87						
2.5 i.e. V6	Petrol	114	10/84 → 07/87						
2.5 i.e. V6 (162.A, 162.AA)	Petrol	110	10/84 → 07/87						

ALFASUD (901)

1.2 (901.D0, 901.D1)	Petrol	46	06/72 → 09/84						
1.2 (901.D5)	Petrol	44	03/80 → 12/83						
1.2 ti	Petrol	50	11/73 → 12/83						
1.3 (901.F0)	Petrol	50	01/78 → 02/80						
1.3 SC/ti Super	Petrol	55	09/77 → 12/83						
1.3 Super (901.F2)	Petrol	51	01/79 → 12/83						
1.3 ti (901.G0)	Petrol	55	09/77 → 12/83						
1.3 ti (901.G4)	Petrol	63	03/80 → 12/83						
1.5 ti	Petrol	70	03/80 → 12/83						
1.5 ti (901.F1, 901.F4, 901.G1)	Petrol	61	01/79 → 12/83						

ALFASUD Giardinetta (904)

1.2	Petrol	46	01/78 → 12/81						
1.3	Petrol	48	01/78 → 07/79						
1.3	Petrol	51	03/80 → 12/81						

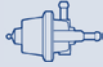

TYPE



TYPE



TYPE

PI024 J1

PI024 J1

SPA131 F1 PI024 J1

SPA129 F1

SPA129 F1

SPA104 F1

PI024 J1

SPA104 F1

PI024 J1

SPA104 F1

SPA131 F1 PI024 J1

SPA131 F1 PI024 J1

SPA131 F1 PI024 J1

SPA104 F1

SPA131 F1 PI024 J1

SPA104 F1

PI024 J1

SPA104 F1

SPA131 F1

SPA131 F1

SPA131 F1

BK2A

BK2A

BK2A

BK2A

BK2A

BK2A

BK2A

BK2A

BK2A

BK2A

BK2A

BK2A

BK2A



KW



TYPE



TYPE

ALFA ROMEO

ALFASUD Sprint (902.A)

1.4	Petrol	55	05/78 → 02/80					
1.4	Petrol	63	07/79 → 12/89					
1.5 (902.A1)	Petrol	61	05/78 → 12/81					
1.5 (902.A5)	Petrol	70	07/79 → 12/83					

ARNA (920)

1.3 TI (920.A1B)	Petrol	63	03/83 → 12/85					
------------------	--------	----	---------------	--	--	--	--	--

BRERA

2.0 JTDM	Diesel	125	05/09 →				48CPD6G	B3
2.2 JTS	Petrol	136	01/06 →					
2.2 JTS	Petrol	136	01/06 →					
2.4 JTDM 20V	Diesel	147	01/06 →					
2.4 JTDM 20V	Diesel	154	05/07 →					
2.4 JTDM 20V	Diesel	147	01/06 →					
3.2 JTS	Petrol	191	03/08 →					
3.2 JTS Q4	Petrol	191	01/06 →					

GIULIETTA (116)

2.0 Turbo	Petrol	125	07/83 → 06/84					
-----------	--------	-----	---------------	--	--	--	--	--

GIULIETTA (940)

1.4 BiFuel	BiFuel	88	12/11 →					
1.4 TB	Petrol	125	05/10 →					
1.4 TB	Petrol	88	05/10 →					
1.4 TB	Petrol	125	04/10 →					
1.4 TB	Petrol	88	04/10 →					
1.6 JTDM	Diesel	77	04/10 →					
2.0 JTDM	Diesel	103	04/10 →					
2.0 JTDM	Diesel	125	04/10 →					

GT (937)

1.8 TS	Petrol	103	11/03 → 09/10					
1.8 TS	Petrol	103	11/03 → 09/10					
1.8 TS	Petrol	103	11/03 → 09/10					
1.9 JTD	Diesel	110	11/03 → 09/10				TB0017	B3
1.9 JTD	Diesel	110	11/03 → 09/10					
1.9 JTD	Diesel	125	05/08 → 09/10					
2.0 JTS	Petrol	121	11/03 → 09/10					
2.0 JTS	Petrol	121	11/03 → 09/10					
2.0 JTS	Petrol	121	11/03 → 09/10					
2.0 JTS	Petrol	119	12/06 → 09/10					
3.2 GTA	Petrol	176	11/03 → 09/10					
3.2 GTA	Petrol	176	11/03 → 09/10					

GTV (116)

2.0 Turbodelta	Petrol	111	01/78 → 12/80					
----------------	--------	-----	---------------	--	--	--	--	--

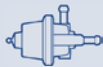

TYPE



TYPE



TYPE

										BK2A				
										BK2A				
										BK2A				
										BK2A				
										BK2A				
										BK2A				
										SAF001	H4			
										SAC092	H2			
										SAD004	H3			
	APS36		ATS20		F2					SAF001	H4			
	APS36		ATS20		F2					SAF001	H4			
										SAG133	H1			
										SAD004	H3			
										SAD004	H3			
												PI024	J1	
										BAE680BQ				
										BAE680CD				
										BAE680BQ				
												GA2115	J2	
												GA2115	J2	
	APS63									SAF001	H4			
	APS36									SAF001	H4			
	APS63									SAF001	H4			
										SAC059	H2	BAE680DE	SUA547	J2
										SAD016	H3			
										SAG102	H1			
	APS36		ATS20		F2					SAC068	H2		SUA533	J2
										SAG133	H1			
	APS36													
										SAC059	H2	BAE680AT	SUA543	J2
										SAD026	H3			
										SAG102	H1			
												BAE680AT		
										SAC029	H2	BAE680AP	SUA547	J2
										SAG039	H1			
												PI024	J1	



KW

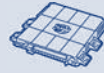

TYPE



TYPE

ALFA ROMEO

GTV (916C_)

1.8 16V (916C3)	Petrol	106	05/98 → 10/05					
1.8 16V (916C3)	Petrol	106	05/98 → 12/00					
1.8 16V (916C3)	Petrol	106	05/98 → 12/00					
2.0 JTS	Petrol	121	04/03 → 10/05					
2.0 JTS	Petrol	121	04/03 → 10/05					
2.0 T.SPARK 16V (916.C2__, 916C2C00)	Petrol	110	06/95 → 10/05				B3393	B1
2.0 T.SPARK 16V (916.C2__, 916C2C00)	Petrol	110	06/95 → 09/00				SVF015	B6
2.0 T.SPARK 16V (916.C2__, 916C2C00)	Petrol	110	06/95 → 02/98					
2.0 T.SPARK 16V (916.C2__, 916C2C00)	Petrol	110	03/98 → 09/00					
2.0 T.SPARK 16V (916.C2__, 916C2C00)	Petrol	110	06/00 → 10/05	ENGINE: 3649575 →				
2.0 T.SPARK 16V (916.C2__, 916C2C00)	Petrol	110	06/95 → 04/98					
2.0 T.SPARK 16V (916.C2__, 916C2C00)	Petrol	110	08/00 → 10/05					
2.0 T.SPARK 16V (916.C2__, 916C2C00)	Petrol	110	06/95 → 04/98					
2.0 T.SPARK 16V (916C2C)	Petrol	114	05/98 → 08/00				B3393	B1
2.0 T.SPARK 16V (916C2C)	Petrol	114	05/98 → 08/00					
2.0 T.SPARK 16V (916C2C)	Petrol	114	05/98 → 07/00					
2.0 V6 Turbo (916.C2A)	Petrol	148	06/95 → 09/98					
3.0 V6 24V (916.C1B_)	Petrol	160	10/00 → 10/05				SVF015	B6
3.0 V6 24V (916.C1B_)	Petrol	160	10/00 → 10/05					
3.2 V6 24V	Petrol	176	04/03 → 10/05					
3.2 V6 24V	Petrol	176	06/03 → 10/05					

MITO (955)

1.3 JTDM	Diesel	66	09/08 →	ENGINE: 199A3000			40CDSF1	B3
1.3 JTDM	Diesel	66	09/08 →					
1.3 JTDM	Diesel	70	10/09 →					
1.4	Petrol	58	09/08 →				TB0009	B3
1.4	Petrol	51	05/11 →	ENGINE: 955A9000				
1.4	Petrol	57	03/11 →					
1.4	Petrol	57	03/11 →	ENGINE: 955A1000				
1.4	Petrol	70	09/08 →					
1.4	Petrol	88	10/08 →					
1.4	Petrol	51	05/11 →					
1.4 BiFuel	Petrol/LPG	88	07/11 →					
1.4 TB	Petrol	114	09/08 →					
1.4 TB	Petrol	114	09/08 →					
1.4 TB	Petrol	125	10/09 →					



TYPE

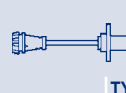

TYPE



TYPE

						SAD016	H3	ESS0025A	J1
						SAC059	H2	BAE680DD	
						SAG122	H1		
						SAC059	H2	BAE680AT	
						SAG102	H1		
			SPA104	F1		SAD009	H3		
						SAC049	H2		
						SAC059	H2		
						SAG102	H1		
								BAE680DD	
								BAE680DE	
								ESS531	J1
						SAD016	H3		
						SAG122	H1		
								BAE680DD	
						SAD009	H3	ESS0174A	J1
			SPA164	F1		SAC029	H2	BAE680AP	ESS0174A
						SAG039	H1		
						SAG039	H1	BAE680AP	
						SAC029	H2		
	APS36					SAF001	H4		
	APS36		SPA146	F1		SAF001	H4		
						SAC079	H2	SUA551	J2
						CVM03/1	H1		
						SAC079	H2		
						CVM03/1	H1		
						SAD026	H3		
								BAE680BQ	
								GA2176	J2
								BAE680BQ	
			SPA156	F1		SAC095	H2	BAE680BQ	GA2110
						SAD026	H3		J2
								BAE680CD	



KW



TYPE



TYPE

ALFA ROMEO

MITO (955)

1.4 TB	Petrol	99	10/09 →					
1.6 JTDM	Diesel	88	09/08 →					

RZ

3.0 V6 Zagato	Petrol	152	01/92 → 02/92				SVF009	B6
3.0 V6 Zagato	Petrol	152	01/92 → 12/93					

SPIDER (102)

2000	Petrol	85	08/83 → 12/61					
------	--------	----	---------------	--	--	--	--	--

SPIDER (115)

2000	Petrol	88	01/90 → 12/93				SVF009	B6
2000	Petrol	85	08/86 → 12/90					
2000 Veloce	Petrol	93	01/90 → 12/93				SVF009	B6
2000 Veloce	Petrol	93	01/77 → 12/93					

SPIDER (916S_)

1.8 16V (916S3)	Petrol	106	05/98 → 04/05					
1.8 16V (916S3)	Petrol	106	05/98 → 04/05					
1.8 16V (916S3)	Petrol	106	05/98 → 12/00					
1.8 16V (916S3)	Petrol	106	05/98 → 07/00					
2.0 JTS	Petrol	121	04/03 → 04/05					
2.0 JTS	Petrol	121	04/03 → 04/05					
2.0 T.SPARK 16V (916S2B)	Petrol	114	05/98 → 08/00				B3393	B1
2.0 T.SPARK 16V (916S2B)	Petrol	114	05/98 → 08/00				SVF015	B6
2.0 T.SPARK 16V (916S2B)	Petrol	114	05/98 → 08/00					
2.0 T.SPARK 16V (916S2B)	Petrol	114	05/98 → 07/00					
2.0 T.SPARK 16V (916S2C00)	Petrol	110	06/95 → 04/05				B3393	B1
2.0 T.SPARK 16V (916S2C00)	Petrol	110	06/95 → 04/05				SVF015	B6
2.0 T.SPARK 16V (916S2C00)	Petrol	110	06/95 → 02/98					
2.0 T.SPARK 16V (916S2C00)	Petrol	110	03/98 → 04/05					
2.0 T.SPARK 16V (916S2C00)	Petrol	110	09/00 → 04/05	ENGINE: 3649575 →				
2.0 T.SPARK 16V (916S2C00)	Petrol	110	06/95 → 04/98					
2.0 T.SPARK 16V (916S2C00)	Petrol	110	08/00 → 04/05					
3.0 V6 (916S1)	Petrol	141	06/95 → 09/00				SVF015	B6
3.0 V6 (916S1)	Petrol	141	06/95 → 04/05					
3.0 V6 (916S1)	Petrol	141	06/95 → 08/00					
3.0 V6 (916S1B00)	Petrol	160	09/94 → 08/00				SVF015	B6
3.0 V6 (916S1B00)	Petrol	160	09/94 → 08/00					
3.0 V6 24V	Petrol	162	01/99 → 10/03					
3.2 V6 24V	Petrol	176	04/03 → 04/05					
3.2 V6 24V	Petrol	176	06/03 → 04/05					

SPIDER (939)

2.0 JTDM	Diesel	125	05/09 →					
2.2 JTS	Petrol	136	09/06 →					
2.2 JTS	Petrol	136	09/06 →					
2.4 JTDM	Diesel	147	04/07 →					
2.4 JTDM	Diesel	154	03/08 →					



TYPE

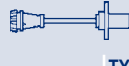

TYPE



TYPE

APS36**SAF001****H4****BAE680CD****SPA104****F1****PI024****J1****SPA104****F1****SPA131****F1****PI024****J1****SPA131****F1****PI024****J1****SAD016****H3****SAG122****H1****SAC059****H2****BAE680DD****SAC059****H2****BAE680AT****SAG102****H1****SAC059****H2****SAD016****H3****SAG122****H1****BAE680DD****SPA104****F1****SAD009****H3****SAC049****H2****SAC059****H2****SAG102****H1****BAE680DD****BAE680DE****SAC029****H2****SPA104****F1****BAE680W****SPA164****F1****SAC029****H2****BAE680AP****SAG039****H1****SPA164****F1****SAG039****H1****BAE680AP****SAC029****H2****APS36****SAF001****H4****SAC092****H2****SAD004****H3****ATS20****F2****SAF001****H4****ATS20****F2****SAF001****H4**



KW



TYPE



TYPE

ALFA ROMEO

SPIDER (939)

2.4 JTDM	Diesel	147	04/07 →						
3.2 JTS	Petrol	191	03/08 →						
3.2 JTS Q4	Petrol	191	09/06 →						

SZ

3.0 V6 Zagato	Petrol	152	01/89 → 12/91						
---------------	--------	-----	---------------	--	--	--	--	--	--

ALPINA

B7 (E65)

4.4	Petrol	368	12/03 → 06/08						
-----	--------	-----	---------------	--	--	--	--	--	--

B7 (F01, F02)

4.4 BiTurbo	Petrol	373	09/09 → 08/11						
4.4 BiTurbo Trazione integrale	Petrol	373	09/10 → 08/11						

AUDI

100 (43, C2)

1.6	Petrol	63	08/76 → 07/82						
1.9	Petrol	74	08/80 → 07/82						
2.0	Petrol	85	06/76 → 08/78						
2.0 D	Diesel	51	08/78 → 07/82						
2.1	Petrol	100	03/77 → 07/82						
2.1	Petrol	85	10/77 → 07/82						

100 (44, 44Q, C3)

1.8	Petrol	55	08/82 → 12/87						
1.8	Petrol	55	08/82 → 12/87						
1.8	Petrol	65	02/86 → 07/88						
1.8	Petrol	65	02/86 → 07/88						
1.8 Cat.	Petrol	66	03/85 → 11/90						
1.8 Cat.	Petrol	66	03/85 → 11/90						
1.8 quattro	Petrol	65	08/86 → 07/90						
1.8 quattro	Petrol	65	08/86 → 07/90						
1.8 quattro Cat.	Petrol	66	07/88 → 11/90						
1.8 quattro Cat.	Petrol	66	08/85 → 11/90						
1.8 quattro Cat.	Petrol	66	08/85 → 11/90						
1.9	Petrol	74	08/82 → 07/84						
1.9	Petrol	74	08/82 → 07/84						
2.0	Petrol	83	08/86 → 11/87						
2.0	Petrol	83	08/86 → 11/87						
2.0	Petrol	85	08/84 → 12/87						
2.0	Petrol	85	08/84 → 12/87						
2.0 Cat.	Petrol	85	01/88 → 11/90						
2.0 Cat.	Petrol	85	01/88 → 11/90						
2.0 D	Diesel	51	08/82 → 07/88						
2.0 D	Diesel	51	08/82 → 07/88						
2.0 D Turbo	Diesel	64	08/82 → 02/88						

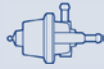

TYPE



TYPE



TYPE

SAG133 H1
SAD004 H3
SAD004 H3

SPA104 F1

BAE680AH

BAE680BR

BAE680BR

SAA102

SAA102

SAA102

SAA102

SAA102 ESS0103A J1

SAA102 ESS0112A J1

SAA102

SAA104

SAA102

SAA104

SPA143 F1 SAA102 ESS0103A J1

SAA104

SAA102

SAA104

SPA143 F1

SAA102 ESS0103A J1

SAA104

SAA102

SAA104

SAA102 ESS0103A J1

SAA104

SAA102

SAA104

SAA102 SAD019 H3 ESS0103A J1

SAA104

SAA102

SAA104

SAA102



KW



TYPE



TYPE

AUDI

100 (44, 44Q, C3)

2.0 D Turbo	Diesel	64	08/82 → 02/88						
2.0 D Turbo	Diesel	74	03/88 → 11/90						
2.0 D Turbo	Diesel	74	03/88 → 11/90						
2.1	Petrol	100	08/82 → 07/84						
2.1	Petrol	100	08/82 → 07/84						
2.2	Petrol	101	08/84 → 12/88						
2.2	Petrol	101	08/84 → 12/88						
2.2	Petrol	85	10/84 → 09/86						
2.2	Petrol	85	10/84 → 09/86						
2.2 Cat.	Petrol	101	06/89 → 11/90						
2.2 Cat.	Petrol	101	06/89 → 11/90						
2.2 E quattro	Petrol	88	08/85 → 07/86						
2.2 E quattro	Petrol	88	08/85 → 07/86						
2.2 E Turbo quattro	Petrol	121	08/86 → 11/90						
2.2 E Turbo quattro	Petrol	121	08/86 → 11/90						
2.2 quattro	Petrol	101	08/84 → 12/88						
2.2 quattro	Petrol	101	08/84 → 12/88						
2.2 quattro Cat.	Petrol	101	06/89 → 11/90						
2.2 quattro Cat.	Petrol	101	06/89 → 11/90						
2.2 Turbo	Petrol	121	08/86 → 11/90						
2.2 Turbo	Petrol	121	08/86 → 11/90						
2.3 E	Petrol	100	10/86 → 11/90						
2.3 E	Petrol	100	10/86 → 11/90						
2.3 E	Petrol	98	01/90 → 11/90						
2.3 E	Petrol	98	01/90 → 11/90						
2.3 E quattro	Petrol	100	08/86 → 11/90						
2.3 E quattro	Petrol	100	08/86 → 11/90						
2.3 quattro	Petrol	98	01/90 → 11/90						
2.3 quattro	Petrol	98	01/90 → 11/90						
2.4 D	Diesel	60	08/89 → 07/91						
2.4 D	Diesel	60	08/89 → 07/91						
2.5 TDI	Diesel	88	01/90 → 11/90						
2.5 TDI	Diesel	88	01/90 → 11/90						

100 (4A, C4)

2.0	Petrol	74	12/90 → 06/94						
2.0	Petrol	74	12/90 → 06/94						
2.0	Petrol	74	01/93 → 06/94						
2.0 E	Petrol	85	12/90 → 06/94						
2.0 E	Petrol	85	12/90 → 06/94						
2.0 E	Petrol	85	01/93 → 06/94						
2.0 E	Petrol	85	12/92 → 06/94	ENGINE: ABK					
2.0 E 16V	Petrol	103	01/92 → 06/94						
2.0 E 16V	Petrol	103	01/92 → 06/94						
2.0 E 16V	Petrol	103	01/93 → 06/94						



KW

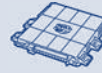

TYPE



TYPE

AUDI

100 (4A, C4)

2.0 E 16V quattro	Petrol	103	07/92 → 06/94					
2.0 E 16V quattro	Petrol	103	07/92 → 06/94					
2.0 E 16V quattro	Petrol	103	01/93 → 06/94					
2.0 E quattro	Petrol	85	12/90 → 07/92					
2.0 E quattro	Petrol	85	12/90 → 07/92					
2.3 E	Petrol	98	12/90 → 06/94					
2.3 E	Petrol	98	12/90 → 06/94					
2.3 E	Petrol	98	01/93 → 06/94					
2.3 E quattro	Petrol	98	12/90 → 06/94					
2.3 E quattro	Petrol	98	12/90 → 06/94					
2.3 E quattro	Petrol	98	01/93 → 06/94					
2.4 D	Diesel	60	12/90 → 06/94					
2.4 D	Diesel	60	12/90 → 06/94					
2.4 D	Diesel	60	01/93 → 06/94					
2.5 TDI	Diesel	85	06/91 → 06/94					
2.5 TDI	Diesel	85	12/90 → 06/94					
2.5 TDI	Diesel	85	12/90 → 06/94					
2.5 TDI	Diesel	85	01/93 → 06/94					
2.6	Petrol	110	03/92 → 06/94	CHASSIS: 4AM000001 →			B3391	B1
2.6	Petrol	110	04/92 → 06/94					
2.6	Petrol	102	07/93 → 06/94					
2.6	Petrol	110	03/92 → 06/94					
2.6	Petrol	102	07/93 → 06/94					
2.6	Petrol	110	03/92 → 06/94					
2.6	Petrol	110	01/93 → 06/94					
2.6 quattro	Petrol	110	04/92 → 06/94	CHASSIS: 4AM000001 →			B3391	B1
2.6 quattro	Petrol	110	04/92 → 06/94					
2.6 quattro	Petrol	110	04/92 → 06/94					
2.6 quattro	Petrol	110	01/93 → 06/94					
2.8 E	Petrol	128	12/90 → 06/94				AMM19669	B4
2.8 E	Petrol	128	12/90 → 06/94					
2.8 E	Petrol	128	01/93 → 06/94					
2.8 E quattro	Petrol	128	12/90 → 06/94				AMM19669	B4
2.8 E quattro	Petrol	128	12/90 → 06/94					
2.8 E quattro	Petrol	128	01/93 → 06/94					
S4 Turbo quattro	Petrol	169	07/92 → 06/94					
S4 Turbo quattro	Petrol	169	08/91 → 06/94					
S4 Turbo quattro	Petrol	169	08/91 → 06/94					
S4 Turbo quattro	Petrol	169	06/92 → 06/94					
S4 V8 quattro	Petrol	206	10/92 → 06/94					
S4 V8 quattro	Petrol	213	03/94 → 06/94					

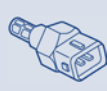
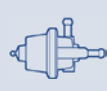

TYPE

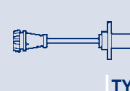

TYPE



TYPE

					SAA102	SAD021	H3			
					SAA104					
						SAG026	H1			
			SPA106	F1	SAA102	SAD021	H3			
					SAA104					
					SAA102	SAD019	H3			
					SAA104					
						SAG026	H1			
					SAA102					
					SAA104					
						SAG026	H1			
					SAA102					
					SAA104					
						SAG026	H1			
			SPA121	F1						
					SAA102					
					SAA104					
						SAG026	H1			
			RP02A							
				SPA143	F1	SAA102			ESS529	J1
				SPA143	F1	SAA102	SAD021	H3	ESS529	J1
					SAA104					
					SAA104					
						SAG026	H1			
			RP02A	SPA143	F1	SAA102	SAD021	H3	ESS529	J1
					SAA104					
						SAG026	H1			
			RP02A	SPA143	F1	SAA102	SAD021	H3		
					SAA104					
						SAG026	H1			
			RP02A	SPA143	F1	SAA102	SAD021	H3	ESS529	J1
					SAA104					
						SAG026	H1			
			RP02A							
					SAA102	SAD021	H3			
					SAA104					
									ESS529	J1
				SPA121	F1	SAA102			ESS529	J1
					SAA102					



KW



TYPE



TYPE

AUDI

100 (C1)

1.8	Petrol	63	09/71 → 07/73					
1.8	Petrol	74	10/70 → 07/73					
1.9	Petrol	82	09/71 → 07/73					

100 Avant (43, C2)

1.6	Petrol	63	07/77 → 02/83					
1.9	Petrol	74	08/80 → 07/82					
2.0	Petrol	85	08/77 → 07/80					
2.0 D	Diesel	51	08/78 → 02/83					
2.1	Petrol	100	07/77 → 02/83					
2.1	Petrol	85	07/77 → 02/83					

100 Avant (44, 44Q, C3)

1.8	Petrol	55	08/82 → 12/87					
1.8	Petrol	55	08/82 → 12/87					
1.8	Petrol	65	02/86 → 07/90					
1.8	Petrol	65	02/86 → 07/90					
1.8	Petrol	66	08/83 → 07/89					
1.8	Petrol	66	08/83 → 07/89					
1.8 Cat.	Petrol	66	03/85 → 11/90					
1.8 Cat.	Petrol	66	03/85 → 11/90					
2.0	Petrol	83	09/86 → 11/87					
2.0	Petrol	83	09/86 → 11/87					
2.0 D	Diesel	51	03/83 → 11/90					
2.0 D	Diesel	51	03/83 → 11/90					
2.0 E	Petrol	85	01/85 → 12/87					
2.0 E	Petrol	85	01/85 → 12/87					
2.0 E Cat.	Petrol	85	01/88 → 11/90					
2.0 E Cat.	Petrol	85	01/88 → 11/90					
2.0 TD	Diesel	64	03/83 → 10/87					
2.0 TD	Diesel	64	03/83 → 10/87					
2.0 TD	Diesel	74	03/88 → 11/90					
2.0 TD	Diesel	74	03/88 → 11/90					
2.1	Petrol	100	08/82 → 07/84					
2.1	Petrol	100	08/82 → 07/84					
2.2	Petrol	101	08/84 → 12/88					
2.2	Petrol	101	08/84 → 12/88					
2.2	Petrol	85	10/84 → 09/86					
2.2	Petrol	85	10/84 → 09/86					
2.2 Cat.	Petrol	101	06/89 → 11/90					
2.2 Cat.	Petrol	101	06/89 → 11/90					
2.2 E quattro	Petrol	88	08/85 → 07/86					
2.2 E quattro	Petrol	88	08/85 → 07/86					
2.2 quattro	Petrol	101	08/84 → 12/88					
2.2 quattro	Petrol	101	08/84 → 12/88					
2.2 quattro Cat.	Petrol	101	06/89 → 11/90					

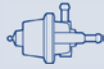

TYPE



TYPE



TYPE

				SAA102			
				SAA102			
				SAA102			
				SAA102			
				SAA102			
				SAA102			
				SAA102		ESS0112A	J1
				SAA102		ESS0112A	J1
				SAA102			
				SAA104			
				SAA102			
				SAA104			
				SAA102			
				SAA104			
		SPA143	F1	SAA102			
				SAA104			
				SAA102			
				SAA104			
				SAA102			
				SAA104			
				SAA102			
				SAA104			
				SAA102	SAD019	H3	
				SAA104			
				SAA102			
				SAA104			
				SAA102			
				SAA104			
				SAA102			
				SAA104			
				SAA102			
				SAA104			
				SAA102			
				SAA104			
				SAA102			
				SAA104			
				SAA102			
				SAA104			



KW



TYPE



TYPE

AUDI

100 Avant (44, 44Q, C3)

2.2 quattro Cat.	Petrol	101	06/89 → 11/90						
2.2 Turbo	Petrol	121	08/86 → 11/90						
2.2 Turbo	Petrol	121	08/86 → 11/90						
2.2 Turbo quattro	Petrol	121	08/86 → 11/90						
2.2 Turbo quattro	Petrol	121	08/86 → 11/90						
2.3	Petrol	100	08/86 → 11/90						
2.3	Petrol	100	08/86 → 11/90						
2.3	Petrol	98	03/90 → 11/90						
2.3	Petrol	98	03/90 → 11/90						
2.3 E quattro	Petrol	100	08/86 → 11/90						
2.3 E quattro	Petrol	100	08/86 → 11/90						
2.3 quattro	Petrol	98	01/90 → 11/90						
2.3 quattro	Petrol	98	01/90 → 11/90						
2.4 D	Diesel	60	08/89 → 11/90						
2.4 D	Diesel	60	08/89 → 11/90						
2.5 TDI	Diesel	88	01/90 → 11/90						
2.5 TDI	Diesel	88	01/90 → 11/90						

100 Avant (4A, C4)

2.0 E	Petrol	74	09/91 → 06/94						
2.0 E	Petrol	85	09/91 → 06/94						
2.0 E	Petrol	74	09/91 → 06/94						
2.0 E	Petrol	85	09/91 → 06/94						
2.0 E	Petrol	74	01/93 → 06/94						
2.0 E	Petrol	85	01/93 → 06/94						
2.0 E	Petrol	85	12/92 → 06/94	ENGINE: ABK					
2.0 E 16V	Petrol	103	01/93 → 06/94						
2.0 E 16V quattro	Petrol	103	01/93 → 06/94						
2.0 E quattro	Petrol	85	12/90 → 07/92						
2.0 E quattro	Petrol	85	12/90 → 07/92						
2.3 E	Petrol	98	09/91 → 06/94						
2.3 E	Petrol	98	09/91 → 06/94						
2.3 E	Petrol	98	01/93 → 06/94						
2.3 E quattro	Petrol	98	09/91 → 06/94						
2.3 E quattro	Petrol	98	09/91 → 06/94						
2.3 E quattro	Petrol	98	01/93 → 06/94						
2.4 D	Diesel	60	12/90 → 06/94						
2.4 D	Diesel	60	12/90 → 06/94						
2.4 D	Diesel	60	01/93 → 06/94						
2.5 TDI	Diesel	85	06/91 → 06/94						
2.5 TDI	Diesel	85	12/90 → 06/94						
2.5 TDI	Diesel	85	12/90 → 06/94						
2.5 TDI	Diesel	85	01/93 → 06/94						
2.6	Petrol	110	03/92 → 06/94	CHASSIS: 4AM000001 →			B3391		B1
2.6	Petrol	110	07/92 → 06/94						



TYPE

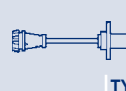

TYPE



TYPE

						SAA104				
						SAA102				
						SAA104				
						SAA102				
						SAA104				
					SPA125	F1	SAA102	SAD019	H3	
							SAA104			
							SAA102			
							SAA104			
					SPA125	F1	SAA102			
							SAA104			
							SAA102			
							SAA104			
							SAA102			
							SAA104			
					SPA121	F1	SAA102			
							SAA104			
					SPA106	F1	SAA102			
					SPA106	F1	SAA102	SAD019	H3	
							SAA104			
							SAA104	SAD021	H3	
								SAG026	H1	
								SAG026	H1	
										ESS529
										J1
								SAG026	H1	
								SAG026	H1	
					SPA106	F1	SAA102	SAD021	H3	
							SAA104			
							SAA102	SAD019	H3	
							SAA104			
								SAG026	H1	
							SAA102			
							SAA104			
								SAG026	H1	
							SAA102			
							SAA104			
								SAG026	H1	
					SPA121	F1		SAG026	H1	
							SAA102			
							SAA104			
								SAG026	H1	
					RP02A					



KW



TYPE



TYPE

AUDI

100 Avant (4A, C4)

2.6	Petrol	102	07/93 → 06/94					
2.6	Petrol	110	03/92 → 06/94					
2.6	Petrol	102	07/93 → 06/94					
2.6	Petrol	110	03/92 → 06/94					
2.6	Petrol	110	01/93 → 06/94					
2.6	Petrol	110	06/92 → 06/94					
2.6 quattro	Petrol	110	07/92 → 06/94	CHASSIS: 4AM000001 →		B3391		B1
2.6 quattro	Petrol	110	07/92 → 06/94					
2.6 quattro	Petrol	110	07/92 → 06/94					
2.6 quattro	Petrol	110	01/93 → 06/94					
2.8 E	Petrol	128	09/91 → 06/94			AMM19669		B4
2.8 E	Petrol	128	09/91 → 06/94					
2.8 E	Petrol	128	01/93 → 06/94					
2.8 E quattro	Petrol	128	09/91 → 06/94			AMM19669		B4
2.8 E quattro	Petrol	128	09/91 → 06/94					
2.8 E quattro	Petrol	128	01/93 → 06/94					
S4 Turbo quattro	Petrol	169	09/91 → 06/94					
S4 Turbo quattro	Petrol	169	09/91 → 06/94					
S4 V8 quattro	Petrol	206	10/92 → 06/94					
S4 V8 quattro	Petrol	213	03/94 → 06/94					

200 (43)

2.1 5E	Petrol	100	10/79 → 09/82					
2.1 5T	Petrol	125	10/79 → 08/82					

200 (44, 44Q)

2.1 5E	Petrol	100	08/83 → 07/84					
2.1 5E	Petrol	100	08/83 → 07/84					
2.1 Turbo	Petrol	134	08/83 → 01/88					
2.1 Turbo	Petrol	134	08/83 → 01/88					
2.1 Turbo quattro	Petrol	134	08/83 → 09/86					
2.1 Turbo quattro	Petrol	134	08/83 → 09/86					
2.2	Petrol	101	08/84 → 07/85					
2.2	Petrol	101	08/84 → 07/85					
2.2 20V Turbo quattro	Petrol	162	03/89 → 12/90					
2.2 20V Turbo quattro	Petrol	162	03/89 → 12/90					
2.2 Turbo	Petrol	121	08/85 → 09/91					
2.2 Turbo	Petrol	121	08/85 → 09/91					
2.2 Turbo	Petrol	140	02/88 → 12/90					
2.2 Turbo	Petrol	140	02/88 → 12/90					
2.2 Turbo	Petrol	147	02/88 → 12/90					
2.2 Turbo	Petrol	147	02/88 → 12/90					
2.2 Turbo quattro	Petrol	121	01/85 → 12/91					
2.2 Turbo quattro	Petrol	121	01/85 → 12/91					
2.2 Turbo quattro	Petrol	147	02/88 → 11/90					
2.2 Turbo quattro	Petrol	147	02/88 → 11/90					

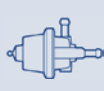

TYPE

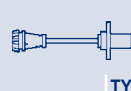

TYPE



TYPE

			SPA143	F1	SAA102				ESS529	J1
			SPA143	F1	SAA102	SAD021	H3			
					SAA104					
					SAA104					
						SAG026	H1			
									ESS529	J1
		RP02A	SPA143	F1	SAA102	SAD021	H3		ESS529	J1
					SAA104					
						SAG026	H1			
		RP02A	SPA143	F1	SAA102	SAD021	H3		ESS529	J1
					SAA104					
						SAG026	H1			
		RP02A	SPA143	F1	SAA102	SAD021	H3		ESS529	J1
					SAA104					
						SAG026	H1			
					SAA102					
					SAA104					
					SAA102					
					SAA102					
						SAG026	H1			
					SAA102				ESS0103A	J1
					SAA102					
					SAA102				ESS0103A	J1
					SAA104					
					SAA102				ESS0103A	J1
					SAA104					
					SAA102				ESS0103A	J1
					SAA104					
					SAA102				ESS0103A	J1
					SAA104					
					SAA102				ESS0103A	J1
					SAA104					
					SAA102				ESS0103A	J1
					SAA104					
					SAA102				ESS0103A	J1
					SAA104					
		RP03A	SPA121	F1	SAA102	SAD021	H3			
					SAA104					
					SAA102				ESS0103A	J1
					SAA104					
					SAA102				ESS0103A	J1
					SAA104					
					SAA102				ESS0103A	J1
					SAA104					
					SAA102				ESS0103A	J1
					SAA104					
					SAA102				ESS0103A	J1
					SAA104					



KW



TYPE



TYPE

AUDI

200 (44, 44Q)

2.3	Petrol	100	11/86 → 12/90					
2.3	Petrol	100	11/86 → 09/91					
2.3	Petrol	100	11/86 → 09/91					

200 Avant (44, 44Q)

2.1 Turbo quattro	Petrol	134	09/83 → 01/88					
2.1 Turbo quattro	Petrol	134	09/83 → 01/88					
2.2 20V Turbo quattro	Petrol	162	07/89 → 11/90					
2.2 20V Turbo quattro	Petrol	162	07/89 → 12/90					
2.2 20V Turbo quattro	Petrol	162	07/89 → 12/90					
2.2 20V Turbo quattro	Petrol	162	07/89 → 11/90					
2.2 Turbo	Petrol	121	08/85 → 09/91					
2.2 Turbo	Petrol	121	08/85 → 09/91					
2.2 Turbo quattro	Petrol	121	09/83 → 12/90					
2.2 Turbo quattro	Petrol	121	09/83 → 12/90					
2.2 Turbo quattro	Petrol	147	02/88 → 12/91					
2.2 Turbo quattro	Petrol	147	02/88 → 12/91					
2.3	Petrol	100	11/86 → 12/90					
2.3	Petrol	100	11/86 → 09/91					
2.3	Petrol	100	11/86 → 09/91					

50 (86)

1.1	Petrol	37	08/74 → 07/78					
1.1	Petrol	44	08/74 → 07/77					
1.3	Petrol	44	08/77 → 07/78					

80 (81, 85, B2)

1.3	Petrol	40	09/78 → 07/81					
1.3	Petrol	40	09/78 → 07/81					
1.3	Petrol	44	09/78 → 07/86					
1.3	Petrol	44	08/83 → 07/86					
1.6	Petrol	54	02/86 → 07/86					
1.6	Petrol	54	02/86 → 07/86					
1.6	Petrol	55	08/78 → 07/86					
1.6	Petrol	55	08/83 → 07/86					
1.6	Petrol	63	08/78 → 02/83					
1.6	Petrol	63	08/78 → 02/83					
1.6 D	Diesel	40	08/80 → 08/86					
1.6 D	Diesel	40	08/83 → 08/86					
1.6 GLE	Petrol	81	01/79 → 12/86					
1.6 GLE	Petrol	81	01/79 → 12/86					
1.6 TD	Diesel	51	08/81 → 05/86					
1.6 TD	Diesel	51	08/83 → 05/86					
1.8	Petrol	65	02/86 → 07/86					
1.8	Petrol	65	02/86 → 07/86					
1.8	Petrol	66	01/83 → 08/86					
1.8	Petrol	66	08/83 → 08/86					



TYPE

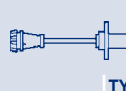

TYPE



TYPE

				SPA125	F1					
						SAA102				
						SAA104				
						SAA102			ESS0103A	J1
						SAA104				
			RP03A							
				SPA121	F1	SAA102	SAD021	H3		
						SAA104				
									ESS529	J1
						SAA102			ESS0103A	J1
						SAA104				
						SAA102			ESS0103A	J1
						SAA104				
						SAA102			ESS0103A	J1
						SAA104				
				SPA125	F1					
						SAA102				
						SAA104				
						SAA102				
						SAA102				
						SAA102				
						SAA104				
						SAA104				
						SAA102				
						SAA104				
						SAA102				
						SAA104				
						SAA102				
						SAA104				
						SAA102				
						SAA104				
						SAA102				
						SAA104			ESS0112A	J1
						SAA102				
						SAA104				
						SAA102				
						SAA104				
						SAA102				
						SAA104				
						SAA102				
						SAA104				
						SAA102				
						SAA104				
						SAA102				
						SAA104				
						SAA102				
						SAA104				



KW



TYPE



TYPE

AUDI

80 (81, 85, B2)

1.8 CC quattro (85Q)	Petrol	66	08/84 → 08/86
1.8 CC quattro (85Q)	Petrol	66	08/84 → 08/86
1.8 GTE	Petrol	82	10/84 → 08/86
1.8 GTE	Petrol	82	10/84 → 08/86
1.8 GTE quattro (85Q)	Petrol	81	03/85 → 08/86
1.8 GTE quattro (85Q)	Petrol	81	03/85 → 08/86
1.8 GTE quattro (85Q)	Petrol	82	08/84 → 08/86
1.8 GTE quattro (85Q)	Petrol	82	08/84 → 08/86
2.0	Petrol	85	10/83 → 09/84
2.0	Petrol	85	10/83 → 09/84
2.0 quattro (85Q)	Petrol	85	10/83 → 09/84
2.0 quattro (85Q)	Petrol	85	10/83 → 09/84
2.2 quattro	Petrol	96	08/82 → 07/84
2.2 quattro (85Q)	Petrol	100	08/82 → 07/84
2.2 quattro (85Q)	Petrol	100	08/83 → 07/84

80 (89, 89Q, 8A, B3)

1.6	Petrol	51	08/87 → 09/91
1.6	Petrol	75	08/90 → 10/91
1.6	Petrol	51	08/87 → 09/91
1.6	Petrol	55	09/86 → 08/91
1.6	Petrol	55	09/86 → 08/91
1.6 D	Diesel	40	09/86 → 08/91
1.6 D	Diesel	40	09/86 → 08/91
1.6 TD	Diesel	59	09/86 → 08/91
1.6 TD	Diesel	59	09/86 → 08/91
1.8	Petrol	83	09/87 → 07/88
1.8	Petrol	55	10/86 → 01/90
1.8	Petrol	55	10/86 → 01/90
1.8	Petrol	83	09/86 → 07/88
1.8	Petrol	83	09/86 → 07/88
1.8 E	Petrol	82	09/86 → 08/91
1.8 E	Petrol	82	06/86 → 08/91
1.8 E	Petrol	82	06/86 → 08/91
1.8 E quattro	Petrol	82	09/86 → 08/91
1.8 E quattro	Petrol	82	09/86 → 08/91
1.8 quattro	Petrol	83	09/86 → 07/88
1.8 quattro	Petrol	83	09/86 → 08/90
1.8 quattro	Petrol	83	09/86 → 08/90
1.8 S	Petrol	65	09/86 → 01/90
1.8 S	Petrol	66	09/86 → 10/91
1.8 S	Petrol	65	09/86 → 12/90
1.8 S	Petrol	65	09/86 → 12/90
1.8 S	Petrol	66	09/86 → 10/91
1.8 S quattro	Petrol	66	09/86 → 07/90

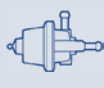

TYPE

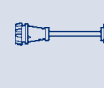

TYPE



TYPE

					SAA102					
					SAA104					
					SAA102				ESS0112A	J1
					SAA104					
					SAA102				ESS0112A	J1
					SAA104					
					SAA102				ESS0112A	J1
					SAA104					
					SAA102				ESS0112A	J1
					SAA104					
					SAA102				ESS0112A	J1
					SAA104					
					SAA102				ESS0112A	J1
					SAA104					
					SAA102				ESS0112A	J1
					SAA104					
					SAA102				ESS0112A	J1
					SAA104					

				SPA143	F1	SAA102				
				SPA143	F1				ESS0112A	J1
						SAA104				
						SAA102				
						SAA104				
						SAA102				
						SAA104				
						SAA102				
						SAA104				
				SPA143	F1					
						SAA102				
						SAA104				
						SAA102	SAD019	H3	ESS0112A	J1
						SAA104				
				SPA143	F1					
						SAA102			ESS0112A	J1
						SAA104				
						SAA102				
						SAA104				
				SPA143	F1					
						SAA102	SAD021	H3		
						SAA104				
				SPA143	F1					
				SPA106	F1	SAA102			ESS0112A	J1
						SAA102				
						SAA104				
						SAA104				
				SPA143	F1					



KW

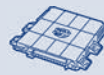

TYPE



TYPE

AUDI

80 (89, 89Q, 8A, B3)

1.8 S quattro	Petrol	65	09/86 → 07/90						
1.8 S quattro	Petrol	65	09/86 → 07/90						
1.8 S quattro	Petrol	66	09/86 → 09/91						
1.8 S quattro	Petrol	66	09/86 → 09/91						
1.9 D	Diesel	50	08/89 → 08/91						
1.9 D	Diesel	50	08/89 → 08/91						
2.0	Petrol	82	10/90 → 08/91						
2.0	Petrol	82	10/90 → 08/91						
2.0 E	Petrol	83	08/88 → 10/90						
2.0 E	Petrol	83	08/88 → 10/90						
2.0 E 16V	Petrol	101	03/90 → 09/91						
2.0 E 16V	Petrol	101	03/90 → 09/91						
2.0 E 16V quattro	Petrol	101	03/90 → 08/91						
2.0 E 16V quattro	Petrol	101	03/90 → 08/91						
2.0 E quattro	Petrol	83	08/88 → 09/90						
2.0 E quattro	Petrol	83	08/88 → 09/90						
2.0 quattro	Petrol	85	10/90 → 08/91						
2.0 quattro	Petrol	82	08/88 → 07/90						
2.0 quattro	Petrol	82	08/88 → 07/90						
2.0 quattro	Petrol	85	10/90 → 08/91						

80 (8C, B4)

1.6	Petrol	52	09/91 → 12/94						
1.6	Petrol	52	09/91 → 12/94						
1.6 E	Petrol	74	06/93 → 12/94						
1.6 E	Petrol	74	06/93 → 12/94						
1.9 TD	Diesel	55	09/91 → 12/94						
1.9 TD	Diesel	55	09/91 → 12/94						
1.9 TDI	Diesel	66	09/91 → 12/94						
1.9 TDI	Diesel	66	09/91 → 12/94						
2.0	Petrol	66	09/91 → 12/94						
2.0	Petrol	66	09/91 → 12/94						
2.0	Petrol	66	01/92 → 12/94						
2.0 E	Petrol	85	09/91 → 12/94						
2.0 E	Petrol	85	09/91 → 12/94						
2.0 E	Petrol	85	01/92 → 12/94						
2.0 E 16V	Petrol	103	08/92 → 12/94						
2.0 E 16V	Petrol	103	08/92 → 12/94						
2.0 E 16V quattro	Petrol	103	08/92 → 12/94						
2.0 E 16V quattro	Petrol	103	04/92 → 12/94						
2.0 E 16V quattro	Petrol	103	04/92 → 12/94						
2.0 E quattro	Petrol	85	09/91 → 12/94						
2.0 E quattro	Petrol	85	09/91 → 12/94						
2.0 E quattro	Petrol	85	01/92 → 12/94						
2.3 E	Petrol	98	09/91 → 12/94						



TYPE

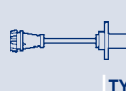

TYPE



TYPE

						SAA102					
						SAA104					
						SAA102					
						SAA104					
						SAA102					
						SAA104					
				SPA143	F1	SAA102	SAD021	H3		ESS0112A	J1
						SAA104					
				SPA143	F1	SAA102	SAD019	H3		ESS0112A	J1
						SAA104					
				SPA143	F1	SAA102	SAD019	H3		ESS0112A	J1
						SAA104	SAD021	H3			
				SPA143	F1	SAA102	SAD021	H3			
						SAA104					
				SPA143	F1	SAA102	SAD021	H3			
						SAA104					
				SPA143	F1	SAA102	SAD021	H3			
						SAA104					
						SAA104					
						SAA104					
				SPA106	F1	SAA102					
						SAA104					
			RP02A			SAA102	SAD021	H3		ESS529	J1
						SAA104	SAG127	H1			
				SPA105	F1	SAA102					
						SAA104					
		APS29		SPA105	F1	SAA102					
						SAA104					
				SPA106	F1	SAA102					
						SAA104					
							SAG026	H1			
				SPA106	F1	SAA102	SAD021	H3		ESS529	J1
						SAA104					
							SAG026	H1			
				SPA143	F1	SAA102	SAD019	H3			
						SAA104	SAD021	H3			
				SPA143	F1						
						SAA102	SAD021	H3			
						SAA104					
				SPA106	F1	SAA102	SAD021	H3		ESS529	J1
						SAA104					
							SAG026	H1			
				SPA125	F1	SAA102	SAD019	H3			



KW



TYPE



TYPE

AUDI

80 (8C, B4)

2.3 E	Petrol	98	09/91 → 12/94					
2.3 E quattro	Petrol	98	09/91 → 12/94					
2.3 E quattro	Petrol	98	09/91 → 12/94					
2.6	Petrol	110	07/92 → 12/94	CHASSIS: 8CN000001 → 8CS025820			B3391	B1
2.6	Petrol	110	07/92 → 12/94					
2.6	Petrol	110	07/92 → 12/94					
2.6 quattro	Petrol	110	06/92 → 12/94	CHASSIS: 8CN000001 → 8CS025820			B3391	B1
2.6 quattro	Petrol	110	07/92 → 12/94					
2.6 quattro	Petrol	110	06/92 → 12/94					
2.6 quattro	Petrol	110	06/92 → 12/94					
2.8	Petrol	128	09/91 → 12/94				AMM19669	B4
2.8	Petrol	128	09/91 → 12/94					
2.8	Petrol	128	01/92 → 12/94					
2.8 quattro	Petrol	128	09/91 → 12/94				AMM19669	B4
2.8 quattro	Petrol	128	09/91 → 12/94					
2.8 quattro	Petrol	128	01/92 → 12/94					
S2 quattro	Petrol	169	02/93 → 12/94					
S2 quattro	Petrol	169	02/93 → 12/94					

80 Avant (8C, B4)

1.6 E	Petrol	74	06/93 → 07/95					
1.6 E	Petrol	74	06/93 → 01/96					
1.6 E	Petrol	74	06/93 → 01/96					
1.6 E	Petrol	74	06/93 → 07/95					
1.9 TDI	Diesel	66	07/92 → 01/96					
1.9 TDI	Diesel	66	07/92 → 01/96					
1.9 TDI	Diesel	66	07/92 → 12/94					
2.0	Petrol	66	07/92 → 01/96					
2.0	Petrol	66	07/92 → 01/96					
2.0 E	Petrol	85	07/92 → 01/96					
2.0 E	Petrol	85	07/92 → 01/96					
2.0 E	Petrol	85	07/92 → 07/95					
2.0 E 16V	Petrol	103	02/93 → 07/95					
2.0 E 16V	Petrol	103	02/93 → 01/96					
2.0 E 16V	Petrol	103	02/93 → 01/96					
2.0 E 16V	Petrol	103	02/93 → 01/96					
2.0 quattro	Petrol	79	11/93 → 07/95					
2.3 E	Petrol	98	07/92 → 11/94					
2.3 E	Petrol	98	07/92 → 01/96					
2.3 E	Petrol	98	07/92 → 01/96					
2.3 E quattro	Petrol	98	09/91 → 11/94					
2.3 E quattro	Petrol	98	09/91 → 11/94					



TYPE

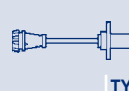

TYPE



TYPE

					SAA104	SAD021	H3		
			SPA125	F1	SAA102	SAD021	H3		
					SAA104				
			RP02A	SPA143	F1	SAA102	SAD019	H3	ESS529
					SAA104	SAD021	H3		
			RP02A						
				ATS08	F2	SAA102	SAD021	H3	ESS529
				SPA143	F1	SAA104			J1
			RP02A	SPA143	F1	SAA102	SAD019	H3	ESS529
						SAA104	SAD021	H3	
							SAG026	H1	
			RP02A	SPA143	F1	SAA102	SAD021	H3	ESS529
						SAA104			
							SAG026	H1	
			RP02A	SPA121	F1	SAA102	SAD021	H3	ESS529
						SAA104			J1
			RP02A						
						SAA102	SAD021	H3	
						SAA104	SAG127	H1	
									ESS529
		APS29		SPA106	F1	SAA102			J1
						SAA104			
				SPA105	F1				
				SPA106	F1	SAA102	SAG026	H1	
						SAA104			
				SPA106	F1	SAA102	SAD021	H3	
						SAA104	SAG026	H1	
									ESS529
				SPA143	F1				J1
						SAA102	SAD019	H3	
						SAA104	SAD021	H3	
							SAG026	H1	
									ESS529
				SPA125	F1				J1
						SAA102	SAD019	H3	
						SAA104	SAD021	H3	
				SPA125	F1	SAA102	SAD021	H3	
						SAA104			



KW

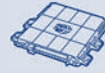

TYPE



TYPE

AUDI

80 Avant (8C, B4)

2.6	Petrol	110	07/92 → 01/96	CHASSIS: 8CN000001 → 8CS025820				B3391	B1
2.6	Petrol	110	08/92 → 05/95						
2.6	Petrol	110	07/92 → 05/95						
2.6	Petrol	110	07/92 → 01/96						
2.6	Petrol	110	07/92 → 01/96						
2.6	Petrol	110	07/92 → 05/95						
2.6 quattro	Petrol	110	07/92 → 07/95	CHASSIS: 8CN000001 → 8CS025820				B3391	B1
2.6 quattro	Petrol	110	08/92 → 07/95						
2.6 quattro	Petrol	110	07/92 → 07/95						
2.6 quattro	Petrol	110	07/92 → 07/95						
2.8	Petrol	128	09/91 → 01/96					AMM19669	B4
2.8	Petrol	128	08/92 → 05/95						
2.8	Petrol	128	09/91 → 01/96						
2.8	Petrol	128	01/92 → 01/96						
2.8	Petrol	128	07/92 → 05/95						
2.8 quattro	Petrol	128	08/92 → 07/95					AMM19669	B4
2.8 quattro	Petrol	128	08/92 → 07/95						
RS2 quattro (P1)	Petrol	232	03/94 → 05/95						
RS2 quattro (P1)	Petrol	232	03/94 → 05/95						
S2 quattro	Petrol	169	07/94 → 07/95						
S2 quattro	Petrol	169	02/93 → 07/95						
S2 quattro	Petrol	169	02/93 → 07/95						
S2 quattro	Petrol	169	06/94 → 07/95						

90 (81, 85, B2)

1.6 TD	Diesel	51	10/85 → 01/87						
2.0	Petrol	85	10/84 → 03/87						
2.2	Petrol	100	10/84 → 03/87						
2.2	Petrol	85	01/85 → 03/87						
2.2 E quattro	Petrol	100	11/84 → 03/87						
2.2 E quattro	Petrol	88	08/85 → 03/87						

90 (89, 89Q, 8A, B3)

1.6 TD	Diesel	59	04/87 → 09/91						
2.0	Petrol	85	07/88 → 09/91						
2.0 20 V	Petrol	118	08/89 → 07/91						
2.0 20 V	Petrol	118	08/89 → 07/91						
2.0 20 V quattro	Petrol	118	08/88 → 09/91						
2.0 20 V quattro	Petrol	118	08/88 → 09/91						
2.2 E	Petrol	100	04/87 → 07/91						
2.2 E quattro	Petrol	100	04/87 → 09/91						
2.3 E	Petrol	100	04/87 → 07/91						
2.3 E	Petrol	98	04/87 → 09/91						
2.3 E	Petrol	100	04/87 → 07/91						



		RP02A							
			SPA143	F1					
					SAA102	SAD019	H3		
					SAA104	SAD021	H3		
								ESS529	J1
		RP02A							
			ATS08	F2	SAA102	SAD021	H3	ESS529	J1
			SPA143	F1	SAA104				
					SAA102	SAD019	H3		
		RP02A	SPA143	F1					
					SAA104	SAD021	H3		
						SAG026	H1		
								ESS529	J1
		RP02A	SPA143	F1	SAA102	SAD021	H3	ESS529	J1
					SAA104	SAG026	H1		
					SAA102	SAD021	H3		
					SAA104				
		RP02A	SPA121	F1					
					SAA102	SAD021	H3		
					SAA104				
								ESS529	J1
					SAA102				
					SAA102			ESS0112A	J1
					SAA102			ESS0112A	J1
					SAA102			ESS0112A	J1
					SAA102			ESS0112A	J1
					SAA102			ESS0112A	J1
					SAA102				
			SPA125	F1	SAA102	SAD019	H3	ESS0112A	J1
					SAA102			ESS0112A	J1
					SAA104				
			SPA121	F1	SAA102				
					SAA104				
					SAA102			ESS0112A	J1
					SAA102				
			SPA125	F1	SAA102	SAD019	H3	ESS0112A	J1
			SPA125	F1	SAA102	SAD019	H3	ESS0112A	J1
						SAD021	H3		



KW

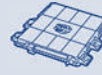

TYPE



TYPE

AUDI

90 (89, 89Q, 8A, B3)

2.3 E	Petrol	98	04/87 → 09/91					
2.3 E 20V	Petrol	123	04/90 → 07/91					
2.3 E 20V	Petrol	125	08/88 → 07/91					
2.3 E 20V quattro	Petrol	123	04/90 → 09/91					
2.3 E 20V quattro	Petrol	125	06/88 → 09/91					
2.3 E quattro	Petrol	100	04/87 → 07/91					
2.3 E quattro	Petrol	98	04/87 → 09/91					

A1 (8X1, 8XF)

1.2 TFSI	Petrol	63	05/10 →					
1.4 TFSI	Petrol	136	01/11 →					
1.4 TFSI	Petrol	90	05/10 →					
1.6 TDI	Diesel	66	03/11 →					
1.6 TDI	Diesel	77	05/10 →					
2.0 TDi	Diesel	105	09/11 →					
2.0 TDi	Diesel	100	05/12 →					
2.0 TFSI quattro	Petrol	188	03/12 →					

A1 Sportback (8XA, 8XK)

1.2 TFSI	Petrol	63	01/12 →					
1.4 TFSI	Petrol	136	11/11 →					
1.4 TFSI	Petrol	90	11/11 →					
1.6 TDI	Diesel	66	11/11 →					
1.6 TDI	Diesel	77	11/11 →					
2.0 TDi	Diesel	105	09/11 →					
2.0 TDi	Diesel	100	05/12 →					

A2 (8Z0)

1.2 TDI	Diesel	45	03/01 → 01/02					
1.2 TDI	Diesel	45	02/02 → 08/05					
1.2 TDI	Diesel	45	03/01 → 08/05					
1.2 TDI	Diesel	45	03/01 → 08/05					
1.4	Petrol	55	02/00 → 08/05					
1.4	Petrol	55	02/00 → 08/05					
1.4 TDI	Diesel	55	02/00 → 01/02					
1.4 TDI	Diesel	55	02/02 → 08/05					
1.4 TDI	Diesel	55	02/00 → 08/05					
1.4 TDI	Diesel	66	11/03 → 08/05					
1.4 TDI	Diesel	55	02/00 → 08/05					
1.4 TDI	Diesel	66	11/03 → 08/05					
1.6 FSI	Petrol	81	05/02 → 08/05					
1.6 FSI	Petrol	81	05/02 → 08/05					

A3 (8L1)

1.6	Petrol	75	08/00 → 05/03				AMM19670	B4
1.6	Petrol	75	08/00 → 05/03					
1.6	Petrol	75	08/00 → 05/03					
1.6	Petrol	75	08/00 → 05/03	CHASSIS: → 8LX090000				



TYPE

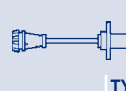

TYPE



TYPE

						SAD021	H3			
				SPA121	F1	SAA102			ESS0112A	J1
				SPA121	F1	SAA102			ESS0112A	J1
				SPA121	F1	SAA102				
				SPA121	F1	SAA102				
				SPA125	F1	SAA102	SAD021	H3		
				SPA125	F1	SAA102	SAD021	H3		
				SPA111	F1		SAC011	H2		
				SPA111	F1		SAC011	H2		
				SPA111	F1		SAC011	H2		
		SPS004		SPA111	F1					
		SPS004		SPA111	F1					
		SPS004		SPA111	F1	SAA105				
				SPA111	F1	SAA105				
				SPA111	F1				BAE680BB	
				SPA111	F1		SAC011	H2		
				SPA111	F1		SAC011	H2		
				SPA111	F1		SAC011	H2		
		SPS004		SPA111	F1					
		SPS004		SPA111	F1					
		SPS004		SPA111	F1					
				SPA111	F1	SAA105				
		APS39								
		APS40								
				SPA109	F1		SAD031	H3		
							SAG134	H1		
				SPA109	F1	SAA105	SAC014	H2	BAE680AA	ESS0016A J1
							SAD031	H3		
		APS39								
		APS40								
				SPA109	F1		SAD031	H3		
				SPA109	F1		SAD031	H3		
							SAG134	H1		
							SAG134	H1		
				SPA109	F1	SAA105	SAC011	H2	BAE680AU	ESS0016A J1
							SAD031	H3		
				SPA109	F1		SAC015	H2		ESS0016A J1
							SAC015-1	H2		
							SAD031	H3		
							SAG018	H1		



KW



TYPE



TYPE

AUDI

A3 (8L1)

1.8 T	Petrol	132	05/00 → 05/03						
1.8 T	Petrol	132	12/98 → 05/03						
1.8 T	Petrol	132	12/98 → 05/03	CHASSIS: 8LX035001 →					
1.8 T	Petrol	132	12/98 → 05/03						
1.8 T	Petrol	132	07/99 → 04/02	CHASSIS: → 8L21050000					
1.8 T quattro	Petrol	110	08/97 → 05/03						
1.8 T quattro	Petrol	132	09/00 → 05/03						
1.8 T quattro	Petrol	110	12/96 → 05/03	CHASSIS: 8LX035001 →					
1.8 T quattro	Petrol	132	10/98 → 05/03						
1.8 T quattro	Petrol	132	10/98 → 05/03	CHASSIS: 8LX035001 →					
1.8 T quattro	Petrol	110	12/96 → 05/03						
1.8 T quattro	Petrol	110	12/96 → 05/03						
1.8 T quattro	Petrol	110	12/96 → 05/03	CHASSIS: → 8LX090000					
1.8 T quattro	Petrol	132	10/98 → 05/03						
1.8 T quattro	Petrol	132	10/98 → 05/03						
1.9 TDI	Diesel	96	08/00 → 05/03				AMM19752		B4
1.9 TDI	Diesel	74	10/00 → 05/03						
1.9 TDI	Diesel	74	11/01 → 05/03						
1.9 TDI quattro	Diesel	96	08/00 → 05/03				AMM19752		B4
S3 quattro	Petrol	154	03/99 → 02/01						
S3 quattro	Petrol	154	03/99 → 04/02						
S3 quattro	Petrol	154	03/99 → 04/02	CHASSIS: 8LX035001 →					
S3 quattro	Petrol	165	10/01 → 05/03						
S3 quattro	Petrol	165	10/01 → 05/03						
S3 quattro	Petrol	154	03/99 → 04/02						
S3 quattro	Petrol	154	03/99 → 04/02						

A3 (8P1)

1.2 TSI	Petrol	77	04/10 → 08/12						
1.2 TSI	Petrol	77	04/10 → 08/12						
1.4 TFSI	Petrol	92	09/07 → 08/12						
1.4 TFSI	Petrol	92	09/07 → 08/12						
1.6	Petrol	75	05/03 → 08/12						
1.6	Petrol	75	05/03 → 08/12						
1.6 FSI	Petrol	85	08/03 → 09/07						
1.6 FSI	Petrol	85	08/03 → 09/07						
1.6 FSI	Petrol	85	08/03 → 09/07						
1.6 FSI	Petrol	85	08/03 → 09/07						
1.6 TDI	Diesel	66	05/09 → 08/12						
1.6 TDI	Diesel	77	05/09 → 08/12						
1.8 TFSI	Petrol	118	11/06 → 08/12						
1.8 TFSI quattro	Petrol	118	07/08 → 08/12						
1.9 TDI	Diesel	77	05/03 → 05/10						
1.9 TDI	Diesel	77	05/03 → 05/10						
2.0	Petrol	120	06/06 → 08/12				AMM19752		B4
2.0 FSI	Petrol	110	05/03 → 06/08						

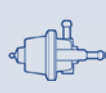

TYPE

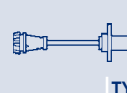

TYPE



TYPE

	APS39									
		ATS19	F2		SAC084	H2		ESS0016A	J1	
		SPA109	F1							
					SAD031	H3		GA2138	J2	
					SAG018	H1				
	APS39	ATS19	F2							
	APS39									
		SPA109	F1							
		ATS19	F2		SAC084	H2				
		SPA109	F1							
					SAC084	H2		ESS0016A	J1	
					SAD031	H3				
					SAG018	H1				
					SAD031	H3				
					SAG018	H1				
		SPA109	F1		SAG015	H2				
	APS39	SPA109	F1		SAG015	H2				
	APS40									
		SPA109	F1		SAG015	H2				
	APS39									
		ATS19	F2		SAC084	H2				
		SPA109	F1							
		SPA109	F1		SAC084	H2	BAE680AW			
		ATS19	F2		SAD031	H3				
					SAD031	H3				
					SAG018	H1				
					SAC011	H2				
					SAG155	H1				
	APS70	SPA111	F1	SAA105	SAC011	H2				
					SAG155	H1				
	APS70	SPA111	F1		SAC075	H2				
					SAD031	H3				
	APS70	ATS13	F2	SAA105	SAC011	H2	BAE680AU	ESS0045A	J1	
		SPA111	F1		SAD031	H3		GA2226	J2	
					SAG166	H1				
		SPA111	F1		SAG155	H1				
		SPA111	F1		SAG155	H1				
	APS70	SPA111	F1				BAE680BB			
		SPA111	F1				BAE680BB			
	APS40	SPA111	F1		SAC073	H2		ESS0073A	J1	
					SAG166	H1				
	APS70	ATS13	F2		SAC073	H2	BAE680BB			



KW

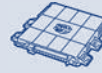

TYPE



TYPE

AUDI

A3 (8P1)

2.0 FSI	Petrol	110	05/03 → 06/08						
2.0 FSI	Petrol	110	05/03 → 06/08						
2.0 TDi	Diesel	100	05/03 → 08/12				AMM19752	B4	
2.0 TDi	Diesel	103	06/05 → 06/08				AMM19752	B4	
2.0 TDi	Diesel	125	03/06 → 08/12				AMM19752	B4	
2.0 TDi	Diesel	100	05/03 → 08/12						
2.0 TDi	Diesel	120	06/06 → 06/08						
2.0 TDi	Diesel	125	03/06 → 08/12						
2.0 TDI 16V	Diesel	103	05/03 → 08/12				AMM19752	B4	
2.0 TDI 16V	Diesel	103	05/03 → 08/12						
2.0 TDI 16V	Diesel	103	01/05 → 08/12						
2.0 TDI 16V quattro	Diesel	103	08/04 → 08/12				AMM19752	B4	
2.0 TDI 16V quattro	Diesel	103	08/04 → 08/12						
2.0 TDI quattro	Diesel	100	05/03 → 06/08				AMM19752	B4	
2.0 TDI quattro	Diesel	103	01/06 → 06/08				AMM19752	B4	
2.0 TDI quattro	Diesel	125	03/06 → 08/12				AMM19752	B4	
2.0 TDI quattro	Diesel	125	03/06 → 08/12						
2.0 TDI quattro	Diesel	100	05/03 → 06/08						
2.0 TFSI	Petrol	147	09/04 → 08/12						
2.0 TFSI quattro	Petrol	147	09/04 → 08/12						
3.2 V6 quattro	Petrol	184	07/03 → 05/09						
3.2 V6 quattro	Petrol	184	07/03 → 05/09						
3.2 V6 quattro	Petrol	184	07/03 → 05/09						
S3 quattro	Petrol	188	02/07 → 08/12						
S3 quattro	Petrol	195	11/06 → 08/12						

A3 (8V1)

1.4 TFSI	Petrol	90	04/12 →						
1.8 TFSI	Petrol	132	04/12 →						

A3 Cabriolet (8P7)

1.2 TFSI	Petrol	77	03/10 → 05/13						
1.2 TFSI	Petrol	77	03/10 → 05/13						
1.4 TFSI	Petrol	92	02/11 → 05/13						
1.6	Petrol	75	09/08 → 05/10						
1.6 TDI	Diesel	77	05/09 → 05/13						
1.8 TFSI	Petrol	118	04/08 → 05/13						
1.9 TDI	Diesel	77	04/08 → 10/09						
2.0 TDi	Diesel	100	04/08 → 05/13						
2.0 TDi	Diesel	103	04/08 → 05/13						
2.0 TDi	Diesel	103	04/08 → 05/13						
2.0 TFSI	Petrol	147	04/08 → 05/13						

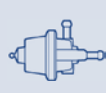

TYPE

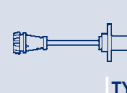

TYPE



TYPE

				SPA111	F1		SAD031	H3		
							SAG100	H1		
		SPS004		SPA111	F1		SAC073	H2		ESS0073A J1
				SPA111	F1		SAG166	H1		ESS0073A J1
				SPA111	F1		SAC085	H2		ESS0073A J1
							SAG166	H1		
				SPA111	F1					
							SAG166	H1		
		SPS004		ATS16	F2		SAC073	H2		ESS0073A J1
				SPA111	F1		SAG166	H1		
		APS40								
		SPS004		SPA111	F1		SAC073	H2		ESS0073A J1
							SAG166	H1		
							SAC085	H2		ESS0073A J1
				SPA111	F1		SAG166	H1		ESS0073A J1
				SPA111	F1		SAC085	H2		ESS0073A J1
							SAG166	H1		
							SAG166	H1		
		APS70		SPA111	F1		SAC073	H2	BAE680BB	
		APS70		SPA111	F1				BAE680BB	
		APS70		SPA111	F1		SAC011	H2	BAE680BC	
							SAD031	H3		
							SAG065	H1		
				SPA111	F1				BAE680BB	
				SPA111	F1				BAE680BB	
							SAA105			
				SPA111	F1					
							SAC011	H2		
							SAG155	H1		
				SPA111	F1		SAC011	H2		
				SPA111	F1					
				SPA111	F1		SAG155	H1		
				SPA111	F1				BAE680BB	
				SPA111	F1		SAG166	H1		ESS0073A J1
				SPA111	F1					
				ATS16	F2		SAG155	H1		ESS0170A J1
				SPA111	F1					
				SPA111	F1				BAE680BB	



KW

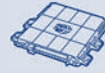

TYPE



TYPE

AUDI

A3 Sportback (8PA)

1.2 TSI	Petrol	77	04/10 → 03/13					
1.2 TSI	Petrol	77	04/10 → 03/13					
1.4 TFSI	Petrol	92	09/07 → 03/13					
1.4 TFSI	Petrol	92	09/07 → 03/13					
1.6	Petrol	75	09/04 → 03/13					
1.6	Petrol	75	09/04 → 03/13					
1.6 FSI	Petrol	85	09/04 → 09/07					
1.6 FSI	Petrol	85	09/04 → 09/07					
1.6 FSI	Petrol	85	09/04 → 09/07					
1.6 TDI	Diesel	66	05/09 → 03/13					
1.6 TDI	Diesel	77	05/09 → 03/13					
1.8 TFSI	Petrol	118	11/06 → 03/13					
1.8 TFSI quattro	Petrol	118	07/08 → 03/13					
1.9 TDI	Diesel	77	09/04 → 05/10					
2.0	Petrol	120	06/06 → 03/13				AMM19752	B4
2.0 FSI	Petrol	110	09/04 → 06/08					
2.0 FSI	Petrol	110	09/04 → 06/08					
2.0 TDi	Diesel	100	09/04 → 03/13				AMM19752	B4
2.0 TDi	Diesel	103	06/05 → 06/08				AMM19752	B4
2.0 TDi	Diesel	125	03/06 → 03/13				AMM19752	B4
2.0 TDi	Diesel	120	06/06 → 06/08					
2.0 TDi	Diesel	125	03/06 → 03/13					
2.0 TDi 16V	Diesel	103	09/04 → 03/13				AMM19752	B4
2.0 TDi 16V	Diesel	103	09/04 → 03/13					
2.0 TDi 16V	Diesel	103	02/05 → 03/13					
2.0 TDi 16V quattro	Diesel	103	11/05 → 03/13					
2.0 TDi 16V quattro	Diesel	103	11/05 → 03/13					
2.0 TDi quattro	Diesel	103	01/06 → 06/08				AMM19752	B4
2.0 TDi quattro	Diesel	125	03/06 → 03/13				AMM19752	B4
2.0 TDi quattro	Diesel	125	03/06 → 03/13					
2.0 TFSI	Petrol	147	09/04 → 03/13					
2.0 TFSI quattro	Petrol	147	09/04 → 03/13					
3.2 V6 quattro	Petrol	184	09/04 → 05/09					
3.2 V6 quattro	Petrol	184	09/04 → 05/09					
3.2 V6 quattro	Petrol	184	09/04 → 05/09					
RS3 quattro	Petrol	250	01/11 → 12/12					
S3 quattro	Petrol	188	07/08 → 03/13					
S3 quattro	Petrol	195	06/08 → 03/13					
S3 quattro	Petrol	195	07/08 → 03/13					

A4 (8D2, B5)

1.6	Petrol	74	01/98 → 12/98				AMM19670	B4
1.6	Petrol	74	07/96 → 12/97				AMM19666	B4
1.6	Petrol	74	12/94 → 10/96				AMM19672	B4
1.6	Petrol	74	11/94 → 06/00					



TYPE

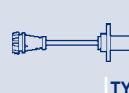

TYPE



TYPE

						SAC011	H2			
						SAG155	H1			
	APS70	SPA111	F1	SAA105		SAC011	H2			
						SAG155	H1			
	APS70	SPA111	F1			SAC075	H2			
						SAD031	H3			
	APS70	ATS13	F2	SAA105		SAC011	H2	BAE680AU		
		SPA111	F1			SAD031	H3			
						SAG166	H1			
		SPA111	F1			SAG155	H1			
		SPA111	F1			SAG155	H1			
	APS70	SPA111	F1					BAE680BB		
		SPA111	F1					BAE680BB		
	APS40	SPA111	F1			SAG166	H1		ESS0073A	J1
	APS70	ATS13	F2			SAD031	H3	BAE680BB		
		SPA111	F1			SAG100	H1			
		SPA111	F1							
		SPA111	F1			SAG166	H1		ESS0073A	J1
		ATS16	F2			SAC085	H2		ESS0073A	J1
		SPA111	F1							
		SPA111	F1			SAG166	H1			
	SPS004	ATS16	F2			SAC085	H2		ESS0073A	J1
		SPA111	F1			SAG166	H1			
	APS40									
	APS40	ATS16	F2			SAC085	H2		ESS0073A	J1
	SPS004	SPA111	F1			SAG166	H1			
		SPA111	F1			SAG166	H1		ESS0073A	J1
		ATS16	F2			SAC085	H2		ESS0073A	J1
		SPA111	F1			SAG166	H1			
	APS70	SPA111	F1					BAE680BB		
	APS70	SPA111	F1					BAE680BB		
	APS70	SPA111	F1			SAC011	H2			
						SAD031	H3			
						SAG065	H1			
		SPA111	F1					BAE680BB		
		SPA111	F1					BAE680BB		
		SPA111	F1					BAE680BB		



KW



TYPE



TYPE

AUDI

A4 (8D2, B5)

1.6	Petrol	75	07/00 → 10/00					
1.6	Petrol	74	11/94 → 10/00	CHASSIS: 8DY000001 →				
1.6	Petrol	74	11/94 → 07/99					
1.6	Petrol	74	11/94 → 12/98					
1.6	Petrol	75	07/00 → 11/00	CHASSIS: 8DY000001 →				
1.6	Petrol	74	11/94 → 10/00					
1.6	Petrol	74	11/94 → 10/00					
1.6	Petrol	74	11/94 → 10/00					
1.6	Petrol	74	11/94 → 10/00					
1.6	Petrol	74	11/94 → 07/97					
1.6	Petrol	74	01/97 → 10/00					
1.6	Petrol	75	07/00 → 11/00					
1.6	Petrol	74	12/94 → 10/00	ENGINE: ADP-AHL-ANA-ARM				
1.6	Petrol	75	07/00 → 11/00	ENGINE: ALZ				
1.8	Petrol	85	07/97 → 12/98			AMM19666	B4	
1.8	Petrol	92	01/95 → 06/97			AMM19672	B4	
1.8	Petrol	92	07/96 → 04/99			AMM19666	B4	
1.8	Petrol	92	01/95 → 10/00					
1.8	Petrol	85	04/95 → 11/00	CHASSIS: 8DY000001 →				
1.8	Petrol	85	04/95 → 06/00					
1.8	Petrol	92	01/95 → 11/00	CHASSIS: 8DY000001 →				
1.8	Petrol	92	01/95 → 12/98					
1.8	Petrol	95	07/99 → 11/00	CHASSIS: 8DY000001 →				
1.8	Petrol	85	04/95 → 11/00					
1.8	Petrol	92	01/95 → 11/00					
1.8	Petrol	92	01/95 → 11/00					
1.8	Petrol	92	01/95 → 11/00					
1.8	Petrol	92	01/95 → 11/00					
1.8	Petrol	92	01/95 → 07/97					
1.8	Petrol	85	04/95 → 11/00	ENGINE: AFY				
1.8	Petrol	92	01/95 → 11/00	ENGINE: ADR-APT-ARG-AVV				
1.8	Petrol	95	01/95 → 11/00	ENGINE: ADR-APT-ARG-AVV				
1.8 quattro	Petrol	85	07/95 → 06/97			AMM19672	B4	
1.8 quattro	Petrol	92	01/95 → 06/97			AMM19672	B4	
1.8 quattro	Petrol	92	07/96 → 04/99			AMM19666	B4	
1.8 quattro	Petrol	92	01/95 → 10/00					
1.8 quattro	Petrol	85	07/95 → 11/00					
1.8 quattro	Petrol	85	07/95 → 11/00	CHASSIS: 8DY000001 →				
1.8 quattro	Petrol	92	01/95 → 11/00	CHASSIS: 8DY000001 →				
1.8 quattro	Petrol	92	01/95 → 06/00					
1.8 quattro	Petrol	92	01/95 → 12/98					
1.8 quattro	Petrol	92	01/95 → 11/00					
1.8 quattro	Petrol	92	01/95 → 11/00					
1.8 quattro	Petrol	92	01/95 → 11/00					

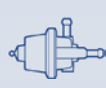

TYPE

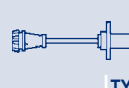
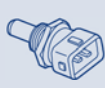

TYPE



TYPE

			RP02A								
				SPA109	F1						
				ATS19	F2						
				SPA106	F1						
				SPA109	F1						
							SAC015	H2	BAE680AA	ESS0071A	J1
							SAC015-1	H2			
							SAD019	H3			
							SAG127	H1			
							SAG026	H1			
							SAG018	H1			
							SAG017	H1		ESS0071A	J1
										ESS515	J1
										ESS515	J1
			RP02A	ATS19	F2				BAE680AQ		
				SPA109	F1						
				ATS19	F2				BAE680AQ		
				SPA109	F1						
				SPA106	F1						
				SPA109	F1						
							SAG127	H1			
							SAC084	H2		ESS0071A	J1
							SAD019	H3			
							SAD021	H3			
							SAG127	H1			
							SAG026	H1			
										ESS515	J1
										ESS515	J1
										ESS515	J1
			RP02A						BAE680AQ		
				ATS19	F2		SAG127	H1	BAE680AQ		
				SPA109	F1						
				SPA109	F1						
				ATS19	F2						
				SPA106	F1						
							SAC084	H2			
							SAD019	H3			
							SAD021	H3			



KW



TYPE



TYPE

AUDI

A4 (8D2, B5)

1.8 quattro	Petrol	92	01/95 → 11/00					
1.8 quattro	Petrol	92	01/95 → 07/97					
1.8 quattro	Petrol	85	07/95 → 11/00	ENGINE: AFY				
1.8 T	Petrol	110	08/98 → 11/00					
1.8 T	Petrol	132	12/97 → 12/98					
1.8 T	Petrol	110	01/95 → 11/00	CHASSIS: 8DY000001 →				
1.8 T	Petrol	110	01/95 → 10/00					
1.8 T	Petrol	110	01/95 → 12/98					
1.8 T	Petrol	132	12/97 → 11/00	CHASSIS: 8DY000001 →				
1.8 T	Petrol	110	01/95 → 11/00					
1.8 T	Petrol	110	01/95 → 11/00					
1.8 T	Petrol	110	01/95 → 11/00					
1.8 T	Petrol	110	10/95 → 11/00					
1.8 T	Petrol	132	12/97 → 11/00					
1.8 T	Petrol	132	12/97 → 11/00					
1.8 T	Petrol	132	12/97 → 11/00					
1.8 T	Petrol	132	12/97 → 11/00					
1.8 T	Petrol	110	01/95 → 11/00	ENGINE: AEB-ANB-APU-ARK-AWT				
1.8 T	Petrol	132	12/97 → 11/00	ENGINE: AJL				
1.8 T quattro	Petrol	110	02/99 → 11/00					
1.8 T quattro	Petrol	132	12/97 → 10/00					
1.8 T quattro	Petrol	110	01/95 → 11/00	CHASSIS: 8DY000001 →				
1.8 T quattro	Petrol	110	01/95 → 10/00					
1.8 T quattro	Petrol	132	12/97 → 11/00	CHASSIS: 8DY000001 →				
1.8 T quattro	Petrol	110	01/95 → 11/00					
1.8 T quattro	Petrol	110	01/95 → 11/00					
1.8 T quattro	Petrol	110	01/95 → 11/00					
1.8 T quattro	Petrol	110	01/95 → 11/00					
1.8 T quattro	Petrol	132	12/97 → 11/00					
1.8 T quattro	Petrol	132	12/97 → 11/00					
1.8 T quattro	Petrol	132	12/97 → 11/00					
1.8 T quattro	Petrol	132	12/97 → 11/00					
1.8 T quattro	Petrol	110	01/95 → 11/00	ENGINE: AEB-ANB-APU-ARK-AWT				
1.8 T quattro	Petrol	132	12/97 → 11/00	ENGINE: AJL				
1.9 TDI	Diesel	55	08/97 → 06/00					
1.9 TDI	Diesel	66	04/97 → 07/98					
1.9 TDI	Diesel	81	08/97 → 06/00					
1.9 TDI	Diesel	85	03/00 → 11/00					
1.9 TDI	Diesel	55	12/95 → 11/00	CHASSIS: 8DY000001 →				
1.9 TDI	Diesel	55	12/95 → 07/97					
1.9 TDI	Diesel	66	01/95 → 11/00	CHASSIS: 8DY000001 →				



TYPE

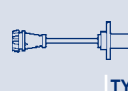

TYPE



TYPE

							SAG127	H1		
							SAG026	H1		
									ESS515	J1
	APS39									
		RP02A	ATS19	F2						
			SPA109	F1						
			ATS19	F2						
			SPA106	F1						
			SPA109	F1						
							SAC084	H2	ESS0071A	J1
							SAD019	H3		
							SAD021	H3		
							SAG127	H1		
							SAG017	H1		
							SAC084	H2	ESS0071A	J1
							SAD019	H3		
							SAD021	H3		
							SAG127	H1		
									ESS515	J1
									ESS515	J1
	APS39									
		RP02A	ATS19	F2						
			SPA109	F1						
			ATS19	F2						
			SPA109	F1						
							SAC084	H2		
							SAD019	H3		
							SAD021	H3		
							SAG127	H1		
							SAC084	H2		
							SAD019	H3		
							SAD021	H3		
							SAG127	H1		
									ESS515	J1
									ESS515	J1
	APS39									
	APS39									
	APS39									
	APS39									
			SPA109	F1						
			ATS18	F2						
			SPA109	F1						



KW

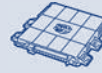

TYPE



TYPE

AUDI

A4 (8D2, B5)

1.9 TDI	Diesel	66	01/95 → 07/97					
1.9 TDI	Diesel	66	01/95 → 12/98					
1.9 TDI	Diesel	81	10/95 → 11/00	CHASSIS: 8DY000001 →				
1.9 TDI	Diesel	81	10/95 → 07/97					
1.9 TDI	Diesel	81	10/95 → 12/98					
1.9 TDI	Diesel	85	03/00 → 11/00	CHASSIS: 8DY000001 →				
1.9 TDI	Diesel	55	12/95 → 11/00					
1.9 TDI	Diesel	66	01/95 → 11/00					
1.9 TDI	Diesel	66	01/95 → 07/96					
1.9 TDI	Diesel	81	10/95 → 11/00					
1.9 TDI quattro	Diesel	85	03/00 → 11/00					
1.9 TDI quattro	Diesel	85	03/00 → 11/00	CHASSIS: 8DY000001 →				
2.4	Petrol	120	08/97 → 11/00			AMM19671	B4	
2.4	Petrol	121	03/97 → 07/97			AMM19667	B4	
2.4	Petrol	121	08/98 → 11/00			AMM19671	B4	
2.4	Petrol	120	08/97 → 10/00					
2.4	Petrol	120	08/97 → 11/00	CHASSIS: 8DY000001 →				
2.4	Petrol	121	03/97 → 11/00	CHASSIS: 8DY000001 →				
2.4	Petrol	121	08/97 → 11/00					
2.4	Petrol	110	07/95 → 09/96	CHASSIS: → 8DV054232				
2.4	Petrol	120	08/97 → 11/00					
2.4	Petrol	120	08/97 → 06/00					
2.4	Petrol	121	03/97 → 11/00					
2.4	Petrol	121	03/97 → 11/00					
2.4	Petrol	121	03/97 → 11/00					
2.4	Petrol	121	03/97 → 11/00					
2.4	Petrol	121	03/97 → 11/00	ENGINE: AGA-ALF-AML-APS-ARJ				
2.4 quattro	Petrol	120	08/97 → 11/00			AMM19671	B4	
2.4 quattro	Petrol	121	03/97 → 07/97			AMM19667	B4	
2.4 quattro	Petrol	121	08/98 → 11/00			AMM19671	B4	
2.4 quattro	Petrol	120	02/99 → 06/00					
2.4 quattro	Petrol	120	08/97 → 11/00	CHASSIS: 8DY000001 →				
2.4 quattro	Petrol	121	03/97 → 11/00	CHASSIS: 8DY000001 →				
2.4 quattro	Petrol	121	08/97 → 11/00					
2.4 quattro	Petrol	120	08/97 → 11/00					
2.4 quattro	Petrol	120	08/97 → 11/00					
2.4 quattro	Petrol	121	03/97 → 11/00					
2.4 quattro	Petrol	121	03/97 → 11/00					
2.4 quattro	Petrol	121	03/97 → 11/00					
2.4 quattro	Petrol	121	01/99 → 11/00					
2.4 quattro	Petrol	120	08/97 → 11/00	ENGINE: AGA-ALF-AML-APS-ARJ				
2.5 TDI	Diesel	110	09/97 → 11/00					
2.5 TDI	Diesel	110	09/97 → 11/00	CHASSIS: 8DW240001 →				

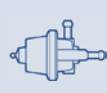

TYPE

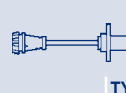

TYPE



TYPE

			ATS18	F2						
			SPA106	F1						
			SPA109	F1						
			ATS18	F2		SAG026	H1			
			SPA106	F1						
			SPA109	F1						
						SAG142	H1	ESS0080A	J1	
						SAG142	H1			
						SAG026	H1			
						SAG142	H1			
	APS39									
			SPA109	F1						
						SAD021	H3	ESS0071A	J1	
		RP02A	ATS19	F2						
			SPA109	F1						
			SPA109	F1						
			ATS19	F2						
					SAA104					
						SAG018	H1			
						SAC084	H2			
						SAC084	H2	ESS0071A	J1	
						SAD021	H3			
						SAG018	H1			
								ESS515	J1	
						SAC084	H2			
		RP02A	ATS19	F2						
			SPA109	F1						
			SPA109	F1						
			ATS19	F2						
						SAD021	H3			
						SAG018	H1			
						SAC084	H2			
						SAD021	H3			
						SAG096	H1			
						SAG018	H1			
								ESS515	J1	
	APS39		SGA115	F3		SAG017	H1			
			SPA109	F1						



KW



TYPE



TYPE

AUDI

A4 (8D2, B5)

2.5 TDI quattro	Diesel	110	09/97 → 11/00					
2.5 TDI quattro	Diesel	110	09/97 → 11/00	CHASSIS: 8DW240001 →				
2.6	Petrol	110	01/95 → 12/97				B3391	B1
2.6	Petrol	110	01/95 → 07/98					
2.6	Petrol	110	01/95 → 11/00	CHASSIS: → 8DT300000				
2.6	Petrol	102	01/96 → 09/96	CHASSIS: → 8DV054232				
2.6	Petrol	110	01/95 → 11/00	CHASSIS: → 8DV054232				
2.6	Petrol	110	01/95 → 11/00					
2.6	Petrol	110	01/95 → 11/00	ENGINE: ABC				
2.6 quattro	Petrol	110	01/95 → 12/97				B3391	B1
2.6 quattro	Petrol	110	01/95 → 07/98					
2.6 quattro	Petrol	110	01/95 → 11/00	CHASSIS: → 8DT400000				
2.6 quattro	Petrol	110	01/95 → 11/00	CHASSIS: → 8DV054232				
2.6 quattro	Petrol	110	01/95 → 11/00					
2.6 quattro	Petrol	110	01/95 → 11/00	ENGINE: ABC				
2.8	Petrol	128	09/95 → 07/97				AMM19669	B4
2.8	Petrol	142	10/96 → 11/00				AMM19669	B4
2.8	Petrol	142	04/97 → 12/98				AMM19667	B4
2.8	Petrol	142	07/98 → 11/00				AMM19671	B4
2.8	Petrol	142	10/96 → 06/00					
2.8	Petrol	128	09/95 → 07/97	CHASSIS: → 8DT300000				
2.8	Petrol	142	10/96 → 11/00	CHASSIS: 8DY000001 →				
2.8	Petrol	128	09/95 → 07/97	CHASSIS: → 8DV054232				
2.8	Petrol	142	10/96 → 11/00	CHASSIS: → 8DV054232				
2.8	Petrol	142	10/96 → 07/99					
2.8	Petrol	142	10/96 → 11/00					
2.8	Petrol	142	01/99 → 11/00					
2.8	Petrol	142	01/99 → 07/99	CHASSIS: 8DX200001 →				
2.8	Petrol	128	09/95 → 07/97	ENGINE: AAH				
2.8	Petrol	142	10/96 → 11/00	ENGINE: ACK-ALG-AMX-APR-AQD				
2.8 quattro	Petrol	128	01/95 → 07/97				AMM19669	B4
2.8 quattro	Petrol	142	10/96 → 11/00				AMM19669	B4
2.8 quattro	Petrol	142	04/97 → 12/98				AMM19667	B4
2.8 quattro	Petrol	142	07/98 → 11/00				AMM19671	B4
2.8 quattro	Petrol	128	01/95 → 07/97	CHASSIS: → 8DT400000				
2.8 quattro	Petrol	142	10/96 → 08/01	CHASSIS: 8DY000001 →				
2.8 quattro	Petrol	142	10/96 → 06/00					
2.8 quattro	Petrol	128	01/95 → 07/97	CHASSIS: → 8DV054232				
2.8 quattro	Petrol	142	10/96 → 08/01	CHASSIS: → 8DV054232				
2.8 quattro	Petrol	142	10/96 → 08/01					
2.8 quattro	Petrol	142	10/96 → 08/01					
2.8 quattro	Petrol	142	10/96 → 08/01					
2.8 quattro	Petrol	142	01/99 → 08/01					



TYPE

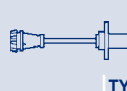

TYPE



TYPE

	APS39		SGA115	F3		SAG017	H1		
			SPA109	F1					
		RP02A							
			SPA144	F1					
						SAA104			
						SAA104			
						SAD021	H3	ESS0071A	J1
								ESS515	J1
		RP02A							
			SPA144	F1					
						SAA104			
						SAD021	H3		
								ESS515	J1
		RP02A				SAD021	H3	ESS0071A	J1
						SAD021	H3	ESS0071A	J1
		RP02A	ATS19	F2		SAC084	H2		
			SPA144	F1					
			SPA109	F1					
						SAA104			
						SAA104			
						SAA104			
						SAG096	H1		
						SAG018	H1		
						SAG018	H1		
								ESS515	J1
								ESS515	J1
		RP02A				SAD021	H3		
			SPA144	F1					
			SPA109	F1					
			ATS19	F2					
						SAA104			
						SAA104			
						SAC084	H2		
						SAD021	H3		
						SAG096	H1		
						SAG018	H1		



KW



TYPE



TYPE

AUDI

A4 (8D2, B5)

2.8 quattro	Petrol	128	01/95 → 07/97	ENGINE: AAH				
2.8 quattro	Petrol	142	10/96 → 08/01	ENGINE: ACK-ALG-AMX-APR-AQD				
S4 quattro	Petrol	195	10/97 → 10/00					
S4 quattro	Petrol	195	09/97 → 09/01					
S4 quattro	Petrol	195	09/97 → 09/01	CHASSIS: 8DY000001 →				
S4 quattro	Petrol	195	09/97 → 09/01	CHASSIS: → 8DV054232				
S4 quattro	Petrol	195	09/97 → 09/01					
S4 quattro	Petrol	195	09/97 → 09/01					
S4 quattro	Petrol	195	09/97 → 09/01	ENGINE: AGB				

A4 (8E2, B6)

1.6	Petrol	75	11/00 → 12/04					
1.6	Petrol	75	11/00 → 12/04					
1.8 T	Petrol	125	07/01 → 12/04					
1.8 T	Petrol	110	11/00 → 07/02					
1.8 T	Petrol	110	11/00 → 04/01					
1.8 T	Petrol	120	07/02 → 12/04					
1.8 T	Petrol	120	07/02 → 12/04					
1.8 T	Petrol	140	11/02 → 12/04					
1.8 T	Petrol	140	11/02 → 12/04					
1.8 T	Petrol	110	11/00 → 07/02					
1.8 T quattro	Petrol	110	11/00 → 07/02					
1.8 T quattro	Petrol	110	11/00 → 04/01					
1.8 T quattro	Petrol	120	07/02 → 12/04					
1.8 T quattro	Petrol	120	07/02 → 12/04					
1.8 T quattro	Petrol	140	11/02 → 12/04					
1.8 T quattro	Petrol	140	11/02 → 12/04					
1.8 T quattro	Petrol	110	11/00 → 07/02					
1.9 TDI	Diesel	85	06/04 → 12/04			AMM19752		B4
1.9 TDI	Diesel	96	11/00 → 12/04			AMM19752		B4
1.9 TDI	Diesel	74	05/01 → 05/04					
1.9 TDI	Diesel	74	05/01 → 12/04					
1.9 TDI quattro	Diesel	96	11/01 → 12/04			AMM19752		B4
2.0	Petrol	96	11/00 → 12/04					
2.0	Petrol	96	11/00 → 12/04					
2.0 FSI	Petrol	110	07/02 → 12/04					
2.0 FSI	Petrol	110	07/02 → 12/04					
2.0 TDi	Diesel	93	10/05 → 10/07			AMM19752		B4
2.4	Petrol	125	09/01 → 12/04			AMM19671		B4
2.4	Petrol	120	09/01 → 12/04					
2.4	Petrol	125	09/01 → 12/04					
2.5 TDI	Diesel	114	08/01 → 07/02			AMM19769		B4
2.5 TDI	Diesel	120	07/02 → 12/04			AMM19769		B4
2.5 TDI	Diesel	114	08/01 → 07/02					

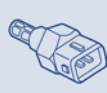
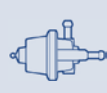

TYPE

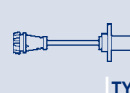

TYPE



TYPE

								ESS515	J1
								ESS515	J1
		RP02A							
			ATS19	F2		SAC084	H2	ESS0071A	J1
			SPA109	F1					
					SAA104				
						SAD021	H3		
						SAG018	H1		
								ESS515	J1
		RP02A	SPA109	F1		SAC075	H2	ESS0071A	J1
						SAG017	H1		
		RP02A							
			SPA109	F1		SAC084	H2	BAE680AW	
			ATS19	F2					
			ATS19	F2		SAC084	H2		
			SPA109	F1		SAG017	H1		
			ATS19	F2		SAC084	H2		
			SPA109	F1		SAG017	H1		
						SAG017	H1		
			SPA109	F1		SAC084	H2		
			ATS19	F2					
			ATS19	F2		SAC084	H2	BAE680AW	
			SPA109	F1		SAG017	H1		
			ATS19	F2		SAC084	H2		
			SPA109	F1		SAG017	H1		
						SAG017	H1		
	APS40		SPA109	F1					
			SPA109	F1				ESS0080A	J1
	APS40								
			SPA109	F1					
			SPA109	F1					
		RP02A	SPA109	F1		SAC084	H2	BAE680AW	
						SAG017	H1		
			SPA109	F1		SAC073	H2		
						SAG033	H1		
			SPA109	F1		SAC084	H2		
			SPA109	F1					
						SAG096	H1		
	APS40		SGA115	F3		SAG017	H1		
	APS40		SGA115	F3		SAG017	H1		
			SPA109	F1					



KW

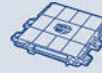

TYPE



TYPE

AUDI

A4 (8E2, B6)

2.5 TDI	Diesel	120	07/02 → 12/04						
2.5 TDI quattro	Diesel	132	11/00 → 12/04				AMM19769	B4	
2.5 TDI quattro	Diesel	132	11/00 → 12/04						
3.0	Petrol	160	04/01 → 12/04				AMM19674	B4	
3.0	Petrol	162	11/00 → 12/04				AMM19674	B4	
3.0	Petrol	160	04/01 → 12/04						
3.0	Petrol	162	12/00 → 12/04						
3.0	Petrol	162	11/00 → 12/04						
3.0 quattro	Petrol	160	04/01 → 12/04						
3.0 quattro	Petrol	162	11/00 → 12/04						
3.0 quattro	Petrol	160	04/01 → 12/04						
3.0 quattro	Petrol	162	11/00 → 12/04						
3.0 quattro	Petrol	160	06/01 → 12/04						
S4 quattro	Petrol	253	03/03 → 12/04						

A4 (8EC, B7)

1.6	Petrol	75	11/04 → 06/08						
1.6	Petrol	75	11/04 → 06/08						
1.8 T	Petrol	120	11/04 → 06/08						
1.8 T	Petrol	120	11/04 → 06/08						
1.8 T quattro	Petrol	120	11/04 → 06/08						
1.8 T quattro	Petrol	120	11/04 → 06/08						
1.9 TDI	Diesel	85	11/04 → 06/08				AMM19752	B4	
1.9 TDI	Diesel	85	11/04 → 11/05						
2.0	Petrol	96	11/04 → 06/08						
2.0	Petrol	96	11/04 → 06/08						
2.0 TDi	Diesel	100	11/04 → 06/08				AMM19752	B4	
2.0 TDi	Diesel	103	11/04 → 06/08				AMM19752	B4	
2.0 TDi	Diesel	120	06/06 → 06/08				AMM19752	B4	
2.0 TDi	Diesel	125	06/06 → 06/08				AMM19752	B4	
2.0 TDi	Diesel	89	09/05 → 09/06				AMM19752	B4	
2.0 TDi	Diesel	93	11/05 → 11/06				AMM19752	B4	
2.0 TDi	Diesel	100	11/04 → 06/08						
2.0 TDi	Diesel	125	06/06 → 06/08						
2.0 TDI 16V	Diesel	103	11/04 → 06/08				AMM19752	B4	
2.0 TDI 16V	Diesel	103	11/04 → 06/08						
2.0 TDI quattro	Diesel	103	01/06 → 06/08				AMM19752	B4	
2.0 TDI quattro	Diesel	120	06/06 → 06/08				AMM19752	B4	
2.0 TDI quattro	Diesel	125	06/06 → 06/08				AMM19752	B4	
2.0 TDI quattro	Diesel	103	06/06 → 06/08						
2.0 TDI quattro	Diesel	125	06/06 → 06/08						
2.0 TFSI	Petrol	125	10/06 → 06/08						
2.0 TFSI	Petrol	125	03/07 → 06/08						
2.0 TFSI	Petrol	147	11/04 → 06/08						
2.0 TFSI	Petrol	162	06/05 → 06/08						



TYPE

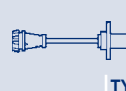

TYPE



TYPE

			SPA109	F1						
	APS40		SGA115	F3		SAG017	H1			
			SPA109	F1						
		RP02A	SPA109	F1		SAC073	H2			
			SPA109	F1		SAC073	H2	BAE680AC		
						SAG018	H1			
		RP02A				SAG018	H1			
		RP02A	SPA109	F1		SAC073	H2			
		RP02A	SPA109	F1		SAC073	H2			
						SAG096	H1			
						SAG018	H1			
						SAG018	H1			
		RP02A	SPA109	F1		SAC073	H2			
		RP02A	SPA109	F1		SAC075	H2		ESS0071A	J1
						SAG017	H1			
			SPA109	F1		SAC084	H2			
						SAG017	H1			
			SPA109	F1		SAC084	H2			
						SAG017	H1			
			SPA109	F1					ESS0080A	J1
	APS40									
		RP02A	SPA109	F1		SAC084	H2			
						SAG017	H1			
			SPA111	F1		SAC085	H2		ESS0080A	J1
			SPA111	F1						
			SPA111	F1						
			SPA111	F1		SAC085	H2			
			SPA111	F1						
			SPA111	F1						
						SAG166	H1			
						SAG166	H1			
			SPA111	F1		SAC085	H2			
						SAG166	H1			
			SPA111	F1						
			SPA109	F1						
			SPA109	F1		SAC085	H2			
			SPA109	F1						
						SAG166	H1			
			SPA111	F1		SAD031	H3			
			SPA109	F1				BAE680BB		
			SPA109	F1		SAC073	H2	BAE680BB		
			SPA109	F1		SAC073	H2	BAE680BB		



KW



TYPE



TYPE

AUDI

A4 (8EC, B7)

2.0 TFSI	Petrol	147	11/04 → 06/08
2.0 TFSI quattro	Petrol	147	11/04 → 06/08
2.0 TFSI quattro	Petrol	147	11/04 → 10/07
2.0 TFSI quattro	Petrol	162	06/05 → 06/08
2.0 TFSI quattro	Petrol	147	11/04 → 06/08
2.0 TFSI quattro	Petrol	162	06/05 → 06/08
2.5 TDI	Diesel	120	11/04 → 04/06
2.5 TDI	Diesel	120	11/04 → 05/06
2.7 TDI	Diesel	120	11/05 → 06/08
2.7 TDI	Diesel	132	01/06 → 06/08
3.0	Petrol	160	11/04 → 05/06
3.0 quattro	Petrol	160	11/04 → 07/06
3.0 TDI quattro	Diesel	150	11/04 → 06/08
3.0 TDI quattro	Diesel	171	01/06 → 06/08
3.2 FSI	Petrol	188	01/05 → 06/08
3.2 FSI quattro	Petrol	188	01/05 → 06/08
RS4 quattro	Petrol	309	09/05 → 06/08
S4 quattro	Petrol	253	11/04 → 06/08

A4 (8K2, B8)

1.8 TFSI	Petrol	118	11/07 →
1.8 TFSI	Petrol	125	11/11 →
1.8 TFSI	Petrol	88	01/08 →
1.8 TFSI	Petrol	118	11/07 → 03/12
1.8 TFSI quattro	Petrol	118	09/08 →
1.8 TFSI quattro	Petrol	125	11/11 →
1.8 TFSI quattro	Petrol	118	09/08 → 03/12
2.0 TDi	Diesel	100	11/07 →
2.0 TDi	Diesel	105	11/07 →
2.0 TDi	Diesel	120	08/08 →
2.0 TDi	Diesel	130	11/11 →
2.0 TDi	Diesel	88	06/08 →
2.0 TDi	Diesel	125	01/08 →
2.0 TDi	Diesel	120	08/08 → 02/10
2.0 TDI quattro	Diesel	105	11/08 →
2.0 TDI quattro	Diesel	130	11/11 →
2.0 TDI quattro	Diesel	125	08/08 →
2.0 TDI quattro	Diesel	125	01/08 →
2.0 TFSI	Petrol	132	06/08 →
2.0 TFSI	Petrol	155	06/08 →
2.0 TFSI flexible fuel	Petrol/Ethanol	132	01/10 →
2.0 TFSI flexible fuel	Petrol/Ethanol	132	11/09 →
2.0 TFSI flexible fuel quattro	Petrol/Ethanol	132	01/10 →
2.0 TFSI flexible fuel quattro	Petrol/Ethanol	132	11/09 →
2.0 TFSI quattro	Petrol	155	06/08 →



TYPE

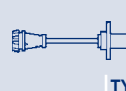

TYPE



TYPE

						SAD031	H3			
					SPA109	F1	SAC073	H2	BAE680BB	
					SPA111	F1				
					SPA109	F1	SAC073	H2	BAE680BB	
							SAD031	H3		
							SAD031	H3		
		APS40								
					SPA109	F1	SAG017	H1		ESS0080A
					SPA111	F1				J1
					SPA111	F1	SAG090	H1		
					SPA109	F1	SAG018	H1		
					SPA109	F1	SAG018	H1		
					SPA109	F1	SAG090	H1		
					SPA109	F1	SAG090	H1		
					SPA111	F1			BAE680AV	
					SPA109	F1				
					SPA111	F1			BAE680BB	
					SPA109	F1				
					SPA111	F1				
					SPA111	F1			GA2157	J2
					SPA111	F1			BAE680CO	
					SPA111	F1			BAE680BB	GA2157
									BAE680BB	J2
					SPA111	F1			GA2157	J2
					SPA111	F1			BAE680CO	
									BAE680BB	
		SPS004			SPA111	F1	SAG155	H1	GA2214	J2
		SPS004			SPA111	F1	SAG155	H1	GA2214	J2
		SPS004			SPA111	F1	SAG155	H1	GA2214	J2
		SPS004			SPA111	F1				
		SPS004			SPA111	F1	SAG155	H1	GA2214	J2
					SPA111	F1	SAG155	H1	GA2214	J2
									BAE680BB	
		SPS004			SPA111	F1	SAG155	H1	GA2214	J2
		SPS004			SPA111	F1				
					SPA111	F1				
							SAG155	H1	GA2214	J2
					SPA111	F1			BAE680BB	GA2157
					SPA111	F1			BAE680BB	GA2157
					SPA111	F1				
									BAE680BB	
					SPA111	F1				
									BAE680BB	
					SPA111	F1			BAE680BB	GA2157



KW



TYPE



TYPE

AUDI

A4 (8K2, B8)

2.7 TDI	Diesel	120	11/07 →						
2.7 TDI	Diesel	140	11/07 →						
3.0 TDI	Diesel	150	11/11 →						
3.0 TDI quattro	Diesel	180	11/11 →						
3.0 TDI quattro	Diesel	155	06/08 →						
3.0 TDI quattro	Diesel	176	11/07 →						
3.0 TFSI quattro	Petrol	200	02/12 →						
3.2 FSI	Petrol	195	09/08 →						
3.2 FSI quattro	Petrol	195	11/07 →						
S4 quattro	Petrol	245	03/09 →						
S4 quattro	Petrol	245	11/08 →						

A4 Allroad (8KH, B8)

2.0 TDI quattro	Diesel	100	09/09 →						
2.0 TDI quattro	Diesel	105	09/09 →						
2.0 TDI quattro	Diesel	120	04/09 →						
2.0 TDI quattro	Diesel	130	11/11 →						
2.0 TDI quattro	Diesel	125	04/09 →						
2.0 TFSI quattro	Petrol	155	04/09 →						
3.0 TDI quattro	Diesel	176	04/09 →						
3.0 TDI quattro	Diesel	180	01/12 →						

A4 Avant (8D5, B5)

1.6	Petrol	74	01/98 → 12/98					AMM19670	B4
1.6	Petrol	74	07/96 → 12/97					AMM19666	B4
1.6	Petrol	74	02/96 → 10/96					AMM19672	B4
1.6	Petrol	74	11/94 → 09/01						
1.6	Petrol	75	07/00 → 09/01						
1.6	Petrol	74	11/94 → 09/01	CHASSIS: 8DY000001 →					
1.6	Petrol	74	11/94 → 07/99						
1.6	Petrol	74	11/94 → 12/98						
1.6	Petrol	75	07/00 → 09/01	CHASSIS: 8DY000001 →					
1.6	Petrol	74	11/94 → 09/01						
1.6	Petrol	74	11/94 → 09/01						
1.6	Petrol	74	11/94 → 09/01						
1.6	Petrol	74	11/94 → 07/97						
1.6	Petrol	74	01/97 → 09/01						
1.6	Petrol	74	02/96 → 09/01	ENGINE: ADP-AHL-ANA-ARM					
1.6	Petrol	75	07/00 → 09/01	ENGINE: ALZ					
1.8	Petrol	85	07/96 → 12/98					AMM19666	B4
1.8	Petrol	92	02/96 → 06/97					AMM19672	B4
1.8	Petrol	92	07/96 → 12/98					AMM19666	B4
1.8	Petrol	85	07/95 → 09/01	CHASSIS: 8DY000001 →					
1.8	Petrol	85	07/95 → 12/98						
1.8	Petrol	92	02/96 → 09/01						
1.8	Petrol	92	02/96 → 09/01	CHASSIS: 8DY000001 →					

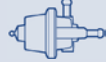

TYPE



TYPE



TYPE

SPA111

F1

GA2214

J2

SPA111

F1

SPA111

F1

SPA111

F1

GA2214

J2

GA2214

J2

SPA111

F1

SPA111

F1

GA2157

J2

SPA111

F1

GA2157

J2

SPA111

F1

GA2157

J2

SPS004

SPA111

F1

GA2157

J2

SPS004

SPA111

F1

SAG155

H1

GA2157

J2

SPS004

SPA111

F1

GA2157

J2

SPS004

SPA111

F1

GA2157

J2

SPA111

F1

SAG155

H1

GA2214

J2

SPA111

F1

BAE680BB

GA2154

J2

SPA111

F1

GA2214

J2

SPA111

F1

GA2157

J2

RP02A

SAC015

H2

ESS0071A

J1

RP02A

SAG017

H1

ESS0071A

J1

SPA109

F1

ATS19

F2

SPA106

F1

SPA109

F1

SAC015-1

H2

SAD019

H3

SAG127

H1

SAG026

H1

SAG018

H1

ESS515

J1

ESS515

J1

SPA109

F1

ATS19

F2

BAE680AQ

ATS19

F2

SAD019

H3

BAE680AQ

ESS0071A

J1

SPA109

F1



KW

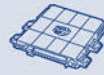

TYPE



TYPE

AUDI

A4 Avant (8D5, B5)

1.8	Petrol	92	02/96 → 12/98					
1.8	Petrol	85	07/95 → 09/01					
1.8	Petrol	92	02/96 → 09/01					
1.8	Petrol	92	02/96 → 09/01					
1.8	Petrol	92	02/96 → 07/97					
1.8	Petrol	92	02/96 → 07/99					
1.8	Petrol	85	07/95 → 09/01	ENGINE: AFY				
1.8	Petrol	92	02/96 → 09/01	ENGINE: ADR-APT-ARG-AVV				
1.8 quattro	Petrol	85	07/95 → 09/01			AMM19672	B4	
1.8 quattro	Petrol	85	07/96 → 04/99			AMM19666	B4	
1.8 quattro	Petrol	92	01/96 → 09/01			AMM19672	B4	
1.8 quattro	Petrol	92	07/96 → 04/99			AMM19666	B4	
1.8 quattro	Petrol	92	01/96 → 09/01					
1.8 quattro	Petrol	85	07/95 → 09/01	CHASSIS: 8DY000001 →				
1.8 quattro	Petrol	85	07/95 → 12/98					
1.8 quattro	Petrol	92	01/96 → 09/01					
1.8 quattro	Petrol	92	01/96 → 09/01	CHASSIS: 8DY000001 →				
1.8 quattro	Petrol	92	01/96 → 12/98					
1.8 quattro	Petrol	92	01/96 → 09/01					
1.8 quattro	Petrol	92	01/96 → 07/97					
1.8 quattro	Petrol	85	07/95 → 09/01	ENGINE: AFY				
1.8 quattro	Petrol	92	01/96 → 09/01	ENGINE: ADR-APT-ARG				
1.8 T	Petrol	110	08/98 → 09/01					
1.8 T	Petrol	110	03/96 → 09/01					
1.8 T	Petrol	132	12/97 → 09/01					
1.8 T	Petrol	110	03/96 → 09/01					
1.8 T	Petrol	110	03/96 → 09/01	CHASSIS: 8DY000001 →				
1.8 T	Petrol	110	03/96 → 12/98					
1.8 T	Petrol	132	12/97 → 09/01					
1.8 T	Petrol	132	12/97 → 09/01	CHASSIS: 8DY000001 →				
1.8 T	Petrol	110	03/96 → 09/01					
1.8 T	Petrol	110	03/96 → 09/01					
1.8 T	Petrol	132	12/97 → 09/01					
1.8 T	Petrol	132	12/97 → 09/01					
1.8 T	Petrol	132	12/97 → 09/01	ENGINE: AEB-ANB-APU				
1.8 T quattro	Petrol	110	02/99 → 09/01					
1.8 T quattro	Petrol	132	12/97 → 09/01					
1.8 T quattro	Petrol	110	01/96 → 09/01					
1.8 T quattro	Petrol	110	01/96 → 09/01	CHASSIS: 8DY000001 →				
1.8 T quattro	Petrol	110	01/96 → 12/98					
1.8 T quattro	Petrol	132	12/97 → 09/01					
1.8 T quattro	Petrol	132	12/97 → 09/01	CHASSIS: 8DY000001 →				
1.8 T quattro	Petrol	110	01/96 → 09/01					
1.8 T quattro	Petrol	110	01/96 → 09/01					

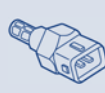

TYPE

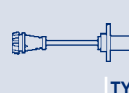

TYPE



TYPE

			SPA106	F1						
						SAG127	H1			
						SAD021	H3			
						SAG127	H1			
						SAG026	H1			
						SAC084	H2			
									ESS515	J1
									ESS515	J1
			ATS19	F2		SAG127	H1	BAE680AQ		
		RP02A	ATS19	F2		SAC084	H2	BAE680AQ		
						SAD019	H3			
			SPA109	F1						
			SPA106	F1						
						SAD021	H3			
			SPA109	F1						
			SPA106	F1						
						SAG127	H1			
						SAG026	H1			
									ESS515	J1
									ESS515	J1
	APS39									
		RP02A	ATS19	F2		SAC084	H2		ESS0071A	J1
		RP02A				SAC084	H2		ESS0071A	J1
						SAD019	H3			
			SPA109	F1						
			SPA106	F1						
			ATS19	F2		SAD019	H3			
			SPA109	F1						
						SAD021	H3			
						SAG017	H1			
						SAD021	H3			
						SAG127	H1			
									ESS515	J1
	APS39									
		RP02A	ATS19	F2		SAC084	H2			
			ATS19	F2		SAC084	H2			
			SPA109	F1						
			SPA106	F1						
						SAD019	H3			
			SPA109	F1						
						SAD021	H3			
						SAG127	H1			



KW



TYPE



TYPE

AUDI

A4 Avant (8D5, B5)

1.8 T quattro	Petrol	132	12/97 → 09/01					
1.8 T quattro	Petrol	132	12/97 → 09/01					
1.8 T quattro	Petrol	110	01/96 → 09/01	ENGINE: AEB-ANB-APU-ARK-AWT				
1.9 DUO	Diesel	66	07/99 → 09/01	CHASSIS: 8DY000001 →				
1.9 TDI	Diesel	55	08/97 → 09/01					
1.9 TDI	Diesel	66	08/97 → 12/98					
1.9 TDI	Diesel	81	08/97 → 06/00					
1.9 TDI	Diesel	85	03/00 → 09/01					
1.9 TDI	Diesel	55	03/96 → 09/01	CHASSIS: 8DY000001 →				
1.9 TDI	Diesel	66	02/96 → 09/01	CHASSIS: 8DY000001 →				
1.9 TDI	Diesel	66	02/96 → 12/98					
1.9 TDI	Diesel	81	02/96 → 09/01	CHASSIS: 8DY000001 →				
1.9 TDI	Diesel	81	02/96 → 12/98					
1.9 TDI	Diesel	85	03/00 → 09/01	CHASSIS: 8DY000001 →				
1.9 TDI	Diesel	55	03/96 → 09/01					
1.9 TDI	Diesel	66	02/96 → 09/01					
1.9 TDI	Diesel	66	02/96 → 07/96					
1.9 TDI	Diesel	81	02/96 → 09/01					
1.9 TDI	Diesel	81	02/96 → 07/97					
1.9 TDI quattro	Diesel	85	03/00 → 09/01					
1.9 TDI quattro	Diesel	85	03/00 → 09/01	CHASSIS: 8DY000001 →				
2.4	Petrol	120	08/97 → 07/98			AMM19667	B4	
2.4	Petrol	120	07/98 → 09/01			AMM19671	B4	
2.4	Petrol	121	08/97 → 07/98			AMM19667	B4	
2.4	Petrol	121	08/98 → 09/01			AMM19671	B4	
2.4	Petrol	120	08/98 → 09/01					
2.4	Petrol	121	08/97 → 09/01					
2.4	Petrol	120	08/97 → 09/01	CHASSIS: 8DY000001 →				
2.4	Petrol	121	03/97 → 09/01	CHASSIS: 8DY000001 →				
2.4	Petrol	120	08/97 → 09/01					
2.4	Petrol	120	08/97 → 09/01					
2.4	Petrol	120	08/98 → 06/00					
2.4	Petrol	121	03/97 → 09/01					
2.4	Petrol	121	03/97 → 09/01					
2.4	Petrol	121	01/99 → 09/01					
2.4	Petrol	120	08/97 → 09/01	ENGINE: AJG				
2.4	Petrol	121	03/97 → 09/01	ENGINE: AGA-ALF-AML-APS-ARJ				
2.4 quattro	Petrol	120	08/98 → 09/01			AMM19671	B4	
2.4 quattro	Petrol	121	08/97 → 07/98			AMM19667	B4	
2.4 quattro	Petrol	121	08/98 → 09/01			AMM19671	B4	
2.4 quattro	Petrol	120	08/98 → 06/00					



TYPE

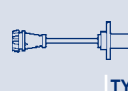

TYPE



TYPE

						SAD021	H3			
						SAG127	H1			
									ESS515	J1
				SPA109	F1					
	APS39									
	APS39									
	APS39									
	APS39									
				SPA109	F1					
				SPA109	F1					
				SPA106	F1					
				SPA109	F1					
				SPA106	F1					
				SPA109	F1					
						SAG142	H1			
						SAG142	H1			
						SAG026	H1			
						SAG142	H1			
						SAG026	H1			
	APS39									
				SPA109	F1					
		RP02A	ATS19	F2						
		RP02A	ATS19	F2						
			SPA109	F1						
			SPA109	F1						
						SAD021	H3		ESS0071A	J1
						SAG018	H1			
						SAC084	H2			
						SAC084	H2		ESS0071A	J1
						SAD021	H3			
						SAG096	H1			
						SAG018	H1			
									ESS515	J1
									ESS515	J1
		RP02A	ATS19	F2						



KW



TYPE



TYPE

AUDI

A4 Avant (8D5, B5)

2.4 quattro	Petrol	121	08/97 → 09/01					
2.4 quattro	Petrol	120	08/97 → 09/01	CHASSIS: 8DY000001 →				
2.4 quattro	Petrol	121	03/97 → 09/01	CHASSIS: 8DY000001 →				
2.4 quattro	Petrol	120	08/97 → 09/01					
2.4 quattro	Petrol	120	08/97 → 09/01					
2.4 quattro	Petrol	120	08/97 → 09/01					
2.4 quattro	Petrol	121	03/97 → 09/01					
2.4 quattro	Petrol	121	03/97 → 09/01					
2.4 quattro	Petrol	121	03/97 → 09/01					
2.4 quattro	Petrol	121	01/99 → 09/01					
2.4 quattro	Petrol	121	03/97 → 09/01	ENGINE: AGA-ALF-AML-APS-ARJ				
2.5 TDI	Diesel	110	09/97 → 09/01					
2.5 TDI	Diesel	110	09/97 → 09/01	CHASSIS: 8DW240001 →				
2.5 TDI quattro	Diesel	110	09/97 → 06/00					
2.5 TDI quattro	Diesel	110	09/97 → 09/01					
2.5 TDI quattro	Diesel	110	09/97 → 09/01	CHASSIS: 8DW240001 →				
2.6	Petrol	110	02/96 → 12/97				B3391	B1
2.6	Petrol	110	02/96 → 07/98					
2.6	Petrol	110	02/96 → 09/01	CHASSIS: → 8DT300000				
2.6	Petrol	110	02/96 → 09/01	CHASSIS: → 8DV054232				
2.6	Petrol	110	02/96 → 09/01					
2.6	Petrol	110	02/96 → 09/01	ENGINE: ABC				
2.6 quattro	Petrol	110	01/96 → 12/97				B3391	B1
2.6 quattro	Petrol	110	01/96 → 07/98					
2.6 quattro	Petrol	110	01/96 → 09/01	CHASSIS: → 8DT400000				
2.6 quattro	Petrol	110	01/96 → 09/01	CHASSIS: → 8DV054232				
2.6 quattro	Petrol	110	01/96 → 09/01					
2.6 quattro	Petrol	110	01/96 → 09/01	ENGINE: ABC				
2.8	Petrol	128	03/96 → 09/96				AMM19669	B4
2.8	Petrol	142	10/96 → 09/01				AMM19669	B4
2.8	Petrol	142	04/97 → 12/98				AMM19667	B4
2.8	Petrol	142	07/98 → 09/01				AMM19671	B4
2.8	Petrol	128	03/96 → 09/96	CHASSIS: → 8DT300000				
2.8	Petrol	142	10/96 → 09/01	CHASSIS: 8DY000001 →				
2.8	Petrol	142	10/96 → 07/99					
2.8	Petrol	128	03/96 → 09/96	CHASSIS: → 8DV054232				
2.8	Petrol	142	10/96 → 09/01	CHASSIS: → 8DV054232				
2.8	Petrol	142	10/96 → 09/01					
2.8	Petrol	142	10/96 → 09/01					
2.8	Petrol	142	01/99 → 09/01					
2.8	Petrol	128	03/96 → 09/96	ENGINE: AAH				
2.8	Petrol	142	10/96 → 09/01	ENGINE: ACK-ALG-AMX-APR-AQD				

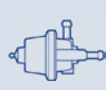

TYPE

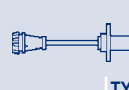

TYPE



TYPE

			RP02A	ATS19	F2					
				SPA109	F1					
				SPA109	F1					
							SAC084	H2		ESS0071A
							SAD021	H3		
							SAG018	H1		
							SAC084	H2		
							SAD021	H3		
							SAG096	H1		
							SAG018	H1		
										ESS515
										J1
	APS39			SGA115	F3		SAG017	H1		
				SPA109	F1					
	APS39									
				SGA115	F3		SAG017	H1		
				SPA109	F1					
			RP02A							
				SPA144	F1					
							SAA104			
							SAD021	H3		ESS0071A
										ESS515
										J1
			RP02A							
				SPA144	F1					
							SAA104			
							SAD021	H3		
										ESS515
										J1
							SAC084	H2		ESS0071A
										J1
				SPA144	F1					
				SPA109	F1					
				ATS19	F2					
							SAA104			
							SAA104			
							SAD021	H3		
							SAG096	H1		
							SAG018	H1		
										ESS515
										J1
										ESS515
										J1



KW

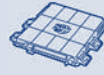

TYPE



TYPE

AUDI

A4 Avant (8D5, B5)

2.8 quattro	Petrol	128	01/96 → 09/96				AMM19669	B4
2.8 quattro	Petrol	142	10/96 → 09/01				AMM19669	B4
2.8 quattro	Petrol	142	04/97 → 12/98				AMM19667	B4
2.8 quattro	Petrol	142	07/98 → 09/01				AMM19671	B4
2.8 quattro	Petrol	142	10/96 → 09/01					
2.8 quattro	Petrol	128	01/96 → 09/96	CHASSIS: → 8DT400000				
2.8 quattro	Petrol	142	10/96 → 09/01					
2.8 quattro	Petrol	142	10/96 → 09/01	CHASSIS: 8DY000001 →				
2.8 quattro	Petrol	128	01/96 → 09/96	CHASSIS: → 8DV054232				
2.8 quattro	Petrol	142	10/96 → 09/01	CHASSIS: → 8DV054232				
2.8 quattro	Petrol	142	01/99 → 09/01					
2.8 quattro	Petrol	128	01/96 → 09/96	ENGINE: AAH				
2.8 quattro	Petrol	142	10/96 → 09/01	ENGINE: ACK-ALG-AMX-APR-AQD				
RS4 quattro	Petrol	280	05/00 → 09/01					
RS4 quattro	Petrol	280	05/00 → 09/01					
RS4 quattro	Petrol	280	05/00 → 09/01	CHASSIS: → 8DV054232				
S4 quattro	Petrol	195	10/97 → 09/01					
S4 quattro	Petrol	195	09/97 → 09/01	CHASSIS: 8DY000001 →				
S4 quattro	Petrol	195	09/97 → 09/01	CHASSIS: → 8DV054232				
S4 quattro	Petrol	195	09/97 → 09/01					
S4 quattro	Petrol	195	09/97 → 09/01					
S4 quattro	Petrol	195	09/97 → 09/00					

A4 Avant (8E5, B6)

1.6	Petrol	75	09/01 → 12/04					
1.6	Petrol	75	09/01 → 12/04					
1.8 T	Petrol	110	09/01 → 07/02					
1.8 T	Petrol	120	07/02 → 12/04					
1.8 T	Petrol	120	07/02 → 12/04					
1.8 T	Petrol	140	11/02 → 12/04					
1.8 T	Petrol	140	11/02 → 12/04					
1.8 T	Petrol	110	09/01 → 07/02					
1.8 T quattro	Petrol	110	09/01 → 07/02					
1.8 T quattro	Petrol	120	07/02 → 12/04					
1.8 T quattro	Petrol	120	07/02 → 12/04					
1.8 T quattro	Petrol	140	11/02 → 12/04					
1.8 T quattro	Petrol	140	11/02 → 12/04					
1.8 T quattro	Petrol	110	09/01 → 07/02					
1.9 TDI	Diesel	85	06/04 → 12/04				AMM19752	B4
1.9 TDI	Diesel	96	09/01 → 12/04				AMM19752	B4
1.9 TDI	Diesel	74	11/01 → 05/04					
1.9 TDI	Diesel	74	11/01 → 12/04					
1.9 TDI quattro	Diesel	96	11/01 → 12/04				AMM19752	B4
2.0	Petrol	96	09/01 → 12/04					

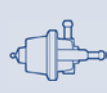

TYPE

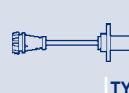

TYPE



TYPE

			RP02A	ATS19	F2		SAC084	H2		
							SAD021	H3		
				SPA144	F1		SAG096	H1		
				SPA109	F1					
						SAA104				
						SAA104				
							SAG018	H1		
									ESS515	J1
									ESS515	J1
	APS39		RP02A	ATS19	F2		SAC084	H2		
				SPA109	F1		SAG018	H1		
						SAA104				
			RP02A							
				SPA109	F1					
						SAA104				
							SAC084	H2		ESS0071A
							SAD021	H3		
							SAG018	H1		
			RP02A	SPA109	F1		SAC075	H2		ESS0071A
							SAG017	H1		
				SPA109	F1		SAC084	H2		
				ATS19	F2		SAC084	H2		
				SPA109	F1		SAG017	H1		
				ATS19	F2		SAC084	H2		
				SPA109	F1		SAG017	H1		
							SAG017	H1		
				SPA109	F1		SAC084	H2		
				ATS19	F2		SAC084	H2		
				SPA109	F1		SAG017	H1		
				ATS19	F2		SAC084	H2		
				SPA109	F1		SAG017	H1		
							SAG017	H1		
	APS40			SPA109	F1					
				SPA109	F1					
	APS40									
				SPA109	F1					
				SPA109	F1					
			RP02A	SPA109	F1		SAC084	H2		



KW



TYPE



TYPE

AUDI

A4 Avant (8E5, B6)

2.0	Petrol	96	09/01 → 12/04						
2.0 FSI	Petrol	110	07/02 → 12/04						
2.0 FSI	Petrol	110	07/02 → 12/04						
2.4	Petrol	125	09/01 → 12/04				AMM19671	B4	
2.4	Petrol	125	09/01 → 12/04						
2.4	Petrol	120	09/01 → 12/04						
2.5 TDI	Diesel	114	09/01 → 07/02				AMM19769	B4	
2.5 TDI	Diesel	120	07/02 → 12/04				AMM19769	B4	
2.5 TDI	Diesel	114	09/01 → 07/02						
2.5 TDI	Diesel	120	07/02 → 12/04						
2.5 TDI quattro	Diesel	132	09/01 → 12/04				AMM19769	B4	
2.5 TDI quattro	Diesel	132	09/01 → 12/04						
3.0	Petrol	160	04/01 → 12/04				AMM19674	B4	
3.0	Petrol	162	09/01 → 12/04				AMM19674	B4	
3.0	Petrol	160	09/01 → 12/04						
3.0	Petrol	162	09/01 → 12/04						
3.0	Petrol	160	04/01 → 12/04						
3.0	Petrol	160	06/01 → 12/04						
3.0 quattro	Petrol	160	04/01 → 12/04				AMM19674	B4	
3.0 quattro	Petrol	162	09/01 → 12/04				AMM19674	B4	
3.0 quattro	Petrol	160	09/01 → 12/04						
3.0 quattro	Petrol	162	09/01 → 12/04						
3.0 quattro	Petrol	160	04/01 → 12/04						
3.0 quattro	Petrol	160	06/01 → 12/04						
S4 quattro	Petrol	253	03/03 → 12/04						

A4 Avant (8ED, B7)

1.6	Petrol	75	11/04 → 06/08						
1.6	Petrol	75	11/04 → 06/08						
1.8 T	Petrol	120	11/04 → 06/08						
1.8 T	Petrol	120	11/04 → 06/08						
1.8 T quattro	Petrol	120	11/04 → 06/08						
1.8 T quattro	Petrol	120	11/04 → 06/08						
1.9 TDI	Diesel	85	11/04 → 06/08				AMM19752	B4	
1.9 TDI	Diesel	85	11/04 → 11/05						
2.0	Petrol	96	11/04 → 06/08						
2.0	Petrol	96	11/04 → 06/08						
2.0 TDi	Diesel	100	11/04 → 06/08				AMM19752	B4	
2.0 TDi	Diesel	103	11/04 → 06/08				AMM19752	B4	
2.0 TDi	Diesel	120	06/06 → 06/08				AMM19752	B4	
2.0 TDi	Diesel	125	06/06 → 06/08				AMM19752	B4	
2.0 TDi	Diesel	89	09/05 → 09/06				AMM19752	B4	
2.0 TDi	Diesel	93	11/05 → 11/06				AMM19752	B4	
2.0 TDi	Diesel	100	11/04 → 06/08						
2.0 TDi	Diesel	125	06/06 → 06/08						

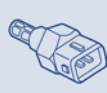
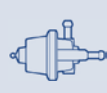

TYPE

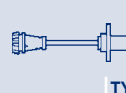

TYPE



TYPE

						SAG017	H1		
			SPA109	F1		SAC073	H2		
						SAG033	H1		
		RP02A	SPA109	F1		SAC084	H2		
						SAG096	H1		
			SPA109	F1					
	APS40		SGA115	F3		SAG017	H1		
	APS40		SGA115	F3		SAG017	H1		
			SPA109	F1					
			SPA109	F1					
	APS40		SGA115	F3		SAG017	H1		
			SPA109	F1					
			SPA109	F1		SAC073	H2		
		RP02A	SPA109	F1		SAC073	H2		
		RP02A							
						SAG018	H1		
						SAG096	H1		
						SAG018	H1		
			SPA109	F1		SAC073	H2		
		RP02A	SPA109	F1		SAC073	H2		
		RP02A							
						SAG018	H1		
						SAG096	H1		
						SAG018	H1		
		RP02A	SPA109	F1					
		RP02A	SPA109	F1		SAC075	H2	ESS0071A	J1
						SAG017	H1		
			SPA109	F1		SAC084	H2		
						SAG017	H1		
			SPA109	F1		SAC084	H2		
						SAG017	H1		
			SPA109	F1					
	APS40								
		RP02A	SPA109	F1		SAC084	H2		
						SAG017	H1		
			SPA111	F1		SAC085	H2		
			SPA111	F1					
			SPA111	F1					
			SPA111	F1		SAC085	H2		
			SPA111	F1					
			SPA111	F1					
						SAG166	H1		
						SAG166	H1		



KW



TYPE



TYPE

AUDI

A4 Avant (8ED, B7)

2.0 TDI 16V	Diesel	103	11/04 → 06/08				AMM19752	B4
2.0 TDI 16V	Diesel	103	11/04 → 06/08					
2.0 TDI quattro	Diesel	103	01/06 → 06/08				AMM19752	B4
2.0 TDI quattro	Diesel	120	06/06 → 06/08				AMM19752	B4
2.0 TDI quattro	Diesel	125	06/06 → 06/08				AMM19752	B4
2.0 TDI quattro	Diesel	103	06/06 → 06/08					
2.0 TDI quattro	Diesel	125	06/06 → 06/08					
2.0 TFSI	Petrol	125	10/06 → 06/08					
2.0 TFSI	Petrol	125	03/07 → 06/08					
2.0 TFSI	Petrol	147	11/04 → 06/08					
2.0 TFSI	Petrol	162	02/06 → 06/08					
2.0 TFSI	Petrol	147	11/04 → 06/08					
2.0 TFSI	Petrol	162	06/05 → 06/08					
2.0 TFSI quattro	Petrol	147	11/04 → 06/08					
2.0 TFSI quattro	Petrol	147	11/04 → 03/08					
2.0 TFSI quattro	Petrol	162	02/06 → 06/08					
2.0 TFSI quattro	Petrol	147	11/04 → 06/08					
2.0 TFSI quattro	Petrol	162	06/05 → 06/08					
2.5 TDI	Diesel	120	11/04 → 05/06					
2.7 TDI	Diesel	120	11/05 → 03/08					
2.7 TDI	Diesel	132	01/06 → 06/08					
3.0	Petrol	160	11/04 → 05/06					
3.0 quattro	Petrol	160	11/04 → 07/06					
3.0 TDI quattro	Diesel	150	11/04 → 06/08					
3.0 TDI quattro	Diesel	171	01/06 → 06/08					
3.2 FSI	Petrol	188	01/05 → 06/08					
3.2 FSI quattro	Petrol	188	01/05 → 06/08					
RS4 quattro	Petrol	309	09/05 → 06/08					
S4 quattro	Petrol	253	11/04 → 06/08					

A4 Avant (8K5, B8)

1.8 TFSI	Petrol	118	11/07 →					
1.8 TFSI	Petrol	125	11/11 →					
1.8 TFSI	Petrol	88	04/08 →					
1.8 TFSI quattro	Petrol	118	09/08 →					
1.8 TFSI quattro	Petrol	125	11/11 →					
2.0 TDi	Diesel	100	04/08 →					
2.0 TDi	Diesel	105	04/08 →					
2.0 TDi	Diesel	120	08/08 →					
2.0 TDi	Diesel	130	11/11 →					
2.0 TDi	Diesel	88	06/08 →					
2.0 TDi	Diesel	125	04/08 →					
2.0 TDI quattro	Diesel	105	04/08 →					
2.0 TDI quattro	Diesel	130	11/11 →					
2.0 TDI quattro	Diesel	105	11/08 →					



TYPE



TYPE



TYPE

				SPA111	F1		SAC085	H2		
							SAG166	H1		
				SPA111	F1					
				SPA109	F1					
				SPA109	F1		SAC085	H2		
				SPA109	F1					
							SAG166	H1		
				SPA111	F1		SAD031	H3		
				SPA109	F1				BAE680BB	
				SPA109	F1		SAC073	H2	BAE680BB	
				SPA109	F1					
							SAD031	H3		
							SAD031	H3	BAE680BB	
				SPA109	F1		SAC073	H2	BAE680BB	
				SPA111	F1					
				SPA109	F1					
							SAD031	H3		
							SAD031	H3	BAE680BB	
	APS40			SPA109	F1		SAG017	H1		
				SPA111	F1		SAG090	H1		
				SPA111	F1		SAG090	H1		
				SPA109	F1		SAG018	H1		
				SPA109	F1		SAG018	H1		
				SPA109	F1		SAG090	H1		
				SPA109	F1		SAG090	H1		
				SPA111	F1					
				SPA109	F1					
				SPA111	F1				BAE680BB	
				SPA109	F1					
				SPA111	F1				BAE680BB	GA2157
				SPA111	F1				BAE680CO	
				SPA111	F1				BAE680BB	GA2157
				SPA111	F1				BAE680BB	GA2157
				SPA111	F1				BAE680CO	
	SPS004			SPA111	F1		SAG155	H1		GA2214
	SPS004			SPA111	F1		SAG155	H1		GA2214
	SPS004			SPA111	F1		SAG155	H1		GA2214
	SPS004			SPA111	F1					
	SPS004			SPA111	F1		SAG155	H1		GA2214
				SPA111	F1		SAG155	H1		GA2214
	SPS004						SAG155	H1		GA2214
	SPS004			SPA111	F1					
				SPA111	F1					



KW



TYPE



TYPE

AUDI

A4 Avant (8K5, B8)

2.0 TDI quattro	Diesel	125	08/08 →						
2.0 TFSI	Petrol	132	06/08 →						
2.0 TFSI	Petrol	155	06/08 →						
2.0 TFSI flexible fuel	Petrol/Ethanol	132	11/09 →						
2.0 TFSI flexible fuel quattro	Petrol/Ethanol	132	01/10 →						
2.0 TFSI flexible fuel quattro	Petrol/Ethanol	132	11/09 →						
2.0 TFSI quattro	Petrol	155	06/08 →						
2.7 TDI	Diesel	120	06/08 →						
2.7 TDI	Diesel	140	04/08 →						
3.0 TDI	Diesel	150	11/11 →						
3.0 TDI quattro	Diesel	180	11/11 →						
3.0 TDI quattro	Diesel	176	04/08 →						
3.0 TFSI quattro	Petrol	200	02/12 →						
3.2 FSI	Petrol	195	09/08 →						
3.2 FSI quattro	Petrol	195	04/08 →						
S4 quattro	Petrol	245	03/09 →						
S4 quattro	Petrol	245	11/08 →						

A4 Cabriolet (8H7, B6, 8HE, B7)

1.8 T	Petrol	120	07/02 → 03/09						
1.8 T	Petrol	120	07/02 → 12/05						
1.8 T	Petrol	120	07/02 → 03/09						
1.8 T quattro	Petrol	120	05/03 → 03/09						
1.8 T quattro	Petrol	120	05/03 → 12/05						
1.8 T quattro	Petrol	120	05/03 → 03/09						
2.0	Petrol	96	09/04 → 11/05						
2.0	Petrol	147	11/05 → 03/09						
2.0	Petrol	96	09/04 → 12/05						
2.0	Petrol	96	09/04 → 12/05						
2.0 TDi	Diesel	100	01/06 → 03/09				AMM19752	B4	
2.0 TDi	Diesel	103	01/06 → 03/09				AMM19752	B4	
2.0 TFSI 16V	Petrol	147	01/06 → 03/09						
2.4	Petrol	120	04/02 → 12/05				AMM19671	B4	
2.4	Petrol	125	04/02 → 12/05				AMM19671	B4	
2.4	Petrol	125	04/02 → 11/05						
2.4	Petrol	125	04/02 → 12/05						
2.5 TDI	Diesel	120	08/02 → 12/05				AMM19769	B4	
2.5 TDI	Diesel	120	08/02 → 11/05						
2.5 TDI	Diesel	120	08/02 → 12/05						
2.7 TDI	Diesel	132	06/06 → 03/09						
3.0	Petrol	162	04/02 → 11/05						
3.0	Petrol	162	04/02 → 12/05						
3.0	Petrol	162	04/02 → 12/05						
3.0 quattro	Petrol	162	06/03 → 11/05						
3.0 quattro	Petrol	162	05/03 → 12/05						



TYPE

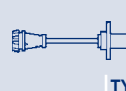

TYPE



TYPE

				SPA111	F1		SAG155	H1		GA2214	J2	
				SPA111	F1					BAE680BB	GA2157	J2
				SPA111	F1					BAE680BB	GA2157	J2
				SPA111	F1					BAE680BB		
				SPA111	F1					BAE680BB		
				SPA111	F1					BAE680BB	GA2157	J2
				SPA111	F1							
				SPA111	F1					GA2214	J2	
				SPA111	F1							
				SPA111	F1							
				SPA111	F1							
				SPA111	F1					GA2214	J2	
				SPA111	F1							
				SPA111	F1					GA2157	J2	
				SPA111	F1					GA2157	J2	
				SPA111	F1							
										GA2157	J2	
				SPA109	F1		SAC084	H2				
				ATS19	F2							
							SAG017	H1				
				SPA109	F1		SAC084	H2		BAE680AW		
				ATS19	F2							
							SAG017	H1				
			RP02A									
				SPA111	F1					BAE680BB		
				SPA109	F1		SAC084	H2		BAE680AC		
							SAG017	H1				
				SPA111	F1							
				SPA111	F1							
				SPA111	F1		SAC085	H2		BAE680BB		
				SPA109	F1							
				SPA109	F1		SAC084	H2				
			RP02A									
							SAG096	H1				
				SGA115	F3		SAG017	H1				
		APS40										
				SPA109	F1							
				SPA111	F1		SAG090	H1				
			RP02A									
				SPA109	F1		SAC073	H2				
							SAG018	H1				
			RP02A									
				SPA109	F1		SAC073	H2		BAE680AC		



KW

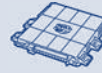

TYPE



TYPE

AUDI

A4 Cabriolet (8H7, B6, 8HE, B7)

3.0 quattro	Petrol	162	05/03 → 12/05						
3.0 TDI quattro	Diesel	150	01/06 → 03/09						
3.0 TDI quattro	Diesel	171	01/06 → 03/09						
3.2 FSI	Petrol	188	01/06 → 03/09						
3.2 FSI quattro	Petrol	188	01/06 → 03/09						
RS4 quattro	Petrol	309	06/06 → 03/09						
S4 quattro	Petrol	253	03/04 → 03/09						

A5 (8T3)

1.8 TFSI	Petrol	118	05/09 →						
1.8 TFSI	Petrol	125	10/07 →						
1.8 TFSI	Petrol	125	10/07 → 11/08						
2.0 TDi	Diesel	120	08/08 →						
2.0 TDi	Diesel	125	08/08 →						
2.0 TDi	Diesel	130	10/11 →						
2.0 TDI quattro	Diesel	130	12/11 →						
2.0 TDI quattro	Diesel	125	08/08 →						
2.0 TFSI	Petrol	132	11/08 →						
2.0 TFSI	Petrol	155	06/08 →						
2.0 TFSI	Petrol	155	06/08 → 05/13						
2.0 TFSI quattro	Petrol	155	06/08 →						
2.7 TDI	Diesel	120	09/07 →						
2.7 TDI	Diesel	140	07/07 →						
2.7 TDI	Diesel	140	06/07 →						
2.7 TDI	Diesel	140	06/07 →						
3.0 TDI	Diesel	150	10/11 →						
3.0 TDI quattro	Diesel	155	03/08 → 05/10						
3.0 TDI quattro	Diesel	176	06/07 →						
3.0 TDI quattro	Diesel	180	10/11 →						
3.0 TDI quattro	Diesel	155	03/08 →						
3.0 TDI quattro	Diesel	176	06/07 →						
3.0 TFSI quattro	Petrol	200	12/11 →						
3.2 FSI	Petrol	195	06/07 →						
3.2 FSI quattro	Petrol	195	06/07 →						
RS 5 quattro	Petrol	331	03/10 →						
S5 quattro	Petrol	245	10/11 →						
S5 quattro	Petrol	260	06/07 →						

A5 Cabriolet (8F7)

1.8 TFSI	Petrol	118	09/09 →						
1.8 TFSI	Petrol	125	10/11 →						
2.0 TDi	Diesel	105	10/11 →						
2.0 TDi	Diesel	130	10/11 →						
2.0 TDi	Diesel	120	05/09 →						
2.0 TDi	Diesel	125	05/09 →						
2.0 TDI quattro	Diesel	130	01/12 →						



KW



TYPE



TYPE

AUDI

A5 Cabriolet (8F7)

2.0 TFSI	Petrol	132	03/09 →						
2.0 TFSI	Petrol	155	03/09 →						
2.0 TFSI quattro	Petrol	155	03/09 →						
2.7 TDI	Diesel	120	05/09 →						
2.7 TDI	Diesel	140	03/09 →						
3.0 TDI	Diesel	150	10/11 →						
3.0 TDI quattro	Diesel	176	03/09 →						
3.0 TDI quattro	Diesel	180	10/11 →						
3.0 TFSI quattro	Petrol	200	12/11 →						
3.2 FSI	Petrol	195	03/09 →						
3.2 FSI quattro	Petrol	195	03/09 →						
S5 quattro	Petrol	245	06/09 →						

A5 Sportback (8TA)

1.8 TFSI	Petrol	118	11/09 →						
1.8 TFSI	Petrol	125	08/11 →						
1.8 TFSI	Petrol	118	11/09 → 09/11						
2.0 TDi	Diesel	130	10/11 →						
2.0 TDi	Diesel	100	09/09 →						
2.0 TDi	Diesel	105	09/09 →						
2.0 TDi	Diesel	120	09/09 →						
2.0 TDi	Diesel	125	09/09 →						
2.0 TDI quattro	Diesel	130	12/11 →						
2.0 TDI quattro	Diesel	125	09/09 →						
2.0 TFSI	Petrol	132	09/09 →						
2.0 TFSI	Petrol	155	09/09 →						
2.0 TFSI	Petrol	155	09/09 → 05/13						
2.0 TFSI quattro	Petrol	155	09/09 →						
2.7 TDI	Diesel	120	09/09 →						
2.7 TDI	Diesel	140	09/09 →						
3.0 TDI	Diesel	150	10/11 →						
3.0 TDI quattro	Diesel	176	09/09 →						
3.0 TDI quattro	Diesel	180	10/11 →						
3.0 TFSI quattro	Petrol	200	12/11 →						
3.2 FSI quattro	Petrol	195	09/09 →						
S5 quattro	Petrol	245	01/10 →						

A6 (4A, C4)

1.8	Petrol	92	12/95 → 02/97				AMM19672	B4	
1.8	Petrol	92	12/95 → 10/97						
1.8	Petrol	92	12/95 → 10/97						
1.8	Petrol	92	12/95 → 10/97						
1.8	Petrol	92	12/95 → 10/97						
1.8 quattro	Petrol	92	12/95 → 02/97				AMM19672	B4	
1.8 quattro	Petrol	92	12/95 → 10/97						
1.8 quattro	Petrol	92	12/95 → 10/97						



KW



TYPE



TYPE

AUDI

A6 (4A, C4)

1.8 quattro	Petrol	92	12/95 → 10/97					
1.9 TDI	Diesel	66	06/94 → 10/97					
1.9 TDI	Diesel	66	06/94 → 09/96					
2.0	Petrol	74	06/94 → 10/97					
2.0	Petrol	85	06/94 → 10/97					
2.0	Petrol	85	06/94 → 10/97					
2.0	Petrol	85	06/94 → 08/96					
2.0	Petrol	85	06/94 → 08/96					
2.0 16V	Petrol	103	06/94 → 10/97					
2.0 16V	Petrol	103	06/94 → 10/97					
2.0 16V	Petrol	103	06/94 → 10/97					
2.0 16V quattro	Petrol	103	06/94 → 10/97					
2.0 16V quattro	Petrol	103	06/94 → 10/97					
2.0 16V quattro	Petrol	103	06/94 → 10/97					
2.6	Petrol	110	06/94 → 10/97	CHASSIS: → 4AS026714		B3391		B1
2.6	Petrol	110	06/94 → 10/97					
2.6	Petrol	102	06/94 → 10/97	CHASSIS: → 4AT150000				
2.6	Petrol	110	06/94 → 10/97	CHASSIS: → 4AT150000				
2.6	Petrol	102	06/94 → 10/97					
2.6 quattro	Petrol	110	06/94 → 10/97	CHASSIS: → 4AS026714		B3391		B1
2.6 quattro	Petrol	110	06/94 → 10/97					
2.8	Petrol	128	06/94 → 02/97			AMM19669		B4
2.8	Petrol	142	12/95 → 02/97			AMM19669		B4
2.8	Petrol	128	06/94 → 10/97					
2.8	Petrol	142	12/95 → 10/97					
2.8	Petrol	128	06/94 → 10/97	CHASSIS: → 4AT150000				
2.8	Petrol	142	12/95 → 10/97					
2.8	Petrol	142	12/95 → 10/97					
2.8 quattro	Petrol	128	06/94 → 02/97			AMM19669		B4
2.8 quattro	Petrol	142	12/95 → 02/97			AMM19669		B4
2.8 quattro	Petrol	128	06/94 → 10/97					
2.8 quattro	Petrol	142	12/95 → 10/97					
2.8 quattro	Petrol	142	12/95 → 10/97					
2.8 quattro	Petrol	142	12/95 → 10/97					
S6 4.2 quattro	Petrol	213	06/94 → 10/97					
S6 4.2 quattro	Petrol	213	08/94 → 07/97					
S6 Turbo quattro	Petrol	169	06/94 → 10/97					
S6 Turbo quattro	Petrol	169	06/94 → 10/97					
S6 Turbo quattro	Petrol	169	06/94 → 07/97					

A6 (4B2, C5)

1.8	Petrol	85	05/97 → 05/00			AMM19666		B4
1.8	Petrol	92	12/97 → 01/05			AMM19666		B4
1.8	Petrol	92	12/97 → 04/01					
1.8	Petrol	85	05/97 → 01/05	CHASSIS: 4BY000001 →				

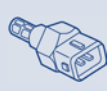
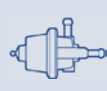

TYPE

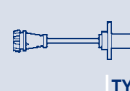

TYPE



TYPE

							SAG026	H1			
			SPA106	F1			SAG142	H1		ESS0080A	J1
							SAG026	H1			
			SPA106	F1							
			SPA106	F1			SAD019	H3			
							SAD021	H3			
							SAG026	H1			
										ESS529	J1
							SAC084	H2			
							SAD019	H3			
							SAD021	H3			
							SAC084	H2			
							SAD019	H3			
							SAD021	H3			
		RP02A	ATS08	F2	SAA104		SAD021	H3		ESS529	J1
			SPA144	F1							
			SPA144	F1							
					SAA104					ESS529	J1
		RP02A	ATS08	F2	SAA104		SAD021	H3		ESS529	J1
		RP02A			SAA104		SAD021	H3		ESS529	J1
		RP02A	ATS08	F2	SAA104		SAC084	H2		ESS529	J1
			SPA144	F1							
			SPA144	F1			SAD021	H3			
							SAG018	H1			
		RP02A			SAA104		SAD021	H3		ESS529	J1
		RP02A	ATS08	F2	SAA104		SAC084	H2		ESS529	J1
							SAD021	H3			
							SAG018	H1			
					SAA104		SAD019	H3			
										ESS529	J1
		RP02A					SAD019	H3			
							SAD021	H3			
										ESS529	J1
			ATS19	F2						BAE680AQ	
							SAC084	H2			
		RP02A	ATS19	F2							
			SPA109	F1							



KW



TYPE



TYPE

AUDI

A6 (4B2, C5)

1.8	Petrol	92	07/97 → 01/05	CHASSIS: 4BY000001 →				
1.8	Petrol	85	05/97 → 01/05					
1.8	Petrol	92	07/97 → 01/05					
1.8	Petrol	92	07/97 → 01/05					
1.8	Petrol	92	07/97 → 01/05					
1.8 T	Petrol	132	12/97 → 10/00					
1.8 T	Petrol	132	12/97 → 01/05	CHASSIS: 4BY000001 →				
1.8 T	Petrol	132	12/97 → 01/05					
1.8 T	Petrol	132	12/97 → 01/05					
1.8 T quattro	Petrol	110	02/97 → 05/04					
1.8 T quattro	Petrol	132	12/97 → 10/00					
1.8 T quattro	Petrol	110	04/97 → 05/04					
1.8 T quattro	Petrol	110	02/97 → 01/05	CHASSIS: 4BY000001 →				
1.8 T quattro	Petrol	132	12/97 → 01/05	CHASSIS: 4BY000001 →				
1.8 T quattro	Petrol	110	02/97 → 01/05					
1.8 T quattro	Petrol	110	02/97 → 01/05					
1.8 T quattro	Petrol	110	02/97 → 01/05					
1.8 T quattro	Petrol	110	02/97 → 01/05					
1.8 T quattro	Petrol	132	12/97 → 01/05					
1.8 T quattro	Petrol	132	12/97 → 01/05					
1.8 T quattro	Petrol	132	12/97 → 01/05					
1.8 T quattro	Petrol	110	11/98 → 05/01					
1.9 TDI	Diesel	96	08/01 → 01/05			AMM19752	B4	
1.9 TDI	Diesel	81	04/97 → 09/00					
1.9 TDI	Diesel	85	07/00 → 04/01					
1.9 TDI	Diesel	81	04/97 → 10/00	CHASSIS: 4BY000001 →				
1.9 TDI	Diesel	85	07/00 → 01/05	CHASSIS: 4BY000001 →				
1.9 TDI	Diesel	81	04/97 → 10/00					
2.0	Petrol	96	08/01 → 05/04					
2.0	Petrol	96	08/01 → 01/05					
2.4	Petrol	100	02/99 → 01/05			AMM19671	B4	
2.4	Petrol	115	08/98 → 07/99			AMM19667	B4	
2.4	Petrol	120	05/97 → 01/05			AMM19667	B4	
2.4	Petrol	120	11/98 → 05/00			AMM19671	B4	
2.4	Petrol	121	04/97 → 01/99			AMM19667	B4	
2.4	Petrol	121	11/98 → 06/00			AMM19671	B4	
2.4	Petrol	125	08/01 → 01/05			AMM19671	B4	
2.4	Petrol	115	04/98 → 04/01					
2.4	Petrol	121	04/97 → 01/05					
2.4	Petrol	125	08/01 → 05/04					
2.4	Petrol	100	07/98 → 01/05	CHASSIS: 4BY000001 →				
2.4	Petrol	100	07/98 → 05/04					
2.4	Petrol	115	02/97 → 01/05	CHASSIS: 4BY000001 →				



TYPE

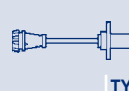

TYPE



TYPE

				SPA109	F1						
							SAG127	H1			
							SAD019	H3	BAE680AW	ESS0072A	J1
							SAD021	H3			
							SAG018	H1			
	APS39	RP02A		ATS19	F2		SAC084	H2			
				SPA109	F1						
							SAD019	H3			
							SAD021	H3			
							SAG127	H1			
	APS39										
	APS39	RP02A		ATS19	F2		SAC084	H2			
		RP02A		ATS19	F2						
				SPA109	F1						
				SPA109	F1						
							SAC084	H2	BAE680AW	ESS0072A	J1
							SAD019	H3			
							SAD021	H3			
							SAG017	H1			
							SAD019	H3		ESS0072A	J1
							SAD021	H3			
							SAG127	H1			
									BAE680AQ		
				SPA109	F1						
	APS39										
	APS39										
				SPA109	F1						
				SPA109	F1						
							SAG142	H1		ESS0080A	J1
		RP02A									
				SPA109	F1		SAC084	H2			
				SPA109	F1		SAC084	H2			
		RP02A		ATS19	F2		SAC084	H2			
		RP02A		ATS19	F2						
		RP02A		ATS19	F2						
				SPA109	F1						
				ATS19	F2						
				SPA109	F1						



KW

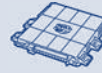

TYPE



TYPE

AUDI

A6 (4B2, C5)

2.4	Petrol	120	02/97 → 01/05	CHASSIS: 4BY000001 →				
2.4	Petrol	120	02/97 → 05/04					
2.4	Petrol	121	02/97 → 01/05	CHASSIS: 4BY000001 →				
2.4	Petrol	125	08/01 → 01/05					
2.4	Petrol	100	07/98 → 01/05					
2.4	Petrol	100	07/98 → 01/05					
2.4	Petrol	100	07/98 → 01/05					
2.4	Petrol	115	02/97 → 01/05					
2.4	Petrol	115	02/97 → 01/05					
2.4	Petrol	115	04/98 → 01/05					
2.4	Petrol	120	02/97 → 01/05					
2.4	Petrol	120	02/97 → 01/05					
2.4	Petrol	120	02/97 → 01/05					
2.4	Petrol	120	02/97 → 12/99					
2.4	Petrol	121	02/97 → 01/05					
2.4	Petrol	121	02/97 → 01/05					
2.4	Petrol	121	02/97 → 05/01					
2.4	Petrol	121	02/97 → 12/99					
2.4 quattro	Petrol	120	05/97 → 01/05			AMM19667	B4	
2.4 quattro	Petrol	120	11/98 → 05/00			AMM19671	B4	
2.4 quattro	Petrol	121	04/97 → 01/99			AMM19667	B4	
2.4 quattro	Petrol	121	11/98 → 06/00			AMM19671	B4	
2.4 quattro	Petrol	125	08/01 → 01/05			AMM19671	B4	
2.4 quattro	Petrol	115	08/98 → 07/99					
2.4 quattro	Petrol	115	08/98 → 07/99					
2.4 quattro	Petrol	120	06/97 → 05/00					
2.4 quattro	Petrol	125	08/01 → 05/04					
2.4 quattro	Petrol	115	08/98 → 07/99					
2.4 quattro	Petrol	115	08/98 → 07/99	CHASSIS: 4BY000001 →				
2.4 quattro	Petrol	120	02/97 → 01/05	CHASSIS: 4BY000001 →				
2.4 quattro	Petrol	121	02/97 → 01/05	CHASSIS: 4BY000001 →				
2.4 quattro	Petrol	121	04/97 → 05/01					
2.4 quattro	Petrol	125	08/01 → 01/05					
2.4 quattro	Petrol	120	02/97 → 01/05					
2.4 quattro	Petrol	120	02/97 → 01/05					
2.4 quattro	Petrol	120	02/97 → 05/00					
2.4 quattro	Petrol	120	02/97 → 12/99					
2.4 quattro	Petrol	121	02/97 → 01/05					
2.4 quattro	Petrol	121	02/97 → 01/05					
2.4 quattro	Petrol	121	02/97 → 05/01					
2.4 quattro	Petrol	121	02/97 → 12/99					
2.5 TDI	Diesel	114	08/01 → 01/05			AMM19769	B4	
2.5 TDI	Diesel	120	07/02 → 01/05			AMM19769	B4	
2.5 TDI	Diesel	132	02/00 → 01/05			AMM19769	B4	

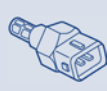
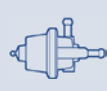

TYPE



TYPE



TYPE

				SPA109	F1					
				ATS19	F2					
				SPA109	F1					
							SAG018	H1		
							SAC084	H2	ESS0072A	J1
							SAD021	H3		
							SAG018	H1		
							SAD021	H3		
							SAG096	H1		
							SAG018	H1		
							SAC084	H2		
							SAD021	H3		
							SAG096	H1		
							SAG018	H1		
							SAD021	H3		
							SAG096	H1		
							SAC084	H2		
							SAG018	H1		
				SPA109	F1		SAC084	H2	ESS0072A	J1
		RP02A		ATS19	F2		SAC084	H2	ESS0072A	J1
							SAD021	H3		
		RP02A		ATS19	F2					
		RP02A		ATS19	F2					
							SAG018	H1		
				SPA109	F1					
				SPA109	F1					
				SPA109	F1					
				ATS19	F2					
							SAG018	H1		
							SAD021	H3	ESS0072A	J1
							SAG096	H1		
							SAC084	H2		
							SAG018	H1		
							SAD021	H3	ESS0072A	J1
							SAG096	H1		
							SAC084	H2		
							SAG018	H1		
				SGA115	F3		SAG017	H1		
				SGA115	F3		SAG017	H1		
				SGA115	F3		SAG017	H1		



KW



TYPE



TYPE

AUDI

A6 (4B2, C5)

2.5 TDI	Diesel	110	07/97 → 01/05					
2.5 TDI	Diesel	110	07/97 → 01/05	CHASSIS: 4BY000001 →				
2.5 TDI	Diesel	114	08/01 → 01/05					
2.5 TDI	Diesel	120	07/02 → 01/05					
2.5 TDI	Diesel	132	02/00 → 01/05	CHASSIS: 4BY000001 →				
2.5 TDI quattro	Diesel	132	02/00 → 01/05			AMM19769	B4	
2.5 TDI quattro	Diesel	110	07/97 → 01/05					
2.5 TDI quattro	Diesel	110	07/97 → 01/05	CHASSIS: 4BY000001 →				
2.5 TDI quattro	Diesel	132	02/00 → 01/05	CHASSIS: 4BY000001 →				
2.7 T	Petrol	169	02/99 → 05/01					
2.7 T	Petrol	169	02/99 → 01/05	CHASSIS: 4BY000001 →				
2.7 T	Petrol	169	02/99 → 01/05					
2.7 T	Petrol	169	02/99 → 01/05					
2.7 T	Petrol	169	02/99 → 05/00	CHASSIS: → 4B1006637				
2.7 T quattro	Petrol	169	12/97 → 08/00					
2.7 T quattro	Petrol	184	08/01 → 05/04					
2.7 T quattro	Petrol	169	12/97 → 01/05	CHASSIS: 4BY000001 →				
2.7 T quattro	Petrol	184	08/01 → 01/05					
2.7 T quattro	Petrol	169	12/97 → 01/05					
2.7 T quattro	Petrol	169	01/99 → 01/05					
2.7 T quattro	Petrol	169	02/99 → 05/00	CHASSIS: → 4B1006637				
2.7 T quattro	Petrol	184	08/01 → 01/05					
2.8	Petrol	132	04/98 → 07/98			AMM19667	B4	
2.8	Petrol	140	07/99 → 06/01			AMM19671	B4	
2.8	Petrol	142	04/97 → 12/98			AMM19667	B4	
2.8	Petrol	142	11/98 → 06/01			AMM19671	B4	
2.8	Petrol	132	10/97 → 05/00					
2.8	Petrol	140	07/99 → 04/01					
2.8	Petrol	142	04/97 → 04/01					
2.8	Petrol	132	10/97 → 05/00					
2.8	Petrol	132	10/97 → 05/00	CHASSIS: 4BY000001 →				
2.8	Petrol	140	07/99 → 01/05	CHASSIS: 4BY000001 →				
2.8	Petrol	142	02/97 → 01/05	CHASSIS: 4BY000001 →				
2.8	Petrol	142	02/97 → 01/05					
2.8	Petrol	132	10/97 → 05/00					
2.8	Petrol	140	07/99 → 01/05					
2.8	Petrol	142	02/97 → 01/05					
2.8	Petrol	142	02/97 → 04/01					
2.8	Petrol	142	02/97 → 12/99					
2.8 quattro	Petrol	142	04/97 → 12/98			AMM19667	B4	
2.8 quattro	Petrol	142	11/98 → 06/01			AMM19671	B4	
2.8 quattro	Petrol	142	04/97 → 05/01					
2.8 quattro	Petrol	140	07/99 → 05/01					
2.8 quattro	Petrol	142	02/97 → 01/05	CHASSIS: 4BY000001 →				

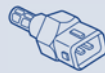
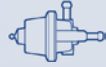

TYPE



TYPE



TYPE

			SGA115	F3		SAG017	H1		ESS0080A	J1
			SPA109	F1						
			SPA109	F1						
			SPA109	F1						
			SPA109	F1						
			SGA115	F3		SAG017	H1			
			SGA115	F3		SAG017	H1			
			SPA109	F1						
			SPA109	F1						
		RP02A	ATS19	F2		SAC084	H2			
			SPA109	F1						
						SAD021	H3		ESS0072A	J1
						SAG018	H1			
						SAG017	H1			
		RP02A	ATS19	F2		SAC084	H2			
		RP02A	ATS19	F2						
			SPA109	F1						
			SPA109	F1		SAC084	H2	BAE680AW		
						SAD021	H3		ESS0072A	J1
						SAG018	H1			
						SAG017	H1			
						SAG018	H1			
		RP02A	ATS19	F2		SAC084	H2			
		RP02A	ATS19	F2		SAC084	H2			
		RP02A	ATS19	F2						
						SAD021	H3			
			SPA109	F1						
			SPA109	F1						
			SPA109	F1						
					SAA104	SAD021	H3			
						SAG018	H1			
						SAG018	H1			
						SAG096	H1			
						SAC084	H2			
						SAG018	H1			
		RP02A	ATS19	F2						
			SPA109	F1		SAG018	H1			
			SPA109	F1						



KW



TYPE



TYPE

AUDI

A6 (4B2, C5)

2.8 quattro	Petrol	142	02/97 → 01/05					
2.8 quattro	Petrol	142	02/97 → 01/05					
2.8 quattro	Petrol	142	02/97 → 05/01					
2.8 quattro	Petrol	142	02/97 → 12/99					
3.0	Petrol	162	08/01 → 01/05				AMM19674	B4
3.0	Petrol	162	08/01 → 05/04					
3.0	Petrol	162	08/01 → 01/05					
3.0 quattro	Petrol	162	08/01 → 05/04					
3.0 quattro	Petrol	160	06/01 → 07/04					
3.0 quattro	Petrol	162	08/01 → 01/05					
3.0 quattro	Petrol	162	08/01 → 01/05					
3.7 quattro	Petrol	191	03/99 → 01/05					
4.2 quattro	Petrol	220	11/98 → 01/05					
4.2 quattro	Petrol	220	11/98 → 01/05					
4.2 quattro	Petrol	220	04/99 → 05/04					
RS6 quattro	Petrol	331	07/02 → 04/04					
RS6 quattro	Petrol	331	07/02 → 01/05					
RS6 quattro	Petrol	331	07/02 → 01/05					
S6 quattro	Petrol	250	09/99 → 05/04					
S6 quattro	Petrol	250	09/99 → 01/05					
S6 quattro	Petrol	250	09/99 → 01/05					
S6 quattro	Petrol	250	09/99 → 01/05					

A6 (4F2, C6)

2.0 TDi	Diesel	100	05/05 → 03/11				AMM19752	B4
2.0 TDi	Diesel	103	07/04 → 10/08				AMM19752	B4
2.0 TDi	Diesel	89	09/05 → 06/06				AMM19752	B4
2.0 TDi	Diesel	100	07/04 → 07/09					
2.0 TDi	Diesel	103	07/04 → 10/08					
2.0 TDi	Diesel	120	04/09 → 07/09					
2.0 TDi	Diesel	125	11/08 → 07/09					
2.0 TDi	Diesel	100	07/04 → 03/11					
2.0 TDi	Diesel	100	07/04 → 03/11					
2.0 TFSI	Petrol	125	06/05 → 03/11					
2.0 TFSI	Petrol	125	06/05 → 03/11					
2.4	Petrol	130	05/04 → 10/08					
2.4 quattro	Petrol	130	01/05 → 10/08					
2.7 TDI	Diesel	120	11/04 → 07/09					
2.7 TDI	Diesel	132	11/04 → 10/08					
2.7 TDI	Diesel	120	11/04 → 03/11					
2.7 TDI quattro	Diesel	120	06/05 → 07/09					
2.7 TDI quattro	Diesel	132	11/04 → 10/08					
2.7 TDI quattro	Diesel	120	06/05 → 03/11					
2.8 FSI	Petrol	140	10/08 → 03/11					
2.8 FSI	Petrol	154	11/06 → 10/08					

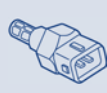
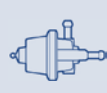

TYPE

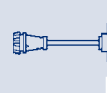

TYPE



TYPE

					SAA104	SAD021	H3	ESS0072A	J1
						SAG096	H1		
						SAC084	H2		
						SAG018	H1		
			SPA109	F1		SAC073	H2	BAE680AC	
		RP02A				SAC084	H2		
						SAG018	H1		
		RP02A				SAC084	H2		
			SPA109	F1		SAG018	H1		
			SPA109	F1		SAC073	H2	ESS0072A	J1
						SAG018	H1		
						SAG056	H1		
			SPA109	F1		SAD019	H3	ESS0072A	J1
						SAG056	H1		
						SAC084	H2		
	APS39	RP02A	ATS08	F2					
			SPA109	F1		SAC084	H2		
						SAG056	H1		
		RP02A							
			SPA109	F1		SAC084	H2		
						SAD019	H3		
						SAG056	H1		
			SPA111	F1		SAC085	H2		
			SPA111	F1					
			SPA111	F1					
						SAG166	H1		
			SPA111	F1					
			SPA111	F1					
						SAC085	H2		
						SAG166	H1		
			SPA111	F1		SAC073	H2	BAE680BB	
						SAD031	H3		
		RP02A	SPA111	F1				BAE680AV	
		RP02A	SPA111	F1					
			SPA111	F1					
			SPA111	F1		SAG090	H1		
						SAG090	H1		
			SPA111	F1					
			SPA111	F1		SAG090	H1		
						SAG090	H1		
			SPA111	F1					
			SPA111	F1					



KW



TYPE



TYPE

AUDI

A6 (4F2, C6)

2.8 FSI	Petrol	162	10/08 → 03/11
2.8 FSI quattro	Petrol	140	10/08 → 03/11
2.8 FSI quattro	Petrol	154	06/07 → 10/08
2.8 FSI quattro	Petrol	162	10/08 → 03/11
3.0	Petrol	160	08/04 → 05/06
3.0 quattro	Petrol	160	05/04 → 05/06
3.0 TDI	Diesel	171	06/06 → 03/11
3.0 TDI quattro	Diesel	155	05/04 → 03/11
3.0 TDI quattro	Diesel	165	05/04 → 05/06
3.0 TDI quattro	Diesel	171	06/06 → 10/08
3.0 TFSI quattro	Petrol	213	10/08 → 03/11
3.0 TFSI quattro	Petrol	220	10/08 → 03/11
3.2 FSI	Petrol	188	05/04 → 05/09
3.2 FSI quattro	Petrol	183	09/06 → 10/08
3.2 FSI quattro	Petrol	188	05/04 → 10/08
4.2 FSI quattro	Petrol	257	06/06 → 03/11
4.2 quattro	Petrol	246	05/04 → 05/06
S6 quattro	Petrol	320	03/06 → 03/11

A6 (4G2, C7, 4GC)

2.0 TDi	Diesel	120	03/11 →
2.0 TDi	Diesel	100	01/12 →
2.0 TFSI	Petrol	132	05/11 →
2.0 TFSI	Petrol	155	03/11 → 05/13
2.0 TFSI hybrid	Hybrid	155	11/11 →
3.0 TDI quattro	Diesel	230	11/11 →
3.0 TFSI quattro	Petrol	228	03/11 →
S6 quattro	Petrol	309	04/12 →

A6 Allroad (4FH, C6)

2.7 TDI quattro	Diesel	120	05/06 → 08/11
2.7 TDI quattro	Diesel	132	05/06 → 10/08
2.7 TDI quattro	Diesel	140	10/08 → 08/11
3.0 TDI quattro	Diesel	155	05/06 → 08/11
3.0 TDI quattro	Diesel	171	05/06 → 10/08
3.0 TDI quattro	Diesel	176	10/08 → 08/11
3.0 TFSI quattro	Petrol	213	10/08 → 08/11
3.2 FSI quattro	Petrol	188	05/06 → 10/08
4.2 FSI quattro	Petrol	257	05/06 → 12/10

A6 Allroad (4GH, 4GJ)

3.0 TDI quattro	Diesel	150	01/12 →
3.0 TDI quattro	Diesel	180	01/12 →
3.0 TDI quattro	Diesel	230	01/12 →
3.0 TFSI quattro	Petrol	228	01/12 →



KW



TYPE



TYPE

AUDI

A6 Avant (4A, C4)

1.8	Petrol	92	12/95 → 12/97				AMM19672	B4
1.8	Petrol	92	12/95 → 10/97					
1.8	Petrol	92	12/95 → 12/97					
1.8	Petrol	92	12/95 → 12/97					
1.8	Petrol	92	12/95 → 12/97					
1.8	Petrol	92	12/95 → 10/97					
1.8 quattro	Petrol	92	12/95 → 12/97				AMM19672	B4
1.8 quattro	Petrol	92	07/96 → 10/97					
1.8 quattro	Petrol	92	12/95 → 12/97					
1.8 quattro	Petrol	92	12/95 → 12/97					
1.8 quattro	Petrol	92	06/96 → 10/97					
1.9 TDI	Diesel	66	06/94 → 12/97					
1.9 TDI	Diesel	66	06/94 → 09/96					
2.0	Petrol	74	06/94 → 12/97					
2.0	Petrol	85	06/94 → 12/97					
2.0	Petrol	85	06/94 → 12/97					
2.0	Petrol	85	06/94 → 08/96					
2.0	Petrol	85	06/94 → 06/96					
2.0 16V	Petrol	103	06/94 → 12/97					
2.0 16V	Petrol	103	06/94 → 12/97					
2.0 16V	Petrol	103	06/94 → 12/97					
2.0 16V	Petrol	103	06/96 → 10/97					
2.0 16V quattro	Petrol	103	06/94 → 12/97					
2.0 16V quattro	Petrol	103	06/94 → 12/97					
2.0 16V quattro	Petrol	103	06/94 → 12/97					
2.6	Petrol	110	06/94 → 12/97	CHASSIS: → 4AS026714			B3391	B1
2.6	Petrol	110	06/94 → 06/96					
2.6	Petrol	102	06/94 → 02/97	CHASSIS: → 4AT150000				
2.6	Petrol	110	06/94 → 12/97	CHASSIS: → 4AT150000				
2.6	Petrol	102	06/94 → 02/97					
2.6	Petrol	110	06/94 → 12/97					
2.6	Petrol	102	06/94 → 07/96					
2.6	Petrol	110	06/94 → 06/96					
2.8	Petrol	128	06/94 → 12/97				AMM19669	B4
2.8	Petrol	142	12/95 → 12/97				AMM19669	B4
2.8	Petrol	128	06/94 → 07/96					
2.8	Petrol	128	06/94 → 12/97	CHASSIS: → 4AT150000				
2.8	Petrol	142	12/95 → 12/97					
2.8	Petrol	142	12/95 → 12/97					
2.8	Petrol	142	12/95 → 10/97					
2.8	Petrol	128	06/94 → 07/96					
2.8	Petrol	142	12/95 → 10/97					
2.8 quattro	Petrol	128	06/94 → 12/97				AMM19669	B4
2.8 quattro	Petrol	142	12/95 → 12/97				AMM19669	B4

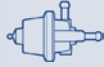

TYPE



TYPE



TYPE

			SPA144	F1		SAC084	H2			
		RP02A	ATS19	F2				BAE680AQ		
						SAD019	H3			
						SAD021	H3			
						SAG026	H1			
									ESS529	J1
						SAC084	H2			
		RP02A						BAE680AQ		
						SAD021	H3			
						SAG026	H1			
									ESS529	J1
			SPA106	F1		SAG142	H1			
						SAG026	H1			
			SPA106	F1						
			SPA106	F1		SAD019	H3			
						SAD021	H3			
						SAG026	H1			
									ESS529	J1
						SAC084	H2			
						SAD019	H3			
						SAD021	H3			
									ESS529	J1
						SAC084	H2			
						SAD019	H3			
						SAD021	H3			
		RP02A	ATS08	F2						
			SPA144	F1						
			SPA144	F1						
					SAA104					
					SAA104	SAD021	H3			
									ESS529	J1
									ESS529	J1
					SAA104	SAD021	H3			
			ATS08	F2	SAA104	SAC084	H2			
		RP02A								
			SPA144	F1						
			SPA144	F1		SAD021	H3			
						SAG018	H1			
						SAG038	H1			
									ESS529	J1
									ESS529	J1
					SAA104	SAD021	H3			
					SAA104	SAC084	H2			



KW



TYPE



TYPE

AUDI

A6 Avant (4A, C4)

2.8 quattro	Petrol	128	07/96 → 10/97						
2.8 quattro	Petrol	142	07/96 → 12/97						
2.8 quattro	Petrol	142	12/95 → 12/97						
2.8 quattro	Petrol	142	12/95 → 12/97						
2.8 quattro	Petrol	142	07/96 → 10/97						
2.8 quattro	Petrol	128	06/94 → 10/97						
2.8 quattro	Petrol	142	06/96 → 10/97						
S6 4.2 quattro	Petrol	213	06/94 → 12/97						
S6 4.2 quattro	Petrol	213	08/94 → 07/97						
S6 Turbo quattro	Petrol	169	06/94 → 07/97						
S6 Turbo quattro	Petrol	169	06/94 → 12/97						
S6 Turbo quattro	Petrol	169	06/94 → 12/97						
S6 Turbo quattro	Petrol	169	06/94 → 07/97						

A6 Avant (4B5, C5)

1.8	Petrol	85	02/98 → 05/00					AMM19666	B4
1.8	Petrol	92	12/97 → 01/05					AMM19666	B4
1.8	Petrol	92	02/98 → 04/01						
1.8	Petrol	85	02/98 → 01/05	CHASSIS: 4BY000001 →					
1.8	Petrol	92	12/97 → 01/05	CHASSIS: 4BY000001 →					
1.8	Petrol	85	02/98 → 01/05						
1.8	Petrol	92	12/97 → 01/05						
1.8	Petrol	92	12/97 → 04/01						
1.8	Petrol	92	01/98 → 01/05						
1.8 T	Petrol	110	12/97 → 04/01						
1.8 T	Petrol	132	04/99 → 10/00						
1.8 T	Petrol	110	02/98 → 04/01						
1.8 T	Petrol	110	12/97 → 01/05	CHASSIS: 4BY000001 →					
1.8 T	Petrol	132	04/99 → 01/05	CHASSIS: 4BY000001 →					
1.8 T	Petrol	110	12/97 → 01/05						
1.8 T	Petrol	110	12/97 → 01/05						
1.8 T	Petrol	110	12/97 → 01/05						
1.8 T	Petrol	132	04/99 → 01/05						
1.8 T	Petrol	132	04/99 → 01/05						
1.8 T	Petrol	110	11/98 → 04/01						
1.8 T quattro	Petrol	110	12/97 → 01/05						
1.8 T quattro	Petrol	132	12/97 → 10/00						
1.8 T quattro	Petrol	110	02/98 → 01/05						
1.8 T quattro	Petrol	132	02/98 → 10/00						
1.8 T quattro	Petrol	110	12/97 → 01/05	CHASSIS: 4BY200001 →					
1.8 T quattro	Petrol	132	12/97 → 01/05	CHASSIS: 4BY000001 →					
1.8 T quattro	Petrol	110	12/97 → 01/05						
1.8 T quattro	Petrol	110	12/97 → 01/05						
1.8 T quattro	Petrol	132	12/97 → 01/05						

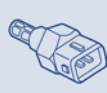
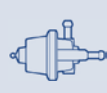

TYPE

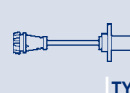

TYPE



TYPE

			RP02A										
				ATS08	F2								
								SAD021	H3				
								SAG018	H1				
								SAG038	H1				
												ESS529	J1
												ESS529	J1
							SAA104	SAD019	H3				
												ESS529	J1
			RP02A										
								SAD019	H3				
								SAD021	H3				
												ESS529	J1
				ATS19	F2							BAE680AQ	
								SAD019	H3				
			RP02A	ATS19	F2								
				SPA109	F1								
				SPA109	F1								
								SAG127	H1				
								SAD021	H3				
								SAC084	H2				
								SAG018	H1				
		APS39											
		APS39	RP02A	ATS19	F2			SAC084	H2				
			RP02A	ATS19	F2			SAC084	H2				
				SPA109	F1								
				SPA109	F1								
								SAD019	H3				
								SAD021	H3				
								SAG017	H1				
								SAD019	H3			ESS0072A	J1
								SAD021	H3				
								SAG127	H1				
												BAE680AQ	
		APS39						SAD019	H3			ESS0072A	J1
		APS39						SAC084	H2				
			RP02A	ATS19	F2			SAC084	H2				
			RP02A	ATS19	F2								
				SPA109	F1								
				SPA109	F1								
								SAD021	H3				
								SAG017	H1				
								SAD019	H3			ESS0072A	J1



KW

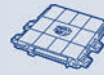

TYPE



TYPE

AUDI

A6 Avant (4B5, C5)

1.8 T quattro	Petrol	132	12/97 → 01/05					
1.8 T quattro	Petrol	132	12/97 → 01/05					
1.9 TDI	Diesel	96	08/01 → 01/05				AMM19752	B4
1.9 TDI	Diesel	81	02/98 → 03/01					
1.9 TDI	Diesel	85	07/00 → 04/01					
1.9 TDI	Diesel	81	02/98 → 04/01	CHASSIS: 4BY000001 →				
1.9 TDI	Diesel	85	07/00 → 01/05	CHASSIS: 4BY000001 →				
1.9 TDI	Diesel	81	02/98 → 04/01					
2.0	Petrol	96	08/01 → 01/05					
2.4	Petrol	100	02/99 → 01/05				AMM19671	B4
2.4	Petrol	115	08/98 → 07/99				AMM19667	B4
2.4	Petrol	120	12/97 → 01/99				AMM19667	B4
2.4	Petrol	120	11/98 → 05/00				AMM19671	B4
2.4	Petrol	121	12/97 → 01/99				AMM19667	B4
2.4	Petrol	121	11/98 → 06/01				AMM19671	B4
2.4	Petrol	125	08/01 → 01/05				AMM19671	B4
2.4	Petrol	121	12/97 → 04/01					
2.4	Petrol	125	08/01 → 01/05					
2.4	Petrol	100	07/98 → 01/05					
2.4	Petrol	100	07/98 → 01/05	CHASSIS: 4BY000001 →				
2.4	Petrol	115	12/97 → 01/05	CHASSIS: 4BY000001 →				
2.4	Petrol	115	04/98 → 07/98					
2.4	Petrol	120	12/97 → 01/05	CHASSIS: 4BY000001 →				
2.4	Petrol	120	02/98 → 04/01					
2.4	Petrol	121	12/97 → 01/05	CHASSIS: 4BY000001 →				
2.4	Petrol	100	07/98 → 01/05					
2.4	Petrol	100	07/98 → 01/05					
2.4	Petrol	115	12/97 → 01/05					
2.4	Petrol	115	12/97 → 01/05					
2.4	Petrol	115	04/98 → 01/05					
2.4	Petrol	120	12/97 → 01/05					
2.4	Petrol	120	12/97 → 01/05					
2.4	Petrol	120	12/97 → 04/01					
2.4	Petrol	120	02/98 → 01/05					
2.4	Petrol	121	12/97 → 01/05					
2.4	Petrol	121	12/97 → 01/05					
2.4	Petrol	121	12/97 → 05/01					
2.4 quattro	Petrol	120	12/97 → 01/99				AMM19667	B4
2.4 quattro	Petrol	120	11/98 → 05/00				AMM19671	B4
2.4 quattro	Petrol	121	12/97 → 01/99				AMM19667	B4
2.4 quattro	Petrol	121	11/98 → 06/01				AMM19671	B4
2.4 quattro	Petrol	125	08/01 → 01/05				AMM19671	B4
2.4 quattro	Petrol	115	08/98 → 05/01					
2.4 quattro	Petrol	120	12/97 → 05/01					

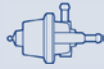

TYPE



TYPE



TYPE

						SAD021	H3		
						SAG127	H1		
			SPA109	F1					
	APS39								
	APS39								
			SPA109	F1					
			SPA109	F1					
						SAG142	H1		
		RP02A	SPA109	F1		SAC084	H2		
		RP02A	ATS19	F2		SAC084	H2		
		RP02A	ATS19	F2					
			SPA109	F1		SAG018	H1		
			ATS19	F2		SAC084	H2		
			SPA109	F1					
			SPA109	F1					
			ATS19	F2		SAC084	H2		
			SPA109	F1					
			ATS19	F2					
			SPA109	F1					
						SAD021	H3		
						SAG018	H1		
						SAD021	H3		
						SAG096	H1		
						SAG018	H1		
						SAD021	H3		
						SAG096	H1		
						SAC084	H2		
						SAG018	H1		
						SAD021	H3		
						SAG018	H1		
						SAC084	H2		
		RP02A	ATS19	F2		SAC084	H2	ESS0072A	J1
		RP02A	ATS19	F2		SAC084	H2		
		RP02A	ATS19	F2		SAC084	H2		



KW



TYPE



TYPE

AUDI

A6 Avant (4B5, C5)

2.4 quattro	Petrol	121	12/97 → 05/01					
2.4 quattro	Petrol	125	08/01 → 01/05					
2.4 quattro	Petrol	115	08/98 → 05/01					
2.4 quattro	Petrol	115	08/98 → 05/01	CHASSIS: 4BY000001 →				
2.4 quattro	Petrol	120	12/97 → 01/05	CHASSIS: 4BY000001 →				
2.4 quattro	Petrol	121	12/97 → 01/05	CHASSIS: 4BY000001 →				
2.4 quattro	Petrol	115	08/98 → 05/01					
2.4 quattro	Petrol	120	12/97 → 01/05					
2.4 quattro	Petrol	120	12/97 → 01/05					
2.4 quattro	Petrol	121	12/97 → 01/05					
2.4 quattro	Petrol	121	12/97 → 01/05					
2.4 quattro	Petrol	121	12/97 → 01/05					
2.4 quattro	Petrol	121	01/98 → 12/99					
2.5 TDI	Diesel	114	08/01 → 01/05				AMM19769	B4
2.5 TDI	Diesel	120	07/02 → 01/05				AMM19769	B4
2.5 TDI	Diesel	132	02/00 → 01/05				AMM19769	B4
2.5 TDI	Diesel	110	12/97 → 01/05					
2.5 TDI	Diesel	110	12/97 → 01/05	CHASSIS: 4BY000001 →				
2.5 TDI	Diesel	114	08/01 → 01/05					
2.5 TDI	Diesel	120	07/02 → 01/05					
2.5 TDI	Diesel	132	02/00 → 01/05	CHASSIS: 4BY000001 →				
2.5 TDI quattro	Diesel	132	02/00 → 01/05				AMM19769	B4
2.5 TDI quattro	Diesel	110	12/97 → 01/05					
2.5 TDI quattro	Diesel	110	12/97 → 01/05	CHASSIS: 4BY000001 →				
2.5 TDI quattro	Diesel	132	02/00 → 01/05	CHASSIS: 4BY000001 →				
2.7 T	Petrol	169	02/99 → 05/01					
2.7 T	Petrol	169	02/99 → 01/05	CHASSIS: 4BY000001 →				
2.7 T	Petrol	169	02/99 → 01/05					
2.7 T	Petrol	169	02/99 → 01/05					
2.7 T	Petrol	169	02/99 → 05/00	CHASSIS: → 4B1006637				
2.7 T quattro	Petrol	184	08/01 → 01/05					
2.7 T quattro	Petrol	169	12/97 → 01/05	CHASSIS: 4BY000001 →				
2.7 T quattro	Petrol	169	02/99 → 05/01					
2.7 T quattro	Petrol	184	08/01 → 01/05					
2.7 T quattro	Petrol	169	12/97 → 01/05					
2.7 T quattro	Petrol	169	12/97 → 08/00					
2.7 T quattro	Petrol	169	01/99 → 01/05					
2.7 T quattro	Petrol	169	02/99 → 05/00	CHASSIS: → 4B1006637				
2.8	Petrol	132	04/98 → 07/98				AMM19667	B4
2.8	Petrol	140	07/99 → 06/01				AMM19671	B4
2.8	Petrol	142	12/97 → 12/98				AMM19667	B4
2.8	Petrol	142	11/98 → 06/01				AMM19671	B4
2.8	Petrol	132	02/98 → 05/00					
2.8	Petrol	140	07/99 → 04/01					
2.8	Petrol	142	02/98 → 04/01					



TYPE

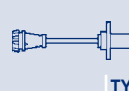

TYPE



TYPE

			RP02A	ATS19	F2		SAC084	H2		
				SPA109	F1		SAG018	H1		
							SAD021	H3		
				SPA109	F1					
				SPA109	F1					
				SPA109	F1					
							SAG018	H1		
							SAD021	H3	ESS0072A	J1
							SAG018	H1		
							SAD021	H3	ESS0072A	J1
							SAG096	H1		
							SAG018	H1		
				SGA115	F3		SAG017	H1		
				SGA115	F3		SAG017	H1		
				SGA115	F3		SAG017	H1		
				SGA115	F3		SAG017	H1		
				SPA109	F1					
				SPA109	F1					
				SPA109	F1					
				SPA109	F1					
				SGA115	F3		SAG017	H1		
				SGA115	F3		SAG017	H1		
				SPA109	F1					
				SPA109	F1					
			RP02A	ATS19	F2		SAC084	H2		
				SPA109	F1					
							SAD021	H3	ESS0072A	J1
							SAG018	H1		
							SAG017	H1		
			RP02A	ATS19	F2		SAC084	H2		
				SPA109	F1					
				ATS19	F2					
				SPA109	F1		SAG018	H1		
							SAD021	H3	ESS0072A	J1
							SAC084	H2		
							SAG018	H1		
							SAG017	H1		
			RP02A	ATS19	F2					
			RP02A	ATS19	F2		SAC084	H2		
			RP02A	ATS19	F2					



KW



TYPE



TYPE

AUDI

A6 Avant (4B5, C5)

2.8	Petrol	132	12/97 → 05/00	CHASSIS: 4BY000001 →				
2.8	Petrol	140	07/99 → 01/05	CHASSIS: 4BY000001 →				
2.8	Petrol	142	12/97 → 01/05	CHASSIS: 4BY000001 →				
2.8	Petrol	142	12/97 → 01/05					
2.8	Petrol	132	12/97 → 05/00					
2.8	Petrol	132	12/97 → 05/00					
2.8	Petrol	132	12/97 → 05/00					
2.8	Petrol	140	07/99 → 01/05					
2.8	Petrol	142	12/97 → 01/05					
2.8	Petrol	142	12/97 → 01/05					
2.8 quattro	Petrol	142	12/97 → 12/98			AMM19667	B4	
2.8 quattro	Petrol	142	11/98 → 06/01			AMM19671	B4	
2.8 quattro	Petrol	142	02/98 → 05/01					
2.8 quattro	Petrol	142	12/97 → 01/05	CHASSIS: 4BY000001 →				
2.8 quattro	Petrol	142	12/97 → 01/05					
2.8 quattro	Petrol	142	12/97 → 01/05					
2.8 quattro	Petrol	142	12/97 → 01/05					
3.0	Petrol	162	08/01 → 01/05			AMM19674	B4	
3.0	Petrol	162	08/01 → 01/05					
3.0 quattro	Petrol	162	08/01 → 01/05					
3.0 quattro	Petrol	162	08/01 → 01/05					
3.7 quattro	Petrol	191	03/99 → 01/05					
4.2 quattro	Petrol	220	04/99 → 01/05					
4.2 quattro	Petrol	220	11/98 → 01/05					
4.2 quattro	Petrol	220	11/98 → 01/05					
4.2 quattro	Petrol	220	11/98 → 01/05					
RS6 plus quattro	Petrol	353	04/04 → 09/04					
RS6 plus quattro	Petrol	353	04/04 → 09/04					
RS6 plus quattro	Petrol	353	04/04 → 01/05					
RS6 plus quattro	Petrol	353	04/04 → 01/05					
RS6 quattro	Petrol	331	07/02 → 04/04					
RS6 quattro	Petrol	331	07/02 → 09/04					
RS6 quattro	Petrol	331	07/02 → 01/05					
RS6 quattro	Petrol	331	07/02 → 01/05					
S6 quattro	Petrol	250	09/99 → 01/05					
S6 quattro	Petrol	250	09/99 → 01/05					
S6 quattro	Petrol	250	09/99 → 01/05					

A6 Avant (4F5, C6)

2.0 TDi	Diesel	100	06/05 → 08/11			AMM19752	B4	
2.0 TDi	Diesel	103	06/05 → 10/08			AMM19752	B4	
2.0 TDi	Diesel	89	09/05 → 06/06			AMM19752	B4	
2.0 TDi	Diesel	100	06/05 → 07/09					
2.0 TDi	Diesel	103	06/05 → 10/08					
2.0 TDi	Diesel	120	04/09 → 07/09					



TYPE

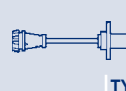

TYPE



TYPE

			SPA109	F1						
			SPA109	F1						
			SPA109	F1						
					SAA104	SAC084	H2			
						SAC084	H2			
						SAD021	H3			
						SAG018	H1			
						SAG018	H1			
						SAD021	H3			
						SAG018	H1			
		RP02A	ATS19	F2						
			SPA109	F1						
					SAA104	SAC084	H2		ESS0072A	J1
						SAD021	H3			
						SAG018	H1			
		RP02A	SPA109	F1		SAC073	H2	BAE680AC		
						SAG018	H1			
		RP02A	SPA109	F1		SAC073	H2		ESS0072A	J1
						SAG018	H1			
						SAG056	H1			
		RP02A								
			SPA109	F1		SAC084	H2		ESS0072A	J1
						SAD019	H3			
						SAG056	H1			
	APS39	RP02A	ATS08	F2						
			SPA109	F1						
						SAC084	H2			
						SAG056	H1			
	APS39	RP02A	ATS08	F2						
			SPA109	F1						
						SAC084	H2			
						SAG056	H1			
		RP02A	SPA109	F1		SAC084	H2			
						SAD019	H3			
						SAG056	H1			
						SAC085	H2			
			SPA111	F1		SAC085	H2			
			SPA111	F1		SAC085	H2			
			SPA111	F1						
						SAG166	H1			
			SPA111	F1						



KW



TYPE



TYPE

AUDI

A6 Avant (4F5, C6)

2.0 TDi	Diesel	125	10/08 → 07/09						
2.0 TDi	Diesel	89	09/05 → 06/06						
2.0 TDi	Diesel	100	06/05 → 08/11						
2.0 TDi	Diesel	125	10/08 → 08/11						
2.0 TFSI	Petrol	125	06/05 → 08/11						
2.0 TFSI	Petrol	125	06/05 → 08/11						
2.4	Petrol	130	03/05 → 10/08						
2.4 quattro	Petrol	130	03/05 → 10/08						
2.7 TDI	Diesel	120	03/05 → 07/09						
2.7 TDI	Diesel	132	03/05 → 10/08						
2.7 TDI	Diesel	120	03/05 → 08/11						
2.7 TDI quattro	Diesel	120	06/05 → 07/09						
2.7 TDI quattro	Diesel	132	03/05 → 10/08						
2.7 TDI quattro	Diesel	120	06/05 → 08/11						
2.8 FSI	Petrol	140	10/08 → 08/11						
2.8 FSI	Petrol	154	11/06 → 10/08						
2.8 FSI	Petrol	162	10/08 → 08/11						
2.8 FSI quattro	Petrol	140	10/08 → 08/11						
2.8 FSI quattro	Petrol	154	06/07 → 10/08						
2.8 FSI quattro	Petrol	162	10/08 → 08/11						
3.0	Petrol	160	03/05 → 05/06						
3.0 quattro	Petrol	160	03/05 → 05/06						
3.0 TDI	Diesel	171	06/06 → 08/11						
3.0 TDI quattro	Diesel	155	03/05 → 08/11						
3.0 TDI quattro	Diesel	165	03/05 → 05/06						
3.0 TDI quattro	Diesel	171	06/06 → 10/08						
3.0 TFSI quattro	Petrol	213	10/08 → 08/11						
3.0 TFSI quattro	Petrol	220	10/08 → 08/11						
3.2 FSI	Petrol	188	03/05 → 10/08						
3.2 FSI quattro	Petrol	188	03/05 → 10/08						
4.2 FSI quattro	Petrol	257	06/06 → 08/11						
4.2 quattro	Petrol	246	03/05 → 05/06						
S6 quattro	Petrol	320	03/06 → 08/11						

A6 Avant (4G5, C7, 4GD)

2.0 TDi	Diesel	120	05/11 →						
2.0 TDi	Diesel	130	05/11 →						
2.0 TDi	Diesel	100	01/12 →						
2.0 TFSI	Petrol	132	06/11 →						
2.8 FSI	Petrol	150	05/11 →						
2.8 FSI quattro	Petrol	150	05/11 →						
3.0 TDI	Diesel	150	05/11 →						
3.0 TDI quattro	Diesel	180	05/11 →						
3.0 TDI quattro	Diesel	230	11/11 →						
3.0 TFSI quattro	Petrol	220	05/11 → 05/12						



TYPE



TYPE



TYPE

			SPA111	F1					
						SAG166	H1		
						SAG166	H1		
						SAG155	H1		
			SPA111	F1		SAC073	H2	BAE680BB	
						SAD031	H3		
		RP02A	SPA111	F1				BAE680BB	
			SPA111	F1				BAE680BB	
			SPA111	F1					
			SPA111	F1		SAG090	H1		
						SAG090	H1		
			SPA111	F1					
			SPA111	F1		SAG090	H1		
						SAG090	H1		
			SPA111	F1					
			SPA111	F1					
			SPA111	F1					
			SPA111	F1					
			SPA111	F1					
			SPA109	F1					
			SPA109	F1					
						SAG090	H1		
			SPA111	F1		SAG090	H1		
			SPA111	F1		SAG090	H1		
			SPA111	F1		SAG090	H1		
			SPA111	F1					
			SPA111	F1					
		RP02A	SPA111	F1					
			SPA111	F1					
			SPA111	F1					
			SPA111	F1		SAC073	H2		
			SPA111	F1					
		SPS004	SPA111	F1					
		SPS004	SPA111	F1					
			SPA111	F1					
			SPA111	F1				BAE680BB	
			SPA111	F1					
			SPA111	F1					
			SPA111	F1					
			SPA111	F1					
			SPA111	F1					
			SPA111	F1					
			SPA111	F1					



KW



TYPE



TYPE

AUDI

A6 Avant (4G5, C7, 4GD)

3.0 TFSI quattro	Petrol	228	11/11 →					
S6 quattro	Petrol	309	04/12 →					

A7 Sportback (4GA, 4GF)

2.8 FSI	Petrol	150	02/11 →					
2.8 FSI quattro	Petrol	150	10/10 →					
3.0 TDI	Diesel	150	11/10 →					
3.0 TDI	Diesel	150	11/10 →					
3.0 TDI quattro	Diesel	180	10/10 →					
3.0 TDI quattro	Diesel	180	10/10 →					
3.0 TDI quattro	Diesel	230	11/11 →					
3.0 TFSI quattro	Petrol	220	10/10 →					
3.0 TFSI quattro	Petrol	228	11/11 →					
S7 quattro	Petrol	309	02/12 →					

A8 (4D2, 4D8)

2.5 TDI	Diesel	132	09/00 → 09/02				AMM19769	B4
2.5 TDI quattro	Diesel	110	07/97 → 04/00					
2.5 TDI quattro	Diesel	110	07/97 → 04/00					
2.8	Petrol	120	07/95 → 03/96				AMM19669	B4
2.8	Petrol	128	03/94 → 03/96				AMM19669	B4
2.8	Petrol	142	04/96 → 09/02				AMM19669	B4
2.8	Petrol	142	01/99 → 09/02				AMM19671	B4
2.8	Petrol	128	06/94 → 03/96					
2.8	Petrol	120	07/95 → 03/96	CHASSIS: 4DT000001 →				
2.8	Petrol	128	03/94 → 03/96	CHASSIS: 4DT000001 →				
2.8	Petrol	142	04/96 → 09/02	CHASSIS: 4DT000001 →				
2.8	Petrol	142	10/97 → 09/02					
2.8	Petrol	142	04/96 → 09/02					
2.8	Petrol	142	04/96 → 09/02	CHASSIS: 4DV010966 →				
2.8	Petrol	142	04/96 → 04/97					
2.8	Petrol	142	05/97 → 09/02	CHASSIS: 4DV010966 →				
2.8 quattro	Petrol	120	07/95 → 03/96				AMM19669	B4
2.8 quattro	Petrol	128	03/94 → 03/96				AMM19669	B4
2.8 quattro	Petrol	142	04/96 → 09/02				AMM19669	B4
2.8 quattro	Petrol	142	01/99 → 04/99				AMM19671	B4
2.8 quattro	Petrol	128	09/94 → 03/96					
2.8 quattro	Petrol	120	07/95 → 03/96	CHASSIS: 4DT000001 →				
2.8 quattro	Petrol	128	03/94 → 03/96	CHASSIS: 4DT000001 →				
2.8 quattro	Petrol	142	04/96 → 09/02	CHASSIS: 4DT000001 →				
2.8 quattro	Petrol	142	01/99 → 09/02					
2.8 quattro	Petrol	142	04/96 → 09/02					
2.8 quattro	Petrol	142	04/96 → 04/97					
2.8 quattro	Petrol	142	04/96 → 12/98	CHASSIS: 4DV010966 →				
2.8 quattro	Petrol	142	05/97 → 09/02	CHASSIS: 4DV010966 →				
3.3 TDI quattro	Diesel	165	06/00 → 09/02					



KW



TYPE



TYPE

AUDI

A8 (4D2, 4D8)

3.7	Petrol	169	07/95 → 12/98						
3.7	Petrol	191	11/98 → 02/01						
3.7	Petrol	169	07/95 → 12/98						
3.7	Petrol	191	11/98 → 09/02						
3.7	Petrol	191	11/98 → 09/02						
3.7 quattro	Petrol	169	10/95 → 11/98						
3.7 quattro	Petrol	191	11/98 → 09/02						
3.7 quattro	Petrol	191	11/98 → 09/02						
3.7 quattro	Petrol	169	07/95 → 11/98						
3.7 quattro	Petrol	191	11/98 → 09/02						
3.7 quattro	Petrol	169	07/95 → 11/98						
3.7 quattro	Petrol	169	11/98 → 11/98						
4.2 quattro	Petrol	180	06/94 → 07/96						
4.2 quattro	Petrol	220	06/94 → 11/98						
4.2 quattro	Petrol	175	02/99 → 04/00						
4.2 quattro	Petrol	228	11/98 → 09/02						
4.2 quattro	Petrol	180	03/94 → 07/96						
4.2 quattro	Petrol	220	03/94 → 11/98						
4.2 quattro	Petrol	228	11/98 → 09/02						
4.2 quattro	Petrol	175	02/99 → 04/00						
4.2 quattro	Petrol	180	03/94 → 07/96						
4.2 quattro	Petrol	220	03/94 → 11/98						
4.2 quattro	Petrol	220	11/98 → 11/98						
6.0 W12 quattro	Petrol	309	03/01 → 08/02						
6.0 W12 quattro	Petrol	309	01/01 → 09/02						
S 8 quattro	Petrol	265	06/99 → 09/02						
S 8 quattro	Petrol	265	06/99 → 09/02						
S 8 quattro	Petrol	265	06/99 → 09/02						

A8 (4E_)

2.8 FSI	Petrol	154	08/07 → 07/10						
3.0	Petrol	160	07/03 → 05/06						
3.0	Petrol	162	07/03 → 05/05						
3.0	Petrol	160	07/03 → 05/06						
3.0	Petrol	162	07/03 → 05/05						
3.0 quattro	Petrol	162	08/03 → 05/05						
3.0 TDI quattro	Diesel	155	11/03 → 07/10						
3.0 TDI quattro	Diesel	171	01/04 → 07/10						
3.0 TDI quattro	Diesel	171	08/03 → 07/10						
3.2 FSI	Petrol	191	06/05 → 07/10						
3.2 FSI quattro	Petrol	191	06/05 → 07/10						
3.7 quattro	Petrol	206	11/02 → 05/06						
3.7 quattro	Petrol	206	10/02 → 05/06						
4.0 TDI quattro	Diesel	202	05/03 → 07/05						
4.2 FSI quattro	Petrol	257	06/06 → 07/10						

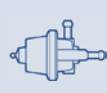

TYPE

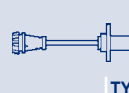

TYPE



TYPE

			RP02A	ATS08	F2	SAA104	SAC084	H2		
			RP02A				SAD019	H3		
				SPA109	F1	SAA104	SAC084	H2		
							SAD019	H3		
			RP02A	ATS08	F2					
			RP02A	SPA109	F1	SAA104	SAC084	H2		
							SAD019	H3		
						SAA104	SAC084	H2		
							SAG056	H1		
							SAD019	H3		
							SAG056	H1		
			RP02A	ATS08	F2					
			RP02A	ATS08	F2					
				SPA109	F1		SAD019	H3		
				SPA109	F1	SAA104	SAD019	H3		
						SAA104	SAC084	H2		
						SAA104	SAC084	H2		
							SAG056	H1		
							SAG056	H1		
							SAD019	H3		
							SAD019	H3		
							SAG056	H1		
			RP02A							
				SPA109	F1		SAC040	H2		
			RP02A	SPA109	F1		SAC084	H2		
							SAD019	H3		
							SAG056	H1		
				SPA111	F1					
			RP02A	SPA109	F1		SAC073	H2	BAE680AC	
			RP02A	SPA109	F1		SAC073	H2		
							SAG096	H1		
							SAG096	H1		
				SPA109	F1					
		APS40		SPA111	F1		SAG090	H1		
		APS40								
				SPA111	F1		SAG090	H1		
				SPA111	F1					
				SPA111	F1					
			RP02A							
				SPA111	F1		SAC084	H2		
		APS40		SPA111	F1		SAG056	H1		
				SPA111	F1					



KW



TYPE



TYPE

AUDI

A8 (4E_)

4.2 quattro	Petrol	246	11/02 → 07/10					
4.2 quattro	Petrol	246	10/02 → 07/10					
4.2 TDI quattro	Diesel	235	01/05 → 06/05					
4.2 TDI quattro	Diesel	240	07/05 → 07/10					
6.0 W12 quattro	Petrol	331	02/04 → 07/10					
6.0 W12 quattro	Petrol	331	12/03 → 07/10					
S8 quattro	Petrol	331	06/06 → 07/10					

A8 (4H_)

2.0 TFSI hybrid	Hybrid	155	02/12 →					
3.0 TDI quattro	Diesel	184	07/10 →					
3.0 TFSI quattro	Petrol	213	07/10 →					
3.0 TFSI quattro	Petrol	228	11/11 →					
3.0 TFSI quattro	Petrol	245	06/10 →					
4.0 TFSI quattro	Petrol	309	03/12 →					
4.2 FSI quattro	Petrol	273	11/09 →					
4.2 TDI quattro	Diesel	258	11/09 →					
6.3 W12 quattro	Petrol	368	01/11 →					
S8 quattro	Petrol	382	04/12 →					

ALLROAD (4BH, C5)

2.5 TDI quattro	Diesel	120	05/03 → 08/05				AMM19769	B4
2.5 TDI quattro	Diesel	132	05/00 → 08/05				AMM19769	B4
2.5 TDI quattro	Diesel	120	05/03 → 08/05					
2.5 TDI quattro	Diesel	132	05/00 → 08/05					
2.7 T quattro	Petrol	184	05/00 → 08/05				AMM19674	B4
2.7 T quattro	Petrol	184	05/00 → 08/05					
2.7 T quattro	Petrol	184	05/00 → 06/02					
4.2 V8 quattro	Petrol	220	07/02 → 08/05					
4.2 V8 quattro	Petrol	220	04/03 → 08/05					

CABRIOLET (8G7, B4)

1.9 TDI	Diesel	66	06/95 → 08/00					
2.0 16V	Petrol	103	06/95 → 07/96	CHASSIS: → 8GX001000				
2.0 16V	Petrol	103	06/95 → 07/96					
2.0 E	Petrol	85	01/93 → 07/98					
2.0 E	Petrol	85	01/93 → 07/98	CHASSIS: → 8GX001000				
2.0 E	Petrol	85	01/93 → 07/98					
2.3 E	Petrol	98	05/91 → 07/94					
2.3 E	Petrol	98	05/91 → 07/94					
2.6	Petrol	102	05/95 → 08/00				AMM19669	B4
2.6	Petrol	110	06/93 → 08/00				AMM19669	B4
2.6	Petrol	110	06/93 → 08/00	CHASSIS: → 8GS001302			B3391	B1
2.6	Petrol	102	05/95 → 08/00	CHASSIS: → 8GT015000				
2.6	Petrol	102	05/95 → 12/99					
2.6	Petrol	110	06/93 → 08/00	CHASSIS: → 8GT015000				
2.6	Petrol	110	01/94 → 08/00					



TYPE

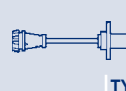

TYPE



TYPE

			RP02A										
				SPA111	F1		SAC084	H2					
				SPA111	F1		SAG056	H1					
				SPA111	F1		SAG056	H1					
			RP02A										
				SPA111	F1		SAC040	H2					
				SPA111	F1								
				SPA111	F1						BAE680BB		
				SPA111	F1								
				SPA111	F1								
				SPA111	F1								
				SPA111	F1	SAA105							
				SPA111	F1								
							SAC011	H2					
				SPA111	F1								
				SGA115	F3		SAG017	H1					
				SGA115	F3		SAG017	H1					
				SPA109	F1								
				SPA109	F1								
			RP02A	SPA109	F1		SAC084	H2					
							SAG018	H1					
				ATS19	F2								
			RP02A				SAC073	H2					
				SPA109	F1								
							SAA104						
							SAA104						
							SAD019	H3					
				SPA106	F1		SAD019	H3			ESS0109A	J1	
							SAA104						
							SAD021	H3					
				SPA125	F1	SAA104	SAD019	H3					
							SAD021	H3					
							SAD019	H3			ESS0109A	J1	
				SPA144	F1								
				SPA143	F1								
				SPA144	F1								
				ATS08	F2								



KW



TYPE



TYPE

AUDI

CABRIOLET (8G7, B4)

2.6	Petrol	110	01/94 → 08/00					
2.6	Petrol	102	05/95 → 08/00	CHASSIS: 8GS000001 → 8GV004000				
2.6	Petrol	110	06/93 → 08/00	CHASSIS: 8GS000001 → 8GV004000				
2.6	Petrol	110	06/93 → 08/00					
2.8	Petrol	128	11/92 → 08/00			AMM19669	B4	
2.8	Petrol	128	11/92 → 08/00					
2.8	Petrol	128	11/92 → 08/00	CHASSIS: 8GS000001 → 8GV004000				
2.8	Petrol	128	11/92 → 08/00					

COUPE (81, 85)

1.6	Petrol	55	07/80 → 08/81					
1.6	Petrol	55	07/80 → 08/81					
1.8	Petrol	55	08/81 → 07/83					
1.8	Petrol	55	08/81 → 07/83					
1.8 GT	Petrol	65	04/86 → 10/88					
1.8 GT	Petrol	65	04/86 → 10/88					
1.8 GT	Petrol	66	09/82 → 10/88					
1.8 GT	Petrol	66	09/82 → 10/88					
1.8 GT	Petrol	79	08/86 → 10/87					
1.8 GT	Petrol	79	08/86 → 10/87					
1.8 GT	Petrol	82	08/86 → 10/88					
1.8 GT	Petrol	82	08/86 → 10/88					
1.9	Petrol	85	08/80 → 07/83					
1.9	Petrol	85	08/80 → 07/83					
2.0	Petrol	83	03/86 → 04/88					
2.0	Petrol	83	03/86 → 04/88					
2.0	Petrol	85	09/83 → 07/86					
2.0	Petrol	85	09/83 → 07/86					
2.1 GT	Petrol	96	09/82 → 10/87					
2.1 GT	Petrol	96	09/82 → 10/87					
2.2 GT	Petrol	100	09/84 → 10/88					
2.2 GT	Petrol	100	09/84 → 10/88					
2.2 GT	Petrol	85	07/81 → 10/87					
2.2 GT	Petrol	85	07/81 → 10/87					
2.2 quattro	Petrol	100	10/84 → 10/88					
2.2 quattro	Petrol	100	10/84 → 10/88					
2.2 quattro	Petrol	88	08/85 → 10/88					
2.2 quattro	Petrol	88	08/85 → 10/88					
2.3	Petrol	100	01/87 → 10/88					
2.3	Petrol	100	01/87 → 10/88					
2.3 quattro	Petrol	100	01/87 → 10/88					
2.3 quattro	Petrol	100	01/87 → 10/88					

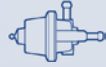

TYPE



TYPE



TYPE

				SPA143	F1				
						SAA104			
						SAA104			
							SAD021	H3	
				SPA143	F1		SAD019	H3	ESS0109A J1
							SAD021	H3	
						SAA104			
							SAG026	H1	
						SAA102			
						SAA104			
						SAA102			
						SAA104			
						SAA102			
						SAA104			
						SAA102			
						SAA104			
						SAA102			ESS0112A J1
						SAA104			
						SAA102			ESS0112A J1
						SAA104			
						SAA102			
						SAA104			
						SAA102			ESS0112A J1
						SAA104			
						SAA102			ESS0112A J1
						SAA104			
						SAA102			ESS0112A J1
						SAA104			
						SAA102			ESS0112A J1
						SAA104			
						SAA102			ESS0112A J1
						SAA104			
						SAA102			ESS0112A J1
						SAA104			
						SAA102			ESS0112A J1
						SAA104			
						SAA102			ESS0112A J1
						SAA104			



KW



TYPE



TYPE

AUDI

COUPE (89, 8B)

2.0	Petrol	82	03/90 → 07/90					
2.0	Petrol	83	05/89 → 03/90					
2.0	Petrol	85	08/90 → 07/91					
2.0	Petrol	85	05/89 → 12/96					
2.0	Petrol	85	05/89 → 12/96					
2.0	Petrol	82	03/90 → 07/90					
2.0	Petrol	83	05/89 → 03/90					
2.0 16 V	Petrol	101	01/92 → 07/92					
2.0 16 V	Petrol	103	08/92 → 12/95					
2.0 16 V	Petrol	101	01/92 → 07/92					
2.0 16 V	Petrol	103	08/92 → 12/96					
2.0 16 V	Petrol	103	08/92 → 12/96					
2.0 20 V quattro	Petrol	118	08/89 → 07/91					
2.0 20 V quattro	Petrol	118	08/89 → 07/91					
2.0 20 V quattro	Petrol	118	07/90 → 07/91					
2.3	Petrol	100	10/88 → 07/94					
2.3	Petrol	98	03/90 → 07/94					
2.3	Petrol	100	10/88 → 07/94					
2.3	Petrol	98	03/90 → 12/96					
2.3	Petrol	98	03/90 → 12/96					
2.3 20V	Petrol	123	08/90 → 07/91					
2.3 20V	Petrol	125	08/89 → 07/91					
2.3 20V	Petrol	123	08/90 → 07/91					
2.3 20V	Petrol	125	08/89 → 07/91					
2.3 20V quattro	Petrol	123	05/90 → 07/91					
2.3 20V quattro	Petrol	125	11/88 → 07/91					
2.3 20V quattro	Petrol	123	05/90 → 12/96					
2.3 20V quattro	Petrol	123	05/90 → 12/96					
2.3 20V quattro	Petrol	125	11/88 → 07/91					
2.3 20V quattro	Petrol	123	07/90 → 07/91					
2.3 20V quattro	Petrol	125	07/90 → 07/91					
2.3 quattro	Petrol	100	11/88 → 12/92					
2.3 quattro	Petrol	98	05/90 → 07/94					
2.3 quattro	Petrol	100	11/88 → 12/92					
2.3 quattro	Petrol	98	05/90 → 12/96					
2.3 quattro	Petrol	98	05/90 → 12/96					
2.6	Petrol	110	08/92 → 12/96			B3391		B1
2.6	Petrol	110	08/92 → 12/96					
2.6	Petrol	110	08/92 → 12/95					
2.6	Petrol	110	08/92 → 12/95					
2.6 quattro	Petrol	110	08/92 → 12/96	CHASSIS: → 8BS000544		B3391		B1
2.6 quattro	Petrol	110	08/92 → 12/95					
2.6 quattro	Petrol	110	08/92 → 12/95					
2.6 quattro	Petrol	110	08/92 → 12/96					



TYPE



TYPE



TYPE

				SPA143	F1		SAD019	H3		
				SPA143	F1		SAD019	H3		
				SPA143	F1					
						SAA102	SAD021	H3		
						SAA104				
							SAD021	H3		
							SAD021	H3		
				SPA143	F1	SAA102	SAD019	H3		
				SPA143	F1					
						SAA104				
						SAA102	SAD019	H3		
						SAA104				
						SAA102				
						SAA104				
									ESS529	J1
				SPA125	F1	SAA102	SAD019	H3		
				SPA125	F1					
						SAA104	SAD021	H3		
						SAA102	SAD019	H3		
						SAA104	SAD021	H3		
				SPA121	F1	SAA102				
				SPA121	F1	SAA102				
						SAA104				
						SAA104				
				SPA121	F1					
				SPA121	F1	SAA102				
						SAA102				
						SAA104				
						SAA104				
									ESS529	J1
									ESS529	J1
				SPA125	F1	SAA102	SAD019	H3		
				SPA125	F1					
						SAA104	SAD021	H3		
						SAA102	SAD019	H3		
						SAA104	SAD021	H3		
				SPA144	F1	SAA102	SAD021	H3		
						SAA104				
				ATS08	F2					
				SPA143	F1					
				ATS08	F2					
				SPA143	F1					
						SAA102	SAD019	H3		



KW



TYPE



TYPE

AUDI

COUPE (89, 8B)

2.6 quattro	Petrol	110	08/92 → 12/96						
2.6 quattro	Petrol	110	08/92 → 12/95						
2.8	Petrol	128	09/91 → 12/96				AMM19669	B4	
2.8	Petrol	128	09/91 → 12/96						
2.8	Petrol	128	09/91 → 12/95						
2.8 quattro	Petrol	128	08/91 → 12/96				AMM19669	B4	
2.8 quattro	Petrol	128	08/91 → 12/95						
2.8 quattro	Petrol	128	08/91 → 12/96						
2.8 quattro	Petrol	128	08/91 → 12/96						
2.8 quattro	Petrol	128	08/91 → 12/95						
S2 quattro	Petrol	162	09/90 → 09/92						
S2 quattro	Petrol	162	09/90 → 09/92						
S2 quattro	Petrol	169	10/92 → 12/96						
S2 quattro	Petrol	169	10/92 → 12/96						
S2 quattro	Petrol	169	10/92 → 12/95						

Q3 (8U)

2.0 TDi	Diesel	100	09/11 →						
2.0 TDi	Diesel	103	09/11 →						
2.0 TDi quattro	Diesel	103	01/12 →						
2.0 TDi quattro	Diesel	120	06/11 →						
2.0 TDi quattro	Diesel	130	06/11 →						
2.0 TFSI quattro	Petrol	125	06/11 →						
2.0 TFSI quattro	Petrol	155	06/11 →						

Q5 (8R)

2.0 TDi	Diesel	100	11/10 →						
2.0 TDi	Diesel	105	11/10 →						
2.0 TDi quattro	Diesel	105	08/09 →						
2.0 TDi quattro	Diesel	125	11/08 →						
2.0 TDi quattro	Diesel	100	08/09 →						
2.0 TDi quattro	Diesel	120	11/08 →						
2.0 TFSI hybrid quattro	Hybrid	155	06/11 →						
2.0 TFSI quattro	Petrol	132	08/09 →						
2.0 TFSI quattro	Petrol	155	11/08 →						
3.0 TDi quattro	Diesel	176	11/08 →						
3.2 FSI quattro	Petrol	199	11/08 →						
3.2 FSI quattro	Petrol	199	11/08 → 08/09						

Q7 (4L)

3.0 TDi	Diesel	150	05/10 →						
3.0 TDi	Diesel	155	03/06 → 05/10						
3.0 TDi	Diesel	165	06/09 → 05/12						
3.0 TDi	Diesel	171	03/06 → 05/08						
3.0 TDi	Diesel	176	11/07 →						
3.0 TFSI	Petrol	200	05/10 →						
3.0 TFSI	Petrol	206	05/11 →						

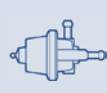

TYPE

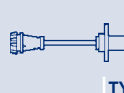

TYPE



TYPE

						SAA104	SAD021	H3			
										ESS529	J1
				SPA144	F1	SAA102	SAD021	H3			
						SAA104	SAG026	H1			
				SPA143	F1						
						SAA102	SAD019	H3			
				SPA143	F1						
						SAA104	SAD021	H3			
							SAG026	H1			
										ESS529	J1
		RP03A		SPA121	F1	SAA102	SAD019	H3		ESS529	J1
						SAA104					
						SAA102	SAD019	H3			
						SAA104	SAD021	H3			
										ESS529	J1
				SPA111	F1						
				SPA111	F1						
				SPA111	F1						
				SPA111	F1						
				SPA111	F1						
				SPA111	F1				BAE680BB		
				SPA111	F1				BAE680BB		
		SPS004		SPA111	F1						
		SPS004		SPA111	F1						
		SPS004		SPA111	F1		SAG155	H1			
		SPS004		SPA111	F1		SAG155	H1		ESS0080A	J1
				SPA111	F1						
				SPA111	F1						
				SPA111	F1				BAE680BB		
				SPA111	F1						
				SPA111	F1				BAE680BB		
										ESS0080A	J1
				SPA111	F1						
										BAE680BB	
				SPA111	F1						
				SPA111	F1					ESS0003A	J1
				SPA111	F1						
				SPA111	F1					ESS0003A	J1
				SPA111	F1						
				SPA111	F1						
				SPA111	F1						



KW



TYPE



TYPE

AUDI

Q7 (4L)

3.0 TFSI	Petrol	245	05/10 →
3.6 FSI	Petrol	206	08/06 → 05/10
3.6 FSI	Petrol	206	08/06 → 05/10
4.2 FSI	Petrol	257	03/06 → 05/10
4.2 TDI	Diesel	240	03/07 → 06/09
4.2 TDI	Diesel	250	05/09 →
4.2 TDI	Diesel	250	06/09 →

QUATTRO (85)

2.1 20V Turbo	Petrol	225	05/84 → 07/87
2.1 20V Turbo	Petrol	225	05/84 → 07/87
2.1 Turbo	Petrol	147	07/80 → 07/87
2.1 Turbo	Petrol	147	07/80 → 07/87
2.2 20V Turbo	Petrol	162	08/89 → 07/91
2.2 20V Turbo	Petrol	162	08/89 → 07/91
2.2 Turbo	Petrol	147	08/87 → 07/89
2.2 Turbo	Petrol	147	08/87 → 07/89

R8

4.2 FSI quattro	Petrol	309	04/07 → 09/10
4.2 FSI quattro	Petrol	316	09/10 →
5.2 FSI quattro	Petrol	412	11/10 → 10/12

R8 Spyder

4.2 FSI quattro	Petrol	316	09/10 →
-----------------	--------	-----	---------

TT (8J3)

1.8 TFSI	Petrol	118	06/08 →
2.0 quattro	Petrol	195	05/08 →
2.0 TDI quattro	Diesel	125	06/08 →
2.0 TFSI	Petrol	147	08/06 → 06/10
2.0 TFSI quattro	Petrol	147	06/08 → 06/10
2.0 TFSI quattro	Petrol	200	05/08 →
2.5 TFSI RS quattro	Petrol	250	07/09 →
2.5 TFSI RS quattro	Petrol	265	05/11 →
3.2 V6 quattro	Petrol	184	08/06 → 06/10
3.2 V6 quattro	Petrol	184	08/06 → 06/10
3.2 V6 quattro	Petrol	184	08/06 → 06/10

TT (8N3)

1.8 T	Petrol	110	09/02 → 06/06	
1.8 T	Petrol	132	10/98 → 06/06	
1.8 T	Petrol	110	09/02 → 06/06	
1.8 T	Petrol	110	09/02 → 06/06	
1.8 T	Petrol	120	09/05 → 06/06	
1.8 T	Petrol	132	10/98 → 06/06	
1.8 T	Petrol	132	10/98 → 06/06	CHASSIS: 8NY000001 →
1.8 T	Petrol	140	09/05 → 06/06	
1.8 T	Petrol	132	10/98 → 06/06	



TYPE

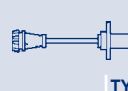

TYPE



TYPE

				SPA111	F1								
				SPA111	F1		SAC011	H2	BAE680BC				
							SAD031	H3					
				SPA111	F1								
				SPA111	F1								
				ATS16	F2								
				SPA111	F1								
							SAA102						
							SAA104						
							SAA102				ESS0103A	J1	
							SAA104						
			RP03A	SPA121	F1	SAA102	SAD021	H3					
						SAA104							
						SAA102							
						SAA104							
				SPA111	F1								
				SPA111	F1						BAE680BB		
				SPA111	F1								
				SPA111	F1								
				SPA111	F1						BAE680BB		
				SPA111	F1						BAE680BB		
				SPA111	F1		SAG155	H1					
				SPA111	F1						BAE680BB		
				SPA111	F1						BAE680BB		
				SPA111	F1						BAE680BB		
				SPA111	F1						BAE680BB		
				SPA111	F1						BAE680BB		
				SPA111	F1		SAC011	H2					
							SAD031	H3					
							SAG065	H1					
	APS39		ATS19	F2		SAC084	H2	BAE680AW	GA2138	J2			
	APS39		ATS19	F2		SAC084	H2	BAE680AW	ESS0016A	J1			
			SPA109	F1		SAD031	H3						
						SAG178	H1						
			SPA109	F1		SAD031	H3						
						SAD031	H3		GA2138	J2			
			SPA109	F1									
			SPA109	F1		SAD031	H3						
						SAG018	H1						



KW



TYPE



TYPE

AUDI

TT (8N3)

1.8 T quattro	Petrol	132	10/98 → 05/05						
1.8 T quattro	Petrol	165	10/98 → 01/01						
1.8 T quattro	Petrol	132	10/98 → 06/06						
1.8 T quattro	Petrol	132	10/98 → 06/06	CHASSIS: 8NY000001 →					
1.8 T quattro	Petrol	140	09/05 → 06/06						
1.8 T quattro	Petrol	165	10/98 → 06/06						
1.8 T quattro	Petrol	165	10/98 → 06/06	CHASSIS: 8NY000001 →					
1.8 T quattro	Petrol	176	03/05 → 06/06						
1.8 T quattro	Petrol	132	10/98 → 06/06						
1.8 T quattro	Petrol	132	10/98 → 06/06						
1.8 T quattro	Petrol	165	10/98 → 06/06						
1.8 T quattro	Petrol	165	10/98 → 06/06						
1.8 T quattro	Petrol	165	09/02 → 06/06						
3.2 VR6 quattro	Petrol	184	07/03 → 06/06						
3.2 VR6 quattro	Petrol	184	07/03 → 06/06						
3.2 VR6 quattro	Petrol	184	07/03 → 06/06						

TT Roadster (8J9)

1.8 TFSI	Petrol	118	06/08 →						
2.0 quattro	Petrol	195	05/08 →						
2.0 TDI quattro	Diesel	125	06/08 →						
2.0 TFSI	Petrol	147	03/07 → 06/10						
2.0 TFSI quattro	Petrol	147	06/08 → 06/10						
2.0 TFSI quattro	Petrol	200	05/08 →						
2.5 TFSI quattro	Petrol	265	03/12 →						
2.5 TFSI RS quattro	Petrol	250	07/09 →						
3.2 V6 quattro	Petrol	184	03/07 → 06/10						
3.2 V6 quattro	Petrol	184	03/07 → 06/10						
3.2 V6 quattro	Petrol	184	03/07 → 06/10						

TT Roadster (8N9)

1.8 T	Petrol	110	01/01 → 06/06						
1.8 T	Petrol	132	10/99 → 06/06						
1.8 T	Petrol	110	01/01 → 06/06						
1.8 T	Petrol	110	01/01 → 06/06						
1.8 T	Petrol	120	09/05 → 06/06						
1.8 T	Petrol	132	10/99 → 06/06						
1.8 T	Petrol	132	10/99 → 06/06	CHASSIS: 8NY000001 →					
1.8 T	Petrol	140	09/05 → 06/06						
1.8 T	Petrol	132	10/99 → 06/06						
1.8 T quattro	Petrol	132	02/00 → 06/06						
1.8 T quattro	Petrol	165	10/99 → 01/01						
1.8 T quattro	Petrol	132	02/00 → 06/06						
1.8 T quattro	Petrol	132	02/00 → 06/06	CHASSIS: 8NY000001 →					
1.8 T quattro	Petrol	140	09/05 → 06/06						
1.8 T quattro	Petrol	165	10/99 → 06/06						

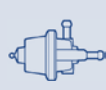

TYPE

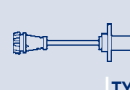

TYPE



TYPE

APS39
APS39
ATS19 F2 **SAC084** H2

SPA109 F1

SPA109 F1 **SAD031** H3

ATS19 F2 **SAC084** H2

SPA109 F1

SPA109 F1 **SAD031** H3

SAD031 H3

SAG018 H1

SAD031 H3

SAG018 H1

SAG096 H1

SPA109 F1 **SAC040** H2 **BAE680BC**
SAD031 H3

SAG065 H1

SPA111 F1 **BAE680BB**
SPA111 F1 **BAE680BB**
SPA111 F1 **SAA105** **SAG155** H1

SPA111 F1 **BAE680BB**
SPA111 F1 **BAE680BB**
SPA111 F1 **BAE680BB**
SPA111 F1 **BAE680BB**
SPA111 F1 **BAE680BB**
SPA111 F1 **SAC011** H2

SAD031 H3

SAG065 H1

APS39 **ATS19** F2 **SAC084** H2 **ESS0016A** J1

APS39 **ATS19** F2 **SAC084** H2 **ESS0016A** J1

SPA109 F1 **SAD031** H3

SAG178 H1

SPA109 F1

SAD031 H3

SPA109 F1

SPA109 F1 **SAD031** H3

SAG018 H1

APS39 **ATS19** F2 **SAC084** H2

APS39 **SAD031** H3

SPA109 F1

SPA109 F1 **SAD031** H3

ATS19 F2 **SAC084** H2



KW

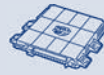

TYPE



TYPE

AUDI

TT Roadster (8N9)

1.8 T quattro	Petrol	165	10/99 → 06/06	CHASSIS: 8NY000001 →					
1.8 T quattro	Petrol	132	02/00 → 06/06						
1.8 T quattro	Petrol	165	10/99 → 06/06						
1.8 T quattro	Petrol	165	10/99 → 06/06						
1.8 T quattro	Petrol	165	09/02 → 06/06						
3.2 VR6 quattro	Petrol	184	07/03 → 06/06						
3.2 VR6 quattro	Petrol	184	07/03 → 06/06						
3.2 VR6 quattro	Petrol	184	07/03 → 06/06						

V8 (44_, 4C_)

3.6 quattro	Petrol	180	04/93 → 02/94						
3.6 quattro	Petrol	184	10/88 → 02/94						
3.6 quattro	Petrol	180	04/93 → 11/93						
3.6 quattro	Petrol	184	10/88 → 11/93						
4.2 quattro	Petrol	206	10/91 → 02/94						
4.2 quattro	Petrol	206	10/91 → 11/93						

AUTOBIANCHI

Y10

1.0	Petrol	41	01/95 → 10/95						
1.0 4WD	Petrol	37	07/89 → 10/95						
1.0 Cat.	Petrol	33	10/87 → 09/92						
1.1	Petrol	42	08/89 → 06/92						
1.1 4WD	Petrol	42	08/89 → 06/92						
1.1 i.e. Cat.	Petrol	42	09/90 → 06/92						

BENTLEY

AZURE

6.75 V8	Petrol	286	09/95 → 08/99						
---------	--------	-----	---------------	--	--	--	--	--	--

CONTINENTAL

6.75 V8 S	Petrol	286	05/94 → 12/95						
-----------	--------	-----	---------------	--	--	--	--	--	--

BMW

1 (E81)

116 i	Petrol	85	03/07 → 09/12						
116 i	Petrol	85	09/07 → 12/11						
116 i	Petrol	90	09/07 → 11/11						
116 i	Petrol	90	03/09 → 12/11						
118 i	Petrol	95	09/06 → 09/12						
118 i	Petrol	105	05/07 → 12/11						
118 i	Petrol	95	05/07 → 12/11						
120 i	Petrol	110	09/06 → 09/12						
120 i	Petrol	110	05/07 → 12/11						
120 i	Petrol	115	05/07 → 10/11						
120 i	Petrol	120	05/07 → 12/11						

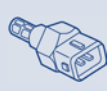

TYPE



TYPE



TYPE

SPA109

F1

SAG018

H1

SAD031

H3

SAG018

H1

SAG096

H1

SPA109

F1

SAC040

H2

SAD031

H3

SAG065

H1

SPA121

F1

SAA102

SPA121

F1

SAA102

ESS529

J1

ESS529

J1

SPA121

F1

SAA102

ESS529

J1

ESS514

J1

ESS514

J1

ESS514

J1

ESS514

J1

ESS514

J1

ESS514

J1

APS29

APS29

SAG151

H1

BAE680AH

BAE680BS

BAE680BS

SAG151

H1

BAE680BS

BAE680BS

SAG151

H1

BAE680BS

BAE680AH

BAE680BS



KW



TYPE



TYPE

BMW

1 (E81)

120 i	Petrol	125	05/07 → 12/11
130 i	Petrol	190	09/09 → 12/11
130 i	Petrol	195	09/06 → 09/12

1 Cabriolet (E88)

118 i	Petrol	105	03/08 → 02/12
120 i	Petrol	120	03/08 → 02/12
120 i	Petrol	125	03/08 → 02/12
125 i	Petrol	160	03/08 →
135 i	Petrol	225	03/08 →

1 Coupé (E82)

120 i	Petrol	125	09/09 → 02/12
125 i	Petrol	160	03/08 →
135 i	Petrol	225	10/07 →
M	Petrol	250	04/11 → 06/12

2500-3.3 (E3)

3.0 si	Petrol	143	10/75 → 04/77
3.2 Li	Petrol	147	10/75 → 04/77

3 (E21)

318 i	Petrol	77	11/79 → 08/82
320 i	Petrol	92	06/75 → 08/82
323 i	Petrol	105	01/78 → 08/82

3 (E30)

316 (Ecotronic)	Petrol	66	09/83 → 12/90
316 i	Petrol	73	09/88 → 06/91
316 i	Petrol	75	09/88 → 06/91
316 i	Petrol	73	09/87 → 06/91
316 i	Petrol	75	07/88 → 06/91
316 i	Petrol	73	04/89 → 06/91
316 i	Petrol	75	04/89 → 06/91
318 i	Petrol	83	09/87 → 06/91
318 i	Petrol	85	09/87 → 06/91
318 i	Petrol	75	12/84 → 08/88
318 i	Petrol	77	09/82 → 08/87
318 i	Petrol	83	09/87 → 06/91
318 i	Petrol	85	09/87 → 06/91
318 i	Petrol	83	04/89 → 06/91
318 i	Petrol	85	04/89 → 06/91
318 is	Petrol	100	09/89 → 08/91
320 i	Petrol	110	12/85 → 06/90
320 i	Petrol	92	09/82 → 12/85
320 i	Petrol	95	12/85 → 06/91
320 i	Petrol	95	10/87 → 06/91
320 i	Petrol	95	12/85 → 06/91
320 is	Petrol	141	05/88 → 12/90

SVF012

B6

SVF012

B6

SVF012

B6

SVF012

B6

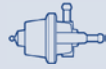

TYPE



TYPE



TYPE

BAE680BS

BAE680BR

BAE680BR

BAE680BS

BAE680BS

BAE680BS

BAE680BR

BAE680BR

BAE680BS

BAE680BR

BAE680BR

BAE680BR

PI024

J1

PI024

J1

ESS0171A

J1

ESS0171A

J1

ESS0171A

J1

SPA104

F1

SPA104

F1

ESS0129A

J1

SPA104

F1

ESS0129A

J1

SAG073

H1

SAG073

H1

SPA104

F1

ESS0129A

J1

SPA104

F1

ESS0129A

J1

SPA104

F1

ESS0171A

J1

PI024

J1

PI024

J1

SAG073

H1

SAG073

H1

RP06A

SAC017

H2

BAE680DN

ESS0129A

J1

SPA104

F1

SPA104

F1

PI024

J1

SPA104

F1

ESS0129A

J1

SAG073

H1

PI024

J1

ESS0129A

J1



KW



TYPE



TYPE

BMW

3 (E30)

323 i	Petrol	110	09/84 → 08/86						
323 i	Petrol	102	09/82 → 08/83						
323 i	Petrol	110	09/83 → 08/86						
324 d	Diesel	63	09/88 → 12/90						
324 td	Diesel	85	09/87 → 12/90						
325 e 2.7	Petrol	90	12/86 → 12/88						
325 e 2.7	Petrol	95	12/86 → 08/87						
325 e 2.7	Petrol	90	10/83 → 12/88						
325 e 2.7	Petrol	90	10/83 → 12/88						
325 e 2.7	Petrol	95	01/85 → 08/87						
325 i	Petrol	125	12/86 → 06/91						
325 i	Petrol	126	12/86 → 11/89						
325 i	Petrol	125	12/86 → 09/87						
325 i	Petrol	125	10/87 → 06/91						
325 i	Petrol	126	09/83 → 09/87						
325 i	Petrol	126	10/87 → 11/89						
325 i	Petrol	125	12/86 → 06/91						
325 i	Petrol	126	09/83 → 11/89						
325 i	Petrol	126	09/83 → 11/89						
325 i X	Petrol	125	12/86 → 08/91						
325 i X	Petrol	126	03/86 → 12/87						
325 i X	Petrol	125	12/86 → 09/87						
325 i X	Petrol	125	10/87 → 08/91						
325 i X	Petrol	126	03/86 → 09/87						
325 i X	Petrol	126	10/87 → 12/87						
325 i X	Petrol	125	12/86 → 08/91						
325 i X	Petrol	126	03/86 → 12/87						
M3 2.3	Petrol	143	07/86 → 06/91						
M3 2.3	Petrol	147	02/87 → 05/89						
M3 2.3	Petrol	158	06/89 → 06/91						
M3 2.3	Petrol	143	07/86 → 06/91						
M3 2.3	Petrol	158	06/89 → 06/91						

3 (E36)

316 i	Petrol	73	09/90 → 09/93						
316 i	Petrol	75	09/90 → 09/93						
316 i	Petrol	75	07/93 → 09/95						
316 i	Petrol	75	07/93 → 02/98						
316 i	Petrol	75	07/93 → 09/95						
316 i	Petrol	75	10/95 → 02/98						
316 i	Petrol	75	09/93 → 02/98						
316 i	Petrol	73	09/90 → 12/90						
316 i	Petrol	75	09/90 → 12/90						
318 i	Petrol	83	12/90 → 10/93						
318 i	Petrol	85	10/93 → 09/95						

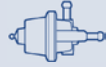

TYPE



TYPE



TYPE

			SPA104	F1								
											PI024	J1
											PI024	J1
			SPA164	F1								
			SPA164	F1								
			SPA104	F1								
			SPA104	F1								
											ESS0129A	J1
											PI024	J1
											PI024	J1
			SPA104	F1							ESS0129A	J1
			SPA104	F1								
							SAG045	H1				
							SAG073	H1				
							SAG045	H1				
							SAG073	H1				
											PI024	J1
											ESS0129A	J1
											PI024	J1
			SPA104	F1							ESS0129A	J1
			SPA104	F1							ESS0129A	J1
							SAG045	H1				
							SAG073	H1				
							SAG045	H1				
							SAG073	H1				
											PI024	J1
											PI024	J1
			SPA104	F1							ESS0129A	J1
			SPA104	F1							PI024	J1
			SPA104	F1							ESS0129A	J1
											PI024	J1
											PI024	J1
		RP06A	SPA104	F1			SAG062	H1				
		RP06A	SPA104	F1			SAG062	H1				
			SPA104	F1			SAC050	H2				
							SAG151	H1			ESS524	J1
							SAG099	H1				
							SAG104	H1				
										BAE680AB		
											ESS524	J1
											ESS524	J1
		RP06A	SPA104	F1			SAG062	H1				
			SPA104	F1			SAC050	H2				



KW



TYPE



TYPE

BMW

3 (E36)

318 i	Petrol	85	10/93 → 09/95						
318 i	Petrol	85	10/95 → 02/98						
318 i	Petrol	85	10/93 → 02/98						
318 is	Petrol	103	03/93 → 02/98						
318 is	Petrol	103	03/93 → 09/93						
318 is	Petrol	103	10/93 → 02/98						
318 is	Petrol	103	10/93 → 02/98						
318 is	Petrol	103	10/93 → 12/96						
318 is	Petrol	103	09/95 → 02/98						
318 is	Petrol	103	06/93 → 09/97						
318 is	Petrol	103	12/95 → 02/98						
320 i	Petrol	110	09/90 → 02/98						
320 i	Petrol	110	09/90 → 09/92						
320 i	Petrol	110	09/90 → 09/95						
320 i	Petrol	110	10/92 → 02/98						
320 i	Petrol	110	10/92 → 12/95						
320 i	Petrol	110	09/90 → 02/98	ENGINE: M50B(206S2) VANOS, M52B(206S3)					
320 i	Petrol	110	09/90 → 09/92						
320 i	Petrol	110	09/94 → 02/98						
323 i 2.5	Petrol	125	03/95 → 02/98						
328 i	Petrol	142	01/95 → 02/98						
M3 3.0	Petrol	210	08/94 → 09/95						
M3 3.0	Petrol	210	08/94 → 09/95						
M3 3.2	Petrol	236	09/95 → 02/98						

3 (E46)

316 i	Petrol	77	04/00 → 02/05						
316 i	Petrol	77	09/98 → 02/05						
316 i	Petrol	77	09/98 → 02/05						
316 i	Petrol	85	02/02 → 02/05						
316 i	Petrol	85	06/02 → 02/05						
316 i	Petrol	77	04/00 → 09/02						
316 i	Petrol	77	09/98 → 09/02						
316 i	Petrol	85	03/03 → 02/05						
318 d	Diesel	85	03/03 → 02/05						
318 d	Diesel	85	09/01 → 03/03						
318 d	Diesel	85	09/01 → 03/03						
318 i	Petrol	105	09/01 → 02/05						
318 i	Petrol	87	02/98 → 09/01						
318 i	Petrol	87	02/98 → 09/01						
318 i	Petrol	105	03/03 → 02/05						
318 i	Petrol	87	04/98 → 09/01						
320 d	Diesel	100	04/98 → 09/01						
320 d	Diesel	110	09/01 → 02/05						



TYPE



TYPE



TYPE

						SAG099	H1			
						SAG104	H1			
								BAE680AB		
			SPA104	F1						
						SAC034	H2			
						SAC050	H2			
						SAG099	H1			
								BAE680AB		
								BAE680AB		
									ESS524	J1
									ESS524	J1
			RP06A			SAG075	H1	BAE680DN	ESS524	J1
				ATS11	F2	SAC042	H2			
				SPA104	F1					
				ATS09	F2					
				SPA132	F1					
						SAG115	H1			
						SAG087	H1			
						SAG111	H1			
						SAG111	H1		ESS524	J1
						SAG111	H1		ESS524	J1
				ATS11	F2			BAE680DN		
				SPA104	F1					
				ATS11	F2					
				SGA113	F3	SAG144	H1		ESS0082A	J1
				SGA113	F3	SAG144	H1		ESS0082A	J1
				SPA112	F1					
				SGA113	F3	SAG151	H1		ESS0082A	J1
						SAG151	H1	BAE680AH		
								BAE680AB		
								BAE680AB		
								BAE680AH		
	APS32			ATS15	F2				ESS0059A	J1
	APS30			SGA113	F3				ESS0059A	J1
									PI025	J1
				SGA113	F3	SAG151	H1		ESS0082A	J1
				SGA113	F3	SAG144	H1		ESS0082A	J1
				SPA112	F1					
								BAE680AH		
								BAE680AB		
	APS30			SGA113	F3				ESS0059A	J1
	APS32			ATS15	F2				ESS0059A	J1



KW



TYPE



TYPE

BMW

3 (E46)

320 d	Diesel	100	04/98 → 09/01						
320 d	Diesel	110	09/01 → 02/05						
320 i	Petrol	110	03/98 → 09/00						
320 i	Petrol	110	03/98 → 09/00						
320 i	Petrol	125	09/00 → 02/05						
320 i	Petrol	125	09/00 → 02/05						
320 i	Petrol	125	10/02 → 02/05						
323 i	Petrol	125	03/98 → 09/00						
323 i	Petrol	125	03/98 → 09/00						
325 i	Petrol	141	09/00 → 02/05						
325 i	Petrol	141	09/00 → 02/05						
325 xi	Petrol	141	09/00 → 02/05						
325 xi	Petrol	141	09/00 → 02/05						
328 i	Petrol	142	02/98 → 06/00						
328 i	Petrol	142	02/98 → 06/00						
330 d	Diesel	135	10/99 → 02/05						
330 d	Diesel	150	03/03 → 02/05						
330 d	Diesel	135	10/99 → 02/05						
330 d	Diesel	150	03/03 → 02/05						
330 i	Petrol	170	06/00 → 02/05						
330 i	Petrol	170	06/00 → 02/05						
330 xd	Diesel	135	06/00 → 02/05						
330 xd	Diesel	150	03/03 → 02/05						
330 xd	Diesel	135	06/00 → 02/05						
330 xd	Diesel	150	03/03 → 02/05						
330 xi	Petrol	170	06/00 → 02/05						
330 xi	Petrol	170	06/00 → 02/05						

3 (E90)

316 i	Petrol	85	02/06 → 12/11						
316 i	Petrol	85	02/06 → 10/11						
316 i	Petrol	90	09/07 → 10/11						
318 d	Diesel	105	09/05 → 12/11				TB0019		B3
318 d	Diesel	90	09/05 → 12/11						
318 i	Petrol	105	09/07 → 12/11						
318 i	Petrol	95	09/05 → 03/07						
318 i	Petrol	105	09/07 → 10/11						
320 d	Diesel	130	09/07 → 12/11				TB0019		B3
320 d	Diesel	135	01/10 → 12/11				TB0019		B3
320 d	Diesel	120	01/05 → 12/11						
320 i	Petrol	110	01/05 → 03/07						
320 i	Petrol	110	03/05 → 03/07						
320 i	Petrol	115	03/07 → 12/11						
320 i	Petrol	125	09/07 → 12/11						
320 si	Petrol	127	05/06 → 12/11						



TYPE

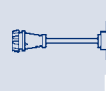

TYPE



TYPE

										PI025	J1
			SGA113	F3						PI025	J1
			SGA113	F3		SAC076	H2			ESS0082A	J1
			SPA112	F1		SAG144	H1				
			SGA113	F3		SAC076	H2			ESS0082A	J1
			SPA112	F1		SAG144	H1				
									BAE680AH		
			SGA113	F3		SAC076	H2			ESS0082A	J1
			SPA112	F1		SAG144	H1				
			SGA113	F3		SAC076	H2	BAE680AH		ESS0082A	J1
						SAG144	H1				
			SGA113	F3		SAC076	H2	BAE680AH		ESS0082A	J1
						SAG144	H1				
			SGA113	F3		SAC076	H2			ESS0082A	J1
			SPA112	F1		SAG144	H1				
		APS30	SGA113	F3						ESS0059A	J1
		APS32	ATS15	F2						ESS0059A	J1
										PI025	J1
			SGA113	F3							
			SGA113	F3		SAC076	H2	BAE680AH		ESS0082A	J1
						SAG144	H1				
		APS30	SGA113	F3						ESS0059A	J1
		APS32	ATS15	F2						ESS0059A	J1
										PI025	J1
			SGA113	F3							
			SGA113	F3		SAC076	H2	BAE680AH		ESS0082A	J1
						SAG144	H1				
						SAG151	H1				
									BAE680AH		
									BAE680BS		
										PI025	J1
						SAG151	H1				
						SAG151	H1	BAE680AH			
								BAE680BS			
		APS32									
						SAG151	H1				
									BAE680AH		
									BAE680AH		
									BAE680BS		
						SAG151	H1				



KW



TYPE



TYPE

BMW

3 (E90)

320 si	Petrol	127	05/06 → 09/06						
323 i	Petrol	130	04/06 → 04/06						
323 i	Petrol	130	05/06 → 12/11						
325 i	Petrol	160	01/05 → 12/11						
325 i	Petrol	160	03/05 → 04/06						
325 i	Petrol	160	09/07 → 12/11						
325 i xDrive	Petrol	160	09/08 → 10/11						
325 xi	Petrol	160	01/05 → 12/11						
325 xi	Petrol	160	09/05 → 04/06						
325 xi	Petrol	160	09/07 → 08/08						
330 i	Petrol	190	01/05 → 12/11						
330 i	Petrol	200	09/07 → 12/11						
330 i	Petrol	200	09/07 → 10/11						
330 i xDrive	Petrol	200	09/08 → 10/11						
330 xi	Petrol	190	01/05 → 12/11						
330 xi	Petrol	190	05/06 → 09/07						
330 xi	Petrol	200	09/07 → 08/08						
335 i	Petrol	225	09/06 → 12/11						
335 i xDrive	Petrol	225	09/08 → 12/11						
335 xi	Petrol	225	09/07 → 12/11						

3 Cabriolet (E30)

318 i	Petrol	83	09/90 → 10/93				SVF012	B6	
320 i	Petrol	95	04/86 → 10/93						
320 i	Petrol	95	10/87 → 10/93						
320 i	Petrol	95	04/86 → 10/93						
325 i	Petrol	125	09/87 → 10/93						
325 i	Petrol	126	12/86 → 12/87						
325 i	Petrol	125	09/87 → 10/93						
325 i	Petrol	126	12/85 → 09/87						
325 i	Petrol	126	10/87 → 12/87						
325 i	Petrol	126	12/85 → 12/87						
325 i	Petrol	126	12/85 → 12/87						
M3 2.3	Petrol	143	06/88 → 06/91						

3 Cabriolet (E36)

318 i	Petrol	85	01/94 → 09/95						
318 i	Petrol	85	01/94 → 09/95						
318 i	Petrol	85	10/95 → 04/99						
318 i	Petrol	85	01/94 → 04/99						
320 i	Petrol	110	12/93 → 12/95						
320 i	Petrol	110	12/93 → 12/95						
320 i	Petrol	110	12/93 → 04/99						
320 i	Petrol	110	12/93 → 04/99	ENGINE: M50B,M52B					
320 i	Petrol	110	09/94 → 09/98						
320 i	Petrol	110	12/98 → 04/99						



TYPE



TYPE



TYPE

BAE680AH
 BAE680BP
 BAE680BR
 BAE680BR
 BAE680BP
 BAE680BS
 BAE680BS
 BAE680BR
 BAE680BP
 BAE680BS
 BAE680BP
 BAE680BS
 BAE680BS
 BAE680BP
 BAE680BR
 BAE680BS
 BAE680BR
 BAE680BR
 BAE680BR

SPA104

F1

SAG073

H1

ESS0129A

J1

SPA104

F1

SAG073

H1

ESS0129A

J1

PI024

J1

SPA104

F1

SAG073

H1

ESS0129A

J1

SPA104

F1

PI024

J1

SAG045

H1

SAG073

H1

ESS0129A

J1

PI024

J1

PI024

J1

SPA104

F1

SAC050

H2

SAG099

H1

SAG104

H1

BAE680AB

RP06A

ATS09

F2

SPA132

F1

SAG075

H1

BAE680DN

ESS524

J1

SAG115

H1

SAG111

H1

SAG144

H1



KW



TYPE



TYPE

BMW

3 Cabriolet (E36)

323 i	Petrol	125	06/95 → 04/99						
323 i	Petrol	125	06/95 → 09/98						
323 i	Petrol	125	12/98 → 04/99						
325 i	Petrol	141	03/93 → 03/95						
325 i	Petrol	141	03/93 → 03/95						
328 i	Petrol	142	03/95 → 04/99						
328 i	Petrol	142	03/95 → 09/98						
328 i	Petrol	142	12/98 → 04/99						
M3 3.0	Petrol	210	01/94 → 10/95						
M3 3.2	Petrol	236	10/95 → 04/99						

3 Cabriolet (E46)

318 Ci	Petrol	105	09/01 →						
318 Ci	Petrol	110	02/05 →						
318 Ci	Petrol	105	03/03 → 03/04						
318 Ci	Petrol	110	02/05 → 08/06						
320 Cd	Diesel	110	02/05 →						
320 Ci	Petrol	125	09/00 →						
320 Ci	Petrol	125	09/00 →						
320 Ci	Petrol	125	10/02 → 08/06						
323 Ci	Petrol	125	04/00 → 09/00						
323 Ci	Petrol	125	04/00 → 09/00						
325 Ci	Petrol	141	09/00 →						
330 Cd	Diesel	150	08/05 →						
330 Ci	Petrol	170	06/00 →						
330 Ci	Petrol	170	06/00 →						
M3 3.2	Petrol	252	04/01 →						

3 Cabriolet (E93)

318i	Petrol	105	03/10 → 02/12						
320 d	Diesel	130	03/07 →				TB0019		B3
320 i	Petrol	110	03/07 → 08/07						
320 i	Petrol	125	03/07 → 02/12						
323 i	Petrol	130	03/07 →						
325 i	Petrol	160	03/07 →						
325 i	Petrol	160	03/07 → 02/12						
330 i	Petrol	190	03/07 →						
330 i	Petrol	200	03/07 → 02/12						
335 i	Petrol	225	03/07 →						

3 Compact (E36)

316 g	BiFuel	75	03/94 → 08/00						
316 i	Petrol	75	03/94 → 09/95						
316 i	Petrol	77	12/98 → 08/00						
316 i	Petrol	75	03/94 → 09/95						
316 i	Petrol	75	10/95 → 08/00						
316 i	Petrol	75	03/94 → 08/00						



TYPE

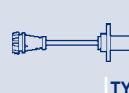

TYPE



TYPE

						SAG115	H1		ESS524	J1
						SAG111	H1			
						SAG144	H1			
		RP05A	ATS11	F2		SAG087	H1	BAE680DN	ESS524	J1
			SPA104	F1						
						SAG115	H1		ESS524	J1
						SAG111	H1			
						SAG144	H1			
			ATS11	F2				BAE680DN		
			ATS11	F2						
			SGA113	F3		SAG151	H1		ESS0082A	J1
						SAG151	H1			
								BAE680AH		
								BAE680AH		
	APS32		ATS15	F2					ESS0059A	J1
			SGA113	F3		SAC076	H2		ESS0082A	J1
						SAG144	H1			
								BAE680AH		
			SGA113	F3		SAC076	H2		ESS0082A	J1
			SPA112	F1		SAG144	H1			
			SGA113	F3		SAG144	H1	BAE680AH	ESS0082A	J1
	APS32		ATS15	F2						
			SGA113	F3		SAC076	H2	BAE680AH	ESS0082A	J1
						SAG144	H1			
			SGA113	F3				BAE680AH		
								BAE680BS		
								BAE680AH		
								BAE680BS		
								BAE680BR		
								BAE680BR		
								BAE680BS		
								BAE680BR		
								BAE680BS		
								BAE680BR		
								BAE680BS		
								BAE680BR		
						SAG104	H1	BAE680AB	ESS524	J1
			SPA104	F1		SAC050	H2			
			SGA113	F3		SAG144	H1	BAE680AB	ESS524	J1
						SAG099	H1			
						SAG104	H1			
								BAE680AB	ESS524	J1



KW



TYPE



TYPE

BMW

3 Compact (E36)

318 ti	Petrol	103	07/95 → 08/00
318 ti	Petrol	103	11/94 → 08/95
318 ti	Petrol	103	11/94 → 08/95
318 ti	Petrol	103	12/95 → 08/00
323 ti	Petrol	125	08/97 → 09/98
323 ti	Petrol	125	12/98 → 08/00
323 ti	Petrol	125	08/97 → 08/00

3 Compact (E46)

316 ti	Petrol	85	06/01 → 02/05
316 ti	Petrol	85	03/03 → 12/04
316 ti	Petrol	85	06/02 → 12/04
318 td	Diesel	85	03/03 → 02/05
318 td	Diesel	85	03/03 → 02/05
318 ti	Petrol	105	09/01 → 02/05
318 ti	Petrol	105	03/03 → 12/04
320 td	Diesel	110	09/01 → 02/05
320 td	Diesel	110	09/01 → 02/05
325 ti	Petrol	141	06/01 → 02/05
325 ti	Petrol	141	06/01 → 02/05
325 ti	Petrol	141	10/02 → 12/04

3 Coupé (E36)

316 i	Petrol	75	09/93 → 09/95
316 i	Petrol	75	09/93 → 04/99
316 i	Petrol	75	09/93 → 09/95
316 i	Petrol	75	10/95 → 04/99
318 is	Petrol	103	03/92 → 10/95
318 is	Petrol	103	03/92 → 09/93
318 is	Petrol	103	10/93 → 10/95
318 is	Petrol	103	10/93 → 10/95
318 is	Petrol	103	09/95 → 04/99
318 is	Petrol	103	06/93 → 10/95
318 is	Petrol	103	12/95 → 04/99
320 i	Petrol	110	03/92 → 12/95
320 i	Petrol	110	03/92 → 09/92
320 i	Petrol	110	03/92 → 09/95
320 i	Petrol	110	09/92 → 12/95
320 i	Petrol	110	10/92 → 04/99
320 i	Petrol	110	03/92 → 04/99
320 i	Petrol	110	03/92 → 04/99
320 i	Petrol	110	03/92 → 09/92
320 i	Petrol	110	09/94 → 09/98
320 i	Petrol	110	12/98 → 04/99
323 i	Petrol	125	03/95 → 04/99
323 i	Petrol	125	03/95 → 09/98

ENGINE: M50B, M52B



TYPE

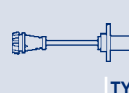

TYPE



TYPE

			RP06A							
			SPA104	F1		SAC050	H2	BAE680AB	ESS524	J1
						SAG099	H1			
								BAE680AB	ESS524	J1
						SAG111	H1			
						SAG144	H1			
									ESS524	J1
						SGA113	F3			
									ESS0082A	J1
								BAE680AH		
								BAE680AH		
		APS32	ATS15	F2					ESS0059A	J1
			SGA113	F3						
			SGA113	F3		SAG151	H1		ESS0082A	J1
								BAE680AH		
		APS32	ATS15	F2					ESS0059A	J1
			SGA113	F3					PI025	J1
			SGA113	F3		SAC076	H2		ESS0082A	J1
						SAG144	H1			
								BAE680AH		
			SPA104	F1		SAC050	H2			
						SAG151	H1	BAE680AB	ESS524	J1
						SAG099	H1			
						SAG104	H1			
			SPA104	F1				BAE680AB		
						SAC034	H2			
						SAC050	H2			
						SAG099	H1			
								BAE680AB		
									ESS524	J1
									ESS524	J1
			RP06A							
			ATS11	F2		SAC042	H2			
			SPA104	F1						
			SPA132	F1						
			ATS09	F2						
						SAG075	H1	BAE680DN	ESS524	J1
						SAG115	H1			
						SAG087	H1			
						SAG111	H1			
						SAG144	H1			
						SAG115	H1		ESS524	J1
						SAG111	H1			



KW

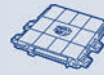

TYPE



TYPE

BMW

3 Coupé (E36)

323 i	Petrol	125	12/98 → 04/99						
328 i	Petrol	142	01/95 → 04/99						
328 i	Petrol	142	01/95 → 09/98						
328 i	Petrol	142	12/98 → 04/99						
M3 3.0	Petrol	210	10/92 → 01/95						
M3 3.0	Petrol	210	10/92 → 01/95						
M3 3.0	Petrol	217	01/95 → 10/95						
M3 3.0	Petrol	217	01/95 → 10/95						
M3 3.2	Petrol	236	10/95 → 04/99						

3 Coupé (E46)

316 Ci	Petrol	77	04/00 →						
316 Ci	Petrol	77	04/00 →						
316 Ci	Petrol	85	06/02 →						
316 Ci	Petrol	77	04/00 → 09/02						
316 Ci	Petrol	85	06/02 → 05/06						
318 Ci	Petrol	105	09/01 →						
318 Ci	Petrol	87	11/99 → 09/01						
318 Ci	Petrol	87	11/99 → 09/01						
318 Ci	Petrol	110	03/05 →						
318 Ci	Petrol	105	03/03 → 03/04						
318 Ci	Petrol	110	03/05 → 05/06						
320 Cd	Diesel	110	11/03 →						
320 Cd	Diesel	110	11/03 →						
320 Ci	Petrol	110	08/99 → 09/00						
320 Ci	Petrol	110	08/99 → 09/00						
320 Ci	Petrol	125	09/00 →						
320 Ci	Petrol	125	09/00 →						
320 Ci	Petrol	125	10/02 → 05/06						
323 Ci	Petrol	125	04/99 → 09/00						
323 Ci	Petrol	125	04/99 → 09/00						
325 Ci	Petrol	141	09/00 →						
325 Ci	Petrol	141	09/00 →						
328 Ci	Petrol	142	04/99 → 06/00						
328 Ci	Petrol	142	04/99 → 06/00						
330 Cd	Diesel	150	03/03 →						
330 Cd	Diesel	150	03/03 →						
330 Ci	Petrol	170	06/00 →						
330 xi	Petrol	170	06/00 →						
330 xi	Petrol	170	06/00 →						
M3 3.2	Petrol	252	06/00 →						
M3 CSL	Petrol	265	06/03 →						
M3 CSL	Petrol	265	06/03 → 12/03						

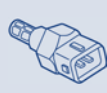
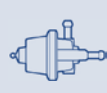

TYPE

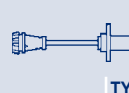

TYPE



TYPE

						SAG144	H1			
						SAG115	H1	ESS524	J1	
						SAG111	H1			
						SAG144	H1			
				ATS08	F2					
				SPA104	F1					
				ATS08	F2			BAE680DN		
				SPA104	F1					
				ATS11	F2					
				SGA113	F3	SAG144	H1	ESS0082A	J1	
				SPA112	F1					
						SAG151	H1			
								BAE680AB		
								BAE680AH		
				SGA113	F3	SAG151	H1	ESS0082A	J1	
				SGA113	F3	SAG144	H1	BAE680AB	ESS0082A	J1
				SPA112	F1					
						SAG151	H1			
								BAE680AH		
								BAE680AH		
	APS32			ATS15	F2			ESS0059A	J1	
				SGA113	F3					
				SGA113	F3	SAC076	H2	ESS0082A	J1	
				SPA112	F1	SAG144	H1			
				SGA113	F3	SAC076	H2	ESS0082A	J1	
						SAG144	H1			
								BAE680AH		
				SGA113	F3	SAC076	H2	ESS0082A	J1	
						SAG144	H1			
				SGA113	F3	SAC076	H2	BAE680AH	ESS0082A	J1
						SAG144	H1			
				SGA113	F3	SAC076	H2	ESS0082A	J1	
				SPA112	F1	SAG144	H1			
	APS32			ATS15	F2			ESS0059A	J1	
				SGA113	F3					
						SAG151	H1	BAE680AH		
				SGA113	F3	SAC076	H2	ESS0082A	J1	
						SAG144	H1			
				SGA113	F3			BAE680AH		
				SGA113	F3			BAE680AH		



KW



TYPE



TYPE

BMW

3 Coupé (E92)

318i	Petrol	105	03/10 → 02/12					
320 d	Diesel	130	03/07 →				TB0019	B3
320 d	Diesel	135	01/10 →				TB0019	B3
320 i	Petrol	110	03/07 → 06/07					
320 i	Petrol	125	03/07 → 02/12					
323 i	Petrol	130	06/06 →					
325 i	Petrol	160	09/06 →					
325 i	Petrol	160	09/07 → 02/12					
325 i xDrive	Petrol	160	09/08 → 02/12					
325 xi	Petrol	160	09/06 →					
325 xi	Petrol	160	09/07 → 08/08					
330 i	Petrol	190	09/06 →					
330 i	Petrol	200	09/07 → 02/12					
330 i xDrive	Petrol	200	09/08 → 02/12					
330 xi	Petrol	190	09/06 → 09/07					
330 xi	Petrol	200	09/06 → 09/07					
330 xi	Petrol	200	09/07 → 08/08					
335 i	Petrol	225	09/06 →					
335 i xDrive	Petrol	225	09/08 →					
335 xi	Petrol	225	09/06 →					

3 Touring (E30)

316 i	Petrol	73	09/91 → 06/94					
316 i	Petrol	75	09/91 → 06/94					
316 i	Petrol	73	09/91 → 12/93					
316 i	Petrol	75	09/91 → 12/93					
318 i	Petrol	83	04/89 → 06/94				SVF012	B6
318 i	Petrol	85	04/89 → 06/91				SVF012	B6
318 i	Petrol	85	09/87 → 06/91					
318 i	Petrol	83	04/89 → 12/93					
318 i	Petrol	85	09/87 → 06/91					
320 i	Petrol	95	01/88 → 12/91					
320 i	Petrol	95	04/89 → 12/91					
324 td	Diesel	85	01/88 → 06/93					
325 i	Petrol	125	07/87 → 03/93					
325 i	Petrol	125	07/87 → 09/87					
325 i	Petrol	125	10/87 → 03/93					
325 i	Petrol	125	07/87 → 03/93					
325 i X	Petrol	125	06/88 → 10/93					
325 i X	Petrol	125	06/88 → 10/93					

3 Touring (E36)

316 i	Petrol	75	01/96 → 10/99					
318 i	Petrol	85	07/95 → 09/95					
318 i	Petrol	85	07/95 → 10/99					
320 i	Petrol	110	01/95 → 10/99					



KW



TYPE



TYPE

BMW

3 Touring (E36)

320 i	Petrol	110	01/95 → 09/98
320 i	Petrol	110	12/98 → 10/99
323 i	Petrol	125	09/95 → 10/99
323 i	Petrol	125	09/95 → 09/98
323 i	Petrol	125	12/98 → 10/99
325 tds	Diesel	105	01/95 → 10/99
325 tds	Diesel	105	09/95 → 01/96
328 i	Petrol	142	01/95 → 10/99
328 i	Petrol	142	01/95 → 09/98
328 i	Petrol	142	12/98 → 10/99

3 Touring (E46)

316 i	Petrol	85	03/02 → 02/05
316 i	Petrol	85	03/02 → 02/05
316 i	Petrol	85	06/02 → 02/05
316 i	Petrol	85	03/03 → 02/05
318 d	Diesel	85	03/02 → 02/05
318 d	Diesel	85	03/03 → 02/05
318 d	Diesel	85	03/03 → 02/05
318 i	Petrol	105	09/01 → 02/05
318 i	Petrol	87	10/99 → 09/01
318 i	Petrol	105	03/03 → 02/05
318 i	Petrol	85	10/99 → 09/01
320 d	Diesel	100	03/00 → 09/01
320 d	Diesel	110	09/01 → 02/05
320 d	Diesel	110	09/01 → 02/05
320 i	Petrol	110	10/99 → 09/00
320 i	Petrol	110	10/99 → 09/00
320 i	Petrol	125	09/00 → 02/05
320 i	Petrol	125	09/00 → 02/05
320 i	Petrol	125	10/02 → 02/05
325 i	Petrol	141	09/00 → 02/05
325 i	Petrol	141	09/00 → 02/05
325 xi	Petrol	141	09/00 → 02/05
325 xi	Petrol	141	09/00 → 02/05
328 i	Petrol	142	10/99 → 06/00
328 i	Petrol	142	10/99 → 06/00
330 d	Diesel	135	10/99 → 02/05
330 d	Diesel	150	03/03 → 02/05
330 d	Diesel	135	10/99 → 02/05
330 d	Diesel	150	03/03 → 02/05
330 i	Petrol	170	06/00 → 02/05
330 i	Petrol	170	06/00 → 02/05
330 i	Petrol	170	10/02 → 02/05
330 xd	Diesel	135	06/00 → 02/05



TYPE

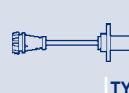

TYPE



TYPE

							SAG111	H1			
							SAG144	H1			
							SAG115	H1		ESS524	J1
							SAG111	H1			
							SAG144	H1			
	APS42		ATS15	F2							
			SPA164	F1							
							SAG115	H1		ESS524	J1
							SAG111	H1			
							SAG144	H1			
			SGA113	F3						ESS0082A	J1
			SPA112	F1							
							SAG151	H1			
									BAE680AH		
	APS30		SGA113	F3						ESS0059A	J1
	APS32		ATS15	F2						ESS0059A	J1
			SGA113	F3							
			SGA113	F3			SAG151	H1		ESS0082A	J1
			SGA113	F3			SAG144	H1	BAE680AB	ESS0082A	J1
									BAE680AH		
									BAE680AB		
	APS30		SGA113	F3						ESS0059A	J1
	APS32		ATS15	F2						ESS0059A	J1
			SGA113	F3						PI025	J1
			SGA113	F3			SAC076	H2		ESS0082A	J1
			SPA112	F1			SAG144	H1			
			SGA113	F3			SAC076	H2		ESS0082A	J1
							SAG144	H1			
									BAE680AH		
			SGA113	F3			SAC076	H2	BAE680AH	ESS0082A	J1
							SAG144	H1			
			SGA113	F3			SAC076	H2	BAE680AH	ESS0082A	J1
							SAG144	H1			
			SGA113	F3			SAC076	H2		ESS0082A	J1
			SPA112	F1			SAG144	H1			
	APS30		SGA113	F3						ESS0059A	J1
	APS32		ATS15	F2							
										PI025	J1
			SGA113	F3							
			SGA113	F3			SAC076	H2		ESS0082A	J1
							SAG144	H1			
									BAE680AH		
	APS30		SGA113	F3						ESS0059A	J1



KW



TYPE



TYPE

BMW

3 Touring (E46)

330 xd	Diesel	150	03/03 → 02/05
330 xd	Diesel	135	06/00 → 02/05
330 xd	Diesel	150	03/03 → 02/05
330 xi	Petrol	170	06/00 → 02/05
330 xi	Petrol	170	06/00 → 02/05
330 xi	Petrol	170	10/02 → 02/05

3 Touring (E91)

316 i	Petrol	90	09/08 → 02/12
318 d	Diesel	100	07/07 →
318 d	Diesel	105	09/07 →
318 i	Petrol	95	01/06 →
318 i	Petrol	105	09/07 → 02/12
318 i	Petrol	95	03/06 → 03/10
318i	Petrol	100	09/07 → 02/12
320 d	Diesel	120	09/05 →
320 d	Diesel	130	09/07 →
320 d	Diesel	135	01/10 →
320 i	Petrol	110	09/05 →
320 i	Petrol	110	09/05 → 05/12
320 i	Petrol	125	09/07 → 02/12
323 i	Petrol	130	04/06 → 04/06
323 i	Petrol	130	05/06 → 06/07
325 i	Petrol	160	09/05 →
325 i	Petrol	160	09/05 → 04/06
325 i	Petrol	160	09/07 → 02/12
325 i xDrive	Petrol	160	09/08 → 02/12
325 xi	Petrol	160	09/05 →
325 xi	Petrol	160	09/05 → 04/06
325 xi	Petrol	160	09/07 → 08/08
325i	Petrol	155	01/12 → 02/12
330 i	Petrol	190	09/05 →
330 i	Petrol	190	09/05 → 04/06
330 i	Petrol	200	09/07 → 02/12
330 i xDrive	Petrol	200	09/08 → 02/12
330 xi	Petrol	190	09/05 → 04/06
330 xi	Petrol	190	05/06 → 09/07
330 xi	Petrol	200	09/07 → 08/08
335 i	Petrol	225	09/06 → 02/10
335 i xDrive	Petrol	225	09/08 → 02/10
335 xi	Petrol	225	09/07 → 08/08

5 (E12)

528 i	Petrol	130	04/77 → 05/81
528 i	Petrol	135	04/77 → 05/81

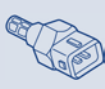
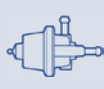

TYPE

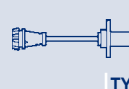

TYPE



TYPE

	APS32		ATS15	F2					
								PI025	J1
			SGA113	F3					
			SGA113	F3		SAC076	H2	ESS0082A	J1
						SAG144	H1		
								BAE680AH	
								BAE680BS	
						SAG151	H1		
								BAE680BS	
								BAE680AH	
								BAE680BS	
	APS32								
						SAG151	H1		
								BAE680AH	
								BAE680BS	
								BAE680BP	
								BAE680BR	
								BAE680BR	
								BAE680BP	
								BAE680BS	
								BAE680BS	
								BAE680BR	
								BAE680BP	
								BAE680BS	
								BAE680BS	
								BAE680BR	
								BAE680BP	
								BAE680BS	
								BAE680BS	
								BAE680BR	
								BAE680BR	
								BAE680BR	
								BAE680BR	
								BAE680BR	
								BAE680BR	
								BAE680BR	
								BAE680BR	
								BAE680BR	
								PI024	J1
								PI024	J1



KW



TYPE



TYPE

BMW

5 (E28)

518	Petrol	66	06/81 → 08/84
518 i	Petrol	77	09/83 → 12/87
520 i	Petrol	110	12/86 → 12/87
520 i	Petrol	92	06/81 → 12/87
520 i	Petrol	95	08/85 → 12/87
520 i	Petrol	92	06/81 → 12/87
524 d	Diesel	63	03/86 → 12/87
524 td	Diesel	85	01/87 → 12/87
524 td	Diesel	85	09/83 → 12/87
525 e	Petrol	90	09/81 → 12/87
525 e	Petrol	92	05/83 → 12/87
525 e	Petrol	95	12/84 → 12/87
525 i	Petrol	110	06/81 → 12/87
528 i	Petrol	135	06/81 → 12/87
535 i, M 535 i	Petrol	136	01/85 → 12/87
535 i, M 535 i	Petrol	141	01/85 → 12/87
535 i, M 535 i	Petrol	160	01/85 → 12/87

5 (E34)

518 i	Petrol	83	08/89 → 09/91			SVF012	B6
518 i	Petrol	83	08/89 → 09/95				
518 i	Petrol	85	08/89 → 09/95				
518 i	Petrol	83	08/89 → 08/91				
518 i	Petrol	83	09/91 → 09/95				
518 i	Petrol	85	09/90 → 09/95				
520 i	Petrol	95	01/88 → 12/90			SVF010	B6
520 i	Petrol	95	01/88 → 08/91				
520 i 24V	Petrol	110	09/89 → 09/95				
520 i 24V	Petrol	110	09/89 → 09/95				
520 i 24V	Petrol	110	09/89 → 09/92				
520 i 24V	Petrol	110	09/92 → 09/95				
520 i 24V	Petrol	110	10/92 → 09/95				
520 i 24V	Petrol	110	09/89 → 09/92				
524 td	Diesel	85	03/88 → 12/91				
525 i	Petrol	125	01/88 → 12/90			SVF010	B6
525 i	Petrol	125	01/88 → 08/91				
525 i 24V	Petrol	141	09/89 → 09/95				
525 i 24V	Petrol	141	09/89 → 09/95				
525 i 24V	Petrol	141	09/89 → 09/92				
525 iX 24V	Petrol	141	10/91 → 09/95				
525 iX 24V	Petrol	141	10/91 → 09/95				
525 iX 24V	Petrol	141	10/91 → 09/92				
525 tds	Diesel	105	10/92 → 09/95				
525 tds	Diesel	105	09/91 → 09/95				
525 tds	Diesel	105	09/91 → 09/95				

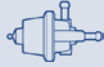

TYPE

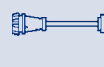

TYPE



TYPE

			SPA104	F1										
													PI024	J1
			SPA104	F1										
			SPA104	F1									ESS0171A	J1
			SPA104	F1										
													PI024	J1
							SAG032	H1						
			SPA121	F1										
							SAG032	H1						
			SPA104	F1										
			SPA104	F1									PI024	J1
			SPA104	F1									PI024	J1
													PI024	J1
													PI024	J1
			SPA104	F1									PI024	J1
			SPA104	F1									PI024	J1
			SPA104	F1									PI024	J1
			SPA104	F1									ESS0134A	J1
			SPA104	F1			SAG099	H1					ESS0134A	J1
							SAG073	H1						
							SAG062	H1						
							SAC050	H2	BAE680AB					
			SPA104	F1			SAG073	H1					ESS0134A	J1
		RP06A	SPA104	F1			SAG075	H1	BAE680DN				ESS0134A	J1
													ESS519	J1
			ATS11	F2			SAC042	H2						
			SPA132	F1			SAG115	H1						
			ATS09	F2										
							SAG087	H1						
			SPA164	F1										
			SPA104	F1			SAG073	H1					ESS0134A	J1
		RP05A	ATS11	F2			SAG087	H1	BAE680DN				ESS0134A	J1
			SPA104	F1										
							SAC042	H2						
		RP05A	ATS11	F2			SAG087	H1					ESS0134A	J1
			SPA104	F1										
							SAC042	H2						
		APS42												
			ATS15	F2										
			SPA164	F1										



KW



TYPE



TYPE

BMW

5 (E34)

530 i	Petrol	138	01/88 → 08/91					
530 i V8	Petrol	160	09/92 → 09/95					
535 i	Petrol	155	01/88 → 09/95					
540 i V8	Petrol	210	09/92 → 09/95					
M 3.6	Petrol	232	10/88 → 05/92					
M 3.6	Petrol	232	10/88 → 05/92					
M 3.6 Cat.	Petrol	232	10/88 → 05/92					
M 3.6 Cat.	Petrol	232	10/88 → 05/92					
M 3.8	Petrol	250	03/92 → 09/95					

5 (E39)

520 d	Diesel	100	02/00 → 06/03					
520 i	Petrol	110	09/98 → 09/00					
520 i	Petrol	110	10/98 → 09/00					
520 i	Petrol	125	09/00 → 06/03					
520 i	Petrol	125	09/00 → 06/03					
520 i	Petrol	100	04/99 → 06/03					
520 i	Petrol	110	01/96 → 09/00					
520 i	Petrol	110	01/96 → 09/00					
520 i	Petrol	110	01/96 → 09/98					
520 i	Petrol	125	10/02 → 06/03					
523 i	Petrol	125	09/98 → 09/00					
523 i	Petrol	125	11/95 → 09/00					
523 i	Petrol	125	11/95 → 09/98					
523 i	Petrol	125	10/98 → 09/00					
525 d	Diesel	120	02/00 → 06/03					
525 i	Petrol	141	09/00 → 06/03					
525 i	Petrol	141	09/00 → 06/03					
525 td	Diesel	85	01/97 → 06/03					
525 tds	Diesel	105	01/96 → 06/03					
528 i	Petrol	142	09/98 → 09/00					
528 i	Petrol	142	11/95 → 09/00					
528 i	Petrol	142	11/95 → 09/00					
528 i	Petrol	142	11/95 → 09/98					
528 i	Petrol	142	10/98 → 09/00					
530 d	Diesel	135	08/98 → 09/00					
530 d	Diesel	142	09/00 → 06/03					
530 d	Diesel	135	08/98 → 09/00					
530 i	Petrol	170	09/00 → 06/03					
530 i	Petrol	170	09/00 → 06/03					
535 i	Petrol	180	04/99 → 06/03					
540 i	Petrol	210	04/96 → 09/98					
540 i	Petrol	210	04/96 → 06/03					
M 4.9	Petrol	294	10/98 → 06/03					



TYPE

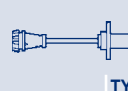

TYPE



TYPE

			SPA104	F1				ESS0134A	J1
		RP05A	ATS11	F2		SAC034	H2	BAE680DN	
			SPA104	F1				ESS0134A	J1
		RP05A	ATS11	F2		SAC034	H2	ESS0134A	J1
			ATS11	F2				ESS0134A	J1
			SPA104	F1					
			ATS11	F2				ESS0134A	J1
			SPA104	F1					
			ATS11	F2				ESS0134A	J1
			SPA104	F1					
			ATS11	F2				ESS0134A	J1
		APS30	SGA113	F3				ESS0074A	J1
			SPA112	F1					
			SGA113	F3		SAG144	H1		
			SGA113	F3		SAC076	H2	ESS519	J1
			SPA112	F1		SAG144	H1		
						SAG151	H1	ESS519	J1
						SAC076	H2	ESS519	J1
						SAG151	H1		
						SAG111	H1		
								BAE680AH	
			SPA112	F1					
						SAC076	H2	ESS519	J1
						SAG111	H1		
						SAG144	H1		
		APS30						ESS0074A	J1
			SPA112	F1		SAC076	H2	BAE680AH	ESS519
						SAG144	H1		
		APS42						ESS0074A	J1
		APS42				SAG151	H1	ESS0074A	J1
			SPA112	F1					
						SAC076	H2	ESS519	J1
						SAG151	H1		
						SAG111	H1		
						SAG144	H1		
		APS30						ESS0074A	J1
		APS30						PI025	J1
								PI025	J1
			SPA112	F1		SAC076	H2	BAE680AH	ESS519
						SAG144	H1		
			SPA112	F1		SAG061	H1	ESS519	J1
		RP05A							
			SPA112	F1		SAG061	H1		
			SPA112	F1		SAG061	H1		



KW



TYPE



TYPE

BMW

5 (E60)

520 d	Diesel	110	09/05 → 03/10						
520 d	Diesel	120	07/05 → 03/10						
520 i	Petrol	125	07/03 → 03/10						
520 i	Petrol	125	07/03 → 03/10						
520 i	Petrol	125	07/03 → 03/05						
520 i	Petrol	125	09/07 → 02/10						
523 i	Petrol	130	07/05 → 03/10						
523 i	Petrol	130	07/05 → 04/06						
523 i	Petrol	140	03/07 → 02/10						
525 d	Diesel	130	06/04 → 03/10						
525 d	Diesel	120	12/04 → 03/10						
525 d	Diesel	145	01/07 → 03/10						
525 d xDrive	Diesel	145	09/08 → 03/10						
525 i	Petrol	141	09/03 → 03/10						
525 i	Petrol	141	09/03 → 03/10						
525 i	Petrol	160	03/07 → 02/10						
525 i	Petrol	160	07/05 → 03/10						
525 i	Petrol	160	07/05 → 04/06						
525 i xDrive	Petrol	160	09/08 → 02/10						
525 i xDrive	Petrol	160	09/08 → 03/10						
525 xi	Petrol	160	03/07 → 08/08						
525 xi	Petrol	160	07/05 → 04/06						
525 xi	Petrol	160	05/06 → 03/07						
530 d	Diesel	160	07/03 → 03/10						
530 d	Diesel	160	07/03 → 03/10						
530 d	Diesel	170	07/03 → 03/10						
530 d	Diesel	173	01/07 → 03/10						
530 d xDrive	Diesel	173	09/08 → 03/10						
530 i	Petrol	170	07/03 → 03/10						
530 i	Petrol	170	07/03 → 03/10						
530 i	Petrol	190	07/05 → 03/10						
530 i	Petrol	200	03/07 → 02/10						
530 i xDrive	Petrol	200	09/08 → 02/10						
530 xd	Diesel	170	07/05 → 03/10						
530 xd	Diesel	173	01/07 → 03/10						
530 xi	Petrol	190	07/05 → 03/10						
530 xi	Petrol	200	03/07 → 08/08						
535 d	Diesel	200	09/04 → 03/10						
535 d	Diesel	210	01/07 → 03/10						
540 i	Petrol	225	09/05 → 02/10						
545 i	Petrol	245	09/03 → 03/10						
550 i	Petrol	270	07/05 → 03/10						
M	Petrol	373	09/04 → 03/10						

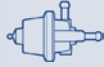

TYPE



TYPE



TYPE

									SUA583	J3
									SUA583	J3
			SGA113	F3			SAC076	H2		
							SAG144	H1		
									BAE680AH	
									BAE680BS	
									BAE680BR	
									BAE680BP	
									BAE680BS	
			SGA113	F3					SUA583	J3
									SUA583	J3
									SUA583	J3
									SUA583	J3
			SGA113	F3			SAC076	H2	BAE680AH	
							SAG144	H1		
									BAE680BS	
									BAE680BR	
									BAE680BP	
									BAE680BS	
									SUA583	J3
									BAE680BS	
									BAE680BP	
									BAE680BR	
	APS32		ATS15	F2					SUA583	J3
			SGA113	F3						
			SGA113	F3						
									SUA583	J3
									SUA583	J3
			SGA113	F3			SAC076	H2	BAE680AH	
							SAG144	H1		
									BAE680BP	
									BAE680BS	
									BAE680BS	
			SGA113	F3					SUA583	J3
									SUA583	J3
									BAE680BP	
									BAE680BS	
			SGA113	F3					SUA583	J3
									SUA583	J3
									BAE680AH	
			SGA113	F3			SAG151	H1	BAE680AH	
									BAE680AH	
							SAG061	H1		



KW



TYPE



TYPE

BMW

5 (F10, F18)

520 d	Diesel	135	03/10 →						TB0019	B3
520i	Petrol	120	09/11 →							
520i	Petrol	135	09/11 →							
523 i	Petrol	150	03/10 → 08/11							
528 i	Petrol	190	03/10 →							
528 i	Petrol	190	03/10 → 08/11							
528i	Petrol	180	09/11 →							
530i	Petrol	200	09/11 → 02/12							
535 i	Petrol	225	03/10 →							
535 i xDrive	Petrol	225	03/10 →							
550 i	Petrol	300	03/10 →							
550 i xDrive	Petrol	300	09/10 →							
M	Petrol	412	09/11 →							

5 Gran Turismo (F07)

535 i	Petrol	225	10/09 →							
535 i xDrive	Petrol	225	09/10 →							
550 i	Petrol	300	10/09 →							
550 i xDrive	Petrol	300	09/10 →							

5 Touring (E34)

518 g	BiFuel	85	11/95 → 06/96							
518 g	BiFuel	85	11/95 → 06/96							
518 i	Petrol	83	03/93 → 09/94							
518 i	Petrol	85	09/94 → 01/97							
518 i	Petrol	85	09/94 → 01/97							
518 i	Petrol	85	09/94 → 12/96							
520 i	Petrol	110	11/91 → 12/96							
520 i	Petrol	110	11/91 → 09/92							
520 i	Petrol	110	11/91 → 09/95							
520 i	Petrol	110	09/92 → 09/95							
520 i	Petrol	110	10/92 → 01/97							
520 i	Petrol	110	11/91 → 01/97							
520 i	Petrol	110	11/91 → 09/92							
525 i	Petrol	141	11/91 → 12/96							
525 i	Petrol	141	11/91 → 01/97							
525 i	Petrol	141	11/91 → 09/95							
525 i	Petrol	141	11/91 → 09/92							
525 ix	Petrol	141	02/92 → 12/96							
525 ix	Petrol	141	02/92 → 01/97							
525 ix	Petrol	141	02/92 → 09/95							
525 ix	Petrol	141	02/92 → 09/92							
525 td	Diesel	85	03/93 → 01/97							
525 td	Diesel	85	03/93 → 01/97							
525 tds	Diesel	105	10/92 → 01/97							
525 tds	Diesel	105	12/91 → 01/97							



TYPE



TYPE



TYPE

									GA2233	J2
									GA2231	J2
									GA2231	J2
								BAE680BS		
								BAE680BR	GA2231	J2
								BAE680BS		
									GA2231	J2
								BAE680BS		
									GA2232	J2
									GA2232	J2
								BAE680BR		
								BAE680BR		
								BAE680BR		
									GA2232	J2
									GA2232	J2
								BAE680BR		
								BAE680BR		
									SPA104	F1
									SAC050	H2
									SAG099	H1
									SPA104	F1
									SAG062	H1
									ESS0134A	J1
									SPA104	F1
									SAC050	H2
									ESS0134A	J1
									SAG099	H1
									BAE680AB	
			RP06A							
									ATS11	F2
									SAC042	H2
									SPA104	F1
									SPA132	F1
									ATS09	F2
									SAG075	H1
									ESS0134A	J1
									SAG087	H1
			RP05A							
									ATS11	F2
									SAG087	H1
									ESS0134A	J1
									SPA104	F1
									SAC042	H2
			RP05A							
									ATS11	F2
									SAG087	H1
									ESS0134A	J1
									SPA104	F1
									SAC042	H2
			APS42							
									ATS15	F2
									SPA164	F1
			APS42							
									ATS15	F2



KW



TYPE



TYPE

BMW

5 Touring (E34)

525 tds	Diesel	105	12/91 → 01/97
530 i V8	Petrol	160	09/92 → 12/96
530 i V8	Petrol	160	09/92 → 01/97
540 i	Petrol	210	10/93 → 12/96
540 i	Petrol	210	09/93 → 01/97
M 3.8	Petrol	250	09/94 → 01/97
M 3.8	Petrol	250	09/94 → 01/97

5 Touring (E39)

520 d	Diesel	100	02/00 → 09/03
520 i	Petrol	125	09/00 → 05/04
520 i	Petrol	125	09/00 → 05/04
520 i	Petrol	125	10/02 → 05/04
520 i	Petrol	100	04/99 → 05/04
525 d	Diesel	120	02/00 → 05/04
525 i	Petrol	141	09/00 → 05/04
525 i	Petrol	141	09/00 → 05/04
525 tds	Diesel	105	03/97 → 05/04
528 i	Petrol	142	09/98 → 09/00
528 i	Petrol	142	01/97 → 09/00
528 i	Petrol	142	01/97 → 09/00
528 i	Petrol	142	01/97 → 09/98
528 i	Petrol	142	10/98 → 09/00
530 d	Diesel	135	08/98 → 09/00
530 d	Diesel	142	09/00 → 05/04
530 d	Diesel	135	08/98 → 09/00
530 i	Petrol	170	09/00 → 05/04
530 i	Petrol	170	09/00 → 05/04
530 i	Petrol	170	10/02 → 05/04

5 Touring (E61)

520 d	Diesel	110	09/05 →
520 d	Diesel	120	07/05 →
520 i	Petrol	125	09/07 → 08/10
523 i	Petrol	130	07/05 →
523 i	Petrol	130	07/05 → 04/06
523 i	Petrol	140	03/07 → 08/10
525 d	Diesel	130	06/04 →
525 d	Diesel	145	01/07 →
525 d xDrive	Diesel	145	09/08 →
525 i	Petrol	141	06/04 →
525 i	Petrol	141	06/04 →
525 i	Petrol	141	06/04 → 03/05
525 i	Petrol	160	03/07 → 08/10
525 i	Petrol	160	07/05 →
525 i	Petrol	160	07/05 → 04/06

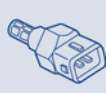
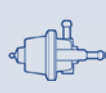

TYPE

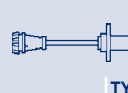

TYPE



TYPE

			SPA164	F1					
		RP05A							
			ATS11	F2		SAC034	H2		
		RP05A							
			ATS11	F2		SAC034	H2		
			ATS11	F2					
			SPA104	F1					
	APS30		SGA113	F3				ESS0074A	J1
			SGA113	F3		SAC076	H2	ESS519	J1
			SPA112	F1		SAG144	H1		
								BAE680AH	
								ESS519	J1
	APS30							ESS0074A	J1
			SPA112	F1		SAC076	H2	BAE680AH	ESS519
						SAG144	H1		
	APS42							ESS0074A	J1
			SPA112	F1					
						SAC076	H2	ESS519	J1
						SAG151	H1		
						SAG115	H1		
						SAG144	H1		
	APS30							ESS0074A	J1
	APS30							PI025	J1
								PI025	J1
			SPA112	F1		SAC076	H2	ESS519	J1
						SAG144	H1		
								BAE680AH	
								SUA583	J3
								SUA583	J3
								BAE680BS	
								BAE680BR	
								BAE680BP	
								BAE680BS	
			SGA113	F3				SUA583	J3
								SUA583	J3
								SUA583	J3
						SAC076	H2		
						SAG144	H1		
								BAE680AH	
								BAE680BS	
								BAE680BR	
								BAE680BP	



KW

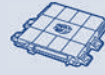

TYPE



TYPE

BMW

5 Touring (E61)

525 i xDrive	Petrol	160	09/08 → 08/10						
525 xi	Petrol	160	03/07 → 08/08						
525 xi	Petrol	160	07/05 → 04/06						
525 xi	Petrol	160	05/06 → 03/07						
530 d	Diesel	160	06/04 →						
530 d	Diesel	160	06/04 →						
530 d	Diesel	170	07/05 →						
530 d	Diesel	173	01/07 →						
530 d xDrive	Diesel	173	09/08 →						
530 i	Petrol	170	06/04 →						
530 i	Petrol	190	07/05 →						
530 i	Petrol	190	07/05 → 04/06						
530 i	Petrol	200	01/07 →						
530 i	Petrol	200	03/07 → 08/10						
530 i xDrive	Petrol	200	09/08 → 08/10						
530 xd	Diesel	170	07/05 →						
530 xd	Diesel	173	01/07 →						
530 xi	Petrol	190	07/05 →						
530 xi	Petrol	200	03/07 → 08/08						
535 d	Diesel	200	09/04 →						
535 d	Diesel	210	01/07 →						
545 i	Petrol	245	06/04 →						
545 i	Petrol	245	06/04 → 09/05						
550 i	Petrol	270	09/05 → 08/10						

5 Touring (F11)

520 d	Diesel	135	09/10 →					TB0019	B3
520i	Petrol	135	09/11 →						
523 i	Petrol	150	09/10 → 08/11						
528 i	Petrol	190	09/10 → 08/11						
528i	Petrol	180	09/11 →						
530i	Petrol	200	09/11 → 02/12						
550i	Petrol	300	03/11 →						

6 (E24)

628 CSi	Petrol	135	09/79 → 08/87						
633 CSi	Petrol	145	09/78 → 08/84						
633 CSi	Petrol	147	04/76 → 09/78						
635 CSi	Petrol	136	01/85 → 05/89						
635 CSi	Petrol	155	08/87 → 05/89						
635 CSi	Petrol	160	01/85 → 08/88						
635 CSi	Petrol	160	11/81 → 10/89						
M 635 CSi	Petrol	211	03/84 → 05/89						



TYPE



TYPE



TYPE

								BAE680BS		
								BAE680BS		
								BAE680BP		
								BAE680BR		
	APS32		ATS15	F2				SUA583	J3	
			SGA113	F3				SUA583	J3	
			SGA113	F3				SUA583	J3	
								SUA583	J3	
							SAG144	H1		
								BAE680BR		
								BAE680BP		
								BAE680BR		
								BAE680BS		
								BAE680BS		
			SGA113	F3				SUA583	J3	
								SUA583	J3	
								BAE680BP		
								BAE680BS		
			SGA113	F3				SUA583	J3	
								SUA583	J3	
							SAG151	H1		
								BAE680AH		
								BAE680AH		
								GA2231	J2	
								BAE680BS		
								BAE680BS		
								GA2231	J2	
								BAE680BS		
								BAE680BR		
								PI024	J1	
								PI024	J1	
								PI024	J1	
			SPA104	F1				PI024	J1	
			SPA104	F1				PI024	J1	
			SPA104	F1				PI024	J1	
								PI024	J1	
			SPA104	F1				PI024	J1	



KW



TYPE



TYPE

BMW

6 (E63)

630 i	Petrol	190	09/04 →
630 i	Petrol	190	09/04 → 04/06
630 i	Petrol	200	09/07 → 07/10
635 d	Diesel	210	07/07 →
645 Ci	Petrol	245	01/04 →
650 i	Petrol	270	07/05 →
M	Petrol	373	09/05 →

6 Cabriolet (E64)

630 i	Petrol	190	09/04 →
630 i	Petrol	190	09/04 → 04/06
630 i	Petrol	200	09/07 → 07/10
635 d	Diesel	210	07/07 →
645 Ci	Petrol	245	04/04 →
650 i	Petrol	270	07/05 →

6 Cabriolet (F12)

650 i	Petrol	300	03/11 → 06/12
650i xDrive	Petrol	300	09/11 → 06/12
M	Petrol	412	03/12 →

6 Coupé (F13)

650 i	Petrol	300	10/11 → 06/12
650i xDrive	Petrol	300	10/11 → 06/12
M	Petrol	412	09/12 →

7 (E23)

728 i	Petrol	135	07/78 → 08/86
733 i	Petrol	145	05/77 → 08/86
735 i	Petrol	136	01/85 → 08/86
735 i	Petrol	160	09/79 → 08/86

7 (E32)

730 i,iL	Petrol	138	12/86 → 09/94
730 i,iL	Petrol	145	12/86 → 09/94
730 i,iL V8	Petrol	160	04/92 → 09/94
735 i,iL	Petrol	155	09/86 → 09/92
735 i,iL	Petrol	162	09/86 → 12/87
740 i,iL V8	Petrol	210	04/92 → 09/94
750 i,iL V12	Petrol	220	01/92 → 09/94
750 i,iL V12	Petrol	220	09/87 → 09/94

7 (E38)

725 tds	Diesel	105	04/96 → 11/01
728 i,iL	Petrol	142	08/95 → 11/01
728 i,iL	Petrol	142	09/98 → 11/01
728 i,iL	Petrol	142	08/95 → 09/98
728 i,iL	Petrol	142	10/98 → 11/01
730 d	Diesel	135	08/98 → 04/00
730 d	Diesel	142	04/00 → 11/01

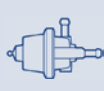

TYPE



TYPE



TYPE

BAE680BR

BAE680BP

BAE680BS

SUA583

J3

SAG151

H1

BAE680AH

BAE680AH

SAG061

H1

BAE680BR

BAE680BP

BAE680BS

SUA583

J3

SAG151

H1

BAE680AH

BAE680AH

BAE680BR

BAE680BR

BAE680BR

BAE680BR

BAE680BR

BAE680BR

PI024

J1

PI024

J1

SPA104

F1

SPA104

F1

PI024

J1

SPA104

F1

ESS0134A

J1

SPA104

F1

ESS0134A

J1

RP05A

SAC034

H2

BAE680DN

SPA104

F1

ESS0134A

J1

SPA104

F1

ESS0134A

J1

RP05A

SAC034

H2

BAE680DN

ESS0134A

J1

RP06A

ATS08

F2

APS42

SGA113

F3

SAG151

H1

ESS518

J1

SPA112

F1

SAG111

H1

SAG144

H1

APS30

PI025

J1

APS30

PI025

J1



KW

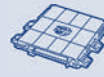

TYPE



TYPE

BMW

7 (E38)

730 i,iL	Petrol	155	10/94 → 12/96						
730 i,iL	Petrol	160	10/94 → 12/96						
730 i,iL	Petrol	155	10/94 → 11/01						
730 i,iL	Petrol	160	10/94 → 11/01						
735 i,iL	Petrol	173	01/96 → 09/98						
735 i,iL	Petrol	173	09/98 → 11/01						
735 i,iL	Petrol	173	01/96 → 11/01						
740 d	Diesel	180	05/99 → 11/01						
740 i,iL	Petrol	210	01/96 → 06/96						
740 i,iL	Petrol	210	10/94 → 09/98						
740 i,iL	Petrol	210	09/98 → 11/01						
740 i,iL	Petrol	210	10/94 → 11/01						
740 i,iL	Petrol	210	01/96 → 11/01						
750 i,iL	Petrol	240	09/98 → 11/01						
750 i,iL	Petrol	240	12/94 → 11/01						

7 (E65, E66, E67)

760	Petrol	320	02/03 → 08/05						
730 d	Diesel	160	10/02 →						
730 d	Diesel	160	10/02 →						
730 i,Li	Petrol	170	03/03 →						
730 i,Li	Petrol	170	03/03 →						
730 i,Li	Petrol	170	03/03 → 03/05						
730 i,Li	Petrol	190	03/05 →						
730 i,Li	Petrol	190	04/05 → 04/06						
730 Ld	Diesel	170	07/05 →						
735 i	Petrol	225	04/05 → 10/08						
735 i,Li	Petrol	200	11/01 →						
735 i,Li	Petrol	200	11/01 → 03/05						
740 d	Diesel	190	10/02 →						
740 i,Li	Petrol	225	07/05 → 10/08						
745 i,Li	Petrol	245	11/01 →						
750 i,Li	Petrol	270	07/05 →						
760 i,Li	Petrol	327	01/03 →						

7 (F01, F02, F03, F04)

730 i	Petrol	190	05/09 →						
740 i	Petrol	240	10/08 →						
750 i	Petrol	300	10/08 →						
750 i xDrive	Petrol	300	09/09 →						
760 i	Petrol	400	09/09 →						
ActiveHybrid	Hybrid	330	10/10 →						



TYPE

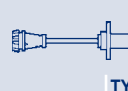

TYPE



TYPE

			RP05A								
			RP05A								
				ATS11	F2		SAC034	H2	BAE680DN	ESS518	J1
				ATS11	F2		SAC034	H2		ESS518	J1
			RP05A								
				SPA112	F1						
							SAG061	H1		ESS518	J1
		APS30					SAG061	H1			
			RP05A								
			RP05A								
				SPA112	F1						
				ATS11	F2		SAC034	H2	BAE680DN	ESS518	J1
							SAG061	H1		ESS518	J1
				SPA112	F1						
							SAG061	H1		ESS518	J1
									BAE680AH		
		APS32		ATS15	F2						
				SGA113	F3						
				SGA113	F3		SAC076	H2		ESS523	J1
							SAG144	H1			
									BAE680AH		
									BAE680BR		
									BAE680BP		
				SGA113	F3						
									BAE680AH		
				SGA113	F3		SAG151	H1		ESS523	J1
									BAE680AH		
		APS32		ATS15	F2						
									BAE680AH		
				SGA113	F3		SAG151	H1	BAE680AH	ESS523	J1
									BAE680AH		
				SGA113	F3						
									BAE680BR		
									BAE680BR		
									BAE680BR		
									BAE680BR		
									BAE680BR		
									BAE680BR		



KW



TYPE



TYPE

BMW

8 (E31)

840 Ci	Petrol	210	01/96 → 12/99						
840 i	Petrol	210	02/93 → 02/96						
850 Ci	Petrol	240	09/94 → 12/99						
850 CSi	Petrol	280	04/93 → 10/96						
850 CSi	Petrol	280	04/93 → 12/96						
850 i,Ci	Petrol	220	01/92 → 10/94						
850 i,Ci	Petrol	220	04/90 → 10/94						

X1 (E84)

sDrive 18 i	Petrol	110	03/10 →						
xDrive 25 i	Petrol	160	03/10 →						
xDrive 28 i	Petrol	190	10/09 → 08/11						

X3 (E83)

2.0 D	Diesel	110	10/04 →						
2.0 D	Diesel	110	10/04 →						
2.0 D	Diesel	130	09/07 →						
2.0 i	Petrol	110	07/05 →						
2.0 i	Petrol	110	09/05 → 08/08						
2.5 i	Petrol	141	01/04 →						
2.5 i	Petrol	141	01/04 →						
2.5 si	Petrol	160	09/06 →						
3.0 d	Diesel	150	01/04 →						
3.0 d	Diesel	150	01/04 →						
3.0 d	Diesel	160	01/04 →						
3.0 i xDrive	Petrol	170	01/04 →						
3.0 i xDrive	Petrol	170	01/04 →						
3.0 sd	Diesel	210	09/06 →						
3.0 si	Petrol	200	09/06 →						
xDrive 20 i	Petrol	110	09/08 → 08/10						
xDrive 25 i	Petrol	160	09/08 → 08/10						
xDrive 30 i	Petrol	200	09/08 →						

X3 (F25)

xDrive 20i	Petrol	135	09/11 →						
xDrive 28 i	Petrol	190	04/11 →						
xDrive 28 i	Petrol	180	08/11 →						
xDrive 35 i	Petrol	225	09/10 →						

X5 (E53)

3.0 d	Diesel	135	05/01 →						
3.0 d	Diesel	160	12/03 →						
3.0 i	Petrol	163	05/00 →						
3.0 i	Petrol	163	05/00 →						
3.0 i	Petrol	170	05/00 →						
3.0 i	Petrol	170	05/00 →						
4.4 i	Petrol	210	05/00 →						
4.4 i	Petrol	235	12/03 →						

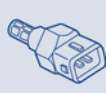
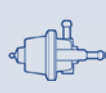

TYPE

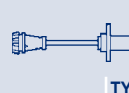

TYPE



TYPE

			RP05A	ATS09	F2		SAG061	H1	BAE680DN		
			RP05A	ATS11	F2		SAC034	H2			
							SAG061	H1			
			RP06A								
				ATS11	F2						
			RP06A								
				ATS11	F2						
									BAE680AH		
									BAE680BR		
									BAE680BR		
		APS32		ATS15	F2						
				SGA113	F3						
							SAG151	H1			
							SAG151	H1			
									BAE680AH		
							SAC076	H2	BAE680AH		
							SAG144	H1			
							SAG151	H1	BAE680BR		
				ATS15	F2						
				SGA113	F3						
				SGA113	F3						
				SGA113	F3		SAC076	H2	BAE680AH		
							SAG144	H1			
							SAG151	H1			
							SAG151	H1	BAE680BR		
									BAE680AH		
									BAE680BR		
									BAE680BR		
									BAE680BR		
										ESS0061A	J1
									BAE680BR	ESS0061A	J1
										ESS0061A	J1
										ESS0061A	J1
		APS30					SAG144	H1		PI025	J1
		APS32		ATS15	F2					PI025	J1
				SGA113	F3		SAG144	H1		ESS522	J1
				SPA112	F1						
				SGA113	F3		SAC076	H2	BAE680AH	ESS522	J1
							SAG144	H1			
				SPA112	F1					ESS522	J1
				SGA113	F3		SAG151	H1	BAE680AH	ESS522	J1



KW



TYPE



TYPE

BMW

X5 (E53)

4.6 is	Petrol	255	02/02 →					
4.8 is	Petrol	265	04/04 →					

X5 (E70)

3.0 d	Diesel	173	02/07 → 09/08					
3.0 sd	Diesel	210	09/07 → 02/09					
3.0 si	Petrol	200	02/07 → 09/08					
4.8 i xDrive	Petrol	261	02/07 → 09/08					
4.8 i xDrive	Petrol	261	02/07 → 09/08					
M	Petrol	408	09/09 →					
xDrive 30 i	Petrol	200	09/08 → 03/10					
xDrive 35 i	Petrol	225	09/10 →					
xDrive 48 i	Petrol	261	09/08 →					
xDrive 50 i	Petrol	300	06/10 →					

X6 (E71, E72)

35 i	Petrol	225	05/08 →					
50 i	Petrol	300	05/08 →					
M	Petrol	408	09/09 →					
xDrive 35 i	Petrol	225	09/08 →					
xDrive 50 i	Petrol	300	09/08 →					

Z1

2.5	Petrol	125	06/88 → 06/91			SVF010	B6	
-----	--------	-----	---------------	--	--	--------	----	--

Z3 (E36)

1.8	Petrol	85	10/95 → 10/98					
1.9	Petrol	87	07/98 → 01/03					
1.9	Petrol	85	01/99 → 01/03					
1.9	Petrol	103	10/95 → 03/99					
1.9	Petrol	85	01/99 → 09/02					
1.9	Petrol	87	09/98 → 09/02					
2.0	Petrol	110	04/99 → 01/03					
2.0	Petrol	110	04/99 → 01/03					
2.2	Petrol	125	08/00 → 01/03					
2.2	Petrol	125	08/00 → 01/03					
3.0	Petrol	170	06/00 → 01/03					
3.0	Petrol	170	06/00 → 01/03					
M 3.2	Petrol	239	06/01 → 01/03					

Z3 Coupé (E36)

2.8	Petrol	141	09/98 → 06/00					
2.8	Petrol	141	07/97 → 06/00					
2.8	Petrol	141	07/97 → 06/00					
2.8	Petrol	141	07/97 → 09/98					
2.8	Petrol	141	07/97 → 03/98					
2.8	Petrol	141	04/98 → 06/00					
3.0	Petrol	170	06/00 → 06/03					
3.0	Petrol	170	06/00 → 06/03					



KW



TYPE



TYPE

BMW

Z3 Coupé (E36)

M	Petrol	236	02/98 → 06/01						
M	Petrol	239	06/01 → 06/03						

Z4 (E85)

2.0 i	Petrol	110	04/05 →						
2.0 i	Petrol	110	04/05 → 03/09						
2.2 i	Petrol	125	10/03 →						
2.2 i	Petrol	125	10/03 →						
2.2 i	Petrol	125	10/03 → 11/05						
2.5 i	Petrol	141	02/03 →						
2.5 i	Petrol	141	02/03 →						
2.5 i	Petrol	130	01/06 →						
2.5 i	Petrol	130	02/06 → 04/06						
2.5 si	Petrol	160	01/06 →						
2.5 si	Petrol	160	02/06 → 04/06						
3.0 i	Petrol	170	02/03 →						
3.0 i	Petrol	170	02/03 →						
3.0 si	Petrol	195	01/06 →						
M	Petrol	252	03/06 →						

Z4 (E89)

sDrive 23 i	Petrol	150	05/09 → 08/11						
sDrive 23 i	Petrol	150	05/09 →						
sDrive 30 i	Petrol	190	05/09 →						
sDrive 35 i	Petrol	225	05/09 →						
sDrive 35 is	Petrol	250	09/10 →						
sDrive20i	Petrol	135	09/11 →						
sDrive28i	Petrol	180	09/11 →						

Z4 Coupé (E86)

3.0 si	Petrol	195	03/06 →						
M	Petrol	252	03/06 →						

Z8 (E52)

4.9	Petrol	294	06/00 → 06/03						
-----	--------	-----	---------------	--	--	--	--	--	--

CADILLAC

CTS

2.8	Petrol	158	03/05 → 09/07						
3.2	Petrol	160	09/02 → 08/04						
3.6	Petrol	189	03/05 → 09/07						
3.6	Petrol	229	01/08 → 08/09						
3.6 AWD	Petrol	229	01/08 → 08/09						

CTS Coupé

3.6	Petrol	229	01/08 → 08/09						
-----	--------	-----	---------------	--	--	--	--	--	--



KW



TYPE



TYPE

CADILLAC

SRX

3.6	Petrol	190	07/04 → 12/08						
3.6 Trazione posteriore	Petrol	190	01/04 → 12/08						

STS

3.6	Petrol	189	05/05 →						
-----	--------	-----	---------	--	--	--	--	--	--

CHEVROLET

AVEO 2 volumi /Coda spiovente (T300)

1.2	Petrol	63	06/11 →						
1.3 D	Diesel	55	07/11 →						
1.3 D	Diesel	70	07/11 →						
1.6	Petrol	85	03/11 →						

AVEO Tre volumi (T250, T255)

1.2	Petrol	53	03/06 → 12/07					B3396	B1
1.2	Petrol	53	03/06 → 12/07						
1.4	Petrol	69	03/06 → 12/07					B3396	B1
1.4	Petrol	69	03/06 → 12/07						

AVEO Tre volumi (T300)

1.3 D	Diesel	55	07/11 →						
1.3 D	Diesel	70	07/11 →						
1.6	Petrol	85	03/11 →						

CAPTIVA (C100, C140)

2.0 D	Diesel	110	09/07 →						
-------	--------	-----	---------	--	--	--	--	--	--

EPICA (KL1_)

2.0	Petrol	94	01/05 → 12/06						
2.0	Petrol	98	01/05 → 12/06						
2.0	Petrol	105	06/06 →						
2.5	Petrol	115	06/06 →						

EVANDA

2.0	Petrol	96	03/05 →						
2.0	Petrol	96	03/05 →						

KALOS

1.2	Petrol	53	03/05 →						
1.4	Petrol	61	03/05 →						
1.4	Petrol	61	03/05 →						
1.4 16V	Petrol	69	03/05 →						
1.4 16V	Petrol	69	03/05 →						

KALOS Tre volumi

1.4 16V	Petrol	69	03/05 →						
---------	--------	----	---------	--	--	--	--	--	--

LACETTI (J200)

1.4 16V	Petrol	70	03/05 →						
1.4 16V	Petrol	70	03/05 →						
1.4 16V	Petrol	70	03/05 →						
1.6	Petrol	80	03/05 →						
1.6	Petrol	80	03/05 →						



TYPE

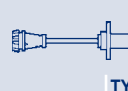

TYPE



TYPE

BAE680CF

BAE680CF

BAE680CF

SAA103

SPA146 F1

SPA146 F1

BAE680CS

SAC051 H2

SAD024 H3

SAC051 H2

SAD024 H3

SPA146 F1

SPA146 F1

BAE680CS

APS65

APS65

APS65

SAD024 H3

SAD024 H3

APS65

SPA115 F1

SAC036 H2

SAD024 H3

SAD024 H3

SPA115 F1

SAD024 H3

SAG106 H1

SPA115 F1

SAD024 H3

SAG106 H1

SPA115 F1

SAG106 H1

APS65

SPA115 F1

SAC051 H2

SAD024 H3

SAG106 H1

APS65

SPA115 F1

SAC051 H2

SAD024 H3

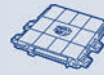
KW

TYPE

TYPE

CHEVROLET

LACETTI (J200)

1.6	Petrol	80	03/05 →					
1.8	Petrol	89	08/05 →					
1.8	Petrol	90	03/05 →					
1.8	Petrol	90	03/05 →					
2.0 D	Diesel	89	01/07 →					

MATIZ (M200, M250)

0.8	Petrol	38	03/05 →					
1.0	Petrol	47	03/05 →					
1.0	Petrol	49	03/05 →					

NUBIRA Station wagon

1.6	Petrol	80	03/05 →					
1.6	Petrol	80	03/05 →					
1.8	Petrol	90	03/05 →					
1.8	Petrol	90	03/05 →					

NUBIRA Tre volumi

1.6	Petrol	80	03/05 →					
1.6	Petrol	80	03/05 →					
1.8	Petrol	90	03/05 →					
1.8	Petrol	90	03/05 →					

TACUMA

1.6	Petrol	77	03/05 →					
1.6	Petrol	79	08/05 →					
1.6	Petrol	79	08/05 →					
2.0	Petrol	89	03/05 →					
2.0	Petrol	89	03/05 →					
2.0	Petrol	90	08/05 →					

CHRYSLER

LE BARON

2.2 i	Petrol	69	09/86 → 12/94					
2.5 i	Petrol	75	09/86 → 12/94					

LE BARON Cabriolet

2.5 i	Petrol	75	09/86 → 12/93					
-------	--------	----	---------------	--	--	--	--	--

SARATOGA

2.5	Petrol	72	10/89 → 09/91					
-----	--------	----	---------------	--	--	--	--	--

VOYAGER III (GS)

2.5 TD	Diesel	85	01/95 → 03/01					
--------	--------	----	---------------	--	--	--	--	--

CITROËN

2 CV

4	Petrol	12	03/63 → 02/70					
4	Petrol	17	01/70 → 12/75					
6	Petrol	18	09/75 → 06/81					
6	Petrol	20	08/79 → 07/90					

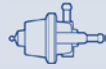

TYPE



TYPE



TYPE

						SAG106	H1		
	APS65					SAC051	H2		
	APS65		SPA115	F1		SAC036	H2		
						SAD024	H3		
	APS65								
FEI0003			SPA115	F1		SAD024	H3		
			SPA115	F1		SAD024	H3		
			SPA115	F1		SAD024	H3		
			SPA115	F1		SAD024	H3		
						SAG106	H1		
			SPA115	F1		SAC036	H2		
						SAD024	H3		
	APS65		SPA115	F1		SAD024	H3		
						SAG106	H1		
	APS65		SPA115	F1		SAC036	H2		
						SAD024	H3		
						SAD024	H3		
						SAD024	H3		
			SPA115	F1		SAG106	H1		
						SAC036	H2		
						SAD024	H3		
						SAC036	H2		
			SPA137	F1					
			SPA137	F1				ESS0096A	J1
			SPA137	F1				ESS0096A	J1
			SPA137	F1					
	APS64								
								SUA188	J3
								SUA188	J3
								SUA188	J3
								SUA188	J3



KW



TYPE



TYPE

CITROËN

2 CV

6 Petrol 21 02/70 → 10/85

AX (ZA-_)

10 Petrol 37 07/92 → 12/98 ENGINE: TU1ML3

10 Petrol 33 01/93 → 12/98

10 Petrol 37 01/93 → 12/98

10 Petrol 33 07/86 → 12/98

10 Petrol 37 02/87 → 12/98

10 Petrol 33 07/94 → 12/98

10 Petrol 37 07/94 → 12/98

10 Petrol 33 07/86 → 12/98

10 Petrol 37 02/87 → 12/98

10 Petrol 37 07/92 → 12/98

11 Petrol 40 06/91 → 04/94 KITPF2C B6

11 Petrol 44 01/91 → 12/97 B03 B1

11 Petrol 44 06/91 → 12/96 KITPF2C B6

11 Petrol 44 10/89 → 12/97 ENGINE: TU1MZ

11 Petrol 44 01/93 → 12/97

11 Petrol 44 06/92 → 12/97

11 Petrol 44 09/86 → 12/97 ENGINE: TU1M(HDZ)H1B

11 Petrol 44 07/94 → 12/97

11 Petrol 44 09/86 → 12/97

11 Petrol 44 09/86 → 12/97

11 Petrol 44 10/89 → 12/97

14 Petrol 55 01/93 → 04/97

14 Petrol 55 05/91 → 04/97

14 Petrol 49 06/88 → 12/89 ENGINE: K2AK2B

14 Petrol 55 04/87 → 04/97 ENGINE: TU3M,Z(KDX,Y,Z)

14 Petrol 55 07/94 → 12/96

14 Petrol 55 04/87 → 04/97

14 Petrol 55 04/87 → 04/97

14 Petrol 55 08/88 → 08/93

1.4 GTi Petrol 74 06/91 → 12/92 SVF015 B6

11 4x4 Petrol 40 06/91 → 07/92 KITPF2C B6

14 4x4 Petrol 55 01/93 → 12/96

14 4x4 Petrol 55 08/91 → 12/96

14 4x4 Petrol 55 07/94 → 12/96

14 4x4 Petrol 55 08/91 → 12/96

14 4x4 Petrol 55 08/91 → 08/93

BERLINGO (B9)

1.4 Petrol 55 03/09 →

1.6 Petrol 66 04/08 →

1.6 Petrol 80 04/08 →

1.6 HDi 110 Diesel 80 04/08 →

1.6 HDi 110 Diesel 80 04/08 →



TYPE

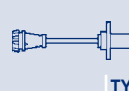

TYPE



TYPE

								SUA188	J3
	PRT03/04	SZA102	F1						
		SPA104	F1						
		SPA104	F1						
					SAG156	H1		ESS0034A	J1
					SAG156	H1		GA2184	J2
							BAE680CV		
							BAE680CV		
								GA2184	J2
								ESS0034A	J1
								ESS514	J1
	PRT03/04	SZA102	F1						
		SPA104	F1						
					SAG156	H1			
							BAE507BK		
							BAE680CV		
								ESS0034A	J1
								GA2184	J2
								ESS514	J1
		SPA104	F1		SAG156	H1			
					SAG150	H1			
							BAE507BK		
							BAE507BK		
							BAE680CV		
								ESS0034A	J1
								GA2184	J2
								ESS514	J1
					SAG156	H1		GA2184	J2
		SPA104	F1		SAG156	H1			
					SAG150	H1		ESS0034A	J1
							BAE680CV		
								GA2184	J2
								ESS514	J1
FEI0002									
		SPA161	F1	SAA118					
		SPA161	F1	SAA118					
APS38		ATS22	F2	SAA118	SAC096	H2		SUA584	J3
					SAG167	H1			



KW



TYPE



TYPE

CITROËN

BERLINGO (B9)

1.6 HDi 75	Diesel	55	04/08 →					
1.6 HDi 75	Diesel	55	04/08 →					
1.6 HDi 90	Diesel	66	04/08 →					
1.6 HDi 90	Diesel	66	04/08 →					
1.6 VTi 120	Petrol	88	11/09 →					
1.6 VTi 95	Petrol	72	07/10 →					

BERLINGO (MF)

1.4	Petrol	53	11/02 → 10/05					
1.4 bivalent	Petrol/CNG	48	11/02 →					
1.4 Hybrid	Hybrid	54	05/05 → 05/08					
1.4 i bivalent (MFKFW)	BiFuel	55	04/03 →					
1.6 16V (MFNFU)	Petrol	80	10/00 →			TB0015		B3
1.6 16V (MFNFU)	Petrol	80	10/00 → 11/02					
1.6 16V (MFNFU)	Petrol	80	10/00 → 10/02					
1.6 16V (MFNFU)	Petrol	81	11/02 → 08/05					
1.6 16V (MFNFU)	Petrol	80	11/02 →					
1.6 16V (MFNFU)	Petrol	80	01/01 →	ENGINE: TU5JP4				
1.6 HDi 110	Diesel	80	08/05 →					
1.6 HDi 75 (MF9HW)	Diesel	55	07/05 →					
1.6 HDi 75 (MF9HW)	Diesel	55	07/05 →					
1.6 HDi 90 (MF9HX)	Diesel	66	07/05 →					
1.6 HDi 90 (MF9HX)	Diesel	66	07/05 →					
1.8 D (MFA9A)	Diesel	43	07/98 →					
1.8 D (MFA9A)	Diesel	43	09/99 →					
1.8 i (MFLFX)	Petrol	66	05/97 →	ENGINE: XU7JB		B32/00		B1
1.8 i (MFLFX)	Petrol	66	05/97 →			KITPF2C		B6
1.8 i (MFLFX)	Petrol	66	05/97 →					
1.8 i (MFLFX)	Petrol	66	05/97 → 12/98					
1.8 i (MFLFX)	Petrol	66	05/97 →	ENGINE: XU7JB				
1.8 i (MFLFX)	Petrol	66	09/99 →					
1.8 i 4WD (MFLFX)	Petrol	66	04/97 → 12/98					
1.8 i 4WD (MFLFX)	Petrol	66	04/97 →					
1.8 i 4WD (MFLFX)	Petrol	66	04/97 →					
1.8 i 4WD (MFLFX)	Petrol	66	09/99 →					
1.9 D (MFWJZ)	Diesel	51	07/98 →					
1.9 D (MFWJZ)	Diesel	51	09/99 →					
1.9 D (MFWJZ)	Diesel	51	11/02 →					
1.9 D (MFWJZ)	Diesel	51	07/98 → 12/00	ENGINE: XUD9				
1.9 D (MFWJZ)	Diesel	51	01/01 →	ENGINE: DW8				
1.9 D 4WD (MFWJZ)	Diesel	51	07/98 →					
1.9 D 4WD (MFWJZ)	Diesel	51	09/99 →					
1.9 D 4WD (MFWJZ)	Diesel	51	11/02 →					
1.9 D 4WD (MFWJZ)	Diesel	51	07/98 → 12/00	ENGINE: XUD9				
1.9 D 4WD (MFWJZ)	Diesel	51	01/01 →	ENGINE: DW8				



TYPE

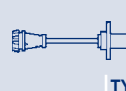

TYPE



TYPE

	APS38		ATS22	F2	SAA118	SAC096	H2	SUA584	J3
						SAG167	H1		
	APS38		ATS22	F2	SAA118	SAC096	H2	SUA584	J3
						SAG167	H1		
	APS71							BAE680BR	
								BAE680BR	
FEI0002					SAA118				
			SPA107	F1	SAA118	SAG164	H1		
			SPA107	F1					
FEI0002	APS77		SPA107	F1	SAA118	SAG164	H1		
			SPA107	F1	SAA118	SAD030	H3		
	APS77								
			SPA167	F1		SAG126	H1		
			SPA107	F1					
						SAG164	H1		
								GA2002	J2
						SAG167	H1		
	APS38		ATS22	F2	SAA118	SAC096	H2		
			SPA172	F1		SAG167	H1		
	APS38		ATS22	F2	SAA118	SAC096	H2		
			SPA172	F1		SAG167	H1		
					SAA118	SAG028	H1		
						SAG027	H1		
		KITRPM40	SZA101	F1					
IWP049/1					SAA118	SAD033	H3	ESS0092A	J1
						SAG028	H1		
	APS76								
		RPM40							
						SAG027	H1		
	APS76								
					SAA118	SAD033	H3	ESS0092A	J1
						SAG028	H1		
						SAG027	H1		
			SPA107	F1	SAA118	SAG028	H1		
						SAG027	H1		
						SAG150	H1		
								SUA371	J3
								SUA405	J3
					SAA118	SAG028	H1		
						SAG027	H1		
						SAG150	H1		
								SUA371	J3
								SUA405	J3



KW

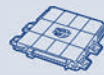

TYPE



TYPE

CITROËN

BERLINGO (MF)

2.0 HDi 90 (MFRHY)	Diesel	66	12/99 → 10/02				
2.0 HDi 90 (MFRHY)	Diesel	66	11/02 →				
2.0 HDi 90 (MFRHY)	Diesel	66	12/99 →				
2.0 HDi 90 (MFRHY)	Diesel	66	01/01 →				
2.0 HDi 90 (MFRHY)	Diesel	66	06/00 → 11/02				
electrique		16	01/00 →				

BERLINGO Furgonato (B9)

1.6	Petrol	66	04/08 →				
1.6	Petrol	80	04/08 →				
1.6 HDi 110	Diesel	80	04/08 →				
1.6 HDi 110	Diesel	80	04/08 →				
1.6 HDi 75	Diesel	55	04/08 →				
1.6 HDi 75	Diesel	55	04/08 →				
1.6 HDi 90	Diesel	66	04/08 →				
1.6 HDi 90	Diesel	66	04/08 →				
1.6 VTi 120	Petrol	88	11/09 →				
1.6 VTi 95	Petrol	72	07/10 →				

BERLINGO Furgonato (M_)

1.4 bivalent	Petrol/CNG	48	11/02 →				
1.4 i bivalent (MBKFW)	BiFuel	55	04/03 →				
1.6 16V (MBNFU)	Petrol	80	10/00 →			TB0015	B3
1.6 16V (MBNFU)	Petrol	80	10/00 → 11/02				
1.6 16V (MBNFU)	Petrol	80	10/00 → 10/02				
1.6 16V (MBNFU)	Petrol	80	11/02 →				
1.6 HDi 75 (MB9HW)	Diesel	55	07/05 →				
1.6 HDi 75 (MB9HW)	Diesel	55	07/05 →				
1.6 HDi 90 (MB9HX, MC9HX)	Diesel	66	07/05 →				
1.6 HDi 90 (MB9HX, MC9HX)	Diesel	66	07/05 →				
1.8 i	Petrol	66	08/99 → 10/02	ENGINE: XU7JB		B32/00	B1
1.8 i	Petrol	66	08/99 → 10/02			KITPF2C	B6
1.9 D 70 (MBWJZ, MCWJZ)	Diesel	51	04/99 →				
1.9 D 70 (MBWJZ, MCWJZ)	Diesel	51	09/99 →				
1.9 D 70 (MBWJZ, MCWJZ)	Diesel	51	11/02 →				
1.9 D 70 (MBWJZ, MCWJZ)	Diesel	51	04/99 → 12/00	ENGINE: XUD9			
1.9 D 70 (MBWJZ, MCWJZ)	Diesel	51	01/01 →	ENGINE: DW8			
1.9 D 70 4WD (MBWJZ, MCWJZ)	Diesel	51	07/98 →				
1.9 D 70 4WD (MBWJZ, MCWJZ)	Diesel	51	09/99 →				
1.9 D 70 4WD (MBWJZ, MCWJZ)	Diesel	51	11/02 →				
1.9 D 70 4WD (MBWJZ, MCWJZ)	Diesel	51	07/98 → 12/00	ENGINE: XUD9			



TYPE

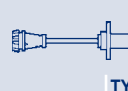

TYPE



TYPE

				SPA167	F1							
				SPA172	F1							
						SAA118	SAG027	H1				
											SUA377	J2
											GA2033	J2
							SAG027	H1				
				SPA161	F1	SAA118						
				SPA161	F1	SAA118						
	APS38			ATS22	F2	SAA118	SAC096	H2				
							SAG167	H1				
	APS38			ATS22	F2	SAA118	SAC096	H2				
							SAG167	H1				
	APS38			ATS22	F2	SAA118	SAC096	H2				
							SAG167	H1				
											BAE680BR	
											BAE680BR	
				SPA107	F1	SAA118	SAG164	H1				
FEI0002	APS77			SPA107	F1	SAA118	SAG164	H1				
				SPA107	F1	SAA118						
	APS77											
				SPA167	F1		SAG126	H1				
							SAG164	H1				
				ATS22	F2	SAA118	SAC096	H2				
							SAG167	H1				
				ATS22	F2	SAA118	SAC096	H2				
							SAG167	H1				
						SAA118	SAD033	H3				
				SPA107	F1	SAA118	SAG028	H1				
							SAG027	H1				
							SAG150	H1				
											SUA371	J3
											SUA405	J3
						SAA118	SAG028	H1				
							SAG027	H1				
							SAG150	H1				
											SUA371	J3



KW



TYPE



TYPE

CITROËN

BERLINGO Furgonato (M_)

1.9 D 70 4WD (MBWJZ, MCWJZ)	Diesel	51	01/01 →	ENGINE: DW8				
2.0 HDI 90 (MBRHY, MCRHY)	Diesel	66	12/99 → 10/02					
2.0 HDI 90 (MBRHY, MCRHY)	Diesel	66	11/02 →					
2.0 HDI 90 (MBRHY, MCRHY)	Diesel	66	12/99 →					
2.0 HDI 90 (MBRHY, MCRHY)	Diesel	66	01/01 →					
2.0 HDI 90 (MBRHY, MCRHY)	Diesel	66	06/00 → 11/02					
2.0 HDI 90 4WD (MBRHY, MCRHY)	Diesel	66	11/00 → 10/02					
2.0 HDI 90 4WD (MBRHY, MCRHY)	Diesel	66	11/02 →					
2.0 HDI 90 4WD (MBRHY, MCRHY)	Diesel	66	11/00 →					
2.0 HDI 90 4WD (MBRHY, MCRHY)	Diesel	66	11/00 → 11/02					

BX (XB_)

14	Petrol	55	01/89 → 02/93					
14	Petrol	55	01/89 → 02/93					
15	Petrol	59	01/91 → 05/92			B04	B1	
16	Petrol	53	01/91 → 02/93			B04	B1	
16	Petrol	55	01/91 → 02/93			B04	B1	
16	Petrol	58	01/91 → 02/93			B04	B1	
16	Petrol	64	01/91 → 02/93			B04	B1	
16	Petrol	76	03/86 → 02/93			SVF010	B6	
16	Petrol	76	01/91 → 02/93			B04	B1	
16	Petrol	55	09/88 → 02/93					
16	Petrol	68	10/82 → 12/92					
16	Petrol	76	03/86 → 02/93					
19	Petrol	70	09/86 → 11/89					
14 E	Petrol	45	10/82 → 06/88					
14 E	Petrol	49	09/85 → 02/93					
14 E	Petrol	52	04/83 → 07/89					
14 E	Petrol	53	04/83 → 02/93					
16 E	Petrol	65	05/89 → 02/93			CP90/011	B6	
16 E	Petrol	65	01/91 → 02/93			B04	B1	
16 E	Petrol	65	05/89 → 02/93	ENGINE: XU5M2Z				
16 E	Petrol	65	01/91 → 02/93	ENGINE: XU5MZ				
19 D	Diesel	47	09/83 → 12/87					
19 E	Petrol	80	06/88 → 02/93					
19 GTi	Petrol	88	06/88 → 02/93			SVF010	B6	
19 GTi	Petrol	90	07/86 → 05/90			SVF010	B6	
19 GTi	Petrol	90	05/90 → 07/90			SVF015	B6	
19 GTi	Petrol	90	07/86 → 02/93					
19 GTi	Petrol	90	07/86 → 02/93					

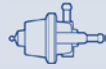

TYPE



TYPE



TYPE

									SUA405	J3
				SPA167	F1					
				SPA172	F1					
						SAA118	SAG027	H1		
									SUA377	J2
									GA2033	J2
				SPA167	F1					
				SPA172	F1					
						SAA118				
									GA2033	J2
									ESS514	J1
									SUA319	J3
									PI024	J1
									PI024	J1
									SUA319	J3
									SUA319	J3
				SPA104	F1					
									SUA319	J3
									SUA319	J3
									SUA319	J3
				SPA104	F1					
							SAG150	H1		
	PRT03/04									
				SZA102	F1					
									SUA319	J3
	APS45									
									PI024	J1
									SUA319	J3



KW



TYPE



TYPE

CITROËN

BX (XB-_)

19 GTi 16V	Petrol	108	03/88 → 02/93				SVF010	B6
19 GTi 4x4	Petrol	88	06/88 → 02/93				SVF010	B6
TRD Turbo	Diesel	66	03/88 → 02/93					

BX Break (XB-_)

14	Petrol	55	01/89 → 02/93					
16	Petrol	53	01/91 → 12/94				B04	B1
16	Petrol	55	01/91 → 12/94				B04	B1
16	Petrol	64	01/91 → 12/94				B04	B1
16	Petrol	65	05/89 → 12/94				CP90/011	B6
16	Petrol	65	05/89 → 12/94				PF90/018	B6
16	Petrol	65	01/91 → 12/94				B04	B1
16	Petrol	76	03/86 → 12/94				SVF010	B6
16	Petrol	76	01/91 → 12/94				B04	B1
16	Petrol	65	05/89 → 12/93					
16	Petrol	65	04/91 → 12/93					
16	Petrol	65	07/94 → 12/94					
16	Petrol	55	09/88 → 12/94					
19	Petrol	88	06/88 → 03/93				SVF010	B6
19	Petrol	80	06/88 → 12/94					
19	Petrol	75	07/86 → 12/94					
18 D	Diesel	44	10/85 → 09/93					
19 Cat.	Petrol	75	07/86 → 12/94				SVF010	B6
19 Cat.	Petrol	75	07/86 → 12/94					
19 D	Diesel	47	09/83 → 12/87					
19 D	Diesel	51	03/87 → 12/94					

C1 (PM_, PN_)

1.0	Petrol	50	06/05 →					
1.0	Petrol	50	06/05 →					
1.0	Petrol	50	06/05 →					
1.4 HDi	Diesel	40	06/05 →					
1.4 HDi	Diesel	40	06/05 →					

C15 (VD-_)

1.1 i	Petrol	44	07/88 → 12/96					
1.4 i	Petrol	55	05/91 → 12/96					
1.9 D	Diesel	44	12/00 → 12/05					

C2 (JM_)

1.1	Petrol	44	09/03 →	ENGINE: TU1JP			B35/00	B1
1.1	Petrol	44	09/03 → 01/10	ENGINE: HFX(TU1JP)			42SXPP31	B3
1.1	Petrol	44	09/03 →	ENGINE: HFX(TU1JP)				
1.1	Petrol	44	09/03 →					
1.1	Petrol	44	09/03 → 10/03					
1.4	Petrol	54	09/03 →					
1.4	Petrol	55	10/06 →					
1.4	Petrol	54	09/03 → 10/03					



TYPE

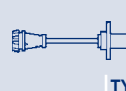

TYPE



TYPE

				SPA104	F1				PI024	J1
									SUA319	J3
									ESS514	J1
									PI024	J1
				SPA104	F1					
						SAG150	H1			
								BAE680AF		
									PI024	J1
	APS45									
									SUA319	J3
									SUA319	J3
						SAG150	H1		PI024	J1
									SUA319	J3
									SUA319	J3
									SUA319	J3
	APS75			SPA162	F1	SAC091	H2	BAE680CB	GA2225	J2
						SAD025	H3			
						SAG152	H1			
				ATS22	F2	SAA118			SUA560	J3
				SPA172	F1	SAG168	H1			
									ESS514	J1
				SPA104	F1				ESS0034A	J1
						SAA118				
	IPM002									
		APS77		SPA107	F1	SAA118	SAG164	H1	GA2198	J2
							SAD030	H3		
	FEI0002	APS77		SPA107	F1	SAA118	SAG164	H1	GA2198	J2
				SPA107	F1					
							SAD030	H3		



KW



TYPE



TYPE

CITROËN

C2 (JM_)

1.4 16V	Petrol	65	06/06 →	ENGINE: KFUET3J4		50SMP1	B3
1.4 16V	Petrol	65	06/06 →				
1.4 HDi	Diesel	50	09/03 →			AMM19765	B4
1.4 HDi	Diesel	50	09/03 →				
1.6	Petrol	80	09/03 →			TB0015	B3
1.6 HDi	Diesel	80	09/05 →				
1.6 HDi	Diesel	80	09/05 →				
1.6 VTS	Petrol	90	01/05 →			TB0015	B3
1.6 VTS	Petrol	90	01/05 → 04/05				

C2 ENTERPRISE

1.4 HDi	Diesel	50	04/09 →				
---------	--------	----	---------	--	--	--	--

C3 I (FC_)

1.1 i	Petrol	44	02/02 →	ENGINE: TU1JP		B35/00	B1
1.1 i	Petrol	44	02/02 → 05/05	ENGINE: HFX(TU1JP)		42SXPP31	B3
1.1 i	Petrol	44	02/02 →	ENGINE: HFX(TU1JP)			
1.1 i	Petrol	44	02/02 → 08/05				
1.1 i	Petrol	44	02/02 →				
1.1 i	Petrol	44	02/02 →				
1.1 i	Petrol	44	04/03 → 08/05				
1.4 16V	Petrol	65	12/03 →	ENGINE: KFUET3J4		50SMP1	B3
1.4 16V	Petrol	65	12/03 →	ENGINE: ET3			
1.4 16V	Petrol	65	12/03 → 08/05				
1.4 16V	Petrol	65	12/03 →				
1.4 16V HDi	Diesel	66	02/02 →				
1.4 16V HDi	Diesel	66	02/02 →				
1.4 HDi	Diesel	50	02/02 →			AMM19765	B4
1.4 HDi	Diesel	50	02/02 →				
1.4 HDi	Diesel	55	05/05 →				
1.4 i	Petrol	54	02/02 →				
1.4 i Bivalent	Petrol/CNG	54	02/02 →				
1.4 i Bivalent	Petrol/CNG	54	02/02 →	ENGINE: ET3			
1.4 i Bivalent	Petrol/CNG	54	02/02 → 08/05				
1.4 i Bivalent	Petrol/CNG	54	04/03 → 08/05				
1.6 16V	Petrol	80	02/02 →			TB0015	B3
1.6 16V	Petrol	80	02/02 → 08/05				
1.6 16V	Petrol	80	02/02 →				
1.6 16V	Petrol	80	02/02 → 09/02				
1.6 16V	Petrol	80	09/05 →				
1.6 16V	Petrol	80	04/03 → 08/05				
1.6 16V HDi	Diesel	66	10/05 →				
1.6 16V HDi	Diesel	80	09/05 →				
1.6 16V HDi	Diesel	66	10/05 →				
1.6 16V HDi	Diesel	80	09/05 →				

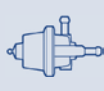

TYPE

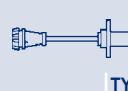

TYPE



TYPE

				SPA161	F1	SAA118	SAG164	H1	BAE680CA	GA2198	J2
				ATS22	F2	SAA118	SAC100	H2			
				SPA172	F1		SAG167	H1			
	APS77			SPA107	F1	SAA118	SAG164	H1		GA2198	J2
				ATS22	F2	SAA118	SAC096	H2			
							SAG167	H1			
	APS77			SPA161	F1	SAA118	SAG164	H1		GA2198	J2
				SPA107	F1						
							SAG167	H1			
	IPM002										
		APS77									
				SPA107	F1	SAA118	SAD030	H3		GA2221	J2
							SAG164	H1			
										GA2041	J2
	IPM012										
		APS77									
				SPA107	F1	SAA118	SAG164	H1	BAE680CA	GA2221	J2
		APS38		SPA172	F1	SAA118	SAC096	H2		SUA591	J3
							SAG168	H1			
				ATS22	F2	SAA118	SAC100	H2		SUA591	J3
				SPA172	F1		SAG167	H1			
							SAG167	H1			
	FEI0002					SAA118	SAD030	H3		GA2221	J2
	FEI0002			SPA107	F1	SAA118	SAG164	H1		GA2221	J2
	IPM012										
		APS77									
										GA2041	J2
				SPA107	F1	SAA118	SAG164	H1		GA2221	J2
		APS77									
										SUA591	J3
							SAD030	H3			
							SAG130	H1			
										GA2041	J2
		APS38		ATS22	F2	SAA118	SAC096	H2			
		APS38		ATS22	F2	SAA118	SAC096	H2		SUA591	J3
							SAG167	H1			
				SPA172	F1		SAG167	H1			



KW



TYPE



TYPE

CITROËN

C3 II

1.1	Petrol	44	11/09 →					
1.4	Petrol	54	11/09 →					
1.4 HDi 70	Diesel	50	11/09 →					
1.4 VTi 95	Petrol	70	11/09 →	ENGINE: KFTTU3AE5			44GTE3P	B3
1.4 VTi 95	Petrol	70	11/09 →					
1.6 HDi	Diesel	68	11/09 →					
1.6 HDi 110	Diesel	82	11/09 →					
1.6 HDi 90	Diesel	66	11/09 →					
1.6 VTi 120	Petrol	88	11/09 →					

C3 Picasso

1.4 VTi 95	Petrol	70	02/09 →					
1.6 HDi	Diesel	66	02/09 →					
1.6 HDi	Diesel	80	02/09 →					
1.6 VTi 120	Petrol	88	02/09 →					

C3 Pluriel (HB_)

1.4	Petrol	54	05/03 →					
1.4	Petrol	54	05/03 →	ENGINE: ET3				
1.4	Petrol	54	05/03 → 10/03					
1.4 HDi	Diesel	50	04/04 →				AMM19765	B4
1.4 HDi	Diesel	50	04/04 →					
1.4 Hybrid	Petrol	54	05/05 →					
1.6	Petrol	80	05/03 →				TB0015	B3

C4 Coupé (LA_)

1.4 16V	Petrol	65	11/04 →	ENGINE: ET3				
1.4 16V	Petrol	65	11/04 →					
1.6 16V	Petrol	80	11/04 →					
1.6 HDi	Diesel	66	11/04 →					
1.6 HDi	Diesel	80	11/04 →					
1.6 HDi	Diesel	66	11/04 →					
1.6 HDi	Diesel	80	11/04 →					
1.6 THP 150	Petrol	110	07/08 →					
1.6 VTi 120	Petrol	88	07/08 →					
1.6 VTi 120	Petrol	88	07/08 → 07/10					
2.0 16V	Petrol	130	11/04 →	ENGINE: EW10J4S	IAW6LPA.02	A1		
2.0 16V	Petrol	100	11/04 →					
2.0 16V	Petrol	130	11/04 →					
2.0 HDi	Diesel	100	11/04 →	ENGINE: DW10BTED4, RHR(DW10BTED4)			50CDDP9	B3
2.0 HDi	Diesel	100	11/04 →	ENGINE: RHR(DW10BTED4)			50CDDP8	B3
2.0 HDi	Diesel	100	11/04 →					
2.0 HDi	Diesel	100	11/04 →					



TYPE



TYPE



TYPE

									GA2143	J2	
									GA2143	J2	
									SUA578	J3	
							SAC072	H2	BAE680BR	GA2129	J2
									SUA578	J3	
									SUA578	J3	
							SAG167	H1			
							SAC072	H2	BAE680BR		
		APS71							BAE680BR	GA2215	J2
							SAG167	H1			
							SAG167	H1			
		APS71					SAC072	H2	BAE680BR	GA2215	J2
FEI0002	APS77		SPA107	F1	SAA118	SAG164	H1		GA2041	J2	
IPM012											
							SAD030	H3			
			ATS22	F2	SAA118	SAC100	H2		SUA591	J3	
			SPA172	F1		SAG167	H1				
			SPA107	F1							
	APS77		SPA107	F1	SAA118	SAG164	H1		GA2041	J2	
IPM012											
	APS77		SPA107	F1	SAA118	SAG164	H1		ESS0015A	J1	
	APS77		SPA107	F1	SAA118	SAG130	H1		ESS0015A	J1	
	APS38		ATS22	F2	SAA118	SAC096	H2		SUA456	J3	
	APS38		ATS22	F2	SAA118	SAC096	H2		SUA456	J3	
			SPA172	F1		SAG167	H1				
			SPA172	F1		SAG167	H1				
	APS47					SAC072	H2				
	APS71										
									BAE680BR		
	APS62		SPA107	F1	SAA118	SAC070	H2		ESS0015A	J1	
	APS77		SPA107	F1	SAA118	SAC070	H2		ESS0015A	J1	
	APS38		ATS22	F2	SAA118	SAC096	H2		SUA456	J3	
						SAG169	H1				



KW

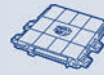

TYPE



TYPE

CITROËN

C4 Grand Picasso I (UA_)

1.6 16V	Petrol	103	07/08 →				
1.6 16V	Petrol	110	10/08 →				
1.6 16V	Petrol	103	07/08 → 11/09				
1.6 HDi	Diesel	80	10/06 →				
1.6 HDi	Diesel	80	10/06 →				
1.6 VTi 120	Petrol	88	07/08 →				
1.8 i 16V	Petrol	92	10/06 →				
2.0 HDi 138	Diesel	100	10/06 →	ENGINE: RHR(DW10BTED4), RHJ(DW10BTED4)		50CDDP8	B3
2.0 HDi 138	Diesel	100	10/06 →				
2.0 HDi 138	Diesel	100	10/06 →				
2.0 i 16V	Petrol	103	10/06 →				

C4 I (LC_)

1.4 16V	Petrol	65	11/04 →	ENGINE: KFUET3J4		50SMP1	B3
1.4 16V	Petrol	65	11/04 →	ENGINE: ET3			
1.4 16V	Petrol	65	11/04 →				
1.4 16V	Petrol	65	06/06 →				
1.6 16V	Petrol	80	11/04 →				
1.6 16V	Petrol	80	06/06 →				
1.6 16V Bio-Flex	BiFuel	80	09/07 →			TB0015	B3
1.6 HDi	Diesel	66	11/04 →				
1.6 HDi	Diesel	80	11/04 →				
1.6 HDi	Diesel	66	11/04 →				
1.6 HDi	Diesel	80	11/04 →				
1.6 THP 140	Petrol	103	07/08 →				
1.6 THP 140	Petrol	103	07/08 → 07/09				
1.6 THP 150	Petrol	110	07/08 →				
1.6 VTi 120	Petrol	88	07/08 →				
1.6 VTi 120	Petrol	88	07/08 → 09/10				
2.0 16V	Petrol	130	11/04 →	ENGINE: EW10J4S	IAW6LPA.02	A1	
2.0 16V	Petrol	100	11/04 →				
2.0 16V	Petrol	103	11/04 →				
2.0 16V	Petrol	130	02/05 →				
2.0 16V	Petrol	130	11/04 →				
2.0 16V	Petrol	100	06/06 →				
2.0 16V	Petrol	103	06/06 →				
2.0 16V	Petrol	130	06/06 →				
2.0 HDi	Diesel	100	11/04 →	ENGINE: RHR(DW10BTED4)		50CDDP8	B3
2.0 HDi	Diesel	100	11/04 →				
2.0 HDi	Diesel	100	11/04 →				



TYPE

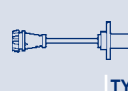

TYPE



TYPE

	APS47									
	APS47					SAC072	H2			
						SAC072	H2			
		ATS22	F2	SAA118	SAC096	H2		SUA584	J3	
					SAG167	H1				
	APS71	SPA161	F1	SAA118				BAE680BR		
				SAA118						
		ATS22	F2	SAA118	SAC096	H2		SUA584	J3	
					SAG169	H1				
				SAA118						
IPM012										
	APS77	SPA107	F1	SAA118	SAG164	H1	BAE680CA	ESS0015A	J1	
								GA2042	J2	
	APS77	SPA107	F1	SAA118	SAG130	H1		ESS0015A	J1	
								GA2042	J2	
		SPA107	F1	SAA118				GA2059	J2	
	APS38	ATS22	F2	SAA118	SAC096	H2				
	APS38	ATS22	F2	SAA118	SAC096	H2		SUA456	J3	
		SPA172	F1		SAG167	H1				
		SPA172	F1		SAG167	H1				
	APS47									
					SAC072	H2				
	APS47	SPA161	F1	SAA118	SAC072	H2				
	APS71	SPA161	F1	SAA118						
								BAE680BR		
	APS62	SPA107	F1	SAA118	SAC070	H2		ESS0015A	J1	
	APS77	SPA172	F1	SAA118	SAC070	H2				
		SPA107	F1							
				SAA118	SAC070	H2				
								GA2042	J2	
								GA2042	J2	
								GA2042	J2	
	APS38	ATS22	F2	SAA118	SAC096	H2		SUA456	J3	
					SAG169	H1				



KW



TYPE



TYPE

CITROËN

C4 II (B7)

1.4 VTi 95	Petrol	70	09/10 →					
1.4 VTi 95	Petrol	70	11/09 →					
1.6 HDi 110	Diesel	82	11/09 →					
1.6 HDi 90	Diesel	68	11/09 →					
1.6 THP 155	Petrol	115	11/09 →					
1.6 VTi 120	Petrol	88	09/10 →					
1.6 VTi 120	Petrol	88	11/09 →					
1.6 VTi 120 LPG	Petrol/LPG	88	09/11 →					
2.0 HDi 150	Diesel	110	11/09 →					

C4 Picasso I (UD_)

1.6 16V	Petrol	110	07/08 →					
1.6 HDi	Diesel	80	02/07 →					
1.6 HDi	Diesel	80	02/07 →					
1.6 THP 140	Petrol	103	07/08 →					
1.6 THP 140	Petrol	103	07/08 → 11/09					
1.6 VTi 120	Petrol	88	07/08 →					
1.8 i 16V	Petrol	92	02/07 →					
2.0 HDi 138	Diesel	100	02/07 →	ENGINE: RHR(DW10BTED4), RHJ(DW10BTED4)			50CDDP8	B3
2.0 HDi 138	Diesel	100	02/07 →					
2.0 HDi 138	Diesel	100	02/07 →					
2.0 i 16V	Petrol	103	02/07 →					

C4 Tre volumi

1.6 16V	Petrol	80	04/07 →					
1.6 HDi	Diesel	80	07/06 →					

C5 I (DC_)

1.8 16V (DC6FZB, DC6FZE)	Petrol	85	03/01 → 08/04					
1.8 16V (DC6FZB, DC6FZE)	Petrol	85	03/01 → 08/04					
2.0 16V (DCRFNC, DCRFNF)	Petrol	100	03/01 → 08/04	ENGINE: EW10J4,L5	IAW48P2.31/1	A1		
2.0 16V (DCRFNC, DCRFNF)	Petrol	100	03/01 → 08/04					
2.0 16V (DCRFNC, DCRFNF)	Petrol	100	03/01 → 08/04					
2.0 16V (DCRFNC, DCRFNF)	Petrol	100	03/01 → 04/02					
2.0 16V HPi (DCRLZB)	Petrol	103	03/01 → 08/04	ENGINE: RLZEW10D			60CPM1	B3
2.0 16V HPi (DCRLZB)	Petrol	103	03/01 → 08/04					
2.0 16V HPi (DCRLZB)	Petrol	103	03/01 → 04/02					
2.0 HDi	Diesel	79	03/01 → 08/04					
2.0 HDi (DCRHVB)	Diesel	66	03/01 → 08/04					
2.0 HDi (DCRHZB, DCRHZE)	Diesel	80	03/01 → 08/04					
2.2 HDi (DC4HXB, DC4HXE)	Diesel	98	03/01 → 08/04					
3.0 V6 (DCXFXC, DCXFXF)	Petrol	152	03/01 → 08/04					

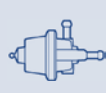

TYPE

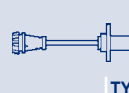

TYPE



TYPE

								BAE680BR	
								GA2104	J2
								SUA567	J3
								SUA567	J3
								GA2051	J2
								BAE680BR	
								GA2104	J2
								BAE680BR	
								SUA567	J3
	APS47					SAC072	H2	GA2086	J2
	APS38	ATS22	F2	SAA118	SAC096	H2		SUA571	J3
					SAG167	H1			
	APS47							GA2086	J2
					SAC072	H2			
	APS71	SPA161	F1	SAA118				BAE680BR	
				SAA118					
	APS38	ATS22	F2	SAA118	SAC096	H2		SUA497	J3
					SAG169	H1			
				SAA118					
		SPA107	F1						
					SAG167	H1			
		SPA107	F1	SAA118	SAC070	H2			
					SAG157	H1			
		IATS04	F2	SAA118	SAC070	H2			
		SPA107	F1		SAD033	H3			
					SAG157	H1			
	APS62	SPA107	F1	SAA118					
					SAG157	H1			
				SAA118					
	APS35	SPA172	F1	SAA118	SAG157	H1			
	APS35	SPA172	F1	SAA118	SAG157	H1			
	APS35	SPA172	F1	SAA118	SAG157	H1			
	APS62	SPA107	F1	SAA118				BAE680BD	

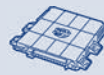
KW

TYPE

TYPE

CITROËN

C5 I Break (DE_)

1.8 16V (DE6FZB, DE6FZE)	Petrol	85	06/01 → 08/04					
1.8 16V (DE6FZB, DE6FZE)	Petrol	85	06/01 → 08/04					
2.0 16V (DERFNF, DERFNC, RERFNC)	Petrol	100	06/01 → 08/04	ENGINE: EW10J4,L5	IAW48P2.31/1	A1		
2.0 16V (DERFNF, DERFNC, RERFNC)	Petrol	100	06/01 → 08/04					
2.0 16V (DERFNF, DERFNC, RERFNC)	Petrol	100	06/01 → 08/04					
2.0 16V (DERFNF, DERFNC, RERFNC)	Petrol	100	06/01 → 04/02					
2.0 16V HPi (DERLZB)	Petrol	103	06/01 → 08/04	ENGINE: RLZEW10D			60CPM1	B3
2.0 16V HPi (DERLZB)	Petrol	103	06/01 → 08/04					
2.0 16V HPi (DERLZB)	Petrol	103	06/01 → 04/02					
2.0 HDi	Diesel	80	06/01 → 08/04					
2.0 HDi (DERHSB, DERHSE)	Diesel	79	06/01 → 08/04					
2.0 HDi (DERHYB)	Diesel	66	06/01 → 08/04					
2.2 HDi (DE4HXB, DE4HXE)	Diesel	98	06/01 → 08/04					
3.0 Carlsson	Petrol	173	09/03 → 08/04					
3.0 V6 (DEXFXC, DEXFXF)	Petrol	152	06/01 → 08/04					

C5 II (RC_)

1.6 HDi (RC8HZB)	Diesel	80	09/04 →					
1.6 HDi (RC8HZB)	Diesel	80	09/04 →					
1.8 16V	Petrol	92	09/05 →					
1.8 16V (RC6FZB)	Petrol	85	09/04 →					
2.0 16V (RCRFJB, RCRFJC)	Petrol	103	09/04 →	ENGINE: EW10J4			B33	B1
2.0 16V (RCRFJB, RCRFJC)	Petrol	103	09/04 →					
2.0 HDi (RCRHRH)	Diesel	100	09/04 →	ENGINE: DW10BTED4, RHR(DW10BTED4)			50CDDP9	B3
2.0 HDi (RCRHRH)	Diesel	100	09/04 →	ENGINE: RHR(DW10BTED4)			50CDDP8	B3
2.0 HDi (RCRHRH)	Diesel	100	09/04 →					
2.0 HDi (RCRHRH)	Diesel	100	09/04 →					
2.2 HDi	Diesel	125	04/06 →					
2.2 HDi	Diesel	125	04/06 →					
2.2 HDi (RC4HXE)	Diesel	98	09/04 →					
3.0 V6 (RCXFUF)	Petrol	152	09/04 →					
3.0 V6 (RCXFUF)	Petrol	152	09/04 →	ENGINE: ES9J4S				

C5 II Break (RE_)

1.6 HDi (RE8HZB)	Diesel	80	09/04 →					
1.6 HDi (RE8HZB)	Diesel	80	09/04 →					
1.8 16V	Petrol	92	09/05 →					
1.8 16V (RE6FZB)	Petrol	85	09/04 →					
2.0 16V (RERFJB, RERFJC)	Petrol	103	09/04 →	ENGINE: EW10J4			B33	B1
2.0 16V (RERFJB, RERFJC)	Petrol	103	09/04 →					
2.0 HDi (RERHRH)	Diesel	100	09/04 →	ENGINE: RHR(DW10BTED4)			50CDDP8	B3



TYPE

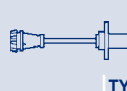

TYPE



TYPE

			SPA107	F1	SAA118	SAC070	H2		
						SAG157	H1		
			IATS04	F2	SAA118	SAC070	H2		
			SPA107	F1		SAD033	H3		
						SAG157	H1		
	APS62		SPA107	F1	SAA118				
						SAG157	H1		
					SAA118				
	APS35		SPA172	F1	SAA118	SAG157	H1		
	APS35		SPA172	F1		SAG157	H1		
	APS35		SPA172	F1	SAA118	SAG157	H1		
			SPA107	F1					
	APS62		SPA107	F1	SAA118			BAE680BD	
	APS38		ATS22	F2	SAA118	SAC096	H2	SUA456	J3
			SPA172	F1		SAG167	H1		
					SAA118	SAC070	H2		
	APS77		SPA107	F1	SAA118	SAC070	H2		
	APS77		SPA172	F1	SAA118	SAC070	H2	GA2000	J2
	APS38		ATS22	F2	SAA118	SAG169	H1	SUA456	J3
								SUA493	J2
						SAG167	H1	SUA456	J3
								SUA493	J2
					SAA118	SAG168	H1	SUA493	J2
	APS62		SPA107	F1	SAA118	SAD008	H3	BAE680BD	
								GA2000	J2
	APS38		ATS22	F2	SAA118	SAC096	H2	SUA456	J3
			SPA172	F1		SAG167	H1		
					SAA118	SAC070	H2		
	APS77		SPA107	F1	SAA118	SAC070	H2		
	APS77		SPA172	F1	SAA118	SAC070	H2	GA2000	J2



KW

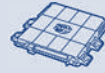

TYPE



TYPE

CITROËN

C5 II Break (RE_)

2.0 HDi (RERHRH)	Diesel	100	09/04 →					
2.0 HDi (RERHRH)	Diesel	100	09/04 →					
2.2 HDi	Diesel	125	04/06 →					
2.2 HDi	Diesel	125	04/06 →					
2.2 HDi (RE4HXE)	Diesel	98	09/04 →					
3.0	Petrol	173	09/04 →					
3.0 V6 (REXFUF)	Petrol	152	09/04 →					
3.0 V6 (REXFUF)	Petrol	152	09/04 →	ENGINE: ES9J4S				

C5 III (RD_)

1.6 HDi	Diesel	80	02/08 →					
1.6 HDi	Diesel	80	02/08 →					
1.6 THP 155	Petrol	115	04/09 →					
1.6 THP 155	Petrol	115	09/09 →					
1.6 VTi 120	Petrol	88	09/10 →					
1.8 16V	Petrol	92	02/08 →					
2.0 16V	Petrol	103	02/08 →					
2.0 16V BioFlex	BiFuel	103	02/08 →					
2.0 HDi	Diesel	100	02/08 →	ENGINE: RHR(DW10BTED4)		50CDDP8		B3
2.0 HDi	Diesel	100	02/08 →					
2.0 HDi	Diesel	100	02/08 →					
2.2 HDi	Diesel	125	02/08 →					
2.2 HDi	Diesel	125	02/08 →					
3.0 V6	Petrol	155	02/08 →					

C5 III Break (TD_)

1.6 HDi	Diesel	80	02/08 →					
1.6 HDi	Diesel	80	02/08 →					
1.6 THP 155	Petrol	115	04/09 →					
1.6 THP 155	Petrol	115	09/09 →					
1.6 VTi 120	Petrol	88	09/10 →					
1.8 16V	Petrol	92	02/08 →					
2.0 16V	Petrol	103	02/08 →					
2.0 16V BioFlex	BiFuel	103	02/08 →					
2.0 HDi	Diesel	100	02/08 →	ENGINE: RHR(DW10BTED4)		50CDDP8		B3
2.0 HDi	Diesel	100	02/08 →					
2.0 HDi	Diesel	100	02/08 →					
2.2 HDi	Diesel	125	02/08 →					
2.2 HDi	Diesel	125	02/08 →					
3.0 V6	Petrol	155	02/08 →					

C6 (TD_)

2.2 HDi	Diesel	125	06/06 →					
2.2 HDi	Diesel	125	06/06 →					
2.7 HDi	Diesel	150	09/06 →	ENGINE: DT17				
3.0 V6	Petrol	155	11/05 →					
3.0 V6	Petrol	155	09/05 →					



TYPE



TYPE



TYPE

	APS38		ATS22	F2	SAA118	SAG169	H1	SUA456	J3
								SUA493	J2
						SAG167	H1	SUA456	J3
								SUA493	J2
					SAA118	SAG168	H1	SUA493	J2
			SPA107	F1				BAE680BD	
	APS62		SPA107	F1	SAA118			BAE680BD	
								GA2000	J2
	APS38		ATS22	F2	SAA118	SAC096	H2	SUA465	J3
						SAG167	H1		
	APS47							GA2064	J2
						SAC072	H2		
								BAE680BR	
			SPA107	F1	SAA118				
			SPA107	F1					
			SPA107	F1					
	APS38		ATS22	F2	SAA118	SAC096	H2		
						SAG169	H1		
			ATS22	F2	SAA118	SAC096	H2		
						SAG167	H1		
			SPA107	F1	SAA118			BAE680BD	
	APS38		ATS22	F2	SAA118	SAC096	H2		
						SAG167	H1		
	APS47							GA2064	J2
						SAC072	H2		
								BAE680BR	
			SPA107	F1	SAA118				
			SPA107	F1	SAA118				
			SPA107	F1					
	APS38		ATS22	F2	SAA118	SAC096	H2		
						SAG169	H1		
			ATS22	F2	SAA118	SAC096	H2		
						SAG167	H1		
			SPA107	F1	SAA118			BAE680BD	
			ATS22	F2	SAA118	SAC096	H2		
						SAG167	H1		
								GA2038	J2
	APS62								
			SPA107	F1	SAA118			BAE680BD	

KW

TYPE

TYPE
CITROËN
C8 (EA_, EB_)

2.0	Petrol	100	07/02 →	ENGINE: EW10J4	IAW48P2.34/2	A1		
2.0	Petrol	100	07/02 →					
2.0	Petrol	100	07/02 →					
2.0 16V	Petrol	103	09/05 →					
2.0 HDi	Diesel	88	02/07 →	ENGINE: RHK(DW10UTED4)			50CDSP6	B3
2.0 HDi	Diesel	88	02/07 → 11/07	ENGINE: RHK(DW10UTED4)			50CDSP3	B3
2.0 HDi	Diesel	88	11/07 →	ENGINE: RHK(DW10UTED4)			50CAD281	B3
2.0 HDi	Diesel	79	07/02 → 06/03					
2.0 HDi	Diesel	88	02/07 →					
2.0 HDi	Diesel	79	07/02 →					
2.0 HDi	Diesel	79	07/02 → 12/06					
2.0 HDi 135	Diesel	100	03/06 →	ENGINE: RHR(DW10BTED4)			50CDDP8	B3
2.0 HDi 135	Diesel	100	03/06 →					
2.0 HDi 135	Diesel	100	03/06 →					
2.2	Petrol	116	07/02 →	ENGINE: 3FZ(EW12J4)			60CPM2	B3
2.2	Petrol	116	07/02 →	ENGINE: 3FZ(EW12J4)			KITBLOW	B2
2.2	Petrol	116	07/02 →					
2.2	Petrol	116	07/02 →					
2.2 HDi	Diesel	94	07/02 →	ENGINE: 4HW(DW12TED4)			50CDDP1	B3
2.2 HDi	Diesel	94	07/02 → 06/03					
2.2 HDi	Diesel	125	06/06 →					
2.2 HDi	Diesel	94	07/02 →					
2.2 HDi	Diesel	125	06/06 →					
2.2 HDi	Diesel	94	07/02 → 07/06					
3.0 V6	Petrol	150	10/02 →					
3.0 V6	Petrol	150	07/02 →					

C-CROSSER (EP_)

2.2 HDi	Diesel	115	02/07 →					
2.2 HDi	Diesel	115	02/07 →					

C-CROSSER ENTERPRISE

2.2 HDi	Diesel	115	01/09 →					
---------	--------	-----	---------	--	--	--	--	--

CX I (MA)

2400 GTi	Petrol	94	06/77 → 06/82					
2400 GTi	Petrol	96	06/77 → 06/82					
25 GTi Turbo 2	Petrol	122	06/84 → 08/85					
25 TRi	Petrol	100	07/83 → 08/85					

CX I Break (MA)

2400	Petrol	85	08/76 → 06/80					
2400 GTi	Petrol	94	07/82 → 06/83					
25 TRi	Petrol	100	07/83 → 08/85					



TYPE

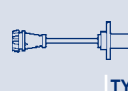

TYPE



TYPE

	APS62		SPA107	F1	SAA118	SAC070	H2		
						SAD033	H3		
	APS77		SPA107	F1	SAA118	SAC070	H2		
	APS35								
	APS38		ATS22	F2	SAA118	SAC096	H2		
			SPA167	F1	SAA118				
								SUA467	J2
			ATS22	F2	SAA118	SAC096	H2		
						SAG169	H1		
			SPA107	F1	SAA118	SAC070	H2		
						SAD033	H3		
	APS35								
			ATS22	F2	SAA118	SAC096	H2		
			SPA167	F1	SAA118				
						SAG167	H1		
								SUA467	J2
	APS62								
			SPA107	F1	SAA118			BAE680BD	
			ATS22	F2	SAA118	SAC096	H2		
						SAG167	H1		
						SAG167	H1		
								PI024	J1
								PI024	J1
								PI024	J1
								PI024	J1
								PI024	J1
								PI024	J1
								PI024	J1



KW



TYPE



TYPE

CITROËN

CITROËN									
CX II									
25 GTi	Petrol	89	05/86 → 12/92						
25 GTi Turbo 2	Petrol	122	08/85 → 12/92						
25 TRi	Petrol	100	08/85 → 12/92						
CX II Break									
25 i	Petrol	89	05/86 → 12/92						
25 TRi	Petrol	100	08/85 → 12/92						
DS3									
1.4 VTi 95	Petrol	70	04/10 →						
1.4 VTi 95	Petrol	70	04/10 →						
1.6 HDi 110	Diesel	82	11/09 →						
1.6 HDi 90	Diesel	68	11/09 →						
1.6 Racing	Petrol	149	02/11 →						
1.6 Racing	Petrol	152	02/11 →						
1.6 THP 155	Petrol	115	04/10 →						
1.6 VTi 120	Petrol	88	04/10 →						
1.6 VTi 120	Petrol	88	04/10 →						
DS4									
1.6 HDi 110	Diesel	81	04/11 →						
1.6 HDi 110	Diesel	82	04/11 →						
DS5									
1.6 THP 155	Petrol	115	11/11 →						
1.6 THP 200	Petrol	147	11/11 →						
EVASION (22, U6)									
1.8	Petrol	73	05/97 → 07/02					B04	B1
1.8	Petrol	73	05/97 → 07/02					PF16080067	B6
1.8	Petrol	73	05/97 → 07/02	ENGINE: XU7JP					
1.8	Petrol	73	05/97 → 07/02	ENGINE: XU7JP					
1.8	Petrol	73	09/99 → 07/02						
1.8	Petrol	73	05/97 → 12/00	ENGINE: C(XU7JP)					
1.8	Petrol	73	05/97 → 12/01	ENGINE: ID(XU7JP)					
1.9 TD	Diesel	66	11/94 → 07/02						
1.9 TD	Diesel	68	10/95 → 12/98						
1.9 TD	Diesel	66	09/99 → 07/02						
2.0	Petrol	89	06/94 → 07/02					B04	B1
2.0	Petrol	89	06/94 → 12/95					PF90/018	B6
2.0	Petrol	89	01/96 → 07/02					PF16080067	B6
2.0	Petrol	89	06/94 → 07/02	ENGINE: XU10J2CZ					
2.0	Petrol	89	06/94 → 07/02	ENGINE: XU10J2CZ					
2.0	Petrol	89	09/99 → 07/02						
2.0	Petrol	89	06/94 → 12/00	ENGINE: C(XU10J2-XU10J2TE-XU10J4R)					
2.0 16V	Petrol	100	05/00 → 07/02	ENGINE: EW10J4				B33	B1
2.0 16V	Petrol	97	05/98 → 04/00	ENGINE: EW10J4				B33	B1
2.0 16V	Petrol	97	05/98 → 12/98						



KW

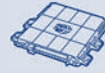

TYPE



TYPE

CITROËN

EVASION (22, U6)

2.0 16V	Petrol	100	05/00 → 07/02						
2.0 16V	Petrol	100	05/00 → 07/02						
2.0 16V	Petrol	97	05/98 → 04/00						
2.0 16V	Petrol	100	05/00 → 07/02						
2.0 16V	Petrol	100	05/00 → 12/00						
2.0 16V	Petrol	97	05/98 → 04/00						
2.0 16V	Petrol	97	09/99 → 04/00						
2.0 HDi	Diesel	80	08/99 → 07/02						
2.0 HDi	Diesel	80	08/99 → 06/01	ENGINE: DW10					
2.0 HDi	Diesel	80	01/01 → 07/02	ENGINE: DW10					
2.0 HDi	Diesel	80	07/01 → 07/02						
2.0 HDi 16V	Diesel	80	09/99 → 07/02						
2.0 HDi 16V	Diesel	80	07/01 → 07/02						
2.0 TD	Diesel	68	05/97 → 07/02						
2.0 Turbo C.T.	Petrol	108	06/94 → 06/95				SVF015	B6	
2.0 Turbo C.T.	Petrol	108	06/94 → 07/02						
2.0 Turbo C.T.	Petrol	108	09/99 → 07/02						

JUMPER Autobus

2.2 HDi 100	Diesel	74	04/06 →				AMM19656	B4	
2.2 HDi 100	Diesel	74	04/06 →	ENGINE: PUMA100					
2.2 HDi 120	Diesel	88	04/06 →				AMM19656	B4	
2.2 HDi 120	Diesel	88	04/06 →	ENGINE: PUMA120					
2.2 HDi 130	Diesel	96	07/11 →				AMM19656	B4	
3.0 HDi 160	Diesel	116	09/06 →						
3.0 HDi 160	Diesel	116	09/06 →	ENGINE: F30DT					
3.0 HDi 180	Diesel	130	07/11 →						

JUMPER Autobus (230P)

1.9 D	Diesel	51	01/99 → 04/02						
1.9 TD	Diesel	66	08/94 → 04/02						
1.9 TD	Diesel	68	02/94 → 04/02						
2.0	Petrol	80	02/94 → 04/94				B04	B1	
2.0	Petrol	80	02/94 → 12/95				PF90/018	B6	
2.0	Petrol	80	01/96 → 04/02				PF16080067	B6	
2.0	Petrol	80	02/94 → 04/02	ENGINE: XU10J2U					
2.0	Petrol	80	02/94 → 04/02	ENGINE: XU10J2U					
2.0	Petrol	80	02/94 → 04/02						
2.0	Petrol	80	02/94 → 04/02						
2.0	Petrol	80	02/94 → 02/02						
2.5 D	Diesel	63	08/94 → 04/02						
2.5 TD	Diesel	76	08/94 → 04/02						
2.8 HDi	Diesel	94	09/00 → 04/02						
2.8 HDi 4x4	Diesel	94	09/00 → 04/02						



TYPE

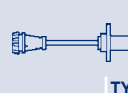

TYPE



TYPE

			SPA107	F1	SAA118	SAC070	H2	SUA146	J3
						SAD033	H3		
					SAA118	SAD008	H3		
						SAG027	H1		
						SAG157	H1		
						SAG028	H1		
						SAG027	H1		
	APS35		SPA107	F1	SAA118	SAG027	H1		
								SUA463	J2
								SUA494	J2
								SUA467	J2
			SPA107	F1					
								SUA467	J2
								SUA146	J3
					SAA118	SAG028	H1	ESS0095A	J1
						SAG027	H1		
					SAA113			ESS0066A	J1
								SUA512	J3
					SAA113			ESS0066A	J1
								SUA512	J3
								ESS0066A	J1
								SUA512	J3
						SAF001	H4		
					SAA118				
			SPA102	F1	SAA118				
					SAA118				
	PRT03/04	KITRPM36	SZA101	F1					
		RPM36							
					SAA118	SAC070	H2	ESS0095A	J1
						SAG150	H1		
								BAE680AF	
					SAA118				
					SAA118				
			SPA103	F1		SAG089	H1	ESS0066A	J1
			SPA103	F1		SAG089	H1	ESS0066A	J1



KW



TYPE



TYPE

CITROËN

JUMPER Autobus (244, Z_)

2.0	Petrol	81	04/02 →						
2.0	Petrol	81	04/02 →						
2.0	Petrol	81	04/02 →						
2.0	Petrol	81	04/02 → 05/06						
2.0 bivalent	Petrol/CNG	81	02/03 →						
2.0 bivalent	Petrol/CNG	81	02/03 →						
2.0 bivalent	Petrol/CNG	81	02/03 → 05/06						
2.0 HDi	Diesel	62	04/02 →						
2.2 HDi	Diesel	74	04/02 →						
2.8 HDi	Diesel	94	04/02 →						

JUMPER Furgonato

2.2 HDi 100	Diesel	74	04/06 →				AMM19656	B4	
2.2 HDi 100	Diesel	74	04/06 →	ENGINE: PUMA100					
2.2 HDi 120	Diesel	88	04/06 →				AMM19656	B4	
2.2 HDi 120	Diesel	88	04/06 →	ENGINE: PUMA120					
2.2 HDi 130	Diesel	96	07/11 →				AMM19656	B4	
3.0 HDi 160	Diesel	116	09/06 →						
3.0 HDi 160	Diesel	116	09/06 →	ENGINE: F30DT					
3.0 HDi 180	Diesel	130	07/11 →						

JUMPER Furgonato (230L)

1.9 D	Diesel	51	02/94 → 04/02						
1.9 TD	Diesel	66	03/94 → 04/02						
1.9 TD	Diesel	68	03/94 → 04/02						
2.0	Petrol	80	03/94 → 04/94				B04	B1	
2.0	Petrol	80	03/94 → 12/95				PF90/018	B6	
2.0	Petrol	80	01/96 → 04/02				PF16080067	B6	
2.0	Petrol	80	03/94 → 04/02	ENGINE: XU10J2U					
2.0	Petrol	80	03/94 → 04/02	ENGINE: XU10J2U					
2.0	Petrol	80	03/94 → 04/02						
2.0	Petrol	80	03/94 → 04/02						
2.0	Petrol	80	03/94 → 02/02						
2.0 4x4	Petrol	80	10/96 → 01/02						
2.0 HDi	Diesel	62	11/01 → 04/02						
2.5 D	Diesel	63	03/94 → 04/02						
2.5 D 4x4	Diesel	63	03/00 → 04/02						
2.5 TD	Diesel	76	03/94 → 04/02						
2.5 TDI	Diesel	79	12/96 → 11/00						
2.5 TDI 4x4	Diesel	79	03/00 → 11/00						
2.8 HDi	Diesel	94	09/00 → 04/02						
2.8 HDi 4x4	Diesel	94	09/00 → 04/02						



TYPE

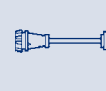

TYPE



TYPE

				SPA167	F1	SAA118	SAC070	H2			
							SAD033	H3			
							SAG157	H1			
									BAE680AF		
						SAA118	SAC070	H2			
							SAD033	H3			
									BAE680AF		
						SAA118				ESS0066A	J1
				SPA172	F1	SAA118	SAG157	H1		ESS0066A	J1
				SPA103	F1		SAG089	H1		ESS0066A	J1
						SAA113				ESS0066A	J1
										SUA512	J3
						SAA113				ESS0066A	J1
										SUA512	J3
										ESS0066A	J1
										SUA512	J3
							SAF001	H4			
						SAA118					
				SPA102	F1	SAA118					
						SAA118					
	PRT03/04	KITRPM36	SZA101	F1		SAA118	SAC070	H2		ESS0095A	J1
		RPM36					SAG150	H1			
									BAE680AF		
									BAE680AF		
										ESS0066A	J1
						SAA118					
						SAA118					
						SAA118					
						SAA118					
						SAA118					
				SPA103	F1		SAG089	H1		ESS0066A	J1
				SPA103	F1		SAG089	H1		ESS0066A	J1

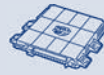
KW

TYPE

TYPE
CITROËN
JUMPER Furgonato (244)

2.0	Petrol	81	04/02 →						
2.0	Petrol	81	04/02 →						
2.0	Petrol	81	04/02 →						
2.0	Petrol	81	04/02 → 05/06						
2.0 bivalent	Petrol/CNG	81	02/03 →						
2.0 bivalent	Petrol/CNG	81	02/03 → 05/06						
2.0 HDi	Diesel	62	04/02 →						
2.2 HDi	Diesel	74	04/02 →						
2.8 HDi	Diesel	107	05/04 →						
2.8 HDi	Diesel	94	04/02 →						
2.8 HDi 4x4	Diesel	94	04/02 →						

JUMPER Pianale piatto/Telaio

2.2 HDi 100	Diesel	74	04/06 →				AMM19656	B4	
2.2 HDi 100	Diesel	74	04/06 →	ENGINE: PUMA100					
2.2 HDi 120	Diesel	88	04/06 →				AMM19656	B4	
2.2 HDi 120	Diesel	88	04/06 →	ENGINE: PUMA120					
2.2 HDi 130	Diesel	96	07/11 →				AMM19656	B4	
3.0 HDi 160	Diesel	116	09/06 →						
3.0 HDi 160	Diesel	116	09/06 →	ENGINE: F30DT					
3.0 HDi 180	Diesel	130	07/11 →						

JUMPER Pianale piatto/Telaio (230)

1.9 TD	Diesel	66	03/94 → 04/02						
1.9 TD	Diesel	68	03/94 → 04/02						
2.0	Petrol	80	03/94 → 04/94				B04	B1	
2.0	Petrol	80	03/94 → 12/95				PF90/018	B6	
2.0	Petrol	80	01/96 → 04/02				PF16080067	B6	
2.0	Petrol	80	03/94 → 04/02						
2.0	Petrol	80	03/94 → 04/02						
2.0	Petrol	80	03/94 → 02/02						
2.5 D	Diesel	63	03/94 → 04/02						
2.5 D 4x4	Diesel	63	03/00 → 04/02						
2.5 TD	Diesel	76	03/94 → 04/02						
2.5 TDI	Diesel	79	12/96 → 04/02						
2.5 TDI 4x4	Diesel	79	03/00 → 04/02						
2.8 HDi	Diesel	94	09/00 → 04/02						
2.8 HDi	Diesel	93	10/00 → 01/02						

JUMPER Pianale piatto/Telaio (244)

2.0 HDi	Diesel	62	04/02 →						
2.2 HDi	Diesel	74	04/02 →						
2.2 HDi	Diesel	74	02/02 → 06/06						
2.8 HDi	Diesel	107	05/04 →						
2.8 HDi	Diesel	94	04/02 →						
2.8 HDi 4x4	Diesel	94	02/02 → 06/06						

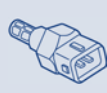
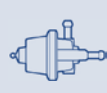

TYPE

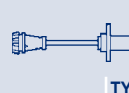

TYPE



TYPE

				SPA167	F1	SAA118	SAC070	H2			
							SAD033	H3			
							SAG157	H1			
									BAE680AF		
						SAA118	SAC070	H2			
									BAE680AF		
						SAA118				ESS0066A	J1
				SPA172	F1	SAA118	SAG157	H1		ESS0066A	J1
				SPA103	F1		SAG089	H1		ESS0066A	J1
				SPA103	F1		SAG089	H1		ESS0066A	J1
				SPA103	F1		SAG089	H1		ESS0066A	J1
						SAA113				ESS0066A	J1
										SUA512	J3
						SAA113				ESS0066A	J1
										SUA512	J3
										ESS0066A	J1
										SUA512	J3
							SAF001	H4			
				SPA102	F1	SAA118					
						SAA118					
						SAA118	SAC070	H2		ESS0095A	J1
							SAG150	H1			
									BAE680AF		
						SAA118					
						SAA118					
						SAA118					
						SAA118					
						SAA118					
				SPA103	F1		SAG089	H1		ESS0066A	J1
										ESS0066A	J1
						SAA118				ESS0066A	J1
				SPA172	F1	SAA118	SAG157	H1		ESS0066A	J1
										ESS0066A	J1
				SPA103	F1		SAG089	H1		ESS0066A	J1
				SPA103	F1		SAG089	H1		ESS0066A	J1
										ESS0066A	J1



KW



TYPE



TYPE

CITROËN

JUMPY

1.6 HDi 90 16V	Diesel	66	01/07 →					
1.6 HDi 90 16V	Diesel	66	01/07 →					
1.6 HDi 90 16V	Diesel	66	01/07 →	ENGINE: DV6TED4				
2.0 HDi 120	Diesel	88	01/07 →	ENGINE: RHK(DW10UTED4)		50CDSP6	B3	
2.0 HDi 120	Diesel	88	01/07 → 11/07	ENGINE: RHK(DW10UTED4)		50CDSP3	B3	
2.0 HDi 120	Diesel	88	11/07 →	ENGINE: RHK(DW10UTED4)		50CAD281	B3	
2.0 HDi 120	Diesel	88	01/07 →					
2.0 HDi 120	Diesel	88	01/07 →					
2.0 HDi 120	Diesel	88	01/07 →	ENGINE: DW10TEDA				
2.0 HDi 140	Diesel	100	01/07 →					
2.0 HDi 140	Diesel	100	01/07 →					
2.0 i	Petrol	103	01/07 →					
2.0 i	Petrol	103	01/07 →	ENGINE: EW10J4				

JUMPY (U6U)

1.9 D 70	Diesel	51	04/98 →					
1.9 D 70	Diesel	51	09/99 →					
2.0	Petrol	100	04/00 → 12/06					
2.0	Petrol	100	04/00 → 12/06					
2.0	Petrol	100	04/00 → 12/06					
2.0	Petrol	100	04/00 → 12/00					
2.0 HDi 110	Diesel	80	06/00 → 06/03					
2.0 HDi 110	Diesel	80	03/00 →					
2.0 HDi 110	Diesel	80	03/00 → 06/01	ENGINE: DW10				
2.0 HDi 110	Diesel	80	07/01 → 01/07					
2.0 HDi 95	Diesel	69	10/99 → 06/03					
2.0 HDi 95	Diesel	69	10/99 →					
2.0 HDi 95	Diesel	69	10/99 → 06/01	ENGINE: DW10				
2.0 HDi 95	Diesel	69	07/01 → 01/07					
2.0 i 16V	Petrol	102	03/00 → 12/03	ENGINE: EW10J4		B33	B1	
2.0 i 16V	Petrol	102	03/00 →					
2.0 i 16V	Petrol	102	03/00 →					
2.0 i 16V	Petrol	102	03/00 →					
2.0 i 16V	Petrol	102	11/06 →	ENGINE: EW10J4				

JUMPY Furgonato

1.6 HDi 90 16V	Diesel	66	01/07 →					
1.6 HDi 90 16V	Diesel	66	01/07 →	ENGINE: DV6TED4				
2.0 HDi 120	Diesel	88	01/07 →	ENGINE: RHK(DW10UTED4)		50CDSP6	B3	
2.0 HDi 120	Diesel	88	01/07 → 11/07	ENGINE: RHK(DW10UTED4)		50CDSP3	B3	
2.0 HDi 120	Diesel	88	11/07 →	ENGINE: RHK(DW10UTED4)		50CAD281	B3	
2.0 HDi 120	Diesel	88	01/07 →					
2.0 HDi 120	Diesel	88	01/07 →	ENGINE: DW10TEDA				
2.0 HDi 140	Diesel	100	01/07 →					
2.0 HDi 140	Diesel	100	01/07 →					



TYPE

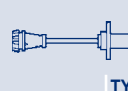

TYPE



TYPE

	APS38		ATS22	F2	SAA118	SAC096	H2	SUA582	J3
						SAG167	H1		
								SUA512	J3
	APS38		ATS22	F2	SAA118	SAC096	H2	SUA587	J3
								SUA588	J3
								SUA589	J3
								SUA512	J3
	APS38		ATS22	F2	SAA118	SAC096	H2		
						SAG169	H1		
			SPA107	F1	SAA118				
								GA2037	J2
			SPA107	F1	SAA118	SAG028	H1	SUA146	J3
						SAG027	H1		
			SPA107	F1	SAA118	SAC070	H2		
						SAD033	H3		
						SAG027	H1		
						SAG157	H1		
	APS35								
			SPA107	F1	SAA118	SAG027	H1		
								SUA463	J2
								SUA467	J2
	APS35								
			SPA107	F1	SAA118	SAG027	H1		
								SUA463	J2
								SUA467	J2
			SPA107	F1	SAA118	SAC070	H2		
						SAD033	H3		
						SAG027	H1		
								GA2036	J2
						SAG167	H1		
								SUA512	J3
	APS38		ATS22	F2	SAA118	SAC096	H2		
								SUA512	J3
	APS38		ATS22	F2	SAA118	SAC096	H2		
						SAG169	H1		



KW



TYPE



TYPE

CITROËN

JUMPY Furgonato

2.0 i	Petrol	103	01/07 →					
2.0 i	Petrol	103	01/07 →	ENGINE: EW10J4				

JUMPY Furgonato (BS_, BT_, BY_, BZ_)

1.6 i	Petrol	58	10/95 →					
1.6 i	Petrol	58	09/99 →					
1.9 D 70	Diesel	51	04/98 →					
1.9 D 70	Diesel	51	09/99 →					
1.9 TD	Diesel	66	10/95 →					
1.9 TD	Diesel	66	09/99 →					
2.0 HDi 110	Diesel	80	01/02 →					
2.0 HDi 110	Diesel	80	01/02 → 01/07					
2.0 HDi 95	Diesel	69	10/99 → 06/03					
2.0 HDi 95	Diesel	69	10/99 →					
2.0 HDi 95	Diesel	69	07/01 → 01/07					
2.0 i 16V	Petrol	102	03/00 → 12/03	ENGINE: EW10J4		B33		B1
2.0 i 16V	Petrol	102	03/00 →					
2.0 i 16V	Petrol	102	03/00 →					

JUMPY Pianale piatto/Telaio (BU_, BV_, BW_, BX_)

1.9 TD	Diesel	68	10/99 →					
2.0	Petrol	100	12/03 → 10/06					
2.0 HDi 110 16V	Diesel	80	12/03 → 10/06					
2.0 HDi 95	Diesel	69	10/99 → 06/03					
2.0 HDi 95	Diesel	69	10/99 →					
2.0 HDi 95	Diesel	69	10/99 → 06/01	ENGINE: DW10				
2.0 HDi 95	Diesel	69	07/01 → 01/07					

NEMO Furgonato (AA_)

1.3 HDi 75	Diesel	55	10/10 →					
1.4	Petrol	54	02/08 →					
1.4 HDi	Diesel	50	02/08 →					

NEMO Station wagon

1.4	Petrol	54	04/09 →					
1.4 HDi	Diesel	50	04/09 →					

SAXO (S0, S1)

1.0 X	Petrol	37	05/98 → 06/03					
1.0 X	Petrol	37	09/99 → 06/03					
1.0 X	Petrol	37	05/98 → 06/03	ENGINE: TU9M				
1.1 X,SX	Petrol	44	05/96 → 09/03	ENGINE: TU1JP		CA0077265/1		B6
1.1 X,SX	Petrol	44	05/96 → 12/99	ENGINE: TU1JP		B35/00		B1
1.1 X,SX	Petrol	44	07/00 → 09/03	ENGINE: HFX(TU1JP)		42SXPP31		B3
1.1 X,SX	Petrol	44	03/00 → 05/03					
1.1 X,SX	Petrol	44	05/96 → 09/03					
1.1 X,SX	Petrol	44	05/96 → 09/03					
1.1 X,SX	Petrol	44	02/98 → 09/03					
1.1 X,SX	Petrol	44	05/96 → 01/98					



TYPE

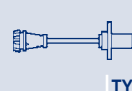

TYPE



TYPE

				SPA107	F1	SAA118					
										GA2037	J2
				SPA104	F1		SAG028	H1			
							SAG027	H1			
				SPA107	F1	SAA118	SAG028	H1			
							SAG027	H1			
						SAA118	SAG028	H1			
							SAG027	H1			
	APS35			SPA107	F1	SAA118				SUA467	J2
	APS35										
				SPA107	F1	SAA118	SAG027	H1			
										SUA467	J2
				SPA107	F1	SAA118	SAC070	H2			
							SAG027	H1			
						SAA118	SAG027	H1		SUA146	J3
				SPA107	F1						
				SPA107	F1					SUA467	J2
	APS35										
				SPA107	F1	SAA118					
										SUA463	J2
										SUA467	J2
				SPA146	F1		SAF001	H4			
				SPA107	F1	SAA118	SAG164	H1			
				ATS22	F2	SAA118	SAG167	H1			
				SPA107	F1						
							SAG167	H1			
				SPA164	F1		SAG028	H1	BAE680AF		
							SAG027	H1			
										ESS273	J1
	APS77										
				SPA107	F1	SAA118	SAD033	H3	BAE680AF	ESS0034A	J1
				SPA167	F1		SAG028	H1			
				SPA164	F1						
							SAG156	H1			



KW



TYPE



TYPE

CITROËN

SAXO (S0, S1)

1.1 X,SX	Petrol	44	03/00 → 09/03					
1.1 X,SX	Petrol	44	09/99 → 09/03					
1.1 X,SX	Petrol	44	05/96 → 09/03	ENGINE: TU1M				
1.4 VTS	Petrol	55	06/97 → 11/98		IAW1AP.40/3	A1		
1.4 VTS	Petrol	55	12/97 → 04/00		IAW1AP.81	A1		
1.6	Petrol	88	02/96 → 04/04					
1.6	Petrol	74	02/01 → 04/04					
1.6	Petrol	66	02/96 → 06/03					
1.6 VTS	Petrol	72	09/00 → 08/03					
1.6 VTS	Petrol	72	09/00 → 09/03					
1.6 VTS	Petrol	72	09/00 → 10/02					
1.6 VTS	Petrol	87	06/96 → 12/00	ENGINE: TU5J4-L3			B17	B1
1.6 VTS	Petrol	87	09/00 → 07/03		IAW48P2.80/1	A1		

VISA

16 GTI	Petrol	83	06/86 → 03/91				SVF010	B6
16 GTI	Petrol	76	01/85 → 06/86					

XANTIA (X1)

1.6 i	Petrol	65	03/93 → 01/98				B04	B1
1.6 i	Petrol	65	03/93 → 12/95				PF90/018	B6
1.6 i	Petrol	65	01/96 → 01/98				PF16080067	B6
1.6 i	Petrol	65	03/93 → 01/98					
1.6 i	Petrol	65	01/97 → 01/98	ENGINE: XU5JPZ				
1.6 i	Petrol	65	01/97 → 01/98	ENGINE: XU5JPZ				
1.6 i	Petrol	65	03/93 → 01/98	ENGINE: XU5JPZ				
1.6 i	Petrol	65	01/97 → 01/98	ENGINE: ID(XU5JP)				
1.8 i	Petrol	66	04/97 → 01/98	ENGINE: XU7JPZ	IAW8P.10/2	A1		
1.8 i	Petrol	66	04/97 → 01/98	ENGINE: XU7JP	IAW8P.10/3	A1		
1.8 i	Petrol	66	07/97 → 01/98	ENGINE: XU7JB	IAW1AP.20/2	A1		
1.8 i	Petrol	74	03/93 → 01/98	ENGINE: XU7JPZ	IAW8P.10/2	A1		
1.8 i	Petrol	74	05/93 → 01/98	ENGINE: XU7JP	IAW8P.10/3	A1		
1.8 i	Petrol	74	07/97 → 01/98	ENGINE: XU7JB	IAW1AP.20/2	A1		
1.8 i	Petrol	66	04/97 → 01/98				B04	B1
1.8 i	Petrol	66	04/97 → 01/98				KITPF2C	B6
1.8 i	Petrol	74	03/93 → 01/98				B04	B1
1.8 i	Petrol	74	03/93 → 12/95				PF90/018	B6
1.8 i	Petrol	74	01/96 → 01/98				PF16080067	B6
1.8 i	Petrol	74	03/93 → 01/98					
1.8 i	Petrol	66	04/97 → 01/98	ENGINE: XU7JB				
1.8 i	Petrol	66	04/97 → 01/98	ENGINE: XU7JB				
1.8 i	Petrol	74	03/93 → 01/98	ENGINE: XU7JPZ				
1.8 i	Petrol	74	03/93 → 01/98	ENGINE: XU7JPK,TR				
1.8 i	Petrol	74	01/97 → 01/98	ENGINE: XU7B-XU7JP-XU7JP4				
1.8 i 16V	Petrol	81	06/95 → 01/98					

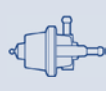
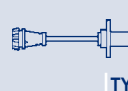
TYPE

TYPE

TYPE

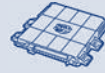
					SAG164	H1			
					SAG027	H1			
								ESS273	J1
			SPA107	F1					
					SAA118				
							BAE680AF		
	APS77								
			SPA167	F1	SAA118	SAG164	H1		
						SAD030	H3		
								PI024	J1
								PI024	J1
	PRT03E/04				SAG150	H1	BAE680AF	ESS0095A	J1
								SUA142	J2
			KITRPM36 RPM36						
				SZA101	F1				
								SUA461	J2
			KITRPM36						
	APS76				SAD033	H3	BAE680AF	ESS0095A	J1
					SAG150	H1		SUA142	J2
	APS29				SAG150	H1	BAE680AF	ESS0095A	J1
	PRT03E/04							SUA142	J2
			KITRPM40 RPM40 RPM36		SZA101	F1			
					SZA101	F1			
								SUA461	J2
	APS76				SAG150	H1	BAE680AY	ESS0095A	J1

KW

TYPE

TYPE
CITROËN
XANTIA (X1)

1.8 i 16V	Petrol	81	06/95 → 01/98					
1.9 Turbo D	Diesel	66	10/94 → 01/98					
2.0 i	Petrol	89	03/93 → 01/98			B04	B1	
2.0 i	Petrol	89	03/93 → 12/95			PF90/018	B6	
2.0 i	Petrol	89	01/96 → 01/98			PF16080067	B6	
2.0 i	Petrol	89	03/93 → 01/98					
2.0 i	Petrol	89	03/93 → 01/98	ENGINE: XU10J2CK				
2.0 i	Petrol	89	03/93 → 01/98	ENGINE: XU10J2CK				
2.0 i	Petrol	89	02/97 → 01/98					
2.0 i 16V	Petrol	110	06/94 → 01/98			SVF015	B6	
2.0 i 16V	Petrol	112	03/93 → 01/98			SVF015	B6	
2.0 i 16V	Petrol	110	06/94 → 01/98					
2.0 i 16V	Petrol	110	06/94 → 01/98					
2.0 i 16V	Petrol	112	03/93 → 01/98					
2.0 i 16V	Petrol	112	03/93 → 01/98					
2.0 i 16V	Petrol	97	06/95 → 01/98					
2.0 i 16V	Petrol	110	06/95 → 01/98	ENGINE: XU10J4R(RFV)				
2.0 i 16V	Petrol	112	06/95 → 01/98	ENGINE: XU10J4R(RFV)				
2.0 i 16V	Petrol	97	06/95 → 01/98					
2.0 i 16V	Petrol	97	06/95 → 01/98	ENGINE: XU10J4R(RFV)				
2.0 i 16V	Petrol	110	02/97 → 01/98					
2.0 i 16V	Petrol	97	02/97 → 01/98					
2.0 Turbo	Petrol	108	06/95 → 01/98					
2.0 Turbo	Petrol	108	06/95 → 01/98					
2.0 Turbo	Petrol	108	02/97 → 01/98					
2.1 Turbo D 12V	Diesel	80	06/95 → 01/98					

XANTIA (X2)

1.8 i	Petrol	66	01/98 → 04/03	ENGINE: XU7JB		B32/00	B1
1.8 i	Petrol	66	01/98 → 12/98				
1.8 i	Petrol	66	01/98 → 04/03				
1.8 i	Petrol	66	01/98 → 04/03				
1.8 i	Petrol	66	09/99 → 04/03				
1.8 i	Petrol	66	01/98 → 12/01				
1.8 i 16V	Petrol	81	01/98 → 04/03				
1.8 i 16V	Petrol	81	01/98 → 12/98				
1.8 i 16V	Petrol	81	09/99 → 04/03				
1.9 SD	Diesel	55	01/98 → 04/03				
1.9 SD	Diesel	55	09/99 → 04/03				
1.9 Turbo D	Diesel	66	01/98 → 04/03				
1.9 Turbo D	Diesel	66	09/99 → 04/03				
2.0 HDI 109	Diesel	80	02/99 → 04/03				
2.0 HDI 109	Diesel	80	09/99 → 04/03				
2.0 HDI 109	Diesel	80	02/99 → 12/01	ENGINE: DW10TD, DW10ATED			



TYPE

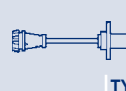

TYPE



TYPE

									SUA142	J2	
							SAG150	H1			
	PRT03E/04						SAD013	H3	BAE680AF	ESS0095A	J1
							SAG150	H1		SUA142	J2
	PRT03/04	KITRPM36	SZA101	F1							
		RPM36									
										SUA455	J2
							SAC064	H2		ESS0095A	J1
							SAC064	H2		ESS0095A	J1
							SAD013	H3		SUA142	J2
							SAG150	H1			
							SAD013	H3		SUA142	J2
							SAG150	H1			
							SAG150	H1	BAE680AY	ESS0095A	J1
									BAE700AK		
									BAE700AK		
										SUA142	J2
									BAE700AK		
										SUA455	J2
										SUA455	J2
							SAD013	H3	BAE680AF	ESS0095A	J1
							SAG150	H1		SUA142	J2
										SUA455	J2
							SAG150	H1			
	APS76										
							SAA118	SAD033	H3		
								SAG028	H1		
								SAG027	H1		
										BAE680AF	
	APS45						SAA118	SAG028	H1		
	APS76							SAG027	H1		
							SAA118	SAG028	H1		
								SAG027	H1		
							SAA118	SAG028	H1		
								SAG027	H1		
	APS35		SPA167	F1			SAA118	SAG028	H1		
								SAG027	H1		
										SUA463	J2



KW



TYPE



TYPE

CITROËN

XANTIA (X2)

2.0 HDI 90	Diesel	66	03/99 → 04/03					
2.0 HDI 90	Diesel	66	09/99 → 04/03					
2.0 HDI 90	Diesel	66	03/99 → 12/01	ENGINE: DW10TD, DW10ATED				
2.0 i	Petrol	89	01/98 → 04/03					
2.0 i	Petrol	89	01/98 → 04/03					
2.0 i	Petrol	89	09/99 → 04/03					
2.0 i	Petrol	89	01/98 → 12/01					
2.0 i 16V	Petrol	97	01/98 → 12/98					
2.0 i 16V	Petrol	97	01/98 → 04/03					
2.0 i 16V	Petrol	97	01/98 → 04/03					
2.0 i 16V	Petrol	97	09/99 → 04/03					
2.0 Turbo	Petrol	108	01/98 → 04/03					
2.0 Turbo	Petrol	108	09/99 → 04/03					
2.0 Turbo	Petrol	108	01/98 → 12/01					
2.1 Turbo D 12V	Diesel	80	01/98 → 02/99					
3.0 V6	Petrol	140	01/98 → 01/99					
3.0 V6	Petrol	140	01/98 → 04/03					
3.0 V6	Petrol	140	09/99 → 04/03					

XANTIA Break (X1)

1.8 i	Petrol	66	04/97 → 01/98	ENGINE: XU7JP	IAW8P.10/3	A1		
1.8 i	Petrol	66	07/97 → 01/98	ENGINE: XU7JB	IAW1AP.20/2	A1		
1.8 i	Petrol	74	06/95 → 01/98	ENGINE: XU7JPZ	IAW8P.10/2	A1		
1.8 i	Petrol	74	06/95 → 01/98	ENGINE: XU7JP	IAW8P.10/3	A1		
1.8 i	Petrol	74	07/97 → 01/98	ENGINE: XU7JB	IAW1AP.20/2	A1		
1.8 i	Petrol	66	04/97 → 01/98				B04	B1
1.8 i	Petrol	74	06/95 → 01/98				B04	B1
1.8 i	Petrol	74	06/95 → 12/95				PF90/018	B6
1.8 i	Petrol	74	01/96 → 01/98				PF16080067	B6
1.8 i	Petrol	66	04/97 → 01/98					
1.8 i	Petrol	74	09/95 → 01/98					
1.8 i	Petrol	74	01/97 → 01/98	ENGINE: XU7B-XU7JP-XU7JP4				
1.8 i 16V	Petrol	81	06/95 → 01/98				B04	B1
1.8 i 16V	Petrol	81	06/95 → 04/97					
1.8 i 16V	Petrol	81	04/97 → 01/98					
1.9 SD	Diesel	55	04/97 → 01/98					
1.9 Turbo D	Diesel	66	06/95 → 01/98					
2.0 i	Petrol	89	06/95 → 01/98				B04	B1
2.0 i	Petrol	89	06/95 → 12/95				PF90/018	B6
2.0 i	Petrol	89	01/96 → 01/98				PF16080067	B6
2.0 i	Petrol	89	06/95 → 01/98					
2.0 i	Petrol	89	09/95 → 01/98					
2.0 i	Petrol	89	02/97 → 01/98					

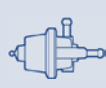

TYPE

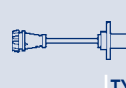

TYPE



TYPE

	APS35		SPA167	F1	SAA118	SAG028	H1				
						SAG027	H1				
									SUA463		J2
						SAD013	H3		SUA455		J2
						SAG028	H1				
						SAG027	H1				
									BAE680AF		
	APS76										
					SAA118	SAD008	H3		SUA455		J2
						SAG028	H1				
						SAG027	H1				
					SAA118	SAG028	H1				
						SAG027	H1				
									BAE680AF		
						SAG150	H1				
	APS76										
			SPA120	F1	SAA118	SAG028	H1				
						SAG027	H1				
	APS76					SAD033	H3	BAE680AF	ESS0095A		J1
	PRT03E/04					SAG150	H1		ESS0095A		J1
						SAG150	H1		SUA142		J2
	APS29							BAE680AF	SUA142		J2
									SUA461		J2
						SAG150	H1		ESS0095A		J1
	APS76										
									SUA142		J2
						SAG150	H1				
						SAG150	H1				
	PRT03E/04					SAD013	H3		ESS0095A		J1
						SAG150	H1				
									BAE680AF	SUA142	J2
									SUA455		J2



KW



TYPE



TYPE

CITROËN

XANTIA Break (X1)

2.0 i 16V	Petrol	97	06/95 → 01/98					
2.0 i 16V	Petrol	97	02/97 → 01/98					
2.0 i 16V	Petrol	97	09/95 → 01/98					
2.0 Turbo	Petrol	108	06/95 → 01/98					
2.0 Turbo	Petrol	108	06/95 → 01/98					
2.0 Turbo	Petrol	108	09/95 → 01/98					

XANTIA Break (X2)

1.8 i	Petrol	66	01/98 → 04/03	ENGINE: XU7JB			B32/00	B1
1.8 i	Petrol	66	01/98 → 12/98					
1.8 i	Petrol	66	01/98 → 04/03					
1.8 i	Petrol	66	09/99 → 04/03					
1.8 i	Petrol	66	01/98 → 12/01					
1.8 i 16V	Petrol	81	01/98 → 04/03					
1.8 i 16V	Petrol	81	01/98 → 12/98					
1.8 i 16V	Petrol	81	09/99 → 04/03					
1.9 SD	Diesel	55	01/98 → 04/03					
1.9 SD	Diesel	55	09/99 → 04/03					
1.9 Turbo D	Diesel	66	01/98 → 04/03					
1.9 Turbo D	Diesel	66	09/99 → 04/03					
2.0 HDI 109	Diesel	80	02/99 → 04/03					
2.0 HDI 109	Diesel	80	09/99 → 04/03					
2.0 HDI 109	Diesel	80	02/99 → 12/01	ENGINE: DW10TD, DW10ATED				
2.0 HDI 90	Diesel	66	03/99 → 04/03					
2.0 HDI 90	Diesel	66	09/99 → 04/03					
2.0 HDI 90	Diesel	66	03/99 → 12/01	ENGINE: DW10TD, DW10ATED				
2.0 i	Petrol	89	01/98 → 04/03					
2.0 i	Petrol	89	01/98 → 04/03					
2.0 i	Petrol	89	09/99 → 04/03					
2.0 i	Petrol	89	01/98 → 12/01					
2.0 i 16V	Petrol	97	01/98 → 12/98					
2.0 i 16V	Petrol	97	01/98 → 04/03					
2.0 i 16V	Petrol	97	01/98 → 04/03					
2.0 i 16V	Petrol	97	09/99 → 04/03					
2.0 Turbo	Petrol	108	01/98 → 04/03					
2.0 Turbo	Petrol	108	09/99 → 04/03					
2.0 Turbo	Petrol	108	01/98 → 12/01					
2.1 Turbo D 12V	Diesel	80	01/98 → 02/99					
3.0 V6	Petrol	140	01/98 → 01/99					
3.0 V6	Petrol	140	01/98 → 04/03					
3.0 V6	Petrol	140	09/99 → 04/03					



TYPE



TYPE



TYPE

							SAG150	H1	ESS0095A	J1	
									SUA455	J2	
									SUA142	J2	
							SAD013	H3	ESS0095A	J1	
							SAG150	H1			
									BAE680AF	SUA142	J2
	APS76						SAA118	SAG028	H1		
								SAG027	H1		
									BAE680AF		
	APS45						SAA118	SAG028	H1		
	APS76							SAG027	H1		
							SAA118	SAG028	H1		
								SAG027	H1		
							SAA118	SAG028	H1		
								SAG027	H1		
	APS35		SPA167	F1			SAA118	SAG028	H1		
								SAG027	H1		
										SUA463	J2
	APS35		SPA167	F1			SAA118	SAG028	H1		
								SAG027	H1		
										SUA463	J2
								SAD013	H3	SUA455	J2
								SAG028	H1		
								SAG027	H1		
									BAE680AF		
	APS76						SAA118	SAD008	H3	SUA455	J2
								SAG028	H1		
								SAG027	H1		
							SAA118	SAG028	H1		
								SAG027	H1		
									BAE680AF		
								SAG150	H1		
	APS76										
			SPA120	F1			SAA118	SAG028	H1		
								SAG027	H1		



KW

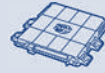

TYPE



TYPE

CITROËN

XM (Y3)

2.0	Petrol	84	05/89 → 04/94					
2.0	Petrol	84	05/89 → 04/94	ENGINE: XU10J2(RFZ)				
2.0 i	Petrol	79	05/89 → 04/94			CP90/011	B6	
2.0 i	Petrol	89	05/89 → 06/94			SVF015	B6	
2.0 i	Petrol	89	05/89 → 06/94	ENGINE: XU10J2K				
2.0 i	Petrol	89	04/93 → 06/94					
2.0 i	Petrol	89	05/89 → 06/94					
2.0 i	Petrol	79	05/89 → 04/94	ENGINE: XU10J2(RFZ)				
2.0 i	Petrol	89	05/89 → 06/94	ENGINE: XU10J2(RFZ)				
2.0 i	Petrol	79	11/91 → 04/94					
2.0 i Turbo	Petrol	104	09/92 → 06/94			SVF015	B6	
2.0 i Turbo	Petrol	104	09/92 → 06/94					
3.0	Petrol	123	05/89 → 05/94					
3.0	Petrol	147	05/89 → 06/94					
3.0 V6	Petrol	123	05/89 → 06/94					
3.0 V6	Petrol	123	05/89 → 06/94					
3.0 V6 24V	Petrol	147	07/90 → 06/94					
3.0 V6 24V	Petrol	147	07/90 → 06/94					

XM (Y4)

2.0 i 16V	Petrol	97	02/97 → 12/98					
2.0 i 16V	Petrol	97	05/94 → 10/00					
2.0 i 16V	Petrol	97	05/94 → 10/00					
2.0 i 16V	Petrol	97	09/99 → 10/00					
2.0 Turbo	Petrol	108	07/94 → 09/95			SVF015	B6	
2.0 Turbo	Petrol	108	05/94 → 10/00					
2.0 Turbo	Petrol	108	05/94 → 10/00					
2.0 Turbo	Petrol	108	09/99 → 10/00					
2.1 TD 12V	Diesel	80	05/94 → 10/00					
2.1 TD 12V	Diesel	80	09/99 → 10/00					
2.5 TD	Diesel	95	05/94 → 10/00					
2.5 TD	Diesel	95	09/99 → 10/00					
3.0 V6	Petrol	123	05/94 → 10/00					
3.0 V6	Petrol	140	09/97 → 12/98					
3.0 V6	Petrol	140	04/97 → 10/00					
3.0 V6	Petrol	123	05/94 → 10/00					
3.0 V6	Petrol	123	09/99 → 10/00					
3.0 V6	Petrol	140	09/99 → 10/00					
3.0 V6	Petrol	140	04/97 → 12/99					
3.0 V6 24V	Petrol	147	05/94 → 10/00					
3.0 V6 24V	Petrol	147	05/94 → 10/00					
3.0 V6 24V	Petrol	147	09/99 → 10/00					



TYPE

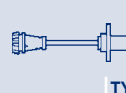

TYPE



TYPE

				SPA102	F1							
												BAE507BK
				SPA102	F1		SAG150	H1				
				SPA102	F1		SAG150	H1			ESS0014A	J1
		PRT03/04		SZA102	F1							
		APS29										
				SPA104	F1							
												BAE507BK
												BAE507BK
												ESS514
												J1
							SAD008	H3				ESS0014A
												J1
							SAG150	H1				
				SPA102	F1							
				SPA102	F1							
		APS45		SPA102	F1		SAD013	H3				ESS0014A
												J1
				SPA104	F1		SAG150	H1				
		APS45		SPA102	F1		SAD013	H3				ESS0014A
												J1
				SPA104	F1		SAG150	H1				
		APS76										
							SAA118		SAD008	H3	BAE680AY	ESS0095A
									SAG028	H1		
									SAG027	H1		
												BAE680AF
							SAA118		SAD008	H3		ESS0095A
									SAG028	H1		
									SAG027	H1		
									SAG028	H1		
									SAG027	H1		
							SAA118		SAG028	H1		
									SAG027	H1		
		APS45							SAD013	H3		ESS0095A
												J1
		APS76										
				SPA120	F1	SAA118	SAG028	H1				ESS0095A
									SAG028	H1		
									SAG027	H1		
									SAG027	H1		
												GA2025
												J2
		APS45					SAD013	H3				ESS0095A
									SAG028	H1		
									SAG027	H1		



KW

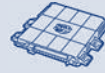

TYPE



TYPE

CITROËN

XM Break (Y3)

2.0 i	Petrol	89	11/91 → 04/94				SVF015	B6
2.0 i	Petrol	89	04/93 → 04/94					
2.0 i	Petrol	89	11/91 → 04/94	ENGINE: XU10J2(RFZ)				
2.0 i (Y3A)	Petrol	79	11/91 → 04/94				CP90/011	B6
2.0 i (Y3A)	Petrol	79	11/91 → 04/94	ENGINE: XU10J2(RFZ)				
2.0 Turbo	Petrol	104	09/92 → 04/94				SVF015	B6
2.0 Turbo	Petrol	104	09/92 → 04/94					
3.0 Pallas	Petrol	147	01/90 → 07/94					
3.0 Pullman	Petrol	147	05/89 → 07/94					
3.0 V6	Petrol	123	11/91 → 04/94					
3.0 V6	Petrol	123	11/91 → 04/94					

XM Break (Y4)

2.0 i 16V	Petrol	97	02/97 → 12/98					
2.0 i 16V	Petrol	97	05/94 → 10/00					
2.0 i 16V	Petrol	97	05/94 → 10/00					
2.0 i 16V	Petrol	97	09/99 → 10/00					
2.1 D12	Diesel	60	07/94 → 06/96					
2.1 TD 12V	Diesel	80	05/94 → 10/00					
2.1 TD 12V	Diesel	80	09/99 → 10/00					
2.5 TD	Diesel	95	05/94 → 10/00					
2.5 TD	Diesel	95	09/99 → 10/00					
3.0 V6	Petrol	123	05/94 → 10/00					
3.0 V6	Petrol	140	09/97 → 12/98					
3.0 V6	Petrol	140	04/97 → 10/00					
3.0 V6	Petrol	123	05/94 → 10/00					
3.0 V6	Petrol	123	09/99 → 10/00					
3.0 V6	Petrol	140	09/99 → 10/00					
3.0 V6	Petrol	123	05/94 → 12/99					
3.0 V6	Petrol	140	04/97 → 12/99					

XSARA (N1)

1.4 HDi	Diesel	50	01/03 → 03/05				AMM19765	B4
1.4 HDi	Diesel	50	01/03 → 03/05					
1.4 i	Petrol	55	04/97 → 03/05				KITPF2C	B6
1.4 i	Petrol	55	04/97 → 09/00	ENGINE: TU3JP			B35/00	B1
1.4 i	Petrol	55	04/97 → 12/00	ENGINE: TU3JP,L3			B24/00	B1
1.4 i	Petrol	55	04/97 → 03/05					
1.4 i	Petrol	55	07/97 → 12/98					
1.4 i	Petrol	55	09/00 → 03/05					
1.4 i	Petrol	55	04/97 → 03/05	ENGINE: TU3JP,L3				
1.4 i	Petrol	55	04/97 → 03/05	ENGINE: TU3JP,L3				
1.4 i	Petrol	55	04/97 → 03/05					
1.4 i	Petrol	55	04/97 → 10/02					
1.4 i	Petrol	55	04/97 → 01/98					
1.4 i	Petrol	55	07/97 → 03/05					



TYPE



TYPE



TYPE

			SPA102	F1		SAG150	H1		ESS0014A	J1
	APS29								BAE507BK	
			SPA102	F1		SAG150	H1		ESS514	J1
									BAE507BK	
						SAD008	H3		ESS0014A	J1
						SAG150	H1			
			SPA102	F1						
			SPA102	F1						
	APS45		SPA102	F1		SAD013	H3		ESS0014A	J1
						SAG150	H1			
	APS76									
					SAA118	SAD008	H3		ESS0095A	J1
						SAG028	H1		PI024	J1
						SAG027	H1			
						SAG150	H1			
						SAG028	H1			
						SAG027	H1			
					SAA118	SAG028	H1			
						SAG027	H1			
	APS45					SAD013	H3		ESS0095A	J1
	APS76									
			SPA120	F1	SAA118	SAG028	H1		ESS0095A	J1
						SAG028	H1			
						SAG027	H1			
						SAG027	H1			
									GA2025	J2
									GA2025	J2
			SPA172	F1	SAA118	SAC100	H2			
						SAG167	H1			
FEI0002			IATS04	F2	SAA118	SAC064	H2			
			SPA107	F1		SAD033	H3			
	APS76									
	APS77					SAG164	H1			
		KITRPM40	SZA101	F1						
		RPM40								
						SAG028	H1			
			SPA167	F1						
						SAG156	H1			
						SAD030	H3			



KW

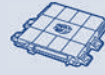

TYPE



TYPE

CITROËN

XSARA (N1)

1.4 i	Petrol	55	09/99 → 03/05					
1.4 i	Petrol	55	07/97 → 06/98					
1.4 i	Petrol	55	05/98 → 03/05	ENGINE: TU3JP				
1.5 D	Diesel	42	04/97 → 09/00					
1.5 D	Diesel	42	09/99 → 09/00					
1.6 16V	Petrol	80	09/00 → 03/05				TB0015	B3
1.6 16V	Petrol	80	09/00 → 10/02					
1.6 i	Petrol	65	07/97 → 06/98					
1.6 i	Petrol	65	07/98 → 12/98					
1.6 i	Petrol	65	07/98 → 09/00					
1.6 i	Petrol	65	04/97 → 09/00					
1.6 i	Petrol	65	04/97 → 01/98					
1.6 i	Petrol	65	09/99 → 09/00					
1.6 i	Petrol	65	05/98 → 09/00	ENGINE: TU5JP				
1.8 D	Diesel	43	04/97 → 09/00					
1.8 D	Diesel	43	09/99 → 09/00					
1.8 i	Petrol	66	09/97 → 04/99	ENGINE: XU7JPK	IAW8P1.A/2	A1		
1.8 i	Petrol	66	04/97 → 09/00				B04	B1
1.8 i	Petrol	66	04/97 → 09/00				KITPF2C	B6
1.8 i	Petrol	66	04/97 → 09/00	ENGINE: XU7JB			B32/00	B1
1.8 i	Petrol	66	04/97 → 09/00				PF16080067	B6
1.8 i	Petrol	66	07/97 → 09/00					
1.8 i	Petrol	66	04/97 → 09/00	ENGINE: XU7JB				
1.8 i	Petrol	66	09/99 → 09/00					
1.8 i	Petrol	66	07/97 → 08/00					
1.8 i	Petrol	66	04/97 → 09/00	ENGINE: XU7JB-XU7JP-XU7JP4				
1.8 i 16V	Petrol	81	04/97 → 09/00					
1.8 i 16V	Petrol	81	07/97 → 09/00					
1.8 i 16V	Petrol	81	09/99 → 09/00					
1.8 i 16V	Petrol	81	04/97 → 09/00	ENGINE: XU10J2TE				
1.8 i Aut.	Petrol	74	04/97 → 09/00				PF16080067	B6
1.8 i Aut.	Petrol	74	04/97 → 12/99				B04	B1
1.8 i Aut.	Petrol	74	04/97 → 09/00	ENGINE: XU7JP,L3				
1.8 i Aut.	Petrol	74	04/97 → 09/00	ENGINE: XU7JP,L3				
1.8 i Aut.	Petrol	74	09/99 → 09/00					
1.8 i Aut.	Petrol	74	07/97 → 08/00					
1.8 TD	Diesel	66	10/97 → 09/00					
1.8 TD	Diesel	66	09/99 → 09/00					
1.8 VTS	Petrol	85	09/00 → 10/04					
1.9 D	Diesel	51	07/98 → 03/05					
1.9 D	Diesel	50	04/97 → 09/00					
1.9 D	Diesel	50	09/99 → 09/00					
1.9 D	Diesel	51	09/99 → 03/05					

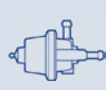

TYPE

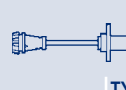

TYPE



TYPE

							SAG027	H1			
									BAE680AF		
										SUA455	J2
						SAA118	SAG028	H1			
							SAG027	H1			
	APS77		SPA107	F1	SAA118	SAG027	SAG027	H1			
			SPA167	F1		SAD030	SAD030	H3			
	APS29								BAE680AF		
	APS76										
			SPA164	F1		SAD030	SAD030	H3			
						SAG028	SAG028	H1			
						SAG156	SAG156	H1			
						SAG027	SAG027	H1			
										SUA455	J2
					SAA118	SAG028	SAG028	H1			
						SAG027	SAG027	H1			
	IWP049/1				SAA118	SAD033	SAD033	H3			
						SAG028	SAG028	H1			
		KITRPM40	SZA101	F1							
	APS76										
		RPM40									
						SAG027	SAG027	H1			
									BAE680AF		
										SUA455	J2
	APS45				SAA118	SAG028	SAG028	H1			
	APS76										
						SAG027	SAG027	H1			
										SUA455	J2
					SAA118	SAG028	SAG028	H1			
	PRT03/04	KITRPM36	SZA101	F1							
		RPM36									
						SAG027	SAG027	H1			
									BAE680AF		
						SAG028	SAG028	H1			
						SAG027	SAG027	H1			
						SAC070	SAC070	H2			
			SPA107	F1	SAA118	SAG028	SAG028	H1			
					SAA118	SAG028	SAG028	H1			
						SAG027	SAG027	H1			
						SAG027	SAG027	H1			



KW

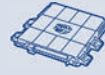

TYPE



TYPE

CITROËN

XSARA (N1)

1.9 SD	Diesel	55	01/98 → 09/00					
1.9 SD	Diesel	55	09/99 → 09/00					
1.9 TD	Diesel	66	04/97 → 09/00					
1.9 TD	Diesel	66	09/99 → 09/00					
2.0 16V	Petrol	97	07/98 → 09/00	ENGINE: EW10J4			B33	B1
2.0 16V	Petrol	120	07/97 → 09/00					
2.0 16V	Petrol	97	07/98 → 09/00					
2.0 16V	Petrol	120	04/97 → 09/00	ENGINE: XU10J4RS				
2.0 16V	Petrol	120	04/97 → 09/00	ENGINE: XU10J4RS				
2.0 16V	Petrol	100	09/00 → 03/05					
2.0 16V	Petrol	100	09/00 → 03/05					
2.0 16V	Petrol	120	04/97 → 09/00					
2.0 16V	Petrol	120	04/97 → 09/00					
2.0 16V	Petrol	100	09/00 → 03/05					
2.0 16V	Petrol	97	07/98 → 09/00					
2.0 16V	Petrol	120	09/99 → 09/00					
2.0 16V	Petrol	97	09/99 → 09/00					
2.0 16V	Petrol	100	09/00 → 03/05	ENGINE: XU10J4RS				
2.0 16V	Petrol	97	07/98 → 09/00	ENGINE: XU10J4RS				
2.0 HDI 109	Diesel	80	05/01 → 03/05					
2.0 HDI 109	Diesel	80	05/01 → 03/05	ENGINE: DW10ATED				
2.0 HDI 90	Diesel	66	02/99 → 03/05					
2.0 HDI 90	Diesel	66	02/99 → 08/00					
2.0 HDI 90	Diesel	66	09/00 → 03/05					
2.0 HDI 90	Diesel	66	09/99 → 03/05					
2.0 HDI 90	Diesel	66	02/99 → 03/05	ENGINE: DW10TD				

XSARA Break (N2)

1.4 HDi	Diesel	50	01/03 → 08/05				AMM19765	B4
1.4 HDi	Diesel	50	01/03 → 08/05					
1.4 i	Petrol	55	10/97 → 08/05				KITPF2C	B6
1.4 i	Petrol	55	10/97 → 09/00	ENGINE: TU3JP			B35/00	B1
1.4 i	Petrol	55	10/97 → 12/00	ENGINE: TU3JP,L3			B24/00	B1
1.4 i	Petrol	55	10/97 → 08/05					
1.4 i	Petrol	55	04/98 → 12/98					
1.4 i	Petrol	55	09/00 → 08/05					
1.4 i	Petrol	55	10/97 → 10/02					
1.4 i	Petrol	55	10/97 → 01/98					
1.4 i	Petrol	55	04/98 → 08/05					
1.4 i	Petrol	55	09/99 → 08/05					
1.4 i	Petrol	55	04/98 → 06/98					
1.4 i	Petrol	55	05/98 → 08/05	ENGINE: TU3JP				
1.5 D	Diesel	42	10/97 → 09/00					
1.5 D	Diesel	42	09/99 → 09/00					
1.6 16V	Petrol	80	09/00 → 08/05				TB0015	B3



TYPE



TYPE



TYPE

					SAA118	SAG028	H1		
						SAG027	H1		
					SAA118	SAG028	H1		
						SAG027	H1		
	APS76								
	APS76				SAA118	SAD008	H3		
		KITRPM40	SZA101	F1				SUA455	J2
		RPM40							
			IATS04/01	F2	SAA118	SAC070	H2		
			SPA107	F1		SAD033	H3		
			IATS04	F2	SAA118	SAC064	H2		
			SPA107	F1		SAG028	H1		
						SAG027	H1		
						SAG028	H1		
						SAG027	H1		
						SAG027	H1		
								SUA455	J2
								SUA455	J2
	APS35		SPA172	F1	SAA118				
								SUA454	J2
	APS35				SAA118	SAG028	H1		
			SPA167	F1					
			SPA172	F1		SAG157	H1		
						SAG027	H1		
								SUA454	J2
			SPA172	F1	SAA118	SAC100	H2		
						SAG167	H1		
FEI0002			IATS04	F2	SAA118	SAC064	H2		
			SPA107	F1		SAG028	H1		
APS76									
APS77						SAG164	H1		
			SPA167	F1					
						SAG156	H1		
						SAD030	H3		
						SAG027	H1		
								BAE680AF	
								SUA455	J2
					SAA118	SAG028	H1		
						SAG027	H1		
APS77			SPA107	F1	SAA118	SAG027	H1		



KW



TYPE



TYPE

CITROËN

XSARA Break (N2)

1.6 16V	Petrol	80	09/00 → 10/02					
1.6 i	Petrol	65	10/97 → 06/98					
1.6 i	Petrol	65	07/98 → 12/98					
1.6 i	Petrol	65	07/98 → 09/00					
1.6 i	Petrol	65	10/97 → 09/00					
1.6 i	Petrol	65	10/97 → 01/98					
1.6 i	Petrol	65	09/99 → 09/00					
1.8 D	Diesel	43	10/97 → 09/00					
1.8 D	Diesel	43	09/99 → 09/00					
1.8 i	Petrol	66	10/97 → 04/99	ENGINE: XU7JPK	IAW8P1.A/2	A1		
1.8 i	Petrol	66	10/97 → 09/00				B04	B1
1.8 i	Petrol	66	10/97 → 09/00				KITPF2C	B6
1.8 i	Petrol	66	10/97 → 09/00	ENGINE: XU7JB			B32/00	B1
1.8 i	Petrol	66	10/97 → 09/00				PF16080067	B6
1.8 i	Petrol	66	04/98 → 09/00					
1.8 i	Petrol	66	09/99 → 09/00					
1.8 i	Petrol	66	04/98 → 08/00					
1.8 i	Petrol	66	10/97 → 09/00	ENGINE: XU7JB-XU7JP-XU7JP4				
1.8 i 16V	Petrol	81	10/97 → 09/00					
1.8 i 16V	Petrol	81	04/98 → 09/00					
1.8 i 16V	Petrol	81	09/99 → 09/00					
1.8 i 16V	Petrol	81	10/97 → 09/00	ENGINE: XU10J2TE				
1.8 i Aut.	Petrol	74	10/97 → 09/00				B04	B1
1.8 i Aut.	Petrol	74	10/97 → 09/00				PF16080067	B6
1.8 i Aut.	Petrol	74	09/99 → 09/00					
1.8 i Aut.	Petrol	74	04/98 → 08/00					
1.9 D	Diesel	51	07/98 → 08/05					
1.9 D	Diesel	50	10/97 → 09/00					
1.9 D	Diesel	55	01/98 → 09/00					
1.9 D	Diesel	50	09/99 → 09/00					
1.9 D	Diesel	51	09/99 → 08/05					
1.9 D	Diesel	55	09/99 → 09/00					
1.9 TD	Diesel	66	10/97 → 09/00					
1.9 TD	Diesel	66	09/99 → 09/00					
2.0 16V	Petrol	97	07/98 → 09/00	ENGINE: EW10J4			B33	B1
2.0 16V	Petrol	97	07/98 → 09/00					
2.0 16V	Petrol	100	09/00 → 08/05					
2.0 16V	Petrol	100	09/00 → 08/05					
2.0 16V	Petrol	97	07/98 → 09/00					
2.0 16V	Petrol	97	09/99 → 09/00					
2.0 16V	Petrol	100	09/00 → 08/05	ENGINE: XU10J4RS				
2.0 16V	Petrol	97	07/98 → 09/00	ENGINE: XU10J4RS				
2.0 HDI 109	Diesel	80	05/01 → 08/05					



TYPE

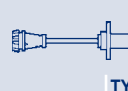

TYPE



TYPE

			SPA167	F1		SAD030	H3			
	APS29								BAE680AF	
	APS76									
			SPA164	F1		SAD030	H3			
						SAG028	H1			
						SAG156	H1			
						SAG027	H1			
					SAA118	SAG028	H1			
						SAG027	H1			
	IWP049/1				SAA118	SAG028	H1			
	APS76									
						SAG027	H1			
									BAE680AF	
										SUA455
										J2
	APS45				SAA118	SAG028	H1			
	APS76									
						SAG027	H1			
										SUA455
										J2
						SAA118	SAG028	H1		
						SAG027	H1			
									BAE680AF	
			SPA107	F1	SAA118	SAG028	H1			
					SAA118	SAG028	H1			
					SAA118	SAG028	H1			
						SAG027	H1			
						SAG027	H1			
						SAG027	H1			
						SAG027	H1			
					SAA118	SAG028	H1			
						SAG027	H1			
	APS76				SAA118	SAD008	H3			
			IATS04/01	F2	SAA118	SAC070	H2			
			SPA107	F1		SAG027	H1			
						SAG028	H1			
						SAG027	H1			
										SUA455
										J2
										SUA455
										J2
	APS35		SPA172	F1	SAA118					



KW

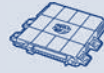

TYPE



TYPE

CITROËN

XSARA Break (N2)

2.0 HDI 109	Diesel	80	05/01 → 08/05	ENGINE: DW10ATED				
2.0 HDI 90	Diesel	66	02/99 → 08/05					
2.0 HDI 90	Diesel	66	02/99 → 08/00					
2.0 HDI 90	Diesel	66	09/00 → 08/05					
2.0 HDI 90	Diesel	66	09/99 → 08/05					
2.0 HDI 90	Diesel	66	02/99 → 08/05	ENGINE: DW10TD				

XSARA Coupé (N0)

1.4 HDi	Diesel	50	01/03 → 03/05				AMM19765	B4
1.4 HDi	Diesel	50	01/03 → 03/05					
1.4 i	Petrol	55	03/98 → 03/05	ENGINE: TU3JP,L3			B24/00	B1
1.4 i	Petrol	55	03/98 → 03/05					
1.4 i	Petrol	55	03/98 → 12/98					
1.4 i	Petrol	55	09/00 → 03/05					
1.4 i	Petrol	55	03/98 → 03/05					
1.4 i	Petrol	55	03/98 → 03/05					
1.4 i	Petrol	55	03/98 → 10/02					
1.4 i	Petrol	55	09/99 → 03/05					
1.4 i	Petrol	55	03/98 → 06/98					
1.6 16V	Petrol	80	09/00 → 03/05				TB0015	B3
1.6 16V	Petrol	80	09/00 → 10/02					
1.6 i	Petrol	65	07/98 → 09/00					
1.6 i	Petrol	65	02/98 → 09/00					
1.6 i	Petrol	65	02/98 → 09/00					
1.6 i	Petrol	65	09/99 → 09/00					
1.6 i	Petrol	65	02/98 → 06/98					
1.8 i	Petrol	66	02/98 → 09/00				B04	B1
1.8 i	Petrol	74	02/98 → 09/00				B04	B1
1.8 i	Petrol	66	09/99 → 09/00					
1.8 i	Petrol	66	02/98 → 08/00					
1.8 i	Petrol	74	02/98 → 08/00					
1.8 i 16V	Petrol	81	02/98 → 09/00					
1.8 i 16V	Petrol	81	09/99 → 09/00					
1.8 i 16V	Petrol	81	02/98 → 09/00	ENGINE: XU10J2TE				
1.9 D	Diesel	51	02/99 → 03/05					
1.9 D	Diesel	50	02/98 → 09/00					
1.9 D	Diesel	51	09/99 → 03/05					
1.9 TD	Diesel	66	02/98 → 09/00					
2.0 16V	Petrol	100	09/00 → 03/05					
2.0 16V	Petrol	100	09/00 → 03/05					
2.0 HDI 109	Diesel	80	05/01 → 03/05					
2.0 HDI 109	Diesel	80	05/01 → 03/05	ENGINE: DW10ATED				
2.0 HDI 90	Diesel	66	02/99 → 03/05					
2.0 HDI 90	Diesel	66	02/99 → 08/00					
2.0 HDI 90	Diesel	66	09/00 → 03/05					

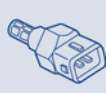
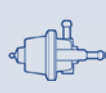

TYPE

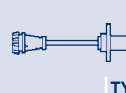

TYPE



TYPE

									SUA454	J2
	APS35				SAA118	SAG028	H1			
			SPA167	F1						
			SPA172	F1		SAG157	H1			
						SAG027	H1			
									SUA454	J2
			SPA172	F1	SAA118	SAC100	H2			
						SAG167	H1			
FEI0002			IATS04	F2	SAA118	SAC064	H2			
	APS76									
	APS77					SAG164	H1			
			SPA107	F1		SAD030	H3			
						SAG028	H1			
			SPA167	F1						
						SAG027	H1			
									BAE680AF	
	APS77		SPA107	F1	SAA118	SAG027	H1			
			SPA167	F1		SAD030	H3			
			SPA164	F1						
						SAD030	H3			
						SAG028	H1			
						SAG027	H1			
									BAE680AF	
	APS76				SAA118	SAG028	H1			
					SAA118	SAG150	H1			
						SAG027	H1			
									BAE680AF	
									BAE680AF	
	APS76				SAA118	SAG028	H1			
						SAG027	H1			
									SUA455	J2
			SPA107	F1	SAA118	SAG028	H1			
					SAA118					
						SAG027	H1			
					SAA118					
			IATS04/01	F2	SAA118	SAC070	H2			
			SPA107	F1		SAG027	H1			
	APS35		SPA172	F1	SAA118					
									SUA454	J2
	APS35				SAA118					
			SPA167	F1						
			SPA172	F1		SAG157	H1			



KW



TYPE



TYPE

CITROËN

XSARA Coupé (N0)

2.0 HDi 90	Diesel	66	02/99 → 03/05	ENGINE: DW10TD				
2.0 i 16V	Petrol	120	02/98 → 10/00	ENGINE: XU10J4RS	IAW1AP.10	A1		
2.0 i 16V	Petrol	120	02/98 → 12/00	ENGINE: XU10J4RS			B13	B1
2.0 i 16V	Petrol	120	02/98 → 08/00					
2.0 i 16V	Petrol	120	02/98 → 03/05	ENGINE: XU10J4RS				
2.0 i 16V	Petrol	120	02/98 → 03/05	ENGINE: XU10J4RS				
2.0 i 16V	Petrol	120	02/98 → 03/05					
2.0 i 16V	Petrol	120	02/98 → 03/05					
2.0 i 16V	Petrol	120	09/99 → 03/05					

XSARA PICASSO (N68)

1.6	Petrol	70	12/99 →					
1.6	Petrol	65	12/99 →					
1.6	Petrol	70	12/99 → 11/02					
1.6	Petrol	70	11/02 →					
1.6	Petrol	65	12/99 →					
1.6	Petrol	65	05/00 →	ENGINE: TU5JP				
1.6	Petrol	70	08/00 →	ENGINE: TU5JP				
1.6 16V	Petrol	80	09/05 →					
1.6 Chrono	Petrol	74	11/02 → 10/04					
1.6 Chrono	Petrol	74	04/01 → 10/04					
1.6 Chrono	Petrol	74	04/01 → 11/02					
1.6 HDi	Diesel	66	09/05 →					
1.6 HDi	Diesel	80	05/04 →					
1.6 HDi	Diesel	66	09/05 →					
1.6 HDi	Diesel	80	05/04 →					
1.8 16V	Petrol	85	02/00 →				B33	B1
1.8 16V	Petrol	85	02/00 →					
2.0 16V	Petrol	100	01/03 →	ENGINE: EW10J4			B33	B1
2.0 16V	Petrol	100	01/03 →					
2.0 16V	Petrol	100	01/03 →					
2.0 HDi	Diesel	80	12/99 →	ENGINE: RHZ(DW10ATED)			52SXP31	B3
2.0 HDi	Diesel	66	12/99 →					
2.0 HDi	Diesel	66	12/99 → 12/01					
2.0 HDi	Diesel	66	01/00 →					
2.0 HDi	Diesel	66	05/00 →					
2.0 HDi	Diesel	66	05/00 →	ENGINE: DW10TD				

ZX (N2)

1.1	Petrol	44	09/95 → 06/97					
1.1	Petrol	44	04/94 → 06/97					
1.1	Petrol	44	03/91 → 06/97					
1.1	Petrol	44	03/91 → 06/97					
1.1	Petrol	44	03/91 → 06/97					
1.1	Petrol	44	10/91 → 03/94					
1.4	Petrol	55	08/92 → 06/97					

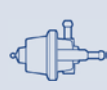
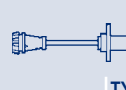

TYPE

TYPE

TYPE

									SUA454	J2
	APS76									
		KITRPM40	SZA101	F1						
		RPM40								
			IATS04	F2	SAA118	SAC064	H2			
			SPA107	F1		SAG028	H1			
						SAG027	H1			
	APS77					SAG027	H1			
			SPA164	F1		SAD030	H3			
			SPA167	F1						
			SPA107	F1						
						SAG027	H1			
									GA2002	J2
									GA2002	J2
	APS77		SPA107	F1	SAA118	SAG126	H1			
			SPA107	F1						
						SAG126	H1			
						SAD030	H3			
	APS38		ATS22	F2	SAA118	SAC096	H2			
	APS38		ATS22	F2	SAA118	SAC096	H2			
						SAG167	H1			
			SPA172	F1		SAG167	H1			
			SPA107	F1	SAA118	SAC070	H2			
						SAG027	H1			
	APS62		IATS04/01	F2	SAA118	SAC070	H2			
			SPA107	F1		SAD033	H3			
	APS35		SPA172	F1	SAA118	SAG027	H1		GA2210	J2
						SAG157	H1			
									GA2033	J2
									SUA377	J2
									SUA454	J2
			SPA104	F1						
						SAG156	H1			
									ESS0034A	J1
									GA2193	J2
									SUA139	J3
									SUA138	J3
						SAG156	H1			

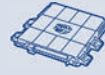

KW



TYPE



TYPE

CITROËN

ZX (N2)

1.4	Petrol	55	03/91 → 06/97					
1.4	Petrol	55	03/91 → 06/97					
1.4 i	Petrol	55	03/91 → 06/97	ENGINE: TU3JP,L3			B24/00	B1
1.4 i	Petrol	55	01/94 → 06/97				B14	B1
1.4 i	Petrol	55	01/94 → 06/97				KITPF2C	B6
1.4 i	Petrol	55	03/91 → 06/97	ENGINE: TU3MC				
1.4 i	Petrol	55	03/91 → 06/97	ENGINE: TU3JPL,3				
1.4 i	Petrol	55	03/91 → 06/97	ENGINE: TU3JPL,3				
1.4 i	Petrol	55	03/91 → 06/97					
1.4 i	Petrol	55	01/93 → 06/97					
1.4 i	Petrol	55	09/95 → 06/97					
1.4 i	Petrol	55	03/91 → 06/97					
1.4 i	Petrol	55	08/92 → 06/97					
1.4 i	Petrol	55	08/92 → 08/96					
1.4 i	Petrol	55	03/91 → 06/97					
1.4 i	Petrol	55	08/92 → 06/95					
1.6	Petrol	66	07/94 → 10/97					
1.6 i	Petrol	65	03/91 → 06/97				B04	B1
1.6 i	Petrol	65	03/91 → 12/95				PF90/018	B6
1.6 i	Petrol	65	01/96 → 06/97				PF16080067	B6
1.6 i	Petrol	65	03/91 → 06/97	ENGINE: XU5M3K				
1.6 i	Petrol	65	03/91 → 06/97	ENGINE: XU5JPZ				
1.6 i	Petrol	65	03/91 → 06/97	ENGINE: XU5JPZ				
1.6 i	Petrol	65	03/91 → 06/97					
1.6 i	Petrol	65	02/96 → 06/97					
1.6 i	Petrol	65	03/91 → 12/94					
1.6 i	Petrol	65	03/91 → 06/97					
1.6 i	Petrol	65	03/91 → 06/95					
1.8	Petrol	76	07/94 → 10/97					
1.8 D	Diesel	44	06/93 → 06/95					
1.8 i	Petrol	74	05/93 → 06/97	ENGINE: XU7JP	IAW8P.10/3	A1		
1.8 i	Petrol	74	10/92 → 06/97	ENGINE: XU7JPZ	IAW8P.10/2	A1		
1.8 i	Petrol	74	07/92 → 06/97				B04	B1
1.8 i	Petrol	74	01/96 → 06/97				PF16080067	B6
1.8 i	Petrol	74	07/92 → 06/97					
1.8 i	Petrol	74	07/92 → 06/97	ENGINE: XU7JPK,TR				
1.8 i	Petrol	74	07/92 → 06/97	ENGINE: XU7JPK,TR				
1.8 i	Petrol	74	07/92 → 06/95					
1.8 i 16V	Petrol	81	01/96 → 06/97					
1.8 i 16V	Petrol	81	01/96 → 06/97					
1.9	Petrol	93	03/91 → 06/97					
1.9	Petrol	96	03/91 → 09/93					
1.9 D	Diesel	47	03/91 → 06/95					
1.9 D	Diesel	50	05/94 → 06/97					

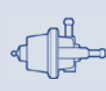

TYPE

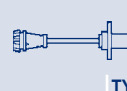

TYPE



TYPE

GA2193 J2

SUA139 J3

PRT03/04 SZA102 F1

KITRPM40 SZA101 F1

RPM40

KITATS05 F2 SAD033 H3 ESS0014A J1

IATS04 F2

SPA104 F1

GA2193 J2

SAG156 H1

BAE680CV

SUA139 J3

SUA138 J3

BAE680AF

SAG150 H1 ESS0014A J1

PRT03/04 SZA102 F1

KITRPM36 SZA101 F1

RPM36

GA2193 J2

SAG156 H1

BAE680AF

SUA139 J3

SUA138 J3

BAE680AF

SUA138 J3

APS29 SAG150 H1 BAE680AF ESS0014A J1

PRT03E/04 SUA139 J3

KITRPM36 SZA101 F1

RPM36

SUA138 J3

APS76 SAD008 H3 ESS0014A J1

SAG150 H1

BAE680AF

BAE680AF

SUA138 J3

SUA138 J3

KW

TYPE

TYPE
CITROËN
ZX (N2)

1.9 i	Petrol	88	03/91 → 06/97				SVF010	B6
1.9 i	Petrol	88	03/91 → 04/94					
1.9 TD	Diesel	66	07/92 → 06/95					
2.0	Petrol	90	07/94 → 10/97					
2.0 i	Petrol	89	07/92 → 06/97				B04	B1
2.0 i	Petrol	89	07/92 → 06/97	ENGINE: (ES9J4-XU10J4RS)			CA0005504	B6
2.0 i	Petrol	89	07/92 → 12/95				PF90/018	B6
2.0 i	Petrol	89	01/96 → 06/97				PF16080067	B6
2.0 i	Petrol	89	07/92 → 06/97					
2.0 i	Petrol	89	07/92 → 06/97	ENGINE: XU10J2CK				
2.0 i	Petrol	89	07/92 → 06/97	ENGINE: XU10J2CK				
2.0 i 16V	Petrol	110	05/96 → 06/97	ENGINE: XU10J4RS	IAW1AP.10	A1		
2.0 i 16V	Petrol	110	06/94 → 05/95				SVF015	B6
2.0 i 16V	Petrol	112	07/92 → 10/94				SVF015	B6
2.0 i 16V	Petrol	110	06/94 → 06/97					
2.0 i 16V	Petrol	110	06/94 → 06/97					
2.0 i 16V	Petrol	110	06/94 → 06/97					
2.0 i 16V	Petrol	112	07/92 → 10/94					
2.0 i 16V	Petrol	112	07/92 → 10/94					
2.0 i 16V	Petrol	110	06/94 → 06/97	ENGINE: XU10J4,Z(RFT,RFV)				
2.0 i 16V	Petrol	112	07/92 → 10/94	ENGINE: XU10J4,Z(RFT,RFV)				
2.0 i 16V	Petrol	110	06/94 → 06/95					

ZX Break (N2)

1.4 i	Petrol	55	10/93 → 10/97	ENGINE: TU3JP,L3			B24/00	B1
1.4 i	Petrol	55	01/94 → 10/97				B14	B1
1.4 i	Petrol	55	01/94 → 10/97				KITPF2C	B6
1.4 i	Petrol	55	10/93 → 10/97					
1.4 i	Petrol	55	10/93 → 10/97					
1.4 i	Petrol	55	09/95 → 10/97					
1.4 i	Petrol	55	10/93 → 08/96					
1.4 i	Petrol	55	10/93 → 06/95					
1.6 i	Petrol	65	10/93 → 10/97				B04	B1
1.6 i	Petrol	65	10/93 → 12/95				PF90/018	B6
1.6 i	Petrol	65	02/96 → 10/97					
1.6 i	Petrol	65	10/93 → 06/95					
1.8 D	Diesel	44	10/93 → 10/97					
1.8 i	Petrol	74	10/93 → 10/97	ENGINE: XU7JPZ	IAW8P.10/2	A1		
1.8 i	Petrol	74	10/93 → 10/97	ENGINE: XU7JP	IAW8P.10/3	A1		
1.8 i	Petrol	74	10/93 → 10/97				B04	B1
1.8 i	Petrol	74	10/93 → 10/97					
1.8 i	Petrol	74	10/93 → 06/95					
1.8 i 16V	Petrol	81	01/96 → 02/98					
1.8 i 16V	Petrol	81	01/96 → 02/98					
1.9 D	Diesel	47	10/93 → 10/97					

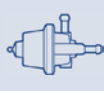

TYPE

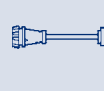

TYPE



TYPE

			SPA104	F1				ESS0014A	J1	
								SUA138	J3	
								SUA138	J3	
							BAE680AF			
	PRT03E/04					SAD013	H3	BAE680AF	ESS0014A	J1
						SAG150	H1	SUA138	J3	
	PRT03/04	KITRPM36 RPM36	SZA101	F1						
						SAC064	H2	ESS0014A	J1	
						SAC064	H2	PB507	J1	
						SAD013	H3	SUA139	J3	
						SAG150	H1			
						SAD013	H3	SUA138	J3	
						SAG150	H1			
								BAE700AK		
								BAE700AK		
								SUA138	J3	
			IATS04	F2		SAD033	H3	ESS0014A	J1	
			KITATS05	F2		SAG156	H1	GA2193	J2	
			SPA104	F1						
								BAE680CV		
								SUA138	J3	
	PRT03E/04					SAG150	H1	BAE680AF	ESS0014A	J1
						SAG156	H1			
								SUA138	J3	
								SUA138	J3	
	APS29					SAG150	H1	BAE680AF	ESS0014A	J1
	PRT03E/04									
								SUA138	J3	
	APS76					SAD008	H3	ESS0014A	J1	
						SAG150	H1			
								SUA139	J3	



KW



TYPE



TYPE

CITROËN

ZX Break (N2)

1.9 D	Diesel	47	05/94 → 04/97						
1.9 D	Diesel	50	06/94 → 10/97						
1.9 D	Diesel	50	06/94 → 06/95						
1.9 TD	Diesel	66	10/93 → 06/95						

DACIA

1309 Pick-up

1.6	Petrol	53	02/97 → 08/01						
-----	--------	----	---------------	--	--	--	--	--	--

DUSTER

1.5 dCi	Diesel	63	04/10 →						
1.5 dCi	Diesel	79	06/10 →						
1.5 dCi 4x4	Diesel	79	06/10 →						
1.6 16V	Petrol	77	04/10 →						
1.6 16V 4x4	Petrol	77	06/10 →						
1.6 16V 4x4	Petrol	77	06/10 →						
1.6 16V LPG	Petrol/LPG	77	04/11 →						

LODGY

1.5 dCi	Diesel	79	01/13 →						
1.6	Petrol	61	03/12 →						

LOGAN (LS_)

1.4 (LSOA, LSOC, LSOE, LSOG)	Petrol	55	09/04 →						
1.4 (LSOA, LSOC, LSOE, LSOG)	Petrol	55	09/04 →						
1.4 (LSOA, LSOC, LSOE, LSOG)	Petrol	55	09/04 →	ENGINE: K7J					
1.4 (LSOA, LSOC, LSOE, LSOG)	Petrol	55	09/04 →	ENGINE: K7J					
1.4 MPI LPG (LSOC)	Petrol/LPG	55	02/06 →						
1.5 dCi (LS0J, LS0Y)	Diesel	48	09/05 →						
1.5 dCi (LS0J, LS0Y)	Diesel	48	09/05 →						
1.5 dCi (LS0J, LS0Y)	Diesel	48	09/05 →						
1.5 dCi (LS0J, LS0Y)	Diesel	48	09/05 →	ENGINE: K9K					
1.5 dCi (LS0K)	Diesel	50	01/06 →						
1.5 dCi (LS0K)	Diesel	50	01/06 →						
1.5 dCi (LS0W)	Diesel	63	09/07 →						
1.5 dCi (LS0W)	Diesel	63	09/07 →						
1.6 (LSOB, LSOD, LSOF, LSOH)	Petrol	64	09/04 → 12/11						
1.6 (LSOB, LSOD, LSOF, LSOH)	Petrol	64	09/04 →						
1.6 (LSOB, LSOD, LSOF, LSOH)	Petrol	64	09/04 →						
1.6 (LSOB, LSOD, LSOF, LSOH)	Petrol	64	09/04 →	ENGINE: K7M					
1.6 (LSOB, LSOD, LSOF, LSOH)	Petrol	64	09/04 →	ENGINE: K7M					
1.6 16V (LS0M)	Petrol	77	02/06 →						
1.6 16V (LS0M)	Petrol	77	02/06 →						



TYPE

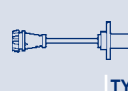

TYPE



TYPE

										SUA138	J3
										SUA139	J3
										SUA138	J3
										SUA138	J3

BAE680AG

										SAD035	H3		
										SAD035	H3	SUA561	J3
										SAD035	H3		
				SPA108	F1					SAG160	H1		
				SPA108	F1							GA2082	J2
												GA2083	J2
				SPA108	F1								

												GA2069	J2
												GA2053	J2

				SPA108	F1					SAD035	H3	BAE680Z	
										SAG163	H1		

												SUA470	J2
												SUA471	J2

				SPA108	F1								
				APS37		SPA169	F1			SAC010	H1		
										SAD035	H3		
										SAG161	H1		

												SUA485	J3
--	--	--	--	--	--	--	--	--	--	--	--	--------	----

				APS37		SPA169	F1			SAC010	H1		
										SAD035	H3		
				APS37		SPA169	F1			SAC010	H1		
										SAD035	H3		

				SPA108	F1								
										SAD035	H3	BAE680Z	
										SAG163	H1		

												SUA470	J2
												SUA471	J2

				SPA108	F1					SAD035	H3		
										SAG159	H1		



KW

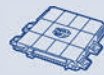

TYPE



TYPE

DACIA

LOGAN EXPRESS (FS_)

1.4	Petrol	55	03/09 →						
1.5 dCi (FS0K)	Diesel	50	03/09 →						
1.5 dCi (FS0W)	Diesel	63	03/09 →						
1.6	Petrol	64	03/09 →						
1.6 Bifuel	BiFuel	62	05/10 →						

LOGAN MCV (KS_)

1.4	Petrol	55	02/07 →						
1.5 dCi (KS0K)	Diesel	50	02/07 →						
1.5 dCi (KS0K)	Diesel	50	02/07 →						
1.5 dCi (KS0W)	Diesel	63	09/07 →						
1.5 dCi (KS0W)	Diesel	63	09/07 →						
1.6	Petrol	64	02/07 →						
1.6 16V	Petrol	77	02/07 →						
1.6 16V	Petrol	77	02/07 →						
1.6 Bifuel	BiFuel	64	11/08 →						

LOGAN Pick-up (US_)

1.5 dCi (US0K)	Diesel	50	03/08 →						
1.5 dCi (US0W)	Diesel	63	03/08 →						
1.6	Petrol	64	03/08 →						
1.6 Bifuel	BiFuel	62	05/10 →						

NOVA

1.6	Petrol	53	05/96 → 09/00						
-----	--------	----	---------------	--	--	--	--	--	--

SANDERO

1.2 16V	Petrol	55	11/08 →						
1.2 16V LPG	Petrol/LPG	55	01/11 →						
1.4	Petrol	55	06/08 →						
1.5 dCi	Diesel	50	11/08 →						
1.5 dCi	Diesel	63	11/08 →						
1.6	Petrol	64	06/08 →						
1.6 16V Bifuel	BiFuel	77	01/11 →						

SUPERNOVA

1.4	Petrol	55	04/00 → 03/03						
-----	--------	----	---------------	--	--	--	--	--	--

DAEWOO

ESPERO (KLEJ)

1.5 16V	Petrol	66	02/95 → 06/99						
1.8	Petrol	66	02/95 → 09/99						
1.8	Petrol	70	02/95 → 06/99						
2.0	Petrol	77	02/95 → 06/99						

EVANDA (KLAL)

2.0	Petrol	96	08/02 →						
2.0	Petrol	96	03/03 → 01/05						



TYPE

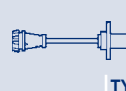

TYPE



TYPE

			SPA108	F1					
	APS37					SAC010	H1		
	APS37					SAC010	H1		
			SPA108	F1					
			SPA108	F1					
			SPA108	F1		SAD035	H3		
	APS37		SPA169	F1		SAC010	H1		
						SAD035	H3		
	APS37		SPA169	F1		SAC010	H1		
						SAD035	H3		
			SPA108	F1		SAD035	H3		
			SPA108	F1		SAD035	H3		
						SAG159	H1		
			SPA108	F1					
	APS37					SAC010	H1		
	APS37					SAC010	H1		
			SPA108	F1					
			SPA108	F1					
									BAE680AG
			SPA108	F1					
			SPA108	F1					
			SPA108	F1		SAD035	H3		
						SAC010	H1		
						SAC010	H1		
			SPA108	F1		SAD035	H3		
			SPA108	F1					
									ESS533
									J1
			SPA115	F1					
								SUA484	J1
								SUA484	J1
								SUA484	J1
			SPA115	F1		SAC036	H2		
						SAG051	H1		

KW

TYPE

TYPE
DAEWOO
KALOS (KLAS)

1.2	Petrol	53	04/03 →					B3396	B1
1.2	Petrol	53	04/03 →						
1.4	Petrol	61	09/02 →						
1.4	Petrol	61	09/02 → 01/05						
1.4 16V	Petrol	69	04/03 →					B3396	B1
1.4 16V	Petrol	69	04/03 → 01/05						

KORANDO (KJ)

2.3	Petrol	105	01/99 →						
2.3	Petrol	105	01/99 → 05/05						
2.3	Petrol	105	01/99 → 12/00						
3.2 4x4	Petrol	156	01/99 →						

KORANDO Cabrio (KJ)

2.0 16V	Petrol	94	02/99 → 02/01						
2.0 16V	Petrol	94	02/99 → 12/00						
2.3	Petrol	105	02/99 →						
2.3	Petrol	105	02/99 → 05/05						
2.3	Petrol	105	02/99 → 12/00						

LACETTI 2 volumi /Coda spiovente (KLAN)

1.4	Petrol	70	02/04 →						
1.4	Petrol	70	02/04 → 01/05						
1.6	Petrol	80	02/04 →						
1.8	Petrol	90	02/04 →						
1.8	Petrol	90	02/04 →						
1.8	Petrol	90	02/04 →						

LACETTI Tre volumi (J200)

1.8 CDX	Petrol	90	08/03 → 12/04						
---------	--------	----	---------------	--	--	--	--	--	--

LANOS (KLAT)

1.4	Petrol	55	05/97 →					B3396	B1
1.4	Petrol	55	05/97 →						
1.4	Petrol	55	05/97 →	ENGINE: A14SMS					
1.5	Petrol	63	05/97 →					B3396	B1
1.5	Petrol	63	05/97 →						
1.5	Petrol	63	05/97 →	ENGINE: A15SMS					
1.6 16V	Petrol	78	05/97 →					B3396	B1
1.6 16V	Petrol	78	05/97 →						
1.6 16V	Petrol	78	05/97 →	ENGINE: A16DMS					

LANOS Tre volumi (KLAT)

1.4	Petrol	55	05/97 →					B3396	B1
1.4	Petrol	55	05/97 →						
1.4	Petrol	55	05/97 →	ENGINE: A14SMS					
1.5	Petrol	63	05/97 →					B3396	B1
1.5	Petrol	63	05/97 →						
1.5	Petrol	63	05/97 →	ENGINE: A15SMS					
1.6 16V	Petrol	78	05/97 →					B3396	B1



TYPE

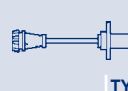

TYPE



TYPE

							SAC051	H2		
							SAD024	H3		
			SPA115	F1						
							SAG106	H1		
			SPA115	F1			SAC051	H2		
							SAG106	H1		
			ATS21	F2			SAD033	H3		
							SAC016	H2		
							SAG146	H1		
			ATS21	F2			SAC043	H2		
							SAC016	H2		
							SAG146	H1		
			ATS21	F2						
							SAC016	H2		
							SAG146	H1		
			SPA115	F1			SAD024	H3		
							SAG106	H1		
			SPA115	F1			SAG106	H1		
			SPA115	F1			SAC036	H2		
							SAD024	H3		
							SAG051	H1		
							SAC036	H2		
	APS45		SPA115	F1			SAD024	H3		
							SAG098	H1		
									BAE608M	
	APS45		SPA115	F1			SAD024	H3		
							SAG098	H1		
									BAE608M	
	APS45		SPA115	F1			SAD024	H3		
							SAG098	H1		
									BAE608M	
	APS45		SPA115	F1			SAD024	H3		
							SAG098	H1		
									BAE608M	
	APS45		SPA115	F1			SAD024	H3		
							SAG098	H1		
									BAE608M	
	APS45		SPA115	F1			SAG098	H1		



KW



TYPE



TYPE

DAEWOO

LANOS Tre volumi (KLAT)

1.6 16V	Petrol	78	05/97 →						
1.6 16V	Petrol	78	05/97 →	ENGINE: A16DMS					

LEGANZA (KLAV)

2.0 16V	Petrol	98	06/97 → 12/02						
2.0 16V	Petrol	98	06/97 → 12/02						
2.0 16V	Petrol	93	07/00 → 04/04						
2.0 16V	Petrol	93	07/00 → 04/04						
2.0 16V	Petrol	93	07/00 → 04/04						
2.0 16V	Petrol	98	06/97 → 12/02						
2.0 16V	Petrol	98	06/97 → 12/02	ENGINE: X20SED					
2.2 16V	Petrol	100	04/99 → 12/02						
2.2 16V	Petrol	100	04/99 → 12/02						
2.2 16V	Petrol	100	04/99 → 12/02						
2.2 16V	Petrol	100	04/99 → 12/02	ENGINE: T22SED					

MATIZ (KLYA)

0.8	Petrol	38	09/98 →					B3368	B1
1.0	Petrol	47	01/03 →						

MUSSO (FJ)

2.3	Petrol	103	01/99 →						
2.3	Petrol	103	01/99 → 05/05						
2.3	Petrol	103	01/99 → 12/00						
3.2 4x4	Petrol	162	01/99 →						

NEXIA (KLETN)

1.5	Petrol	52	02/95 → 08/97						
1.5	Petrol	55	02/95 → 08/97						
1.5 16V	Petrol	66	02/95 → 08/97						

NEXIA Tre volumi (KLETN)

1.5	Petrol	52	02/95 → 08/97						
1.5	Petrol	55	02/95 → 08/97						
1.5 16V	Petrol	66	02/95 → 08/97						

NUBIRA (KLAJ)

1.6 16V	Petrol	78	05/97 →					B3396	B1
1.6 16V	Petrol	78	05/97 →	CHASSIS: → 580669					
1.6 16V	Petrol	78	05/97 →	ENGINE: A16DMS					
2.0 16V	Petrol	98	05/97 →					B3396	B1
2.0 16V	Petrol	98	05/97 →	ENGINE: X20SED					

NUBIRA Tre volumi (KLAJ)

1.6 16V	Petrol	78	05/97 →					B3396	B1
1.6 16V	Petrol	76	07/00 →	CHASSIS: → 580669					
1.6 16V	Petrol	78	05/97 →	CHASSIS: → 580669					
1.6 16V	Petrol	76	07/00 →						
1.6 16V	Petrol	76	07/00 →						
1.6 16V	Petrol	78	05/97 →						
1.6 16V	Petrol	78	05/97 →	ENGINE: A16DMS					



TYPE

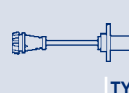

TYPE



TYPE

						SAD024	H3		
								BAE608M	
	APS44		SPA115	F1		SAC036	H2		
						SAD024	H3		
						SAC036	H2		
						SAD024	H3		
						SAG051	H1		
						SAG051	H1		
								BAE608M	
			SPA115	F1		SAC036	H2		
						SAD024	H3		
						SAG051	H1		
								BAE608M	
	FEI0003		SPA115	F1		SAD024	H3		GA2216 J2
	FEI0003					SAD024	H3		GA2216 J2
			ATS21	F2					
						SAC016	H2		
						SAG146	H1		
			ATS21	F2		SAC043	H2		
			SPA115	F1					
			SPA115	F1					
			SPA115	F1					
			SPA115	F1					
			SPA115	F1					
			SPA115	F1					
						SAD024	H3		
			SPA115	F1		SAG098	H1		
								BAE608M	
	APS44		SPA115	F1		SAD024	H3		
								BAE608M	
						SAD009	H3		
			SPA115	F1		SAG098	H1		
			SPA115	F1		SAG098	H1		
						SAC051	H2		
						SAD024	H3		
						SAD024	H3		
								BAE608M	

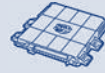
KW

TYPE

TYPE
DAEWOO
NUBIRA Tre volumi (KLAJ)

2.0 16V	Petrol	98	05/97 →						B3396	B1
2.0 16V	Petrol	98	05/97 →							
2.0 16V	Petrol	93	12/00 →							
2.0 16V	Petrol	93	12/00 →							
2.0 16V	Petrol	98	05/97 →	ENGINE: X20SED						

NUBIRA Tre volumi (KLAN)

1.6	Petrol	80	07/03 →							
1.6	Petrol	80	07/03 →							
1.8	Petrol	90	07/03 →							
1.8	Petrol	90	07/03 →							

NUBIRA Wagon (KLAJ)

1.6 16V	Petrol	66	06/97 →	CHASSIS: → 580669						
1.6 16V	Petrol	76	12/00 →	CHASSIS: → 580669						
1.6 16V	Petrol	78	05/97 →	CHASSIS: → 580669						
1.6 16V	Petrol	76	12/00 →							
1.6 16V	Petrol	78	05/97 →							
1.6 16V	Petrol	78	05/97 →	ENGINE: A16DMS						
2.0 16V	Petrol	98	05/97 →							
2.0 16V	Petrol	93	12/00 →							
2.0 16V	Petrol	98	05/97 →							
2.0 16V	Petrol	98	05/97 →	ENGINE: X20SED						

NUBIRA Wagon (KLAN)

1.6	Petrol	80	07/03 →							
1.8	Petrol	90	07/03 →							

TACUMA (KLAU)

1.6	Petrol	77	09/00 →							
1.8	Petrol	67	09/00 →							
1.8	Petrol	72	09/00 →							
1.8	Petrol	72	09/00 →							
1.8	Petrol	74	09/00 →							
1.8	Petrol	74	09/00 →							
1.8	Petrol	74	09/00 →							
2.0	Petrol	94	09/00 →							
2.0	Petrol	89	09/01 →							
2.0	Petrol	94	09/00 →							
2.0	Petrol	89	09/01 →							
2.0	Petrol	89	09/01 →							

DAIHATSU
APPLAUSE I (A101, A111)

1.6 16V (A101)	Petrol	77	04/94 → 07/97							
1.6 16V (A101)	Petrol	66	06/89 → 07/97							
1.6 16V (A101)	Petrol	77	06/89 → 07/97							
1.6 16V 4WD (A111)	Petrol	77	04/94 → 07/97							



TYPE

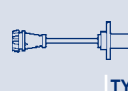

TYPE



TYPE

	APS44		SPA115	F1		SAD024	H3		
						SAG051	H1		
			SPA115	F1		SAC051	H2		
						SAD024	H3		
								BAE608M	
			SPA115	F1		SAD024	H3		
						SAG106	H1		
			SPA115	F1		SAC036	H2		
						SAG051	H1		
			SPA115	F1					
			SPA115	F1		SAG098	H1		
			SPA115	F1		SAG098	H1		
						SAD024	H3		
						SAD024	H3		
								BAE608M	
	APS44		SPA115	F1		SAD024	H3		
			SPA115	F1		SAD024	H3		
						SAG051	H1		
								BAE608M	
						SAG106	H1		
						SAC036	H2		
						SAG106	H1		
						SAD024	H3		
						SAC051	H2		
						SAD024	H3		
						SAC051	H2		
						SAD024	H3		
						SAG106	H1		
	APS44		SPA115	F1		SAC036	H2		
			SPA115	F1		SAC036	H2		
						SAD024	H3		
						SAD024	H3		
						SAG051	H1		
			SPA142	F1					
						SAA110			
						SAA110			
			SPA142	F1					

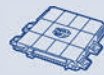
KW

TYPE

TYPE
DAIHATSU
APPLAUSE I (A101, A111)

1.6 16V 4WD (A111) Petrol 77 06/89 → 07/97

APPLAUSE II (A101)

1.6 16V (A101) Petrol 73 07/97 → 05/00

CHARADE IV (G200, G202)

1.0 Petrol 38 09/94 → 03/96

1.3 i 16V Petrol 62 01/93 → 03/96

1.3 i 16V Petrol 62 01/93 → 09/00

1.6 GTI Petrol 77 03/93 → 11/99

CHARADE IV Tre volumi (G203)

1.5 i 16V Petrol 66 08/94 →

COPEN

1.3 Petrol 64 03/06 →

CUORE II (L80, L81)

0.8 (L80) Petrol 29 11/89 → 12/90

0.8 (L80) Petrol 32 09/85 → 06/90

0.8 4WD (L81) Petrol 32 09/86 → 10/88

CUORE III (L201)

0.8 Petrol 30 10/90 → 12/94

CUORE IV (L501)

0.8 Petrol 32 01/95 → 11/96

CUORE VI (L7_)

1.0 i (L701) Petrol 41 10/98 → 05/03

FEROZA Hard Top (F300)

1.6 16V Petrol 63 10/88 → 12/99

1.6 i 16V 4x4 Petrol 70 09/93 → 10/99

1.6 i 16V 4x4 Petrol 70 10/88 → 12/99

FEROZA Soft Top (F300)

1.6 16V Petrol 63 10/88 → 12/99

1.6 i 16V Petrol 70 09/93 → 10/99

1.6 i 16V Petrol 70 10/88 → 12/99

GRAN MOVE (G3)

1.6 16V (G301) Petrol 67 05/98 →

HIJET Autobus (S85)

1.0 i Petrol 35 07/94 → 05/98

HIJET Furgonato (S85)

1.0 i Petrol 35 07/94 → 05/98

MOVE (L6, L9)

1.0 i Petrol 41 10/98 →

ROCKY Hard Top (F7, F8)

2.8 D Diesel 54 02/85 → 12/98

ROCKY Soft Top (F7, F8)

2.8 D Diesel 54 02/85 → 12/98

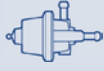

TYPE



TYPE



TYPE

SAA110

SAA110

SAA110

SPA142 F1

SAA110

SPA142 F1

SAA110

SAA110

SAC091 H2

SAA110

SAA110

SAA110

SAA110

SPA142 F1

SAA110

SAA110

SAA110

SPA142 F1

SAA110

SAA110

SAA110

SPA142 F1

SAA110

SAA110

SPA142 F1

SPA142 F1

SPA142 F1

SAA110

SAA110

SAA110



KW



TYPE



TYPE

DAIHATSU

SIRION (M1)

1.0 i (M100)	Petrol	41	04/98 → 09/00					
1.0 i 4WD	Petrol	41	04/99 → 09/00					
1.3 Sport	Petrol	75	08/00 → 07/04					
1.3 Sport 4WD	Petrol	75	08/00 → 07/04					

SIRION (M3_)

1.0	Petrol	51	01/05 →					
1.3	Petrol	64	01/05 →					
1.3	Petrol	67	03/08 →					
1.3 4WD	Petrol	64	02/06 →					
1.3 4WD	Petrol	67	03/08 →					

TERIOS (J1)

1.3	Petrol	63	09/01 → 10/05					
1.3 4WD	Petrol	61	10/97 → 10/00					
1.3 4WD	Petrol	63	10/00 → 10/05					

YRV (M2)

1.0	Petrol	43	02/01 →					
1.3	Petrol	64	02/01 →					
1.3	Petrol	64	02/01 → 07/05					
1.3 4WD	Petrol	64	02/01 →					
1.3 4WD	Petrol	64	02/01 → 07/05					
1.3 GTi	Petrol	95	07/02 → 07/05					

DODGE

CARAVAN

2.5 TD	Diesel	85	01/95 → 03/01					
--------	--------	----	---------------	--	--	--	--	--

RAM 4000 Pianale piatto/Telaio (DH, DR, D1, DC, DM)

2.0 4x4	Petrol	282	06/98 →				B04	B1
---------	--------	-----	---------	--	--	--	-----	----

FERRARI

208/308

208 Turbo	Petrol	162	06/82 → 10/89					
308 GTB Qv	Petrol	177	09/82 → 06/85					
308 GTS Qv	Petrol	177	09/82 → 06/85					

328 GTB

3.2	Petrol	199	09/85 → 09/89				SVF010	B6
-----	--------	-----	---------------	--	--	--	--------	----

328 GTS

3.2	Petrol	199	09/85 → 09/89				SVF010	B6
-----	--------	-----	---------------	--	--	--	--------	----

348 Spider

3.4	Petrol	235	03/93 → 04/94					
-----	--------	-----	---------------	--	--	--	--	--

348 tb/GTB

3.4	Petrol	221	02/90 → 04/94					
3.4	Petrol	235	10/93 → 04/94					

360 (F131)

3.6 Modena	Petrol	294	03/99 → 03/05					
------------	--------	-----	---------------	--	--	--	--	--



TYPE

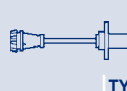

TYPE



TYPE

SAA110

SAA110

SAC091

H2

SAC091

H2

SAC091

H2

SAC091

H2

SAC091

H2

SAC091

H2

SAC091

H2

SAA110

SAC091

H2

SAA110

SAA110

SAC086

H2

SAC091

H2

SAA110

SAC086

H2

SAC091

H2

SAC091

H2

APS64

ESS0118A

J1

ESS0118A

J1

ESS0118A

J1

ESS0118A

J1

ESS0118A

J1

BAE680AG

BAE680AG

BAE680AG

SPA103

F1



KW



TYPE



TYPE

FERRARI

360 Spider (F131)

3.6 Petrol 294 02/00 → 03/05

412 i

4.9 Petrol 250 04/85 → 12/88

456 GT/GTA

5.5 (F116) Petrol 325 01/93 → 03/96

SVF015 B6

5.5 (F116) Petrol 325 01/93 → 06/04

512 BB

4.9 Petrol 237 07/81 → 08/84

512 TR

5.0 Petrol 315 01/92 → 10/94

SVF015 B6

F355 BERLINETTA

3.5 Petrol 280 05/94 → 10/95

SVF015 B6

3.5 Petrol 280 05/94 → 03/99

F355 GTS

3.5 Spider Petrol 280 07/94 → 10/95

SVF015 B6

3.5 Spider Petrol 280 07/94 → 12/00

F40

3.0 Petrol 352 01/90 → 06/92

MONDIAL

3.2 Quattrovalvole Petrol 199 10/85 → 12/87

SVF010 B6

3.2 Quattrovalvole Petrol 199 10/85 → 12/88

3.4 T Petrol 221 03/89 → 12/93

MONDIAL Cabriolet

3.2 Quattrovalvole Petrol 199 09/85 → 12/87

SVF010 B6

3.2 Quattrovalvole Petrol 199 09/85 → 12/88

3.4 T Petrol 221 01/89 → 12/93

TESTAROSSA

5.0 Petrol 272 08/86 → 10/91

SVF010 B6

5.0 Petrol 287 01/86 → 10/91

SVF010 B6

5.0 Petrol 287 01/86 → 12/91

5.0 Petrol 287 05/84 → 12/91

FIAT

124 Spider

1500 Sport (BS) Petrol 66 01/66 → 12/72

1600 Sport (BS1) Petrol 74 11/69 → 08/73

1600 Sport (BS1) Petrol 80 01/69 → 12/74

1800 Sport (CS1) Petrol 87 01/72 → 12/77

126

600 Petrol 17 09/72 → 06/77

650 Petrol 17 07/77 → 09/87

700 Petrol 19 09/87 → 06/96

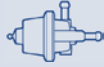

TYPE



TYPE



TYPE

SPA103

F1

ESS0118A

J1

ESS0172A

J1

ESS0118A

J1

SAG066

H1

BAE680AG

BAE680AG

ATS04-1

F2

ESS0118A

J1

SAG066

H1

BAE680AG

ESS0118A

J1

SAG066

H1

BAE680AG

SPA129

F1

ESS0118A

J1

SPA129

F1

ESS0118A

J1

BK2A

BK2A

BK2A

BK2A

SAA107

SPA101

F1

BZ600A

SPA101

F1



KW



TYPE



TYPE

FIAT

127

0.9	Petrol	33	06/71 → 05/83
0.9	Petrol	29	06/71 → 05/83
1.0	Petrol	37	04/77 → 12/86
1.0 Sport	Petrol	51	07/78 → 02/82
1.3 Diesel	Diesel	33	04/81 → 12/86
1.3 Sport	Petrol	55	12/81 → 05/83

CHASSIS: 1221151 →

127 Panorama

1.3 D	Diesel	33	06/81 → 12/86
-------	--------	----	---------------

128

1.1	Petrol	33	02/75 → 09/81
1.1	Petrol	40	03/69 → 12/84
1.3 Sport	Petrol	44	08/74 → 12/84

128 Coupé

1.3 Berlinetta (AC)	Petrol	54	06/75 → 12/79
---------------------	--------	----	---------------

131

1.3 Mirafiori	Petrol	40	10/74 → 09/81
1.3 Super Mirafiori	Petrol	57	03/78 → 12/80
1.6	Petrol	63	11/76 → 12/84
1.6 (S)	Petrol	55	10/74 → 12/80
1.6 Super	Petrol	71	03/78 → 01/84

132

2.0	Petrol	82	05/77 → 06/81
-----	--------	----	---------------

500

0.5	Petrol	13	01/65 → 12/75
-----	--------	----	---------------

500 (312)

0.9	Petrol	63	07/10 →
0.9	Petrol	63	09/10 → 05/11
1.2	Petrol	51	10/07 →
1.2	Petrol	51	10/07 →
1.2	Petrol	51	12/09 →
1.2	Petrol	51	10/08 →
1.2	Petrol	51	10/07 →
1.2 LPG	Petrol/LPG	51	12/10 →
1.2 LPG	Petrol/LPG	51	12/10 →
1.3 D Multijet	Diesel	55	10/07 →
1.3 D Multijet	Diesel	55	10/07 →
1.3 D Multijet	Diesel	55	10/07 →
1.3 D Multijet	Diesel	70	12/09 →
1.4	Petrol	74	10/07 →
1.4	Petrol	74	10/07 →
1.4 Abarth	Petrol	99	08/08 →
1.4 Abarth	Petrol	132	08/08 → 12/12
1.4 Abarth	Petrol	132	08/08 →

CFC328F.02 A3 40SMF10/1 B3

IAW5SF8.MR A1 KIT EC2/1 B2

IAW5SF9.MS1 A1

IAW5SF9.MS A1

ENGINE: 169A4000 40GTE3F B3

ENGINE: 169A4000 40GTE3F B3

MJD6F3B1 A1

MJD6F3B2 A1

ENGINE: 169A1000 40DFP1 B3

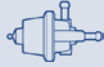

TYPE

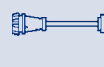

TYPE



TYPE

				SPA101	F1	SAA107				
									BK2A	
									BK2A	
									BK2A	
				SPA101	F1					
									BK2A	
									BK2A	
									BK2A	
				SPA101	F1					
									BK2A	
									BK2A	
									BK2A	
				SPA101	F1					
									BK2A	
									BK2A	
									BK2A	
				SPA101	F1					
						SAA107				
	APS36								GA2131	J2
									BAE680DB	
IWP160	KITLDF6T		SPA156	F1		CVM03/1	H1	BAE940A	GA2229	J2
						SAC079	H2			
									GA2229	J2
						SAC093	H2			
						SAG025	H1			
	APS36		SPA146	F1		SAF001	H4			
						SAC095	H2		GA2229	J2
						SAD026	H3			
			SPA156	F1				BAE680BQ	GA2131	J2
								BAE680BQ		
									GA2131	J2



KW



TYPE



TYPE

FIAT

500 C (312)

0.9	Petrol	63	09/09 →					
0.9	Petrol	63	09/10 → 05/11					
1.2	Petrol	51	09/09 →	ENGINE: 169A4000			40GTE3F	B3
1.2	Petrol	51	09/09 →					
1.3 D Multijet	Diesel	70	09/09 →					
1.4	Petrol	74	09/09 →					
1.4 Abarth	Petrol	103	09/09 →					

850 Coupé

0.9 Sport	Petrol	38	02/68 → 10/72					
-----------	--------	----	---------------	--	--	--	--	--

850 Spider

0.9 Sport	Petrol	38	03/68 → 12/72					
-----------	--------	----	---------------	--	--	--	--	--

ARGENTA (132A)

2000 i.e.	Petrol	90	06/81 → 07/86					
2000 i.e.	Petrol	90	01/83 → 07/86					
2500 Diesel	Diesel	53	06/81 → 11/85					

BARCETTA (183)

1.8 16V	Petrol	96	04/95 → 05/98				B3392	B1
1.8 16V	Petrol	96	04/95 → 05/05					
1.8 16V	Petrol	96	06/98 → 05/05					
1.8 16V	Petrol	96	04/95 → 05/05					

BRAVA (182)

1.2 16V 80	Petrol	59	10/00 → 09/01				TB0011	B3
1.2 16V 80	Petrol	59	10/00 → 10/01					
1.2 16V 80	Petrol	60	12/98 → 12/02					
1.2 16V 80	Petrol	59	10/00 → 09/01					
1.2 16V 80	Petrol	60	07/00 → 10/00					
1.4 (182.BG)	Petrol	55	10/95 → 10/01					
1.4 (182.BG)	Petrol	55	10/95 → 10/98					
1.6 16V (182.BH)	Petrol	66	10/95 → 12/97				KITEC1/02	B2
1.6 16V (182.BH)	Petrol	66	10/95 → 03/98				B02	B1
1.6 16V (182.BH)	Petrol	66	10/95 → 03/98				KITPF1C	B6
1.6 16V (182.BH)	Petrol	66	01/98 → 10/01				46SXF8	B3
1.6 16V (182.BH)	Petrol	66	10/95 → 12/97					
1.6 16V (182.BH)	Petrol	66	10/95 → 10/01					
1.6 16V (182.BH)	Petrol	66	10/95 → 10/01					
1.6 16V (182.BH)	Petrol	66	10/95 → 10/95					
1.6 16V (182.BH)	Petrol	66	01/01 → 10/01					
1.6 16V (182.BH)	Petrol	66	10/95 → 10/01	ENGINE: 182A6000-182A4000				
1.6 16V (182.BH)	Petrol	66	01/98 → 12/00					
1.6 16V (182.BH)	Petrol	66	07/00 → 10/01					
1.8 GT 16V (182.BC)	Petrol	83	10/96 → 07/99				B3392	B1
1.8 GT 16V (182.BC)	Petrol	83	10/95 → 10/01					
1.8 GT 16V (182.BC)	Petrol	83	10/95 → 10/98					
1.8 GT 16V (182.BC)	Petrol	83	11/98 → 07/99					

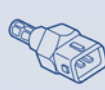
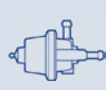

TYPE

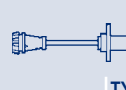

TYPE



TYPE

	APS36				SAG082	H1	GA2131	J2
							BAE680DB	
					SAG082	H1	GA2229	J2
		SPA146	F1		SAF001	H4		
							GA2229	J2
							BAE680BQ	
							BK2A	
							BK2A	
	PRT03/04	SPA101	F1					
					SEN8D	H1		
		SPA101	F1					
					SAC049	H2		
		SPA101	F1				ESS0095A	J1
							BAE680G	
							SUA133	J2
							BAE680AG	
	KITLDF6T				SAD026	H3	GA2020	J2
	APS59				SAD013	H3	BAE680AG	SUA537
							SUA541	J2
							GA2020	J2
		SPA101	F1		SAD013	H3	GA2155	J2
					SAG121	H1	BAE680AG	ESS514
IWP001/1		KITRPM40						
		RPM40						
	PRT03/04	SPA101	F1		CWM02/1	H1	ESS0095A	J1
		SZA104	F1					
		ATS04-1	F2					
		SZA105	F1					
							BAE920AX	
							GA2015	J2
							GA2020	J2
IWP006		SPA101	F1				ESS0095A	J1
		SPA164	F1					
					SAC049	H2		



KW

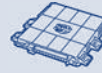

TYPE



TYPE

FIAT

BRAVA (182)

1.8 GT 16V (182.BC)	Petrol	83	08/99 → 10/01
1.8 GT 16V (182.BC)	Petrol	83	07/00 → 10/01
1.9 D	Diesel	48	10/95 → 10/01
1.9 JTD	Diesel	74	09/00 → 10/01
1.9 JTD	Diesel	74	09/00 → 09/01
1.9 JTD 105	Diesel	77	12/98 → 10/01
1.9 JTD 105	Diesel	77	12/98 → 09/01
2.0	Petrol	113	11/98 → 08/00

BRAVO I (182)

1.2 16V 80	Petrol	59	10/00 → 09/01
1.2 16V 80	Petrol	59	10/00 → 10/01
1.2 16V 80	Petrol	60	12/98 → 10/00
1.2 16V 80	Petrol	59	10/00 → 09/01
1.2 16V 80	Petrol	60	07/00 → 10/00
1.4 (182.AG)	Petrol	55	10/95 → 10/01
1.4 (182.AG)	Petrol	55	10/95 → 10/98
1.6 16V (182.AH)	Petrol	66	10/95 → 12/97
1.6 16V (182.AH)	Petrol	66	10/95 → 03/98
1.6 16V (182.AH)	Petrol	66	10/95 → 03/98
1.6 16V (182.AH)	Petrol	66	01/98 → 10/01
1.6 16V (182.AH)	Petrol	66	10/95 → 12/97
1.6 16V (182.AH)	Petrol	66	10/95 → 10/01
1.6 16V (182.AH)	Petrol	66	10/95 → 10/01
1.6 16V (182.AH)	Petrol	66	10/95 → 10/95
1.6 16V (182.AH)	Petrol	66	01/01 → 10/01
1.6 16V (182.AH)	Petrol	66	10/95 → 10/01
1.6 16V (182.AH)	Petrol	66	01/98 → 12/00
1.6 16V (182.AH)	Petrol	66	07/00 → 10/01
1.8 GT (182.AC)	Petrol	83	10/96 → 07/99
1.8 GT (182.AC)	Petrol	83	10/95 → 10/01
1.8 GT (182.AC)	Petrol	83	10/95 → 07/99
1.8 GT (182.AC)	Petrol	83	11/98 → 07/99
1.8 GT (182.AC)	Petrol	83	08/99 → 10/01
1.8 GT (182.AC)	Petrol	83	07/00 → 10/01
1.9 D	Diesel	48	10/95 → 10/01
1.9 JTD	Diesel	74	09/00 → 10/01
1.9 JTD	Diesel	74	09/00 → 09/01
1.9 JTD 105	Diesel	77	12/98 → 10/01
1.9 JTD 105	Diesel	77	12/98 → 09/01
2.0 HGT 20V (182.AD)	Petrol	108	10/95 → 07/98
2.0 HGT 20V (182.AD)	Petrol	108	10/95 → 07/98
2.0 HGT 20V (182.AD)	Petrol	108	10/95 → 07/98
2.0 HGT 20V (182AQ)	Petrol	113	07/98 → 10/01
2.0 HGT 20V (182AQ)	Petrol	113	11/98 → 10/01

ENGINE: 182A6000-182A4000

TB0018

B3

TB0018

B3

TB0011

B3

KITEC1/02

B2

B02

B1

KITPF1C

B6

46SXF8

B3

B3392

B1

TB0018

B3

B3393

B1

SVF015

B6



TYPE

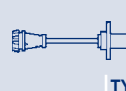

TYPE



TYPE

BAE680G									
								GA2020	J2
		SPA101	F1						
	APS31				SAC088	H2		ESS0066A	J1
								SUA527	J2
	APS31	SPA103	F1		SAC088	H2		ESS0066A	J1
								SUA521	J2
BAE680AM									
BAE680AG									
	KITLDF6T				SAD026	H3		GA2020	J2
	APS59				SAD013	H3	BAE680AG	SUA537	J2
								SUA541	J2
								GA2020	J2
		SPA101	F1		SAD013	H3		GA2155	J2
					SAG121	H1	BAE680AG	ESS514	J1
IWP001/1		KITRPM40							
		RPM40							
	PRT03/04	SPA101	F1		CWM02/1	H1		ESS0095A	J1
		SZA104	F1						
		ATS04-1	F2						
		SZA105	F1						
BAE920AX									
								GA2015	J2
								GA2020	J2
IWP006		SPA101	F1					ESS0095A	J1
		SPA164	F1						
					SAC049	H2			
BAE680G									
								GA2020	J2
		SPA101	F1						
	APS31				SAC088	H2		ESS0066A	J1
								SUA527	J2
	APS31	SPA103	F1		SAC088	H2		ESS0066A	J1
								SUA521	J2
		SPA101	F1		SAC049	H2	BAE680CY		
					SAD009	H3			
					SAG121	H1			
		SPA104	F1		SAD003	H3			
					SAC024	H2			



KW



TYPE



TYPE

FIAT

BRAVO I (182)

2.0 HGT 20V (182AQ)	Petrol	113	11/98 → 10/01					
2.0 HGT 20V (182AQ)	Petrol	113	11/98 → 09/01					

BRAVO II (198)

1.4	Petrol	66	04/07 →				TB0009	B3
1.4	Petrol	66	04/07 →					
1.4 16V	Petrol	103	03/10 →					
1.4 T-Jet	Petrol	110	09/07 →					
1.4 T-Jet	Petrol	88	09/07 →					
1.6 D Multijet	Diesel	77	03/08 →				48CPD6G	B3
1.6 D Multijet	Diesel	88	03/08 →				48CPD6G	B3
1.6 D Multijet	Diesel	77	03/08 →					
1.6 D Multijet	Diesel	85	11/08 →					
1.6 D Multijet	Diesel	88	03/08 →					
1.9 D Multijet	Diesel	110	04/07 →				48CPD6	B3
1.9 D Multijet	Diesel	88	04/07 →	ENGINE: 192A8000			48CPD9	B3
1.9 D Multijet	Diesel	110	04/07 →					
1.9 D Multijet	Diesel	88	04/07 →					
2.0 D Multijet	Diesel	121	09/08 →				48CPD6G	B3
2.0 D Multijet	Diesel	120	09/08 →					

BRAVO Van (198)

1.6 Multijet	Diesel	77	03/08 →					
--------------	--------	----	---------	--	--	--	--	--

CINQUECENTO (170)

0.7 i (170AD)	Petrol	22	07/94 → 01/98					
0.9 (170AB)	Petrol	30	07/91 → 12/93					
0.9 i.e. (170AC)	Petrol	30	07/91 → 12/93				KITPF2C	B6
0.9 i.e. (170AC)	Petrol	30	07/91 → 12/93					
0.9 i.e. S (170AF, 170CF)	Petrol	29	07/91 → 01/98				KITPF2C	B6
0.9 i.e. S (170AF, 170CF)	Petrol	29	07/91 → 12/97				KITEC1/02	B2
0.9 i.e. S (170AF, 170CF)	Petrol	29	01/92 → 01/98				B01	B1
0.9 i.e. S (170AF, 170CF)	Petrol	29	07/91 → 01/98					
0.9 i.e. S (170AF, 170CF)	Petrol	29	07/91 → 01/98					
0.9 i.e. S (170AF, 170CF)	Petrol	29	07/91 → 01/98					
0.9 i.e. S (170AF, 170CF)	Petrol	29	07/91 → 07/99					
1.1 Sporting (170AH)	Petrol	40	10/94 → 01/98				B12	B1
1.1 Sporting (170AH)	Petrol	40	10/94 → 01/98				KITPF2C	B6
1.1 Sporting (170AH)	Petrol	40	10/94 → 12/97				KITEC1/02	B2
1.1 Sporting (170AH)	Petrol	40	10/94 → 01/98					
1.1 Sporting (170AH)	Petrol	40	10/94 → 01/98					

COUPE (FA/175)

2.0 16V	Petrol	102	11/93 → 08/96					
2.0 16V	Petrol	102	11/93 → 08/96					
2.0 16V	Petrol	102	11/93 → 08/96					
2.0 16V	Petrol	102	11/93 → 08/96					
2.0 16V	Petrol	102	03/94 → 08/96					



TYPE



TYPE



TYPE

						SAG122	H1			
								BAE680AM		
						SAC095	H2	BAE403C	SUA544	J2
						SAD026	H3			
								BAE680CD		
			SPA156	F1		SAD026	H3	BAE680BQ		
			SPA156	F1				BAE680BQ		
	APS36					SAF001	H4		GA2191	J2
	APS36					SAF001	H4		GA2191	J2
						SAG080	H1			
	APS36					SAF001	H4			
						SAG080	H1			
	APS36					SAF001	H4		GA2191	J2
						SAG133	H1			
	APS36					SAF001	H4		GA2191	J2
	APS36					SAF001	H4			
	APS36					SAF001	H4			
	APS36									
						SEN8D	H1	BAE800B		
			SPA101	F1	SAA101					
			KITATS05	F2	SAA101					
			SPA101	F1						
			KITATS05	F2	SAA101					
	PRT03/04		WTS05-1	F1		SEN8D3	H1	BAE800B		
			SPA101	F1						
			SZA103	F1						
	PRT03/04		KITATS05	F2		CWM02/6	H1	BAE800B	ESS273/1	J1
			SPA101	F1					ESS273/1	J1
			SZA103	F1						
			WTS05-1	F1						
	PRT03/04	KITRPM40	ATS04-1	F2		SEN8I	H1			
		RPM40	SPA101	F1						
			SZA103	F1						
			WTS05-1	F1						
									ESS531	J1



KW

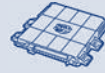

TYPE



TYPE

FIAT

COUPE (FA/175)

2.0 16V Turbo	Petrol	140	11/93 → 08/96					
2.0 16V Turbo	Petrol	140	11/93 → 08/96					
2.0 16V Turbo	Petrol	140	11/93 → 08/96					
2.0 16V Turbo	Petrol	140	11/93 → 08/96					
2.0 20V	Petrol	113	04/98 → 08/00					
2.0 20V	Petrol	113	04/98 → 08/00					
2.0 20V	Petrol	113	04/98 → 08/00					

CROMA (154)

1600	Petrol	61	12/85 → 12/90					
1600	Petrol	61	01/88 → 12/90					
2000 CHT (154.AC)	Petrol	66	12/85 → 02/89					
2000 i.e. (154.AD)	Petrol	88	03/87 → 09/92					
2000 i.e. (154.AD)	Petrol	88	01/88 → 09/92					
2000 i.e. (154.AD)	Petrol	88	01/91 → 09/92					
2000 i.e. (154.AM)	Petrol	83	03/86 → 09/90					
2000 i.e. (154.AM, 154.LM)	Petrol	85	01/92 → 08/96					
2000 i.e. (154.AM, 154.LM)	Petrol	85	01/91 → 08/96					
2000 i.e. (154.AM, 154.LM)	Petrol	85	01/91 → 08/96					
2000 i.e. (154.AM, 154.LM)	Petrol	85	01/91 → 01/92					
2000 i.e. (154.AM, 154.LM)	Petrol	85	01/91 → 01/92					
2000 i.e. (154.AM, 154.LM)	Petrol	85	10/87 → 08/96					
2000 i.e. (154.AM, 154.LM)	Petrol	85	10/87 → 12/93					
2000 i.e. Turbo (154.AM)	Petrol	114	12/85 → 06/90					
2000 i.e. Turbo (154.AM, 154.LM)	Petrol	110	01/91 → 08/96					
2000 i.e. Turbo (154.AM, 154.LM)	Petrol	110	06/87 → 08/96					
2500 TDE	Diesel	77	12/91 → 08/96					

CROMA (194)

1.8 16V	Petrol	103	12/05 →					
1.8 16V	Petrol	103	12/05 →					
1.9 D Multijet	Diesel	100	12/05 →	ENGINE: 939A8000		CAD191	B2	
1.9 D Multijet	Diesel	110	06/05 →	ENGINE: 939A2000		CAD191	B2	
1.9 D Multijet	Diesel	110	06/05 →			48CPD4	B3	
1.9 D Multijet	Diesel	85	06/05 →			48CPD1	B3	
1.9 D Multijet	Diesel	88	06/05 →			48CPD1	B3	
1.9 D Multijet	Diesel	100	12/05 →					
1.9 D Multijet	Diesel	110	06/05 →					
1.9 D Multijet	Diesel	110	06/05 →					
2.2 16V	Petrol	108	06/05 →					
2.4 D Multijet	Diesel	147	06/05 →			48CPD4	B3	
2.4 D Multijet	Diesel	147	06/05 →					
2.4 D Multijet	Diesel	147	06/05 →					



TYPE



TYPE



TYPE

			KITRPM36	ATS04-1	F2		SAD009	H3	BAE800B	ESS0025A	J1
			RPM36	SPA101	F1		SEN8I	H1			
				SZA103	F1						
				WTS05-1	F1						
							SAC024	H2	BAE680AM		
							SAD003	H3			
							SAG122	H1			
							SEN8D	H1			
									BAE504F		
							SEN8D	H1	BAE504D		
		PRT03/04							BAE504D	ESS0173A	J1
				ATS04-1	F2		SEN8D	H1			
				SPA104	F1						
				SPA104	F1		SEN8D	H1	BAE504D	ESS0173A	J1
		PRT03/04									
				ATS04-1	F2		SEN8D	H1			
				SPA104	F1						
				SZA103	F1						
				WTS05-1	F1						
							SEN8E	H1	BAE504F	ESS0173A	J1
									BAE504D		
				SPA104	F1		SEN8D	H1		ESS0173A	J1
				SPA104	F1						
							SEN8D	H1		ESS0174A	J1
										ESS0174A	J1
							SAC062	H2		SUA550	J2
							SAD033	H3			
		APS36		ATS20	F2		SAC068	H2		GA2140	J2
		APS36					SAF001	H4			
		APS36		ATS20	F2					GA2140	J2
		APS36					SAF001	H4			
							SAF001	H4			
							SAG133	H1			
		APS44					SAG083	H1	BAE608N	SUA550	J2
		APS36		ATS20	F2		SAC068	H2		GA2140	J2
							SAF001	H4			
							SAG133	H1			



KW



TYPE



TYPE

FIAT

DOBLO (119)

1.2 (223AXA1A)	Petrol	48	03/01 → 12/03		IAW59F.SC/1	A1		
1.2 (223AXA1A)	Petrol	48	03/01 → 12/03		IAW59F.SCR	A2		
1.2 (223AXA1A)	Petrol	48	03/01 →	ENGINE: 223A5000			36SXF1/4	B3
1.2 (223AXA1A)	Petrol	48	03/01 →				KIT EC2/1	B2
1.2 (223AXA1A)	Petrol	48	03/01 →	ENGINE: 223A5000			IPF2C	B6
1.2 (223AXA1A)	Petrol	48	03/01 → 12/04					
1.2 (223AXA1A)	Petrol	48	03/01 → 01/02					
1.2 (223AXA1A)	Petrol	48	03/01 →	ENGINE: 2533528 →				
1.3 D Multijet	Diesel	62	05/08 →		MJD6F3D1	A1		
1.3 D Multijet	Diesel	62	10/06 →		MJD6F3D5	A1		
1.3 D Multijet	Diesel	62	10/05 →					
1.3 D Multijet	Diesel	62	10/05 →					
1.3 JTD	Diesel	55	09/05 →					
1.4	Petrol	57	10/05 →		IAW5SF.MB	A1	44SMF9/1	B3
1.4	Petrol	57	10/05 →				KIT EC2/1	B2
1.4	Petrol	57	10/05 →	ENGINE: 831A1000				
1.6	Petrol	68	09/02 →	ENGINE: 182B6000				
1.6 16V (223AXD1A)	Petrol	76	02/03 →	ENGINE: 182B6000	IAW4AF.G1/1	A1		
1.6 16V (223AXD1A)	Petrol	76	02/04 →	ENGINE: 182B6000	IAW4AF.G2	A1		
1.6 16V (223AXD1A)	Petrol	76	10/01 →				KIT48SMF5	B3
1.6 16V (223AXD1A)	Petrol	76	10/01 → 12/04					
1.6 16V (223AXD1A)	Petrol	76	10/01 →	ENGINE: 182B600				
1.6 Natural Power	BiFuel	76	01/06 →		IAW4AF.G3/1	A1		
1.6 Natural Power	BiFuel	76	09/02 →					
1.6 Natural Power	BiFuel	76	09/02 →	ENGINE: 182B6000				
1.9 D Multijet	Diesel	88	10/05 →				48CPD8	B3
1.9 D Multijet	Diesel	88	10/05 →					
1.9 JTD	Diesel	77	07/03 →					
1.9 JTD (223AXE1A)	Diesel	74	10/01 →					
1.9 JTD (223AXE1A)	Diesel	74	10/01 → 01/04					

DOBLO Cargo (223)

1.2 (223ZX1A)	Petrol	48	03/01 → 12/03		IAW59F.SC/1	A1		
1.2 (223ZX1A)	Petrol	48	03/01 → 12/03		IAW59F.SCR	A2		
1.2 (223ZX1A)	Petrol	48	03/01 →	ENGINE: 223A5000			36SXF1/4	B3
1.2 (223ZX1A)	Petrol	48	03/01 →				KIT EC2/1	B2
1.2 (223ZX1A)	Petrol	48	03/01 →	ENGINE: 223A5000			IPF2C	B6
1.2 (223ZX1A)	Petrol	48	03/01 → 12/04					
1.2 (223ZX1A)	Petrol	48	03/01 → 01/02					
1.2 (223ZX1A)	Petrol	48	03/01 →	ENGINE: 2533528 →				
1.3 D Multijet	Diesel	55	10/05 → 01/10		MJD6F3D2	A1		
1.3 D Multijet	Diesel	55	10/05 → 04/07		MJD6F3D4	A1		
1.3 D Multijet	Diesel	55	05/07 → 01/10		MJD6F3D4/1	A1		
1.3 D Multijet	Diesel	55	10/05 → 01/10					
1.3 JTD 16V	Diesel	51	05/04 → 12/06					



TYPE

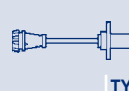

TYPE



TYPE

IWP116/1					SAC094	H2	BAE800B	GA2122	J2
	KITTPRT05/2				CWM02/8	H1			
		816001633701	F1		CVM03/1	H1			
	APS36				SAC093	H2		SUA535	J2
					SAG025	H1			
								SUA531	J2
IWP160	KITLDF6T	SPA156	F1		CVM03/1	H1			
					SAC079	H2			
							BAE940A		
							BAE403B		
IWP164		SPA101	F1		CWM02/1	H1		GA2122	J2
	KITTPRT05/2							BAE403B	
		SPA101	F1		CWM02/1	H1	BAE920AX		
							BAE403B		
	APS36	ATS20	F2		SAC088	H2		SUA535	J2
					SAF001	H4			
	APS23				SAC088	H2		SUA531	J2
	APS23				SAC088	H2		ESS0066A	J1
								SUA531	J2
IWP116/1					SAC094	H2	BAE800B	GA2122	J2
	KITTPRT05/2				CWM02/8	H1			
		816001633701	F1		CVM03/1	H1			
		ATS20	F2		SAC093	H2		SUA531	J2
					SAG025	H1			
					SAC093	H2		ESS0066A	J1



KW



TYPE



TYPE

FIAT

DOBLO Cargo (223)

1.3 JTD 16V	Diesel	51	05/04 → 12/06					
1.3 JTD 16V	Diesel	51	05/04 → 09/05					
1.3 JTD 16V Multijet	Diesel	62	08/06 →					
1.4	Petrol	57	10/05 →		IAW5SF.MB	A1	44SMF9/1	B3
1.4	Petrol	57	10/05 →				KIT EC2/1	B2
1.4	Petrol	57	10/05 →	ENGINE: 831A1000				
1.6 16V (223ZXD1A)	Petrol	76	02/03 →	ENGINE: 182B6000	IAW4AF.G1/1	A1		
1.6 16V (223ZXD1A)	Petrol	76	02/04 →	ENGINE: 182B6000-	IAW4AF.G2	A1		
1.6 16V (223ZXD1A)	Petrol	76	10/01 →				KIT48SMF5	B3
1.6 16V (223ZXD1A)	Petrol	76	10/01 → 12/04					
1.6 16V (223ZXD1A)	Petrol	76	10/01 →	ENGINE: 182B600				
1.6 Natural Power	BiFuel	76	01/06 →		IAW4AF.G3/1	A1		
1.6 Natural Power	BiFuel	76	09/02 →					
1.6 Natural Power	BiFuel	76	09/02 →	ENGINE: 182B6000				
1.9 JTD	Diesel	77	07/03 →					
1.9 JTD	Diesel	77	07/03 →					
1.9 JTD (223ZXE1A)	Diesel	74	10/01 →					
1.9 JTD (223ZXE1A)	Diesel	74	10/01 → 01/04					
1.9 JTD Multijet	Diesel	88	12/06 →					

DOBLO Cassone / Furgonato / Promiscuo (263)

1.3 D Multijet	Diesel	66	02/10 →	ENGINE: 199A3000			40CDSF1	B3
1.3 D Multijet	Diesel	66	02/10 →	ENGINE: 263A2000			40DFP1	B3
1.3 D Multijet	Diesel	66	02/10 →					
1.4	Petrol	88	10/11 →					
1.4 Natural Power	BiFuel	88	06/10 →					
1.6 D Multijet	Diesel	74	02/10 →					
1.6 D Multijet	Diesel	77	02/10 →					
1.6 D Multijet	Diesel	74	02/10 →					
1.6 D Multijet	Diesel	77	02/10 →					
2.0 D Multijet	Diesel	99	02/10 →					

DOBLO Combi (152, 263)

1.3 D Multijet	Diesel	66	02/10 →	ENGINE: 199A3000			40CDSF1	B3
1.3 D Multijet	Diesel	66	02/10 →	ENGINE: 263A2000			40DFP1	B3
1.3 D Multijet	Diesel	66	02/10 →					
1.4	Petrol	88	10/11 →					
1.4 Natural Power	BiFuel	88	02/10 →	ENGINE: 198A4000			44SMF9/1	B3
1.4 Natural Power	BiFuel	88	06/10 →					
1.6 D Multijet	Diesel	66	02/10 →					
1.6 D Multijet	Diesel	77	02/10 →					
1.6 D Multijet	Diesel	66	02/10 →					
2.0 D Multijet	Diesel	99	02/10 →					



TYPE

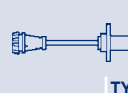

TYPE



TYPE

						SAG025	H1			
									SUA531	J2
		APS36								
IWP160	KITLDF6T		SPA156	F1		CVM03/1	H1			
						SAC079	H2			
								BAE940A		
IWP164			SPA101	F1		CWM02/1	H1		GA2122	J2
	KITTPRT05/2									
								BAE403B		
			SPA101	F1		CWM02/1	H1	BAE920AX		
								BAE403B		
	APS23					SAC088	H2		ESS0066A	J1
									SUA531	J2
	APS23					SAC088	H2		ESS0066A	J1
									SUA531	J2
	APS36					SAF001	H4		ESS0066A	J1
	APS36		SPA146	F1		SAF001	H4			
								BAE680BQ		
								BAE680BQ		
	APS63					SAF001	H4			
	APS36					SAF001	H4			
						SAG080	H1			
						SAG080	H1			
	APS63					SAF001	H4			
	APS36		SPA146	F1		SAF001	H4		GA2097	J2
								BAE680BQ		
								BAE680BQ		
	APS36					SAF001	H4			
	APS63					SAF001	H4		GA2097	J2
						SAG080	H1			
	APS63					SAF001	H4		GA2097	J2



KW



TYPE



TYPE

FIAT

DOBLO Pianale piatto/Telaio (263)

1.3 D Multijet	Diesel	66	02/10 →	ENGINE: 199A3000				40CDSF1	B3
1.3 D Multijet	Diesel	66	02/10 →	ENGINE: 263A2000				40DFP1	B3
1.3 D Multijet	Diesel	66	02/10 →						
1.6 D Multijet	Diesel	66	02/10 →						
1.6 D Multijet	Diesel	77	02/10 →						
1.6 D Multijet	Diesel	74	02/11 →						
2.0 D Multijet	Diesel	99	02/10 →						

DUCATO Autobus (230)

1.9 D	Diesel	50	04/98 → 04/02						
1.9 TD	Diesel	66	04/98 → 04/02						
1.9 TD Combinato	Diesel	59	08/94 → 04/02						
1.9 TD Panorama/Combinato	Diesel	60	03/94 → 04/02						
2.0 4x4	Petrol	80	11/94 → 11/01						
2.0 JTD	Diesel	62	10/01 → 04/02						
2.0 JTD	Diesel	62	10/01 → 03/02						
2.0 Panorama/Combinato	Petrol	80	03/94 → 04/94					B04	B1
2.0 Panorama/Combinato	Petrol	80	03/94 → 12/95					PF90/018	B6
2.0 Panorama/Combinato	Petrol	80	01/96 → 04/02					PF16080067	B6
2.0 Panorama/Combinato	Petrol	80	03/94 → 04/02	ENGINE: XU10J2U					
2.0 Panorama/Combinato	Petrol	80	03/94 → 04/02	ENGINE: XU10J2U					
2.0 Panorama/Combinato	Petrol	80	03/94 → 04/02						
2.0 Panorama/Combinato	Petrol	80	02/95 → 04/02						
2.0 Panorama/Combinato	Petrol	80	03/94 → 03/02						
2.5 D Combinato	Diesel	62	08/94 → 04/02						
2.5 TDI 4x4	Diesel	85	04/97 → 03/98						
2.5 TDI Combinato	Diesel	80	08/94 → 04/02						
2.5 TDI Panorama/Combinato	Diesel	80	07/94 → 04/02						
2.5 TDI Panorama/Combinato	Diesel	85	03/94 → 04/02						
2.5 TDI Panorama/Combinato	Diesel	80	07/94 → 03/98						
2.5 TDI Panorama/Combinato	Diesel	85	03/94 → 03/98						
2.8 D	Diesel	64	02/98 → 04/02						
2.8 JTD	Diesel	94	11/00 → 04/02						
2.8 JTD	Diesel	94	11/00 → 03/02						
2.8 JTD 4x4	Diesel	94	11/00 → 04/02						
2.8 JTD 4x4	Diesel	94	11/00 → 03/02	ENGINE: 814043S					
2.8 TDI	Diesel	90	10/97 → 04/02						
2.8 TDI 4x4	Diesel	90	07/99 → 04/02						

DUCATO Autobus (244, Z_)

2.0	Petrol	81	04/02 →						
2.0	Petrol	81	04/02 →						
2.0	Petrol	81	04/02 →						
2.0	Petrol	81	04/02 → 08/06						
2.0 4x4	Petrol	81	05/02 → 07/06						
2.0 Bipower	Petrol/CNG	81	11/02 →						



TYPE

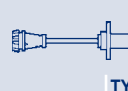

TYPE



TYPE

	APS36		SPA146	F1		SAF001	H4		
	APS36					SAF001	H4		
	APS36					SAF001	H4		
						SAF001	H4		
	APS36					SAF001	H4		

						SAA118			
						SAA118	SAG150	H1	
						SAA101			
						SAA101			
							SAC070	H2	BAE680AF
						SAA118	SAG157	H1	ESS534
									ESS0066A
									SUA528

	PRT03/04	KITRPM36	SZA101	F1					
		RPM36				SAA101	SAC070	H2	ESS534
							SAG150	H1	
									BAE680AF
						SAA101			
							SAG071	H1	
						SAA101			
						SAA101			
						SAA101			
							SAG071	H1	
							SAG071	H1	
							CWM02/2	H1	
			SPA103	F1			SAG089	H1	ESS0066A
									SUA528
			SPA103	F1			SAG089	H1	ESS0066A
									SUA528
							SAG071	H1	ESS0066A
							SAG071	H1	ESS0066A

			SPA167	F1	SAA118	SAC070	H2		GA2045
						SAD033	H3		
						SAG157	H1		
									BAE680AF
									BAE680AF
						SAC070	H2		



KW

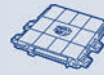

TYPE



TYPE

FIAT

DUCATO Autobus (244, Z_)

2.0 Bipower	Petrol/CNG	81	11/02 →					
2.0 Bipower	Petrol/CNG	81	11/02 → 08/06					
2.0 JTD	Diesel	62	04/02 →					
2.0 JTD	Diesel	62	04/02 → 08/06					
2.0 JTD	Diesel	62	04/02 → 08/06					
2.3 JTD	Diesel	81	04/02 →					
2.3 JTD	Diesel	81	04/02 →					
2.3 JTD	Diesel	81	04/02 → 08/06					
2.8 JTD	Diesel	94	04/02 →					
2.8 JTD	Diesel	94	04/02 → 08/06					
2.8 JTD 4x4	Diesel	94	07/02 →					
2.8 JTD 4x4	Diesel	94	07/02 → 08/06					

DUCATO Autobus (250)

100 Multijet 2,2 D	Diesel	74	07/06 →				AMM19656	B4
100 Multijet 2,2 D	Diesel	74	07/06 →					
100 Multijet 2,2 D	Diesel	74	07/06 →					
100 Multijet 2,2 D	Diesel	74	07/06 →					
100 Multijet 2,2 D	Diesel	74	07/06 →					
110 Multijet 2,3 D	Diesel	83	10/11 →	ENGINE: F1AE3481G			54DTE3I	B3
110 Multijet 2,3 D	Diesel	83	10/11 →					
115 Multijet 2,0 D	Diesel	85	06/11 →					
120 Multijet 2,3 D	Diesel	88	07/06 →	ENGINE: F1AE0481D			KBLCF01	B2
120 Multijet 2,3 D	Diesel	88	07/06 →				54DTS3I	B3
120 Multijet 2,3 D	Diesel	88	07/06 →					
120 Multijet 2,3 D	Diesel	88	07/06 →					
120 Multijet 2,3 D	Diesel	88	07/06 →					
120 Multijet 2,3 D	Diesel	88	07/06 →					
130 Multijet 2,3 D	Diesel	96	01/07 →					
140 Natural Power	Petrol/CNG	100	04/09 →					
150 Multijet 2,3 D	Diesel	109	06/11 →	ENGINE: F1AE3481E			54DTE3I	B3
150 Multijet 2,3 D	Diesel	109	06/11 →					
160 Multijet 3,0 D	Diesel	116	07/06 →					
160 Multijet 3,0 D	Diesel	116	07/06 →					
160 Multijet 3,0 D	Diesel	116	07/06 →					
160 Multijet 3,0 D	Diesel	116	07/06 →					
3.0 D Multijet	Diesel	130	06/11 →					

DUCATO Furgonato (230L)

1.9 D	Diesel	50	04/98 → 04/02					
1.9 TD	Diesel	60	03/94 → 04/02					
1.9 TD	Diesel	66	04/98 → 04/02					
1.9 TD CAT	Diesel	59	08/94 → 04/02					
2.0	Petrol	80	03/94 → 04/94				B04	B1
2.0	Petrol	80	03/94 → 12/95				PF90/018	B6
2.0	Petrol	80	01/96 → 04/02				PF16080067	B6



TYPE



TYPE



TYPE

						SAG157	H1		
								BAE680AF	
					SAA118				ESS0066A J1
						SAG157	H1		
								SUA528	J2
			SPA103	F1		SAC054	H2	ESS0066A	J1
						SAG058	H1		
								SUA528	J2
	APS50		SPA103	F1		SAG089	H1	ESS0066A	J1
								SUA528	J2
	APS50		SPA103	F1		SAG089	H1	ESS0066A	J1
								SUA528	J2
					SAA113			ESS0066A	J1
								GA2127	J2
								SUA587	J3
								SUA588	J3
								SUA589	J3
						SAF001	H4		
	APS36					SAF001	H4	GA2202	J2
			ATS20	F2		SAC054	H2	ESS0066A	J1
						SAG110	H1	GA2202	J2
								SUA587	J3
								SUA588	J3
								SUA589	J3
						SAF001	H4	GA2202	J2
						SAG110	H1	GA2131	J2
						SAF001	H4	GA2202	J2
			ATS20	F2		SAG110	H1	GA2202	J2
								SUA587	J3
								SUA588	J3
								SUA589	J3
						SAF001	H4	GA2202	J2
					SAA118				
					SAA101				
					SAA118	SAG150	H1		
					SAA101				



KW



TYPE



TYPE

FIAT

DUCATO Furgonato (230L)

2.0	Petrol	80	03/94 → 04/02	ENGINE: XU10J2U					
2.0	Petrol	80	03/94 → 04/02	ENGINE: XU10J2U					
2.0	Petrol	80	03/94 → 04/02						
2.0	Petrol	80	02/95 → 04/02						
2.0	Petrol	80	03/94 → 03/02						
2.0 4x4	Petrol	80	11/94 → 03/02						
2.0 JTD	Diesel	62	10/01 → 04/02						
2.0 JTD	Diesel	62	10/01 → 03/02						
2.8 D	Diesel	64	05/98 → 04/02						
2.8 JTD	Diesel	94	11/00 → 04/02						
2.8 JTD	Diesel	94	11/00 → 03/02						
2.8 JTD 4x4	Diesel	94	11/00 → 04/02						
2.8 JTD 4x4	Diesel	94	11/00 → 03/02	ENGINE: 814043S					
2.8 TDI	Diesel	90	10/97 → 04/02						
2.8 TDI 4x4	Diesel	90	06/99 → 04/02						

DUCATO Furgonato (244)

2.0	Petrol	81	04/02 →						
2.0	Petrol	81	04/02 →						
2.0	Petrol	81	04/02 →						
2.0	Petrol	81	04/02 → 08/06						
2.0 4x4	Petrol	81	05/02 → 07/06						
2.0 Bipower	Petrol/CNG	81	11/02 →						
2.0 Bipower	Petrol/CNG	81	11/02 →						
2.0 Bipower	Petrol/CNG	81	11/02 → 08/06						
2.0 JTD	Diesel	62	04/02 →						
2.0 JTD	Diesel	62	04/02 → 08/06						
2.0 JTD	Diesel	62	04/02 → 08/06						
2.3 JTD	Diesel	81	04/02 →						
2.3 JTD	Diesel	81	04/02 →						
2.3 JTD	Diesel	81	04/02 → 08/06						
2.8 JTD	Diesel	94	04/02 →						
2.8 JTD	Diesel	94	04/02 → 08/06						
2.8 JTD 4x4	Diesel	94	07/02 →						
2.8 JTD 4x4	Diesel	94	07/02 → 08/06						
2.8 JTD Power	Diesel	107	05/04 →						
2.8 JTD Power	Diesel	107	05/04 → 08/06						

DUCATO Furgonato (250)

100 Multijet 2,2 D	Diesel	74	07/06 →				AMM19656	B4	
100 Multijet 2,2 D	Diesel	74	07/06 →						
100 Multijet 2,2 D	Diesel	74	07/06 →						
100 Multijet 2,2 D	Diesel	74	07/06 →						
110 Multijet 2,3 D	Diesel	83	10/11 →	ENGINE: F1AE3481G			54DTE3I	B3	
110 Multijet 2,3 D	Diesel	83	10/11 →						
115 Multijet 2,0 D	Diesel	85	06/11 →						



TYPE

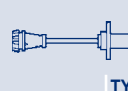

TYPE



TYPE

	PRT03/04	KITRPM36	SZA101	F1					
		RPM36							
					SAA118	SAC070	H2	ESS534	J1
						SAG150	H1		
								BAE680AF	
								BAE680AF	
					SAA118	SAG157	H1	ESS0066A	J1
								SUA528	J2
						CWM02/2	H1		
			SPA103	F1		SAG089	H1	ESS0066A	J1
								SUA528	J2
			SPA103	F1		SAG089	H1	ESS0066A	J1
								SUA528	J2
						SAG071	H1	ESS0066A	J1
						SAG071	H1	ESS0066A	J1
			SPA167	F1	SAA118	SAC070	H2	GA2045	J2
						SAD033	H3		
						SAG157	H1		
								BAE680AF	
								BAE680AF	
						SAC070	H2		
						SAG157	H1		
								BAE680AF	
					SAA118			ESS0066A	J1
						SAG157	H1		
								SUA528	J2
	APS50		SPA103	F1		SAC054	H2	ESS0066A	J1
						SAG058	H1		
								SUA528	J2
	APS50		SPA103	F1		SAG089	H1	ESS0066A	J1
								SUA528	J2
	APS50		SPA103	F1		SAG089	H1	ESS0066A	J1
								SUA528	J2
	APS50					SAG089	H1		
								SUA534	J2
					SAA113			GA2101	J2
								SUA587	J3
								SUA588	J3
								SUA589	J3
						SAF001	H4		
	APS36					SAF001	H4	GA2202	J2



KW



TYPE



TYPE

FIAT

DUCATO Furgonato (250)

120 Multijet 2,3 D	Diesel	88	07/06 →	ENGINE: F1AE0481D				KBLCF01	B2
120 Multijet 2,3 D	Diesel	88	07/06 →					54DTS3I	B3
120 Multijet 2,3 D	Diesel	88	07/06 →						
120 Multijet 2,3 D	Diesel	88	07/06 →						
120 Multijet 2,3 D	Diesel	88	03/10 →						
120 Multijet 2,3 D	Diesel	88	07/06 →						
120 Multijet 2,3 D	Diesel	88	07/06 →						
130 Multijet 2,3 D	Diesel	96	01/07 →	ENGINE: F1AE3481D, F1AE0481N				KBLCF01	B2
130 Multijet 2,3 D	Diesel	96	01/07 →					54DTS3I	B3
140 Natural Power	Petrol/CNG	100	04/09 →						
150 Multijet 2,3 D	Diesel	109	06/11 →	ENGINE: F1AE3481E				54DTE3I	B3
150 Multijet 2,3 D	Diesel	109	06/11 →						
160 Multijet 3,0 D	Diesel	116	07/06 →						
160 Multijet 3,0 D	Diesel	116	07/06 →						
160 Multijet 3,0 D	Diesel	116	07/06 →						
160 Multijet 3,0 D	Diesel	116	07/06 →						
3.0 D Multijet	Diesel	130	06/11 →						

DUCATO Furgonato (290)

2.5 D 4x4	Diesel	55	07/90 → 03/94						
2.5 TD	Diesel	70	07/90 → 03/94						

DUCATO Panorama (280)

1.9 D	Diesel	52	02/87 → 08/90						
-------	--------	----	---------------	--	--	--	--	--	--

DUCATO Pianale piatto/Telaio (230)

1.9 D	Diesel	50	04/98 → 04/02						
1.9 D	Diesel	51	03/94 → 04/02						
1.9 TD	Diesel	60	03/94 → 04/02						
1.9 TD	Diesel	66	04/98 → 04/02						
1.9 TD CAT	Diesel	59	08/94 → 04/02						
2.0	Petrol	80	06/98 → 04/02					B04	B1
2.0	Petrol	80	06/98 → 04/02	ENGINE: XU10J2U					
2.0	Petrol	80	06/98 → 04/02	ENGINE: XU10J2U					
2.0	Petrol	80	06/98 → 04/02						
2.0	Petrol	80	06/98 → 03/02						
2.5 D	Diesel	62	03/94 → 04/02						
2.5 D 4x4	Diesel	62	03/94 → 04/02						
2.5 TDI	Diesel	80	03/94 → 04/02						
2.5 TDI	Diesel	85	03/94 → 04/02						
2.5 TDI	Diesel	80	03/94 → 03/98						
2.5 TDI	Diesel	85	03/94 → 03/98						
2.8 D	Diesel	64	02/98 → 04/02						
2.8 iDTD 4x4	Diesel	90	05/98 → 09/01						
2.8 JTD	Diesel	94	11/00 → 04/02						
2.8 JTD	Diesel	94	11/00 → 03/02						

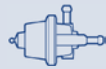

TYPE



TYPE



TYPE

								SAC054	H2	ESS0066A	J1		
								SAG110	H1	GA2150	J2		
										SUA587	J3		
										GA2202	J2		
										SUA588	J3		
										SUA589	J3		
										GA2131	J2		
								SAF001	H4	GA2202	J2		
								SAG110	H1	GA2150	J2		
										SUA587	J3		
										SUA588	J3		
										SUA589	J3		
								SAF001	H4	GA2202	J2		
								SPA101	F1				
								SPA101	F1				
								SPA101	F1				
								SAA118					
								SAA101					
								SAA101					
								SAA118	SAG150	H1			
								SAA101					
								SAA118	SAC070	H2	ESS534	J1	
	PRT03/04	KITRPM36	SZA101	F1									
		RPM36											
								SAG150	H1				
										BAE680AF			
								SAA101					
								SAA101					
								SAA101					
								SAA101					
								SAG071	H1				
								SAG071	H1				
								CWM02/2	H1				
										ESS0066A	J1		
								SPA103	F1	SAG089	H1	ESS0066A	J1
												SUA528	J2



KW



TYPE



TYPE

FIAT

DUCATO Pianale piatto/Telaio (230)

2.8 TDI	Diesel	90	12/98 → 04/02					
---------	--------	----	---------------	--	--	--	--	--

DUCATO Pianale piatto/Telaio (244)

2.0 JTD	Diesel	62	04/02 → 07/06					
2.0 JTD	Diesel	62	04/02 → 07/06					
2.3 JTD	Diesel	81	04/02 → 07/06					
2.3 JTD	Diesel	81	04/02 → 07/06					
2.8 JTD	Diesel	94	04/02 → 07/06					
2.8 JTD	Diesel	94	04/02 → 07/06					
2.8 JTD 4x4	Diesel	94	10/02 → 07/06					
2.8 JTD 4x4	Diesel	94	10/02 → 07/06					
2.8 JTD Power	Diesel	107	05/04 → 07/06					

DUCATO Pianale piatto/Telaio (250)

100 Multijet 2,2 D	Diesel	74	07/06 →			AMM19656	B4	
100 Multijet 2,2 D	Diesel	74	07/06 →					
100 Multijet 2,2 D	Diesel	74	07/06 →					
100 Multijet 2,2 D	Diesel	74	07/06 →					
110 Multijet 2,3 D	Diesel	83	10/11 →	ENGINE: F1AE3481G		54DTE3I	B3	
110 Multijet 2,3 D	Diesel	83	10/11 →					
115 Multijet 2,0 D	Diesel	85	06/11 →					
120 Multijet 2,3 D	Diesel	88	07/06 →	ENGINE: F1AE0481D		KBLCF01	B2	
120 Multijet 2,3 D	Diesel	88	07/06 →			54DTS3I	B3	
120 Multijet 2,3 D	Diesel	88	07/06 →					
120 Multijet 2,3 D	Diesel	88	07/06 →					
120 Multijet 2,3 D	Diesel	88	03/10 →					
120 Multijet 2,3 D	Diesel	88	07/06 →					
120 Multijet 2,3 D	Diesel	88	07/06 →					
130 Multijet 2,3 D	Diesel	96	01/07 →	ENGINE: F1AE3481D, F1AE0481N		KBLCF01	B2	
130 Multijet 2,3 D	Diesel	96	01/07 →			54DTS3I	B3	
130 Multijet 2,3 D	Diesel	96	01/07 →					
130 Multijet 2,3 D	Diesel	96	01/07 →					
140 Natural Power	Petrol/CNG	100	04/09 →	ENGINE: F1CE0441A		57SMI1	B3	
150 Multijet 2,3 D	Diesel	109	06/11 →	ENGINE: F1AE3481E		54DTE3I	B3	
150 Multijet 2,3 D	Diesel	109	06/11 →					
160 Multijet 3,0 D	Diesel	116	07/06 →					
160 Multijet 3,0 D	Diesel	116	07/06 →					
160 Multijet 3,0 D	Diesel	116	07/06 →					
160 Multijet 3,0 D	Diesel	116	07/06 →					
3.0 D Multijet	Diesel	130	06/11 →					

DUCATO Pianale piatto/Telaio (280)

1.9 D	Diesel	52	01/88 → 08/90					
-------	--------	----	---------------	--	--	--	--	--

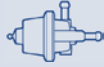

TYPE



TYPE



TYPE

					SAG071	H1	ESS0066A	J1
				SAA118	SAG157	H1	ESS0066A	J1
							SUA528	J2
	APS50	SPA103	F1		SAC054	H2	ESS0066A	J1
					SAG058	H1	SUA528	J2
	APS50	SPA103	F1		SAG089	H1	ESS0066A	J1
							SUA528	J2
	APS50	SPA103	F1		SAG089	H1	ESS0066A	J1
							SUA528	J2
	APS50				SAG089	H1	SUA534	J2
				SAA113			GA2127	J2
							SUA587	J3
							SUA588	J3
							SUA589	J3
					SAF001	H4		
	APS36				SAF001	H4	GA2202	J2
					SAC054	H2	ESS0066A	J1
					SAG110	H1	GA2202	J2
							SUA587	J3
							GA2202	J2
							SUA588	J3
							SUA589	J3
					SAC054	H2	GA2202	J2
					SAF001	H4		
	IPM019				SAG110	H1		
					SAF001	H4	GA2202	J2
					SAG110	H1	GA2202	J2
							SUA587	J3
							SUA588	J3
							SUA589	J3
					SAF001	H4	GA2202	J2
		SPA101	F1					



KW

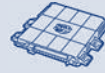

TYPE



TYPE

FIAT

DUNA (146 B)

1.7 DS	Diesel	44	01/87 → 12/91					
60 1.1	Petrol	43	01/87 → 12/91					
60 1.1	Petrol	43	01/89 → 12/91					
70 1.3	Petrol	49	01/87 → 12/91					
70 1.3	Petrol	49	01/89 → 12/91					

DUNA Weekend (146 B)

1.7 DS	Diesel	44	01/87 → 12/91					
60 1.1	Petrol	43	01/87 → 12/91					
60 1.1	Petrol	43	01/89 → 12/91					
70 1.3	Petrol	49	01/87 → 12/91					
70 1.3	Petrol	49	01/89 → 12/91					

FIORINO (127)

1050	Petrol	37	01/80 → 12/87					
------	--------	----	---------------	--	--	--	--	--

FIORINO (147)

1.3 D	Diesel	33	03/82 → 12/87					
1.5	Petrol	55	01/88 → 08/93					

FIORINO Cassone / Furgonato / Promiscuo (225)

1.3 D Multijet	Diesel	55	11/07 →					
1.3 D Multijet	Diesel	70	07/09 →					
1.4	Petrol	54	11/07 →					

FIORINO Furgonato (146)

75 i.e. 1.6	Petrol	55	10/93 → 05/01					
75 i.e. 1.6	Petrol	55	06/95 → 05/01					

FIORINO Pick up (146)

1.4	Petrol	49	05/94 → 05/01					
1.4	Petrol	49	06/95 → 05/01					
1.6	Petrol	55	01/94 → 05/01					
1.6	Petrol	55	06/95 → 05/01					
1.7 TD	Diesel	46	01/97 → 05/01					

FREEMONT (JF_, JC)

2.0 JTD	Diesel	100	08/11 →					
2.0 JTD	Diesel	103	08/11 →					
2.0 JTD	Diesel	120	08/11 →					
2.0 JTD	Diesel	125	08/11 →					
2.0 JTD 4x4	Diesel	120	08/11 →					
2.0 JTD 4x4	Diesel	125	08/11 →					

IDEA

1.2 16V	Petrol	59	01/04 →				TB0011	B3
1.2 16V	Petrol	59	01/04 →					
1.3 D Multijet	Diesel	66	10/05 →	ENGINE: → 1866163	MJD6F3M3	A1		
1.3 D Multijet	Diesel	66	10/05 →	ENGINE: → 1866163	MJD6JFM5	A1		
1.3 D Multijet	Diesel	66	05/09 →		MJD6F3M3/3	A1		
1.3 D Multijet	Diesel	66	07/08 →		MJD6F3M5	A1		
1.3 D Multijet	Diesel	66	10/05 →					

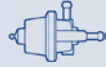

TYPE



TYPE



TYPE

				SPA101	F1								
				SPA101	F1								
												BAE506F	
				SPA101	F1								
												BAE506F	
				SPA101	F1								
				SPA101	F1								
												BAE506F	
				SPA101	F1								
												BAE506F	
													BK2A
				SPA101	F1								
				SPA101	F1								
	APS36							SAF001	H4			GA2174	J2
	APS36			SPA146	F1			SAF001	H4				
	APS77			SPA107	F1	SAA118		SAG164	H1				
				SPA101	F1			SEN8M	H1	BAE504D			
								SAG048	H1	BAE680AG	ESS514		J1
				SPA104	F1								
								SAG048	H1	BAE680AG	ESS514		J1
				SPA104	F1								
								SAG048	H1	BAE680AG	ESS514		J1
				SPA101	F1								
	APS36												
	APS36												
	APS36												
	APS36												
	APS36												
	APS36												
	KITLDF6T							SAD026	H3			ESS0028A	J1
												GA2208	J2
	APS25			ATS20	F2			SAC093	H2			GA2098	J2



KW



TYPE



TYPE

FIAT

IDEA

1.3 D Multijet	Diesel	66	10/05 →						
1.3 D Multijet	Diesel	66	10/05 →						
1.3 D Multijet	Diesel	70	05/08 →						
1.3 JTD	Diesel	51	01/04 →						
1.3 JTD	Diesel	51	01/04 →						
1.4	Petrol	57	10/05 →				44SMF9/1	B3	
1.4 16V	Petrol	70	01/04 →				TB0009	B3	
1.4 16V	Petrol	70	01/04 →						
1.4 16V	Petrol	70	03/04 →						
1.4 16V	Petrol	70	01/04 →	ENGINE: 843A1000					
1.4 LPG	Petrol/LPG	57	03/09 →	ENGINE: 350A1000			44SMF9/1	B3	
1.6 D Multijet	Diesel	88	05/08 →						
1.9 JTD	Diesel	74	01/04 →						

LINEA (323)

1.3 D Multijet	Diesel	66	06/07 →						
1.3 D Multijet	Diesel	66	06/07 →						
1.3 D Multijet	Diesel	66	06/07 →						
1.4	Petrol	57	06/07 →		IAW5SF.MD	A1	44SMF9/1	B3	
1.4	Petrol	57	06/07 →				KIT EC2/1	B2	
1.4 T-Jet	Petrol	88	09/07 →						
1.4 T-Jet	Petrol	88	09/07 →						
1.6 D Multijet	Diesel	77	06/09 →				48CPD6G	B3	
1.6 D Multijet	Diesel	77	06/09 →						

MAREA (185)

1.2 16V	Petrol	60	03/99 → 05/02						
1.2 16V	Petrol	60	10/98 → 05/02						
1.2 16V	Petrol	60	02/99 → 05/02						
1.6 100 16V Bipower	Petrol/CNG	76	04/99 → 05/02						
1.6 100 16V Bipower	Petrol/CNG	76	04/99 → 05/02	ENGINE: 182A4000					
1.6 100 16V Bipower	Petrol/CNG	76	10/00 → 05/02						
1.6 100 16V	Petrol	76	01/01 → 05/02		IAW4EF.B3	A1			
1.9 JTD 105	Diesel	77	04/99 → 01/01				TB0018	B3	
1.9 JTD 105	Diesel	77	04/99 → 01/01						
1.9 JTD 110	Diesel	81	01/01 → 05/02				TB0018	B3	
1.9 JTD 110	Diesel	81	01/01 → 07/01						
1.9 JTD 110	Diesel	81	08/01 → 05/02	ENGINE: 2705195 →					
1.9 JTD 110	Diesel	81	01/01 → 05/02						
2.0 150 20V	Petrol	110	01/01 → 05/02						
2.0 150 20V	Petrol	110	01/01 → 05/02						
2.0 150 20V	Petrol	110	01/01 → 05/02						
2.0 155 20V	Petrol	113	04/99 → 01/01						
2.0 155 20V	Petrol	113	04/99 → 01/01						
2.0 155 20V	Petrol	113	04/99 → 01/01						
2.4 JTD 130	Diesel	96	04/99 → 05/02						



TYPE

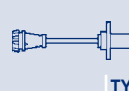

TYPE



TYPE

						SAF001	H4			
						SAG025	H1			
						SAF001	H4			
		APS23				SAC093	H2		SUA524	J2
						SAG025	H1			
	IWP160		SPA156	F1		SAC095	H2	BAE940A	ESS0028A	J1
		KITLDF6T				SAC079	H2		ESS0028A	J1
						SAD026	H3		GA2208	J2
			SPA156	F1						
								BAE403C		
		APS36				SAF001	H4			
		APS36	ATS20	F2		SAC088	H2		SUA524	J2
		APS36				SAC093	H2			
						SAF001	H4			
						SAG025	H1			
	IWP160	KITLDF6T	SPA156	F1		CVM03/1	H1	BAE940A		
						SAC095	H2			
			SPA156	F1		SAC095	H2	BAE680BQ		
						SAD026	H3			
		APS36				SAF001	H4			
						SAG080	H1			
		APS59						BAE680AG		
						SAD013	H3			
									SUA537	J2
			SPA101	F1		CWM02/1	H1		ESS0095A	J1
								BAE920AX		
									GA2020	J2
		APS31	SPA103	F1		SAC088	H2		ESS0066A	J1
									SUA521	J2
						SAC088	H2		ESS0066A	J1
		APS31								
		APS23							SUA527	J2
						SAC024	H2	BAE680AM	SUA541	J2
						SAD003	H3			
						SAG122	H1			
			SPA104	F1		SAC024	H2	BAE680AM		
						SAD003	H3			
						SAG122	H1			
		APS31	SPA103	F1		SAC088	H2		ESS0066A	J1



KW



TYPE



TYPE

FIAT

MAREA (185)

2.4 JTD 130 Diesel 96 04/99 → 05/02

MAREA Weekend (185)

1.2 16V Petrol 60 03/99 → 05/02

1.2 16V Petrol 60 10/98 → 05/02

1.2 16V Petrol 60 02/99 → 05/02

1.6 100 16V Petrol 76 01/01 → 05/02

IAW4EF.B3 A1

1.9 JTD 105 Diesel 77 04/99 → 05/02

TB0018 B3

1.9 JTD 105 Diesel 77 04/99 → 05/02

1.9 JTD 110 Diesel 81 01/01 → 05/02

TB0018 B3

1.9 JTD 110 Diesel 81 01/01 → 07/01

1.9 JTD 110 Diesel 81 08/01 → 05/02

ENGINE: 2705195 →

1.9 JTD 110 Diesel 81 01/01 → 05/02

2.0 150 20V Petrol 110 01/01 → 05/02

2.0 150 20V Petrol 110 01/01 → 05/02

2.0 150 20V Petrol 110 01/01 → 05/02

2.0 155 20V Petrol 113 04/99 → 02/03

2.0 155 20V Petrol 113 04/99 → 02/03

2.0 155 20V Petrol 113 04/99 → 02/03

2.4 JTD 130 Diesel 96 04/99 → 05/02

MULTIPLA (186)

1.6 100 16V (186AXA1A) Petrol 76 04/99 → 12/00

ENGINE: 182A4000-

IAW49F.B2 A1

1.6 100 16V (186AXA1A) Petrol 76 04/99 → 06/10

ENGINE: 182A4000-

46SXF8 B3

1.6 100 16V (186AXA1A) Petrol 76 04/99 → 06/10

1.6 100 16V (186AXA1A) Petrol 76 01/01 → 06/10

1.6 100 16V (186AXA1A) Petrol 76 04/99 → 06/10

ENGINE: 182A4000

1.6 100 16V (186AXA1A) Petrol 76 04/99 → 12/00

1.6 16V Bipower (186AMB1A) Petrol/CNG 76 04/99 → 06/10

1.6 16V Bipower (186AMB1A) Petrol/CNG 76 04/99 → 06/10

ENGINE: 182A4000

1.6 16V Bipower (186AXC1A) Petrol/CNG 76 01/06 → 06/10

IAW4EF.G4/1 A1

1.6 16V Bipower (186AXC1A) Petrol/CNG 76 10/01 → 06/10

1.6 16V Bipower (186AXC1A) Petrol/CNG 76 10/01 → 06/10

ENGINE: 182A4000

1.6 16V Blupower (186AMA1A) Bifuel 70 04/99 → 06/10

1.6 16V Blupower (186AMA1A) Bifuel 70 04/99 → 06/10

ENGINE: 182A4000

1.9 JTD (186AXE1A) Diesel 88 04/02 → 06/10

48CPD8 B3

1.9 JTD (186AXE1A) Diesel 88 04/02 → 06/10

PAS003 B5

1.9 JTD 105 (186AXB1A) Diesel 77 04/99 → 06/10

PAS003 B5

1.9 JTD 105 (186AXB1A) Diesel 77 04/99 → 12/00

1.9 JTD 105 (186AXB1A) Diesel 77 04/99 → 12/00

1.9 JTD 110 Diesel 81 03/01 → 07/02

PAS003 B5

1.9 JTD 110 Diesel 81 03/01 → 07/01

1.9 JTD 110 Diesel 81 08/01 → 03/02

ENGINE: 2705195 →

1.9 JTD 110 Diesel 81 03/01 → 03/02

1.9 JTD 115 Diesel 85 07/02 → 06/10

48CPD8 B3

1.9 JTD 115 Diesel 85 07/02 → 06/10

PAS003 B5



TYPE

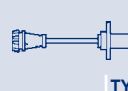

TYPE



TYPE

								SUA521	J2
	APS59							BAE680AG	
					SAD013	H3			
								SUA537	J2
	APS31	SPA103	F1		SAC088	H2		ESS0066A	J1
								SUA521	J2
					SAC088	H2		ESS0066A	J1
	APS31								
	APS23								
								SUA527	J2
					SAC024	H2	BAE680AM	SUA541	J2
					SAD003	H3			
					SAG122	H1			
		SPA104	F1		SAC024	H2	BAE680AM		
					SAD003	H3			
					SAG122	H1			
	APS31	SPA103	F1		SAC088	H2		SUA521	J2
IWP164	KITTPRT05/2				CWM02/1	H1			
		SZA105	F1					BAE920AX	
								GA2014	J2
IWP164	KITTPRT05/2				CWM02/1	H1		GA2084	J2
								BAE920AX	
IWP164					CWM02/1	H1		BAE920AX	
IWP164	KITTPRT05/2				CWM02/1	H1		GA2084	J2
								BAE920AX	
	APS36	ATS20	F2		SAC088	H2		GA2108	J2
					SAC088	H2			
	APS23	SPA103	F1						
								SUA523	J2
					SAC088	H2			
	APS31								
	APS23								
								SUA523	J2
	APS23				SAC088	H2		SUA523	J2



KW



TYPE



TYPE

FIAT

PALIO (178BX)

1.0	Petrol	45	04/96 →						
1.0	Petrol	56	04/96 →						
1.2	Petrol	54	06/98 → 12/00				KITPF2C	B6	
1.2	Petrol	54	06/98 → 12/01				B18	B1	
1.2	Petrol	54	01/01 →				KIT EC2/1	B2	
1.2	Petrol	54	02/01 →				36SXF5/1	B3	
1.2	Petrol	54	01/01 →						
1.2	Petrol	54	01/01 → 12/04						
1.2	Petrol	54	06/98 →						
1.2	Petrol	54	06/98 →						
1.2	Petrol	54	06/98 →						
1.2	Petrol	54	06/98 → 12/02						
1.2	Petrol	59	10/01 →						
1.4	Petrol	51	04/96 →				44SMF9/1	B3	
1.4	Petrol	70	06/03 →				44SMF9/1	B3	
1.4	Petrol	51	03/00 → 09/01						
1.4 Cat.	Petrol	51	04/96 →						
1.4 Cat.	Petrol	51	03/98 → 09/01						
1.6 16V	Petrol	74	04/96 →				KITEC1/02	B2	
1.6 16V	Petrol	74	04/96 → 12/98				B02	B1	
1.6 16V	Petrol	74	04/96 → 12/98				KITPF1C	B6	
1.6 16V	Petrol	74	01/99 →				46SXF8	B3	
1.6 16V	Petrol	74	01/02 →				46SXF7	B3	
1.6 16V	Petrol	74	01/99 → 12/00						
1.6 16V	Petrol	74	01/01 →						
1.6 16V	Petrol	74	04/96 →	ENGINE: 178B3000					

PALIO Weekend (178DX)

1.0	Petrol	45	07/98 → 10/03						
1.2 (178DX.G1A)	Petrol	54	04/96 → 02/01				KITPF2C	B6	
1.2 (178DX.G1A)	Petrol	54	01/97 → 02/01				B18	B1	
1.2 (178DX.G1A)	Petrol	54	04/96 → 02/01						
1.2 (178DX.G1A)	Petrol	54	04/96 → 02/01						
1.2 (178DYA1A)	Petrol	44	02/01 →				36SXF5/1	B3	
1.2 (178DYA1A)	Petrol	44	02/01 →				KIT EC2/1	B2	
1.2 (178DYA1A)	Petrol	44	02/01 → 12/01				B18	B1	
1.2 (178DYA1A)	Petrol	44	02/01 → 12/02						
1.6 16V (178DX.D1A)	Petrol	74	04/96 → 02/01				KITEC1/02	B2	
1.6 16V (178DX.D1A)	Petrol	74	04/96 → 12/98				B02	B1	
1.6 16V (178DX.D1A)	Petrol	74	04/96 → 12/98				KITPF1C	B6	
1.6 16V (178DX.D1A)	Petrol	74	01/99 → 02/01				46SXF8	B3	
1.6 16V (178DX.D1A)	Petrol	74	04/96 → 02/01						
1.6 16V (178DX.D1A)	Petrol	74	04/96 → 02/01						
1.6 16V (178DX.D1A)	Petrol	74	04/96 → 02/01	ENGINE: 178B3000					
1.6 16V (178DYC1A06)	Petrol	76	02/01 →				46SXF8	B3	



TYPE

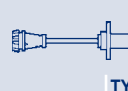

TYPE



TYPE

KIT IWP065									ESS0040A	J1
KIT IWP065										
			SZA105	F1						
IWP116/1										
	KITTPRT05/2									
			KITATS05	F2		CWM02/3	H1			
			SPA101	F1						
			SZA106	F1						
						CWM02/8	H1			
								BAE680AG		
			SPA101	F1		CVM03/1	H1	BAE940A		
						SAG067	H1			
			SPA101	F1		CVM03/1	H1			
						SAG067	H1			
IWP164			SPA101	F1		CWM02/1	H1		ESS0040A	J1
	KITTPRT05/2									
			SZA105	F1						
								BAE920AX		
KIT IWP065										
	PRT03/04	KITRPM36	KITATS05	F2		CWM02/3	H1	BAE800B	ESS0040A	J1
		RPM36	SPA101	F1						
			SZA106	F1						
IWP116/1	KITTPRT05/2		KITATS05	F2		CWM02/3	H1			
			SZA105	F1						
						CWM02/8	H1			
IWP001/1	PRT03/04	RPM67	ATS04-1	F2		CWM02/1	H1		ESS0040A	J1
	KITTPRT05/2									
			SPA101	F1						
			SZA104	F1						
								BAE920AX		
IWP164			SZA105	F1		CWM02/1	H1		ESS0040A	J1



KW

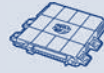

TYPE



TYPE

FIAT

PALIO Weekend (178DX)

1.6 16V (178DYC1A06)	Petrol	76	02/01 →				KITEC1/02	B2
1.6 16V (178DYC1A06)	Petrol	76	01/02 →				46SXF7	B3
1.6 16V (178DYC1A06)	Petrol	76	02/01 → 12/04					
1.6 16V (178DYC1A06)	Petrol	76	02/01 →	ENGINE: 182B6000				
1.6 16V (178DYC1A06)	Petrol	76	02/01 →	ENGINE: 178B3000				
1.7 TD (178DX.H1A)	Diesel	51	04/96 → 03/01					
1.9 JTD	Diesel	59	09/01 →					

PANDA (141A_)

650	Petrol	22	01/82 → 07/04					
650	Petrol	22	01/82 → 07/04					
800	Petrol	25	02/81 → 12/85					
900	Petrol	29	04/92 → 12/96				B01	B1
900	Petrol	29	04/92 → 12/96				KITEC1/02	B2
900	Petrol	29	04/92 → 12/96				KITPF2C	B6
900	Petrol	33	04/92 → 06/94				KITPF2C	B6
900	Petrol	29	04/92 → 12/96					
900	Petrol	33	10/80 → 06/94					
950	Petrol	35	09/82 → 08/83					
1000	Petrol	32	01/86 → 12/91					
1000	Petrol	37	01/85 → 12/91					
1000	Petrol	32	01/86 → 04/92					
1000	Petrol	37	01/85 → 12/92					
1000	Petrol	37	01/86 → 12/92					
1100	Petrol	40	09/02 → 09/03		IAW4AF.PP	A1		
1100	Petrol	37	05/91 → 12/99				B12	B1
1100	Petrol	37	05/91 → 12/97				KITEC1/02	B2
1100	Petrol	37	04/92 → 12/99				KITPF2C	B6
1100	Petrol	40	02/95 → 12/00				B12	B1
1100	Petrol	40	02/95 → 12/00				KITPF2C	B6
1100	Petrol	40	01/01 → 09/03				KIT EC2/1	B2
1100	Petrol	37	05/91 → 12/99					
1100	Petrol	40	02/95 → 08/00					
1100	Petrol	37	05/91 → 12/99					
1100	Petrol	37	05/91 → 12/99					
1100	Petrol	40	02/95 → 09/03					
1100	Petrol	40	02/95 → 08/00					
1100	Petrol	40	01/01 → 01/02					
1100	Petrol	40	12/00 → 09/03					
1100	Petrol	37	05/91 → 12/92					
1000 4x4	Petrol	33	05/86 → 12/94	ENGINE: 141C2000				
1000 4x4	Petrol	37	01/91 → 12/92					
1000 4x4	Petrol	32	01/86 → 07/89					
1000 4x4	Petrol	33	10/87 → 05/91					
1000 4x4	Petrol	37	01/86 → 12/92					

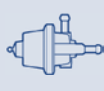

TYPE

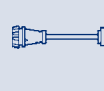

TYPE



TYPE

KITTPRT05/2

BAE403B

BAE920AX

SEN8U

H1

SAC088

H2

SAA107

BZ600A

SAA107

SAA107

PRT03/04

KITATS05

F2

SEN8D3

H1

BAE800B

ESS273/1

J1

SPA101

F1

SZA103

F1

WTS05-1

F1

KITATS05

F2

SAA107

BK2A

SPA101

F1

SAA107

SPA104

F1

SPA104

F1

BK2A

BK2A

BAE506D

PRT03/04

SPA101

F1

BAE800B

ESS273/1

J1

IWP116/1

KITTPRT05/2

SZA105

F1

CWM02/5

H1

GA2023

J2

SPA104

F1

PRT03/04

SZA103

F1

BAE800B

SZA103

F1

WTS05-1

F1

SPA101

F1

ESS273/1

J1

WTS05-1

F1

816001633701

F1

SAC094

H2

ESS514

J1

SPA104

F1

BK2A

BK2A

BAE506F



KW



TYPE



TYPE

FIAT

PANDA (141A_)

1000 4x4	Petrol	33	05/86 → 12/94						
1000 i.e. Cat.	Petrol	33	10/87 → 08/98				B12	B1	
1000 i.e. Cat.	Petrol	33	10/87 → 12/97				KITEC1/02	B2	
1000 i.e. Cat.	Petrol	33	04/92 → 08/98				KITPF2C	B6	
1000 i.e. Cat.	Petrol	33	10/87 → 08/98						
1000 i.e. Cat.	Petrol	33	10/87 → 08/98						
1000 i.e. Cat.	Petrol	33	10/87 → 08/98						
1000 i.e. Cat.	Petrol	33	10/87 → 12/91						
1100 4x4	Petrol	40	02/95 → 12/00				B12	B1	
1100 4x4	Petrol	40	02/95 → 12/00				KITPF2C	B6	
1100 4x4	Petrol	40	01/01 → 07/04						
1100 4x4	Petrol	40	02/95 → 07/04						
1100 4x4	Petrol	40	01/01 → 09/03						
1100 4x4	Petrol	40	02/95 → 07/04						
1100 4x4	Petrol	40	02/95 → 07/04	ENGINE: 176B2000					
1100 Trekking 4x4	Petrol	37	10/91 → 07/04				KITEC1/02	B2	
1100 Trekking 4x4	Petrol	37	10/91 → 12/00				B12	B1	
1100 Trekking 4x4	Petrol	37	01/01 → 09/03				KIT EC2/1	B2	
1100 Trekking 4x4	Petrol	37	04/92 → 12/00				KITPF2C	B6	
1100 Trekking 4x4	Petrol	37	01/01 → 07/04						
1100 Trekking 4x4	Petrol	37	10/91 → 07/04						
1100 Trekking 4x4	Petrol	37	10/91 → 12/95						
1100 Trekking 4x4	Petrol	37	01/01 → 09/03						
1100 Trekking 4x4	Petrol	37	10/91 → 12/92						
750 (141AA)	Petrol	25	01/86 → 01/95						
750 (141AI)	Petrol	25	01/86 → 01/95						
750 (141AM) Cat.	Petrol	25	01/95 → 10/03						
950 4x4	Petrol	35	09/83 → 12/86						
950 4x4	Petrol	35	09/83 → 12/85						

PANDA (169)

1.1	Petrol	40	09/03 → 01/04		IAW5AF.SM/1	A1			
1.1	Petrol	40	09/03 → 01/04	CHASSIS: → 191792	IAW5AF.S1/1	A1			
1.1	Petrol	40	01/05 →		IAW4AF.S3/2	A1			
1.1	Petrol	40	10/06 →		IAW4AF.SS/2	A1			
1.1	Petrol	40	09/03 →				KIT EC2/1	B2	
1.1	Petrol	40	10/03 →						
1.2	Petrol	44	09/03 →	ENGINE: 188A4000	IAW5SF8.M4/1	A1			
1.2	Petrol	44	09/03 → 01/04		IAW5AF.S2	A1			
1.2	Petrol	44	09/03 → 01/04		IAW5AF.SP	A1			
1.2	Petrol	44	01/04 →		IAW5NF.S5/1	A1			
1.2	Petrol	44	01/07 →		IAW5AF.SK	A1			
1.2	Petrol	44	02/04 →		IAW4AF.S2/3	A1			
1.2	Petrol	44	09/03 →				36SMF6	B3	
1.2	Petrol	44	09/03 →				KIT EC2/1	B2	

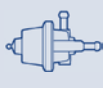

TYPE

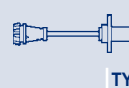

TYPE



TYPE

									ESS514	J1
	PRT03/04		KITATS05	F2				BAE800B	ESS273/1	J1
			SPA101	F1						
			SZA103	F1						
			WTS05-1	F1						
			SPA104	F1						
	IWP116/1									
	PRT03/04		SZA103	F1				BAE800B	ESS273/1	J1
	KITTPRT05/2		SZA105	F1		CWM02/5	H1			
			WTS05-1	F1						
									GA2021	J2
	PRT03/04		SZA103	F1				BAE800B	ESS273/1	J1
	IWP116/1									
			WTS05-1	F1						
			SPA104	F1						
			SZA105	F1						
									ESS514	J1
			SPA101	F1				BK2A		
			SPA101	F1	SAA107					
			SPA101	F1						
			SPA101	F1	SAA107					
									BK2A	
	KITLDF6T					CVM03/1	H1		GA2229	J2
						SAC095	H2			
	KITLDF6T					CVM03/1	H1	BAE800B	GA2229	J2



KW

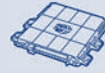

TYPE



TYPE

FIAT

PANDA (169)

1.2	Petrol	51	03/10 →	ENGINE: 169A4000			40SMF10/1	B3
1.2	Petrol	51	03/10 →					
1.2 4x4	Petrol	44	10/04 →		IAW5NF.S8/2	A1	KIT EC2/1	B2
1.2 4x4	Petrol	44	03/06 → 05/09				36SMF6	B3
1.2 4x4	Petrol	51	11/09 →	ENGINE: 169A4000			40SMF10/1	B3
1.2 Bi-Power / Natural Power	BiFuel	44	01/07 →					
1.2 Bi-Power / Natural Power	BiFuel	44	01/07 →					
1.2 LPG	Petrol/LPG	44	04/09 →					
1.2 LPG	Petrol/LPG	51	11/10 →					
1.3 D Multijet	Diesel	51	09/03 →		MJD6JFS1	A1		
1.3 D Multijet	Diesel	51	09/03 →		MJD6JFS3	A1		
1.3 D Multijet	Diesel	55	06/06 →	ENGINE: 169A1000	MJD6F3A5	A1		
1.3 D Multijet	Diesel	51	01/04 →					
1.3 D Multijet	Diesel	55	06/06 →					
1.3 D Multijet 4x4	Diesel	51	10/04 →		MJD6JFS4	A1		
1.3 D Multijet 4x4	Diesel	51	10/04 →					
1.3 D Multijet 4x4	Diesel	55	09/10 →					
1.4	Petrol	74	10/06 →					
1.4 Bi-Power / Natural Power	BiFuel	57	09/10 →	ENGINE: 350A1000			44SMF9/1	B3

PANDA (312)

0.9	Petrol	57	02/12 →					
0.9	Petrol	63	02/12 →					
1.2	Petrol	51	02/12 →	ENGINE: 169A4000			40GTE3F	B3
1.2 LPG	Petrol/LPG	51	06/12 →	ENGINE: 169A4000			40GTE3F	B3
1.3 D Multijet	Diesel	55	02/12 →	ENGINE: 199A9000			40DFP1	B3
1.3 D Multijet	Diesel	55	02/12 →					

PANDA Van (141_)

750	Petrol	25	01/86 → 07/92					
1000	Petrol	32	01/91 → 12/91					
1000	Petrol	32	01/86 → 02/92					
1000 i.e	Petrol	33	01/01 → 09/03				KIT EC2/1	B2
1000 i.e	Petrol	33	08/92 → 02/04					

PANDA Van (169)

1.2	Petrol	44	09/04 →	ENGINE: 188A4000	IAW5SF8.M4/1	A1		
1.2	Petrol	51	09/10 →	ENGINE: 169A4000			40SMF10/1	B3
1.2	Petrol	44	09/04 →					
1.2	Petrol	51	09/10 →					
1.2 4x4	Petrol	51	09/10 →	ENGINE: 169A4000			40SMF10/1	B3
1.2 LPG	Petrol/LPG	51	09/10 →					
1.3 JTD	Diesel	51	03/04 →					
1.3 JTD	Diesel	55	01/06 →					

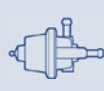

TYPE



TYPE



TYPE

SPARK PLUGS

									GA2229	J2
--	--	--	--	--	--	--	--	--	--------	----

KITLDF6T

--	--	--	--	--	--	--	--	--	--	--

SAC095 H2

SAG082 H1

SAG082 H1

GA2229 J2

GA2229 J2

SAC093 H2

SAG025 H1

APS23

SAF001 H4

APS23

SAC093 H2

SAG025 H1

SAF001 H4

SAD026 H3

BAE403C

GA2229

J2

SPARK PLUGS

APS36

APS36

APS36

SPARK PLUGS

SPA101 F1 SAA107

BK2A

SPA104 F1

BK2A

SPA101 F1

ESS273/1 J1

SPARK PLUGS

GA2229 J2

GA2229 J2

GA2229 J2

SAG025 H1

SAG025 H1



KW



TYPE



TYPE

FIAT

PUNTO (176)

1.2 16V	Petrol	63	04/97 → 09/99				40SXF1	B3
1.2 16V	Petrol	63	04/97 → 09/99				KITEC1/02	B2
1.2 16V	Petrol	63	04/97 → 04/99				KITPF2C	B6
1.2 16V	Petrol	63	04/97 → 09/99					
1.4 GT Turbo	Petrol	98	01/94 → 09/96				SVF015	B6
1.4 GT Turbo	Petrol	98	01/94 → 09/96					
1.6	Petrol	65	01/94 → 04/97					
1.6	Petrol	65	01/94 → 04/97					
1.7 D	Diesel	42	04/94 → 09/97					
1.7 TD	Diesel	51	01/94 → 09/99					
1.7 TD	Diesel	52	01/94 → 09/99					
55 1.1	Petrol	40	09/93 → 09/99				B12	B1
55 1.1	Petrol	40	09/93 → 09/99				KITPF2C	B6
55 1.1	Petrol	40	09/93 → 12/97				KITEC1/02	B2
55 1.1	Petrol	40	09/93 → 09/99					
55 1.1	Petrol	40	09/93 → 09/99					
60 1.2	Petrol	43	01/94 → 09/99				B12	B1
60 1.2	Petrol	43	01/94 → 09/99				KITPF2C	B6
60 1.2	Petrol	44	03/94 → 09/99				B12	B1
60 1.2	Petrol	44	03/94 → 09/99				KITPF2C	B6
60 1.2	Petrol	44	03/94 → 12/97				KITEC1/02	B2
60 1.2	Petrol	44	03/94 → 09/99					
60 1.2	Petrol	44	03/94 → 09/99					
75 1.2	Petrol	54	01/94 → 12/97				KITEC1/02	B2
75 1.2	Petrol	54	12/93 → 09/99				KITPF2C	B6
75 1.2	Petrol	54	12/93 → 05/98				B18	B1
75 1.2	Petrol	54	02/98 → 09/98					
75 1.2	Petrol	54	01/94 → 09/99					
75 1.2	Petrol	54	01/94 → 12/97					
75 1.2	Petrol	54	12/93 → 09/99					
75 1.2	Petrol	54	10/93 → 09/99					

PUNTO (188)

1.2 16V 80 (188.233, .235, .253, .255, .333, .353, .639...)	Petrol	59	09/99 →				TB0011	B3
1.2 16V 80 (188.233, .235, .253, .255, .333, .353, .639...)	Petrol	59	09/99 →					
1.2 16V 80 (188.233, .235, .253, .255, .333, .353, .639...)	Petrol	59	09/99 →	ENGINE: 2192182 →				
1.2 16V 80 (188.233, .235, .253, .255, .333, .353, .639...)	Petrol	59	09/99 → 06/03					
1.2 16V 80 (188.233, .235, .253, .255, .333, .353, .639...)	Petrol	59	12/01 →					
1.2 16V 80 (188.233, .235, .253, .255, .333, .353, .639...)	Petrol	59	09/99 → 12/10					



TYPE



TYPE



TYPE

IWP045	KITTPRT05/2	KITRPM40	SPA101	F1				BAE800B	ESS0095A	J1
		RPM40	SZA103	F1					SUA133	J2
			WTS05-1	F1						
			ATS08	F2		SAD013	H3	BAE680AG		
			SPA101	F1		SAG067	H1			
	APS45		SPA101	F1	SAA101				ESS0095A	J1
									SUA133	J2
			SPA101	F1		SEN8U	H1		SUA129	J3
			SPA101	F1	SAA101	SEN8U	H1		SUA129	J3
			SPA101	F1	SAA101	SEN8U	H1		SUA129	J3
	PRT03/04		KITATS05	F2	SAA101	CWM02/3	H1	BAE800B	ESS273/1	J1
			SPA101	F1					SUA130	J2
			SZA103	F1						
			WTS05-1	F1						
			KITATS05	F2	SAA101	CWM02/3	H1		ESS273/1	J1
			SPA101	F1					SUA130	J2
	PRT03/04		KITATS05	F2	SAA101	CWM02/3	H1	BAE800B	ESS0095A	J1
			SPA101	F1					SUA130	J2
			SZA103	F1						
			WTS05-1	F1						
		KITRPM36								
			KITATS05	F2		CWM02/3	H1		ESS452	J1
IWP023			SZA108	F1						
	PRT03/04		SZA107	F1				BAE800B		
		RPM36								
			SPA101	F1					SUA133	J2
					SAA101				ESS0095A	J1
	KITLDF6T					SAD026	H3		ESS0028A	J1
									GA2208	J2
						CVM03/1	H1			
						SAG097	H1			
						SAC095	H2			
								BAE680AG		



KW

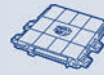

TYPE



TYPE

FIAT

PUNTO (188)

1.2 60 (188.030, .050, .130, .150, .230, .250)	Petrol	44	09/99 → 12/00		IAW59F.M2/1	A1		
1.2 60 (188.030, .050, .130, .150, .230, .250)	Petrol	44	09/99 → 12/00		IAW59F.VG	A1		
1.2 60 (188.030, .050, .130, .150, .230, .250)	Petrol	44	09/99 → 12/00		IAW59FM2R/1	A2		
1.2 60 (188.030, .050, .130, .150, .230, .250)	Petrol	44	01/01 → 05/03	ENGINE: 188A4000-	IAW59F.M3/7	A1		
1.2 60 (188.030, .050, .130, .150, .230, .250)	Petrol	44	01/01 → 05/03	ENGINE: 188A4000-	IAW59FM3R/1	A2		
1.2 60 (188.030, .050, .130, .150, .230, .250)	Petrol	44	01/01 → 05/03		IAW59F.E4/1	A1		
1.2 60 (188.030, .050, .130, .150, .230, .250)	Petrol	44	06/03 →		IAW5AF.P4/4	A1	36SMF6	B3
1.2 60 (188.030, .050, .130, .150, .230, .250)	Petrol	44	06/03 → 08/05		IAW5AF.P3/3	A1		
1.2 60 (188.030, .050, .130, .150, .230, .250)	Petrol	44	09/99 →	ENGINE: 188A4000			IPF2C	B6
1.2 60 (188.030, .050, .130, .150, .230, .250)	Petrol	44	09/99 → 09/05	ENGINE: 188A4000-			36SXFE1/4	B3
1.2 60 (188.030, .050, .130, .150, .230, .250)	Petrol	44	01/01 →				KIT EC2/1	B2
1.2 60 (188.030, .050, .130, .150, .230, .250)	Petrol	44	09/99 →					
1.2 60 (188.030, .050, .130, .150, .230, .250)	Petrol	44	09/99 → 06/03					
1.2 60 (188.030, .050, .130, .150, .230, .250)	Petrol	44	07/03 →					
1.2 60 (188.030, .050, .130, .150, .230, .250)	Petrol	44	09/99 → 01/02					
1.2 60 (188.030, .050, .130, .150, .230, .250)	Petrol	44	09/99 →	ENGINE: 2192182 →				
1.2 60 (188.030, .050, .130, .150, .230, .250)	Petrol	44	09/99 →					
1.2 Natural Power	BiFuel	44	01/04 →		IAW5AF.PE/2	A1		
1.2 Natural Power	BiFuel	44	09/03 →				KIT EC2/1	B2
1.2 Natural Power	BiFuel	44	09/03 →	ENGINE: 2192182 →				
1.3 JTD 16V	Diesel	51	06/03 →		MJD6JFP1	A1		
1.3 JTD 16V	Diesel	51	06/03 →					
1.3 JTD 16V	Diesel	51	06/03 →		MJD6JFP3	A1		
1.3 JTD 16V	Diesel	51	07/03 →					
1.4	Petrol	70	09/03 →				TB0009	B3
1.4	Petrol	70	09/03 →					
1.4	Petrol	70	03/04 →					

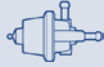

TYPE



TYPE



TYPE

IWP116/1

IWP023

KITTPRT05/2

KITLDF6T

816001633701 F1

SAC094 H2

SAC095 H2

CVM03/1 H1

GA2018 J2

SAC095 H2 SUA130 J2

CVM03/1 H1

SAC093 H2 SUA524 J2

SAG025 H1

APS23

KITLDF6T

SAD026 H3 ESS0028A J1

GA2208 J2

SPA156 F1



KW

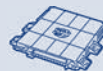

TYPE



TYPE

FIAT

PUNTO (188)

1.4	Petrol	70	09/03 →	ENGINE: 188A5000				
1.8 130 HGT (188.738, .718)	Petrol	96	09/99 →					
1.9 DS 60 (188.031, .051, .231, .251)	Diesel	44	09/99 →					
1.9 JTD	Diesel	63	10/01 →				TB0016	B3
1.9 JTD	Diesel	74	06/03 →				TB0016	B3
1.9 JTD	Diesel	63	10/01 → 06/03					
1.9 JTD 80 (188.237, .257, .337, .357)	Diesel	59	09/99 →				TB0016	B3
1.9 JTD 80 (188.237, .257, .337, .357)	Diesel	59	09/99 → 06/03					
1.9 JTD 80 (188.237, .257, .337, .357)	Diesel	59	09/99 → 07/01					
1.9 JTD 80 (188.237, .257, .337, .357)	Diesel	59	09/99 → 06/03					

PUNTO (199)

1.2	Petrol	51	03/12 →	ENGINE: 169A4000			40GTE3F	B3
1.3 D Multijet	Diesel	55	03/12 →					
1.3 D Multijet	Diesel	62	03/12 →					
1.3 D Multijet	Diesel	70	03/12 →					
1.4 Turbo Multi Air	Petrol	99	03/12 →					

PUNTO / GRANDE PUNTO (199)

1.2	Petrol	48	10/05 →		IAW5SF3.M1/4	A1	40SMF10/1	B3
1.2	Petrol	48	10/05 →				KIT EC2/1	B2
1.2	Petrol	48	10/05 →	ENGINE: 831A1000				
1.3 D Multijet	Diesel	55	10/05 → 06/08		MJD6F3P6	A1		
1.3 D Multijet	Diesel	55	04/07 → 03/08		MJD6F3P7	A1		
1.3 D Multijet	Diesel	55	04/08 → 07/08		MJD6F3P7/1	A1		
1.3 D Multijet	Diesel	66	10/05 →		MJD6F3P5	A1		
1.3 D Multijet	Diesel	66	10/05 →		MJD6F3P8	A1		
1.3 D Multijet	Diesel	66	10/05 →		MJD6F3PB	A1		
1.3 D Multijet	Diesel	66	07/08 →		MJD6F3P5/1	A1		
1.3 D Multijet	Diesel	66	07/08 →		MJD6F3PB/1	A1		
1.3 D Multijet	Diesel	56	06/09 →	ENGINE: 199A2000			40DFP1	B3
1.3 D Multijet	Diesel	66	10/05 →	ENGINE: 199A3000			40CDSF1	B3
1.3 D Multijet	Diesel	55	10/05 →					
1.3 D Multijet	Diesel	55	10/05 →					
1.3 D Multijet	Diesel	55	10/05 →					
1.3 D Multijet	Diesel	62	04/10 →					
1.4	Petrol	57	10/05 →		IAW5SF3.M2/3	A1	44SMF9/1	B3
1.4	Petrol	57	10/05 →				KIT EC2/1	B2
1.4	Petrol	57	10/05 →	ENGINE: 831A1000				
1.4 16V	Petrol	70	10/05 →					
1.4 16V	Petrol	70	02/06 →					



TYPE

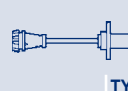

TYPE



TYPE

								BAE403C		
IWP006								BAE680G		
									SUA424	J3
							SAC088	H2	SUA524	J2
			ATS20	F2			SAC088	H2	SUA524	J2
APS23										
									ESS537	J1
APS23							SAC088	H2		
APS31										
									SUA524	J2
							SAF001	H4		
							SAF001	H4		
							SAF001	H4		
									BAE680CD	
IWP160	KITLDF6T		SPA156	F1			CVM03/1	H1	SUA551	J2
							SAC079	H2		
									BAE940A	
	APS25		ATS20	F2			SAC093	H2		
							SAG025	H1		
							SAC093	H2		
							SAF001	H4		
							SAG025	H1		
							SAF001	H4		
IWP160	KITLDF6T		SPA156	F1			CVM03/1	H1	SUA551	J2
							SAC079	H2		
									BAE940A	
			SPA156	F1			SAD026	H3	BAE403C	
									SUA551	J2



KW



TYPE



TYPE

FIAT

PUNTO / GRANDE PUNTO (199)

1.4 Abarth	Petrol	114	12/07 →					
1.4 Abarth	Petrol	114	12/07 →					
1.4 Abarth	Petrol	132	12/07 →					
1.4 LPG	Petrol/LPG	57	12/08 →	ENGINE: 350A1000			44SMF9/1	B3
1.4 T-Jet	Petrol	88	09/07 →					
1.4 T-Jet	Petrol	88	09/07 →					
1.4 T-Jet	Petrol	88	09/07 → 12/09					
1.6 D Multijet	Diesel	88	07/08 →					
1.9 D Multijet	Diesel	88	10/05 →				48CPD1	B3
1.9 D Multijet	Diesel	96	10/05 →				48CPD1	B3
1.9 D Multijet	Diesel	85	06/06 →					
1.9 D Multijet	Diesel	88	10/05 →					
1.9 D Multijet	Diesel	96	10/05 →					

PUNTO Cabriolet (176C)

60 1.2	Petrol	43	04/94 → 06/00				KITPF2C	B6
60 1.2	Petrol	44	05/95 → 06/00				KITPF2C	B6
60 1.2	Petrol	44	05/95 → 12/97				KITEC1/02	B2
60 1.2	Petrol	44	05/95 → 06/00					
60 1.2	Petrol	43	04/94 → 06/00					
60 1.2	Petrol	44	05/95 → 06/00					
60 1.2	Petrol	44	05/95 → 06/00					
60 1.2	Petrol	44	05/95 → 12/98					
85 16V 1.2	Petrol	63	04/97 → 06/00				40SXF1	B3
85 16V 1.2	Petrol	63	04/97 → 06/00				KITEC1/02	B2
85 16V 1.2	Petrol	63	04/97 → 04/99				KITPF2C	B6
85 16V 1.2	Petrol	63	04/97 → 12/99					
85 16V 1.2	Petrol	63	04/97 → 12/99					
90 1.6	Petrol	65	04/94 → 04/97					
90 1.6	Petrol	65	04/94 → 04/97					

PUNTO EVO (199)

1.2	Petrol	51	10/09 → 02/12	ENGINE: 169A4000			40SMF10/1	B3
1.2	Petrol	48	10/09 → 02/12					
1.2	Petrol	51	10/09 → 02/12					
1.3 D Multijet	Diesel	55	10/09 → 02/12	ENGINE: 199A2000,199A9000			40DFP1	B3
1.3 D Multijet	Diesel	66	10/09 → 02/12	ENGINE: 199A3000			40CDSF1	B3
1.3 D Multijet	Diesel	55	10/09 → 02/12					
1.3 D Multijet	Diesel	66	10/09 → 02/12					
1.3 D Multijet	Diesel	62	10/09 → 02/12					
1.3 D Multijet	Diesel	70	10/09 → 02/12					
1.4	Petrol	57	10/09 → 02/12					
1.4 16V	Petrol	99	12/09 → 12/11					
1.4 Abarth	Petrol	120	06/10 →					
1.4 LPG	Petrol/LPG	57	06/09 → 02/12	ENGINE: 350A1000			44SMF9/1	B3
1.4 LPG	Petrol/LPG	57	06/09 → 02/12					

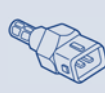

TYPE

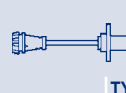

TYPE



TYPE

				SPA156	F1		SAC095	H2	BAE680BQ	GA2110	J2
							SAD026	H3			
									BAE680BQ		
				SPA156	F1		SAC095	H2		GA2110	J2
							SAD026	H3			
									BAE680BQ		
		APS36					SAF001	H4			
		APS36		ATS20	F2		SAC088	H2			
		APS36					SAC088	H2			
		APS36					SAF001	H4			
							SAF001	H4			
							SAF001	H4			
				KITATS05	F2	SAA101	CWM02/3	H1		ESS0095A	J1
		PRT03/04		KITATS05	F2	SAA101	CWM02/3	H1		ESS0095A	J1
				SPA101	F1					ESS273/1	J1
										SUA130	J2
				SZA103	F1					SUA130	J2
				WTS05-1	F1						
									BAE800B		
	IWP045	KITTPRT05/2	KITRPM40	SPA101	F1				BAE800B	ESS0095A	J1
			RPM40							SUA133	J2
				SZA103	F1						
				WTS05-1	F1						
		APS45		SPA101	F1	SAA101				ESS0095A	J1
				SPA115	F1					SUA133	J2
	IWP160						SAG082	H1		GA2176	J2
										GA2176	J2
		APS63		SPA146	F1		SAF001	H4			
		APS63		SPA146	F1						
				SPA146	F1		SAF001	H4			
				SPA146	F1		SAF001	H4			
										GA2176	J2
									BAE680CD		
									BAE680CD		
										GA2176	J2



KW



TYPE



TYPE

FIAT

PUNTO EVO (199)

1.4 Natural Power	BiFuel	57	10/09 → 02/12
1.6 D Multijet	Diesel	88	10/09 → 02/12
1.6 D Multijet	Diesel	88	10/09 → 02/12

48CPD6G B3

PUNTO EVO Furgonato (199)

1.3 D Multijet	Diesel	55	03/09 →
1.4	Petrol	57	03/09 →

PUNTO Van (176L)

1.1	Petrol	40	04/96 → 02/00
1.1	Petrol	40	04/96 → 12/97
1.1	Petrol	40	04/96 → 02/00
1.1	Petrol	40	04/96 → 02/00
1.7 D	Diesel	42	04/96 → 02/00
1.7 TD	Diesel	52	04/96 → 02/00

KITPF2C B6
KITEC1/02 B2

PUNTO Van (188AX)

1.2 60	Petrol	44	02/00 → 12/00
1.2 60	Petrol	44	02/00 → 12/00
1.2 60	Petrol	44	02/00 → 12/00
1.2 60	Petrol	44	01/01 → 05/03
1.2 60	Petrol	44	01/01 → 05/03
1.2 60	Petrol	44	01/01 → 05/03
1.2 60	Petrol	44	06/03 → 10/09
1.2 60	Petrol	44	06/03 → 08/05
1.2 60	Petrol	44	02/00 → 10/09
1.2 60	Petrol	44	02/00 → 10/09
1.2 60	Petrol	44	01/01 → 10/09
1.2 60	Petrol	44	07/03 → 10/09
1.2 60	Petrol	44	02/00 → 01/02
1.2 60	Petrol	44	02/00 → 10/09
1.2 60	Petrol	44	02/00 → 10/09
1.3 JTD	Diesel	51	06/03 → 10/05
1.3 JTD	Diesel	51	06/03 → 10/05
1.9 D 60	Diesel	44	02/00 → 10/09
1.9 JTD	Diesel	63	02/00 → 10/09
1.9 JTD	Diesel	63	02/00 → 06/03
1.9 JTD	Diesel	63	02/00 → 07/01
1.9 JTD	Diesel	63	02/00 → 06/03

IAW59F.M2/1 A1
IAW59F.VG A1
IAW59FM2R/1 A2
IAW59F.M3/7 A1
IAW59FM3R/1 A2
IAW59F.E4/1 A1
IAW5AF.P4/4 A1 36SMF6 B3
IAW5AF.P3/3 A1
ENGINE: 188A4000 IPF2C B6
ENGINE: 188A4000- 36SXFE1/4 B3
KIT EC2/1 B2
TB0016 B3

PUNTO Van (199)

1.3 D Multijet	Diesel	70	03/09 →
----------------	--------	----	---------

QUBO

1.3 D Multijet	Diesel	55	12/08 →
----------------	--------	----	---------

MJD6F3H1 A1

QUBO (225)

1.3 D Multijet	Diesel	55	02/08 →
1.3 D Multijet	Diesel	70	07/10 →
1.4	Petrol	54	02/08 →

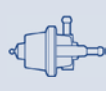

TYPE

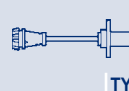

TYPE



TYPE

								GA2176	J2
	APS63						SAF001	H4	
							SAG080	H1	
	APS36	SPA146	F1						
								GA2176	J2
	PRT03/04	KITATS05	F2			CWM02/3	H1	BAE800B	ESS273/1
		SZA103	F1						SUA130
		WTS05-1	F1						
		SPA101	F1			SEN8U	H1		SUA129
		SPA101	F1	SAA101		SEN8U	H1		SUA129
	IWP116/1								
		KITLDF6T							
				816001633701	F1				
							CWM02/3	H1	ESS0095A
									GA2018
							SAC093	H2	SUA524
							SAG025	H1	
									SUA424
	APS23						SAC088	H2	
	APS31								
									SUA524
									J2
	APS36	SPA146	F1						
	APS36						SAF001	H4	GA2174
									J2
	APS36	SPA146	F1				SAF001	H4	
IWP160	APS77	SPA107	F1	SAA118		SAG164	H1		GA2068
									J2



KW

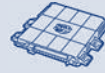

TYPE



TYPE

FIAT

REGATA (138)

100 Super 1.6	Petrol	74	10/83 → 12/90						
100 Super 1.6	Petrol	74	01/89 → 12/90						
65 Diesel 1.9	Diesel	48	04/84 → 07/89						
70 1.3	Petrol	50	09/83 → 07/86						
70 1.3	Petrol	48	09/83 → 07/89						
70 1.3	Petrol	48	09/83 → 12/85						
70 1.3	Petrol	48	01/86 → 07/89						
75 i.e. 1.5	Petrol	55	07/85 → 07/89						
75 i.e. 1.5	Petrol	55	05/87 → 07/89						
80 Turbo Diesel 1.9	Diesel	59	05/86 → 07/89						
85 1.5	Petrol	58	05/85 → 12/87						
85 Super 1.5	Petrol	60	09/83 → 04/85						

REGATA Weekend

65 Diesel 1.9	Diesel	48	04/84 → 07/89						
70 1.3	Petrol	50	01/84 → 07/89						
70 1.3	Petrol	50	01/84 → 12/85						
75 1.5	Petrol	55	09/84 → 07/89						
75 1.5	Petrol	55	09/84 → 12/85						
75 1.5 i.e. Cat.	Petrol	55	05/87 → 07/89						
80 Turbo Diesel 1.9	Diesel	59	05/86 → 07/89						

RITMO I (138A)

105 Sport 1.6	Petrol	77	05/81 → 12/82						
125 TC Abarth 2.0	Petrol	92	11/81 → 09/82						
60 1.0	Petrol	44	09/78 → 09/82						
65 1.3	Petrol	48	01/78 → 09/82						
70 1.3	Petrol	48	11/83 → 08/85						
75 1.3	Petrol	55	01/81 → 09/82						
75 i.e. 1.5	Petrol	55	10/85 → 05/87						
85 1.5	Petrol	63	01/81 → 09/82						

RITMO II (138A)

100 1.6	Petrol	74	01/83 → 12/87						
105 1.6	Petrol	77	01/83 → 12/87						
125 TC Abarth 2.0	Petrol	92	12/82 → 12/87						
130 TC Abarth 2.0	Petrol	96	04/83 → 12/87						
60 1.1	Petrol	43	04/85 → 12/87						
60 1.1	Petrol	40	10/82 → 10/85						
60 Diesel 1.7	Diesel	43	10/82 → 10/85						
70 1.3	Petrol	50	01/83 → 04/85						
75 1.5	Petrol	55	09/85 → 12/88						
75 1.5 Cat.	Petrol	55	09/85 → 12/88						
85 1.5	Petrol	60	01/83 → 12/87						
90 1.6 i.e.	Petrol	66	12/85 → 12/87						

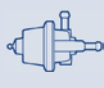

TYPE

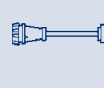

TYPE



TYPE

				SPA101	F1			SEN8E	H1					
								SEN8D	H1					
				SPA101	F1									
				SPA101	F1									
								SEN8D	H1					
										BK2A				
										BAE506F				
								SEN8D	H1	BAE504D	PI024	J1		
											ESS514	J1		
				SPA101	F1									
				SPA101	F1			SEN8D	H1	BK2A				
								SEN8D	H1					
				SPA101	F1									
				SPA101	F1									
										BK2A				
								SEN8D	H1					
										BK2A				
											ESS514	J1		
				SPA101	F1									
								SEN8D	H1					
								SEN8D	H1					
										BK2A				
										BK2A				
				SPA101	F1									
				SPA101	F1			SEN8D	H1	BAE504D				
								SEN8D	H1					
				SPA101	F1									
				SPA101	F1			SEN8D	H1					
											PI024	J1		
								SEN8D	H1		PI024	J1		
				SPA101	F1			SEN8D	H1	BK2A				
								SEN8D	H1	BK2A				
				SPA101	F1									
										BK2A				
				SPA101	F1									
											PI024	J1		
								SEN8D	H1	BK2A				
											ESS514	J1		



KW



TYPE



TYPE

FIAT

SCUDO (270_)

1.6 D Multijet	Diesel	66	01/07 →					
1.6 D Multijet	Diesel	66	01/07 →					
1.6 D Multijet	Diesel	66	01/07 →	ENGINE: DV6TED4				
2.0 D Multijet	Diesel	88	01/07 → 11/07	ENGINE: RHK			50CDSP3	B3
2.0 D Multijet	Diesel	88	11/07 →	ENGINE: RHK			50CAD281	B3
2.0 D Multijet	Diesel	100	01/07 →					
2.0 D Multijet	Diesel	88	01/07 →					
2.0 D Multijet	Diesel	100	01/07 →					
2.0 D Multijet	Diesel	100	01/07 →					
2.0 D Multijet	Diesel	88	01/07 →					
2.0 D Multijet	Diesel	88	01/07 →					
2.0 D Multijet	Diesel	100	01/07 →	ENGINE: DW10TEDA				
2.0 D Multijet 4x4	Diesel	88	01/07 → 11/07	ENGINE: RHK			50CDSP3	B3
2.0 D Multijet 4x4	Diesel	88	11/07 →	ENGINE: RHK			50CAD281	B3

SCUDO Combinato (220P)

1.9 D	Diesel	51	04/98 → 12/06					
1.9 D	Diesel	51	09/99 → 12/06					
1.9 TD Eco	Diesel	66	02/96 → 12/06					
1.9 TD Eco	Diesel	66	09/99 → 12/06					
2.0 16V	Petrol	100	06/00 → 12/06	ENGINE: EW10J4	IAW48P2.34/2	A1		
2.0 16V	Petrol	100	06/00 → 12/06					
2.0 16V	Petrol	100	06/00 → 12/00					
2.0 16V	Petrol	100	09/02 → 12/06					
2.0 JTD	Diesel	80	12/99 → 12/06					
2.0 JTD	Diesel	69	01/04 → 12/06					
2.0 JTD	Diesel	80	12/99 → 06/01					
2.0 JTD	Diesel	80	07/01 → 12/06					

SCUDO Furgonato (220L)

1.6	Petrol	58	02/96 → 12/06					
1.6	Petrol	58	02/96 → 05/00					
1.6	Petrol	58	09/99 → 12/06					
1.9 D	Diesel	51	04/98 → 12/06					
1.9 D	Diesel	51	02/96 → 12/06					
1.9 D	Diesel	51	09/99 → 12/06					
1.9 D	Diesel	51	09/99 → 12/06					
1.9 TD	Diesel	66	02/96 → 12/06					
1.9 TD	Diesel	68	02/98 → 12/06					
1.9 TD	Diesel	66	09/99 → 12/06					
1.9 TD	Diesel	68	09/99 → 12/06					
2.0	Petrol	100	08/02 → 12/06	ENGINE: EW10J4	IAW48P2.34/2	A1		
2.0	Petrol	100	05/00 → 12/06					
2.0	Petrol	100	05/00 → 12/06					
2.0 JTD	Diesel	69	12/99 → 12/06					
2.0 JTD	Diesel	80	12/02 → 12/06					

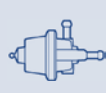

TYPE

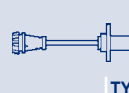

TYPE



TYPE

	APS38		ATS22	F2	SAA118	SAC096	H2	SUA553	J3
			SPA172	F1		SAG080	H1		
								SUA512	J3
	APS38		ATS22	F2	SAA118	SAC096	H2	SUA587	J3
	APS38		ATS22	F2	SAA118	SAC096	H2	SUA587	J3
			SPA172	F1		SAG169	H1	SUA588	J3
								SUA589	J3
			SPA172	F1		SAG169	H1	SUA588	J3
								SUA589	J3
								SUA512	J3
			SPA107	F1	SAA118	SAG028	H1		
						SAG027	H1		
					SAA118	SAG028	H1		
						SAG027	H1		
			SPA107	F1	SAA118				
						SAG157	H1		
						SAC070	H2		
	APS35		SPA107	F1	SAA118	SAG027	H1		
			SPA107	F1	SAA118				
								SUA463	J2
								SUA494	J2
			SPA104	F1		SAG028	H1		
						SAG048	H1	BAE680AG	
						SAG027	H1		
			SPA107	F1	SAA118	SAG028	H1		
						SAG028	H1		
						SAG027	H1		
						SAG027	H1		
					SAA118	SAG028	H1		
					SAA118	SAG028	H1		
						SAG027	H1		
						SAG027	H1		
			SPA107	F1	SAA118	SAC070	H2		
						SAD033	H3		
	APS35		SPA107	F1	SAA118	SAG027	H1		
	APS35		SPA107	F1	SAA118			SUA494	J2

KW

TYPE

TYPE
FIAT
SCUDO Furgonato (220L)

2.0 JTD	Diesel	69	12/99 → 06/01					
2.0 JTD	Diesel	69	07/01 → 12/06					

SCUDO Furgonato (270_)

1.6 D Multijet	Diesel	66	01/07 →					
1.6 D Multijet	Diesel	66	01/07 →	ENGINE: DV6TED4				
2.0 D Multijet	Diesel	88	01/07 → 11/07	ENGINE: RHK		50CDSP3	B3	
2.0 D Multijet	Diesel	88	11/07 →	ENGINE: RHK		50CAD281	B3	
2.0 D Multijet	Diesel	100	01/07 →					
2.0 D Multijet	Diesel	88	01/07 →					
2.0 D Multijet	Diesel	100	01/07 →					
2.0 D Multijet	Diesel	100	01/07 →					
2.0 D Multijet	Diesel	88	01/07 →					
2.0 D Multijet	Diesel	88	01/07 →					
2.0 D Multijet	Diesel	100	01/07 →	ENGINE: DW10TEDA				
2.0 D Multijet 4x4	Diesel	88	01/07 → 11/07	ENGINE: RHK		50CDSP3	B3	
2.0 D Multijet 4x4	Diesel	88	11/07 →	ENGINE: RHK		50CAD281	B3	

SCUDO Pianale piatto/Telaio (270_)

1.6 D Multijet	Diesel	66	01/07 →					
1.6 D Multijet	Diesel	66	01/07 →					
1.6 D Multijet	Diesel	66	01/07 →	ENGINE: DV6TED4				
2.0 D Multijet	Diesel	88	01/07 → 11/07	ENGINE: RHK		50CDSP3	B3	
2.0 D Multijet	Diesel	88	11/07 →	ENGINE: RHK		50CAD281	B3	
2.0 D Multijet	Diesel	100	01/07 →					
2.0 D Multijet	Diesel	100	01/07 →					
2.0 D Multijet	Diesel	100	01/07 →					
2.0 D Multijet	Diesel	100	01/07 →	ENGINE: DW10TEDA				

SEDICI

1.6 16V 4x4	Petrol	79	06/06 →					
1.9 D Multijet	Diesel	88	06/06 →					
1.9 D Multijet 4x4	Diesel	88	06/06 →			48CPD1	B3	
2.0 D Multijet	Diesel	99	06/06 →					
2.0 D Multijet 4x4	Diesel	99	06/06 →					

SEICENTO (187)

0.9 (187AXA, 187AXA1A)	Petrol	29	01/98 → 01/10			KITPF2C	B6	
0.9 (187AXA, 187AXA1A)	Petrol	29	01/98 → 12/00			B01	B1	
0.9 (187AXA, 187AXA1A)	Petrol	29	01/98 → 01/10					
1.1 (187AXB, 187AXB1A)	Petrol	40	01/98 → 01/10		IAW59F.M1/2	A1	KITPF2C	B6
1.1 (187AXB, 187AXB1A)	Petrol	40	01/01 → 01/10	ENGINE: 176B2000, ENGINE: 1236150 →	IAW4AF.M8/1	A1		
1.1 (187AXB, 187AXB1A)	Petrol	40	01/01 → 06/01	ENGINE: 176B2000	IAW59F.M7/6	A1		
1.1 (187AXB, 187AXB1A)	Petrol	40	01/01 → 06/01	ENGINE: 176B2000	IAW59FM7R	A2		
1.1 (187AXB, 187AXB1A)	Petrol	40	09/08 → 01/10	ENGINE: 176B2000	IAW4AF.M9/2	A1		
1.1 (187AXB, 187AXB1A)	Petrol	40	01/98 → 01/10	ENGINE: 176B2000,187A1000			IPF2C	B6
1.1 (187AXB, 187AXB1A)	Petrol	40	01/98 → 12/00				B12	B1



TYPE

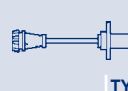

TYPE



TYPE

								SUA463	J2
								SUA494	J2
	APS38	ATS22	F2	SAA118	SAC096	H2			
								SUA512	J3
	APS38	ATS22	F2	SAA118	SAC096	H2		SUA587	J3
	APS38	ATS22	F2	SAA118	SAC096	H2		SUA587	J3
		SPA172	F1		SAG169	H1		SUA588	J3
								SUA589	J3
		SPA172	F1		SAG169	H1		SUA588	J3
								SUA589	J3
								SUA512	J3
		SPA172	F1	SAA118	SAC096	H2			
					SAG080	H1			
								SUA512	J3
	APS38	SPA172	F1	SAA118	SAC096	H2		SUA587	J3
					SAG169	H1		SUA588	J3
								SUA589	J3
								SUA512	J3
				SAA111					
	APS36								
	APS36	ATS20	F2		SAC088	H2			
	APS36								
	APS36								
	PRT03/04	KITATS05	F2		SEN8D3	H1	BAE800B		
								SUA431	J2
		SPA101	F1						
	PRT03/04	KITATS05	F2		CWM02/6	H1	BAE800B		
								SUA431	J2



KW

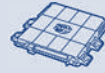

TYPE



TYPE

FIAT

SEICENTO (187)

1.1 (187AXB, 187AXB1A)	Petrol	40	01/01 → 01/10					KIT EC2/1	B2
1.1 (187AXB, 187AXB1A)	Petrol	40	01/01 → 01/10	ENGINE: 176B2000				36SXF1/4	B3
1.1 (187AXB, 187AXB1A)	Petrol	40	01/01 → 01/02						
1.1 (187AXB, 187AXB1A)	Petrol	40	09/00 → 01/10	CHASSIS: 1219711 →					

SEICENTO Van (187)

0.9 (187AXA)	Petrol	29	01/98 → 01/10					KITPF2C	B6
0.9 (187AXA)	Petrol	29	01/98 → 01/10						
0.9 (187AXA)	Petrol	29	01/98 → 12/00						
1.1 (187CXB/C)	Petrol	40	01/01 → 06/01	ENGINE: 176B2000	IAW59F.M7/6	A1			
1.1 (187CXB/C)	Petrol	40	01/01 → 06/01	ENGINE: 176B2000	IAW59FM7R	A2			
1.1 (187CXB/C)	Petrol	40	09/09 → 01/10	ENGINE: 176B2000	IAW4AF.M9/2	A1			
1.1 (187CXB/C)	Petrol	40	01/98 → 01/10	ENGINE: 176B2000				IPF2C	B6
1.1 (187CXB/C)	Petrol	40	01/98 → 01/10					KITPF2C	B6
1.1 (187CXB/C)	Petrol	40	01/98 → 12/00					B12	B1
1.1 (187CXB/C)	Petrol	40	01/01 → 01/10					KIT EC2/1	B2
1.1 (187CXB/C)	Petrol	40	01/01 → 01/10	ENGINE: 176B2000				36SXF1/4	B3
1.1 (187CXB/C)	Petrol	40	01/01 → 01/02						

SIENA (178_)

1.2	Petrol	54	09/98 →					KITPF2C	B6
1.2	Petrol	54	09/98 → 12/00					B18	B1
1.2	Petrol	54	02/01 →					36SXF5/1	B3
1.2	Petrol	54	01/01 →						
1.2	Petrol	54	09/98 → 12/04						
1.2	Petrol	54	09/98 →						
1.2	Petrol	54	09/98 →						
1.2	Petrol	59	01/02 →						
1.4	Petrol	51	04/96 →					44SMF9/1	B3
1.4	Petrol	51	03/00 → 06/01						
1.4 Cat.	Petrol	51	04/96 →						
1.4 Cat.	Petrol	51	05/98 → 06/01						
1.6 16V	Petrol	78	09/98 →					KITEC1/02	B2
1.6 16V	Petrol	78	01/02 →					46SXF7	B3
1.6 16V	Petrol	78	01/01 → 12/04						
1.6 16V	Petrol	78	01/01 →						
1.6 16V	Petrol	78	09/98 →	ENGINE: 178B3000					

STILO (192)

1.2 16V (192_XA1B)	Petrol	59	02/02 → 12/03					TB0011	B3
1.2 16V (192_XA1B)	Petrol	59	02/02 → 11/06						
1.2 16V (192_XA1B)	Petrol	59	02/02 → 12/03	CHASSIS: 819154 →					
1.2 16V (192_XA1B)	Petrol	59	02/02 → 11/06	ENGINE: 188A5000					
1.2 16V (192_XA1B)	Petrol	59	02/02 → 05/02						
1.4 16V	Petrol	66	03/05 → 11/06					TB0009	B3
1.4 16V	Petrol	70	01/04 → 11/06					TB0009	B3
1.4 16V	Petrol	66	03/05 → 11/06						



TYPE



TYPE



TYPE

IWP116/1	KITTPRT05/2					CWM02/5	H1		GA2021	J2
				816001633701	F1					
						SAC095	H2			
				KITATS05	F2					
				SPA101	F1					
									SUA431	J2
				KITATS05	F2	CWM02/6	H1			
									SUA431	J2
IWP116/1									GA2021	J2
				816001633701	F1					
				KITATS05	F2	CWM02/3	H1	BAE800B	ESS0040A	J1
IWP116/1				SZA105	F1					
	KITTPRT05/2									
				SPA101	F1					
				SZA106	F1					
								BAE680AG		
				SPA101	F1	CVM03/1	H1	BAE940A		
						SAG067	H1			
				SPA101	F1	CVM03/1	H1	BAE940A		
						SAG067	H1			
IWP164						CWM02/1	H1		ESS0040A	J1
	KITTPRT05/2									
				SZA105	F1					
								BAE920AX		
	KITLDF6T					SAG097	H1			
						SAD026	H3			
						SAC095	H2			
								BAE403C		
									SUA544	J2
	KITLDF6T	SPA156	F1			SAC095	H2		SUA544	J2
	KITLDF6T					SAC095	H2		SUA544	J2
						SAD026	H3			



KW



TYPE



TYPE

FIAT

STILO (192)

1.4 16V	Petrol	70	01/04 → 11/06						
1.4 16V	Petrol	70	03/04 → 11/06						
1.4 16V	Petrol	70	01/04 → 11/06	ENGINE: 843A1000					
1.6	Petrol	100	06/05 → 11/06						
1.6 16V	Petrol	77	05/05 → 11/06						
1.6 16V (192_XB1A)	Petrol	76	10/01 → 11/06		IAW5NF.T1/1	A1	KIT48SMF5	B3	
1.6 16V (192_XB1A)	Petrol	76	01/03 → 11/06		IAW5NF.T9/1	A1			
1.6 16V (192_XB1A)	Petrol	76	10/01 → 11/06	ENGINE: 182B600					
1.6 16V (192_XB1A)	Petrol	76	10/01 → 05/02						
1.8 16V (192_XC1A)	Petrol	98	10/01 → 11/06						
1.8 16V (192_XC1A)	Petrol	98	10/01 → 05/02						
1.9 D Multijet	Diesel	110	09/05 → 11/06	ENGINE: 937A5000			CAD191	B2	
1.9 D Multijet	Diesel	110	09/05 → 11/06						
1.9 D Multijet	Diesel	88	09/05 → 11/06						
1.9 D Multijet	Diesel	110	09/05 → 11/06						
1.9 D Multijet	Diesel	88	09/05 → 11/06						
1.9 D Multijet	Diesel	110	09/05 → 11/06						
1.9 D Multijet	Diesel	74	09/05 → 11/06						
1.9 D Multijet	Diesel	74	09/05 → 11/06						
1.9 JTD	Diesel	100	04/04 → 11/06						
1.9 JTD	Diesel	103	01/04 → 11/06						
1.9 JTD	Diesel	93	09/03 → 11/06						
1.9 JTD	Diesel	103	01/04 → 11/06						
1.9 JTD (192_XE1A)	Diesel	85	10/01 → 11/06	ENGINE: 192A1000,937A7000			48CPD9	B3	
1.9 JTD (192_XE1A)	Diesel	85	10/01 → 11/06						
1.9 JTD (192_XE1A)	Diesel	85	10/01 → 12/03						
1.9 JTD (192_XE1A)	Diesel	85	10/01 → 11/06	ENGINE: 192A1000					
1.9 JTD (192_XF1A)	Diesel	59	02/02 → 12/03						
1.9 JTD (192_XF1A)	Diesel	59	02/02 → 11/06						
1.9 JTD (192_XF1A)	Diesel	59	02/02 → 12/03						
1.9 JTD (192AXS1B, 192BXS1B)	Diesel	66	09/04 → 11/06	ENGINE: 192B5000			48CPD9	B3	
1.9 JTD (192AXS1B, 192BXS1B)	Diesel	66	09/04 → 11/06						
2.4 20V (192_XD1A)	Petrol	125	10/01 → 11/06						
2.4 20V (192_XD1A)	Petrol	125	10/01 → 11/06						
2.4 20V (192_XD1A)	Petrol	125	10/01 → 12/03						
2.4 20V (192_XD1A)	Petrol	125	10/01 → 11/06	ENGINE: 192A2000					
2.4 20V (192_XD1A)	Petrol	125	10/01 → 05/02						

STILO Multi Wagon (192)

1.4 16V	Petrol	66	03/05 → 08/08				TB0009	B3	
1.4 16V	Petrol	70	01/04 → 08/08				TB0009	B3	
1.4 16V	Petrol	66	03/05 → 08/08						
1.4 16V	Petrol	70	01/04 → 08/08						
1.4 16V	Petrol	70	03/04 → 08/08						
1.6 16V	Petrol	76	01/03 → 08/08		IAW5NF.T1/1	A1	KIT48SMF5	B3	



TYPE



TYPE



TYPE

						SAD026	H3			
			SPA156	F1						
								BAE403C		
									SUA550	J2
					SAA103					
IWP164	KITTPRT05/2					CWM02/1	H1			
								BAE403B		
									SUA544	J2
IWP006								BAE680G		
									SUA544	J2
	APS36	ATS20	F2		SAC068	H2			GA2191	J2
	APS36	ATS20	F2		SAC088	H2			GA2191	J2
					SAF001	H4				
					SAF001	H4				
					SAG133	H1				
					SAC088	H2			SUA529	J2
					SAF001	H4				
	APS36	ATS20	F2		SAG133	H1				
	APS36	ATS20	F2		SAC068	H2			GA2191	J2
	APS36	ATS20	F2		SAG133	H1				
					SAG133	H1				
	APS36				SAC088	H2			GA2191	J2
	APS23									
									SUA529	J2
	APS23									
					SAC088	H2				
									SUA529	J2
	APS36				SAC088	H2				
					SAD003	H3				
					SAG122	H1				
					SAC024	H2				
								BAE403D		
									SUA544	J2
	KITLDF6T	SPA156	F1		SAC095	H2	BAE403C	SUA544	J2	
	KITLDF6T				SAC095	H2	BAE403C	SUA544	J2	
					SAD026	H3				
					SAD026	H3				
		SPA156	F1							
IWP164	KITTPRT05/2					CWM02/1	H1		SUA544	J2



KW



TYPE



TYPE

FIAT

STILO Multi Wagon (192)

1.6 16V	Petrol	76	01/03 → 08/08		IAW5NF.T9/1	A1		
1.6 16V	Petrol	76	01/03 → 08/08	ENGINE: 182B600				
1.8 16V	Petrol	98	01/03 → 08/08					
1.9 D Multijet	Diesel	110	09/05 → 08/08	ENGINE: 937A5000			CAD191	B2
1.9 D Multijet	Diesel	110	09/05 → 08/08					
1.9 D Multijet	Diesel	88	09/05 → 08/08					
1.9 D Multijet	Diesel	110	09/05 → 08/08					
1.9 D Multijet	Diesel	88	09/05 → 08/08					
1.9 D Multijet	Diesel	74	09/05 → 08/08					
1.9 D Multijet	Diesel	74	09/05 → 08/08					
1.9 JTD	Diesel	85	01/03 → 08/08	ENGINE: 192A1000,937A7000			48CPD9	B3
1.9 JTD	Diesel	103	01/04 → 08/08					
1.9 JTD	Diesel	59	01/03 → 08/08					
1.9 JTD	Diesel	85	01/03 → 08/08					
1.9 JTD	Diesel	100	04/04 → 08/08					
1.9 JTD	Diesel	103	01/04 → 08/08					
1.9 JTD	Diesel	93	09/03 → 08/08					
1.9 JTD	Diesel	85	01/03 → 08/08	ENGINE: 192A1000				

STRADA Pick-up (178E)

1.2	Petrol	44	04/03 →				36SXF5/1	B3
1.2	Petrol	44	04/03 →				KIT EC2/1	B2
1.2	Petrol	54	06/99 →				KITPF2C	B6
1.2	Petrol	54	06/99 → 12/00				B18	B1
1.2	Petrol	54	02/01 →				36SXF5/1	B3
1.2	Petrol	54	01/01 →					
1.2	Petrol	44	04/03 → 12/04					
1.2	Petrol	54	06/99 → 03/03					
1.2	Petrol	54	06/99 →					
1.3 D Multijet	Diesel	62	05/06 →					
1.3 D Multijet	Diesel	62	05/06 →					
1.9 JTD	Diesel	59	05/03 →					
1.9 JTD	Diesel	59	04/03 →					

STRADA Pick-up (578_)

1.3 D Multijet	Diesel	70	10/10 →					
----------------	--------	----	---------	--	--	--	--	--

TEMPRA (159)

1.4 i.e. (159.AC)	Petrol	57	03/91 → 08/96					
1.4 i.e. (159.AC, 159.AX)	Petrol	51	03/92 → 08/96					
1.4 i.e. (159.AC, 159.AX)	Petrol	51	03/95 → 08/96					
1.6	Petrol	63	03/90 → 04/93					
1.6 i.e. (159.AE)	Petrol	57	06/90 → 07/92					
1.6 i.e. (159.AJ)	Petrol	63	06/94 → 08/96					
1.6 i.e. (159.AJ)	Petrol	66	06/94 → 08/96					
1.6 i.e. (159.AS, 159.AT)	Petrol	55	06/92 → 08/96					
1.6 i.e. (159.AS, 159.AT)	Petrol	55	04/93 → 08/96					

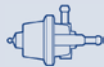

TYPE



TYPE



TYPE

								BAE403B		
								BAE680G	SUA544	J2
	APS36		ATS20	F2		SAF001	H4		GA2191	J2
	APS36		ATS20	F2		SAC088	H2		GA2191	J2
						SAG133	H1			
						SAF001	H4			
						SAC088	H2		SUA529	J2
						SAF001	H4			
	APS36		ATS20	F2		SAC068	H2		GA2191	J2
	APS23					SAC088	H2		SUA529	J2
	APS23					SAC088	H2			
			ATS20	F2		SAG133	H1			
						SAG133	H1			
			ATS20	F2		SAG133	H1			
									SUA529	J2
IWP116/1			KITATS05	F2		CWM02/3	H1	BAE800B		
			SZA105	F1						
			KITATS05	F2		CWM02/3	H1	BAE800B	ESS0040A	J1
IWP116/1			SZA105	F1						
	KITTPRT05/2									
	KITTPRT05/2									
			SZA106	F1						
	APS36		ATS20	F2		SAC093	H2			
						SAG025	H1			
	APS23									
						SAC088	H2		ESS0167A	J1
						SAF001	H4			
			SPA101	F1	SAA101			BAE504D		
			SPA101	F1	SAA101	SEN8M	H1	BAE504D	ESS514	J1
						SAG076	H1	BAE680AG		
			SPA101	F1	SAA101	SEN8M	H1	BAE504D		
			SPA101	F1	SAA101	SEN8M	H1	BAE504D	ESS514	J1
	APS45		SPA115	F1	SAA101				ESS514	J1
	APS45		SPA115	F1	SAA101				ESS0039A	J1
			SPA101	F1	SAA101				ESS514	J1
						SAG076	H1	BAE680AG		



KW



TYPE



TYPE

FIAT

TEMPRA (159)

1.8 i.e. (159.AN)	Petrol	77	03/92 → 08/96				KITPF1C	B6
1.8 i.e. (159.AN)	Petrol	77	01/93 → 08/96				B02	B1
1.8 i.e. (159.AN)	Petrol	81	03/90 → 08/96				KITPF1C	B6
1.8 i.e. (159.AN)	Petrol	81	01/93 → 08/96				B02	B1
1.8 i.e. (159.AN)	Petrol	77	03/92 → 08/92					
1.8 i.e. (159.AN)	Petrol	81	01/92 → 08/96					
1.8 i.e. (159.AN)	Petrol	77	03/92 → 08/96					
1.8 i.e. (159.AN)	Petrol	77	03/92 → 08/96					
1.8 i.e. (159.AN)	Petrol	81	01/92 → 08/96					
1.8 i.e. (159.AN)	Petrol	81	01/92 → 08/96					
1.8 i.e. (159.AV)	Petrol	76	09/93 → 08/96				B02	B1
1.8 i.e. (159.AV)	Petrol	76	09/93 → 08/96				KITEC1/02	B2
1.8 i.e. (159.AV)	Petrol	76	09/93 → 08/96				KITPF1C	B6
1.8 i.e. (159.AV)	Petrol	76	09/93 → 08/96					
1.8 i.e. (159.AZ)	Petrol	66	09/93 → 08/96				B02	B1
1.8 i.e. (159.AZ)	Petrol	66	09/93 → 08/96				KITPF1C	B6
1.8 i.e. (159.BY)	Petrol	74	10/94 → 08/96				B02	B1
1.8 i.e. (159.BY)	Petrol	74	10/94 → 08/96				KITEC1/02	B2
1.8 i.e. (159.BY)	Petrol	74	10/94 → 08/96				KITPF1C	B6
1.8 i.e. (159.BY)	Petrol	74	10/94 → 08/96					
1.9 D (159.AG)	Diesel	48	07/91 → 08/96					
1.9 TD (159.AQ)	Diesel	59	07/92 → 08/96					
1.9 TD (159.CU, 159.AU, 159.AI, 159.BI)	Diesel	66	05/90 → 08/96					
2.0 i.e. (159.AP)	Petrol	83	01/92 → 08/96					
2.0 i.e. (159.AP)	Petrol	83	01/93 → 08/96					
2.0 i.e. (159.AP)	Petrol	83	01/93 → 08/96					
2.0 i.e. (159.AP)	Petrol	83	10/90 → 08/96					

TEMPRA S.W. (159)

1.4 i.e. (159.AC)	Petrol	57	03/91 → 08/96					
1.4 i.e. (159.AC, 159.AX)	Petrol	51	10/92 → 08/96					
1.4 i.e. (159.AC, 159.AX)	Petrol	51	03/95 → 08/96					
1.6	Petrol	63	12/90 → 04/93					
1.6 i.e. (159.AE)	Petrol	57	10/90 → 08/96					
1.6 i.e. (159.AJ)	Petrol	66	06/94 → 08/96					
1.6 i.e. (159.AS, 159.AT)	Petrol	55	10/92 → 08/96					
1.6 i.e. (159.AS, 159.AT)	Petrol	55	04/93 → 08/96					
1.8 i.e. (159.AN)	Petrol	77	03/92 → 12/93				KITPF1C	B6
1.8 i.e. (159.AN)	Petrol	77	01/93 → 12/93				B02	B1
1.8 i.e. (159.AN)	Petrol	81	03/90 → 08/96				KITPF1C	B6
1.8 i.e. (159.AN)	Petrol	81	01/93 → 08/96				B02	B1
1.8 i.e. (159.AN)	Petrol	77	03/92 → 12/92					
1.8 i.e. (159.AN)	Petrol	81	01/92 → 08/96					
1.8 i.e. (159.AN)	Petrol	77	03/92 → 12/93					



TYPE



TYPE



TYPE

			SPA101	F1	SAA101	SAG026	H1		ESS0039A	J1
					SAA101				ESS0039A	J1
	PRT03/04		ATS04-1	F2						
	PRT03/04		ATS04-1	F2		SEN8D	H1			
			SZA103	F1		SEN8I	H1			
			WTS05-1	F1						
			SZA103	F1						
			WTS05-1	F1						
	PRT03/04	KITRPM36	ATS04-1	F2	SAA101	SAG026	H1	BAE800B	ESS0039A	J1
		RPM36	SPA101	F1		SEN8I3	H1			
			SZA103	F1						
			WTS05-1	F1						
			SPA101	F1	SAA101	SAG026	H1		ESS0039A	J1
	PRT03/04	KITRPM36	ATS04-1	F2	SAA101	SAG026	H1	BAE800B	ESS0039A	J1
		RPM36	SPA101	F1		SEN8I3	H1			
			SZA103	F1						
			WTS05-1	F1						
			SPA101	F1	SAA101					
			SPA101	F1	SAA101					
			SPA101	F1	SAA101					
	PRT03/04		ATS04-1	F2						
		KITRPM40	SZA103	F1		SEN8I	H1			
		RPM40	WTS05-1	F1						
			SPA101	F1	SAA101	SAG026	H1		ESS0039A	J1
			SPA101	F1	SAA101			BAE504D		
			SPA101	F1	SAA101	SEN8M	H1	BAE504D	ESS514	J1
						SAG076	H1	BAE680AG		
			SPA101	F1	SAA101	SEN8M	H1	BAE504D		
			SPA101	F1	SAA101	SEN8M	H1	BAE504D	ESS514	J1
	APS45		SPA115	F1	SAA101				ESS0039A	J1
			SPA101	F1	SAA101				ESS514	J1
						SAG076	H1	BAE680AG		
			SPA101	F1	SAA101	SEN8I	H1			
					SAA101				ESS0039A	J1
	PRT03/04		ATS04-1	F2						
	PRT03/04		ATS04-1	F2		SEN8D	H1			
			SZA103	F1						



KW



TYPE



TYPE

FIAT

TEMPRA S.W. (159)

1.8 i.e. (159.AN)	Petrol	77	03/92 → 12/93					
1.8 i.e. (159.AN)	Petrol	81	01/92 → 08/96					
1.8 i.e. (159.AN)	Petrol	81	01/92 → 08/96					
1.8 i.e. (159.AV)	Petrol	76	09/93 → 08/96				B02	B1
1.8 i.e. (159.AV)	Petrol	76	09/93 → 08/96				KITEC1/02	B2
1.8 i.e. (159.AV)	Petrol	76	09/93 → 08/96				KITPF1C	B6
1.8 i.e. (159.AV)	Petrol	76	09/93 → 08/96					
1.8 i.e. (159.AZ)	Petrol	66	09/93 → 08/96				B02	B1
1.8 i.e. (159.AZ)	Petrol	66	09/93 → 08/96				KITPF1C	B6
1.8 i.e. (159.BY)	Petrol	74	10/94 → 08/96				B02	B1
1.8 i.e. (159.BY)	Petrol	74	10/94 → 08/96				KITEC1/02	B2
1.8 i.e. (159.BY)	Petrol	74	10/94 → 08/96				KITPF1C	B6
1.8 i.e. (159.BY)	Petrol	74	10/94 → 08/96					
1.9 D (159.AG)	Diesel	48	07/91 → 08/96					
1.9 TD (159.AI, 159.BI, 159.CU, 159.AU)	Diesel	66	07/91 → 02/95					
1.9 TD (159.AQ)	Diesel	59	03/92 → 06/93					
2.0 i.e. (159.AP)	Petrol	83	01/91 → 03/95					
2.0 i.e. 4x4 (159.AP)	Petrol	83	03/92 → 03/92					
2.0 i.e. 4x4 (159.AP)	Petrol	83	03/92 → 03/95					
2.0 i.e. 4x4 (159.AP)	Petrol	83	03/92 → 03/95					
2.0 i.e. 4x4 (159.AP)	Petrol	83	03/92 → 03/95					

TIPO (160)

1.4 (160.AC)	Petrol	52	07/87 → 12/89					
1.4 i.e.	Petrol	57	05/89 → 12/93	ENGINE: → 1125932				
1.4 i.e.	Petrol	57	04/93 → 04/95					
1.4 i.e. (160.AP, 160.AD, 160.EA)	Petrol	51	05/89 → 04/95					
1.4 i.e. (160.AP, 160.AD, 160.EA)	Petrol	51	05/89 → 04/95	ENGINE: → 1125932				
1.4 i.e. (160.AP, 160.AD, 160.EA)	Petrol	51	04/93 → 04/95					
1.4 i.e. (160.AP, 160.AD, 160.EA)	Petrol	51	10/93 → 04/95					
1.6 i.e.	Petrol	66	02/88 → 05/91					
1.6 i.e. (160.A1, 160.EC, 160.EB)	Petrol	55	10/92 → 04/95					
1.6 i.e. (160.A1, 160.EC, 160.EB)	Petrol	55	04/93 → 04/95					
1.6 i.e. (160.A1, 160.EC, 160.EB)	Petrol	55	03/93 → 04/95					
1.6 i.e. (160.AF)	Petrol	57	07/90 → 01/93					
1.6 i.e. (160.AF)	Petrol	57	07/90 → 01/93	ENGINE: → 1125932				
1.7 D (160.AG)	Diesel	45	04/93 → 10/95					
1.8 i.e.	Petrol	71	03/93 → 04/95				B02	B1
1.8 i.e.	Petrol	71	03/93 → 04/95				KITPF1C	B6
1.8 i.e.	Petrol	66	09/93 → 04/95				B02	B1
1.8 i.e.	Petrol	66	09/93 → 04/95				KITEC1/02	B2
1.8 i.e.	Petrol	66	09/93 → 04/95				KITPF1C	B6
1.8 i.e.	Petrol	81	10/90 → 06/93				B02	B1
1.8 i.e.	Petrol	81	10/90 → 06/93				KITPF1C	B6

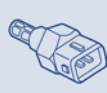
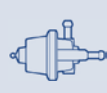

TYPE

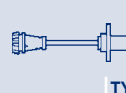

TYPE



TYPE

				WTS05-1	F1						
				SZA103	F1						
				WTS05-1	F1						
	PRT03/04	KITRPM36	ATS04-1	F2	SAA101	SAG026	H1	BAE800B	ESS0039A	J1	
		RPM36	SPA101	F1		SEN8I3	H1				
			SZA103	F1							
			WTS05-1	F1							
			SPA101	F1	SAA101	SAG026	H1		ESS0039A	J1	
	PRT03/04	KITRPM36	ATS04-1	F2	SAA101	SAG026	H1	BAE800B	ESS0039A	J1	
		RPM36	SPA101	F1		SEN8I3	H1				
			SZA103	F1							
			WTS05-1	F1							
			SPA101	F1	SAA101						
			SPA101	F1	SAA101						
			SPA101	F1	SAA101						
			SPA101	F1	SAA101	SAG026	H1		ESS0039A	J1	
	PRT03/04		ATS04-1	F2							
			SPA101	F1	SAA101	SAG026	H1				
			SZA103	F1		SEN8I	H1				
			WTS05-1	F1							
			SPA101	F1				BAE506D			
			SPA104	F1							
					SAA101						
			SPA101	F1		SEN8M	H1	BAE504D	ESS514	J1	
			SPA104	F1							
			SPA134	F1	SAA101						
						SAG076	H1	BAE680AG			
						SEN8M	H1	BAE504D	ESS0039A	J1	
			SPA101	F1							
					SAA101						
						SAG076	H1	BAE680AG			
			SPA101	F1					ESS514	J1	
			SPA104	F1							
					SAA101						
					SAA101						
	PRT03/04	KITRPM36	ATS04-1	F2	SAA101	SAG026	H1	BAE800B	ESS0039A	J1	
		RPM36	SPA101	F1		SEN8I3	H1				
			SZA103	F1							



KW



TYPE



TYPE

FIAT

TIPO (160)

1.8 i.e.	Petrol	66	09/93 → 04/95					
1.8 i.e. (160.ED)	Petrol	76	04/93 → 04/95			B02	B1	
1.8 i.e. (160.ED)	Petrol	76	04/93 → 04/95			KITEC1/02	B2	
1.8 i.e. (160.ED)	Petrol	76	04/93 → 04/95			KITPF1C	B6	
1.8 i.e. (160.ED)	Petrol	76	04/93 → 04/93					
1.8 i.e. (160.EQ, 160.AM)	Petrol	74	10/94 → 04/95			B02	B1	
1.8 i.e. (160.EQ, 160.AM)	Petrol	74	10/94 → 04/95			KITEC1/02	B2	
1.8 i.e. (160.EQ, 160.AM)	Petrol	74	10/94 → 04/95			KITPF1C	B6	
1.8 i.e. (160.EQ, 160.AM)	Petrol	74	10/94 → 04/95					
1.8 i.e. (160.EQ, 160.AM)	Petrol	74	10/94 → 04/95					
1.8 i.e. (160.EQ, 160.AM)	Petrol	74	10/94 → 10/95					
1.8 i.e. 16V Sport	Petrol	100	11/89 → 06/92					
1.9 D	Diesel	48	07/91 → 08/96					
1.9 D	Diesel	48	04/93 → 08/96					
1.9 TD (160.AW)	Diesel	59	03/92 → 06/93					
1.9 TD (160.EL, 160.GL, 160.AQ, 160.EI, 160.AR)	Diesel	66	09/90 → 04/95					
1.9 TD (160.EL, 160.GL, 160.AQ, 160.EI, 160.AR)	Diesel	66	04/93 → 04/95					
2.0 16V (160.AV)	Petrol	107	07/91 → 04/95					
2.0 16V (160.AV)	Petrol	107	07/91 → 04/95					
2.0 16V (160.AV)	Petrol	107	07/91 → 04/95					
2.0 16V (160.AV)	Petrol	107	07/91 → 04/95					
2.0 16V (160.AV)	Petrol	107	04/93 → 04/95					
2.0 i.e. (160.AJ)	Petrol	80	06/90 → 03/92					
2.0 i.e. (160.AT, 160.AJ)	Petrol	83	01/92 → 04/95					
2.0 i.e. (160.AT, 160.AJ)	Petrol	83	01/93 → 04/95					
2.0 i.e. (160.AT, 160.AJ)	Petrol	83	01/93 → 04/95					
2.0 i.e. (160.AT, 160.AJ)	Petrol	83	03/90 → 04/95					
2.0 i.e. (160.AT, 160.AJ)	Petrol	83	04/93 → 04/95					
2.0 i.e. 16V Sport (160.EF)	Petrol	102	03/93 → 04/93					
2.0 i.e. 16V Sport (160.EF)	Petrol	102	03/93 → 04/95					
2.0 i.e. 16V Sport (160.EF)	Petrol	102	03/93 → 04/95					
2.0 i.e. 16V Sport (160.EF)	Petrol	102	03/93 → 04/95					

ULYSSE (179AX)

2.0	Petrol	100	08/02 → 06/11	ENGINE: EW10J4	IAW48P2.34/2	A1		
2.0	Petrol	100	08/02 → 06/11					
2.0	Petrol	100	08/02 → 06/11					
2.0 D Multijet	Diesel	88	11/07 → 06/11	ENGINE: RHK		50CAD281	B3	
2.0 D Multijet	Diesel	100	05/06 → 06/11					
2.0 D Multijet	Diesel	100	05/06 → 06/11					
2.0 D Multijet	Diesel	88	05/06 → 06/11					
2.0 JTD	Diesel	80	08/02 → 08/06					
2.0 JTD	Diesel	79	05/03 → 08/06					



TYPE

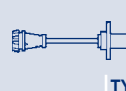

TYPE



TYPE

				WTS05-1	F1						
			KITRPM36	SPA101	F1	SAA101	SAG026	H1	BAE800B	ESS0039A	J1
			RPM36	SZA103	F1		SEN8I3	H1			
				WTS05-1	F1						
		PRT03/04		ATS04-1	F2						
			RPM36	SZA103	F1	SAA101					
		PRT03/04	KITRPM36	ATS04-1	F2		SEN8I3	H1	BAE800B		
				WTS05-1	F1						
										ESS0039A	J1
				SPA101	F1						
				SPA101	F1						
						SAA101					
				SPA101	F1						
				SPA101	F1						
						SAA101					
		PRT03/04		ATS04-1	F2					ESS0039A	J1
				SPA101	F1						
				SZA103	F1						
				WTS05-1	F1						
						SAA101					
				SPA101	F1						
		PRT03/04		ATS04-1	F2						
			KITRPM40	SZA103	F1		SEN8I	H1			
			RPM40	WTS05-1	F1						
				SPA101	F1		SAG026	H1		ESS0039A	J1
						SAA101					
		PRT03/04		ATS04-1	F2						
			KITRPM40	SPA101	F1	SAA101				ESS0039A	J1
			RPM40	SZA103	F1						
				WTS05-1	F1						
		APS62		SPA107	F1	SAA118	SAC070	H2			
							SAD033	H3			
				ATS22	F2	SAA118	SAC096	H2			
				SPA172	F1		SAG169	H1			
				SPA172	F1	SAA118	SAC096	H2			
		APS35				SAA118				SUA494	J2
				SPA172	F1	SAA118					



KW



TYPE



TYPE

FIAT

ULYSSE (179AX)

2.2 D Multijet	Diesel	125	03/08 → 06/11					
2.2 JTD	Diesel	94	08/02 → 06/03					
2.2 JTD	Diesel	94	08/02 → 08/06					
3.0	Petrol	150	08/02 → 06/11					

ULYSSE (220)

1.8 (220.BB5)	Petrol	73	05/97 → 08/02				B04	B1
1.8 (220.BB5)	Petrol	73	05/97 → 08/02				PF16080067	B6
1.8 (220.BB5)	Petrol	73	05/97 → 08/02	ENGINE: XU7JP				
1.8 (220.BB5)	Petrol	73	05/97 → 08/02	ENGINE: XU7JP				
1.8 (220.BB5)	Petrol	73	09/99 → 08/02					
1.8 (220.BB5)	Petrol	73	05/97 → 05/00					
1.8 (220.BB5)	Petrol	73	05/97 → 12/00	ENGINE: C(XU7JP)				
1.8 (220.BB5)	Petrol	73	05/97 → 12/01	ENGINE: ID(XU7JP)				
1.9 TD (220AH5)	Diesel	66	02/95 → 08/02					
1.9 TD (220AH5)	Diesel	66	09/99 → 08/02					
2.0 (220.AC5)	Petrol	89	06/94 → 08/02				B04	B1
2.0 (220.AC5)	Petrol	89	06/94 → 12/95				PF90/018	B6
2.0 (220.AC5)	Petrol	89	01/96 → 08/02				PF16080067	B6
2.0 (220.AC5)	Petrol	89	06/94 → 08/02	ENGINE: XU10J2CZ				
2.0 (220.AC5)	Petrol	89	06/94 → 08/02	ENGINE: XU10J2CZ				
2.0 (220.AC5)	Petrol	89	02/95 → 08/02					
2.0 (220.AC5)	Petrol	89	09/99 → 08/02					
2.0 (220.AC5)	Petrol	89	09/94 → 05/00					
2.0 (220.AC5)	Petrol	89	06/94 → 12/00	ENGINE: C(XU10J2-XU10J2TE-XU10J4R)				
2.0 16V	Petrol	97	05/98 → 12/98					
2.0 16V	Petrol	100	09/00 → 08/02					
2.0 16V	Petrol	97	05/98 → 09/00					
2.0 16V	Petrol	97	05/98 → 09/00					
2.0 16V	Petrol	97	09/99 → 09/00					
2.0 16V	Petrol	97	05/98 → 09/00	ENGINE: C(XU10J2-XU10J2TE-XU10J4R)				
2.0 JTD	Diesel	80	10/99 → 08/02					
2.0 JTD	Diesel	80	10/99 → 06/01					
2.0 JTD	Diesel	80	07/01 → 08/02					
2.0 Turbo (220.AD5)	Petrol	108	09/94 → 06/95				SVF015	B6
2.0 Turbo (220.AD5)	Petrol	108	06/94 → 08/02					
2.0 Turbo (220.AD5)	Petrol	108	02/95 → 08/02					
2.0 Turbo (220.AD5)	Petrol	108	09/99 → 08/02					
2.0 Turbo (220.AD5)	Petrol	108	09/94 → 05/00					



TYPE

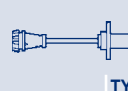

TYPE



TYPE

	APS58				SAA118	SAC096	H2		
	APS35				SAA118				
	APS62		SPA107	F1	SAA118	SAD008	H3	BAE680BD	
	PRT03E/04					SAG028	H1	ESS0095A	J1
		KITRPM36	SZA101	F1					
		RPM36				SAG027	H1		
								BAE680AF	
								SUA378	J2
								SUA461	J2
			SPA102	F1	SAA118	SAG028	H1	SUA146	J3
						SAG027	H1		
	PRT03E/04		SPA102	F1	SAA118	SAG028	H1	ESS0095A	J1
		KITRPM36	SZA101	F1					
		RPM36							
						SAG150	H1		
						SAG027	H1		
								BAE680AF	
								SUA378	J2
	APS76								
			SPA107	F1	SAA118	SAG027	H1		
					SAA118	SAD008	H3		
						SAG028	H1		
						SAG027	H1		
								SUA378	J2
	APS35		SPA107	F1	SAA118	SAG027	H1		
								SUA463	J2
								SUA494	J2
					SAA118	SAG028	H1	ESS0095A	J1
						SAG150	H1		
						SAG027	H1		
								BAE680AF	



KW

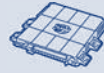

TYPE



TYPE

FIAT

UNO (146 A/E)

1.2	Petrol	44	08/00 → 04/10						
1.3 Super Diesel	Diesel	33	06/83 → 03/92						
1.3 Turbo i.e.	Petrol	73	01/87 → 12/87						
1.3 Turbo i.e.	Petrol	74	09/89 → 03/91						
1.3 Turbo i.e.	Petrol	77	04/85 → 08/89						
1.4 Turbo i.e.	Petrol	82	09/89 → 09/93						
1.4 Turbo i.e.	Petrol	82	09/89 → 09/93						
1.4 Turbo i.e.	Petrol	87	12/89 → 12/96						
1.6 R	Petrol	66	10/94 → 12/95						
1.9 D	Diesel	44	09/89 → 03/94						
45 0.9	Petrol	33	03/83 → 09/92						
45 1.0 (146A.ED)	Petrol	32	06/86 → 12/93						
45 i.e. 1.0	Petrol	33	04/84 → 10/95						
45 i.e. 1.0	Petrol	33	04/84 → 12/94						
45 i.e. 1.0	Petrol	33	01/86 → 12/94						
50 1.1	Petrol	37	01/90 → 12/93						
50 i.e. 1.1	Petrol	36	06/92 → 12/93						
55 1.0	Petrol	41	03/94 → 08/00				KITPF2C		B6
55 1.1	Petrol	40	01/83 → 08/89						
60 1.1	Petrol	42	04/89 → 12/92						
60 1.1 (146A.EG)	Petrol	43	05/85 → 08/89						
60 Diesel 1.7	Diesel	42	09/89 → 12/93						
60 Diesel 1.7	Diesel	44	07/86 → 08/89						
70 1.3	Petrol	50	01/83 → 04/85						
70 i.e. 1.4	Petrol	51	09/89 → 12/93						
70 i.e. 1.4	Petrol	51	09/89 → 12/93						
70 i.e. 1.4	Petrol	53	09/89 → 12/93						
70 S 1.4	Petrol	52	09/89 → 10/92						
75 i.e. 1.5	Petrol	55	10/85 → 12/93						
75 i.e. 1.5	Petrol	55	01/89 → 12/92						
75 i.e. 1.5	Petrol	55	09/89 → 12/93						

X 1/9 (128 AS)

1.3	Petrol	54	10/75 → 06/78						
1.3	Petrol	55	05/73 → 12/79						
1.5	Petrol	56	06/85 → 12/89						
1.5	Petrol	63	11/78 → 12/89						

FORD

B-MAX

1.6 TDCi	Diesel	70	10/12 →						
1.6 TDCi	Diesel	70	10/12 →	ENGINE: T3JB					
1.6 Ti	Petrol	77	10/12 →						
1.6 Ti	Petrol	77	03/13 →						

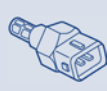
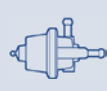

TYPE

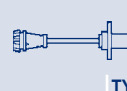

TYPE



TYPE

KIT IWP065

			SPA101	F1						
			SPA134	F1		SEN8D	H1			
			SPA104	F1		SEN8D	H1			
						SEN8D	H1			
			SPA101	F1		SEN8D	H1			
			SPA104	F1						
			SPA101	F1						
								BAE680AG		
			SPA101	F1						
			SPA101	F1	SAA107	SEN8D	H1			
			SPA101	F1						
			SPA134	F1					ESS273/1	J1
			SPA101	F1						
								BAE506D		
			SPA101	F1						
			SPA101	F1				BAE506D	ESS514	J1
			KITATS05	F2		CWM02/3	H1			
			SPA101	F1				BK2A		
			SPA101	F1						
			SPA101	F1				BAE506D		
			SPA101	F1						
			SPA101	F1				BK2A		
			SPA101	F1		SEN8M	H1	BAE504D	ESS514	J1
			SPA134	F1						
			SPA134	F1						
			SPA101	F1						
			SPA101	F1		SEN8D	H1	BAE504D	ESS514	J1
			SPA104	F1						
			SPA134	F1						

			SPA101	F1				BK2A		
								BK2A		
								BK2A		
								BK2A		

						SAG109	H1			
						SAC099	H2			

FEI0017								BAE680DX		
FEI0013										

KW

TYPE

TYPE
FORD
CAPRI III (GECP)

1.3 Petrol 40 01/78 → 06/85

C-MAX (DM2)

1.6 Petrol 74 03/07 → 07/10

1.6 Petrol 74 02/07 →

1.6 Petrol 74 02/07 →

1.6 TDCi Diesel 66 02/07 →

1.6 TDCi Diesel 80 02/07 →

1.6 TDCi Diesel 66 02/07 →

1.6 TDCi Diesel 80 02/07 →

1.8 Petrol 90 03/07 → 07/10

1.8 Petrol 92 03/07 → 07/10

1.8 Petrol 92 02/07 →

1.8 Petrol 92 02/07 →

1.8 Flexifuel Petrol/Ethanol 92 03/07 → 07/10

1.8 Flexifuel Petrol/Ethanol 92 02/07 →

1.8 Flexifuel Petrol/Ethanol 92 02/07 →

1.8 TDCi Diesel 85 02/07 →

1.8 TDCi Diesel 85 02/07 →

1.8 TDCi Diesel 85 02/07 → ENGINE: KKDA

2.0 Petrol 107 03/07 → 07/10

2.0 Petrol 107 02/07 →

2.0 Petrol 107 02/07 →

2.0 CNG Petrol/CNG 107 04/09 → 07/10

2.0 CNG Petrol/CNG 107 04/09 →

2.0 LPG Petrol/LPG 107 06/08 → 07/10

2.0 LPG Petrol/LPG 107 06/08 →

 2.0 TDCi Diesel 100 03/07 → 07/10 ENGINE: G6DA,G6DB,G6DD,G6DG **50CDDF4/1** B3

 2.0 TDCi Diesel 81 02/08 → ENGINE: IXDA **50CDSF5** B3

2.0 TDCi Diesel 100 02/07 →

2.0 TDCi Diesel 81 02/08 →

2.0 TDCi Diesel 100 02/07 →

2.0 TDCi Diesel 81 02/08 →

C-MAX II

1.6 Petrol 63 08/11 →

1.6 Petrol 63 12/10 →

1.6 Petrol 63 12/10 → ENGINE: XTDA

1.6 Flexifuel Petrol/Ethanol 88 02/11 →

COUGAR (EC_)

 2.0 16V Petrol 96 08/98 → 12/01 ENGINE: EDBA,EDBB,EDBC,EDBD **AMM19780** B4

2.0 16V Petrol 96 08/98 → 12/00

2.0 16V Petrol 96 08/98 → 12/01

2.0 16V Petrol 96 08/98 → 12/01



TYPE

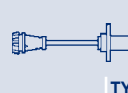

TYPE



TYPE

SAA112

FEI0017

	APS13				SAA115	SAC008	H1	BAE680DX		
						SAD037	H3			
	APS38	ATS22	F2	SAA118	SAC008		H1			
	APS38	ATS22	F2	SAA118	SAC008		H1			
						SAG167	H1			
						SAG167	H1			

FEI0014

	APS19				SAA115	SAC008	H1	BAE680DW		
						SAD036	H3			

FEI0009

	APS19				SAA115	SAC008	H1			
						SAD036	H3			
	APS78	ATS22	F2	SAA115	SAD041		H3			
		SPA158	F1			SAC074	H2			

FEI0014

	APS19					SAC008	H1	BAE680DW	GA2137	J2
						SAD036	H3			

FEI0014

	APS19									
--	-------	--	--	--	--	--	--	--	--	--

FEI0014

	APS19									
--	-------	--	--	--	--	--	--	--	--	--

FEI0014

	APS38	ATS22	F2	SAA118	SAC008		H1			
	APS38	ATS22	F2	SAA118	SAC096		H2			
						SAG169	H1			
						SAG169	H1			

FEI0013

								BAE680DX		
									GA2237	J2
								BAE680DX		

RP04A

		ATS24	F2	SAA113	SAC006		H1	BAE680BZ		
		SPA141	F1		SAG171		H1			



KW



TYPE



TYPE

FORD

COUGAR (EC_)

2.0 16V	Petrol	96	08/98 → 12/01	ENGINE: ZETEC-EFI					
2.5 ST 200	Petrol	151	01/00 → 12/01						
2.5 ST 200	Petrol	151	01/00 → 08/00						
2.5 V6 24V	Petrol	125	06/00 → 12/01						
2.5 V6 24V	Petrol	125	06/00 → 08/00						
2.5 V6 24V	Petrol	125	08/98 → 12/01						
2.5 V6 24V	Petrol	125	08/98 → 12/01						
2.5 V6 24V	Petrol	125	08/98 → 08/00						
2.5 V6 24V	Petrol	125	06/00 → 12/01						

COURIER Furgonato (F3L, F5L)

1.3	Petrol	44	09/91 → 02/96						
1.8 D	Diesel	44	09/91 → 02/96						

COURIER Furgonato (J5_, J3_)

1.3	Petrol	44	02/96 → 08/98			B3398	B1
1.3	Petrol	44	09/98 →			VAE3391	B2
1.3	Petrol	44	02/96 →				
1.3	Petrol	44	02/96 →	ENGINE: J4C			
1.8 D	Diesel	44	02/96 →				
1.8 Di	Diesel	55	09/00 →				

ECOSPORT

5.9 24V DIESEL AWD	Diesel	66	10/13 →	ENGINE: UGJE					
--------------------	--------	----	---------	--------------	--	--	--	--	--

ESCORT '86 Express (AVF)

1.3	Petrol	44	02/86 → 07/90				
1.4 i	Petrol	54	02/86 → 07/90				

ESCORT '95 Furgonato (AVL)

1.8 TD	Diesel	66	01/95 →				
1.8 Turbo D	Diesel	51	12/95 → 06/01				

ESCORT CLASSIC (AAL, ABL)

1.6 16V	Petrol	66	10/98 → 07/00			B3398	B1
1.6 16V	Petrol	66	10/98 → 07/00	ENGINE: ZETEC-E		SVF005	B6
1.6 16V	Petrol	66	10/98 → 07/00				
1.6 16V	Petrol	66	10/98 → 07/00				
1.8 TD	Diesel	66	10/98 → 07/00			AMM19657	B4
1.8 TD	Diesel	66	10/98 → 07/00				

ESCORT CLASSIC Turnier (ANL)

1.6 16V	Petrol	66	02/99 → 07/00			B3398	B1
1.6 16V	Petrol	66	02/99 → 07/00			SVF001	B6
1.6 16V	Petrol	66	02/99 → 07/00	ENGINE: ZETEC-E		SVF005	B6
1.8 TD	Diesel	66	02/99 → 07/00			AMM19657	B4
1.8 TD	Diesel	66	02/99 → 07/00			SVF001	B6

ESCORT III (GAA)

1.1	Petrol	37	08/83 → 12/85				
1.3	Petrol	51	09/80 → 12/85				
1.6 XR3i	Petrol	77	10/82 → 12/85				



TYPE



TYPE



TYPE

						SAG006	H1		
				ATS24	F2	SAC006	H1		
				SPA170	F1				
				ATS24	F2	SAC006	H1		
				SPA170	F1				
				ATS24	F2	SAC006	H1		
				SPA141	F1	SAG176	H1		
				SPA170	F1				
						SAC098	H2		
				SPA170	F1	SAA112			
						SAA112	SAG177	H1	
				SPA170	F1	SAA112	SAG176	H1	BAE680BZ
							SAC097	H2	
				SPA170	F1	SAA112	SAG176	H1	
				SPA158	F1	SAA113			
							SAC099	H2	
						SAA112			
						SAA112			
							SAG176	H1	
				SPA170	F1	SAA112	SAG176	H1	
				ATS24	F2	SAA112	SAC002	H2	
				SPA116	F1		SAG006	H1	
							SAG176	H1	
				ATS24	F2	SAA112	SAG176	H1	
				SPA170	F1				
				ATS24	F2	SAA112	SAC002	H2	
				SPA116	F1		SAG006	H1	
				ATS24	F2	SAA112	SAG176	H1	
				SPA170	F1				
						SAA112			
						SAA112			
						SAA112			



KW

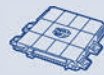

TYPE



TYPE

FORD

ESCORT III Cabriolet (ALD)

1.3	Petrol	51	09/83 → 12/85				
1.6 i	Petrol	77	09/83 → 12/85				

ESCORT III Station wagon (AWA)

1.1	Petrol	37	08/83 → 12/85				
1.3	Petrol	51	03/81 → 12/85				

ESCORT IV (GAF, AWF, ABFT)

1.1	Petrol	37	12/85 → 07/90				
1.1	Petrol	37	12/85 → 07/90	ENGINE: OHV,HCS			

ESCORT IV Cabriolet (ALF)

1.4	Petrol	54	02/87 → 07/90				
1.6 XR3i	Petrol	77	01/86 → 07/90				

ESCORT IV Station wagon (AWF, AVF)

1.3	Petrol	44	01/86 → 07/90				
1.4	Petrol	54	01/86 → 07/90				
1.8 D	Diesel	44	01/89 → 07/90				

ESCORT V (GAL)

1.3	Petrol	44	07/90 → 09/92				
1.3	Petrol	44	07/90 → 09/92	ENGINE: OHV,HCS			
1.4	Petrol	52	07/90 → 09/92				
1.4	Petrol	52	07/90 → 09/92				
1.4	Petrol	52	07/90 → 09/92	ENGINE: OHV,HCS			
1.6	Petrol	77	07/90 → 12/92				
1.6	Petrol	77	07/90 → 12/92				
1.6	Petrol	77	07/90 → 12/92	ENGINE: CVH			
1.8 16V XR3i	Petrol	77	02/92 → 12/92		SVF001	B6	
1.8 16V XR3i	Petrol	77	02/92 → 12/92	ENGINE: ZETEC-E	SVF006	B6	
1.8 16V XR3i	Petrol	96	02/92 → 12/92		SVF001	B6	
1.8 16V XR3i	Petrol	96	02/92 → 12/92	ENGINE: ZETEC-E	SVF006	B6	
1.8 16V XR3i	Petrol	77	02/92 → 12/92	ENGINE: ZETEC-EDOHCEFI			
1.8 16V XR3i	Petrol	96	02/92 → 12/92	ENGINE: ZETEC-EDOHCEFI			
1.8 D	Diesel	44	07/90 → 12/92				
RS 2000	Petrol	110	12/92 → 12/92		SVF001	B6	
RS 2000	Petrol	110	05/91 → 12/92				
RS 2000	Petrol	110	05/91 → 12/92				

ESCORT V Cabriolet (ALL)

1.4	Petrol	52	07/90 → 12/92		SVF001	B6	
1.4	Petrol	52	07/90 → 12/92				
1.4	Petrol	52	07/90 → 12/92	ENGINE: OHV,HCS			
1.6	Petrol	77	07/90 → 12/92				
1.6	Petrol	77	07/90 → 12/92				
1.6	Petrol	77	07/90 → 12/92	ENGINE: CVH			
1.8 16V XR3i	Petrol	77	02/92 → 12/92		SVF001	B6	
1.8 16V XR3i	Petrol	77	02/92 → 12/92	ENGINE: ZETEC-E	SVF006	B6	
1.8 16V XR3i	Petrol	96	02/92 → 12/92		SVF001	B6	



KW



TYPE



TYPE

FORD

ESCORT V Cabriolet (ALL)

1.8 16V XR3i	Petrol	96	02/92 → 12/92	ENGINE: ZETEC-E			SVF006	B6
1.8 16V XR3i	Petrol	77	02/92 → 12/92	ENGINE: ZETEC-EDOHCEFI				
1.8 16V XR3i	Petrol	96	02/92 → 12/92	ENGINE: ZETEC-EDOHCEFI				

ESCORT V Station wagon (GAL, AVL)

1.3	Petrol	44	09/91 → 09/92					
1.3	Petrol	44	09/91 → 09/92	ENGINE: OHV,HCS				
1.4	Petrol	52	07/90 → 09/92					
1.4	Petrol	52	07/90 → 09/92					
1.4	Petrol	52	07/90 → 09/92	ENGINE: OHV,HCS				
1.6	Petrol	77	07/90 → 09/92					
1.6	Petrol	77	07/90 → 09/92					
1.6	Petrol	77	07/90 → 09/92	ENGINE: CVH				
1.8 16V	Petrol	77	02/92 → 12/92				SVF001	B6
1.8 16V	Petrol	77	02/92 → 12/92	ENGINE: ZETEC-E			SVF006	B6
1.8 16V	Petrol	77	02/92 → 12/92	ENGINE: ZETEC-EDOHCEFI				
1.8 D	Diesel	44	07/90 → 12/92					
1.8 TD	Diesel	55	05/91 → 12/92					

ESCORT VI (GAL)

1.3	Petrol	44	12/92 → 04/94				SVF001	B6
1.3	Petrol	44	09/92 → 01/95					
1.3	Petrol	44	09/92 → 01/95	ENGINE: OHV,HCS				
1.4	Petrol	52	12/92 → 04/94				SVF001	B6
1.4	Petrol	55	01/94 → 01/95				AMM19766	B4
1.4	Petrol	55	01/94 → 04/94				SVF001	B6
1.4	Petrol	52	09/92 → 01/95					
1.4	Petrol	52	09/92 → 01/95					
1.6 i 16V	Petrol	65	01/94 → 01/95				AMM19766	B4
1.6 i 16V	Petrol	65	01/94 → 01/95				SVF001	B6
1.6 i 16V	Petrol	65	01/94 → 01/95	ENGINE: ZETEC-E			SVF006	B6
1.6 i 16V	Petrol	66	09/92 → 01/95				AMM19766	B4
1.6 i 16V	Petrol	66	09/92 → 01/95				SVF001	B6
1.6 i 16V	Petrol	66	09/92 → 01/95	ENGINE: ZETEC-E			SVF006	B6
1.6 i 16V	Petrol	66	09/92 → 01/95					
1.8 16V XR3i	Petrol	96	09/92 → 01/95				SVF001	B6
1.8 16V XR3i	Petrol	96	09/92 → 01/95	ENGINE: ZETEC-E			SVF006	B6
1.8 16V XR3i	Petrol	96	09/92 → 01/95					
1.8 16V XR3i	Petrol	96	09/92 → 01/95	ENGINE: ZETEC-EDOHCEFI				
1.8 D	Diesel	44	09/92 → 01/95					
1.8 i 16V	Petrol	77	09/92 → 01/95				SVF001	B6
1.8 i 16V	Petrol	77	09/92 → 01/95	ENGINE: ZETEC-E			SVF006	B6
1.8 i 16V	Petrol	77	09/92 → 01/95					
1.8 i 16V	Petrol	77	09/92 → 01/95					
1.8 TD	Diesel	66	02/93 → 01/95					
1.8 XR3i 16V 4x4	Petrol	77	08/93 → 01/95				SVF001	B6

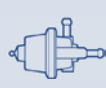

TYPE

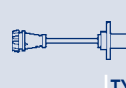

TYPE



TYPE

						SAC002	H2			
						SAC002	H2			
				ATS24	F2	SAA112	SAG176	H1		
							SAG005	H1		
				ATS24	F2	SAA112	SAG177	H1		
				SPA170	F1					
							SAG005	H1		
				ATS24	F2	SAA112	SAG177	H1	ESS0083A	J1
				SPA170	F1					
							SAG005	H1		
				ATS24	F2	SAA112	SAG006	H1	ESS0083A	J1
							SAC002	H2		
				ATS24	F2	SAA112	SAG176	H1		
				ATS24	F2					
				ATS24	F2	SAA112	SAG176	H1		
							SAG005	H1		
				ATS24	F2	SAA112	SAG176	H1		
				ATS24	F2	SAA112	SAG177	H1		
				SPA170	F1					
				ATS24	F2	SAA112	SAC002	H2		
							SAG006	H1		
				ATS24	F2	SAA112	SAC002	H2		
							SAG006	H1		
							SAG176	H1		
				ATS24	F2	SAA112	SAG006	H1		
							SAG177	H1		
							SAC002	H2		
				ATS24	F2	SAA112	SAG176	H1		
				ATS24	F2	SAA112	SAC002	H2		
							SAG006	H1		
							SAG177	H1		
				ATS24	F2		SAG176	H1		
				ATS24	F2	SAA112	SAG006	H1		



KW



TYPE



TYPE

FORD

ESCORT VI (GAL)

1.8 XR3i 16V 4x4	Petrol	77	08/93 → 01/95	ENGINE: ZETEC-E			SVF006	B6
1.8 XR3i 16V 4x4	Petrol	96	08/93 → 01/95				SVF001	B6
1.8 XR3i 16V 4x4	Petrol	96	08/93 → 01/95	ENGINE: ZETEC-E			SVF006	B6
1.8 XR3i 16V 4x4	Petrol	77	08/93 → 01/95					
1.8 XR3i 16V 4x4	Petrol	96	08/93 → 01/95					
1.8 XR3i 16V 4x4	Petrol	77	08/93 → 01/95	ENGINE: ZETEC-EDOHCEFI				
1.8 XR3i 16V 4x4	Petrol	96	08/93 → 01/95	ENGINE: ZETEC-EDOHCEFI				
RS 2000	Petrol	110	12/92 → 01/95				SVF001	B6
RS 2000	Petrol	110	09/92 → 01/95					
RS 2000	Petrol	110	09/92 → 01/95					
RS 2000	Petrol	110	09/92 → 12/94					
RS 2000 4x4	Petrol	110	08/93 → 01/95				SVF001	B6
RS 2000 4x4	Petrol	110	08/93 → 01/95					
RS 2000 4x4	Petrol	110	08/93 → 12/94					
RS Cosworth 4x4	Petrol	162	09/92 → 01/95					
RS Cosworth 4x4	Petrol	162	09/92 → 01/95					

ESCORT VI Cabriolet (ALL)

1.4	Petrol	52	12/92 → 04/94				SVF001	B6
1.4	Petrol	52	12/92 → 04/94					
1.4 i	Petrol	55	07/93 → 01/95				AMM19766	B4
1.4 i	Petrol	55	07/93 → 01/95	ENGINE: ZETEC-S			SVF006	B6
1.4 i	Petrol	55	07/93 → 04/94				SVF001	B6
1.4 i	Petrol	55	07/93 → 01/95					
1.6 16V XR3i	Petrol	66	12/92 → 01/95				AMM19766	B4
1.6 16V XR3i	Petrol	66	12/92 → 01/95				SVF001	B6
1.6 16V XR3i	Petrol	66	12/92 → 01/95	ENGINE: ZETEC-E			SVF006	B6
1.6 i 16V	Petrol	65	02/94 → 01/95				AMM19766	B4
1.6 i 16V	Petrol	65	02/94 → 01/95				SVF001	B6
1.8 16V XR3i	Petrol	77	12/92 → 01/95				SVF001	B6
1.8 16V XR3i	Petrol	77	12/92 → 01/95	ENGINE: ZETEC-E			SVF006	B6
1.8 16V XR3i	Petrol	96	12/92 → 01/95				SVF001	B6
1.8 16V XR3i	Petrol	96	12/92 → 01/95	ENGINE: ZETEC-E			SVF006	B6
1.8 16V XR3i	Petrol	77	12/92 → 01/95	ENGINE: ZETEC-EDOHCEFI				
1.8 16V XR3i	Petrol	96	12/92 → 01/95	ENGINE: ZETEC-EDOHCEFI				

ESCORT VI Station wagon (GAL)

1.3	Petrol	44	12/92 → 04/94				SVF001	B6
1.3	Petrol	44	09/92 → 01/95					
1.4	Petrol	52	12/92 → 01/94				SVF001	B6
1.4	Petrol	55	01/94 → 01/95				AMM19766	B4
1.4	Petrol	55	01/94 → 01/95				SVF001	B6
1.4	Petrol	55	01/94 → 01/95	ENGINE: ZETEC-S			SVF006	B6
1.4	Petrol	52	09/92 → 01/95					
1.4	Petrol	52	09/92 → 01/95					
1.6 i 16V	Petrol	65	01/94 → 01/95				AMM19766	B4

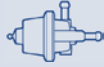

TYPE



TYPE



TYPE

				ATS24	F2	SAA112	SAG006	H1		
							SAG177	H1		
							SAG177	H1		
							SAC002	H2		
							SAC002	H2		
				ATS24	F2		SAG176	H1		
				SPA170	F1					
									BAE680BT	
				ATS24	F2		SAG007	H1		
				SPA170	F1		SAG176	H1		
									BAE680BT	
				ATS24	F2		SAG007	H1		ESS0083A
							SAG176	H1		J1
				ATS24	F2		SAG177	H1		
				SPA170	F1					
				ATS24	F2		SAG176	H1		
				SPA170	F1					
				ATS24	F2		SAC002	H2		
							SAG006	H1		
				ATS24	F2		SAG177	H1		
				ATS24	F2		SAG006	H1		
				ATS24	F2		SAG177	H1		
							SAC002	H2		
							SAC002	H2		
				ATS24	F2		SAG176	H1		
				ATS24	F2		SAG176	H1		
				SPA170	F1					
				ATS24	F2		SAG177	H1		
				SPA170	F1					
				ATS24	F2		SAG177	H1		



KW



TYPE



TYPE

FORD

ESCORT VI Station wagon (GAL)

1.6 i 16V	Petrol	65	01/94 → 01/95				SVF001	B6
1.6 i 16V	Petrol	66	09/92 → 01/95				AMM19766	B4
1.6 i 16V	Petrol	66	09/92 → 01/95				SVF001	B6
1.6 i 16V	Petrol	66	09/92 → 01/95	ENGINE: ZETEC-E			SVF006	B6
1.6 i 16V	Petrol	66	09/92 → 01/95					
1.8 D	Diesel	44	09/92 → 01/95					
1.8 i 16V	Petrol	77	01/93 → 01/95				SVF001	B6
1.8 i 16V	Petrol	77	01/93 → 01/95	ENGINE: ZETEC-E			SVF006	B6
1.8 i 16V	Petrol	96	02/93 → 01/95				SVF001	B6
1.8 i 16V	Petrol	96	02/93 → 01/95	ENGINE: ZETEC-E			SVF006	B6
1.8 i 16V	Petrol	77	01/93 → 01/95					
1.8 i 16V	Petrol	96	02/93 → 01/95					
1.8 TD	Diesel	66	02/93 → 01/95					

ESCORT VI Tre volumi (GAL)

1.3	Petrol	44	08/93 → 04/94				SVF001	B6
1.3	Petrol	44	08/93 → 01/95					
1.4	Petrol	52	08/93 → 04/94				SVF001	B6
1.4	Petrol	55	08/93 → 01/95				AMM19766	B4
1.4	Petrol	55	08/93 → 01/95	ENGINE: ZETEC-S			SVF006	B6
1.4	Petrol	55	08/93 → 04/94				SVF001	B6
1.4	Petrol	52	08/93 → 04/94					
1.4	Petrol	55	08/93 → 01/95					
1.6 i 16V	Petrol	65	01/94 → 01/95				AMM19766	B4
1.6 i 16V	Petrol	65	01/94 → 01/95				SVF001	B6
1.6 i 16V	Petrol	66	08/93 → 01/95				AMM19766	B4
1.6 i 16V	Petrol	66	08/93 → 01/95				SVF001	B6
1.6 i 16V	Petrol	66	08/93 → 01/95	ENGINE: ZETEC-E			SVF006	B6
1.6 i 16V	Petrol	66	08/93 → 01/95					
1.8 D	Diesel	44	08/93 → 01/95					
1.8 i 16V	Petrol	77	08/93 → 01/95				SVF001	B6
1.8 i 16V	Petrol	77	08/93 → 01/95	ENGINE: ZETEC-E			SVF006	B6
1.8 i 16V	Petrol	77	08/93 → 01/95					
1.8 i 16V	Petrol	77	08/93 → 01/95					
1.8 TD	Diesel	66	08/93 → 01/95					

ESCORT VII (GAL, AAL, ABL)

1.3	Petrol	44	01/95 → 10/98	ENGINE: HCS			SVF006	B6
1.3	Petrol	44	01/95 → 08/98				B3398	B1
1.3	Petrol	44	09/98 → 10/98				VAE3391	B2
1.3	Petrol	44	01/95 → 10/98					
1.3	Petrol	44	01/95 → 10/98					
1.3	Petrol	44	01/95 → 10/98	ENGINE: J6A,J4B				
1.3	Petrol	44	01/95 → 10/98	ENGINE: ZETEC-E				
1.3	Petrol	44	01/95 → 10/98	ENGINE: EFIZETEC-S				
1.3	Petrol	44	05/97 → 10/98	ENGINE: EFIHCSBL				

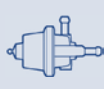

TYPE

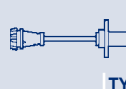

TYPE



TYPE

ATS24	F2	SAC002	H2
		SAG006	H1
		SAG176	H1
ATS24	F2	SAG176	H1
ATS24	F2	SAC002	H2
ATS24	F2	SAC002	H2
		SAG006	H1
		SAG006	H1
ATS24	F2	SAG176	H1

ATS24	F2	SAG176	H1
ATS24	F2	SAG177	H1
ATS24	F2	SAG176	H1
SPA170	F1		
SPA170	F1		
ATS24	F2	SAG177	H1
ATS24	F2	SAC002	H2
		SAG006	H1
		SAG176	H1
ATS24	F2	SAG176	H1
ATS24	F2	SAC002	H2
		SAG006	H1
		SAG177	H1
ATS24	F2	SAG176	H1

ATS24	F2	SAA112	SAG176	H1	BAE680AE
SPA170	F1		SAC097	H2	
			SAG006	H1	
			SAC003	H2	

SUA487

J1



KW

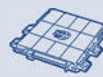

TYPE



TYPE

FORD

ESCORT VII (GAL, AAL, ABL)

1.4	Petrol	55	01/95 → 10/98				AMM19766	B4
1.4	Petrol	55	01/95 → 10/98					
1.4	Petrol	55	05/97 → 10/98	ENGINE: EFICVHPTEHL				
1.6 16V	Petrol	66	01/95 → 10/98				B3398	B1
1.6 16V	Petrol	66	01/95 → 10/98				SVF001	B6
1.6 16V	Petrol	66	01/95 → 10/98	ENGINE: ZETEC-E			SVF006	B6
1.6 16V	Petrol	66	08/95 → 10/98	ENGINE: ZETEC-E			SVF005	B6
1.6 16V	Petrol	66	01/95 → 04/98					
1.6 16V	Petrol	66	05/98 → 10/98					
1.6 16V	Petrol	66	05/97 → 10/98	ENGINE: EFIZETECZH				
1.6 16V 4x4	Petrol	66	01/95 → 10/98				B3398	B1
1.6 16V 4x4	Petrol	66	01/95 → 10/98				SVF001	B6
1.6 16V 4x4	Petrol	66	01/95 → 10/98	ENGINE: ZETEC-E			SVF006	B6
1.6 16V 4x4	Petrol	66	08/95 → 10/98	ENGINE: ZETEC-E			SVF005	B6
1.6 16V 4x4	Petrol	66	01/95 → 04/98					
1.6 16V 4x4	Petrol	66	05/98 → 10/98					
1.6 16V 4x4	Petrol	66	05/97 → 10/98	ENGINE: EFIZETECZH				
1.6 i 16V	Petrol	65	01/95 → 08/95				AMM19766	B4
1.6 i 16V	Petrol	65	01/95 → 08/95				B3398	B1
1.6 i 16V	Petrol	65	01/95 → 08/95				SVF001	B6
1.6 i 16V	Petrol	65	08/95 → 08/95	ENGINE: ZETEC-E			SVF005	B6
1.8 16V	Petrol	77	01/95 → 08/95				SVF001	B6
1.8 16V	Petrol	77	01/95 → 08/95	ENGINE: ZETEC-E			SVF006	B6
1.8 16V	Petrol	85	01/95 → 10/98				B3398	B1
1.8 16V	Petrol	85	01/95 → 10/98				SVF001	B6
1.8 16V	Petrol	85	01/95 → 10/98	ENGINE: ZETEC-E			AMM19657	B4
1.8 16V	Petrol	85	01/95 → 10/98	ENGINE: ZETEC-E			SVF006	B6
1.8 16V	Petrol	85	08/95 → 10/98	ENGINE: ZETEC-E			SVF005	B6
1.8 16V	Petrol	77	01/95 → 08/95					
1.8 16V	Petrol	85	01/95 → 04/98					
1.8 16V	Petrol	85	05/98 → 10/98					
1.8 16V	Petrol	77	01/95 → 08/95	ENGINE: ZETEC-EDOHCEFI				
1.8 16V	Petrol	85	01/95 → 10/98	ENGINE: ZETEC-EDOHCEFI				
1.8 16V	Petrol	85	05/97 → 10/98	ENGINE: EFIZETECZH18				
1.8 D	Diesel	44	01/95 → 12/96					
1.8 TD	Diesel	66	01/95 → 10/98	ENGINE: DIESEL18TI			AMM19657	B4
1.8 TD	Diesel	66	01/95 → 10/98					
1.8 TD	Diesel	66	01/95 → 10/98					
1.8 Turbo D	Diesel	51	12/95 → 10/98					
1.8 Turbo D	Diesel	51	12/95 → 10/98					
RS 2000	Petrol	110	02/95 → 02/98				SVF001	B6
RS 2000	Petrol	110	02/95 → 02/98					
RS 2000	Petrol	110	02/95 → 08/96					
RS 2000 4x4	Petrol	110	02/95 → 10/98				SVF001	B6



TYPE

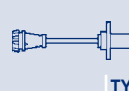

TYPE



TYPE

				ATS24	F2		SAG176	H1	BAE680AE	ESS0014A	J1
				SPA170	F1						
										SUA487	J1
				ATS24	F2	SAA112	SAC002	H2	BAE680AE	ESS0014A	J1
							SAG006	H1			
				SPA170	F1						
				SPA116	F1						
										SUA487	J1
				ATS24	F2	SAA112	SAC002	H2			
							SAG006	H1			
				SPA170	F1						
				SPA116	F1						
										SUA487	J1
				ATS24	F2		SAG177	H1		ESS0014A	J1
				SPA170	F1						
				ATS24	F2	SAA112	SAG006	H1		ESS0014A	J1
				ATS24	F2	SAA112	SAG006	H1	BAE680AE	ESS0014A	J1
				SPA170	F1						
				SPA170	F1						
				SPA116	F1						
							SAC002	H2			
							SAC002	H2			
										SUA487	J1
				ATS24	F2	SAA112	SAG176	H1			
				ATS24	F2	SAA112	SAG176	H1			
				SPA170	F1						
				ATS24	F2	SAA112	SAG176	H1			
				SPA170	F1						
				ATS24	F2	SAA112	SAG176	H1		ESS0014A	J1
				SPA170	F1						
									BAE680BT		
				ATS24	F2	SAA112	SAG007	H1			



KW



TYPE



TYPE

FORD

ESCORT VII (GAL, AAL, ABL)

RS 2000 4x4	Petrol	110	02/95 → 10/98					
RS 2000 4x4	Petrol	110	02/95 → 08/96					
RS Cosworth 4x4	Petrol	162	02/95 → 10/98					
RS Cosworth 4x4	Petrol	162	02/95 → 10/98					
RS Cosworth 4x4	Petrol	162	02/95 → 10/98					
RS Cosworth 4x4	Petrol	162	02/95 → 10/98					
RS Cosworth 4x4	Petrol	162	02/95 → 10/98					

ESCORT VII Cabriolet (ALL)

1.4	Petrol	55	02/95 → 08/98				AMM19766	B4
1.4	Petrol	55	02/95 → 08/98	ENGINE: ZETEC-S			SVF006	B6
1.4	Petrol	55	02/95 → 08/98					
1.4	Petrol	55	05/97 → 08/98	ENGINE: EFICVHPTEHL14				
1.6 16V XR3i	Petrol	65	02/95 → 12/96				AMM19766	B4
1.6 16V XR3i	Petrol	65	02/95 → 12/96				B3398	B1
1.6 16V XR3i	Petrol	65	02/95 → 12/96				SVF001	B6
1.6 16V XR3i	Petrol	65	02/95 → 12/96	ENGINE: ZETEC-E			SVF006	B6
1.6 16V XR3i	Petrol	65	08/95 → 12/96	ENGINE: ZETEC-E			SVF005	B6
1.6 16V XR3i	Petrol	66	02/95 → 09/99				B3398	B1
1.6 16V XR3i	Petrol	66	02/95 → 09/99				SVF001	B6
1.6 16V XR3i	Petrol	66	02/95 → 09/99	ENGINE: ZETEC-E			SVF006	B6
1.6 16V XR3i	Petrol	66	08/95 → 09/99	ENGINE: ZETEC-E			SVF005	B6
1.6 16V XR3i	Petrol	66	02/95 → 04/98					
1.6 16V XR3i	Petrol	66	05/98 → 09/99					
1.6 16V XR3i	Petrol	66	05/97 → 08/99	ENGINE: EFIZETECZH18				
1.8 16V XR3i	Petrol	77	02/95 → 08/98				SVF001	B6
1.8 16V XR3i	Petrol	77	08/95 → 08/98	ENGINE: ZETEC-E			SVF005	B6
1.8 16V XR3i	Petrol	85	10/95 → 08/98				B3398	B1
1.8 16V XR3i	Petrol	85	10/95 → 08/98				SVF001	B6
1.8 16V XR3i	Petrol	85	10/95 → 08/98	ENGINE: ZETEC-E			AMM19657	B4
1.8 16V XR3i	Petrol	85	10/95 → 08/98	ENGINE: ZETEC-E			SVF005	B6
1.8 16V XR3i	Petrol	96	02/95 → 08/00				SVF001	B6
1.8 16V XR3i	Petrol	96	08/95 → 08/00	ENGINE: ZETEC-E			SVF005	B6
1.8 16V XR3i	Petrol	77	02/95 → 04/98					
1.8 16V XR3i	Petrol	77	05/98 → 08/98					
1.8 16V XR3i	Petrol	85	10/95 → 04/98					
1.8 16V XR3i	Petrol	85	05/98 → 08/98					
1.8 16V XR3i	Petrol	96	02/95 → 08/00					
1.8 16V XR3i	Petrol	85	10/95 → 08/98	ENGINE: ZETEC-EDOHCEFI				
1.8 16V XR3i	Petrol	77	05/97 → 08/98	ENGINE: EFIZETECZH				
1.8 16V XR3i	Petrol	85	05/97 → 08/98	ENGINE: EFIZETECZH				
1.8 16V XR3i	Petrol	96	05/97 → 08/99	ENGINE: EFIZETECZH				
1.8 TD	Diesel	66	09/95 → 08/98				AMM19657	B4
1.8 TD	Diesel	66	09/95 → 08/98					



TYPE



TYPE



TYPE

				SPA170	F1						
										BAE680BT	
				ATS04-1	F2		SAG007	H1			
				ATS24	F2						
				SPA170	F1						
				SZA103	F1						
				WTS05-1	F1						
				ATS24	F2	SAA112	SAG176	H1		ESS0014A	J1
				SPA170	F1						
										SUA487	J1
				ATS24	F2	SAA112	SAC002	H2		ESS0014A	J1
				SPA170	F1		SAG006	H1			
				ATS24	F2	SAA112	SAC002	H2		ESS0014A	J1
							SAG006	H1			
				SPA170	F1						
				SPA116	F1						
										SUA487	J1
				ATS24	F2	SAA112	SAG177	H1		ESS0014A	J1
				ATS24	F2	SAA112	SAG006	H1		ESS0014A	J1
				ATS24	F2		SAG177	H1		ESS0014A	J1
				SPA170	F1						
				SPA116	F1						
				SPA170	F1						
				SPA116	F1						
				SPA170	F1						
							SAC002	H2			
										SUA487	J1
										SUA487	J1
										SUA487	J1
				ATS24	F2	SAA112	SAG176	H1			
				SPA170	F1						



KW



TYPE



TYPE

FORD

ESCORT VII Station wagon (GAL, ANL)

1.3	Petrol	44	01/95 → 01/99	ENGINE: HCS			SVF006	B6
1.3	Petrol	44	09/98 → 01/99				VAE3391	B2
1.3	Petrol	44	10/95 → 08/98				B3398	B1
1.3	Petrol	44	01/95 → 01/99					
1.3	Petrol	44	01/95 → 01/99					
1.3	Petrol	44	01/95 → 01/99	ENGINE: J6A,J4B				
1.3	Petrol	44	01/95 → 01/99	ENGINE: ZETEC-E				
1.3	Petrol	44	01/95 → 01/99	ENGINE: EFIZETEC-S				
1.3	Petrol	44	05/97 → 10/98	ENGINE: EFIHCSBL13				
1.4	Petrol	55	01/95 → 02/99				AMM19766	B4
1.4	Petrol	55	01/95 → 02/99					
1.4	Petrol	55	05/97 → 02/99	ENGINE: EFICVHPTEHL14				
1.6 16V	Petrol	66	01/95 → 02/99				B3398	B1
1.6 16V	Petrol	66	01/95 → 02/99				SVF001	B6
1.6 16V	Petrol	66	01/95 → 02/99	ENGINE: ZETEC-E			SVF006	B6
1.6 16V	Petrol	66	08/95 → 02/99	ENGINE: ZETEC-E			SVF005	B6
1.6 16V	Petrol	66	01/95 → 04/98					
1.6 16V	Petrol	66	05/98 → 02/99					
1.6 16V	Petrol	66	05/97 → 02/99	ENGINE: EFIZETECZH18				
1.6 i 16V	Petrol	65	01/95 → 08/95				AMM19766	B4
1.6 i 16V	Petrol	65	01/95 → 08/95				B3398	B1
1.6 i 16V	Petrol	65	01/95 → 08/95				SVF001	B6
1.6 i 16V	Petrol	65	08/95 → 08/95	ENGINE: ZETEC-E			SVF005	B6
1.8 16V	Petrol	77	01/95 → 08/95				SVF001	B6
1.8 16V	Petrol	77	01/95 → 08/95	ENGINE: ZETEC-E			SVF006	B6
1.8 16V	Petrol	85	01/95 → 02/99				SVF001	B6
1.8 16V	Petrol	85	01/95 → 02/99	ENGINE: ZETEC-E			AMM19657	B4
1.8 16V	Petrol	85	01/95 → 02/99	ENGINE: ZETEC-E			SVF006	B6
1.8 16V	Petrol	85	08/95 → 02/99	ENGINE: ZETEC-E			SVF005	B6
1.8 16V	Petrol	85	09/95 → 02/99				B3398	B1
1.8 16V	Petrol	77	01/95 → 08/95					
1.8 16V	Petrol	85	01/95 → 04/98					
1.8 16V	Petrol	85	05/98 → 02/99					
1.8 16V	Petrol	77	01/95 → 08/95	ENGINE: ZETEC-EDOHCEFI				
1.8 16V	Petrol	85	01/95 → 02/99	ENGINE: ZETEC-EDOHCEFI				
1.8 16V	Petrol	85	05/97 → 02/99	ENGINE: EFIZETECZH18				
1.8 D	Diesel	44	01/95 → 02/99					
1.8 TD	Diesel	66	01/95 → 02/99	ENGINE: DIESEL18T1			AMM19657	B4
1.8 TD	Diesel	66	01/95 → 02/99					
1.8 TD	Diesel	66	01/95 → 02/99					
1.8 Turbo D	Diesel	51	12/95 → 02/99					
1.8 Turbo D	Diesel	51	12/95 → 02/99					



KW



TYPE



TYPE

FORD

ESCORT VII Tre volumi (GAL, AFL)

1.3	Petrol	44	01/95 → 02/99	ENGINE: HCS13EFI		SVF006	B6
1.3	Petrol	44	09/98 → 02/99			VAE3391	B2
1.3	Petrol	44	10/95 → 08/98			B3398	B1
1.3	Petrol	44	01/95 → 02/99				
1.3	Petrol	44	01/95 → 02/99				
1.3	Petrol	44	01/95 → 02/99	ENGINE: J6A,J4B			
1.3	Petrol	44	01/95 → 02/99	ENGINE: ZETEC-E			
1.3	Petrol	44	01/95 → 02/99	ENGINE: EFIZETEC-S			
1.3	Petrol	44	05/97 → 02/99	ENGINE: EFIHCSBL13			
1.4	Petrol	55	01/95 → 02/99			AMM19766	B4
1.4	Petrol	55	01/95 → 02/99				
1.4	Petrol	55	05/97 → 02/99	ENGINE: EFICVHPTEHL14			
1.6 i 16V	Petrol	65	01/95 → 08/95			AMM19766	B4
1.6 i 16V	Petrol	65	01/95 → 08/95			B3398	B1
1.6 i 16V	Petrol	65	01/95 → 08/95			SVF001	B6
1.6 i 16V	Petrol	65	08/95 → 08/95	ENGINE: ZETEC-E		SVF005	B6
1.6 i 16V	Petrol	66	01/95 → 02/99			B3398	B1
1.6 i 16V	Petrol	66	01/95 → 02/99			SVF001	B6
1.6 i 16V	Petrol	66	01/95 → 02/99	ENGINE: ZETEC-E		SVF006	B6
1.6 i 16V	Petrol	66	08/95 → 02/99	ENGINE: ZETEC-E		SVF005	B6
1.6 i 16V	Petrol	66	01/95 → 04/98				
1.6 i 16V	Petrol	66	05/98 → 02/99				
1.6 i 16V	Petrol	66	05/97 → 02/99	ENGINE: EFIZETECZH16			
1.8 16V	Petrol	77	01/95 → 08/95			SVF001	B6
1.8 16V	Petrol	77	01/95 → 08/95	ENGINE: ZETEC-E		SVF006	B6
1.8 16V	Petrol	85	01/95 → 02/99			SVF001	B6
1.8 16V	Petrol	85	01/95 → 02/99	ENGINE: ZETEC-E		AMM19657	B4
1.8 16V	Petrol	85	01/95 → 02/99	ENGINE: ZETEC-E		SVF006	B6
1.8 16V	Petrol	85	08/95 → 02/99	ENGINE: ZETEC-E		SVF005	B6
1.8 16V	Petrol	85	09/95 → 02/99			B3398	B1
1.8 16V	Petrol	77	01/95 → 08/95				
1.8 16V	Petrol	85	01/95 → 04/98				
1.8 16V	Petrol	85	05/98 → 02/99				
1.8 16V	Petrol	85	01/95 → 02/99	ENGINE: ZETEC-EDOHCEFI			
1.8 16V	Petrol	85	05/97 → 02/99	ENGINE: EFIZETECZH18			
1.8 D	Diesel	44	01/95 → 12/96				
1.8 TD	Diesel	66	01/95 → 02/99	ENGINE: DIESEL18TI		AMM19657	B4
1.8 TD	Diesel	66	01/95 → 02/99				
1.8 TD	Diesel	66	01/95 → 02/99				
1.8 Turbo D	Diesel	51	12/95 → 02/99				
1.8 Turbo D	Diesel	51	12/95 → 02/99				

FIESTA Furgonato (FVD)

1.8 D (FVJ)	Diesel	43	03/89 → 12/95				
-------------	--------	----	---------------	--	--	--	--



KW



TYPE



TYPE

FORD

FIESTA Furgonato (JV_)

D 1.8 Diesel 44 05/98 →

FIESTA I (GFBT)

0.9 Petrol 29 05/76 → 08/83

0.9 Petrol 33 05/76 → 08/83

1.1 Petrol 39 05/76 → 08/83

1.3 Petrol 49 08/77 → 08/83

1.6 XR2 Petrol 62 08/81 → 08/83

FIESTA II (FBD)

1.1 (FBD) Petrol 36 05/86 → 02/89

1.1 (FBD) Petrol 37 09/83 → 02/89

1.3 (FBD) Petrol 51 09/83 → 01/87

1.4 (FBD) Petrol 54 02/87 → 02/89

1.4 (FBD) Petrol 55 10/85 → 11/89

1.6 D (FBD) Diesel 40 04/84 → 02/89

1.6 XR2 (FBD) Petrol 70 03/84 → 02/89

1.6 XR2 (FBD) Petrol 71 04/84 → 02/89

FIESTA III (GFJ)

1.0 Petrol 33 03/89 → 12/95

1.0 Petrol 33 04/93 → 12/95 ENGINE: EFIHCSBL10

1.1 Petrol 37 12/92 → 12/95 SVF001 B6

1.1 Petrol 40 12/92 → 12/95 SVF001 B6

1.1 Petrol 37 03/89 → 12/95

1.1 Petrol 37 03/89 → 08/95

1.1 Petrol 40 03/89 → 12/95

1.3 Petrol 44 03/89 → 12/92

1.3 Petrol 44 03/89 → 12/95

1.3 Petrol 44 03/89 → 12/92 ENGINE: ZETEC-E

1.3 Cat. Petrol 44 05/91 → 01/97

1.3 Cat. Petrol 44 05/91 → 08/95

1.3 Cat. Petrol 44 05/91 → 12/95 ENGINE: ZETEC-E

1.4 Petrol 52 12/92 → 12/95 SVF001 B6

1.4 Petrol 54 12/92 → 12/95 SVF001 B6

1.4 Petrol 54 03/89 → 12/95

1.4 Petrol 52 03/89 → 12/95

1.4 Petrol 52 03/89 → 12/95

1.4 Petrol 55 11/92 → 12/96

1.4 Cat. Petrol 54 03/89 → 12/95 AMM19766 B4

1.4 Cat. Petrol 54 03/89 → 12/95 ENGINE: ZETEC-S SVF006 B6

1.4 Cat. Petrol 54 12/92 → 12/95 SVF001 B6

1.4 Cat. Petrol 54 01/94 → 12/95

1.4 Cat. Petrol 54 04/93 → 12/95 ENGINE: EFICVHHL14

1.6 Petrol 65 12/92 → 01/94 SVF001 B6

1.6 Petrol 65 01/89 → 01/94

1.6 Petrol 66 03/89 → 12/92

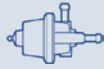

TYPE

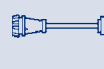

TYPE



TYPE

			SPA170	F1	SAA112	SAG006	H1		
					SAA112				
					SAA112				
					SAA112				
					SAA112				
					SAA112				
					SAA112				
					SAA112				
					SAA112				
					SAA112				
					SAA112				
					SAA112				
			ATS24	F2					
								SUA487	J1
			ATS24	F2	SAA112	SAG006	H1	BAE680AE	
			SPA170	F1					
			ATS24	F2	SAA112	SAG177	H1		
			ATS24	F2		SAG177	H1		
			ATS24	F2		SAG177	H1		
						SAG006	H1		
			ATS24	F2	SAA112				
			SPA170	F1					
						SAG006	H1		
			ATS24	F2	SAA112	SAG177	H1		
			ATS24	F2	SAA112	SAG177	H1	BAE680AE	
			SPA170	F1					
			ATS24	F2					
			ATS24	F2	SAA112	SAG177	H1		
			SPA151	F1					
								SUA487	J1
			ATS24	F2	SAA112	SAG177	H1		
			ATS24	F2		SAG177	H1		



KW

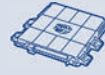

TYPE



TYPE

FORD

FIESTA III (GFJ)

1.6	Petrol	65	04/93 → 01/94	ENGINE: EFIZETECZH16				
1.6 i 16V	Petrol	65	01/94 → 12/95				AMM19766	B4
1.6 i 16V	Petrol	65	01/94 → 12/95				SVF001	B6
1.6 i 16V	Petrol	65	01/94 → 12/95	ENGINE: ZETEC-E			SVF006	B6
1.6 i 16V	Petrol	65	01/94 → 12/95	ENGINE: EFIZETECZH16				
1.6 XR2i	Petrol	76	12/92 → 03/93				SVF001	B6
1.6 XR2i	Petrol	81	12/92 → 01/94				SVF001	B6
1.6 XR2i	Petrol	76	03/89 → 03/93					
1.6 XR2i	Petrol	81	03/89 → 01/94					
1.8 16V	Petrol	77	02/92 → 12/95				SVF001	B6
1.8 16V	Petrol	77	02/92 → 12/95	ENGINE: ZETEC-E			SVF006	B6
1.8 16V	Petrol	77	09/95 → 12/95				B3398	B1
1.8 16V	Petrol	77	02/92 → 12/95					
1.8 16V	Petrol	77	02/92 → 12/95	ENGINE: ZETEC-EDOHCEFI				
1.8 16V	Petrol	77	02/92 → 12/95	ENGINE: EFIZETECZH18				
1.8 D	Diesel	44	03/89 → 12/95					
1.8 D	Diesel	44	03/89 → 12/95					
1.8 TD	Diesel	55	03/93 → 12/95					
1.8 TD	Diesel	55	03/93 → 12/95					
1.8 XR2i 16V	Petrol	96	02/92 → 12/95				SVF001	B6
1.8 XR2i 16V	Petrol	96	02/92 → 12/95	ENGINE: ZETEC-E			SVF006	B6
1.8 XR2i 16V	Petrol	96	08/95 → 12/95				B3398	B1
1.8 XR2i 16V	Petrol	96	02/92 → 12/95					
1.8 XR2i 16V	Petrol	96	02/92 → 12/95	ENGINE: ZETEC-EDOHCEFI				
1.8 XR2i 16V	Petrol	96	02/92 → 12/95	ENGINE: EFIZETECZH18				

FIESTA IV (JA_, JB_)

1.0 i	Petrol	38	02/97 → 09/99				SVF006	B6
1.0 i	Petrol	38	02/97 → 08/98				B3398	B1
1.0 i	Petrol	48	09/99 → 01/02					
1.0 i	Petrol	38	02/97 → 09/99	ENGINE: ZH10JRB				
1.0 i	Petrol	38	02/97 → 09/99	ENGINE: EFIHCSBL10				
1.0 i	Petrol	48	09/99 → 01/02	ENGINE: EFIHCSBL10				
1.1	Petrol	37	09/95 → 12/96					
1.25 i 16V	Petrol	55	08/95 → 12/99	ENGINE: ZETEC-S			SVF006	B6
1.25 i 16V	Petrol	55	12/96 → 01/02	ENGINE: ZETEC-S			SVF008	B6
1.25 i 16V	Petrol	55	01/97 → 12/99					
1.25 i 16V	Petrol	55	01/00 → 01/02					
1.25 i 16V	Petrol	55	08/95 → 01/02					
1.25 i 16V	Petrol	55	08/95 → 01/02	ENGINE: ZETEC-S				
1.25 i 16V	Petrol	55	11/95 → 12/99					
1.25 i 16V	Petrol	55	08/95 → 01/02					
1.25 i 16V	Petrol	55	08/95 → 01/02					
1.25 i 16V	Petrol	55	08/95 → 01/02	ENGINE: ZETEC-S				

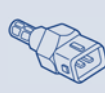

TYPE

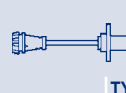

TYPE



TYPE

									SUA487	J1
			ATS24	F2	SAA112	SAC002	H2	BAE680AE		
			SPA151	F1		SAG006	H1			
									SUA487	J1
			ATS24	F2	SAA112	SAG177	H1			
			ATS24	F2	SAA112					
			ATS24	F2		SAG006	H1	BAE680AE		
			SPA151	F1						
						SAC002	H2			
									SUA487	J1
			ATS24	F2	SAA112	SAG177	H1			
			SPA151	F1						
			ATS24	F2						
			SPA151	F1						
			ATS24	F2		SAG006	H1			
			SPA170	F1						
						SAC002	H2			
									SUA487	J1
			ATS24	F2	SAA112	SAG006	H1			
			ATS24	F2						
						SAC097	H2			
						SAC097	H2			
									SUA487	J1
									SUA487	J1
			ATS24	F2						
FEI0012										
FEI0017										
	APS18		ATS24	F2	SAA112	SAC004	H2	BAE680AE	ESS0030A	J1
	APS17					SAC003	H2			
		RP08A								
			SPA154	F1		SAG006	H1			
						SAG176	H1			
						SAG008	H1			



KW



TYPE



TYPE

FORD

FIESTA IV (JA_, JB_)

1.25 i 16V	Petrol	55	08/95 → 11/99	ENGINE: DHA, DHB, DHC, DHD, DHE, DHF, DHG				
1.25 i 16V	Petrol	55	08/95 → 01/02	ENGINE: EFIZETECZH12				
1.3	Petrol	42	04/96 → 08/99					
1.3 i	Petrol	37	08/95 → 01/02	ENGINE: HCS13EFI			SVF006	B6
1.3 i	Petrol	37	08/95 → 08/98				B3398	B1
1.3 i	Petrol	37	09/98 → 01/02				VAE3391	B2
1.3 i	Petrol	44	08/95 → 01/02	ENGINE: HCS13EFI			SVF006	B6
1.3 i	Petrol	44	08/95 → 08/98				B3398	B1
1.3 i	Petrol	44	09/98 → 01/02				VAE3391	B2
1.3 i	Petrol	37	08/95 → 01/02					
1.3 i	Petrol	37	08/95 → 01/02					
1.3 i	Petrol	44	04/96 → 08/99					
1.3 i	Petrol	44	08/95 → 01/02					
1.3 i	Petrol	44	08/95 → 01/02					
1.3 i	Petrol	37	08/95 → 01/02	ENGINE: JJA,JJC,JJE,JJJ,JKK,JJM				
1.3 i	Petrol	37	08/95 → 01/02	ENGINE: ZETEC-E				
1.3 i	Petrol	37	08/95 → 01/02	ENGINE: EFIZETEC-S				
1.3 i	Petrol	44	08/95 → 01/02	ENGINE: JBC,J4C,J4J,J4L,J4Q,J4R,J4T				
1.3 i	Petrol	44	08/95 → 01/02	ENGINE: ZETEC-E				
1.3 i	Petrol	44	08/95 → 01/02	ENGINE: EFIZETEC-S				
1.3 i	Petrol	37	08/95 → 01/02	ENGINE: EFIHCSBL13				
1.3 i	Petrol	44	08/95 → 01/02	ENGINE: EFIHCSBL13				
1.6 16V Sport	Petrol	76	02/00 → 01/02				SVF001	B6
1.6 16V Sport	Petrol	76	02/00 → 01/02					
1.6 16V Sport	Petrol	76	02/00 → 01/02	ENGINE: L1T,L1V				
1.6 16V Sport	Petrol	76	02/00 → 01/02	ENGINE: ZETECEFI				
1.6 16V Sport	Petrol	76	02/00 → 01/02	ENGINE: EFIZETECZH16				
1.8 D	Diesel	44	08/95 → 04/00					
1.8 D	Diesel	44	08/95 → 04/00					
1.8 Di	Diesel	55	04/00 → 01/02					
1.8 Di	Diesel	55	04/00 → 01/02					
1.8 Di	Diesel	55	04/00 → 01/02	ENGINE: RTN,RTP,RTQ				

FIESTA V (JH_, JD_)

1.25 16V	Petrol	51	03/03 → 06/08	ENGINE: ZETEC-S			SVF008	B6
1.25 16V	Petrol	55	05/02 → 06/08	ENGINE: ZETEC-S			SVF008	B6
1.25 16V	Petrol	51	03/03 → 06/08					
1.25 16V	Petrol	55	12/02 → 06/08					
1.25 16V	Petrol	55	05/02 → 06/08					
1.25 16V	Petrol	55	05/02 → 06/08					
1.25 16V	Petrol	51	02/05 → 06/08					
1.25 16V	Petrol	55	08/07 → 06/08					



TYPE



TYPE



TYPE

						SAC097	H2		
								SUA487	J1
			ATS24	F2					
	APS17								
	APS17								
			ATS24	F2	SAA112	SAG176	H1	BAE680AE	
			SPA154	F1					
			ATS24	F2					
			ATS24	F2	SAA112	SAG176	H1	ESS0030A	J1
			SPA154	F1					
						SAC097	H2		
						SAG006	H1		
						SAC003	H2		
						SAC097	H2		
						SAG006	H1		
						SAC003	H2		
								SUA487	J1
								SUA487	J1
FEI0017	APS13		ATS24	F2	SAA112	SAC089	H2		
			SPA113	F1		SAG006	H1		
						SAC097	H2		
						SAC003	H2		
								SUA487	J1
			ATS24	F2	SAA112	SAG006	H1		
			SPA154	F1		SAG176	H1		
			ATS24	F2	SAA113	SAG006	H1		
			SPA133	F1					
						SAC074	H2		
						SAG008	H1		
						SAG008	H1		
FEI0017	APS13		SPA170	F1	SAA112	SAD037	H3		
FEI0017									
	APS13		SPA170	F1	SAA112	SAD037	H3		
						SAG170	H1		
								BAE680DX	
								BAE680DX	



KW



TYPE



TYPE

FORD

FIESTA V (JH_, JD_)

1.25 16V	Petrol	51	03/03 → 06/08	ENGINE: M7JA,M7JB				
1.25 16V	Petrol	55	12/02 → 06/08	ENGINE: FUJA,FUJB				
1.3	Petrol	44	11/01 → 06/08	ENGINE: ROCAM13SOHC		SVF008	B6	
1.3	Petrol	51	11/01 → 06/08	ENGINE: ROCAM13SOHC		SVF008	B6	
1.3	Petrol	44	11/01 → 06/08					
1.3	Petrol	51	11/01 → 06/08					
1.3	Petrol	44	11/01 → 06/08	ENGINE: ZETECROCAM13SOHC				
1.3	Petrol	51	11/01 → 06/08	ENGINE: ZETECROCAM13SOHC				
1.3	Petrol	44	08/07 → 06/08					
1.3	Petrol	44	11/01 → 06/08	ENGINE: BAJA				
1.3	Petrol	51	11/01 → 06/08	ENGINE: A9JA,A9JB				
1.4 16V	Petrol	59	11/01 → 06/08					
1.4 16V	Petrol	59	11/01 → 06/08					
1.4 16V	Petrol	59	02/05 → 06/08					
1.4 16V	Petrol	59	11/01 → 06/08	ENGINE: FXJA,FXJB				
1.4 TDCi	Diesel	50	11/01 → 06/08			AMM19765	B4	
1.4 TDCi	Diesel	50	02/04 → 06/08	ENGINE: DURATORQ14TDCI		AMM19651	B4	
1.4 TDCi	Diesel	50	11/01 → 06/08					
1.6 16V	Petrol	74	11/01 → 06/08			SVF001	B6	
1.6 16V	Petrol	74	11/01 → 06/08					
1.6 16V	Petrol	74	02/05 → 06/08					
1.6 16V	Petrol	74	11/01 → 06/08	ENGINE: FYJA,FYJB				
1.6 TDCi	Diesel	66	11/04 → 06/08	ENGINE: DURATORQ16TDCI		AMM19654	B4	
1.6 TDCi	Diesel	66	11/04 → 06/08					
1.6 TDCi	Diesel	66	11/04 → 06/08					
ST150	Petrol	110	03/05 → 06/08					
ST150	Petrol	110	03/05 → 06/08					
ST150	Petrol	110	03/05 → 06/08	ENGINE: DURATECDOHCEFI				

FIESTA Van

1.25	Petrol	60	01/09 →					
1.3	Petrol	51	10/03 →					
1.3	Petrol	51	10/03 → 09/08	ENGINE: A9JA,A9JB				
1.4 TDCi	Diesel	50	10/03 →					
1.4 TDCi	Diesel	50	10/03 →					
1.4 TDCi	Diesel	50	01/09 →					
1.4 TDCi	Diesel	51	07/10 →	ENGINE: F6JD,KVJA				
1.6 TDCi	Diesel	66	01/09 →					
1.6 TDCi	Diesel	70	02/10 →					
1.6 TDCi	Diesel	70	02/10 →	ENGINE: TZJA,TZJB				



TYPE



TYPE



TYPE

								GA2236	J2
								GA2236	J2
IWP119	APS13				SAA113	SAG170	H1	BAE680BZ	
IWP119	APS13		SPA153	F1	SAA113	SAG170	H1	BAE680BZ	
						SAG008	H1		
						SAG008	H1		
								BAE680DX	
								GA2236	J2
								GA2236	J2
FEI0017	APS13		SPA170	F1	SAA112	SAD037	H3	BAE680BZ	
						SAG008	H1		
								BAE680DX	
								GA2236	J2
			ATS22	F2	SAA118	SAG168	H1		
			SPA172	F1					
FEI0017	APS13		SPA170	F1	SAA112	SAD037	H3	BAE680BZ	
						SAG008	H1		
								BAE680DX	
								GA2236	J2
			ATS22	F2	SAA118	SAC096	H2		
			SPA172	F1		SAG168	H1		
FEI0014	APS19		SPA116	F1	SAA115	SAD036	H3	BAE680BO	
						SAG016	H2		
						SAC001	H2		
FEI0013								BAE680DX	
	APS13				SAA113			BAE680BZ	
								GA2236	J2
			ATS22	F2	SAA118	SAG168	H1		
			SPA172	F1					
						SAG168	H1		
						SAC099	H2		
						SAG167	H1		
						SAG167	H1		
						SAC099	H2		



KW

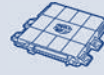

TYPE



TYPE

FORD

FIESTA VI

1.25	Petrol	44	06/08 →					
1.25	Petrol	60	06/08 →					
1.25	Petrol	44	06/08 →					
1.25	Petrol	60	06/08 →					
1.25	Petrol	44	06/08 →					
1.25	Petrol	60	06/08 →					
1.25	Petrol	44	06/08 →	ENGINE: STJB,STJA				
1.25	Petrol	60	06/08 →	ENGINE: SNJB,SNJA				
1.4	Petrol	71	06/08 →					
1.4	Petrol	71	06/08 →					
1.4	Petrol	71	06/08 →					
1.4	Petrol	71	06/08 →	ENGINE: SPJA,SPJC				
1.4 LPG	Petrol/LPG	71	05/09 → 11/12					
1.4 LPG	Petrol/LPG	71	01/09 →					
1.4 LPG	Petrol/LPG	71	01/09 →	ENGINE: RTJA,RTJB				
1.4 TDCi	Diesel	50	01/09 →	ENGINE: F6JB		AMM19770	B4	
1.4 TDCi	Diesel	51	07/10 →	ENGINE: F6JD,KVJA		AMM19770	B4	
1.4 TDCi	Diesel	50	01/09 →					
1.4 TDCi	Diesel	50	01/09 →					
1.4 TDCi	Diesel	51	07/10 →					
1.6	Petrol	70	06/08 →					
1.6 TDCi	Diesel	66	06/08 →					
1.6 TDCi	Diesel	66	06/08 →					
1.6 TDCi	Diesel	55	06/08 →					
1.6 TDCi	Diesel	70	02/10 →					
1.6 TDCi	Diesel	70	02/10 →	ENGINE: TZJA,TZJB,T3JA				
1.6 Ti	Petrol	88	06/08 → 11/12					
1.6 Ti	Petrol	99	01/11 → 11/12					
1.6 Ti	Petrol	88	06/08 →					
1.6 Ti	Petrol	88	06/08 →					
1.6 Ti	Petrol	88	06/08 →					
1.6 Ti	Petrol	99	12/10 →					

FOCUS (DAW, DBW)

1.4 16V	Petrol	55	10/98 → 11/04	ENGINE: ZETEC-S		SVF008	B6	
1.4 16V	Petrol	55	08/00 → 11/04			VAE3390	B2	
1.4 16V	Petrol	55	10/98 → 11/04					
1.4 16V	Petrol	55	10/98 → 11/04					
1.4 16V	Petrol	55	10/98 → 11/04					
1.4 16V	Petrol	55	10/98 → 11/04	ENGINE: FXDA,FXDC,FXDB,FXDD				
1.4 16V	Petrol	55	10/98 → 11/04	ENGINE: FXDA,FXDC,FXDB,FXDD				
1.4 16V	Petrol	55	10/98 → 11/04	ENGINE: ZETEC-S				



TYPE

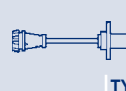

TYPE



TYPE

FEI0013	APS79				SAA115	SAC008	H1	BAE680DX		
FEI0013	APS79				SAA115	SAC008	H1	BAE680DX		
						SAD037	H3			
						SAD037	H3			
						SAG170	H1			
						SAG170	H1			
									GA2234	J2
									GA2234	J2
FEI0013	APS13				SAA115	SAC008	H1	BAE680DX		
						SAD037	H3			
						SAG170	H1			
									GA2234	J2
FEI0013	APS13							BAE680DX		
									GA2234	J2
						SAC099	H2			
						SAC008	H1			
						SAG168	H1			
						SAG109	H1			
								BAE680DX		
	APS38		ATS22	F2	SAA118	SAC008	H1			
			SPA172	F1		SAG167	H1			
						SAC008	H1			
						SAG167	H1			
						SAC099	H2			
FEI0017										
FEI0017	APS13				SAA115	SAC008	H1	BAE680DX		
						SAD037	H3			
						SAG170	H1			
								BAE680DX		
						SAC003	H2			
FEI0017	APS12		ATS24	F2	SAA112	SAC004	H2	BAE680BZ		
			SPA113	F1		SAD037	H3			
						SAG170	H1			
						SAC097	H2			
						SAG179	H1			
						SAG006	H1			



KW



TYPE



TYPE

FORD

FOCUS (DAW, DBW)

1.6 16V	Petrol	74	10/98 → 11/04	ENGINE: ZETECROCAM16SOHC			SVF008	B6
1.6 16V	Petrol	74	08/00 → 11/04				VAE3390	B2
1.6 16V	Petrol	74	10/98 → 11/04					
1.6 16V	Petrol	74	10/98 → 11/04					
1.6 16V	Petrol	74	10/98 → 11/04					
1.6 16V	Petrol	74	10/98 → 11/04					
1.6 16V	Petrol	74	10/98 → 11/04	ENGINE: FYDA,FYDC, FYDB,FYDD,FYDH				
1.6 16V	Petrol	74	10/98 → 11/04	ENGINE: FYDA,FYDC, FYDB,FYDD,FYDH				
1.6 16V	Petrol	74	10/98 → 11/04	ENGINE: ZETECEFI				
1.6 16V Flexifuel	Petrol/Ethanol	75	01/02 → 11/04					
1.8 16V	Petrol	85	10/98 → 11/04				VAE3391	B2
1.8 16V	Petrol	85	10/98 → 11/04	ENGINE: EYDC,EYDB, EYDD,EYDE,EYDF,EYDG, EYDI,EYDJ,EYDL			AMM19780	B4
1.8 16V	Petrol	85	10/98 → 11/04					
1.8 16V	Petrol	85	10/98 → 11/04					
1.8 16V	Petrol	85	10/98 → 11/04					
1.8 16V	Petrol	85	10/98 → 11/04	ENGINE: ZETEC-EDOHCEFI				
1.8 DI / TDDi	Diesel	55	08/99 → 11/04					
1.8 DI / TDDi	Diesel	55	08/99 → 11/04					
1.8 DI / TDDi	Diesel	55	08/99 → 11/04	ENGINE: BHDA,BHDB				
1.8 DI / TDDi	Diesel	55	08/99 → 11/04	ENGINE: BHDA,BHDB				
1.8 TDCi	Diesel	74	08/02 → 09/03	ENGINE: DURATORQTDCI18				
1.8 TDCi	Diesel	85	03/01 → 09/03					
1.8 TDCi	Diesel	74	08/02 → 11/04					
1.8 TDCi	Diesel	74	08/02 → 11/04					
1.8 TDCi	Diesel	85	03/01 → 11/04					
1.8 TDCi	Diesel	85	03/01 → 11/04					
1.8 TDCi	Diesel	74	08/02 → 11/04					
1.8 TDCi	Diesel	74	08/02 → 11/04	ENGINE: FFDA				
1.8 TDCi	Diesel	74	08/02 → 11/04	ENGINE: FFDA				
1.8 TDCi	Diesel	85	03/01 → 11/04	ENGINE: F9DA,F9DB				
1.8 TDCi	Diesel	85	03/01 → 11/04	ENGINE: F9DA,F9DB				
1.8 TDCi	Diesel	85	03/01 → 11/04	ENGINE: DURATORQ18TDCI				
1.8 Turbo DI / TDDi	Diesel	66	10/98 → 11/04					
1.8 Turbo DI / TDDi	Diesel	66	10/98 → 11/04					
1.8 Turbo DI / TDDi	Diesel	66	10/98 → 11/04					
1.8 Turbo DI / TDDi	Diesel	66	10/98 → 11/04	ENGINE: C9DA,C9DB				
1.8 Turbo DI / TDDi	Diesel	66	10/98 → 11/04	ENGINE: C9DC,C9DA,C9DB				
2.0 16V	Petrol	96	10/98 → 11/04				VAE3391	B2



TYPE



TYPE



TYPE

FEI0017	APS12		ATS24	F2	SAA112	SAC008	H1	BAE680BZ
			SPA113	F1		SAD037	H3	
						SAG006	H1	
						SAG170	H1	
						SAC097	H2	
						SAG179	H1	
						SAC003	H2	
			ATS24	F2				
		RP04A	ATS24	F2	SAA113	SAC008	H1	BAE680BZ
						SAG179	H1	
						SAD038	H3	
						SAG006	H1	
						SAG170	H1	
						SAC002	H2	
	APS15		ATS24	F2	SAA113	SAC008	H1	
			SPA158	F1		SAG006	H1	
						SAC074	H2	
						SAG179	H1	
	APS15							
	APS11							
			ATS24	F2	SAA115	SAC008	H1	
			SPA158	F1		SAD040	H3	
			ATS24	F2	SAA115	SAC008	H1	
			SPA158	F1		SAD040	H3	
						SAG006	H1	
						SAC074	H2	
						SAG179	H1	
						SAC074	H2	
						SAG179	H1	
						SAG001	H1	
	APS15		ATS24	F2	SAA113	SAC008	H1	
			SPA158	F1		SAG006	H1	
						SAG170	H1	
						SAC074	H2	
						SAG179	H1	
		RP04A	ATS24	F2	SAA113	SAC008	H1	BAE680BZ



KW



TYPE



TYPE

FORD

FOCUS (DAW, DBW)

2.0 16V	Petrol	96	10/98 → 11/04	ENGINE: EDDC,EDDB,EDDD,EDDF			AMM19780	B4
2.0 16V	Petrol	96	10/98 → 11/04					
2.0 16V	Petrol	96	10/98 → 11/04	ENGINE: ZETEC2016VEFI				
2.0 16V	Petrol	96	10/98 → 11/04	ENGINE: ZETEC-EDOHCEFI				
RS	Petrol	158	10/02 → 11/04				SVF005	B6
RS	Petrol	158	10/02 → 11/04					
ST170	Petrol	127	03/02 → 11/04					
ST170	Petrol	127	03/02 → 11/04					
ST170	Petrol	127	03/02 → 11/04					

FOCUS C-MAX

1.6	Petrol	74	10/03 → 05/05	ENGINE: ZETEC-S			SVF008	B6
1.6	Petrol	74	10/03 → 03/07					
1.6	Petrol	74	10/03 → 03/07					
1.6	Petrol	74	10/03 → 03/07					
1.6	Petrol	74	10/03 → 03/07	ENGINE: ZETEC-S				
1.6	Petrol	74	03/05 → 03/07					
1.6	Petrol	74	10/03 → 03/07	ENGINE: HWDA,HWDB				
1.6 TDCi	Diesel	66	02/05 → 03/07				AMM19764	B4
1.6 TDCi	Diesel	66	02/05 → 03/07	ENGINE: DURATORQ16TDCI			AMM19654	B4
1.6 TDCi	Diesel	80	10/03 → 03/07				AMM19764	B4
1.6 TDCi	Diesel	80	10/03 → 03/07	ENGINE: DURATORQ16TDCI			AMM19654	B4
1.6 TDCi	Diesel	66	02/05 → 03/07					
1.6 TDCi	Diesel	80	10/03 → 03/07					
1.6 TDCi	Diesel	80	10/03 → 03/07					
1.6 Ti	Petrol	85	08/04 → 03/07					
1.6 Ti	Petrol	85	08/04 → 03/07					
1.6 Ti	Petrol	85	08/04 → 03/07					
1.6 Ti	Petrol	85	08/04 → 03/07	ENGINE: ZETECROCAM16SOHC				
1.6 Ti	Petrol	85	03/05 → 03/07					
1.8	Petrol	88	10/03 → 03/07	ENGINE: CSDA,CSDB			AMM19780	B4
1.8	Petrol	88	10/03 → 05/04					
1.8	Petrol	92	04/04 → 05/04					
1.8	Petrol	92	06/04 → 03/07					
1.8	Petrol	88	10/03 → 03/07					
1.8	Petrol	92	04/04 → 03/07					
1.8	Petrol	88	10/03 → 03/07					
1.8	Petrol	92	04/04 → 03/07					
1.8	Petrol	88	10/03 → 03/07					
1.8	Petrol	92	04/04 → 03/07					
1.8	Petrol	88	10/03 → 03/07					
1.8 Flexifuel	Petrol/Ethanol	92	01/06 → 03/07					



TYPE

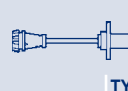

TYPE



TYPE

						SAG179	H1			
						SAG170	H1			
						SAG006	H1			
						SAC002	H2			
			ATS24	F2	SAA113	SAC002	H2	BAE680BZ		
						SAG006	H1			
			ATS24	F2	SAA113	SAC008	H1	BAE680BZ		
						SAD036	H3			
						SAG006	H1			
	FEI0017	APS13			SPA170	F1	SAA115	SAC008	H1	
								SAD037	H3	
								SAG170	H1	
								SAG008	H1	
										BAE680DX
										GA2235
					ATS22	F2	SAA118	SAC008	H1	J2
					ATS22	F2	SAA118	SAC008	H1	
					SPA172	F1		SAG167	H1	
					SPA172	F1		SAC096	H2	
								SAG167	H1	
	FEI0017	APS13			SPA170	F1	SAA115	SAC008	H1	
								SAC092	H2	
								SAD037	H3	
								SAG168	H1	
								SAG008	H1	
										BAE680DX
										GA2235
										J2
	FEI0011									
	FEI0011									
	FEI0014									
		APS19			SPA116	F1	SAA115	SAC001	H2	BAE680DW
		APS19			SPA116	F1	SAA115	SAC001	H2	BAE680DW
								SAD036	H3	
								SAD036	H3	
								SAG016	H2	
								SAG016	H2	
								SAG170	H1	
	FEI0009	APS19					SAA115	SAC001	H2	



KW



TYPE



TYPE

FORD

FOCUS C-MAX

1.8 Flexifuel	Petrol/Ethanol	92	01/06 → 03/07					
1.8 Flexifuel	Petrol/Ethanol	92	01/06 → 03/07					
1.8 Flexifuel	Petrol/Ethanol	92	01/06 → 03/07	ENGINE: Q7DA				
1.8 TDCi	Diesel	85	01/05 → 03/07				AMM19764	B4
1.8 TDCi	Diesel	85	01/05 → 03/07					
2.0	Petrol	107	04/04 → 03/07					
2.0	Petrol	107	03/04 → 03/07					
2.0	Petrol	107	03/04 → 03/07					
2.0 TDCi	Diesel	100	10/03 → 03/07	ENGINE: G6DA			50CDDF4/1	B3
2.0 TDCi	Diesel	100	10/03 → 03/07					
2.0 TDCi	Diesel	100	10/03 → 03/07					
2.0 TDCi	Diesel	100	10/03 → 03/07					

FOCUS II (DA_)

1.4	Petrol	59	11/04 → 12/11					
1.4	Petrol	59	11/04 →					
1.4	Petrol	59	11/04 →					
1.4	Petrol	59	11/04 →					
1.4	Petrol	59	11/04 →	ENGINE: ZETECROCAM16SOHC				
1.4	Petrol	59	03/05 →					
1.6	Petrol	74	11/04 → 12/11					
1.6	Petrol	74	11/04 →					
1.6	Petrol	74	11/04 →					
1.6	Petrol	74	11/04 →					
1.6	Petrol	74	11/04 →	ENGINE: ZETEC-S				
1.6	Petrol	74	03/05 →					
1.6	Petrol	74	11/04 →	ENGINE: HWDA,HWDB,SHDA				
1.6 LPG	Petrol/LPG	85	10/09 → 12/11					
1.6 LPG	Petrol/LPG	85	10/09 →					
1.6 TDCi	Diesel	80	11/04 →				AMM19764	B4
1.6 TDCi	Diesel	80	11/04 →	ENGINE: DURATORQ16TDCI			AMM19654	B4
1.6 TDCi	Diesel	66	01/05 →					
1.6 TDCi	Diesel	66	01/05 →					
1.6 TDCi	Diesel	80	11/04 →					
1.6 Ti	Petrol	85	11/04 →	ENGINE: ZETEC-S			AMM19652	B4
1.6 Ti	Petrol	85	11/04 → 12/11					
1.6 Ti	Petrol	85	11/04 →					
1.6 Ti	Petrol	85	11/04 →					
1.6 Ti	Petrol	85	11/04 →					
1.6 Ti	Petrol	85	11/04 →	ENGINE: ZETECROCAM16SOHC				
1.6 Ti	Petrol	85	03/05 →					
1.8	Petrol	92	03/06 → 12/11					
1.8	Petrol	92	03/06 →					

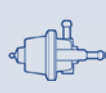

TYPE

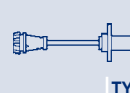

TYPE



TYPE

						SAD036	H3			
						SAG016	H2			
									GA2235	J2
	APS78		ATS22	F2	SAA115	SAC008	H1			
			SPA158	F1		SAD041	H3			
FEI0014										
	APS19		SPA116	F1	SAA115	SAD036	H3	BAE680DW		
						SAG016	H2			
			ATS22	F2	SAA118	SAC008	H1			
			SPA172	F1		SAC096	H2			
						SAG169	H1			
FEI0017										
	APS13		SPA170	F1	SAA115	SAC008	H1			
						SAD037	H3			
						SAG170	H1			
						SAG008	H1			
								BAE680DX		
FEI0017										
	APS13		SPA170	F1	SAA115	SAC008	H1			
						SAD037	H3			
						SAG170	H1			
						SAG008	H1			
								BAE680DX		
									GA2235	J2
FEI0017										
	APS13							BAE680DX		
			ATS22	F2	SAA118	SAC008	H1			
			ATS22	F2	SAA118	SAC008	H1			
			SPA172	F1		SAG167	H1			
			SPA172	F1		SAG167	H1			
FEI0017										
	APS13		SPA170	F1	SAA115	SAC008	H1			
						SAD037	H3			
						SAG168	H1			
						SAG008	H1			
								BAE680DX		
FEI0014										
	APS19							BAE680DW		



KW

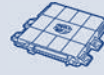

TYPE



TYPE

FORD

FOCUS II (DA_)

1.8 Flexifuel	Petrol/Ethanol	92	01/06 → 12/11						
1.8 Flexifuel	Petrol/Ethanol	96	12/05 → 01/08						
1.8 Flexifuel	Petrol/Ethanol	92	01/06 →						
1.8 Flexifuel	Petrol/Ethanol	92	01/06 →						
1.8 Flexifuel	Petrol/Ethanol	92	01/06 →						
1.8 Flexifuel	Petrol/Ethanol	96	12/05 →						
1.8 Flexifuel	Petrol/Ethanol	92	01/06 →	ENGINE: Q7DA					
1.8 TDCi	Diesel	85	01/05 →						
1.8 TDCi	Diesel	85	01/05 →						
1.8 TDCi	Diesel	85	01/05 →	ENGINE: KKDA, KKDB					
2.0	Petrol	104	06/05 → 09/08	ENGINE: AOD					
2.0	Petrol	107	11/04 → 12/11						
2.0	Petrol	107	11/04 →						
2.0	Petrol	107	11/04 →						
2.0	Petrol	107	05/07 →						
2.0 CNG	Petrol/CNG	107	04/09 → 12/11						
2.0 CNG	Petrol/CNG	107	04/09 →						
2.0 LPG	Petrol/LPG	107	06/08 → 12/11						
2.0 LPG	Petrol/LPG	107	06/08 →						
2.0 TDCi	Diesel	100	11/04 → 01/08	ENGINE: G6DA			50CDDF4/1	B3	
2.0 TDCi	Diesel	100	03/07 →	ENGINE: G6DA, G6DB, G6DD			50CDSP3/F	B3	
2.0 TDCi	Diesel	81	02/08 → 07/11	ENGINE: IXDA			50CDSF5	B3	
2.0 TDCi	Diesel	100	11/04 →						
2.0 TDCi	Diesel	100	11/04 →						
2.5 RS	Petrol	224	01/09 → 12/11						
2.5 RS	Petrol	224	01/09 →						
2.5 RS 500	Petrol	257	05/10 → 07/11						
2.5 ST	Petrol	166	10/05 →						

FOCUS II Cabriolet

1.6	Petrol	74	10/06 → 07/10						
1.6	Petrol	74	10/06 →						
1.6	Petrol	74	10/06 → 10/09						
2.0	Petrol	107	10/06 → 07/10						
2.0	Petrol	107	10/06 →						
2.0	Petrol	107	10/06 →						
2.0	Petrol	107	10/06 →						
2.0	Petrol	107	05/07 →						
2.0 TDCi	Diesel	100	10/06 → 07/10	ENGINE: G6DA			50CDDF4/1	B3	
2.0 TDCi	Diesel	100	03/07 →	ENGINE: G6DA, G6DB, G6DD			50CDSP3/F	B3	
2.0 TDCi	Diesel	100	10/06 →						
2.0 TDCi	Diesel	100	10/06 →						

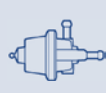

TYPE

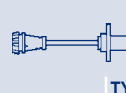

TYPE



TYPE

FEI0009										
FEI0009	APS19				SAA115	SAC001	H2	BAE680DW		
						SAD036	H3			
						SAG016	H2			
						SAC008	H1			
									GA2235	J2
	APS78		ATS22	F2	SAA115	SAC008	H1			
			SPA158	F1		SAD041	H3			
						SAC074	H2			
FEI0014										
FEI0014	APS19		SPA116	F1	SAA115	SAD036	H3	BAE680DW		
						SAG016	H2			
									GA2137	J2
FEI0014	APS19									
FEI0014	APS19									
			ATS22	F2	SAA118	SAC008	H1			
			SPA172	F1		SAG169	H1			
FEI0006	APS22					SAC090	H2			
						SAC090	H2			
	APS22					SAC008	H1			
FEI0017	APS13				SAA115	SAD037	H3	BAE680DX		
FEI0014	APS19				SAA115	SAC008	H1	BAE680DW		
						SAD036	H3			
						SAG016	H2			
									GA2137	J2
			ATS22	F2	SAA118	SAC008	H1			
						SAG169	H1			



KW



TYPE



TYPE

FORD

FOCUS II Station wagon (DA_)

1.4	Petrol	59	11/04 → 12/11					
1.4	Petrol	59	11/04 →					
1.4	Petrol	59	11/04 →					
1.4	Petrol	59	11/04 →					
1.4	Petrol	59	11/04 →	ENGINE: ZETEC-S				
1.4	Petrol	59	03/05 →					
1.6	Petrol	74	11/04 → 12/11					
1.6	Petrol	74	11/04 →					
1.6	Petrol	74	11/04 →					
1.6	Petrol	74	11/04 →	ENGINE: ZETEC-S				
1.6	Petrol	74	03/05 →					
1.6	Petrol	74	11/04 →	ENGINE: HWDA,HWDB,SHDA				
1.6 LPG	Petrol/LPG	85	10/09 → 12/11					
1.6 LPG	Petrol/LPG	85	10/09 →					
1.6 TDCi	Diesel	66	11/04 →					
1.6 TDCi	Diesel	66	11/04 →					
1.6 TDCi	Diesel	80	11/04 →					
1.6 TDCi	Diesel	80	11/04 →					
1.6 Ti	Petrol	85	11/04 →	ENGINE: ZETEC-S		AMM19652		B4
1.6 Ti	Petrol	85	11/04 → 12/11					
1.6 Ti	Petrol	85	11/04 →					
1.6 Ti	Petrol	85	11/04 →					
1.6 Ti	Petrol	85	11/04 →					
1.6 Ti	Petrol	85	11/04 →	ENGINE: ZETECROCAM16SOHC				
1.6 Ti	Petrol	85	03/05 →					
1.8	Petrol	92	03/06 → 12/11					
1.8	Petrol	92	03/06 →					
1.8 Flexifuel	Petrol/Ethanol	92	01/06 → 12/11					
1.8 Flexifuel	Petrol/Ethanol	92	01/06 →					
1.8 Flexifuel	Petrol/Ethanol	92	01/06 →					
1.8 Flexifuel	Petrol/Ethanol	92	01/06 →					
1.8 Flexifuel	Petrol/Ethanol	97	12/05 →					
1.8 Flexifuel	Petrol/Ethanol	92	01/06 →	ENGINE: Q7DA				
1.8 TDCi	Diesel	85	11/04 →			AMM19655		B4
1.8 TDCi	Diesel	85	11/04 →					
1.8 TDCi	Diesel	85	11/04 →					
2.0	Petrol	107	11/04 → 12/11					
2.0	Petrol	107	11/04 →					
2.0	Petrol	107	11/04 →					
2.0	Petrol	107	11/04 →	ENGINE: AODA,AODB				
2.0 LPG	Petrol/LPG	107	06/08 → 12/11					
2.0 LPG	Petrol/LPG	107	06/08 →					



TYPE

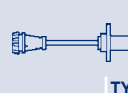

TYPE



TYPE

FEI0017											
	APS13		SPA170	F1	SAA115	SAC008	H1				
						SAD037	H3				
						SAG170	H1				
						SAG008	H1				
										BAE680DX	
FEI0017											
	APS13		SPA170	F1	SAA115	SAC008	H1				
						SAD037	H3				
						SAG170	H1				
						SAG008	H1				
										BAE680DX	
											GA2235
											J2
FEI0017											
										BAE680DX	
			ATS22	F2	SAA118	SAC008	H1				
			SPA172	F1		SAG167	H1				
			ATS22	F2	SAA118	SAC008	H1				
			SPA172	F1		SAG167	H1				
FEI0017											
	APS13		SPA170	F1	SAA115	SAC008	H1				
						SAD037	H3				
						SAG170	H1				
						SAG008	H1				
										BAE680DX	
FEI0014											
	APS19									BAE680DW	
FEI0009											
	APS19				SAA115	SAC001	H2			BAE680DW	
						SAD036	H3				
						SAG016	H2				
						SAC008	H1				
											GA2235
											J2
	APS78		ATS22	F2	SAA115	SAC008	H1				
			SPA158	F1		SAD041	H3				
						SAG170	H1				
FEI0014											
	APS19		SPA116	F1	SAA115	SAD036	H3			BAE680DW	
						SAG016	H2				
											GA2235
											J2
FEI0014											
	APS19										



KW



TYPE



TYPE

FORD

FOCUS II Station wagon (DA_)

2.0 TDCi	Diesel	100	11/04 → 01/08	ENGINE: G6DA			50CDDF4/1	B3
2.0 TDCi	Diesel	100	03/07 →	ENGINE: G6DA,G6DB,G6DD			50CDSP3/F	B3
2.0 TDCi	Diesel	81	02/08 → 07/11	ENGINE: IXDA			50CDSF5	B3
2.0 TDCi	Diesel	100	11/04 →					
2.0 TDCi	Diesel	100	11/04 →					

FOCUS II Tre volumi (DA_)

1.4	Petrol	59	04/05 → 12/11					
1.4	Petrol	59	04/05 →					
1.4	Petrol	59	04/05 →					
1.4	Petrol	59	04/05 →	ENGINE: ZETEC-S				
1.4	Petrol	59	04/05 → 01/08					
1.6	Petrol	74	04/05 → 12/11					
1.6	Petrol	74	04/05 →					
1.6	Petrol	74	04/05 →					
1.6	Petrol	74	04/05 →	ENGINE: ZETEC-S				
1.6	Petrol	74	04/05 → 12/07					
1.6 TDCi	Diesel	66	04/05 →					
1.6 TDCi	Diesel	66	04/05 →					
1.6 TDCi	Diesel	80	04/05 →					
1.6 TDCi	Diesel	80	04/05 →					
1.6 Ti	Petrol	85	04/05 →	ENGINE: ZETEC-S			AMM19652	B4
1.6 Ti	Petrol	85	04/05 → 12/11					
1.6 Ti	Petrol	85	04/05 →					
1.6 Ti	Petrol	85	04/05 →					
1.6 Ti	Petrol	85	04/05 →					
1.6 Ti	Petrol	85	04/05 →	ENGINE: ZETECROCAM16SOHC				
1.6 Ti	Petrol	85	04/05 → 12/07					
1.8	Petrol	92	12/07 → 12/11					
1.8	Petrol	92	03/06 →					
1.8 Flexifuel	Petrol/Ethanol	92	06/06 → 01/08					
1.8 Flexifuel	Petrol/Ethanol	92	06/06 →					
1.8 Flexifuel	Petrol/Ethanol	92	06/06 →					
1.8 Flexifuel	Petrol/Ethanol	92	06/06 →					
1.8 Flexifuel	Petrol/Ethanol	96	12/05 →					
1.8 TDCi	Diesel	85	04/05 →				AMM19655	B4
1.8 TDCi	Diesel	85	04/05 →					
1.8 TDCi	Diesel	85	04/05 →	ENGINE: KKDA, KKDB				
2.0	Petrol	107	04/05 →	ENGINE: AODA, AODB, ENGINE: AODA, AOD<EURO4>, AOD<EURO5>				
2.0	Petrol	107	04/05 →					
2.0	Petrol	107	04/05 →					
2.0	Petrol	107	04/05 →					



TYPE

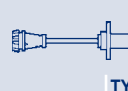

TYPE



TYPE

				ATS22	F2	SAA118	SAC008	H1	
				SPA172	F1		SAG169	H1	
FEI0017	APS13	SPA170	F1	SAA115		SAC008	SAD037	H1 H3	
							SAG008	H1	BAE680DX
FEI0017	APS13	SPA170	F1	SAA115		SAC008	SAD037	H1 H3	
							SAG008	H1	BAE680DX
				ATS22	F2	SAA118	SAC008	H1	
				SPA172	F1		SAG167	H1	
				ATS22	F2	SAA118	SAC008	H1	
				SPA172	F1		SAG167	H1	
FEI0017	APS13	SPA170	F1	SAA115		SAC008	SAD037	H1 H3	
							SAG168	H1	
							SAG008	H1	BAE680DX
FEI0014	APS19								BAE680DW
FEI0009	APS19					SAA115	SAC001	H2	
							SAD036	H3	
							SAG016	H2	
							SAC008	H1	
	APS78	ATS22	F2	SAA115		SAC008	SAD041	H1 H3	
		SPA158	F1				SAC074	H2	
FEI0014	APS19	SPA116	F1	SAA115		SAC001	SAD036	H2 H3	BAE680DW
							SAG016	H2	



KW

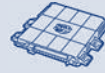

TYPE



TYPE

FORD

FOCUS II Tre volumi (DA_)

2.0	Petrol	107	05/07 →					
2.0 TDCi	Diesel	100	03/07 →	ENGINE: G6DA,G6DB,G6DD			50CDSP3/F	B3
2.0 TDCi	Diesel	100	12/07 → 07/11	ENGINE: G6DA,G6DB,G6DD			50CDDF4/1	B3
2.0 TDCi	Diesel	81	02/08 → 07/11	ENGINE: IXDA			50CDSF5	B3
2.0 TDCi	Diesel	100	04/05 →					
2.0 TDCi	Diesel	100	04/05 →					

FOCUS III

1.6 LPG	Petrol/LPG	88	02/12 →					
1.6 Ti	Petrol	63	08/11 →					
1.6 Ti	Petrol	63	08/11 →	ENGINE: XTDA				

FOCUS III Tre volumi

1.6 Ti	Petrol	63	02/12 →					
1.6 Ti	Petrol	63	08/11 →					

FOCUS III Turnier

1.6 EcoBoost	Petrol	110	05/11 →					
1.6 Flexifuel	Petrol/Ethanol	88	05/11 →					
1.6 LPG	Petrol/LPG	88	02/12 →					
1.6 TDCi	Diesel	70	05/11 →	ENGINE: T3DA,T3DB				
1.6 TDCi	Diesel	85	05/11 →	ENGINE: T1DA,T1DB				
1.6 Ti	Petrol	63	02/12 →					
1.6 Ti	Petrol	63	08/11 →					

FOCUS Station wagon (DNW)

1.4 16V	Petrol	55	02/99 → 11/04	ENGINE: ZETEC-S			SVF008	B6
1.4 16V	Petrol	55	08/00 → 11/04				VAE3390	B2
1.4 16V	Petrol	55	02/99 → 11/04					
1.4 16V	Petrol	55	02/99 → 11/04					
1.4 16V	Petrol	55	02/99 → 11/04	ENGINE: FXDA,FXDC,FXDB,FXDD				
1.4 16V	Petrol	55	02/99 → 11/04	ENGINE: FXDA,FXDC,FXDB,FXDD				
1.4 16V	Petrol	55	02/99 → 11/04	ENGINE: ZETEC-S				
1.6 16V	Petrol	74	02/99 → 11/04	ENGINE: ZETECROCAM16SOHC			SVF008	B6
1.6 16V	Petrol	74	08/00 → 11/04				VAE3390	B2
1.6 16V	Petrol	74	02/99 → 11/04					
1.6 16V	Petrol	74	02/99 → 11/04					
1.6 16V	Petrol	74	02/99 → 11/04					
1.6 16V	Petrol	74	02/99 → 11/04	ENGINE: FYDA,FYDC, FYDB,FYDD,FYDH				
1.6 16V	Petrol	74	02/99 → 11/04	ENGINE: FYDA,FYDC, FYDB,FYDD,FYDH				
1.6 16V	Petrol	74	02/99 → 11/04	ENGINE: ZETECEFI				
1.6 16V Flexifuel	Petrol/Ethanol	75	01/02 → 11/04					
1.8 16V	Petrol	85	02/99 → 11/04				VAE3391	B2



TYPE



TYPE



TYPE

								GA2137	J2
			ATS22	F2	SAA118	SAC008	H1		
			SPA172	F1		SAG169	H1		
								BAE680DX	
FEI0013								BAE680DX	
									GA2237 J2
FEI0013									
								BAE680DX	
						SAG109	H1		
								BAE680DX	
								BAE680DX	
						SAC099	H2		
						SAC099	H2		
FEI0013									
								BAE680DX	
						SAC003	H2		
FEI0017	APS12		ATS24	F2	SAA112	SAC004	H2		
			SPA113	F1		SAD037	H3		
						SAC097	H2		
						SAG179	H1		
						SAG006	H1		
FEI0017	APS12		ATS24	F2	SAA112	SAC008	H1	BAE680BZ	
			SPA113	F1		SAD037	H3		
						SAG006	H1		
						SAC097	H2		
						SAG179	H1		
						SAC003	H2		
			ATS24	F2					
		RP04A	ATS24	F2	SAA113	SAC008	H1	BAE680BZ	



KW



TYPE



TYPE

FORD

FOCUS Station wagon (DNW)

1.8 16V	Petrol	85	02/99 → 11/04	ENGINE: EYDC,EYDB, EYDD,EYDE,EYDF,EYDG, EYDI,EYDJ,EYDL			AMM19780	B4
1.8 16V	Petrol	85	02/99 → 11/04					
1.8 16V	Petrol	85	02/99 → 11/04					
1.8 16V	Petrol	85	02/99 → 11/04	ENGINE: ZETEC-EDOHCEFI				
1.8 BiFuel	Petrol/LPG	82	02/03 → 01/05					
1.8 DI / TDDi	Diesel	55	08/99 → 11/04					
1.8 DI / TDDi	Diesel	55	08/99 → 11/04					
1.8 DI / TDDi	Diesel	55	08/99 → 11/04	ENGINE: BHDA,BHDB				
1.8 TDCi	Diesel	74	08/02 → 09/03	ENGINE: DURATORQTDCI18				
1.8 TDCi	Diesel	85	03/01 → 09/03					
1.8 TDCi	Diesel	74	08/02 → 11/04					
1.8 TDCi	Diesel	74	08/02 → 11/04					
1.8 TDCi	Diesel	85	03/01 → 11/04					
1.8 TDCi	Diesel	85	03/01 → 11/04					
1.8 TDCi	Diesel	74	08/02 → 11/04					
1.8 TDCi	Diesel	74	08/02 → 11/04	ENGINE: FFDA				
1.8 TDCi	Diesel	74	08/02 → 11/04	ENGINE: FFDA				
1.8 TDCi	Diesel	85	03/01 → 11/04	ENGINE: F9DA,F9DB				
1.8 TDCi	Diesel	85	03/01 → 11/04	ENGINE: F9DA,F9DB				
1.8 TDCi	Diesel	85	03/01 → 11/04	ENGINE: DURATORQ18TDCI				
1.8 Turbo DI / TDDi	Diesel	66	02/99 → 11/04					
1.8 Turbo DI / TDDi	Diesel	66	02/99 → 11/04					
1.8 Turbo DI / TDDi	Diesel	66	02/99 → 11/04	ENGINE: C9DC,C9DA,C9DB				
2.0 16V	Petrol	96	02/99 → 11/04				VAE3391	B2
2.0 16V	Petrol	96	02/99 → 11/04	ENGINE: EDDC,EDDB,EDDD,EDDF			AMM19780	B4
2.0 16V	Petrol	96	02/99 → 11/04	ENGINE: ZETEC2016VEFI				
2.0 16V	Petrol	96	02/99 → 11/04	ENGINE: ZETEC-EDOHCEFI				
ST170	Petrol	127	08/02 → 11/04					
ST170	Petrol	127	08/02 → 11/04					
ST170	Petrol	127	08/02 → 11/04					
ST170	Petrol	127	08/02 → 11/04					

FOCUS Tre volumi (DFW)

1.4 16V	Petrol	55	02/99 → 11/04	ENGINE: ZETEC-S			SVF008	B6
1.4 16V	Petrol	55	08/00 → 11/04				VAE3390	B2
1.4 16V	Petrol	55	02/99 → 11/04					
1.4 16V	Petrol	55	02/99 → 11/04					
1.4 16V	Petrol	55	02/99 → 11/04					
1.4 16V	Petrol	55	02/99 → 11/04	ENGINE: FXDA,FXDC,FXDB,FXDD				
1.4 16V	Petrol	55	02/99 → 11/04	ENGINE: FXDA,FXDC,FXDB,FXDD				



TYPE

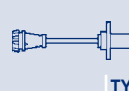

TYPE



TYPE

							SAG179	H1		
							SAD038	H3		
							SAG006	H1		
							SAC002	H2		
			ATS24	F2						
	APS15		ATS24	F2	SAA113		SAC008	H1		
			SPA158	F1			SAG006	H1		
							SAG179	H1		
	APS15									
	APS11									
			ATS24	F2	SAA115		SAC008	H1		
			SPA158	F1			SAD040	H3		
			ATS24	F2	SAA115		SAC008	H1		
			SPA158	F1			SAD040	H3		
							SAG006	H1		
							SAC074	H2		
							SAG179	H1		
							SAC074	H2		
							SAG179	H1		
							SAG001	H1		
	APS15		ATS24	F2	SAA113		SAC008	H1		
			SPA158	F1			SAG006	H1		
							SAG179	H1		
		RP04A	ATS24	F2	SAA113		SAC008	H1	BAE680BZ	
							SAG179	H1		
							SAG006	H1		
							SAC002	H2		
			ATS24	F2	SAA113		SAC008	H1		
							SAC020	H2		
							SAD036	H3		
							SAG006	H1		
							SAC003	H2		
	FEI0017	APS12	ATS24	F2	SAA112		SAC004	H2		
			SPA113	F1			SAD037	H3		
							SAG171	H1		
							SAC097	H2		
							SAG179	H1		



KW



TYPE



TYPE

FORD

FOCUS Tre volumi (DFW)

1.4 16V	Petrol	55	02/99 → 11/04	ENGINE: ZETEC-S				
1.6 16V	Petrol	74	02/99 → 11/04	ENGINE: ZETECROCAM16SOHC		SVF008	B6	
1.6 16V	Petrol	74	08/00 → 11/04			VAE3390	B2	
1.6 16V	Petrol	74	02/99 → 11/04					
1.6 16V	Petrol	74	02/99 → 11/04					
1.6 16V	Petrol	74	02/99 → 11/04					
1.6 16V	Petrol	74	02/99 → 11/04	ENGINE: FYDA,FYDC, FYDB,FYDD,FYDH				
1.6 16V	Petrol	74	02/99 → 11/04	ENGINE: FYDA,FYDC, FYDB,FYDD,FYDH				
1.6 16V	Petrol	74	02/99 → 11/04	ENGINE: ZETECEFI				
1.8 16V	Petrol	85	02/99 → 11/04			VAE3391	B2	
1.8 16V	Petrol	85	02/99 → 11/04	ENGINE: EYDC,EYDB, EYDD,EYDE,EYDF,EYDG, EYDI,EYDJ,EYDL		AMM19780	B4	
1.8 16V	Petrol	85	02/99 → 11/04					
1.8 16V	Petrol	85	02/99 → 11/04					
1.8 16V	Petrol	85	02/99 → 11/04	ENGINE: ZETEC-EDOHCEFI				
1.8 TDCi	Diesel	74	08/02 → 09/03	ENGINE: DURATORQTDCI18				
1.8 TDCi	Diesel	85	03/01 → 09/03					
1.8 TDCi	Diesel	74	08/02 → 11/04					
1.8 TDCi	Diesel	74	08/02 → 11/04					
1.8 TDCi	Diesel	85	03/01 → 11/04					
1.8 TDCi	Diesel	85	03/01 → 11/04					
1.8 TDCi	Diesel	74	08/02 → 11/04					
1.8 TDCi	Diesel	74	08/02 → 11/04	ENGINE: FFDA				
1.8 TDCi	Diesel	74	08/02 → 11/04	ENGINE: FFDA				
1.8 TDCi	Diesel	85	03/01 → 11/04	ENGINE: F9DA,F9DB				
1.8 TDCi	Diesel	85	03/01 → 11/04	ENGINE: F9DA,F9DB				
1.8 TDCi	Diesel	85	03/01 → 11/04	ENGINE: DURATORQ18TDCI				
1.8 Turbo DI / TDDi	Diesel	66	02/99 → 11/04					
1.8 Turbo DI / TDDi	Diesel	55	08/01 → 03/05					
1.8 Turbo DI / TDDi	Diesel	66	02/99 → 11/04					
1.8 Turbo DI / TDDi	Diesel	66	02/99 → 11/04					
1.8 Turbo DI / TDDi	Diesel	55	08/01 → 03/05	ENGINE: BHDA,BHDB				
1.8 Turbo DI / TDDi	Diesel	66	02/99 → 11/04	ENGINE: C9DC,C9DA,C9DB				
2.0 16V	Petrol	96	02/99 → 11/04			VAE3391	B2	
2.0 16V	Petrol	96	02/99 → 11/04	ENGINE: EDDC,EDDB,EDDD,EDDF		AMM19780	B4	
2.0 16V	Petrol	96	02/99 → 11/04					
2.0 16V	Petrol	96	02/99 → 11/04	ENGINE: ZETEC2016VEFI				
2.0 16V	Petrol	96	02/99 → 11/04	ENGINE: ZETEC-EDOHCEFI				



TYPE



TYPE



TYPE

						SAG006	H1	
FEI0017	APS12		ATS24	F2	SAA112	SAC008	H1	BAE680BZ
			SPA113	F1		SAD037	H3	
						SAG006	H1	
						SAC097	H2	
						SAG179	H1	
						SAC003	H2	
		RP04A	ATS24	F2	SAA113	SAC008	H1	BAE680BZ
						SAG179	H1	
						SAD038	H3	
						SAG006	H1	
						SAC002	H2	
	APS15							
	APS11							
			ATS24	F2	SAA115	SAC008	H1	
			SPA158	F1		SAD040	H3	
			ATS24	F2	SAA115	SAC008	H1	
			SPA158	F1		SAD040	H3	
						SAG006	H1	
						SAC074	H2	
						SAG179	H1	
						SAC074	H2	
						SAG179	H1	
						SAG001	H1	
	APS15		ATS24	F2	SAA113	SAC008	H1	
			ATS24	F2				
			SPA158	F1		SAG006	H1	
						SAG171	H1	
						SAG179	H1	
						SAG179	H1	
		RP04A	ATS24	F2	SAA113	SAC008	H1	BAE680BZ
						SAG179	H1	
						SAG171	H1	
						SAG006	H1	
						SAC002	H2	



KW



TYPE



TYPE

FORD

FUSION (JU_)

1.25	Petrol	55	03/05 → 06/12					
1.25	Petrol	55	08/04 →					
1.25	Petrol	55	08/04 →					
1.25	Petrol	55	08/04 →	ENGINE: ZETEC-S				
1.25	Petrol	55	03/05 → 06/12	ENGINE: FUJA,FUJB				
1.3	Petrol	44	11/02 →					
1.4	Petrol	59	10/02 → 06/12					
1.4	Petrol	59	08/02 →					
1.4	Petrol	59	08/02 →					
1.4	Petrol	59	08/02 →	ENGINE: ZETEC-S				
1.4	Petrol	59	03/05 →					
1.4	Petrol	59	10/02 → 06/12	ENGINE: FXJA,FXJB,FXJC				
1.4 TDCi	Diesel	50	08/02 →			AMM19765	B4	
1.4 TDCi	Diesel	50	02/04 →	ENGINE: DURATORQ14TDCI		AMM19651	B4	
1.4 TDCi	Diesel	50	08/02 →					
1.6	Petrol	74	10/02 → 06/12					
1.6	Petrol	74	08/02 →					
1.6	Petrol	74	08/02 →					
1.6	Petrol	74	08/02 →	ENGINE: ZETEC-S				
1.6	Petrol	74	03/05 →					
1.6	Petrol	74	10/02 → 06/12	ENGINE: FYJA,FYJB				
1.6 TDCi	Diesel	66	11/04 →	ENGINE: DURATORQ16TDCI		AMM19654	B4	
1.6 TDCi	Diesel	66	11/04 →					
1.6 TDCi	Diesel	66	11/04 →					

GALAXY (WA6)

1.8 TDCi	Diesel	74	05/06 →			AMM19656	B4	
1.8 TDCi	Diesel	92	05/06 →			AMM19656	B4	
1.8 TDCi	Diesel	74	05/06 →					
1.8 TDCi	Diesel	92	05/06 →					
1.8 TDCi	Diesel	74	05/06 →	ENGINE: FFWA				
1.8 TDCi	Diesel	92	05/06 →	ENGINE: QYWA				
2.0	Petrol	107	05/06 →					
2.0	Petrol	107	05/06 →	ENGINE: AOWB,AOWA				
2.0 EcoBoost	Petrol	149	03/10 → 04/11					
2.0 Flexifuel	Petrol/Ethanol	107	05/06 →					
2.0 TDCi	Diesel	103	05/06 →			AMM19656	B4	
2.0 TDCi	Diesel	85	11/07 →			AMM19656	B4	
2.0 TDCi	Diesel	96	05/06 →			AMM19656	B4	
2.0 TDCi	Diesel	103	05/06 →					
2.0 TDCi	Diesel	85	11/07 →					
2.0 TDCi	Diesel	96	05/06 →					
2.2 TDCi	Diesel	129	03/08 →					
2.3	Petrol	118	07/07 →					
2.3	Petrol	118	07/07 →					



TYPE

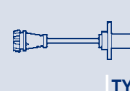

TYPE



TYPE

FEI0017										
	APS13		ATS24	F2	SAA112	SAD037	H3	BAE680DX		
			SPA170	F1		SAG170	H1			
						SAG008	H1			
									GA2236	J2
	APS13									
FEI0017										
	APS13		ATS24	F2	SAA112	SAD037	H3	BAE680BZ		
			SPA170	F1						
						SAG008	H1			
								BAE680DX		
									GA2236	J2
			ATS22	F2	SAA118	SAG168	H1			
			SPA172	F1						
FEI0017										
	APS13		ATS24	F2	SAA112	SAD037	H3	BAE680BZ		
			SPA170	F1						
						SAG008	H1			
								BAE680DX		
									GA2236	J2
			ATS22	F2	SAA118	SAC096	H2			
						SAG168	H1			
	APS78		ATS22	F2	SAA115	SAD041	H3			
	APS78		ATS22	F2	SAA115	SAD041	H3			
			SPA158	F1						
			SPA158	F1						
						SAC074	H2			
						SAC074	H2			
FEI0014	APS19				SAA115	SAD036	H3	BAE680DW		
									GA2238	J2
								BAE680DY		
	APS19									
			ATS22	F2	SAA118	SAC096	H2			
			ATS22	F2	SAA118	SAC096	H2			
			ATS22	F2	SAA118	SAC096	H2			
						SAG169	H1			
						SAG169	H1			
						SAG169	H1			
	APS58		ATS22	F2	SAA118	SAG168	H1			
FEI0007					SAA115	SAC023	H2	BAE680CM		
						SAD036	H3			



KW



TYPE



TYPE

FORD

GALAXY (WA6)

2.3 Petrol 118 07/07 → ENGINE: SEWA

GALAXY (WGR)

1.9 TDI	Diesel	110	05/05 → 05/06				AMM19752	B4
1.9 TDI	Diesel	96	02/03 → 05/06				AMM19752	B4
1.9 TDI	Diesel	66	03/95 → 04/01					
1.9 TDI	Diesel	85	04/00 → 04/01					
1.9 TDI	Diesel	110	05/05 → 05/06					
1.9 TDI	Diesel	66	03/95 → 05/06					
1.9 TDI	Diesel	66	03/95 → 05/06					
1.9 TDI	Diesel	66	09/99 → 09/00					
1.9 TDI	Diesel	81	08/97 → 04/00					
1.9 TDI	Diesel	81	08/97 → 04/00					
1.9 TDI	Diesel	85	04/00 → 05/06					
1.9 TDI	Diesel	85	04/00 → 05/06					
1.9 TDI	Diesel	85	05/00 → 05/06					
1.9 TDI	Diesel	96	02/03 → 05/06					
1.9 TDI	Diesel	110	06/05 → 05/06					
1.9 TDI	Diesel	96	06/05 → 05/06					
2.0 i	Petrol	85	07/96 → 05/06	ENGINE: ZETEC-E20			SVF005	B6
2.0 i	Petrol	85	11/95 → 05/06					
2.0 i	Petrol	85	11/95 → 05/06					
2.3 16V	Petrol	103	09/01 → 05/06					
2.3 16V	Petrol	103	09/01 → 05/06					
2.3 16V	Petrol	103	09/01 → 05/06	ENGINE: E5SB				
2.3 16V	Petrol	103	09/01 → 05/06	ENGINE: DOHC23				
2.3 4x4	Petrol	107	09/96 → 03/00	ENGINE: DOHC23			SVF005	B6
2.3 4x4	Petrol	107	09/96 → 04/00					
2.8 i V6	Petrol	128	11/95 → 04/00					
2.8 i V6	Petrol	128	11/95 → 04/00					
2.8 i V6	Petrol	128	11/95 → 04/00					
2.8 i V6 4x4	Petrol	128	07/96 → 03/00					
2.8 i V6 4x4	Petrol	128	04/96 → 04/00					
2.8 i V6 4x4	Petrol	128	04/96 → 04/00					
2.8 i V6 4x4	Petrol	128	04/96 → 04/00					
2.8 V6	Petrol	150	04/00 → 05/06					
2.8 V6	Petrol	150	04/00 → 05/06					
2.8 V6	Petrol	150	05/00 → 05/06					
2.8 V6	Petrol	150	04/00 → 05/06					

KA (RB_)

1.0 i	Petrol	38	07/97 → 08/98				B3398	B1
1.0 i	Petrol	38	07/97 → 09/99					
1.0 i	Petrol	38	07/97 → 09/99					
1.0 i	Petrol	48	09/99 → 11/08					
1.0 i	Petrol	38	07/97 → 09/99	ENGINE: ZH10JRB				

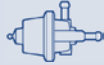

TYPE



TYPE



TYPE

GA2238

J2

 AT24 F2
 AT24 F2

 APS39
 APS39

 SPA111 F1
 AT24 F2
 SPA110 F1
 SPA109 F1
 AT24 F2
 SPA110 F1
 AT24 F2
 SPA109 F1
 SPA111 F1
 SPA111 F1

SAG015 H2

SAG026 H1

SAG142 H1

SAC009 H1

SAG015 H2

SAG015 H2

SAG015 H2

 AT24 F2
 SPA151 F1
 AT24 F2
 SPA170 F1

SAA112

SAG026 H1

ESS0018A J1

ESS0045A J1

SAA112

SAG026 H1

BAE680BZ

ESS0045A J1

SAC097 H2

SAG007 H1

 AT24 F2
 AT24 F2
 SPA105 F1

IWP022

SAC040 H2

ESS0018A J1

SAD002 H3

ESS0045A J1

SAG026 H1

IWP022

 AT24 F2
 SPA105 F1

SAC040 H2

ESS0018A J1

SAD002 H3

ESS0045A J1

SAG026 H1

 AT24 F2
 SPA105 F1
 SPA111 F1

SAC040 H2

ESS0045A J1

SAD031 H3

SAG065 H1

 AT24 F2
 SPA151 F1
 AT24 F2

SAC097 H2

SAC097 H2

KW

TYPE

TYPE
FORD
KA (RB_)

1.0 i	Petrol	48	09/99 → 11/08					
1.3 i	Petrol	36	06/98 → 11/08	ENGINE: HCS13EFI			SVF006	B6
1.3 i	Petrol	36	06/98 → 08/98				B3398	B1
1.3 i	Petrol	36	09/98 → 10/02				VAE3391	B2
1.3 i	Petrol	36	10/02 → 11/08	ENGINE: ROCAM13SOHC			SVF008	B6
1.3 i	Petrol	51	10/02 → 11/08	ENGINE: ROCAM13SOHC			SVF008	B6
1.3 i	Petrol	51	08/02 → 11/08					
1.3 i	Petrol	51	08/02 → 11/08					
1.3 i	Petrol	36	06/98 → 11/08					
1.3 i	Petrol	36	06/98 → 11/08					
1.3 i	Petrol	36	06/98 → 11/08	ENGINE: JJD,JJF,JJG,JJH,JJL				
1.3 i	Petrol	36	06/98 → 11/08	ENGINE: JJD,JJF,JJG,JJH,JJL				
1.3 i	Petrol	36	06/98 → 11/08	ENGINE: ZETEC-E				
1.3 i	Petrol	36	06/98 → 11/08	ENGINE: EFIZETEC-S				
1.3 i	Petrol	51	08/02 → 11/08	ENGINE: A9A,A9B				
1.3 i	Petrol	51	07/07 → 11/08					
1.3 i	Petrol	36	06/98 → 11/08	ENGINE: EFIHCS				
1.6	Petrol	68	10/06 → 12/07					
1.6 i	Petrol	70	07/03 → 11/08					
1.6 i	Petrol	70	07/03 → 11/08	ENGINE: CDB,CDC,CCA				
1.6 i	Petrol	70	07/03 → 11/08	ENGINE: ZETEC-S				
1.6 i	Petrol	70	07/07 → 11/08					

KA (RU8)

1.2	Petrol	51	10/08 → 09/13	ENGINE: FP4			40SMF10/1	B3
1.2	Petrol	51	10/08 →					
1.2	Petrol	51	10/08 →	ENGINE: FP4				
1.3 TDCi	Diesel	55	10/08 →					

KA Van (RB)

1.3 i	Petrol	44	05/02 → 05/05					
1.3 i	Petrol	44	05/02 → 05/05	ENGINE: J4D,J4K,J4M,J4N,J4P,J4S,BAA				

KUGA I

2.0 TDCi	Diesel	100	03/08 →					
2.0 TDCi	Diesel	100	03/08 →					
2.0 TDCi 4x4	Diesel	100	03/08 →					
2.0 TDCi 4x4	Diesel	100	03/08 →					
2.5 4x4	Petrol	147	03/09 →					

MAVERICK

2.0 16V	Petrol	91	02/01 →	ENGINE: ZETEC2016VEFI			SVF008	B6
2.0 16V	Petrol	91	02/01 →					
2.0 16V	Petrol	91	02/01 →	ENGINE: ZETEC-EDOHCEFI				
2.3 16V	Petrol	110	03/04 →	ENGINE: DOHC23			SVF008	B6
2.3 16V	Petrol	110	03/04 →					
3.0 V6 24V	Petrol	145	02/01 →					



TYPE

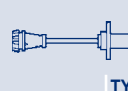

TYPE



TYPE

						SAG179	H1			
	APS17									
IWP119	APS13		ATS24	F2	SAA113	SAG175	H1	BAE680BZ		
			SPA153	F1						
			ATS24	F2	SAA112	SAG175	H1	BAE680AE		
			SPA170	F1						
						SAC097	H2			
						SAG179	H1			
						SAG006	H1			
						SAC003	H2			
						SAG179	H1			
								BAE680DX		
									SUA487	J1
			ATS24	F2						
FEI0008	APS13		ATS24	F2	SAA113	SAG175	H1			
						SAG179	H1			
						SAG008	H1			
								BAE680DX		
FEI0010						SAC079	H2		GA2229	J2
						CVM03/1	H1			
						SAF001	H4			
			ATS24	F2		SAG175	H1			
						SAG179	H1			
	APS38		ATS22	F2	SAA118	SAC096	H2			
						SAG169	H1			
	APS38		ATS22	F2	SAA118	SAC096	H2			
						SAG169	H1			
						SAC090	H2			
						SAA113	SAC007	H1	BAE680BZ	
							SAC002	H2		
						SAA115	SAC007	H1	BAE680DW	
							SAC007	H1		



KW



TYPE



TYPE

FORD

MAVERICK

3.0 V6 24V	Petrol	145	02/01 →	ENGINE: DURATECSE30LEFI				
3.0 V6 24V	Petrol	149	03/04 →					
3.0 V6 24V	Petrol	149	03/04 →	ENGINE: DURATECSE30LEFI				

MAVERICK (UDS, UNS)

2.7 TD	Diesel	74	02/93 → 08/96					
--------	--------	----	---------------	--	--	--	--	--

MONDEO I (GBP)

1.6 i 16V	Petrol	65	07/94 → 08/96					
1.6 i 16V	Petrol	65	07/94 → 08/96					
1.6 i 16V	Petrol	65	09/95 → 08/96					
1.6 i 16V	Petrol	66	02/93 → 08/96					
1.6 i 16V	Petrol	66	02/93 → 08/96					
1.6 i 16V	Petrol	66	09/95 → 08/96					
1.6 i 16V	Petrol	65	07/94 → 08/96					
1.6 i 16V	Petrol	65	07/94 → 08/96	ENGINE: EFIZETECZH16				
1.6 i 16V	Petrol	66	02/93 → 08/96	ENGINE: EFIZETECZH16				
1.8 i 16V	Petrol	82	07/94 → 08/96	ENGINE: ZETEC-E		AMM19657		B4
1.8 i 16V	Petrol	82	07/94 → 08/96	ENGINE: ZETEC-E		SVF005		B6
1.8 i 16V	Petrol	85	02/93 → 08/96	ENGINE: ZETEC-E		AMM19657		B4
1.8 i 16V	Petrol	85	02/93 → 08/96	ENGINE: ZETEC-E		SVF005		B6
1.8 i 16V	Petrol	82	07/94 → 08/96					
1.8 i 16V	Petrol	82	07/94 → 08/96					
1.8 i 16V	Petrol	82	09/95 → 08/96					
1.8 i 16V	Petrol	85	02/93 → 08/96					
1.8 i 16V	Petrol	85	02/93 → 08/96					
1.8 i 16V	Petrol	85	09/95 → 08/96					
1.8 i 16V	Petrol	82	07/94 → 08/96					
1.8 i 16V	Petrol	82	07/94 → 08/96	ENGINE: EFIZETECZH18				
1.8 i 16V	Petrol	85	02/93 → 08/96	ENGINE: EFIZETECZH18				
1.8 i 16V 4x4	Petrol	85	02/93 → 08/96	ENGINE: ZETEC-E		AMM19657		B4
1.8 i 16V 4x4	Petrol	85	02/93 → 08/96	ENGINE: ZETEC-E		SVF005		B6
1.8 i 16V 4x4	Petrol	85	02/93 → 08/96					
1.8 i 16V 4x4	Petrol	85	02/93 → 08/96					
1.8 i 16V 4x4	Petrol	85	09/95 → 08/96					
1.8 i 16V 4x4	Petrol	85	02/93 → 08/96	ENGINE: ZETEC-EDOHCEFI				
1.8 i 16V 4x4	Petrol	85	02/93 → 08/96	ENGINE: EFIZETECZH18				
1.8 TD	Diesel	65	06/93 → 08/96	ENGINE: DIESEL18TI		AMM19657		B4
1.8 TD	Diesel	66	10/95 → 08/96	ENGINE: DIESEL18TI		AMM19657		B4
1.8 TD	Diesel	65	06/93 → 08/96					
1.8 TD	Diesel	65	06/93 → 08/96					
1.8 TD	Diesel	66	10/95 → 08/96					
1.8 TD	Diesel	66	10/95 → 08/96					
2.0 i 16V	Petrol	100	02/93 → 08/96					
2.0 i 16V	Petrol	100	02/93 → 08/96					
2.0 i 16V	Petrol	100	09/95 → 08/96					

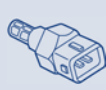
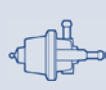

TYPE

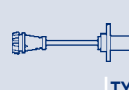

TYPE



TYPE

SAG003 H1

SAC007 H1

SAG003 H1

SPA131 F1

ATS24 F2 SAA112 SAC002 H2 BAE680AE

SPA151 F1 SAG006 H1

SPA170 F1

ATS24 F2 SAA112 SAC002 H2

SPA151 F1 SAG006 H1

SPA170 F1

SAG177 H1

SUA486 J1

SUA486 J1

ATS24 F2 SAA112 SAC002 H2 BAE680AE

SPA151 F1 SAG006 H1

SPA170 F1

ATS24 F2 SAA112 SAC002 H2

SPA151 F1 SAG177 H1

SPA170 F1

SAG177 H1

SUA486 J1

SUA486 J1

ATS24 F2 SAA112 SAC007 H1

SPA151 F1 SAG006 H1

SPA170 F1

SAC002 H2

SUA486 J1

ATS24 F2 SAA112 SAC007 H1

SPA151 F1 SAG101 H1

ATS24 F2 SAA112 SAC007 H1

SPA151 F1 SAG101 H1

ATS24 F2 SAA112 SAC007 H1

ESS0083A J1

SPA151 F1 SAG177 H1

SPA170 F1



KW

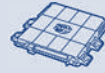

TYPE



TYPE

FORD

MONDEO I (GBP)

2.0 i 16V	Petrol	97	12/94 → 08/96						
2.0 i 16V	Petrol	97	12/94 → 08/96						
2.0 i 16V	Petrol	97	09/95 → 08/96						
2.0 i 16V	Petrol	100	02/93 → 08/96	ENGINE: ZETEC2016VEFI					
2.0 i 16V	Petrol	100	02/93 → 08/96	ENGINE: ZETEC-EDOHCEFI					
2.0 i 16V	Petrol	97	12/94 → 08/96	ENGINE: ZETEC-EDOHCEFI					
2.0 i 16V	Petrol	100	02/93 → 08/96	ENGINE: EFIZETECZH20					
2.0 i 16V	Petrol	97	12/94 → 08/96	ENGINE: EFIZETECZH20					
2.0 i 16V 4x4	Petrol	97	12/94 → 08/96						
2.0 i 16V 4x4	Petrol	97	12/94 → 08/96						
2.0 i 16V 4x4	Petrol	97	09/95 → 08/96						
2.0 i 16V 4x4	Petrol	97	12/94 → 08/96	ENGINE: ZETEC2016VEFI					
2.0 i 16V 4x4	Petrol	97	12/94 → 08/96	ENGINE: EFIZETECZH20					
2.5 i 24V	Petrol	125	07/94 → 08/96						
2.5 i 24V	Petrol	125	07/94 → 08/96						
2.5 i 24V	Petrol	125	08/95 → 08/96						
2.5 i 24V	Petrol	125	07/94 → 08/96						
2.5 i 24V	Petrol	125	07/94 → 08/96	ENGINE: DURATEC25EFI					
2.5 i 24V	Petrol	125	07/94 → 08/96	ENGINE: EFIV624VDURANTEC					

MONDEO I Station wagon (BNP)

1.6 i 16V	Petrol	65	07/94 → 08/96						
1.6 i 16V	Petrol	65	07/94 → 08/96						
1.6 i 16V	Petrol	66	04/93 → 08/96						
1.6 i 16V	Petrol	66	04/93 → 08/96						
1.6 i 16V	Petrol	66	09/95 → 08/96						
1.6 i 16V	Petrol	65	07/94 → 08/96						
1.6 i 16V	Petrol	66	04/93 → 08/96						
1.6 i 16V	Petrol	65	07/94 → 08/96	ENGINE: EFIZETECZH16					
1.6 i 16V	Petrol	66	04/93 → 08/96	ENGINE: EFIZETECZH16					
1.8 i 16V	Petrol	82	07/94 → 08/96	ENGINE: ZETEC-E			AMM19657		B4
1.8 i 16V	Petrol	82	07/94 → 08/96	ENGINE: ZETEC-E			SVF005		B6
1.8 i 16V	Petrol	85	04/93 → 08/96	ENGINE: ZETEC-E			AMM19657		B4
1.8 i 16V	Petrol	85	04/93 → 08/96	ENGINE: ZETEC-E			SVF005		B6
1.8 i 16V	Petrol	82	07/94 → 08/96						
1.8 i 16V	Petrol	82	07/94 → 08/96						
1.8 i 16V	Petrol	82	09/95 → 08/96						
1.8 i 16V	Petrol	85	04/93 → 08/96						
1.8 i 16V	Petrol	85	04/93 → 08/96						
1.8 i 16V	Petrol	85	09/95 → 08/96						
1.8 i 16V	Petrol	82	07/94 → 08/96						
1.8 i 16V	Petrol	85	04/93 → 08/96						
1.8 i 16V	Petrol	82	07/94 → 08/96	ENGINE: EFIZETECZH18					
1.8 i 16V	Petrol	85	04/93 → 08/96	ENGINE: EFIZETECZH18					

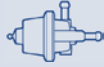

TYPE



TYPE



TYPE

				ATS24	F2		SAC007	H1	BAE680AE		
				SPA151	F1		SAG177	H1			
				SPA170	F1						
							SAG006	H1			
							SAC002	H2			
							SAC002	H2			
										SUA486	J1
										SUA486	J1
				ATS24	F2	SAA112	SAC007	H1		ESS0083A	J1
				SPA151	F1		SAG177	H1			
				SPA170	F1						
							SAG006	H1			
										SUA486	J1
				ATS24	F2	SAA112	SAC007	H1			
				SPA151	F1		SAC098	H2			
				SPA170	F1						
							SAG177	H1			
							SAG003	H1			
										SUA486	J1
				ATS24	F2	SAA112	SAC002	H2			
				SPA151	F1		SAG006	H1			
				ATS24	F2	SAA112	SAC002	H2			
				SPA151	F1		SAG006	H1			
				SPA170	F1						
							SAG177	H1			
							SAG177	H1			
										SUA486	J1
										SUA486	J1
				ATS24	F2	SAA112	SAC002	H2			
				SPA151	F1		SAG006	H1			
				SPA170	F1						
				ATS24	F2	SAA112	SAC002	H2			
				SPA151	F1		SAG006	H1			
				SPA170	F1						
							SAG177	H1			
							SAG177	H1			
										SUA486	J1
										SUA486	J1



KW



TYPE



TYPE

FORD

MONDEO I Station wagon (BNP)

1.8 i 16V 4x4	Petrol	85	04/93 → 08/96	ENGINE: ZETEC-E			AMM19657	B4
1.8 i 16V 4x4	Petrol	85	04/93 → 08/96	ENGINE: ZETEC-E			SVF005	B6
1.8 i 16V 4x4	Petrol	85	04/93 → 08/96					
1.8 i 16V 4x4	Petrol	85	04/93 → 08/96					
1.8 i 16V 4x4	Petrol	85	09/95 → 08/96					
1.8 i 16V 4x4	Petrol	85	04/93 → 08/96					
1.8 i 16V 4x4	Petrol	85	04/93 → 08/96	ENGINE: ZETEC-EDOHCEFI				
1.8 i 16V 4x4	Petrol	85	04/93 → 08/96	ENGINE: EFIZETECZH18				
1.8 TD	Diesel	65	06/93 → 08/96	ENGINE: DIESEL18TI			AMM19657	B4
1.8 TD	Diesel	66	11/95 → 08/96	ENGINE: DIESEL18TI			AMM19657	B4
1.8 TD	Diesel	65	06/93 → 08/96					
1.8 TD	Diesel	65	06/93 → 08/96					
1.8 TD	Diesel	66	11/95 → 08/96					
1.8 TD	Diesel	66	11/95 → 08/96					
2.0 i 16V	Petrol	100	04/93 → 08/96					
2.0 i 16V	Petrol	100	04/93 → 08/96					
2.0 i 16V	Petrol	100	09/95 → 08/96					
2.0 i 16V	Petrol	97	01/93 → 08/96					
2.0 i 16V	Petrol	97	01/93 → 08/96					
2.0 i 16V	Petrol	97	09/95 → 08/96					
2.0 i 16V	Petrol	100	04/93 → 08/96	ENGINE: ZETEC2016VEFI				
2.0 i 16V	Petrol	100	04/93 → 08/96	ENGINE: ZETEC-EDOHCEFI				
2.0 i 16V	Petrol	100	04/93 → 08/96	ENGINE: EFIZETECZH20				
2.0 i 16V	Petrol	97	01/93 → 08/96	ENGINE: EFIZETECZH20				
2.0 i 16V 4x4	Petrol	100	04/93 → 08/96					
2.0 i 16V 4x4	Petrol	100	04/93 → 08/96					
2.0 i 16V 4x4	Petrol	100	09/95 → 08/96					
2.0 i 16V 4x4	Petrol	97	12/94 → 08/96					
2.0 i 16V 4x4	Petrol	97	12/94 → 08/96					
2.0 i 16V 4x4	Petrol	97	09/95 → 08/96					
2.0 i 16V 4x4	Petrol	100	04/93 → 08/96	ENGINE: ZETEC2016VEFI				
2.0 i 16V 4x4	Petrol	100	04/93 → 08/96	ENGINE: ZETEC-EDOHCEFI				
2.0 i 16V 4x4	Petrol	100	04/93 → 08/96	ENGINE: EFIZETECZH20				
2.0 i 16V 4x4	Petrol	97	12/94 → 08/96	ENGINE: EFIZETECZH20				
2.5 i 24V	Petrol	125	07/94 → 08/96					
2.5 i 24V	Petrol	125	07/94 → 08/96					
2.5 i 24V	Petrol	125	08/95 → 08/96					
2.5 i 24V	Petrol	125	07/94 → 08/96					
2.5 i 24V	Petrol	125	07/94 → 08/96	ENGINE: DURATEC25EFI				
2.5 i 24V	Petrol	125	07/94 → 08/96	ENGINE: EFIV624VDURANTEC				

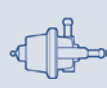

TYPE

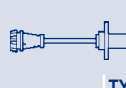

TYPE



TYPE

				ATS24	F2	SAA112	SAC007	H1			
				SPA151	F1		SAG006	H1			
				SPA170	F1						
							SAG177	H1			
							SAC002	H2			
										SUA486	J1
				ATS24	F2	SAA112	SAC007	H1			
				SPA151	F1		SAG101	H1			
				ATS24	F2	SAA112	SAC007	H1			
				SPA151	F1		SAG101	H1			
				ATS24	F2	SAA112	SAC007	H1		ESS0083A	J1
				SPA151	F1		SAG177	H1			
				SPA170	F1						
				ATS24	F2		SAC007	H1			
				SPA151	F1		SAG177	H1			
				SPA170	F1						
							SAG006	H1			
							SAC002	H2			
										SUA486	J1
										SUA486	J1
				ATS24	F2	SAA112	SAC007	H1		ESS0083A	J1
				SPA151	F1		SAG177	H1			
				SPA170	F1						
				ATS24	F2	SAA112	SAC007	H1		ESS0083A	J1
				SPA151	F1		SAG177	H1			
				SPA170	F1						
							SAG006	H1			
							SAC002	H2			
										SUA486	J1
										SUA486	J1
				ATS24	F2	SAA112	SAC007	H1			
				SPA151	F1		SAC098	H2			
				SPA170	F1						
							SAG177	H1			
							SAG003	H1			
										SUA486	J1



KW

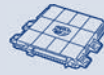

TYPE



TYPE

FORD

MONDEO I Tre volumi (GBP)

1.6 i 16V	Petrol	65	07/94 → 08/96					
1.6 i 16V	Petrol	65	07/94 → 08/96					
1.6 i 16V	Petrol	65	09/95 → 08/96					
1.6 i 16V	Petrol	66	02/93 → 08/96					
1.6 i 16V	Petrol	66	02/93 → 08/96					
1.6 i 16V	Petrol	66	09/95 → 08/96					
1.6 i 16V	Petrol	65	07/94 → 08/96					
1.6 i 16V	Petrol	65	07/94 → 08/96	ENGINE: EFIZETECZH16				
1.6 i 16V	Petrol	66	02/93 → 08/96	ENGINE: EFIZETECZH16				
1.8 4x4	Petrol	85	02/93 → 08/96					
1.8 i 16V	Petrol	82	01/94 → 08/96	ENGINE: ZETEC-E		AMM19657	B4	
1.8 i 16V	Petrol	82	01/94 → 08/96	ENGINE: ZETEC-E		SVF005	B6	
1.8 i 16V	Petrol	85	02/93 → 08/96	ENGINE: ZETEC-E		SVF005	B6	
1.8 i 16V	Petrol	85	02/93 → 08/96	ENGINE: ZETEC-E		AMM19657	B4	
1.8 i 16V	Petrol	82	01/94 → 08/96					
1.8 i 16V	Petrol	82	01/94 → 08/96					
1.8 i 16V	Petrol	82	09/95 → 08/96					
1.8 i 16V	Petrol	85	02/93 → 08/96					
1.8 i 16V	Petrol	85	02/93 → 08/96					
1.8 i 16V	Petrol	85	09/95 → 08/96					
1.8 i 16V	Petrol	82	01/94 → 08/96	ENGINE: EFIZETECZH18				
1.8 i 16V	Petrol	85	02/93 → 08/96	ENGINE: EFIZETECZH18				
1.8 TD	Diesel	65	06/93 → 08/96	ENGINE: DIESEL18TI		AMM19657	B4	
1.8 TD	Diesel	66	10/95 → 08/96	ENGINE: DIESEL18TI		AMM19657	B4	
1.8 TD	Diesel	65	06/93 → 08/96					
1.8 TD	Diesel	65	06/93 → 08/96					
1.8 TD	Diesel	66	10/95 → 08/96					
1.8 TD	Diesel	66	10/95 → 08/96					
2.0 i 16V	Petrol	100	02/93 → 08/96					
2.0 i 16V	Petrol	100	02/93 → 08/96					
2.0 i 16V	Petrol	100	09/95 → 08/96					
2.0 i 16V	Petrol	100	02/93 → 08/96	ENGINE: ZETEC-EDOHCEFI				
2.0 i 16V	Petrol	100	02/93 → 08/96	ENGINE: EFIZETECZH20				
2.0 i 16V 4x4	Petrol	97	12/94 → 08/96					
2.0 i 16V 4x4	Petrol	97	12/94 → 08/96					
2.0 i 16V 4x4	Petrol	97	09/95 → 08/96					
2.0 i 16V 4x4	Petrol	97	12/94 → 08/96	ENGINE: ZETEC-EDOHCEFI				
2.0 i 16V 4x4	Petrol	97	12/94 → 08/96	ENGINE: EFIZETECZH20				
2.5 i 24V	Petrol	125	07/94 → 08/96					
2.5 i 24V	Petrol	125	07/94 → 08/96					
2.5 i 24V	Petrol	125	08/95 → 08/96					
2.5 i 24V	Petrol	125	07/94 → 08/96					
2.5 i 24V	Petrol	125	07/94 → 08/96	ENGINE: DURATEC25EFI				

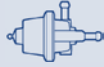

TYPE



TYPE



TYPE

				ATS24	F2	SAA112	SAC002	H2		
				SPA151	F1		SAG006	H1		
				SPA170	F1					
				ATS24	F2	SAA112	SAC002	H2		
				SPA151	F1		SAG006	H1		
				SPA170	F1					
							SAG177	H1		
									SUA486	J1
									SUA486	J1
				ATS24	F2		SAG006	H1		
				ATS24	F2	SAA112	SAC002	H2		
				SPA151	F1		SAG177	H1		
				SPA170	F1					
				ATS24	F2	SAA112	SAC002	H2		
				SPA151	F1		SAG006	H1		
				SPA170	F1					
									SUA486	J1
									SUA486	J1
				ATS24	F2	SAA112	SAC007	H1		
				SPA151	F1		SAG101	H1		
				ATS24	F2	SAA112	SAC007	H1		
				SPA151	F1		SAG101	H1		
				ATS24	F2	SAA112	SAC007	H1	ESS0083A	J1
				SPA151	F1		SAG177	H1		
				SPA170	F1					
							SAC002	H2		
									SUA486	J1
				ATS24	F2	SAA112	SAC007	H1	ESS0083A	J1
				SPA151	F1		SAG177	H1		
				SPA170	F1					
							SAC002	H2		
									SUA486	J1
				ATS24	F2	SAA112	SAC007	H1		
				SPA151	F1		SAC098	H2		
				SPA170	F1					
							SAG177	H1		
							SAG003	H1		



KW



TYPE



TYPE

FORD

MONDEO I Tre volumi (GBP)

2.5 i 24V	Petrol	125	07/94 → 08/96	ENGINE: EFIV624VDURANTEC				
-----------	--------	-----	---------------	-----------------------------	--	--	--	--

MONDEO II (BAP)

1.6 i 16V	Petrol	70	05/98 → 11/00	ENGINE: L1L,L1N,L1Q			AMM19780	B4
1.6 i 16V	Petrol	70	05/98 → 11/00	ENGINE: ZETECROCAM16SOHC			SVF008	B6
1.6 i 16V	Petrol	70	05/98 → 11/00					
1.6 i 16V	Petrol	70	05/98 → 11/00					
1.6 i 16V	Petrol	70	06/98 → 11/99					
2.5 24V	Petrol	125	10/00 → 11/00				SVF008	B6
2.5 24V	Petrol	125	06/00 → 11/00					
2.5 24V	Petrol	125	06/00 → 11/00					
2.5 24V	Petrol	125	06/00 → 11/00	ENGINE: DURATEC25EFI				
2.5 ST 200	Petrol	151	10/00 → 11/00				SVF008	B6
2.5 ST 200	Petrol	151	05/99 → 11/00					
2.5 ST 200	Petrol	151	05/99 → 11/00					
2.5 ST 200	Petrol	151	05/99 → 11/00					

MONDEO II Station wagon (BNP)

1.6 i 16V	Petrol	70	05/98 → 11/00	ENGINE: L1L,L1N,L1Q			AMM19780	B4
1.6 i 16V	Petrol	70	05/98 → 11/00	ENGINE: ZETECROCAM16SOHC			SVF008	B6
1.6 i 16V	Petrol	70	05/98 → 11/00					
1.6 i 16V	Petrol	70	05/98 → 11/00					
1.6 i 16V	Petrol	70	05/98 → 11/99					
2.5 24V	Petrol	125	10/00 → 11/00				SVF008	B6
2.5 24V	Petrol	125	10/99 → 11/00					
2.5 24V	Petrol	125	10/99 → 11/00					
2.5 24V	Petrol	125	05/00 → 11/00					
2.5 24V	Petrol	125	05/00 → 11/00	ENGINE: DURATEC25EFI				
2.5 ST 200	Petrol	151	10/00 → 11/00				SVF008	B6
2.5 ST 200	Petrol	151	05/99 → 11/00					
2.5 ST 200	Petrol	151	05/99 → 11/00					

MONDEO II Tre volumi (BFP)

1.6 i 16V	Petrol	70	05/98 → 11/00	ENGINE: L1L,L1N,L1Q			AMM19780	B4
1.6 i 16V	Petrol	70	05/98 → 11/00	ENGINE: ZETECROCAM16SOHC			SVF008	B6
1.6 i 16V	Petrol	70	05/98 → 11/00					
1.6 i 16V	Petrol	70	05/98 → 11/00					
1.6 i 16V	Petrol	70	06/98 → 11/99					
2.5 24V	Petrol	125	10/00 → 11/00				SVF008	B6
2.5 24V	Petrol	125	06/00 → 11/00					
2.5 24V	Petrol	125	06/00 → 11/00					
2.5 24V	Petrol	125	06/00 → 11/00	ENGINE: DURATEC25EFI				
2.5 ST 200	Petrol	151	10/00 → 11/00				SVF008	B6

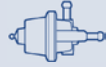

TYPE



TYPE



TYPE

SUA486

J1

ATS24 F2 SAA113 SAC002 H2 BAE680BZ

SPA141 F1

SPA116 F1

ATS24 F2 SAC006 H1

SPA141 F1

SAG003 H1

ATS24 F2 SAC006 H1

SPA141 F1 SAC098 H2

SAG003 H1

ATS24 F2 SAA113 SAC002 H2 BAE680BZ

SPA141 F1

SPA116 F1

ATS24 F2 SAC098 H2

SPA141 F1

SAC006 H1

SAG003 H1

ATS24 F2 SAC006 H1

SPA141 F1 SAG003 H1

ATS24 F2 SAA113 SAC002 H2

SPA141 F1

SPA116 F1

ATS24 F2 SAC006 H1

SPA141 F1

SAG003 H1



KW

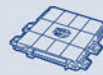

TYPE



TYPE

FORD

MONDEO II Tre volumi (BFP)

2.5 ST 200	Petrol	151	05/99 → 11/00					
2.5 ST 200	Petrol	151	05/99 → 11/00					

MONDEO III (B5Y)

1.8 16V	Petrol	81	11/00 → 08/07	ENGINE: CGBA,CGBB			AMM19780	B4
1.8 16V	Petrol	81	11/00 → 08/07	ENGINE: DURATECHE18SCI			SVF008	B6
1.8 16V	Petrol	92	11/00 → 08/07	ENGINE: CHBA,CHBB			AMM19780	B4
1.8 16V	Petrol	92	11/00 → 08/07	ENGINE: DURATECHE18SCI			SVF008	B6
1.8 16V	Petrol	81	11/00 → 03/07					
1.8 16V	Petrol	92	11/00 → 03/07					
1.8 16V	Petrol	81	11/00 → 08/07					
1.8 16V	Petrol	92	11/00 → 08/07					
1.8 16V	Petrol	81	11/00 → 08/07					
1.8 16V	Petrol	81	11/00 → 08/07					
1.8 16V	Petrol	92	11/00 → 08/07					
1.8 16V	Petrol	92	11/00 → 08/07					
1.8 16V	Petrol	81	11/00 → 08/07	ENGINE: DURATECDOHCEFI				
1.8 16V	Petrol	92	11/00 → 08/07	ENGINE: DURATECDOHCEFI				
1.8 16V	Petrol	81	03/05 → 03/07					
1.8 16V	Petrol	92	03/05 → 03/07					
1.8 SCi	Petrol	96	06/03 → 08/07					
1.8 SCi	Petrol	96	06/03 → 08/07					
1.8 SCi	Petrol	96	06/03 → 03/07					
2.0 16V	Petrol	107	11/00 → 08/07	ENGINE: CJBA,CJBB			AMM19780	B4
2.0 16V	Petrol	107	11/00 → 08/07	ENGINE: ZETEC2016VEFI			SVF008	B6
2.0 16V	Petrol	107	11/00 → 03/07					
2.0 16V	Petrol	107	11/00 → 08/07					
2.0 16V	Petrol	107	11/00 → 08/07					
2.0 16V	Petrol	107	11/00 → 08/07					
2.0 16V	Petrol	107	11/00 → 08/07	ENGINE: DURATECDOHCEFI				
2.0 16V	Petrol	107	03/05 → 03/07					
2.0 16V DI / TDDi / TDCi	Diesel	66	11/00 → 08/07					
2.0 16V DI / TDDi / TDCi	Diesel	66	11/00 → 08/07					
2.0 16V DI / TDDi / TDCi	Diesel	66	11/00 → 08/07					
2.0 16V DI / TDDi / TDCi	Diesel	66	03/06 → 08/07					
2.0 16V TDDi / TDCi	Diesel	85	11/00 → 08/07	ENGINE: DURATORQ20TDCI			AMM19664	B4
2.0 16V TDDi / TDCi	Diesel	85	11/00 → 08/07					
2.0 16V TDDi / TDCi	Diesel	85	11/00 → 08/07					
2.0 16V TDDi / TDCi	Diesel	85	11/00 → 08/07					
2.0 16V TDDi / TDCi	Diesel	85	09/02 → 08/07					
2.0 TDCi	Diesel	96	10/01 → 08/07	ENGINE: DURATORQ20TDCI			AMM19664	B4
2.0 TDCi	Diesel	92	02/03 → 06/05					
2.0 TDCi	Diesel	96	10/01 → 08/07					
2.0 TDCi	Diesel	96	10/01 → 08/07					
2.0 TDCi	Diesel	96	05/02 → 08/07					

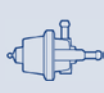

TYPE

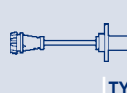

TYPE



TYPE

ATS24 F2 SAC006 H1

SPA141 F1 SAG003 H1

FEI0011

FEI0011

APS19 ATS24 F2 SAA115 SAC007 H1 BAE680BZ

APS19 ATS24 F2 SAA115 SAC007 H1 BAE680BZ

SPA116 F1 SAD036 H3

SAG016 H2

SPA116 F1 SAD036 H3

SAG016 H2

SAC001 H2

SAC001 H2

BAE680BO

BAE680BO

ATS24 F2 SAA115 SAC007 H1 GA2058 J2

SPA116 F1 SAC094 H2

BAE680BU

FEI0014

APS19 ATS24 F2 SAA115 SAC007 H1 BAE680BZ

SPA116 F1 SAD036 H3

SAG016 H2

SAC001 H2

BAE680BO

ATS24 F2 SAA113 SAC007 H1 ESS0168A J1

SPA148 F1 SAD040 H3

SAG016 H2

SAC083 H2

SAG002 H1

ATS24 F2 SAA113 SAC007 H1 ESS0168A J1

SPA148 F1 SAD040 H3

SAG171 H1

SAC083 H2

ATS24 F2 SAC007 H1

ATS24 F2 SAA113 SAC007 H1

SPA148 F1 SAD040 H3

SAC083 H2



KW



TYPE



TYPE

FORD

MONDEO III (B5Y)

2.2 TDCi	Diesel	114	09/04 → 08/07	ENGINE: DURATORQ22TDCI		AMM19665	B4
2.2 TDCi	Diesel	110	09/04 → 08/07				
2.2 TDCi	Diesel	114	09/04 → 08/07				
2.2 TDCi	Diesel	114	09/04 → 08/07				
2.2 TDCi	Diesel	114	09/04 → 08/07				
2.5 V6 24V	Petrol	125	11/00 → 08/07			SVF008	B6
2.5 V6 24V	Petrol	125	11/00 → 08/07				
2.5 V6 24V	Petrol	125	01/03 → 12/03				
3.0 V6 24V	Petrol	150	09/04 → 08/07				
3.0 V6 24V	Petrol	150	09/04 → 08/07				
3.0 V6 24V	Petrol	150	09/04 → 08/07	ENGINE: DURATECSE30LEFI			
ST220	Petrol	166	04/02 → 08/07				
ST220	Petrol	166	04/02 → 08/07				
ST220	Petrol	166	01/03 → 12/03	ENGINE: DURATECST30LEFI			

MONDEO III Station wagon (BWY)

1.8 16V	Petrol	81	11/00 → 08/07	ENGINE: CGBA,CGBB		AMM19780	B4
1.8 16V	Petrol	81	11/00 → 08/07	ENGINE: DURATECHE18SCI		SVF008	B6
1.8 16V	Petrol	92	11/00 → 08/07	ENGINE: CHBA,CHBB		AMM19780	B4
1.8 16V	Petrol	92	11/00 → 08/07	ENGINE: DURATECHE18SCI		SVF008	B6
1.8 16V	Petrol	81	11/00 → 03/07				
1.8 16V	Petrol	92	11/00 → 03/07				
1.8 16V	Petrol	81	11/00 → 08/07				
1.8 16V	Petrol	92	11/00 → 08/07				
1.8 16V	Petrol	81	11/00 → 08/07				
1.8 16V	Petrol	81	11/00 → 08/07				
1.8 16V	Petrol	92	11/00 → 08/07				
1.8 16V	Petrol	92	11/00 → 08/07				
1.8 16V	Petrol	81	11/00 → 08/07	ENGINE: DURATECDOHCEFI			
1.8 16V	Petrol	92	11/00 → 08/07	ENGINE: DURATECDOHCEFI			
1.8 16V	Petrol	81	03/05 → 03/07				
1.8 16V	Petrol	92	03/05 → 03/07				
1.8 SCi	Petrol	96	06/03 → 08/07				
1.8 SCi	Petrol	96	06/03 → 08/07				
1.8 SCi	Petrol	96	06/03 → 03/07				
2.0 16V	Petrol	107	11/00 → 08/07	ENGINE: CJBA,CJBB		AMM19780	B4
2.0 16V	Petrol	107	11/00 → 08/07	ENGINE: ZETEC2016VEFI		SVF008	B6
2.0 16V	Petrol	107	11/00 → 03/07				
2.0 16V	Petrol	107	11/00 → 08/07				
2.0 16V	Petrol	107	11/00 → 08/07				
2.0 16V	Petrol	107	11/00 → 08/07				
2.0 16V	Petrol	107	11/00 → 08/07	ENGINE: DURATECDOHCEFI			
2.0 16V	Petrol	107	03/05 → 03/07				
2.0 16V DI / TDDi / TDCi	Diesel	66	11/00 → 08/07				
2.0 16V DI / TDDi / TDCi	Diesel	66	11/00 → 08/07				



TYPE

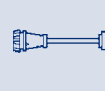

TYPE



TYPE

			ATS24	F2		SAC083	H2	
			ATS24	F2	SAA113	SAC007	H1	
			SPA148	F1		SAC083	H2	
						SAD040	H3	
			ATS24	F2		SAC007	H1	
						SAG171	H1	
						SAG003	H1	
FEI0005			ATS24	F2		SAC007	H1	
						SAC098	H2	
						SAG003	H1	
FEI0005			ATS24	F2		SAC005	H1	
						SAC098	H2	
						SAG003	H1	
FEI0011								
FEI0011								
	APS19		ATS24	F2	SAA115	SAC007	H1	BAE680BZ
	APS19		ATS24	F2	SAA115	SAC007	H1	BAE680BZ
			SPA116	F1		SAD036	H3	
						SAG016	H2	
			SPA116	F1		SAD036	H3	
						SAG016	H2	
						SAC001	H2	
						SAC001	H2	
								BAE680BO
								BAE680BO
			ATS24	F2	SAA115	SAC007	H1	
			SPA116	F1		SAC094	H2	
								BAE680BU
FEI0014								
	APS19		ATS24	F2	SAA115	SAC007	H1	BAE680BZ
			SPA116	F1		SAD036	H3	
						SAG016	H2	
						SAC001	H2	
								BAE680BO
			ATS24	F2	SAA113	SAC007	H1	
			SPA148	F1		SAD040	H3	



KW

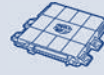

TYPE



TYPE

FORD

MONDEO III Station wagon (BWY)

2.0 16V DI / TDDi / TDCi	Diesel	66	03/06 → 08/07					
2.0 16V TDDi / TDCi	Diesel	85	11/00 → 08/07	ENGINE: DURATORQ20TDCI			AMM19664	B4
2.0 16V TDDi / TDCi	Diesel	85	11/00 → 08/07					
2.0 16V TDDi / TDCi	Diesel	85	11/00 → 08/07					
2.0 16V TDDi / TDCi	Diesel	85	09/02 → 08/07					
2.0 TDCi	Diesel	96	10/01 → 08/07	ENGINE: DURATORQ20TDCI			AMM19664	B4
2.0 TDCi	Diesel	96	10/01 → 08/07					
2.0 TDCi	Diesel	96	10/01 → 08/07					
2.0 TDCi	Diesel	96	05/02 → 08/07					
2.2 TDCi	Diesel	114	09/04 → 08/07	ENGINE: DURATORQ22TDCI			AMM19665	B4
2.2 TDCi	Diesel	110	09/04 → 08/07					
2.2 TDCi	Diesel	114	09/04 → 08/07					
2.2 TDCi	Diesel	114	09/04 → 08/07					
2.2 TDCi	Diesel	114	09/04 → 08/07					
2.5 V6 24V	Petrol	125	11/00 → 08/07				SVF008	B6
2.5 V6 24V	Petrol	125	03/03 → 03/03					
3.0 V6 24V	Petrol	150	09/04 → 08/07					
3.0 V6 24V	Petrol	150	09/04 → 08/07					
3.0 V6 24V	Petrol	150	09/04 → 08/07	ENGINE: DURATECSE30LEFI				
ST220	Petrol	166	04/02 → 08/07					
ST220	Petrol	166	04/02 → 08/07					
ST220	Petrol	166	03/03 → 03/03	ENGINE: DURATECST30LEFI				

MONDEO III Tre volumi (B4Y)

1.8 16V	Petrol	81	11/00 → 08/07	ENGINE: CGBA,CGBB			AMM19780	B4
1.8 16V	Petrol	81	11/00 → 08/07	ENGINE: DURATECHE18SCI			SVF008	B6
1.8 16V	Petrol	92	11/00 → 08/07	ENGINE: CHBA,CHBB			AMM19780	B4
1.8 16V	Petrol	92	11/00 → 08/07	ENGINE: DURATECHE18SCI			SVF008	B6
1.8 16V	Petrol	81	11/00 → 03/07					
1.8 16V	Petrol	92	11/00 → 03/07					
1.8 16V	Petrol	81	11/00 → 08/07					
1.8 16V	Petrol	92	11/00 → 08/07					
1.8 16V	Petrol	81	11/00 → 08/07					
1.8 16V	Petrol	81	11/00 → 08/07					
1.8 16V	Petrol	92	11/00 → 08/07					
1.8 16V	Petrol	92	11/00 → 08/07					
1.8 16V	Petrol	81	11/00 → 08/07	ENGINE: DURATECDOHCEFI				
1.8 16V	Petrol	92	11/00 → 08/07	ENGINE: DURATECDOHCEFI				
1.8 16V	Petrol	81	03/05 → 03/07					
1.8 16V	Petrol	92	03/05 → 03/07					
1.8 SCi	Petrol	96	06/03 → 08/07					
1.8 SCi	Petrol	96	06/03 → 08/07					
1.8 SCi	Petrol	96	06/03 → 03/07					
2.0 16V	Petrol	107	11/00 → 08/07	ENGINE: CJBA,CJBB			AMM19780	B4
2.0 16V	Petrol	107	11/00 → 08/07	ENGINE: ZETEC2016VEFI			SVF008	B6



KW



TYPE



TYPE

FORD

MONDEO III Tre volumi (B4Y)

2.0 16V	Petrol	107	11/00 → 03/07					
2.0 16V	Petrol	107	11/00 → 08/07					
2.0 16V	Petrol	107	11/00 → 08/07					
2.0 16V	Petrol	107	11/00 → 08/07					
2.0 16V	Petrol	107	11/00 → 08/07	ENGINE: DURATECDOHCEFI				
2.0 16V	Petrol	107	03/05 → 03/07					
2.0 16V DI / TDDi / TDCi	Diesel	66	11/00 → 08/07					
2.0 16V DI / TDDi / TDCi	Diesel	66	11/00 → 08/07					
2.0 16V DI / TDDi / TDCi	Diesel	66	03/06 → 08/07					
2.0 16V TDDi / TDCi	Diesel	85	11/00 → 08/07	ENGINE: DURATORQ20TDCI		AMM19664		B4
2.0 16V TDDi / TDCi	Diesel	85	11/00 → 08/07					
2.0 16V TDDi / TDCi	Diesel	85	11/00 → 08/07					
2.0 16V TDDi / TDCi	Diesel	85	09/02 → 08/07					
2.0 TDCi	Diesel	96	10/01 → 08/07	ENGINE: DURATORQ20TDCI		AMM19664		B4
2.0 TDCi	Diesel	92	02/03 → 06/05					
2.0 TDCi	Diesel	96	10/01 → 08/07					
2.0 TDCi	Diesel	96	10/01 → 08/07					
2.0 TDCi	Diesel	96	05/02 → 08/07					
2.2 TDCi	Diesel	114	09/04 → 08/07	ENGINE: DURATORQ22TDCI		AMM19665		B4
2.2 TDCi	Diesel	110	09/04 → 08/07					
2.2 TDCi	Diesel	114	09/04 → 08/07					
2.2 TDCi	Diesel	114	09/04 → 08/07					
2.2 TDCi	Diesel	114	09/04 → 08/07					
2.5 V6 24V	Petrol	125	11/00 → 08/07			SVF008		B6
2.5 V6 24V	Petrol	125	03/03 → 03/03					
3.0 V6 24V	Petrol	150	09/04 → 08/07					
3.0 V6 24V	Petrol	150	09/04 → 08/07					
3.0 V6 24V	Petrol	150	09/04 → 08/07	ENGINE: DURATECSE30LEFI				
ST220	Petrol	166	04/02 → 08/07					
ST220	Petrol	166	04/02 → 08/07					
ST220	Petrol	166	03/03 → 03/03	ENGINE: DURATECST30LEFI				

MONDEO IV (BA7)

1.6 Ti	Petrol	81	03/07 → 08/10					
1.6 Ti	Petrol	92	03/07 → 08/10					
1.6 Ti	Petrol	81	03/07 →					
1.6 Ti	Petrol	92	03/07 →					
1.6 Ti	Petrol	81	03/07 →					
1.6 Ti	Petrol	92	03/07 →					
1.6 Ti	Petrol	81	03/07 →	ENGINE: RHBA				
1.6 Ti	Petrol	92	03/07 →	ENGINE: PNBA				
1.8 TDCi	Diesel	74	03/07 →			AMM19656		B4
1.8 TDCi	Diesel	74	03/07 →					
1.8 TDCi	Diesel	74	03/07 →	ENGINE: FFBA				
2.0	Petrol	107	03/07 →					



TYPE



TYPE



TYPE

FEI0014										
	APS19		ATS24	F2	SAA115	SAC007	H1	BAE680BZ		
			SPA116	F1		SAD036	H3			
						SAG016	H2			
						SAC001	H2			
								BAE680BO		
			ATS24	F2	SAA113	SAC007	H1			
			SPA148	F1		SAD040	H3			
						SAC083	H2			
						SAG002	H1			
			ATS24	F2	SAA113	SAC007	H1			
			SPA148	F1		SAD040	H3			
						SAC083	H2			
			ATS24	F2		SAC007	H1			
			ATS24	F2	SAA113	SAC007	H1			
			SPA148	F1		SAD040	H3			
						SAC083	H2			
			ATS24	F2		SAC083	H2			
			ATS24	F2	SAA113	SAC007	H1			
			SPA148	F1		SAC083	H2			
						SAD040	H3			
			ATS24	F2		SAC007	H1			
						SAG003	H1			
FEI0005			ATS24	F2		SAC007	H1			
						SAC098	H2			
						SAG003	H1			
FEI0005			ATS24	F2		SAC005	H1			
						SAC098	H2			
						SAG003	H1			
FEI0017										
FEI0017										
					SAA115	SAC092	H2	BAE680DX		
					SAA115	SAC092	H2	BAE680DX		
						SAD037	H3			
						SAD037	H3			
									GA2238	J2
									GA2238	J2
	APS78		ATS22	F2	SAA115					
			SPA158	F1						
						SAC074	H2			
FEI0014	APS19				SAA115	SAD036	H3	BAE680DW		



KW

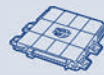

TYPE



TYPE

FORD

MONDEO IV (BA7)

2.0	Petrol	107	03/07 →	ENGINE: AOBC,AOBA,TBBA				
2.0 Flexifuel	Petrol/Ethanol	107	03/09 →					
2.0 SCTi	Petrol	149	03/10 → 01/11					
2.0 TDCi	Diesel	103	03/07 →			AMM19656	B4	
2.0 TDCi	Diesel	103	03/07 →	ENGINE: QXBA		50CDSF5	B3	
2.0 TDCi	Diesel	103	03/07 →	ENGINE: QXBB		50CDSP3/F	B3	
2.0 TDCi	Diesel	85	11/07 →			AMM19656	B4	
2.0 TDCi	Diesel	96	03/07 →			AMM19656	B4	
2.0 TDCi	Diesel	103	03/07 →					
2.0 TDCi	Diesel	85	11/07 →					
2.0 TDCi	Diesel	96	03/07 →					
2.2 TDCi	Diesel	129	03/08 →			AMM19656	B4	
2.3	Petrol	118	07/07 →					
2.3	Petrol	118	07/07 →					
2.5	Petrol	162	03/07 →					
2.5	Petrol	162	03/07 →					
2.5	Petrol	162	03/07 → 08/09					

MONDEO IV Tre volumi (BA7)

1.6 TDCi	Diesel	85	12/10 →	ENGINE: T1BA,T1BB,T1BC				
1.6 Ti	Petrol	92	03/07 →	ENGINE: PNBA		AMM19770	B4	
1.6 Ti	Petrol	81	03/07 → 08/10					
1.6 Ti	Petrol	92	03/07 → 08/10					
1.6 Ti	Petrol	81	03/07 →					
1.6 Ti	Petrol	92	03/07 →					
1.8 TDCi	Diesel	74	03/07 →					
1.8 TDCi	Diesel	74	03/07 →	ENGINE: FFBA				
2.0	Petrol	107	03/07 →					
2.0	Petrol	107	03/07 →	ENGINE: AOBC,AOBA,TBBA				
2.0 Flexifuel	Petrol/Ethanol	107	03/09 →					
2.0 TDCi	Diesel	103	03/07 →			AMM19656	B4	
2.0 TDCi	Diesel	103	03/07 →	ENGINE: QXBA		50CDSF5	B3	
2.0 TDCi	Diesel	103	03/07 →	ENGINE: QXBB		50CDSP3/F	B3	
2.0 TDCi	Diesel	85	11/07 →			AMM19656	B4	
2.0 TDCi	Diesel	96	03/07 →			AMM19656	B4	
2.0 TDCi	Diesel	85	11/07 →					
2.0 TDCi	Diesel	96	03/07 →					
2.2 TDCi	Diesel	129	03/08 →			AMM19656	B4	
2.3	Petrol	118	07/07 →					
2.3	Petrol	118	07/07 →					
2.5	Petrol	162	03/07 →					
2.5	Petrol	162	03/07 →					
2.5	Petrol	162	03/07 → 08/09					



TYPE

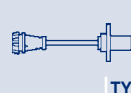

TYPE



TYPE

										GA2238	J2
	APS19				SAA115	SAD036	H3				
										BAE680DY	
			ATS22	F2	SAA118	SAC096	H2				
			ATS22	F2	SAA118	SAC096	H2				
			ATS22	F2	SAA118	SAC096	H2				
						SAG169	H1				
						SAG169	H1				
						SAG169	H1				
	APS58		ATS22	F2	SAA118	SAG168	H1				
FEI0007					SAA115	SAC023	H2			BAE680CM	
						SAD036	H3				
						SAC033	H2				
						SAD039	H3				
						SAC090	H2				
						SAC099	H2				
										GA2238	J2
FEI0017										BAE680DX	
FEI0017										BAE680DX	
						SAC092	H2				
						SAC092	H2				
	APS78										
						SAC074	H2				
FEI0014	APS19				SAA115	SAD036	H3			BAE680DW	
										GA2238	J2
	APS19					SAD036	H3				
			ATS22	F2	SAA118	SAC096	H2				
			ATS22	F2		SAC096	H2				
			ATS22	F2	SAA118	SAC096	H2				
						SAG169	H1				
						SAG169	H1				
	APS58		ATS22	F2	SAA118	SAG168	H1				
FEI0007					SAA115	SAC023	H2			BAE680CM	
						SAD036	H3				
						SAC033	H2				
						SAD039	H3				
						SAC090	H2				



KW



TYPE



TYPE

FORD

MONDEO IV Turnier (BA7)

1.6 Ti	Petrol	81	03/07 → 08/10					
1.6 Ti	Petrol	92	03/07 → 08/10					
1.6 Ti	Petrol	81	03/07 →					
1.6 Ti	Petrol	92	03/07 →					
1.6 Ti	Petrol	81	03/07 →					
1.6 Ti	Petrol	92	03/07 →					
1.6 Ti	Petrol	81	03/07 →	ENGINE: RHBA				
1.6 Ti	Petrol	92	03/07 →	ENGINE: PNBA				
1.8 TDCi	Diesel	74	03/07 →				AMM19656	B4
1.8 TDCi	Diesel	74	03/07 →					
1.8 TDCi	Diesel	74	03/07 →	ENGINE: FFBA				
2.0	Petrol	107	03/07 →					
2.0	Petrol	107	03/07 →	ENGINE: AOBC,AOBA,TBBA				
2.0 Flexifuel	Petrol/Ethanol	107	03/09 →					
2.0 SCTi	Petrol	149	03/10 → 01/11					
2.0 TDCi	Diesel	103	03/07 →				AMM19656	B4
2.0 TDCi	Diesel	103	03/07 →	ENGINE: QXBA			50CDSF5	B3
2.0 TDCi	Diesel	103	03/07 →	ENGINE: QXBB			50CDSP3/F	B3
2.0 TDCi	Diesel	85	11/07 →				AMM19656	B4
2.0 TDCi	Diesel	96	03/07 →				AMM19656	B4
2.0 TDCi	Diesel	103	03/07 →					
2.0 TDCi	Diesel	85	11/07 →					
2.0 TDCi	Diesel	96	03/07 →					
2.2 TDCi	Diesel	129	03/08 →				AMM19656	B4
2.3	Petrol	118	07/07 →					
2.3	Petrol	118	07/07 →					
2.5	Petrol	162	03/07 →					
2.5	Petrol	162	03/07 →					
2.5	Petrol	162	03/07 → 08/09					

ORION I (AFD)

1.3	Petrol	51	07/83 → 03/86					
1.6 i	Petrol	77	07/83 → 03/86					

ORION II (AFF)

1.6 i	Petrol	77	03/86 → 07/90					
-------	--------	----	---------------	--	--	--	--	--

ORION III (GAL)

1.3	Petrol	44	07/90 → 12/93					
1.3	Petrol	44	07/90 → 12/93					
1.3	Petrol	44	09/90 → 08/92					
1.4	Petrol	52	07/90 → 12/93					
1.4	Petrol	54	07/90 → 12/93					
1.4	Petrol	52	07/90 → 12/93					
1.6	Petrol	66	07/90 → 12/92	ENGINE: ZETEC-E			SVF006	B6
1.6	Petrol	66	07/90 → 12/92					
1.6 i	Petrol	77	07/90 → 09/92	ENGINE: ZETEC-E			SVF006	B6



TYPE

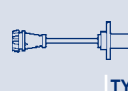

TYPE



TYPE

FEI0017								BAE680DX		
FEI0017								BAE680DX		
					SAA115	SAC092	H2			
					SAA115	SAC092	H2			
						SAD037	H3			
						SAD037	H3			
									GA2238	J2
									GA2238	J2
	APS78		ATS22	F2	SAA115					
			SPA158	F1						
						SAC074	H2			
FEI0014	APS19				SAA115	SAD036	H3	BAE680DW		
									GA2238	J2
	APS19					SAD036	H3			
								BAE680DY		
			ATS22	F2	SAA118	SAC096	H2			
			ATS22	F2	SAA118	SAC096	H2			
			ATS22	F2	SAA118	SAC096	H2			
						SAG169	H1			
						SAG169	H1			
						SAG169	H1			
	APS58		ATS22	F2	SAA118	SAG168	H1			
FEI0007					SAA115	SAC023	H2	BAE680CM		
						SAD036	H3			
						SAC033	H2			
						SAD039	H3			
						SAC090	H2			
					SAA112					
					SAA112					
					SAA112					
			ATS24	F2	SAA112	SAG176	H1			
			SPA151	F1						
			ATS24	F2						
			ATS24	F2	SAA112	SAG177	H1			
			ATS24	F2		SAG176	H1			
			SPA151	F1						
			ATS24	F2	SAA112	SAG177	H1			



KW



TYPE



TYPE

FORD

ORION III (GAL)

1.6 i	Petrol	77	07/90 → 09/92					
1.6 i	Petrol	77	07/90 → 09/92					
1.6 i 16V	Petrol	66	07/92 → 12/93			AMM19766	B4	
1.6 i 16V	Petrol	66	07/92 → 12/93					
1.8 D	Diesel	44	11/90 → 12/93					
1.8 D	Diesel	44	11/90 → 12/93					
1.8 i 16V	Petrol	77	02/92 → 12/93					
1.8 i 16V	Petrol	77	02/92 → 12/93	ENGINE: ZETEC-EDOHCEFI				
1.8 TD	Diesel	66	03/92 → 12/93					

P 100 II

1.8 TD	Diesel	55	10/87 → 12/92					
2.0	Petrol	57	10/87 → 12/92					

PUMA (EC_)

1.4 16V	Petrol	66	11/97 → 10/00	ENGINE: CVH		SVF006	B6	
1.4 16V	Petrol	66	11/97 → 10/00					
1.4 16V	Petrol	66	01/98 → 10/00					
1.4 16V	Petrol	66	11/97 → 10/00	ENGINE: FHD,FHF				
1.4 16V	Petrol	66	11/97 → 10/00	ENGINE: ZETEC-S				
1.6 16V	Petrol	76	08/00 → 06/02	ENGINE: ZETECROCAM16SOHC		SVF008	B6	
1.6 16V	Petrol	76	08/00 → 12/01					
1.6 16V	Petrol	76	08/00 → 06/02					
1.6 16V	Petrol	76	08/00 → 06/02	ENGINE: L1W				
1.6 16V	Petrol	76	08/00 → 06/02	ENGINE: ZETECEFI				
ST 160	Petrol	118	06/99 → 06/02	ENGINE: EFIZETECZH17				

RANGER (ER, EQ)

1.8	Petrol	85	06/99 → 02/02					
2.5 D	Diesel	57	10/99 → 04/02					
2.5 D 4x4	Diesel	57	10/99 → 04/02					
2.5 TD	Diesel	62	04/02 → 06/06					
2.5 TD 4x4	Diesel	80	10/99 → 06/06					
2.5 TD 4x4	Diesel	62	04/02 → 06/06					

SCORPIO I (GAE, GGE)

1.8	Petrol	66	04/85 → 02/92					
2.0	Petrol	77	04/85 → 08/89					
2.0	Petrol	80	11/88 → 10/92					
2.0 i	Petrol	74	10/85 → 12/90					
2.0 i	Petrol	85	02/92 → 09/94					
2.0 i	Petrol	85	04/85 → 02/92					
2.0 i	Petrol	88	05/89 → 09/94					
2.0 i	Petrol	85	02/92 → 09/94	ENGINE: DOHC(8V)				
2.0 i	Petrol	88	05/89 → 09/94	ENGINE: DOHC(8V)				
2.4 i	Petrol	92	10/88 → 02/92					
2.4 i	Petrol	96	09/86 → 09/88					

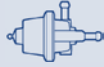

TYPE



TYPE



TYPE

				ATS24	F2	SAA112	SAG177	H1		ESS0083A	J1
				SPA151	F1						
				ATS24	F2	SAA112	SAC002	H2	BAE680AE	ESS0014A	J1
				SPA151	F1		SAG176	H1			
				ATS24	F2	SAA112	SAG176	H1			
				SPA151	F1						
				ATS24	F2	SAA112	SAG177	H1	BAE680AE	ESS0014A	J1
							SAC002	H2			
				ATS24	F2	SAA112	SAG176	H1			
						SAA112					
						SAA112					
FEI0012				SPA170	F1	SAA112			BAE680AE	SUA487	J1
			RP08A								
							SAC097	H2			
							SAC003	H2			
FEI0017				SPA113	F1	SAA112					
							SAC097	H2			
							SAC003	H2			
										SUA487	J1
							SAG177	H1			
				SPA168	F1						
				SPA168	F1						
							SAG034	H1			
				SPA168	F1						
							SAG034	H1			
				ATS24	F2						
				ATS24	F2						
				ATS24	F2						
				ATS24	F2						
				ATS24	F2	SAA112					
				ATS24	F2						
				ATS24	F2	SAA112					
							SAG004	H1			
							SAG004	H1			
				ATS24	F2					ESS0014A	J1
				ATS24	F2	SAA112					



KW



TYPE



TYPE

FORD

SCORPIO I (GAE, GGE)

Model	Fuel	KW	Period	Engine	Accessories	Notes
2.4 i Cat.	Petrol	92	10/88 → 09/94			
2.5 D	Diesel	51	12/85 → 02/92			
2.5 TD	Diesel	68	06/88 → 07/93			
2.5 TD	Diesel	85	08/93 → 09/94			
2.8 i	Petrol	110	04/85 → 11/86			
2.8 i 4x4	Petrol	110	10/85 → 11/86			
2.9 i	Petrol	107	09/86 → 09/94			
2.9 i	Petrol	110	09/86 → 09/94			
2.9 i 24V	Petrol	143	04/91 → 09/94			
2.9 i 4x4	Petrol	107	05/88 → 02/93			
2.9 i 4x4	Petrol	110	09/86 → 09/94			
2.9 i Cat.	Petrol	107	10/87 → 09/94			

SCORPIO I Station wagon (GGE)

Model	Fuel	KW	Period	Engine	Accessories	Notes
2.0 i	Petrol	85	09/91 → 09/94			
2.0 i	Petrol	85	09/91 → 09/94			
2.0 i	Petrol	88	09/91 → 09/94			
2.0 i	Petrol	88	09/91 → 09/94			
2.0 i	Petrol	85	09/91 → 09/94	ENGINE: DOHC(8V)		
2.0 i	Petrol	88	09/91 → 09/94	ENGINE: DOHC(8V)		
2.4 i	Petrol	92	09/91 → 09/94			
2.4 i	Petrol	92	09/91 → 09/94			
2.5 D	Diesel	51	10/90 → 08/92			
2.5 TD	Diesel	68	09/91 → 07/93			
2.5 TD	Diesel	85	08/93 → 09/94			
2.9 24V	Petrol	143	08/93 → 09/94			
2.9 24V	Petrol	143	08/93 → 09/94			
2.9 i	Petrol	107	09/91 → 09/94			
2.9 i	Petrol	107	09/91 → 09/94			
2.9 i 4x4	Petrol	107	05/88 → 02/93			
2.9 i 4x4	Petrol	107	05/88 → 02/93			

SCORPIO I Tre volumi (GGE)

Model	Fuel	KW	Period	Engine	Accessories	Notes
1.8	Petrol	66	01/86 → 10/88			
1.9	Petrol	85	11/92 → 09/93			
2.0	Petrol	77	03/90 → 08/92			
2.0	Petrol	80	06/89 → 03/93			
2.0 i	Petrol	85	02/92 → 09/94			
2.0 i	Petrol	85	02/92 → 09/94			
2.0 i	Petrol	88	05/89 → 09/94			
2.0 i	Petrol	88	05/89 → 09/94			
2.0 i	Petrol	92	05/89 → 02/92			
2.0 i	Petrol	92	05/89 → 02/92			
2.0 i	Petrol	85	02/92 → 09/94	ENGINE: DOHC(8V)		
2.0 i	Petrol	88	05/89 → 09/94	ENGINE: DOHC(8V)		
2.4 i	Petrol	92	10/88 → 10/94			

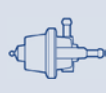

TYPE

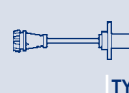

TYPE



TYPE

				ATS24	F2						ESS0014A	J1
				ATS24	F2							
				ATS24	F2							
				ATS24	F2							
				ATS24	F2							
				ATS24	F2	SAA112					ESS0014A	J1
				ATS24	F2	SAA112					ESS0014A	J1
				ATS24	F2	SAA112					ESS0014A	J1
				ATS24	F2	SAA112						
				ATS24	F2	SAA112						
				ATS24	F2	SAA112					ESS0014A	J1
				ATS24	F2	SAA112						
				SPA151	F1							
				ATS24	F2	SAA112						
				SPA151	F1							
								SAG004	H1			
								SAG004	H1			
				ATS24	F2						ESS0014A	J1
				SPA151	F1							
				ATS24	F2							
				ATS24	F2							
				ATS24	F2	SAA112					ESS0014A	J1
				SPA151	F1							
				ATS24	F2	SAA112					ESS0014A	J1
				SPA151	F1							
				ATS24	F2	SAA112						
				SPA151	F1							
				ATS24	F2							
				ATS24	F2							
				ATS24	F2							
				ATS24	F2	SAA112						
				SPA151	F1							
				ATS24	F2	SAA112						
				SPA151	F1							
				ATS24	F2							
				SPA151	F1							
								SAG004	H1			
								SAG004	H1			
				ATS24	F2						ESS0014A	J1



KW



TYPE



TYPE

FORD

SCORPIO I Tre volumi (GGE)

2.4 i	Petrol	92	10/88 → 10/94					
2.5 D	Diesel	51	12/89 → 12/94					
2.5 TD	Diesel	68	06/88 → 07/93					
2.5 TD	Diesel	85	08/93 → 09/94					
2.9	Petrol	107	09/92 → 09/94					
2.9 i 24V	Petrol	143	04/91 → 09/94					
2.9 i 24V	Petrol	143	04/91 → 09/94					
2.9 i 4x4	Petrol	107	12/89 → 10/94					
2.9 i 4x4	Petrol	107	12/89 → 10/94					

SCORPIO II (GFR, GGR)

2.0 i	Petrol	85	10/94 → 08/98	ENGINE: DOHC20			AMM19657	B4
2.0 i	Petrol	85	10/94 → 08/98					
2.0 i	Petrol	85	10/94 → 08/98	ENGINE: NSD				
2.0 i	Petrol	85	10/94 → 08/98	ENGINE: DOHC(8V)				
2.0 i 16V	Petrol	100	10/94 → 08/98				AMM19657	B4
2.0 i 16V	Petrol	100	10/94 → 04/96				B3398	B1
2.0 i 16V	Petrol	100	10/94 → 08/98					
2.0 i 16V	Petrol	100	06/95 → 08/98					
2.0 i 16V	Petrol	100	10/94 → 08/98	ENGINE: N3A				
2.5 TD	Diesel	85	10/94 → 08/98					
2.5 TD	Diesel	85	01/95 → 08/98					
2.9 i	Petrol	110	02/95 → 08/98					
2.9 i 24V	Petrol	152	10/94 → 08/98					

SCORPIO II Station wagon (GNR, GGR)

2.0 i	Petrol	85	10/94 → 08/98				AMM19657	B4
2.0 i	Petrol	85	10/94 → 08/98	ENGINE: NSD				
2.0 i	Petrol	85	10/94 → 08/98	ENGINE: DOHC(8V)				
2.0 i 16V	Petrol	100	10/94 → 08/98				AMM19657	B4
2.0 i 16V	Petrol	100	10/94 → 04/96				B3398	B1
2.0 i 16V	Petrol	100	10/94 → 08/98					
2.0 i 16V	Petrol	100	06/95 → 08/98					
2.0 i 16V	Petrol	100	10/94 → 08/98	ENGINE: N3A				
2.5 TD	Diesel	85	10/94 → 08/98					
2.5 TD	Diesel	85	01/95 → 08/98					
2.9 i	Petrol	110	02/95 → 08/98					
2.9 i 24V	Petrol	152	10/94 → 08/98					

SIERRA (GBG, GB4)

2.0 4x4	Petrol	92	12/92 → 02/93				SVF001	B6
2.0 4x4	Petrol	92	01/90 → 02/93					
2.0 i	Petrol	74	01/87 → 12/89				SVF001	B6
2.0 i	Petrol	92	12/92 → 02/93				SVF001	B6
2.0 i	Petrol	92	01/90 → 02/93					
2.8 i	Petrol	105	08/87 → 02/93					
2.9 4x4	Petrol	107	08/88 → 02/93					



KW



TYPE



TYPE

FORD

SIERRA (GBG, GB4)

2.9 4x4	Petrol	110	08/88 → 02/93				
2.9 i	Petrol	110	08/88 → 02/93				

SIERRA 2 volumi /Coda spiovente (GBC)

1.3	Petrol	44	08/82 → 12/86				
1.8	Petrol	66	10/84 → 12/86				
2.0	Petrol	77	08/82 → 12/86				
2.0 4x4	Petrol	150	01/86 → 12/86	ENGINE: N5B			
2.0 i	Petrol	85	03/85 → 12/86				

SIERRA 2 volumi /Coda spiovente (GBC, GBG)

2.0 16V Cosworth 4x4	Petrol	162	01/90 → 02/93				
2.0 4x4	Petrol	88	10/91 → 03/93				
2.0 i	Petrol	74	12/92 → 02/93			SVF001	B6
2.0 i	Petrol	92	12/92 → 02/93			SVF001	B6
2.0 i	Petrol	74	01/87 → 02/93				
2.0 i	Petrol	80	06/89 → 02/93				
2.0 i	Petrol	92	06/89 → 02/93				
2.0 i	Petrol	92	06/89 → 02/93	ENGINE: DOHC(8V)			
2.8 i	Petrol	105	01/87 → 02/93				
2.8 i XR 4x4	Petrol	107	01/87 → 02/93				
2.8 i XR 4x4	Petrol	110	01/87 → 08/88				

SIERRA Station wagon (BNC)

1.8	Petrol	66	10/84 → 12/86				
-----	--------	----	---------------	--	--	--	--

SIERRA Station wagon (BNG)

1.6 i	Petrol	59	12/92 → 02/93			SVF001	B6
1.6 i	Petrol	59	10/89 → 02/93				
1.6 i	Petrol	59	10/89 → 09/90	ENGINE: DOHC(8V)			
1.8	Petrol	64	05/88 → 02/93				
1.8 TD	Diesel	55	08/88 → 02/93				
2.0	Petrol	77	01/87 → 02/93				
2.0 4x4	Petrol	88	12/92 → 02/93			SVF001	B6
2.0 4x4	Petrol	92	12/92 → 02/93			SVF001	B6
2.0 4x4	Petrol	88	02/90 → 02/93				
2.0 4x4	Petrol	92	05/89 → 02/93				
2.0 i	Petrol	74	12/92 → 02/93			SVF001	B6
2.0 i	Petrol	85	12/92 → 02/93			SVF001	B6
2.0 i	Petrol	88	12/92 → 02/93			SVF001	B6
2.0 i	Petrol	92	12/92 → 02/93			SVF001	B6
2.0 i	Petrol	74	01/87 → 02/93				
2.0 i	Petrol	85	01/87 → 02/93				
2.0 i	Petrol	88	05/89 → 02/93				
2.0 i	Petrol	92	05/89 → 02/93				
2.0 i Cat.	Petrol	74	12/92 → 02/93			SVF001	B6
2.0 i Cat.	Petrol	74	01/87 → 02/93				
2.8 4x4	Petrol	110	01/87 → 08/88				

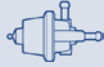

TYPE



TYPE



TYPE

				SPA151	F1		SAG177	H1	ESS0083A	J1
				SPA151	F1		SAG177	H1	ESS0014A	J1
							SAA112			
							SAA112			
							SAA112		ESS0117A	J1
							SAA112			
				SPA151	F1		SAG177	H1		
							SAG177	H1		
				SPA151	F1				ESS0014A	J1
				SPA151	F1				ESS0014A	J1
				SPA151	F1	SAA112			ESS0014A	J1
							SAG004	H1		
				SPA151	F1					
				SPA151	F1					
							SAG177	H1		
							SAA112			
							SAA112			
							SAA112			
							SAA112			
							SAG004	H1		
							SAA112			
							SAA112			
							SAA112			
				SPA151	F1		SAG177	H1	ESS0083A	J1
				SPA151	F1		SAG177	H1	ESS0083A	J1
				SPA151	F1				ESS0014A	J1
				SPA151	F1				ESS0014A	J1
				SPA151	F1		SAG177	H1	ESS0014A	J1
				SPA151	F1		SAG177	H1	ESS0014A	J1
				SPA151	F1				ESS0014A	J1
							SAG177	H1		



KW



TYPE



TYPE

FORD

SIERRA Station wagon (BNG)

2.8 4x4	Petrol	110	01/87 → 08/88	ENGINE: PRG				
2.8 i	Petrol	105	01/87 → 02/93					
2.8 i	Petrol	107	01/87 → 02/93					
2.8 i 4x4	Petrol	107	01/87 → 02/93					
2.9	Petrol	107	08/88 → 02/93					
2.9 4x4	Petrol	107	08/88 → 02/93					
2.9 4x4	Petrol	110	08/88 → 02/93					
2.9 i	Petrol	110	08/88 → 02/93					

S-MAX (WA6)

1.8 TDCi	Diesel	92	05/06 →				AMM19656	B4
1.8 TDCi	Diesel	92	05/06 →					
1.8 TDCi	Diesel	92	05/06 →	ENGINE: QYWA				
2.0	Petrol	107	05/06 →					
2.0	Petrol	107	05/06 →					
2.0	Petrol	107	05/06 →	ENGINE: AOWB,AOWA				
2.0 EcoBoost	Petrol	149	03/10 → 04/11					
2.0 Flexifuel	Petrol/Ethanol	107	05/06 →					
2.0 TDCi	Diesel	103	05/06 →				AMM19656	B4
2.0 TDCi	Diesel	103	05/06 →	ENGINE: QXWC,UFWA,QXWA,QXWB			50CDSP3/F	B3
2.0 TDCi	Diesel	85	11/07 →				AMM19656	B4
2.0 TDCi	Diesel	96	05/06 →				AMM19656	B4
2.0 TDCi	Diesel	103	05/06 →					
2.0 TDCi	Diesel	85	11/07 →					
2.0 TDCi	Diesel	96	05/06 →					
2.2 TDCi	Diesel	129	03/08 →					
2.3	Petrol	118	07/07 →					
2.3	Petrol	118	07/07 →					
2.5 ST	Petrol	162	05/06 →					
2.5 ST	Petrol	162	05/06 →					

STREET KA (RL2)

1.6	Petrol	70	05/03 → 07/05					
1.6	Petrol	70	05/03 → 07/05					
1.6	Petrol	70	05/03 → 07/05	ENGINE: ZETEC-S				

TAUNUS '80 Turnier (GBNS)

1.6	Petrol	54	07/79 → 07/82					
-----	--------	----	---------------	--	--	--	--	--

TOURNEO CONNECT

1.8 16V	Petrol	85	06/02 →				VAE3391	B2
1.8 16V	Petrol	85	06/02 →	ENGINE: EYPA,EYPC,EYPD			AMM19780	B4
1.8 Di	Diesel	55	08/06 →				AMM19656	B4
1.8 Di	Diesel	55	06/02 →					
1.8 TDCi	Diesel	81	08/06 →				AMM19656	B4
1.8 TDCi	Diesel	81	08/06 →	ENGINE: RWPA,RWPC,RWPD				
1.8 Turbo Di	Diesel	66	08/06 →				AMM19656	B4



TYPE

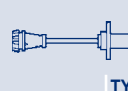

TYPE



TYPE

									ESS0117A	J1
			SPA151	F1						
			SPA151	F1						
			SPA151	F1						
			SPA151	F1		SAG177	H1			
			SPA151	F1		SAG177	H1			
			SPA151	F1		SAG177	H1	ESS0083A		J1
			SPA151	F1		SAG177	H1	ESS0014A		J1
	APS78		ATS22	F2	SAA115	SAD041	H3			
			SPA158	F1						
						SAC074	H2			
FEI0014	APS19				SAA115	SAD036	H3	BAE680DW		
						SAG016	H2			
								GA2238		J2
								BAE680DY		
	APS19				SAA115	SAD036	H3			
			ATS22	F2	SAA118	SAC096	H2			
			ATS22	F2	SAA118	SAC096	H2			
			ATS22	F2	SAA118	SAC096	H2			
			SPA172	F1		SAG169	H1			
			SPA172	F1		SAG169	H1			
			SPA172	F1		SAG169	H1			
	APS58		ATS22	F2	SAA118	SAG168	H1			
FEI0007					SAA115	SAC023	H2	BAE680CM		
						SAD036	H3			
						SAC033	H2			
						SAD039	H3			
FEI0008	APS13		ATS24	F2	SAA113	SAG175	H1	BAE680BZ		
			SPA153	F1						
						SAG008	H1			
					SAA112					
	RP04A				SAA113			BAE680AE		
			SPA158	F1	SAA115	SAD040	H3			
			SPA158	F1	SAA115	SAD040	H3			
						SAG179	H1			



KW



TYPE



TYPE

FORD

TOURNEO CONNECT

1.8 Turbo Di	Diesel	66	06/02 →						
1.8 Turbo Di	Diesel	66	06/02 →	ENGINE: HCPA,HCPB, RWPE,RWPF,P9PA,P9PB, P9PC,P9PD,R3PA					

TRANSIT Autobus

2.2 TDCi	Diesel	103	10/07 →				AMM19656	B4
2.2 TDCi	Diesel	63	04/06 →				AMM19656	B4
2.2 TDCi	Diesel	81	04/06 →				AMM19656	B4
2.2 TDCi	Diesel	96	04/06 →				AMM19656	B4
2.2 TDCi	Diesel	63	04/06 →					
2.2 TDCi	Diesel	81	04/06 →					
2.2 TDCi	Diesel	96	04/06 →					
2.2 TDCi	Diesel	103	10/07 →	ENGINE: PGFA				
2.2 TDCi	Diesel	74	10/11 →					
2.2 TDCi	Diesel	85	10/08 →	ENGINE: QVFA				
2.2 TDCi	Diesel	92	10/11 →					
2.2 TDCi (RWD)	Diesel	74	10/11 →					
2.2 TDCi (RWD)	Diesel	92	10/11 →					
2.2 TDCi [RWD]	Diesel	100	10/11 →					
2.4 TDCi	Diesel	74	04/06 →				AMM19656	B4
2.4 TDCi	Diesel	85	04/06 →				AMM19656	B4
2.4 TDCi	Diesel	103	04/06 →					
2.4 TDCi	Diesel	74	04/06 →					
2.4 TDCi	Diesel	85	04/06 →					
2.4 TDCi	Diesel	103	04/06 →					
2.4 TDCi 4x4	Diesel	103	11/06 →				AMM19656	B4
3.2 TDCi	Diesel	147	02/08 →				AMM19656	B4
3.2 TDCi	Diesel	147	02/08 →	ENGINE: 32DDOP				

TRANSIT Autobus (E_ _)

2.0	Petrol	66	09/91 → 09/94					
2.0 (EBL, EBS, ECL, EDS, EDL, EGL, ESS, ESL, EUS)	Petrol	84	09/95 → 03/00					
2.0 (EBL, EBS, ECL, EDS, EDL, EGL, ESS, ESL, EUS)	Petrol	84	09/95 → 03/00	ENGINE: NSF,NSG				
2.0 CNG	Petrol/CNG	84	06/94 → 03/00					
2.0 CNG	Petrol/CNG	84	06/94 → 03/00	ENGINE: NSH				
2.0i (EBL, EDL, EGL, ESS, EUS)	Petrol	72	09/91 → 07/94					
2.5 DI (EBL, ECL, EDS, EDL)	Diesel	56	07/94 → 03/00					
2.5 DI (EBL, ECL, EDS, EDL)	Diesel	56	09/97 → 03/00					
2.5 DI (EBL, EDL, EDS, ESL, ESS)	Diesel	85	08/97 → 03/00					
2.5 DI (EBL, EDL, EDS, ESL, ESS)	Diesel	85	09/97 → 03/00					



TYPE



TYPE



TYPE

				SPA158	F1	SAA115	SAD040	H3		
							SAG179	H1		
				SPA148	F1					
		APS20				SAA113	SAC083	H2		
		APS20				SAA113	SAC083	H2		
		APS20				SAA113	SAC083	H2		
							SAG172	H1		
							SAG172	H1		
							SAG172	H1		
							SAC083	H2		
							SAC083	H2		
							SAC083	H2		
							SAC083	H2		
							SAC083	H2		
							SAC083	H2		
							SAC083	H2		
		APS20				SAA113	SAC083	H2		
		APS20				SAA113	SAC083	H2		
		APS20				SAA113	SAC083	H2		
							SAG172	H1		
							SAG172	H1		
							SAG172	H1		
		APS20				SAA113	SAC083	H2		
		APS20				SAA113				
							SAC083	H2		
						SAA112				
				SPA141	F1	SAA112				
							SAC097	H2		
				SPA141	F1	SAA112				
							SAC097	H2		
						SAA112			ESS0014A	J1
				SPA141	F1	SAA108	SAG101	H1		
				SPA170	F1					
				SPA141	F1	SAA108	SAG101	H1		
				SPA170	F1					



KW



TYPE



TYPE

FORD

TRANSIT Autobus (E_ _)

2.5 DI (EBL, EDS, ESL, ESS, EUS)	Diesel	51	08/94 → 03/00					
2.5 DI (EBL, EDS, ESL, ESS, EUS)	Diesel	51	09/97 → 03/00					
2.5 DI (EBS, EDS, EDL, ESS, EUS)	Diesel	51	08/91 → 07/94					
2.5 DI (EBS, EDS, EGL, ESS, EUS)	Diesel	59	09/91 → 07/94					
2.5 TD (EB_ , ED_ , ES_)	Diesel	55	08/94 → 06/00					
2.5 TD (EBL, EDL, EDS, EGL, ESL, ESS, EUS)	Diesel	63	01/95 → 03/00					
2.5 TD (EBL, EDL, EDS, EGL, ESL, ESS, EUS)	Diesel	63	09/97 → 03/00					
2.5 TD (EBS, EBL, ECL, EDS, EDL, ESS, EUS)	Diesel	63	10/92 → 07/94					
2.5 TD (ECL, EDL, EDS, ESL, ESS, EUS)	Diesel	74	07/94 → 03/00					
2.5 TD (ECL, EDL, EDS, ESL, ESS, EUS)	Diesel	74	09/97 → 03/00					
2.5 TD (ECL, EDS, EDL, EGL, ESS, EUS)	Diesel	74	09/91 → 07/94					
2.9 i	Petrol	107	01/91 → 09/94					

TRANSIT Autobus (FD_ _ , FB_ _ , FS_ _ , FZ_ _ , FC_ _)

2.0 DI (F_E_ , F_F_ , F_G_)	Diesel	55	08/00 → 05/06					
2.0 DI (F_E_ , F_F_ , F_G_)	Diesel	63	08/00 → 05/06					
2.0 DI (F_E_ , F_F_ , F_G_)	Diesel	74	08/00 → 05/06					
2.0 DI (F_E_ , F_F_ , F_G_)	Diesel	55	08/00 → 05/06	ENGINE: D3FA				
2.0 DI (F_E_ , F_F_ , F_G_)	Diesel	74	08/00 → 05/06	ENGINE: ABFA				
2.0 TDCi (F_F_ , F_E_ , F_G_)	Diesel	92	08/02 → 05/06	ENGINE: DURATORQ20TDCI	AMM19664		B4	
2.0 TDCi (F_F_ , F_E_ , F_G_)	Diesel	92	08/02 → 05/06					
2.0 TDCi (F_F_ , F_E_ , F_G_)	Diesel	92	08/02 → 05/06					
2.3 16V [RWD] (F_B_ , F_C_ , F_A_)	Petrol	107	08/00 → 05/06	ENGINE: DOHC23	SVF005		B6	
2.3 16V [RWD] (F_B_ , F_C_ , F_A_)	Petrol	107	08/00 → 05/06					
2.3 16V [RWD] (F_B_ , F_C_ , F_A_)	Petrol	107	08/00 → 05/06					
2.3 16V [RWD] (F_B_ , F_C_ , F_A_)	Petrol	107	08/00 → 05/06	ENGINE: E5FC,E5FA				
2.3 16V [RWD] (F_B_ , F_C_ , F_A_)	Petrol	107	12/00 → 05/06					
2.4 DI (F_B_ , F_C_ , F_A_)	Diesel	66	01/00 → 05/06					
2.4 DI (F_B_ , F_C_ , F_A_)	Diesel	66	01/00 → 05/06	ENGINE: D2FB,D2FA,D2FE				
2.4 DI [RWD] (F_B_ , F_C_)	Diesel	55	01/00 → 05/06					



TYPE



TYPE



TYPE

				SPA141	F1	SAA108	SAG101	H1		
				SPA170	F1					
						SAA108	SAG101	H1		
						SAA108	SAG101	H1		
				SPA141	F1	SAA108				
				SPA141	F1	SAA108				
				SPA170	F1					
		APS14				SAA108				
				SPA141	F1	SAA108				
				SPA170	F1					
		APS14				SAA108				
						SAA112			ESS0014A	J1
				SPA148	F1	SAA113	SAG006	H1		
				SPA148	F1	SAA113	SAG172	H1		
				SPA148	F1	SAA113	SAG172	H1		
							SAC097	H2		
							SAC097	H2		
				SPA148	F1	SAA113	SAC083	H2		
							SAD040	H3		
				SPA141	F1	SAA112	SAC003	H2		
							SAG172	H1		
							SAC097	H2		
									BAE680BT	
						SAA113	SAG006	H1		
						SAA117	SAC097	H2		
						SAA113	SAG172	H1		



KW



TYPE



TYPE

FORD

TRANSIT Autobus (FD_ , FB_ , FS_ , FZ_ , FC_)

2.4 DI [RWD] (F_B_ , F_C_)	Diesel	55	01/00 → 05/06	ENGINE: F4FA				
2.4 DI [RWD] (F_B_ , F_C_ , F_A_)	Diesel	88	01/00 → 05/06					
2.4 DI [RWD] (F_B_ , F_C_ , F_A_)	Diesel	88	01/00 → 05/06	ENGINE: D4FA				
2.4 TDCi	Diesel	101	03/04 → 05/06					
2.4 TDCi	Diesel	101	03/04 → 05/06					
2.4 TDE	Diesel	85	03/04 → 05/06					
2.4 TDE (F_C_ , F_B_ , F_A_)	Diesel	92	07/01 → 05/06					
2.4 TDE (F_C_ , F_B_ , F_A_)	Diesel	92	07/01 → 05/06	ENGINE: DOFA				

TRANSIT Autobus (T_)

1.6 (TBL, TES)	Petrol	46	12/85 → 01/89					
2.0 (TBS, TCL, TCS) Cat.	Petrol	57	12/85 → 09/92					
2.0 (TBS, TCL, TCS, TEL, TES)	Petrol	57	11/85 → 09/92					
2.5 D (TBS, TCL, TCS, TEL, TES)	Diesel	50	12/85 → 01/89					
2.5 D (TBS, TEL, TES)	Diesel	52	09/88 → 09/92					

TRANSIT CONNECT (P65_ , P70_ , P80_)

1.8 16V	Petrol	85	06/02 →			VAE3391	B2
1.8 16V	Petrol	85	06/02 →	ENGINE: EYPA,EYPC,EYPD		AMM19780	B4
1.8 16V	Petrol	85	06/02 →	ENGINE: ZETEC-EDOHCEFI			
1.8 Di	Diesel	55	08/06 →			AMM19656	B4
1.8 Di	Diesel	55	06/02 →				
1.8 Di	Diesel	55	06/02 →	ENGINE: P7PA,P7PB,R2PA,BHPA			
1.8 Di	Diesel	55	06/02 →	ENGINE: P7PA,P7PB,R2PA,BHPA			
1.8 TDCi	Diesel	66	06/02 →	ENGINE: DURATORQ18TDCI		AMM19656	B4
1.8 TDCi	Diesel	81	08/06 →	ENGINE: DURATORQ18TDCI		AMM19656	B4
1.8 TDCi	Diesel	66	06/02 →	ENGINE: DURATORQTDCI18			
1.8 TDCi	Diesel	66	06/02 →				
1.8 TDCi	Diesel	81	08/06 →				
1.8 TDCi	Diesel	66	06/02 →	ENGINE: HCPA,HCPB,RWPE, RWPF,P9PA,P9PB,P9PC, P9PD,R3PA			
1.8 TDCi	Diesel	66	06/02 →	ENGINE: HCPA,HCPB,RWPE, RWPF,P9PA,P9PB,P9PC, P9PD,R3PA			
1.8 TDCi	Diesel	81	08/06 →	ENGINE: RWPA,RWPC,RWPD			
1.8 TDCi	Diesel	81	08/06 →	ENGINE: RWPA,RWPC,RWPD			

TRANSIT Furgonato

2.2 TDCi	Diesel	103	10/07 →			AMM19656	B4
2.2 TDCi	Diesel	63	04/06 →			AMM19656	B4
2.2 TDCi	Diesel	81	04/06 →			AMM19656	B4
2.2 TDCi	Diesel	96	04/06 →			AMM19656	B4



TYPE



TYPE



TYPE

					SAA117	SAC097	H2		
					SAA113	SAG006	H1		
					SAA117	SAC097	H2		
					SAA113	SAC083	H2		
						SAD036	H3		
					SAA113				
					SAA113				
					SAA117				
					SAA112				
			SPA151	F1	SAA112				
			SPA151	F1	SAA112				
					SAA108				
					SAA108				
			RP04A		SAA113				
						SAC002	H2		
	APS15		SPA158	F1	SAA115	SAD040	H3		
						SAC074	H2		
						SAG179	H1		
	APS15								
			SPA158	F1	SAA115	SAD040	H3		
			SPA158	F1	SAA115	SAD040	H3		
						SAC074	H2		
						SAG179	H1		
						SAC074	H2		
						SAG179	H1		
			SPA148	F1					
	APS20				SAA113	SAC083	H2		
	APS20				SAA113	SAC083	H2		
	APS20				SAA113	SAC083	H2		



KW

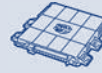

TYPE



TYPE

FORD

TRANSIT Furgonato

2.2 TDCi	Diesel	63	04/06 →						
2.2 TDCi	Diesel	81	04/06 →						
2.2 TDCi	Diesel	96	04/06 →						
2.2 TDCi	Diesel	103	10/07 →	ENGINE: C22DD0P,PGFA					
2.2 TDCi	Diesel	74	10/11 →						
2.2 TDCi	Diesel	85	10/08 →	ENGINE: C22DD0P,QVFA					
2.2 TDCi	Diesel	92	10/11 →						
2.2 TDCi (RWD)	Diesel	114	10/11 →						
2.2 TDCi (RWD)	Diesel	74	10/11 →						
2.2 TDCi (RWD)	Diesel	92	10/11 →						
2.2 TDCi 4x4	Diesel	92	10/11 →						
2.3 16V	Petrol	107	04/06 →						
2.3 16V	Petrol	107	04/06 →						
2.3 16V	Petrol	107	04/06 →	ENGINE: GZFA					
2.4 TDCi	Diesel	74	04/06 →				AMM19656	B4	
2.4 TDCi	Diesel	85	04/06 →				AMM19656	B4	
2.4 TDCi	Diesel	103	04/06 →						
2.4 TDCi	Diesel	74	04/06 →						
2.4 TDCi	Diesel	85	04/06 →						
2.4 TDCi	Diesel	103	04/06 →						
2.4 TDCi 4x4	Diesel	103	11/06 →				AMM19656	B4	
3.2 TDCi	Diesel	147	09/07 →				AMM19656	B4	
3.2 TDCi	Diesel	147	09/07 →	ENGINE: 32DDOP					

TRANSIT Furgonato (E_ _)

2.0	Petrol	66	09/91 → 06/94						
2.0 (EAL, EAS)	Petrol	84	06/94 → 03/00				AMM19657	B4	
2.0 (EAL, EAS)	Petrol	84	06/94 → 03/00	ENGINE: NSF,NSG					
2.0 (EAL, EAS)	Petrol	84	06/94 → 03/00	ENGINE: DOHC(8V)					
2.0 (EAL, EAS)	Petrol	84	06/94 → 03/00	ENGINE: EFIDOHCDL20					
2.5 DI (EAL, EAS)	Diesel	85	05/99 → 03/00	ENGINE: DIESEL25					
2.5 DI (EAL, EAS)	Diesel	51	06/94 → 03/00						
2.5 DI (EAL, EAS)	Diesel	51	09/97 → 03/00						
2.5 DI (EAL, EAS)	Diesel	56	06/94 → 03/00						
2.5 DI (EAL, EAS)	Diesel	56	09/97 → 03/00						
2.5 DI (EAL, EAS)	Diesel	85	05/99 → 03/00						
2.5 TD (EAL, EAS)	Diesel	63	09/97 → 03/00						
2.5 TD (EAL, EAS)	Diesel	63	06/94 → 03/00						
2.5 TD (EAS)	Diesel	55	10/98 → 03/00						
2.5 TDI (EAL, EAS)	Diesel	74	09/97 → 03/00						
2.5 TDI (EAL, EAS)	Diesel	74	06/94 → 03/00						



KW

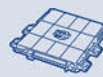

TYPE



TYPE

FORD

TRANSIT Furgonato (FA_ _)

2.0 DI (FAE_, FAF_, FAG_)	Diesel	55	08/00 → 05/06					
2.0 DI (FAE_, FAF_, FAG_)	Diesel	63	08/00 → 05/06					
2.0 DI (FAE_, FAF_, FAG_)	Diesel	74	08/00 → 05/06					
2.0 DI (FAE_, FAF_, FAG_)	Diesel	55	08/00 → 05/06	ENGINE: D3FA				
2.0 DI (FAE_, FAF_, FAG_)	Diesel	74	08/00 → 05/06	ENGINE: ABFA				
2.0 TDCi	Diesel	92	08/02 → 05/06	ENGINE: DURATORQ20TDCI		AMM19664	B4	
2.0 TDCi	Diesel	92	08/02 → 05/06					
2.0 TDCi	Diesel	92	08/02 → 05/06					
2.3	Petrol	105	08/01 → 03/06					
2.3	Petrol	107	03/01 → 03/06					
2.3 16V [RWD] (FAA_, FAB_, FAC_)	Petrol	107	04/01 → 05/06	ENGINE: DOHC23		SVF005	B6	
2.3 16V [RWD] (FAA_, FAB_, FAC_)	Petrol	107	04/01 → 05/06					
2.3 16V [RWD] (FAA_, FAB_, FAC_)	Petrol	107	04/01 → 05/06					
2.3 16V [RWD] (FAA_, FAB_, FAC_)	Petrol	107	04/01 → 05/06	ENGINE: E5FC,E5FA				
2.4 DI (FAA_, FAB_, FAC_, FAD_)	Diesel	66	01/00 → 05/06					
2.4 DI (FAA_, FAB_, FAC_, FAD_)	Diesel	66	01/00 → 05/06	ENGINE: D2FB,D2FA,D2FE				
2.4 DI [RWD] (FAA_, FAB_, FAC_, FAD_)	Diesel	55	01/00 → 05/06					
2.4 DI [RWD] (FAA_, FAB_, FAC_, FAD_)	Diesel	55	01/00 → 05/06	ENGINE: F4FA				
2.4 DI [RWD] (FAA_, FAB_, FAC_, FAD_)	Diesel	88	01/00 → 05/06					
2.4 DI [RWD] (FAA_, FAB_, FAC_, FAD_)	Diesel	88	01/00 → 05/06	ENGINE: D4FA				
2.4 TDCi	Diesel	101	03/04 → 05/06					
2.4 TDCi	Diesel	101	03/04 → 05/06					
2.4 TDE	Diesel	85	03/04 → 05/06					
2.4 TDE	Diesel	92	07/01 → 05/06					
2.4 TDE	Diesel	92	07/01 → 05/06	ENGINE: DOFA				

TRANSIT Furgonato (T_ _)

1.6 (TAS)	Petrol	46	09/85 → 09/92					
2.5 D (TAL, TAS, TGL, TWS)	Diesel	52	10/88 → 09/91					

TRANSIT Pianale piatto/Telaio

2.2 TDCi	Diesel	103	10/07 →			AMM19656	B4	
2.2 TDCi	Diesel	63	04/06 →			AMM19656	B4	
2.2 TDCi	Diesel	81	04/06 →			AMM19656	B4	
2.2 TDCi	Diesel	96	04/06 →			AMM19656	B4	
2.2 TDCi	Diesel	63	04/06 →					

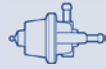

TYPE



TYPE



TYPE

				SPA148	F1	SAA113	SAG006	H1		
				SPA148	F1	SAA113	SAG172	H1		
				SPA148	F1	SAA113	SAG172	H1		
							SAC097	H2		
							SAC097	H2		
				SPA148	F1	SAA113	SAC083	H2		
							SAD040	H3		
									BAE680BT	
									BAE680BT	
				SPA141	F1	SAA112	SAC003	H2	BAE680BT	
							SAG172	H1		
							SAC097	H2		
						SAA113	SAG006	H1		
						SAA117	SAC097	H2		
						SAA113	SAG172	H1		
						SAA117	SAC097	H2		
						SAA113	SAG006	H1		
						SAA117	SAC097	H2		
						SAA113	SAC083	H2		
							SAD036	H3		
						SAA113				
						SAA113				
						SAA117				
						SAA112				
						SAA108				
				SPA148	F1					
		APS20				SAA113	SAC083	H2		
		APS20				SAA113	SAC083	H2		
		APS20				SAA113	SAC083	H2		
							SAG172	H1		



KW



TYPE



TYPE

FORD

TRANSIT Pianale piatto/Telaio

2.2 TDCi	Diesel	81	04/06 →						
2.2 TDCi	Diesel	92	10/11 →						
2.2 TDCi	Diesel	96	04/06 →						
2.2 TDCi	Diesel	103	10/07 →	ENGINE: PGFA					
2.2 TDCi	Diesel	74	10/11 →						
2.2 TDCi	Diesel	85	10/08 →	ENGINE: QVFA					
2.2 TDCi (RWD)	Diesel	114	10/11 →						
2.2 TDCi (RWD)	Diesel	74	10/11 →						
2.2 TDCi (RWD)	Diesel	92	10/11 →						
2.2 TDCi 4x4	Diesel	92	10/11 →						
2.3 16V	Petrol	107	04/06 →						
2.3 16V	Petrol	107	04/06 →						
2.3 16V	Petrol	107	04/06 →	ENGINE: GZFB					
2.4 TDCi	Diesel	74	04/06 →				AMM19656	B4	
2.4 TDCi	Diesel	85	04/06 →				AMM19656	B4	
2.4 TDCi	Diesel	103	04/06 →						
2.4 TDCi	Diesel	74	04/06 →						
2.4 TDCi	Diesel	85	04/06 →						
2.4 TDCi	Diesel	103	04/06 →						
2.4 TDCi 4x4	Diesel	103	11/06 →				AMM19656	B4	
2.4 TDCi 4x4	Diesel	103	11/06 →	ENGINE: HPFB					
3.2 TDCi	Diesel	147	09/07 →				AMM19656	B4	
3.2 TDCi	Diesel	147	09/07 →	ENGINE: 32DDOP					

TRANSIT Pianale piatto/Telaio (E_ _)

2.0 (EME/L/S, ENE/L/S)	Petrol	84	08/94 → 03/00				AMM19657	B4	
2.0 (EME/L/S, ENE/L/S)	Petrol	72	09/91 → 08/94						
2.0 (EME/L/S, ENE/L/S)	Petrol	84	08/94 → 03/00	ENGINE: NSF,NSG					
2.0 (EME/L/S, ENE/L/S)	Petrol	84	08/94 → 03/00	ENGINE: DOHC(8V)					
2.0 (EME/L/S, ENE/L/S)	Petrol	84	08/94 → 03/00	ENGINE: EFIDOHCDL20					
2.5 DI (EME/L/S, ENE/L/S)	Diesel	56	08/94 → 03/00						
2.5 DI (EME/L/S, ENE/L/S)	Diesel	56	09/97 → 03/00						
2.5 DI (EME/L/S, ENE/L/S)	Diesel	59	09/91 → 08/94						
2.5 DI (EML, ENE/L)	Diesel	85	05/99 → 03/00	ENGINE: DIESEL25					
2.5 DI (EML, ENE/L)	Diesel	85	05/99 → 03/00						
2.5 DI (EML/S, ENL/S)	Diesel	51	08/94 → 03/00						
2.5 DI (EML/S, ENL/S)	Diesel	51	09/97 → 03/00						
2.5 DI (EML/S, ENL/S)	Diesel	51	09/91 → 08/94						
2.5 TD (EME/L/S, ENE/L)	Diesel	74	09/91 → 08/94						
2.5 TD (EME/L/S, ENE/L/S)	Diesel	55	10/98 → 07/00						
2.5 TD (EME/L/S, ENE/L/S)	Diesel	63	09/97 → 03/00						
2.5 TD (EME/L/S, ENE/L/S)	Diesel	74	09/97 → 03/00						
2.5 TD (EME/L/S, ENE/L/S)	Diesel	63	08/94 → 03/00						
2.5 TD (EME/L/S, ENE/L/S)	Diesel	74	08/94 → 03/00						
2.5 TD (EME/L/S, ENE/L/S)	Diesel	63	11/92 → 08/94						



KW



TYPE



TYPE

FORD

TRANSIT Pianale piatto/Telaio (FM_-, FN_-)

2.0 DI (F_E_, F_F_)	Diesel	55	08/00 → 05/06					
2.0 DI (F_E_, F_F_)	Diesel	63	08/00 → 05/06					
2.0 DI (F_E_, F_F_)	Diesel	74	08/00 → 05/06					
2.0 DI (F_E_, F_F_)	Diesel	55	08/00 → 05/06	ENGINE: D3FA				
2.0 DI (F_E_, F_F_)	Diesel	74	08/00 → 05/06	ENGINE: ABFA				
2.0 TDCi (F_E_, F_F_)	Diesel	92	08/02 → 05/06	ENGINE: DURATORQ20TDCI		AMM19664	B4	
2.0 TDCi (F_E_, F_F_)	Diesel	92	08/02 → 05/06					
2.0 TDCi (F_E_, F_F_)	Diesel	92	08/02 → 05/06					
2.3 16V (F_A_, F_B_, F_C_, F_D_)	Petrol	107	04/01 → 05/06					
2.3 16V (F_A_, F_B_, F_C_, F_D_)	Petrol	107	04/01 → 05/06					
2.3 16V (F_A_, F_B_, F_C_, F_D_)	Petrol	107	04/01 → 05/06	ENGINE: E5FC,E5FA				
2.4 DI (F_A_, F_B_, F_C_, F_D_)	Diesel	55	01/00 → 05/06					
2.4 DI (F_A_, F_B_, F_C_, F_D_)	Diesel	55	01/00 → 05/06	ENGINE: F4FA				
2.4 DI (F_A_, F_B_, F_C_, F_D_)	Diesel	66	01/00 → 05/06					
2.4 DI (F_A_, F_B_, F_C_, F_D_)	Diesel	66	01/00 → 05/06	ENGINE: D2FB,D2FA,D2FE				
2.4 DI (F_A_, F_B_, F_C_, F_D_)	Diesel	88	01/00 → 05/06					
2.4 DI (F_A_, F_B_, F_C_, F_D_)	Diesel	88	01/00 → 05/06	ENGINE: D4FA				
2.4 TDCi	Diesel	101	03/04 → 05/06					
2.4 TDCi	Diesel	101	03/04 → 05/06					
2.4 TDE	Diesel	85	03/04 → 05/06					
2.4 TDE	Diesel	92	07/01 → 05/06					
2.4 TDE	Diesel	92	07/01 → 05/06	ENGINE: DOFA				

TRANSIT Pianale piatto/Telaio (T_-)

2.0 (TTE, TTL, TTS)	Petrol	57	01/86 → 09/92					
2.0 (TUL) Cat.	Petrol	57	11/85 → 09/92					
2.5 D (TTL, TTS, TUL, TUS, TTE) Cat.	Diesel	50	01/86 → 01/89					
2.5 DI (TTE, TTL, TTS, TUL)	Diesel	52	09/88 → 09/92					

TRANSIT TOURNEO

2.2 TDCi	Diesel	103	10/07 →			AMM19656	B4	
2.2 TDCi	Diesel	81	07/06 →			AMM19656	B4	
2.2 TDCi	Diesel	96	07/06 →			AMM19656	B4	
2.2 TDCi	Diesel	85	10/08 →					
2.5 DI	Diesel	51	11/94 → 12/00					
2.5 DI	Diesel	56	11/94 → 12/00					



TYPE



TYPE



TYPE

				SPA148	F1	SAA113	SAG006	H1		
				SPA148	F1	SAA113	SAG006	H1		
				SPA148	F1	SAA113	SAG172	H1		
							SAC097	H2		
							SAC097	H2		
				SPA148	F1	SAA113	SAC083	H2		
							SAD040	H3		
				SPA141	F1	SAA112	SAC003	H2	BAE680BT	
							SAG172	H1		
							SAC097	H2		
						SAA113	SAG172	H1		
						SAA117	SAC097	H2		
						SAA113	SAG006	H1		
						SAA117	SAC097	H2		
						SAA113	SAG006	H1		
						SAA117	SAC097	H2		
						SAA113	SAC083	H2		
							SAD036	H3		
						SAA113				
						SAA113				
						SAA117				
				SPA151	F1	SAA112				
				SPA151	F1	SAA112				
						SAA108				
						SAA108				
				SPA148	F1		SAC083	H2		
						SAA113	SAC083	H2		
						SAA113	SAC083	H2		
				SPA148	F1		SAC083	H2		
						SAA108				
						SAA108				



KW



TYPE



TYPE

FORD

TRANSIT TOURNEO

2.5 TD	Diesel	63	11/94 → 12/00						
2.5 TD	Diesel	74	04/98 → 12/00						

HONDA

ACCORD IV (CB)

2.0 16V (CB3)	Petrol	66	01/90 → 03/93						
2.0 16V (CB3)	Petrol	81	01/90 → 03/93						
2.0 i 16V (CB3)	Petrol	98	01/90 → 03/93						
2.2 i 16V (CB7)	Petrol	110	01/90 → 03/93						
2.2 i 16V Automatik (CB7)	Petrol	108	01/90 → 03/93						

ACCORD IV Aerodeck (CB)

2.0 i 16V (CC9)	Petrol	98	03/93 → 12/93						
2.2 i 16V (CB8)	Petrol	108	01/91 → 12/93						
2.2 i 16V (CB8)	Petrol	110	01/91 → 12/93						

ACCORD IV Coupé (CC1)

2.0 i 16V	Petrol	98	01/92 → 09/93						
-----------	--------	----	---------------	--	--	--	--	--	--

ACCORD V (CC7, CD)

2.0 i	Petrol	85	03/93 → 01/96						
2.0 i S	Petrol	96	03/93 → 01/96						
2.3 i SR	Petrol	116	03/93 → 01/96						

ACCORD V (CE, CF)

1.9 i (CE7)	Petrol	85	02/96 → 10/98						
2.0 i LS (CE8)	Petrol	96	02/96 → 10/98						
2.0 TDi (CF1)	Diesel	77	04/96 → 10/98						
2.2 i VTEC (CE9)	Petrol	110	02/96 → 10/98						

ACCORD V Aerodeck (CE)

2.0 i LS 16V (CE2)	Petrol	100	09/93 → 02/98						
2.2 i ES (CE1)	Petrol	110	09/93 → 02/98						

ACCORD V Coupé (CD7, CD9)

2.0 (CD9)	Petrol	100	09/93 → 12/97						
2.2 i ES (CD7)	Petrol	110	09/93 → 02/98						

ACCORD VI (CG, CK)

1.6 i	Petrol	85	10/98 → 12/02					SVF016	B6
1.6 i	Petrol	85	01/00 → 12/02						
1.6 LS	Petrol	79	01/00 → 12/02						
1.8 i	Petrol	100	10/98 → 12/02						
2.0 i	Petrol	108	10/98 → 01/01						
2.0 Turbo DI	Diesel	77	02/99 → 12/02						
2.2 Type-R	Petrol	156	02/99 → 12/02						
2.3 (CK2)	Petrol	113	01/01 → 06/03						

ACCORD VI Coupé (CG)

2.0 i 16V	Petrol	108	02/98 → 06/03						
3.0 V6 24V	Petrol	147	02/98 → 06/03						

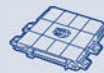
KW

TYPE

TYPE
HONDA
ACCORD VI Hatchback (CH)

1.6	Petrol	85	12/99 → 12/02						
1.8 i (CH6)	Petrol	100	12/99 → 12/02						
2.0 (CH7)	Petrol	108	12/99 → 12/02						
2.0 TDi	Diesel	77	12/99 → 10/00						
2.3 (CL4)	Petrol	113	11/00 → 12/02						

ACCORD VII (CL)

2.0 (CL7)	Petrol	114	02/03 →						
2.0 Trazione integrale (CL8)	Petrol	114	02/03 →						
2.2 i-CTDi	Diesel	103	01/04 →						
2.4 (CL9)	Petrol	140	02/03 →						

ACCORD VII Tourer (CM)

2.0 (CM1)	Petrol	114	04/03 →						
2.2 i-CTDi	Diesel	103	01/04 →						
2.4 (CM2)	Petrol	140	04/03 →						

ACCORD VIII (CU)

2.0 i	Petrol	115	07/08 →						
2.2 i-DTEC	Diesel	110	07/08 →						
2.4 i	Petrol	148	07/08 →						

ACCORD VIII Station wagon

2.0 i	Petrol	115	07/08 →						
2.2 i-DTEC	Diesel	110	07/08 →						
2.4 i	Petrol	148	07/08 →						

CIVIC I Tre volumi (SF)

1300 L	Petrol	33	09/80 → 09/83						
--------	--------	----	---------------	--	--	--	--	--	--

CIVIC II Shuttle (EE)

1.6 i 16V 4WD (EE4)	Petrol	81	01/90 → 02/95						
---------------------	--------	----	---------------	--	--	--	--	--	--

CIVIC IV Hatchback (EC, ED, EE)

1.5 i 16V	Petrol	66	10/88 → 09/91						
1.5 i 16V (ED6)	Petrol	69	10/88 → 09/91						

CIVIC IV Tre volumi (ED)

1.5 i 16V	Petrol	66	10/87 → 09/91						
1.5 i 16V (ED3)	Petrol	69	10/87 → 09/91						

CIVIC V Coupé (EJ)

1.5 i LSi (EJ2)	Petrol	74	08/93 → 11/95						
1.6 i (EJ6)	Petrol	77	01/94 → 11/95						
1.6 i Vtec	Petrol	118	01/94 → 11/95						
1.6 i Vtec (EJ1)	Petrol	92	01/94 → 03/96						

CIVIC V Hatchback (EG)

1.3 16V (EG3)	Petrol	55	10/91 → 11/95						
1.5 i 16V (EG4)	Petrol	66	10/91 → 11/95						
1.5 i 16V (EG4)	Petrol	69	10/91 → 11/95						
1.6 16V Vtec (EG5)	Petrol	92	10/91 → 11/95						
1.6 VTi 16V (EG6)	Petrol	118	10/91 → 11/95						



KW



TYPE



TYPE

HONDA

CIVIC V Tre volumi (EG, EH)

1.5	Petrol	88	06/93 → 09/95						
1.5 i 16V (EG8)	Petrol	69	10/91 → 11/95						
1.6 (EH9)	Petrol	96	10/91 → 10/93						
1.6 16V Vtec (EH9)	Petrol	92	10/91 → 11/95						
1.6 VTi (EG9)	Petrol	118	10/91 → 11/95						

CIVIC VI Aerodeck (MB, MC)

1.4 16V (MB8)	Petrol	55	04/98 → 02/01						
1.4 16V (MB8)	Petrol	66	04/98 → 02/01						
1.5 16V (MB9)	Petrol	84	04/98 → 02/01						
1.6 16V (MC1)	Petrol	85	04/98 → 02/01						
1.8 16V (MC2)	Petrol	124	04/98 → 02/01						
2.0 i D (MC3)	Diesel	77	04/98 → 02/01						

CIVIC VI Coupé (EJ, EM1)

1.6 i	Petrol	77	03/96 → 03/00						
1.6 i Vtec	Petrol	92	03/96 → 03/00						
1.6 i Vtec	Petrol	118	04/99 → 12/00						

CIVIC VI Fastback (MA, MB)

1.4 i (MA8, MB2)	Petrol	55	09/95 → 02/01						
1.4 i (MA8, MB2)	Petrol	66	09/94 → 02/01						
1.5 i Vtec-E (MA9)	Petrol	66	09/94 → 01/97						
1.6 i (MB1)	Petrol	83	09/94 → 01/97						
1.6 i Vtec (MB1)	Petrol	93	09/94 → 01/97						
1.6 VTi	Petrol	118	01/97 → 02/01						

CIVIC VI Hatchback (EJ, EK)

1.4 i (EJ9)	Petrol	55	11/95 → 02/01						
1.4 i S (EJ9)	Petrol	66	11/95 → 02/01						
1.5 i (EK3)	Petrol	84	11/95 → 02/01						
1.6	Petrol	93	10/95 → 01/97						
1.6 i (EK1)	Petrol	84	11/95 → 02/01						
1.6 VTi (EK4)	Petrol	118	11/95 → 02/01						

CIVIC VI Tre volumi (EJ, EK)

1.4 i (EJ9)	Petrol	66	11/95 → 02/01						
1.5 i (EK3)	Petrol	84	11/95 → 02/01						
1.6 i Vtec	Petrol	92	11/95 → 02/01						
1.6 VTi (EK4)	Petrol	118	11/95 → 02/01						

CIVIC VII Coupé (EM2)

1.6 i	Petrol	81	02/01 → 12/05						
1.7 i	Petrol	88	05/01 → 12/05						
1.7 i VTEC	Petrol	92	05/01 → 12/05						

CIVIC VII Hatchback (EU, EP, EV)

1.4 i	Petrol	55	02/01 → 09/05						
1.4 iS (EP1)	Petrol	66	02/01 → 09/05						
1.6 i	Petrol	81	02/01 → 09/05						
1.7 CTDi	Diesel	74	01/02 → 09/05						



TYPE

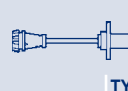

TYPE



TYPE

								BAE680DP	
	APS73				SAA109			BAE680DP	
								BAE680DP	
	APS73				SAA109			BAE680DP	
	APS73				SAA109			BAE680DP	
	APS73		SPA155	F1					
	APS73		SPA155	F1					
	APS73		SPA155	F1	SAA109				
	APS73		SPA155	F1					
	APS73		SPA155	F1					
						SAG081	H1		
	APS73		SPA155	F1	SAA109			BAE680DP	
	APS73		SPA155	F1				BAE680DP	
			SPA155	F1					
	APS73		SPA155	F1					
	APS73		SPA155	F1				BAE680DP	
	APS73		SPA155	F1				BAE680DP	
	APS73		SPA155	F1				BAE680DP	
	APS73		SPA155	F1				BAE680DP	
	APS73		SPA155	F1				BAE680DP	
	APS73		SPA155	F1	SAA109			BAE680DP	
	APS73		SPA155	F1				BAE680DP	
	APS73		SPA155	F1				BAE680DP	
	APS73		SPA155	F1				BAE680DP	
	APS73		SPA155	F1				BAE680DP	
	APS74				SAA109			BAE680CK	
	APS74		SPA157	F1	SAA109	SAC056	H2	BAE680CK	
	APS74		SPA157	F1	SAA109	SAC056	H2	BAE680CK	
	APS74					SAC056	H2	BAE680CK	
	APS74		SPA157	F1	SAA109	SAC056	H2	BAE680CK	
	APS74		SPA157	F1	SAA109	SAC056	H2	BAE680CK	
						SAC094	H2		



KW

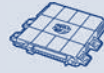

TYPE



TYPE

HONDA

CIVIC VII Hatchback (EU, EP, EV)

2.0 i Sport	Petrol	118	09/01 → 09/05						
2.0 Type-R	Petrol	147	09/01 → 09/05						

CIVIC VII Tre volumi (ES)

1.3 IMA	Petrol	61	01/04 → 09/05						
1.4 (ES4)	Petrol	66	12/00 → 09/05						
1.6	Petrol	81	02/01 → 09/05						
1.7 (EU3)	Petrol	85	02/01 → 09/05						

CIVIC VIII Hatchback (FN, FK)

1.4	Petrol	61	01/06 →						
1.4	Petrol	73	10/08 →						
1.8	Petrol	103	01/06 →						
2.2 CTDi	Diesel	103	01/06 →						
Type R	Petrol	148	09/06 →						

CIVIC VIII Tre volumi (FD, FA)

1.3 Hybrid	Hybrid	70	01/06 →						
------------	--------	----	---------	--	--	--	--	--	--

CR-V I (RD)

2.0	Petrol	98	04/99 → 02/02						
2.0 16V (RD1, RD3)	Petrol	108	01/99 → 02/02						
2.0 16V (RD1, RD3)	Petrol	94	10/95 → 01/99						

CR-V II (RD_)

2.0	Petrol	110	07/02 → 09/06						
-----	--------	-----	---------------	--	--	--	--	--	--

CR-V III (RE)

2.0 i 4WD	Petrol	110	01/07 →						
2.2 i-CTDi 4WD	Diesel	103	01/07 →						

CRX II (ED, EE)

1.6 i 16V (ED9)	Petrol	91	10/87 → 02/92						
-----------------	--------	----	---------------	--	--	--	--	--	--

CRX III (EH, EG)

1.6 ESi (EH6)	Petrol	92	03/92 → 12/98						
1.6 i VTi (EG2)	Petrol	118	03/92 → 12/98						

FR-V (BE)

1.7	Petrol	92	08/04 →						
1.8	Petrol	103	01/07 →						
2.0	Petrol	110	02/05 →						

HR-V (GH)

1.6 16V	Petrol	77	03/99 →						
1.6 16V 4WD	Petrol	77	03/99 →						
1.6 16V 4WD	Petrol	91	10/99 →						

INSIGHT (ZE_)

1.3 Hybrid	Hybrid	65	04/09 →						
------------	--------	----	---------	--	--	--	--	--	--

INTEGRA Coupé (DC2, DC4)

1.8 Type-R	Petrol	140	11/97 → 10/01						
------------	--------	-----	---------------	--	--	--	--	--	--

JAZZ I (AA)

45 1.2	Petrol	33	02/84 → 10/86						
--------	--------	----	---------------	--	--	--	--	--	--

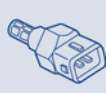
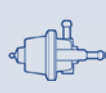

TYPE

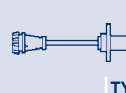

TYPE



TYPE

			SPA157	F1	SAA109			BAE680CE	
	APS74		SPA157	F1	SAA109	SAC069	H2	BAE680CE	
	APS74		SPA157	F1		SAC069	H2		
	APS74							BAE680CK	
	APS74				SAA109			BAE680CK	
	APS74				SAA109				
			SPA152	F1				BAE680CI	
			SPA152	F1					
			SPA152	F1					
			SPA152	F1					
			SPA152	F1					
			SPA152	F1					
			SPA152	F1					
								BAE680DP	
	APS73		SPA155	F1				BAE680DP	
			SPA155	F1				BAE680DP	
	APS74		SPA157	F1	SAA109	SAC069	H2	BAE680CE	
			SPA152	F1				BAE680CE	
			SPA152	F1					
	APS73								
	APS73		SPA155	F1	SAA109			BAE680DP	
	APS73		SPA155	F1	SAA109			BAE680DP	
	APS74					SAC056	H2	BAE680CK	
			SPA152	F1					
			SPA157	F1		SAC069	H2	BAE680CE	
	APS73		SPA155	F1				BAE680DP	
	APS73		SPA155	F1				BAE680DP	
	APS73		SPA155	F1				BAE680DP	
			SPA152	F1					
	APS73		SPA155	F1					
					SAA106				

KW

TYPE

TYPE
HONDA
JAZZ II (GD)

1.2	Petrol	57	03/02 → 07/08						
1.4	Petrol	61	03/02 → 07/08						

LEGEND I (HS, KA)

2.7 i 24V (KA4)	Petrol	124	01/88 → 12/90						
-----------------	--------	-----	---------------	--	--	--	--	--	--

LEGEND I Coupé (KA3)

2.7 i 24V	Petrol	124	10/87 → 12/90						
-----------	--------	-----	---------------	--	--	--	--	--	--

LEGEND II (KA7)

3.2 i 24V	Petrol	151	01/91 → 02/96						
-----------	--------	-----	---------------	--	--	--	--	--	--

LEGEND II Coupé (KA8)

3.2 i 24V	Petrol	151	01/91 → 02/96						
-----------	--------	-----	---------------	--	--	--	--	--	--

LEGEND IV (KB_)

3.5 V6 4WD	Petrol	217	05/06 →						
3.7 VTEC V6 4WD	Petrol	217	07/08 →						

LOGO (GA3)

1.3	Petrol	48	03/99 → 03/02						
-----	--------	----	---------------	--	--	--	--	--	--

NSX Cabriolet (NA)

3.0 24V Vtec	Petrol	201	03/95 → 09/05						
3.0 24V Vtec Automatic	Petrol	188	03/95 → 09/05						

NSX Coupé (NA)

3.0 24V Vtec (NA1)	Petrol	201	06/90 → 09/05						
3.0 24V Vtec Automatic (NA1)	Petrol	188	06/90 → 09/05						

PRELUDE IV (BB)

2.0 i 16V (BB3)	Petrol	98	02/92 → 09/96						
2.2 i 16V Vtec (BB1)	Petrol	136	02/93 → 09/96						
2.3 i 16V (BB2)	Petrol	118	02/92 → 09/96						

PRELUDE V (BB)

2.2 16V	Petrol	147	10/96 → 10/00						
---------	--------	-----	---------------	--	--	--	--	--	--

QUINTET (SU)

1.6 EX	Petrol	59	02/80 → 12/84						
--------	--------	----	---------------	--	--	--	--	--	--

S2000 (AP)

2.0	Petrol	177	06/99 →						
-----	--------	-----	---------	--	--	--	--	--	--

SHUTTLE (RA)

2.2 16V	Petrol	110	10/94 → 02/98						
2.3 16V	Petrol	110	10/97 → 06/04						

STREAM (RN)

1.7 16V	Petrol	92	05/01 →						
2.0 16V	Petrol	115	05/01 →						

HYUNDAI
ACCENT I (X-3)

1.3	Petrol	44	10/94 → 07/99					SVF015	B6
1.3	Petrol	55	10/94 → 07/99					SVF015	B6
1.3	Petrol	44	10/94 → 04/97						
1.3	Petrol	55	10/94 → 04/97						



TYPE

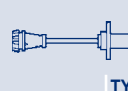

TYPE



TYPE

APS74

BAE680CI

APS74

SPA157

F1

SAC069

H2

SAA106

SAA106

SPA155

F1

SAA109

SPA155

F1

SAA109

BAE680CK

SPA152

F1

APS73

BAE680DP

SPA155

F1

SAA106

SPA155

F1

SAA106

SPA155

F1

SAA106

SPA155

F1

SAA106

APS73

SAA109

BAE680DP

SAA106

BAE680DP

SAA106

BAE680DP

APS73

SAA106

SAA106

APS73

SPA155

F1

SAA106

APS73

SPA155

F1

BAE680DP

APS73

SPA155

F1

BAE680DP

APS74

SPA157

F1

SAC056

H2

BAE680CK

APS74

SPA157

F1

SAC069

H2

BAE680CE

APS45

APS45

KW

TYPE

TYPE
HYUNDAI
ACCENT I (X-3)

1.3	Petrol	44	10/94 → 01/00					
1.3	Petrol	44	10/94 → 01/00					
1.3	Petrol	44	10/94 → 05/96					
1.3	Petrol	55	10/94 → 01/00					
1.3	Petrol	55	10/94 → 01/00					
1.3	Petrol	55	10/94 → 05/96					
1.3 i 12V	Petrol	62	10/94 → 07/99				SVF015	B6
1.3 i 12V	Petrol	62	10/94 → 04/97					
1.3 i 12V	Petrol	62	10/94 → 01/00					
1.3 i 12V	Petrol	62	10/94 → 01/00					
1.3 i 12V	Petrol	62	10/94 → 05/96					
1.5 i 12V	Petrol	65	10/94 → 07/99				SVF015	B6
1.5 i 12V	Petrol	65	10/94 → 04/97					
1.5 i 12V	Petrol	65	10/94 → 01/00					
1.5 i 12V	Petrol	65	10/94 → 01/00					
1.5 i 12V	Petrol	65	10/94 → 01/00					
1.5 i 12V	Petrol	65	10/94 → 05/96					
1.5 i 16V	Petrol	73	12/95 → 01/00				B3394	B1
1.5 i 16V	Petrol	73	12/95 → 07/99				SVF015	B6
1.5 i 16V	Petrol	73	12/95 → 01/00					
1.5 i 16V	Petrol	73	12/95 → 01/00					
1.5 i 16V	Petrol	73	12/95 → 05/96					

ACCENT II (LC)

1.3	Petrol	55	01/00 → 11/05				SVF016	B6
1.3	Petrol	61	01/00 → 11/05				SVF016	B6
1.3	Petrol	62	08/02 → 11/05				SVF016	B6
1.3	Petrol	63	01/00 → 11/05				SVF016	B6
1.5	Petrol	66	01/00 → 11/05				SVF016	B6
1.5	Petrol	75	09/00 → 11/05				SVF016	B6
1.5 CRDi	Diesel	60	04/02 → 11/05					
1.6	Petrol	77	12/02 → 11/05				SVF016	B6

ACCENT III (MC)

1.5 CRDi GLS	Diesel	81	11/05 → 11/10					
--------------	--------	----	---------------	--	--	--	--	--

ACCENT Tre volumi (LC)

1.3	Petrol	55	01/00 → 11/05				SVF016	B6
1.3	Petrol	63	01/00 → 11/05				SVF016	B6
1.5	Petrol	66	01/00 → 11/05				SVF016	B6
1.5 CRDi	Diesel	60	01/02 → 11/05					
1.6	Petrol	77	12/02 → 11/05				SVF016	B6

ACCENT Tre volumi (MC)

1.5 CRDi GLS	Diesel	81	11/05 → 11/10					
--------------	--------	----	---------------	--	--	--	--	--



TYPE

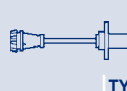

TYPE



TYPE

							SAC045	H2		
							SAG105	H1		
							SAG135	H1		
							SAC045	H2		
							SAG105	H1		
							SAG135	H1		
						APS45				
							SAC045	H2		
							SAG105	H1		
							SAG135	H1		
						APS45				
							SAC045	H2		
							SAD013	H3		
							SAG105	H1		
							SAG135	H1		
						APS54				
							SAC045	H2		
							SAD013	H3		
							SAG105	H1		
							SAG135	H1		
						SPA138	F1		SAG135	H1
										BAE680T
							SAG135	H1		
						SPA138	F1		SAG094	H1
						SPA138	F1		SAG135	H1
						SPA138	F1		SAG135	H1
						SPA138	F1		SAG135	H1
						SPA138	F1		SAG135	H1
						SPA138	F1		SAG135	H1
							SAC058	H2		
						SPA138	F1		SAG135	H1
						SPA138	F1		SAG135	H1
									SAG135	H1
						SPA138	F1			
						SPA138	F1		SAG135	H1
							SAC058	H2		

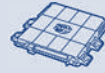
KW

TYPE

TYPE
HYUNDAI
ACCENT Tre volumi (X-3)

1.3	Petrol	44	10/94 → 07/99				SVF015	B6
1.3	Petrol	55	10/94 → 07/99				SVF015	B6
1.3	Petrol	44	10/94 → 04/97					
1.3	Petrol	55	10/94 → 04/97					
1.3	Petrol	44	10/94 → 01/00					
1.3	Petrol	44	10/94 → 01/00					
1.3	Petrol	44	10/94 → 05/96					
1.3	Petrol	55	10/94 → 01/00					
1.3	Petrol	55	10/94 → 01/00					
1.3	Petrol	55	10/94 → 05/96					
1.3 i 12V	Petrol	62	10/94 → 07/99				SVF015	B6
1.3 i 12V	Petrol	62	10/94 → 04/97					
1.3 i 12V	Petrol	62	10/94 → 01/00					
1.3 i 12V	Petrol	62	10/94 → 01/00					
1.3 i 12V	Petrol	62	10/94 → 05/96					
1.5 i 12V	Petrol	65	10/94 → 07/99				SVF015	B6
1.5 i 12V	Petrol	65	10/94 → 04/97					
1.5 i 12V	Petrol	65	10/94 → 01/00					
1.5 i 12V	Petrol	65	10/94 → 01/00					
1.5 i 12V	Petrol	65	10/94 → 01/00					
1.5 i 12V	Petrol	65	10/94 → 05/96					
1.5 i 16V	Petrol	73	10/95 → 01/00				B3394	B1
1.5 i 16V	Petrol	73	10/95 → 07/99				SVF015	B6
1.5 i 16V	Petrol	73	10/95 → 01/00					
1.5 i 16V	Petrol	73	10/95 → 01/00					
1.5 i 16V	Petrol	73	10/95 → 05/96					

ATOS (MX)

1.0 i	Petrol	43	03/01 →				SVF011	B6
1.0 i	Petrol	40	02/98 → 03/02					

ATOS PRIME (MX)

1.0 i	Petrol	43	03/01 →				SVF011	B6
1.0 i	Petrol	40	08/99 →					
1.1	Petrol	43	06/03 →					

COUPE (GK)

1.6 16V	Petrol	77	03/02 → 08/09				B3394	B1
1.6 16V	Petrol	77	03/02 → 08/09				SVF016	B6
1.6 16V	Petrol	79	03/02 → 08/09				B3394	B1
1.6 16V	Petrol	79	03/02 → 08/09				SVF016	B6
2.0	Petrol	102	03/02 → 08/09				SVF016	B6
2.0	Petrol	100	08/01 → 08/09					
2.0 GLS	Petrol	105	02/03 → 08/09				SVF016	B6
2.7 V6	Petrol	123	03/02 → 08/09				SVF011	B6

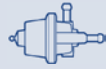

TYPE



TYPE



TYPE

APS45

APS45

SAC045

H2

SAG105

H1

SAG135

H1

SAC045

H2

SAG105

H1

SAG135

H1

APS45

SAC045

H2

SAG105

H1

SAG135

H1

APS45

SAC045

H2

SAD013

H3

SAG105

H1

SAG135

H1

APS54

SAC045

H2

SAD013

H3

SAG105

H1

SAG135

H1

SAG074

H1

SAG074

H1

SAA106

SAG135

H1

BAE680U

SAG135

H1

SPA138

F1

SAD014

H3

SAD014

H3

SAD014

H3

SPA138

F1

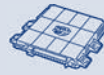
KW

TYPE

TYPE
HYUNDAI
COUPE (RD)

1.6 16V	Petrol	85	03/98 → 09/01					SVF015	B6
1.6 16V	Petrol	85	03/98 → 04/02						
1.6 16V	Petrol	85	03/98 → 04/02						
1.6 i 16V	Petrol	84	12/96 → 09/01					SVF015	B6
1.6 i 16V	Petrol	84	12/96 → 04/97						
1.6 i 16V	Petrol	84	12/96 → 04/02						
1.6 i 16V	Petrol	84	12/96 → 04/02						
1.6 i 16V	Petrol	84	12/96 → 04/02						

ELANTRA (XD)

1.6	Petrol	77	05/03 → 07/06					SVF016	B6
1.6	Petrol	79	06/00 → 07/06					SVF016	B6
1.8	Petrol	97	06/00 → 07/06					SVF016	B6
2.0	Petrol	102	06/00 → 07/06					SVF016	B6
2.0	Petrol	104	06/00 → 07/06					SVF016	B6
2.0	Petrol	105	10/03 → 07/06					SVF016	B6
2.0 CRDi	Diesel	83	04/01 → 07/06						

ELANTRA Tre volumi (XD)

1.6	Petrol	77	05/03 → 07/06					SVF016	B6
1.6	Petrol	79	06/00 → 07/06					SVF016	B6
1.8	Petrol	97	06/00 → 07/06					SVF016	B6
2.0	Petrol	102	06/00 → 07/06					SVF016	B6
2.0	Petrol	104	06/00 → 07/06					SVF016	B6
2.0	Petrol	105	10/03 → 07/06					SVF016	B6

GETZ (TB)

1.1	Petrol	46	09/02 → 09/05					SVF016	B6
1.3	Petrol	63	09/03 → 08/05					SVF016	B6
1.3	Petrol	63	09/03 → 09/05						
1.3 i	Petrol	60	09/02 → 03/04					SVF016	B6
1.4 i	Petrol	71	08/05 → 06/09						
1.5 CRDi	Diesel	65	08/05 → 06/09						
1.5 CRDi GLS	Diesel	81	08/05 → 06/09						
1.6	Petrol	77	09/02 → 09/05					SVF016	B6

H-1 / STAREX

2.5 CRDi	Diesel	103	01/04 → 04/04						
2.5 CRDi 4WD	Diesel	103	01/04 → 04/04						
2.5 TD 4WD	Diesel	73	03/01 → 04/04					B3394	B1
2.5 TD 4WD	Diesel	74	11/01 → 04/04					B3394	B1

H-1 Furgonato

2.4	Petrol	82	03/00 → 04/04					SVF011	B6
-----	--------	----	---------------	--	--	--	--	--------	----

i10 (PA)

1.1 CRDi	Diesel	55	01/08 →						
----------	--------	----	---------	--	--	--	--	--	--

i20 (PB, PBT)

1.6 CRDi	Diesel	85	09/08 →						
----------	--------	----	---------	--	--	--	--	--	--

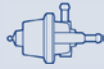

TYPE



TYPE



TYPE

						SAC039	H2		
						SAD006	H3		
	APS45					SAC039	H2		
						SAD006	H3		
						SAG105	H1		
						SAG135	H1	BAE680U	
						SAG135	H1		
						SAD014	H3		
						SAD014	H3		
						SAD014	H3		
						SAD014	H3		
						SAG094	H1		
						SAG135	H1		
						SAG135	H1		
						SAD014	H3		
						SAD014	H3		
						SAD014	H3		
						SAD014	H3		
						SAG112	H1		
						SAG094	H1		
		SPA138	F1			SAG135	H1	BAE680T	
						SAG135	H1		
						SAC058	H2		
						SAC058	H2		
						SAG135	H1	BAE680U	
						SAG068	H1		
						SAG068	H1		
						SAC018	H2		
						SAC018	H2		
						SAC058	H2		



KW



TYPE



TYPE

HYUNDAI

i30 (FD)

1.4	Petrol	80	10/07 → 11/11					
1.4	Petrol	77	10/07 → 11/11					
1.6	Petrol	90	10/07 → 11/11					
1.6	Petrol	85	10/07 → 11/11					
1.6	Petrol	93	02/08 → 11/11					
1.6 CRDi	Diesel	85	10/07 → 11/11					
1.6 CRDi	Diesel	66	10/07 → 11/11					

i30 CW (FD)

1.4	Petrol	77	10/07 → 06/12					
1.4	Petrol	80	11/09 → 06/12					
1.6	Petrol	90	02/08 → 06/12					
1.6	Petrol	93	02/08 → 06/12					
1.6 CRDi	Diesel	66	02/08 → 06/12					
1.6 CRDi	Diesel	85	02/08 → 06/12					

LANTRA I (J-1)

1.5 i.e.	Petrol	63	10/90 → 11/95					
1.6 i.e. 16V	Petrol	78	10/90 → 11/95					
1.6 i.e. 16V	Petrol	84	10/90 → 11/95					
1.8 i.e. 16V	Petrol	93	10/90 → 11/95					

LANTRA II (J-2)

1.5 12V	Petrol	65	12/96 → 09/00			SVF015	B6	
1.5 12V	Petrol	65	12/96 → 04/97					
1.5 12V	Petrol	65	12/96 → 09/00					
1.6 16V	Petrol	84	11/95 → 09/00			SVF015	B6	
1.6 16V	Petrol	84	11/95 → 04/97					
1.6 16V	Petrol	84	11/95 → 09/00					
1.6 i	Petrol	66	11/95 → 09/00			SVF015	B6	
1.6 i	Petrol	66	11/95 → 04/97					
1.6 i	Petrol	66	11/95 → 09/00					
1.6 i	Petrol	66	11/95 → 09/00					
1.8 16V	Petrol	94	11/95 → 09/00			SVF015	B6	
1.8 16V	Petrol	94	11/95 → 04/97					
1.8 16V	Petrol	94	11/95 → 09/00					
1.8 16V	Petrol	94	11/95 → 09/00					

LANTRA II Wagon (J-2)

1.5 12V	Petrol	65	04/97 → 09/00			SVF015	B6	
1.5 12V	Petrol	65	04/97 → 10/00					
1.5 12V	Petrol	65	04/97 → 10/00					
2.0 16V	Petrol	102	12/96 → 09/00			SVF015	B6	
2.0 16V	Petrol	102	12/96 → 04/97					
2.0 16V	Petrol	102	12/96 → 10/00					
2.0 16V	Petrol	102	12/96 → 10/00					
2.0 16V	Petrol	102	12/96 → 10/00					



KW

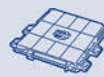

TYPE



TYPE

HYUNDAI

MATRIX (FC)

1.5 CRDi	Diesel	75	12/04 → 08/10					
1.5 CRDi VGT	Diesel	81	08/05 → 08/10					
1.6	Petrol	76	06/01 → 08/10				B3394	B1
1.6	Petrol	76	06/01 → 08/10				SVF016	B6
1.8	Petrol	90	06/01 → 08/10				SVF016	B6
1.8	Petrol	90	06/01 → 08/10					

PONY (X-2)

1.5 i	Petrol	61	07/92 → 01/95					
1.5 i	Petrol	62	07/92 → 01/95					

PONY / EXCEL Tre volumi (X-2)

1.5 i	Petrol	61	07/92 → 01/95					
1.5 i	Petrol	62	07/92 → 01/95					

S COUPE (SLC)

1.5 i	Petrol	65	07/92 → 04/95				SVF015	B6
1.5 i	Petrol	62	02/90 → 05/96					
1.5 i	Petrol	65	04/92 → 05/96					
1.5 i	Petrol	65	04/94 → 05/96					
1.5 i Turbo	Petrol	85	07/92 → 04/95				SVF015	B6
1.5 i Turbo	Petrol	85	04/91 → 05/96					
1.5 i Turbo	Petrol	85	04/94 → 05/96					

SANTA FÉ I (SM)

2.0 CRDi	Diesel	83	08/01 → 03/06					
2.0 CRDi	Diesel	83	08/01 → 03/06	ENGINE: D4EA				
2.0 CRDi 4x4	Diesel	83	04/01 → 03/06					
2.0 CRDi 4x4	Diesel	83	04/01 → 03/06	ENGINE: D4EA				
2.0 CRDi 4x4	Diesel	92	08/03 → 03/06					
2.0 CRDi Trazione integrale	Diesel	107	11/03 → 02/06	ENGINE: D4EA				
2.7 V6 4x4	Petrol	127	02/01 → 03/06					

SONATA IV (EF)

2.0 16V	Petrol	100	06/98 → 10/01					
2.4 16V	Petrol	105	03/98 → 10/01					
2.5 V6 24V	Petrol	118	06/98 → 10/01				SVF011	B6
2.7 V6	Petrol	127	10/01 → 11/04				SVF011	B6

TERRACAN (HP)

3.5 i V6 4WD	Petrol	143	12/01 → 12/06					
--------------	--------	-----	---------------	--	--	--	--	--

TRAJET (FO)

2.0	Petrol	100	03/00 → 07/08				B3394	B1
2.0	Petrol	100	03/04 → 07/08				SVF016	B6
2.0	Petrol	103	03/04 → 07/08				SVF016	B6
2.0	Petrol	100	03/00 → 07/08					
2.0	Petrol	103	01/04 → 07/08					
2.0 CRDi	Diesel	83	04/01 → 07/08					
2.7 V6	Petrol	127	09/00 → 07/08				SVF011	B6



KW



TYPE



TYPE

HYUNDAI

TUCSON (JM)

2.0	Petrol	104	08/04 → 03/10					B3394	B1
2.0	Petrol	104	08/04 → 03/10					SVF016	B6
2.0 CRDi	Diesel	83	08/04 → 03/10						
2.0 CRDi Trazione integrale	Diesel	83	08/04 → 03/10						
2.0 Trazione integrale	Petrol	104	08/04 → 03/10					SVF016	B6
2.7 Trazione integrale	Petrol	129	08/04 → 03/10					SVF011	B6

XG (XG)

30	Petrol	138	12/98 → 12/05					B3394	B1
250	Petrol	120	12/98 → 12/05					B3394	B1
250	Petrol	120	12/98 → 12/05					SVF011	B6
350	Petrol	145	10/02 → 12/05						

INFINITI

I30

3.0	Petrol	142	01/97 →						
-----	--------	-----	---------	--	--	--	--	--	--

J30

3.0	Petrol	157	01/92 → 12/97						
-----	--------	-----	---------------	--	--	--	--	--	--

Q45 I

4.5	Petrol	205	01/89 → 12/93						
-----	--------	-----	---------------	--	--	--	--	--	--

INNOCENTI

ELBA (146)

1.3 (146CW)	Petrol	49	08/91 → 12/96						
1.4 i.e. (146EN, 146EQ)	Petrol	49	09/94 → 12/96						
1.4 i.e. (146EN, 146EQ)	Petrol	49	06/95 → 12/96						
1.5 i.e. (146C9)	Petrol	55	08/92 → 09/94						
1.6 i.e. (146EO, 146ER)	Petrol	55	09/94 → 12/96						
1.6 i.e. (146EO, 146ER)	Petrol	55	03/95 → 12/96						
1.7 D (146DI, 146EI)	Diesel	42	08/91 → 12/96						

ISUZU

TROOPER

3.5 V6 24V	Petrol	158	04/00 →						
------------	--------	-----	---------	--	--	--	--	--	--

TROOPER Fuoristrada aperto

3.5 V6 24V	Petrol	158	04/00 →						
------------	--------	-----	---------	--	--	--	--	--	--

TROOPER Fuoristrada aperto (UBS)

2.6 i (UBS17)	Petrol	85	10/87 → 12/91						
---------------	--------	----	---------------	--	--	--	--	--	--

IVECO

DAILY I Cassone / Furgonato / Promiscuo

30-8 (10014131, 10014132, 10014137, 10014231, 10014232...)	Diesel	53	01/78 → 12/89						
--	--------	----	---------------	--	--	--	--	--	--

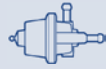

TYPE



TYPE

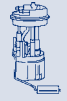

TYPE

SAD014

H3

GA2133

J2

SAG094

H1

BAE680V

GA2123

J2

GA2123

J2

SAD014

H3

SAA106

SPA138

F1

BAE680BX

BAE680N

SPA137

F1

SPA137

F1

SPA101

F1

SPA101

F1

ESS514

J1

BAE680AG

SPA101

F1

SPA101

F1

ESS514

J1

BAE680AG

SPA101

F1

APS44

APS44

SPA104

F1

SPA101

F1

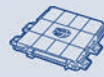
KW

TYPE

TYPE
IVECO
DAILY I Cassone / Furgonato / Promiscuo

35-10 (10314204, 10314211,
10314212, 10314217,
10314411...)

Diesel

68

01/85 → 12/89

35-8 (10034131, 10034132,
10034137, 10034224,
10034231...)

Diesel

53

01/78 → 12/89

40-8 V

Diesel

53

01/83 → 06/89

45-10 V (10334204, 10334211,
10334212, 10334217,
10334404)

Diesel

68

01/85 → 12/89

49-10 V (10354204, 10354211,
10354212, 10354217...)

Diesel

68

01/85 → 12/89

DAILY I Pianale piatto/Telaio

30-8 (10011131, 10011132,
10011231, 10011232,
10011237...)

Diesel

53

01/78 → 12/89

35-10 (10310311, 10311111,
10311112, 10311117,
10311211...)

Diesel

68

01/85 → 12/89

35-8 (10031131, 10031132,
10031137, 10031224,
10031231...)

Diesel

53

01/78 → 12/89

40-8

Diesel

53

01/83 → 06/89

45-10 (10331211, 10331212,
10331217, 10331304,
10331311...)

Diesel

68

01/85 → 12/89

49-10 (10350211, 10350304,
10350311, 10350404,
10350411...)

Diesel

68

01/85 → 12/89

DAILY II Autobus

A 40-10 (94139111, 94139131,
94139311, 94139315...)

Diesel

76

01/91 → 12/96

DAILY II Cassone / Furgonato / Promiscuo

35-10 (12974212, 12974217,
13014111, 13014131,
13014204...)

Diesel

76

06/96 → 08/98

35-10 (12974212, 12974217,
13014111, 13014131,
13014204...)

Diesel

80

06/96 → 08/98

40-10 V

Diesel

76

01/90 → 04/96

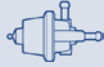

TYPE



TYPE



TYPE

				SPA101	F1				
				SPA101	F1				
				SPA101	F1				
				SPA101	F1				
				SPA101	F1				
				SPA101	F1				
				SPA101	F1				
				SPA101	F1				
				SPA101	F1				
				SPA101	F1				
				SPA101	F1				
				SPA104	F1				
				SPA104	F1				
				SPA101	F1				



KW

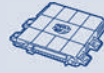

TYPE



TYPE

IVECO

DAILY II Pianale piatto/Telaio

35-10 (12971112, 12971212, 12971312, 12971317, 12976112...)

Diesel

68

07/92 → 12/96

35-10 (12971112, 12971212, 12971312, 12971317, 12976112...)

Diesel

76

07/92 → 12/96

DAILY III Cassone / Furgonato / Promiscuo

29 L 10 V (ALJA43A2, ALJA42A2, ALJA41A2)

Diesel

70

09/02 →

29 L 12 V (ALKA41A2, ALLA52A2, ALKA42A2)

Diesel

85

09/02 →

29 L 13

Diesel

92

05/01 →

29 L 14

Diesel

100

01/05 → 04/06

29 L 9 V

Diesel

66

11/01 → 04/06

35 C 12 V, 35 S 12 V (AGKA43A2, AGKB43A2, AGKB46A2...)

Diesel

85

09/02 →

35 C 14, 35 S 14

Diesel

100

01/05 → 04/06

35 S 10 (ANJA41A1, ANJA42A2, ANJA42AB, ANJA43A, ANJAV1A...)

Diesel

70

09/02 →

35 S 13 V, 35 C 13 V

Diesel

92

05/99 →

35 S 15 V, 35 C 15 V (A6HCV3B2, A6HBV4B2, A6HC41B2...)

Diesel

107

11/02 →

35 S 9 V

Diesel

66

11/01 → 04/06

40 C 13

Diesel

92

05/99 → 04/06

40 C 15

Diesel

107

11/01 → 04/06

50 C 13

Diesel

92

05/99 →

50 C 15

Diesel

107

01/01 → 04/06

65 C 15

Diesel

107

11/01 → 04/06

DAILY III Pianale piatto/Telaio

29 L 10 (ALJAV1A1, ALJA41AA, ALJA41A1, AHJA64A1...)

Diesel

70

09/02 →

29 L 12 (ALKA41A1, AHKA64A1, ALLA51A1)

Diesel

85

09/02 →

29 L 13

Diesel

92

11/01 →

29 L 14 (AHRA11C1B1, AHRA14C1B1, AHRA64C1B1)

Diesel

100

11/05 →

29 L 9

Diesel

66

11/01 → 04/06

35 C 10 V, 35 S 10 V (AMJA11A1, AMJA14A1, AMJA64A1...)

Diesel

70

09/02 →

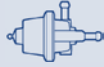

TYPE



TYPE



TYPE

SPA104

F1

SPA104

F1

APS50

SAC038

H2

ESS536

J1

APS50

SAC038

H2

APS50

APS50

APS50

APS50

SAC038

H2

APS50

APS50

SAC038

H2

APS50

ESS536

J1

APS50

APS50

APS50

APS50

APS50

APS50

APS50

APS50

SAC038

H2

ESS536

J1

APS50

SAC038

H2

APS50

APS50

SAC038

H2

APS50

APS50

SAC038

H2



KW



TYPE



TYPE

IVECO

DAILY III Pianale piatto/Telaio

35 C 12 , 35 S 12 (AEKA14A1, AEKA14AA, AEKA64A1...)	Diesel	85	09/02 →					
35 C 14, 35 S 14	Diesel	100	01/05 → 04/06					
35 C 15	Diesel	107	11/01 →					
35 C 9, 35 S 9	Diesel	66	11/01 → 04/06					
35 S 13,35 C 13	Diesel	92	05/99 →					
40 C 13	Diesel	92	05/99 → 04/06					
40 C 15	Diesel	107	11/01 → 04/06					
50 C 13	Diesel	92	05/99 →					
50 C 15	Diesel	107	01/01 →					
65 C 15	Diesel	107	11/01 →					

DAILY IV Autobus

35S14 G	Petrol/CNG	100	07/09 →	ENGINE: F1CE0441A			54DTS3I	B3
35S14 G	Petrol/CNG	100	07/09 →	ENGINE: F1CE0441A			KBLCF01	B2
35S14 G	Petrol/CNG	100	07/09 →					
35S14, 35S14 /P	Diesel	100	05/06 →	ENGINE: F1AE0481HA			54DTS3I	B3
35S14, 35S14 /P	Diesel	100	05/06 →	ENGINE: F1AE0481HA			KBLCF01	B2

DAILY IV Cassone / Furgonato / Promiscuo

29L10 V	Diesel	70	05/06 →	ENGINE: F1AE0481FA			54DTS3I	B3
29L10 V	Diesel	70	05/06 →	ENGINE: F1AE0481FA			KBLCF01	B2
29L12 V, 29L12 V/P	Diesel	85	05/06 →	ENGINE: F1AE0481GA			54DTS3I	B3
29L12 V, 29L12 V/P	Diesel	85	05/06 →	ENGINE: F1AE0481GA			KBLCF01	B2
29L12 V, 29L12 V/P	Diesel	85	05/06 →					
29L14 C, 29L14 C/P, 29L14 V, 29L14 V/P	Diesel	100	05/06 →	ENGINE: F1AE0481HA			54DTS3I	B3
29L14 C, 29L14 C/P, 29L14 V, 29L14 V/P	Diesel	100	05/06 →	ENGINE: F1AE0481HA			KBLCF01	B2
29L14 C, 29L14 C/P, 29L14 V, 29L14 V/P	Diesel	100	05/06 →					
35C10, 35S10	Diesel	70	05/06 →	ENGINE: F1AE0481FA			54DTS3I	B3
35C10, 35S10	Diesel	70	05/06 →	ENGINE: F1AE0481FA			KBLCF01	B2
35C10, 35S10	Diesel	70	05/06 →					
35C10, 35S10	Diesel	70	05/06 →					
35C11 V, 35S11 V	Diesel	78	07/07 →	ENGINE: F1AE0481FA			54DTS3I	B3
35C11 V, 35S11 V	Diesel	78	07/07 →	ENGINE: F1AE0481FA			KBLCF01	B2
35C11 V, 35S11 V	Diesel	78	07/07 →					
35C12 V, 35C12 V/P, 35S12 V, 35S12 V/P	Diesel	85	05/06 →	ENGINE: F1AE0481GA			54DTS3I	B3
35C12 V, 35C12 V/P, 35S12 V, 35S12 V/P	Diesel	85	05/06 →	ENGINE: F1AE0481GA			KBLCF01	B2
35C12 V, 35C12 V/P, 35S12 V, 35S12 V/P	Diesel	85	05/06 →					
35C12 V, 35C12 V/P, 35S12 V, 35S12 V/P	Diesel	85	05/06 →					

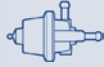

TYPE



TYPE



TYPE

APS50

SAC038

H2

APS50

APS50

APS50

APS50

ESS536

J1

APS50

ESS536

J1

APS50

APS50

ESS536

J1

APS50

APS50

GA2131

J2

GA2169

J2

GA2169

J2

ESS536

J1

GA2136

J2

ESS0068A

J1

ESS0068A

J1

GA2136

J2



KW

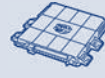

TYPE



TYPE

IVECO

DAILY IV Cassone / Furgonato / Promiscuo

35C13 V, 35C13 V/P, 35S13 V, 35S13 V/P	Diesel	93	07/07 →	ENGINE: F1AE0481GA			54DTS3I	B3
35C13 V, 35C13 V/P, 35S13 V, 35S13 V/P	Diesel	93	07/07 →	ENGINE: F1AE0481GA			KBLCF01	B2
35C13 V, 35C13 V/P, 35S13 V, 35S13 V/P	Diesel	93	07/07 →					
35C14 GV, 35C14 GV/P, 35S14 GV, 35S14 GV/P	Petrol/CNG	100	07/07 →					
35C15 V, 35C15 V/P	Diesel	107	05/06 →					
35C15 V, 35C15 V/P	Diesel	107	05/06 →					
35C18 V, 35C18 V/P, 35S18 V, 35S18 V/P	Diesel	130	05/06 →					
35C18 V, 35C18 V/P, 35S18 V, 35S18 V/P	Diesel	130	05/06 →					
35S14 C, 35S14 C/P, 35S14 V, 35S14 V/P, 35C14 V, 35C14 V/P	Diesel	100	05/06 →	ENGINE: F1AE0481HA			54DTS3I	B3
35S14 C, 35S14 C/P, 35S14 V, 35S14 V/P, 35C14 V, 35C14 V/P	Diesel	100	05/06 →	ENGINE: F1AE0481HA			KBLCF01	B2
35S14 C, 35S14 C/P, 35S14 V, 35S14 V/P, 35C14 V, 35C14 V/P	Diesel	100	05/06 →					
40C10 V	Diesel	70	05/06 →	ENGINE: F1AE0481FA			54DTS3I	B3
40C10 V	Diesel	70	05/06 →	ENGINE: F1AE0481FA			KBLCF01	B2
40C10 V	Diesel	70	05/06 →					
40C11 V	Diesel	78	07/07 →	ENGINE: F1AE0481FA			54DTS3I	B3
40C11 V	Diesel	78	07/07 →	ENGINE: F1AE0481FA			KBLCF01	B2
40C12 V, 40C14 V/P	Diesel	85	05/06 →	ENGINE: F1AE0481GA			54DTS3I	B3
40C12 V, 40C14 V/P	Diesel	85	05/06 →	ENGINE: F1AE0481GA			KBLCF01	B2
40C12 V, 40C14 V/P	Diesel	85	05/06 →					
40C13 V, 40C13 V/P	Diesel	93	07/07 →	ENGINE: F1AE0481GA			54DTS3I	B3
40C13 V, 40C13 V/P	Diesel	93	07/07 →	ENGINE: F1AE0481GA			KBLCF01	B2
40C14 GV, 40C14 GV/P	Petrol/CNG	100	07/07 →					
40C15 V, 40C15 V/P	Diesel	107	05/06 →					
40C15 V, 40C15 V/P	Diesel	107	05/06 →					
40C18 V, 40C18 V/P	Diesel	130	05/06 →					
45C15 V	Diesel	107	05/06 →					
45C18	Diesel	130	05/06 →					
50C14 GV, 50C14 GV/P	Petrol/CNG	100	07/07 →					
50C15 V, 50C15 V/P	Diesel	107	05/06 →					
50C15 V, 50C15 V/P	Diesel	107	05/06 →					
50C18 V, 50C18 V/P	Diesel	130	05/06 →					
50C18 V, 50C18 V/P	Diesel	130	05/06 →					

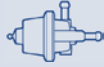

TYPE



TYPE



TYPE

ESS0068A J1

GA2131 J2

ESS0068A J1

GA2136 J2

ESS0068A J1

GA2136 J2

GA2136 J2

GA2169 J2

GA2169 J2

GA2131 J2

ESS0068A J1

GA2169 J2

GA2169 J2

GA2169 J2

GA2169 J2

GA2131 J2

ESS0068A J1

GA2136 J2

ESS0068A J1

GA2169 J2



KW

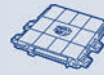

TYPE



TYPE

IVECO

DAILY IV Cassone / Furgonato / Promiscuo

60C15 V	Diesel	107	05/06 →					
60C18	Diesel	130	05/06 →					
60C18	Diesel	130	05/06 →					
65C15	Diesel	107	05/06 →					
65C15	Diesel	107	05/06 →					
65C18	Diesel	130	05/06 →					

DAILY IV Pianale piatto/Telaio

29L10	Diesel	70	05/06 →	ENGINE: F1AE0481FA			54DTS3I	B3
29L10	Diesel	70	05/06 →	ENGINE: F1AE0481FA			KBLCF01	B2
29L10	Diesel	70	05/06 →					
29L12	Diesel	85	05/06 →	ENGINE: F1AE0481GA			54DTS3I	B3
29L12	Diesel	85	05/06 →	ENGINE: F1AE0481GA			KBLCF01	B2
29L12	Diesel	85	05/06 →					
29L14	Diesel	100	05/06 →	ENGINE: F1AE0481HA			54DTS3I	B3
29L14	Diesel	100	05/06 →	ENGINE: F1AE0481HA			KBLCF01	B2
29L14	Diesel	100	05/06 →					
35C10, 35S10	Diesel	70	05/06 →	ENGINE: F1AE0481FA			54DTS3I	B3
35C10, 35S10	Diesel	70	05/06 →	ENGINE: F1AE0481FA			KBLCF01	B2
35C10, 35S10	Diesel	70	05/06 →					
35C10, 35S10	Diesel	70	05/06 →					
35C11, 35S11, 35S11 D, 35S11 /P	Diesel	78	07/07 →	ENGINE: F1AE0481FA			54DTS3I	B3
35C11, 35S11, 35S11 D, 35S11 /P	Diesel	78	07/07 →	ENGINE: F1AE0481FA			KBLCF01	B2
35C11, 35S11, 35S11 D, 35S11 /P	Diesel	78	07/07 →					
35C12, 35S12	Diesel	85	05/06 →	ENGINE: F1AE0481GA			54DTS3I	B3
35C12, 35S12	Diesel	85	05/06 →	ENGINE: F1AE0481GA			KBLCF01	B2
35C12, 35S12	Diesel	85	05/06 →					
35C12, 35S12	Diesel	85	05/06 →					
35C13, 35C13 /P, 35S13 D, 35S13, 35S13 /P	Diesel	93	07/07 →	ENGINE: F1AE0481GA			54DTS3I	B3
35C13, 35C13 /P, 35S13 D, 35S13, 35S13 /P	Diesel	93	07/07 →	ENGINE: F1AE0481GA			KBLCF01	B2
35C13, 35C13 /P, 35S13 D, 35S13, 35S13 /P	Diesel	93	07/07 →					
35C14 G, 35C14 G/P, 35S14 G, 35S14 G/P, 35C14 GD, 35S14 GD	Petrol/CNG	100	07/07 →					
35C14, 35S14, 35S14 /P	Diesel	100	05/06 →	ENGINE: F1AE0481HA			54DTS3I	B3
35C14, 35S14, 35S14 /P	Diesel	100	05/06 →	ENGINE: F1AE0481HA			KBLCF01	B2
35C14, 35S14, 35S14 /P	Diesel	100	05/06 →					
35C15	Diesel	107	05/06 →					
35C15	Diesel	107	05/06 →					

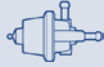

TYPE



TYPE



TYPE

GA2169	J2
ESS0068A	J1
GA2169	J2
ESS0068A	J1
GA2071	J2
GA2071	J2

GA2169	J2
--------	----

GA2169	J2
--------	----

GA2169	J2
--------	----

ESS536	J1
GA2136	J2

ESS0068A	J1
----------	----

ESS0068A	J1
GA2136	J2

ESS0068A	J1
----------	----

GA2131	J2
--------	----

GA2136	J2
ESS0068A	J1
GA2136	J2



KW



TYPE



TYPE

IVECO

DAILY IV Pianale piatto/Telaio

35C18, 35S18	Diesel	130	05/06 →					
35C18, 35S18	Diesel	130	05/06 →					
40C10	Diesel	70	05/06 →	ENGINE: F1AE0481FA			54DTS3I	B3
40C10	Diesel	70	05/06 →	ENGINE: F1AE0481FA			KBLCF01	B2
40C10	Diesel	70	05/06 →					
40C11, 40C11 D	Diesel	78	07/07 →	ENGINE: F1AE0481FA			54DTS3I	B3
40C11, 40C11 D	Diesel	78	07/07 →	ENGINE: F1AE0481FA			KBLCF01	B2
40C12	Diesel	85	05/06 →	ENGINE: F1AE0481GA			54DTS3I	B3
40C12	Diesel	85	05/06 →	ENGINE: F1AE0481GA			KBLCF01	B2
40C12	Diesel	85	05/06 →					
40C13, 40C13 /P	Diesel	93	07/07 →	ENGINE: F1AE0481GA			54DTS3I	B3
40C13, 40C13 /P	Diesel	93	07/07 →	ENGINE: F1AE0481GA			KBLCF01	B2
40C14 G, 40C14 G/P	Petrol/CNG	100	07/07 →					
40C15	Diesel	107	05/06 →					
40C15	Diesel	107	05/06 →					
40C18	Diesel	130	05/06 →					
45C15	Diesel	107	05/06 →					
45C18, 45C18 /P, 45C18 D, 45C18 D/P	Diesel	130	05/06 →					
50C14 G, 50C14 G/P, 50C14 GD, 50C14 GD/P	Petrol/CNG	100	07/07 →					
50C15	Diesel	107	05/06 →					
50C15	Diesel	107	05/06 →					
50C18	Diesel	130	05/06 →					
50C18	Diesel	130	05/06 →					
60C15, 60C15 /P, 60C15 D, 60C15 D/P	Diesel	107	05/06 →					
60C18	Diesel	130	05/06 →					
60C18	Diesel	130	05/06 →					
65C14 G, 65C14 G/P, 65C14 GD, 65C14 GD/P	Petrol/CNG	100	07/07 →					
65C15, 65C15 /P, 65C15 D, 65C15 D/P	Diesel	107	05/06 →					
65C15, 65C15 /P, 65C15 D, 65C15 D/P	Diesel	107	05/06 →					
65C18	Diesel	130	05/06 →					

DAILY IV Ribaltabile

35C10 K	Diesel	70	05/06 →	ENGINE: F1AE0481FA			54DTS3I	B3
35C10 K	Diesel	70	05/06 →	ENGINE: F1AE0481FA			KBLCF01	B2
35C10 K	Diesel	70	05/06 →					
35C10 K	Diesel	70	05/06 →					
35C10 K	Diesel	70	05/06 →					
35C11 K, 35C11 DK, 35S11 K, 35S11 DK	Diesel	78	07/07 →	ENGINE: F1AE0481FA			54DTS3I	B3

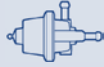

TYPE



TYPE



TYPE

ESS0068A J1

GA2136 J2

GA2169 J2

GA2169 J2

GA2131 J2

ESS0068A J1

GA2169 J2

GA2169 J2

GA2169 J2

GA2169 J2

GA2131 J2

ESS0068A J1

GA2136 J2

ESS0068A J1

GA2169 J2

GA2169 J2

ESS0068A J1

GA2169 J2

GA2131 J2

ESS0068A J1

GA2071 J2

GA2071 J2

ESS0068A J1

ESS536 J1

GA2136 J2

KW

TYPE

TYPE

IVECO

DAILY IV Ribaltabile

35C11 K, 35C11 DK, 35S11 K, 35S11 DK	Diesel	78	07/07 →	ENGINE: F1AE0481FA				KBLCF01	B2
35C11 K, 35C11 DK, 35S11 K, 35S11 DK	Diesel	78	07/07 →						
35C12	Diesel	85	05/06 →	ENGINE: F1AE0481GA				54DTS3I	B3
35C12	Diesel	85	05/06 →	ENGINE: F1AE0481GA				KBLCF01	B2
35C12	Diesel	85	05/06 →						
35C13 K, 35C13 DK, 35S13 K, 35S13 DK	Diesel	93	07/07 →	ENGINE: F1AE0481GA				54DTS3I	B3
35C13 K, 35C13 DK, 35S13 K, 35S13 DK	Diesel	93	07/07 →						
35C15	Diesel	107	05/06 →						
35C15	Diesel	107	05/06 →						
35C18	Diesel	130	05/06 →						
35C18	Diesel	130	05/06 →						
35S14 K, 35S14 DK	Diesel	100	07/07 →	ENGINE: F1AE0481HA				54DTS3I	B3
35S14 K, 35S14 DK	Diesel	100	07/07 →	ENGINE: F1AE0481HA				KBLCF01	B2
50C15	Diesel	107	05/06 →						
50C15	Diesel	107	05/06 →						
50C18	Diesel	130	05/06 →						
50C18	Diesel	130	05/06 →						
60C15	Diesel	107	05/06 →						
60C18	Diesel	130	05/06 →						
60C18	Diesel	130	05/06 →						

JAGUAR

S-TYPE (CCX)

2.5 V6	Petrol	147	04/02 → 10/07						
3.0 V6	Petrol	175	01/99 → 10/07						
4.0 V8	Petrol	203	01/99 → 04/02						
4.2 V8	Petrol	219	04/02 → 10/07						
R 4,2 V8	Petrol	291	04/02 → 10/07						

XF (_J05_, CC9)

3.0	Petrol	175	03/08 →						
4.2 Kompressor	Petrol	306	03/08 →						
5.0	Petrol	283	03/09 →						
5.0 Kompressor	Petrol	375	03/09 →						

XJ (X300)

12 6.0	Petrol	229	11/94 → 07/97						
6 3.2	Petrol	155	11/94 → 07/97						
6 Sovereign 4.0	Petrol	177	11/94 → 07/97						

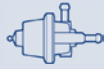

TYPE



TYPE



TYPE

ESS0068A J1

GA2136 J2

ESS0068A J1

ESS0068A J1

GA2136 J2

ESS0068A J1

GA2136 J2

ESS0068A J1

GA2136 J2

ESS0068A J1

GA2169 J2

GA2169 J2

ESS0068A J1

GA2169 J2

SPA116 F1 SAD037 H3

SAD037 H3

SPA116 F1 SAD037 H3

SPA116 F1

APS13 SPA116 F1

SAD037 H3

APS13

SAD040 H3

SAD040 H3

SPA168 F1

SGA114 F3

SGA114 F3

KW

TYPE

TYPE

JAGUAR

XJ (X350, X358)

3.0	Petrol	175	05/03 → 03/09						
3.5	Petrol	190	05/03 → 03/09						
4.2	Petrol	219	05/03 → 03/09						
R 4.2	Petrol	291	05/03 → 03/09						

XJ (XJ 40, 81)

6 2.9	Petrol	108	10/86 → 08/90						
6 2.9	Petrol	117	10/86 → 08/90						
6 2.9	Petrol	123	10/86 → 08/90						

XJ Coupé

5.3 H.E.	Petrol	194	01/86 → 12/89						
----------	--------	-----	---------------	--	--	--	--	--	--

XJSC Convertible

5.3 H.E.	Petrol	194	07/85 → 05/92						
----------	--------	-----	---------------	--	--	--	--	--	--

XK 8 Convertible (QDV)

4.2	Petrol	219	08/02 → 12/06						
R 4.2	Petrol	291	08/02 → 07/05						

XK 8 Coupé (QEV)

4.2	Petrol	219	08/02 → 12/06						
R 4.2	Petrol	291	08/02 → 07/05						

X-TYPE (CF1)

2.0 D	Diesel	96	07/03 → 11/09						
2.2 D	Diesel	114	10/05 → 11/09						
2.2 D	Diesel	107	01/07 → 11/09						

X-TYPE Estate

2.0 D	Diesel	96	02/04 → 12/09						
2.2 D	Diesel	114	10/05 → 12/09						
2.2 D	Diesel	107	01/07 → 12/09						

JEEP

CHEROKEE (XJ)

2.5 i 4x4	Petrol	90	12/91 → 12/95						
2.5 i 4x4	Petrol	90	12/91 → 09/01						
4.0 i	Petrol	135	12/91 → 12/95						
4.0 i	Petrol	136	01/88 → 12/95						
4.0 i	Petrol	135	12/91 → 09/01						
4.0 i	Petrol	136	01/88 → 09/01						

WRANGLER I (YJ, SJ_)

2.5	Petrol	89	12/91 → 12/95						
2.5	Petrol	89	12/91 → 08/96						
4.0	Petrol	131	12/91 → 12/95						
4.0	Petrol	131	12/91 → 08/96						

WRANGLER II (TJ)

4.0	Petrol	124	06/98 → 04/07						
4.0 Rubicon	Petrol	128	08/03 → 04/07						



TYPE



TYPE



TYPE

						SAD037	H3		
				SPA116	F1				
				SPA116	F1				
	APS13			SPA116	F1				
			RP03A	SPA129	F1				
			RP03A	SPA129	F1				
			RP03A	SPA129	F1				
								PI024	J1
								PI024	J1
				SPA116	F1				
				SPA116	F1				
				SPA116	F1				
				SPA116	F1				
				SPA148	F1	SAD040	H3		
				SPA148	F1	SAD040	H3		
						SAD040	H3		
				SPA148	F1	SAD040	H3		
				SPA148	F1	SAD040	H3		
						SAD040	H3		
	APS45							ESS0014A	J1
	APS45								
	APS45							ESS0014A	J1
								ESS0014A	J1
	APS45							ESS0014A	J1
	APS45							ESS0014A	J1
						SAG044	H1		
						SAG044	H1		

KW

TYPE

TYPE
KIA
BESTA Furgonato

2.2 D Diesel 48 02/96 →

CARENS I (FC)

1.8 i Petrol 81 11/00 → 07/02

SVF015 B6

CARENS II (FJ)

1.6 Petrol 77 07/02 →

1.8 Petrol 93 07/02 →

2.0 CVVT Petrol 102 08/04 →

CARENS III (UN)

2.0 CRDi 115 Diesel 85 05/07 →

TB0003 B3

2.0 CRDi 140 Diesel 103 09/06 →

TB0003 B3

CARNIVAL / GRAND CARNIVAL III (VQ)

2.7 V6 Petrol 139 06/06 →

2.9 CRDi Diesel 136 06/06 →

CARNIVAL I (UP)

2.5 V6 Petrol 121 08/99 → 10/01

SVF015 B6

2.9 TD Diesel 93 08/99 → 10/01

CARNIVAL II (GQ)

2.5 V6 Petrol 110 10/01 →

SVF015 B6

2.9 CRDi Diesel 106 10/01 →

CEE'D 2 volumi /Coda spiovente (ED)

1.4 Petrol 80 12/06 →

1.4 Petrol 77 12/06 →

1.6 Petrol 90 12/06 →

1.6 Petrol 93 02/08 →

1.6 CRDi 115 Diesel 85 12/06 →

1.6 CRDi 128 Diesel 94 10/10 →

1.6 CRDi 90 Diesel 66 12/06 →

CEE'D SW (ED)

1.4 Petrol 80 09/07 →

1.6 Petrol 90 09/07 →

1.6 Petrol 85 09/07 →

1.6 Petrol 93 09/07 →

1.6 CRDi 115 Diesel 85 09/07 →

1.6 CRDi 128 Diesel 94 10/10 →

1.6 CRDi 90 Diesel 66 09/07 →

CERATO (LD)

1.5 CRDi Diesel 75 07/05 →

1.6 Petrol 77 07/04 →

1.6 CRDi Diesel 85 06/05 →

2.0 Petrol 105 04/04 →

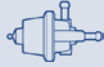

TYPE



TYPE



TYPE

					SAA110				
					SAA111	SAG066	H1		
					SAA111	SAG054	H1	BAE680X	
					SAA111				
						SAD014	H3		
								BAE680X	
						SAG041	H1		
					SAA111				
	SPA137	F1			SAA111	SAG054	H1		
					SAA111				
						SAG066	H1		
						SAC041	H2	GA2189	J2
								GA2189	J2
						SAC041	H2		
								GA2189	J2
						SAC058	H2	SUA575	J3
								SUA575	J3
						SAC058	H2	SUA575	J3
						SAC041	H2	GA2189	J2
						SAC041	H2	GA2189	J2
								GA2189	J2
								GA2189	J2
						SAC058	H2	SUA575	J3
								SUA575	J3
						SAC058	H2	SUA575	J3
						SAC058	H2		
								BAE680U	GA2189
						SAC058	H2		SUA575
						SAD014	H3		

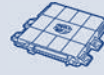
KW

TYPE

TYPE
KIA
CERATO Tre volumi (LD)

1.5 CRDi	Diesel	75	07/05 →						
1.6	Petrol	90	05/06 →						
1.6 CRDi	Diesel	85	06/05 →						
2.0	Petrol	105	04/04 →						

CLARUS Station wagon (GC)

1.8 i 16V	Petrol	85	05/98 →						
2.0 i 16V	Petrol	98	05/98 →						

K2700 (SD)

2.7 D	Diesel	59	10/99 →						
-------	--------	----	---------	--	--	--	--	--	--

MAGENTIS (GD)

2.0	Petrol	100	05/01 →						
2.5 V6	Petrol	124	05/01 →						

OPIRUS (GH)

3.5	Petrol	149	09/03 →						
-----	--------	-----	---------	--	--	--	--	--	--

PICANTO (BA)

1.0	Petrol	45	04/04 →						
1.0	Petrol	46	11/09 →						
1.1	Petrol	48	04/04 →						
1.1 CRDi	Diesel	55	11/05 →						

PREGIO Furgonato (TB)

2.7 D	Diesel	60	10/97 →						
-------	--------	----	---------	--	--	--	--	--	--

PRIDE (DA)

1.1 i	Petrol	38	01/91 →						
1.3 i	Petrol	51	01/90 →						

PRIDE Station wagon

1.3	Petrol	47	08/99 → 01/00					SVF015	B6
1.3	Petrol	47	08/99 →						

RETONA (CE)

2.0 16V	Petrol	94	05/00 → 12/00					SVF015	B6
2.0 16V	Petrol	94	05/00 →						
2.0 16V	Petrol	94	05/00 →						
2.0 TD	Diesel	61	06/99 → 12/02						
2.0 TD	Diesel	61	06/99 →						
2.0 TD	Diesel	61	06/99 → 12/00						

RIO II (JB)

1.5 CRDi	Diesel	81	03/05 →						
1.6 CVVT	Petrol	82	03/05 →						

RIO II Tre volumi (JB)

1.5 CRDi	Diesel	81	03/05 →						
----------	--------	----	---------	--	--	--	--	--	--

RIO Station wagon (DC)

1.3	Petrol	55	08/00 → 02/05					SVF015	B6
1.3	Petrol	60	08/00 → 02/05					SVF015	B6
1.5 16V	Petrol	71	09/02 → 02/05					SVF015	B6
1.5 16V	Petrol	72	08/00 → 02/05					SVF015	B6

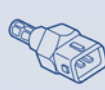
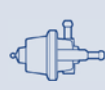

TYPE

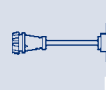

TYPE



TYPE

						SAC058	H2	
						SAC041	H2	
						SAC058	H2	
						SAD014	H3	
					SPA137	F1	SAA111	SAG067
					SPA137	F1	SAA111	H1
					SAA111			
					SPA138	F1		SAC030
					SPA138	F1		H2
								BAE680BX
							SAG112	H1
							SAG112	H1
							SAG112	H1
							SAC058	H2
					SAA111			
					SPA137	F1	SAA110	
					SPA137	F1	SAA110	
					SAA110			
					SPA137	F1	SAA111	SAD006
								H3
							SAG067	H1
					SPA137	F1		
							SAA110	
							SAG067	H1
							SAC058	H2
							BAE680U	
							SAC058	H2
					SAA111			
					SAA111			
					SAA111			
					SAA111			

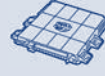
KW

TYPE

TYPE
KIA
RIO Tre volumi (DC_)

1.3	Petrol	55	09/00 → 02/05						SVF015	B6
1.3	Petrol	60	08/02 → 02/05							
1.5 16V	Petrol	72	09/00 → 02/05						SVF015	B6

SHUMA (FB)

1.5 i 16V	Petrol	65	10/97 → 03/01						SVF015	B6
1.8 i 16V	Petrol	81	10/97 → 03/01						SVF015	B6

SHUMA II (FB)

1.6	Petrol	75	05/01 → 08/04						SVF015	B6
1.8	Petrol	84	04/03 → 08/04						SVF015	B6
1.8	Petrol	84	04/03 → 08/04							

SHUMA II Tre volumi (FB)

1.6	Petrol	75	05/01 → 05/04						SVF015	B6
-----	--------	----	---------------	--	--	--	--	--	--------	----

SHUMA Tre volumi (FB)

1.5	Petrol	59	03/96 → 12/98							
1.5 i 16V	Petrol	65	10/97 → 10/01						SVF015	B6

SORENTO I (JC)

2.4	Petrol	102	08/02 →							
2.5 CRDi	Diesel	103	01/04 → 04/06							
3.5 V6	Petrol	143	08/02 →							

SPORTAGE (JE_)

2.0 16V 4WD	Petrol	104	09/04 →							
2.0 CRDi	Diesel	83	02/05 →							
2.0 i 16V	Petrol	104	09/04 →							

SPORTAGE (K00)

2.0	Petrol	87	10/00 → 08/03						SVF015	B6
2.0	Petrol	87	10/00 → 08/03							
2.0	Petrol	87	10/00 → 08/03							
2.0 4WD	Petrol	87	10/00 → 08/03						SVF015	B6
2.0 4WD	Petrol	87	10/00 → 08/03							
2.0 4WD	Petrol	87	10/00 → 08/03							
2.0 i 16V	Petrol	94	10/99 → 08/03						SVF015	B6
2.0 i 16V	Petrol	94	10/99 → 08/03							
2.0 i 16V	Petrol	94	10/99 → 08/03							
2.0 i 16V 4WD	Petrol	94	04/94 → 10/98						SVF015	B6
2.0 i 16V 4WD	Petrol	94	04/94 → 08/03							
2.0 i 4WD	Petrol	70	04/94 → 09/98						SVF015	B6
2.0 i 4WD	Petrol	70	04/94 → 08/99							
2.0 TD 4WD	Diesel	61	10/97 → 08/03							
2.0 TD 4WD	Diesel	61	10/97 → 08/03							



TYPE



TYPE



TYPE

	APS56				SAA111	SAG054	H1		
					SAA111				
	APS56				SAA111	SAG054	H1	BAE680X	
	APS45		SPA137	F1	SAA111				
	APS45		SPA137	F1	SAA111	SAG066	H1		
	APS56				SAA111	SAG054	H1		
	APS45		SPA137	F1	SAA111	SAD024	H3		
						SAG066	H1		
	APS56				SAA111				
	APS45		SPA137	F1	SAA111				
	APS45		SPA137	F1	SAA111				
						SAC030	H2		
						SAG068	H1		
								BAE680BX	
						SAD014	H3		
								GA2123	J2
						SAD014	H3		
			SPA137	F1	SAA111	SAC026	H2		
						SAD006	H3		
						SAG067	H1		
			SPA137	F1	SAA111	SAC026	H2		
						SAD006	H3		
						SAG067	H1		
			SPA137	F1	SAA111	SAC026	H2		
						SAD006	H3		
						SAG067	H1		
			SPA137	F1	SAA111	SAG067	H1		
			SPA137	F1	SAA111	SAG067	H1		
			SPA137	F1	SAA110	SAC026	H2		
						SAG067	H1		

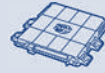
KW

TYPE

TYPE
LADA
110

1.5	Petrol	57	01/96 → 12/04
1.5 16V	Petrol	67	10/00 → 12/04
1.5 16V	Petrol	70	01/96 → 12/04
1.6	Petrol	66	01/05 →

111

1.5	Petrol	57	01/96 → 12/04
1.5 16V	Petrol	67	10/00 → 12/04
1.5 16V	Petrol	70	01/96 → 12/04
1.6	Petrol	60	01/05 →

112

1.5	Petrol	54	01/96 → 12/04
1.5	Petrol	56	10/00 → 12/04
1.5	Petrol	57	01/96 → 12/04
1.5 16V	Petrol	67	10/00 → 12/04
1.5 16V	Petrol	70	01/96 → 12/04
1.6	Petrol	60	01/05 →
1.6	Petrol	66	03/06 →

NIVA (2121)

1600	Petrol	56	04/80 → 12/87
1600	Petrol	56	12/76 → 05/87

PRIORA 2 volumi /Coda spiovente (2172)

1.6	Petrol	72	12/08 →
1.6 LPG	Petrol/LPG	71	12/08 →

PRIORA Station wagon (2171)

1.6	Petrol	60	10/09 →
1.6	Petrol	72	10/09 →

PRIORA Tre volumi (2170)

1.6	Petrol	72	12/08 →
1.6 LPG	Petrol/LPG	71	03/09 →

SAMARA (2108, 2109, 2115)

1100	Petrol	39	02/88 → 12/94
1300	Petrol	48	01/86 → 12/94
1500	Petrol	53	01/88 →
1500	Petrol	52	02/95 → 01/04
1.5	Petrol	57	04/96 →

SAMARA FORMA (21099)

1500	Petrol	52	11/94 →
1.5	Petrol	57	01/00 → 01/04
1.5	Petrol	59	08/03 → 01/04

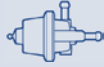

TYPE



TYPE



TYPE

BAE680DK

BAE680DK

BAE680DK

BAE680DK

BAE680DK

BAE680DK

BAE680DK

BAE680DK

BAE680DK

BAE680DK

BAE680DK

BAE680DK

BAE680DK

BAE680DK

BAE680DK

SPA101

F1

SPA101

F1

BAE680DK

BAE680DK

BAE680DK

BAE680DK

BAE680DK

BAE680DK

SPA101

F1

SPA101

F1

SPA101

F1

BAE680DK

BAE680DK

BAE680DK

BAE680DK

BAE680DK

BAE680DK



KW

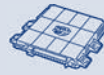

TYPE



TYPE

LANCIA

A 112

0.9 Junior (A112B/2)	Petrol	29	03/81 → 06/86
1.0 Abarth (A112B2/5)	Petrol	51	03/78 → 02/84
1.0 LX	Petrol	35	03/84 → 12/86

DEDRA (835)

1.6 16V (835EI)	Petrol	76	01/96 → 07/99			46SXF8	B3
1.6 16V (835EI)	Petrol	76	01/96 → 07/99			KITEC1/02	B2
1.6 16V (835EI)	Petrol	76	01/96 → 07/99	ENGINE: 182A4000			
1.6 i.e. (835AB)	Petrol	57	08/89 → 03/93				
1.6 i.e. (835AB)	Petrol	57	08/89 → 03/93				
1.6 i.e. (835AN)	Petrol	55	04/93 → 07/99				
1.6 i.e. (835AN)	Petrol	55	04/93 → 10/94				
1.6 LE (835EB) Cat.	Petrol	66	07/94 → 07/99				
1.8 i.e. (835AT)	Petrol	66	08/93 → 12/96			KITPF1C	B6
1.8 i.e. (835AT)	Petrol	66	01/94 → 12/96			B02	B1
1.8 i.e. (835AT)	Petrol	66	08/93 → 07/99				
1.8 i.e. (835BD, 835AD)	Petrol	77	09/89 → 12/96			KITPF1C	B6
1.8 i.e. (835BD, 835AD)	Petrol	77	01/94 → 12/96			B02	B1
1.8 i.e. (835BD, 835AD)	Petrol	77	09/89 → 07/99				
1.8 i.e. (835BD, 835AD)	Petrol	77	09/89 → 07/99				
1.8 i.e. (835BD, 835AD)	Petrol	77	09/89 → 07/99				
1.8 i.e. (835BD, 835AD)	Petrol	77	09/89 → 07/99				
1.8 i.e. (835FA)	Petrol	74	07/94 → 12/97			KITEC1/02	B2
1.8 i.e. (835FA)	Petrol	74	07/94 → 12/96			B02	B1
1.8 i.e. (835FA)	Petrol	74	07/94 → 12/96			KITPF1C	B6
1.8 i.e. (835FA)	Petrol	74	07/94 → 07/99				
1.8 i.e. (835FA)	Petrol	74	07/94 → 12/97				
1.8 i.e. (835FA)	Petrol	74	07/94 → 07/99				
1.8 i.e. (835FA)	Petrol	74	07/94 → 07/94				
1.9 TDS (835EE, 835EF)	Diesel	66	04/89 → 07/99				
2.0 16V (835ED)	Petrol	102	07/94 → 07/99				
2.0 16V (835ED)	Petrol	102	07/94 → 07/99				
2.0 16V (835ED)	Petrol	102	07/94 → 07/94				
2.0 HF Integrale (835AP)	Petrol	124	11/90 → 07/94				
2.0 HF Integrale (835AP)	Petrol	124	11/90 → 12/92				
2.0 HF Integrale (835AP)	Petrol	124	11/90 → 12/92				
2.0 i.e. (835AL)	Petrol	83	09/89 → 07/99				
2.0 i.e. (835AL)	Petrol	83	09/89 → 12/97				
2.0 i.e. (835AL)	Petrol	83	09/89 → 12/97				
2.0 i.e. (835AL)	Petrol	83	09/89 → 07/99				
2.0 i.e. (835AL)	Petrol	83	09/89 → 07/99				
2.0 i.e. Turbo (835AR)	Petrol	119	04/91 → 07/91				
2.0 i.e. Turbo (835AR)	Petrol	119	04/91 → 12/92				
2.0 i.e. Turbo (835AR)	Petrol	119	04/91 → 12/92				
2.0 i.e. Turbo (835AR)	Petrol	119	04/91 → 07/99				
2.0 i.e. Turbo Integrale (835AO)	Petrol	121	05/90 → 07/94				

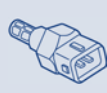
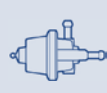

TYPE

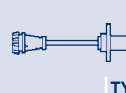

TYPE



TYPE

			SPA101	F1	SAA107			BK2A		
			SPA101	F1				BK2A		
IWP064	APS45					CWM02/1	H1			
	KITTPRT05/2							BAE920AX		
			SZA103	F1		SEN8M	H1	BAE504D	ESS514	J1
			WTS05-1	F1						
			KITATS05	F2		SAG026	H1			
						SAG076	H1	BAE680AG	ESS514	J1
	APS45		SPA115	F1	SAA101				ESS0039A	J1
						SAG026	H1			
	PRT03/04		ATS04-1	F2		SAG026	H1			
			SZA103	F1		SEN8I	H1			
			WTS05-1	F1						
		KITRPM36								
	PRT03/04		SZA103	F1	SAA101	SEN8I3	H1	BAE800B	ESS452	J1
		RPM36								
			WTS05-1	F1						
			ATS04-1	F2						
						SEN8U	H1			
	PRT03/04	KITRPM40	SZA103	F1	SAA101	SEN8I	H1		ESS0095A	J1
		RPM40	WTS05-1	F1						
			ATS04-1	F2						
			ATS04-1	F2		SEN8I	H1		ESS0039A	J1
			SZA103	F1						
			WTS05-1	F1						
	PRT03/04		ATS04-1	F2		SAG026	H1			
		KITRPM40								
		RPM40								
			SZA103	F1		SEN8I	H1			
			WTS05-1	F1						
			ATS04-1	F2						
			SZA103	F1						
			WTS05-1	F1						
						SEN8I	H1		ESS0039A	J1
									ESS0039A	J1



KW

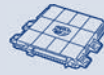

TYPE



TYPE

LANCIA

DEDRA (835)

2.0 Turbo (835AQ) Petrol 130 11/90 → 06/94

DEDRA SW (835)

1.6 (835EB) Petrol 66 10/94 → 07/99

1.6 16V (835EI) Petrol 76 01/96 → 07/99

46SXF8 B3

1.6 16V (835EI) Petrol 76 01/96 → 07/99

KITEC1/02 B2

1.6 16V (835EI) Petrol 76 01/96 → 07/99 ENGINE: 182A4000

1.8 i.e. (835FA) Petrol 74 07/94 → 12/97

KITEC1/02 B2

1.8 i.e. (835FA) Petrol 74 07/94 → 07/99

1.8 i.e. (835FA) Petrol 74 07/94 → 12/97

1.8 i.e. (835FA) Petrol 74 07/94 → 07/99

1.8 i.e. (835FA) Petrol 74 07/94 → 07/94

1.9 TDS (835EE, 835EF) Diesel 66 07/94 → 07/99

2.0 16V (835ED) Petrol 102 07/94 → 07/99

2.0 16V (835ED) Petrol 102 07/94 → 07/99

2.0 16V (835ED) Petrol 102 07/94 → 07/94

2.0 Integrale (835ED) Petrol 102 07/94 → 07/99

2.0 Integrale (835ED) Petrol 102 07/94 → 12/97

2.0 Integrale (835ED) Petrol 102 07/94 → 12/97

2.0 Integrale (835ED) Petrol 102 07/94 → 07/99

2.0 Integrale (835ED) Petrol 102 07/94 → 07/94

DELTA I (831AB0)

1.3 Petrol 58 09/83 → 12/86

1.3 Petrol 58 01/86 → 08/92

1.3 (831AB.011) Petrol 55 09/79 → 12/86

1.3 (831AB.011) Petrol 55 01/86 → 08/92

1.5 (831AB.025) Petrol 63 09/79 → 12/92

1.6 GT Petrol 77 11/82 → 04/86

1.6 GT i.e. (831AB.010) Petrol 66 05/87 → 08/92

1.6 HF Turbo Petrol 122 08/86 → 05/93

1.6 HF Turbo (831AB.020S) Petrol 97 04/87 → 03/89

2.0 16V HF Evo Integrale (831AB.027) Petrol 155 06/93 → 01/94

2.0 16V HF Evo Integrale (831AB.027) Petrol 155 06/93 → 01/94

2.0 16V HF Evo Integrale (831AB.027) Petrol 155 06/93 → 01/94

2.0 16V HF Integrale (831AB.026) Petrol 144 03/89 → 09/91

2.0 16V HF Integrale (831AB.026) Petrol 144 03/89 → 09/91

2.0 16V HF Integrale (831AB.026) Petrol 144 03/89 → 09/89

2.0 HF Integrale (831AB.024) Petrol 133 10/87 → 02/89

2.0 HF Integrale (831AB.024) Petrol 133 10/87 → 02/89



TYPE

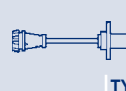

TYPE



TYPE

									ESS0039A	J1
		APS45	SPA115	F1					ESS0039A	J1
IWP064	APS45					CWM02/1	H1			
	KITTPRT05/2									
								BAE920AX		
		KITRPM36								
	PRT03/04		SZA103	F1	SAA101	SEN8I3	H1	BAE800B	ESS452	J1
		RPM36								
			WTS05-1	F1						
			ATS04-1	F2						
					SAA101	SEN8U	H1			
	PRT03/04	KITRPM40	SZA103	F1	SAA101	SEN8I	H1		ESS0095A	J1
		RPM40	WTS05-1	F1						
			ATS04-1	F2						
	PRT03/04		SZA103	F1	SAA101	SEN8I	H1		ESS0095A	J1
		KITRPM40								
		RPM40								
			WTS05-1	F1						
			ATS04-1	F2						
								BK2A		
								BAE506F		
								BK2A		
								BAE506F		
						SEN8D	H1	BAE504F		
						SEN8D	H1			
	APS45								ESS0039A	J1
		RP7/01								
	APS45	RP7/01								
		RP7/01	ATS04-1	F2		SAD009	H3	BAE800B		
			SZA103	F1		SEN8D	H1			
			WTS05-1	F1						
		RP7/01	SZA103	F1		SEN8D	H1			
			WTS05-1	F1						
			ATS04-1	F2						
		RP7/01	ATS04-1	F2		SEN8D	H1			
			SZA103	F1						



KW



TYPE



TYPE

LANCIA

DELTA I (831AB0)

2.0 HF Integrale (831AB.024)	Petrol	133	10/87 → 02/89					
2.0 HF Integrale (831AB.024S, 831AB.028)	Petrol	130	01/87 → 12/92					
2.0 HF Integrale (831AB.024S, 831AB.028)	Petrol	130	01/87 → 12/92					
2.0 HF Integrale (831AB.024S, 831AB.028)	Petrol	130	01/87 → 12/92					

DELTA II (836)

1.4 i.e. (836AF, 836AH)	Petrol	51	10/94 → 08/99					
1.4 i.e. (836AF, 836AH)	Petrol	51	10/94 → 08/99					
1.4 i.e. (836AF, 836AH)	Petrol	51	10/94 → 08/95					
1.6 i.e. (836AD)	Petrol	55	06/93 → 08/99					
1.6 i.e. (836AD)	Petrol	55	06/93 → 08/95					
1.8 i.e. (836AE)	Petrol	76	06/93 → 12/97			KITEC1/02	B2	
1.8 i.e. (836AE)	Petrol	76	06/93 → 12/96			B02	B1	
1.8 i.e. (836AE)	Petrol	76	06/93 → 12/97			KITPF1C	B6	
1.8 i.e. (836AE)	Petrol	76	06/93 → 08/99					
1.8 i.e. (836AE)	Petrol	76	06/93 → 12/97					
1.8 i.e. (836AE)	Petrol	76	06/93 → 08/99					
1.8 i.e. (836AE)	Petrol	76	06/93 → 08/93					
1.8 i.e. (836AG, 836AL)	Petrol	66	07/94 → 12/97			KITEC1/02	B2	
1.8 i.e. (836AG, 836AL)	Petrol	66	07/94 → 12/97			KITPF1C	B6	
1.8 i.e. (836AG, 836AL)	Petrol	66	07/94 → 08/99					
1.8 i.e. (836AG, 836AL)	Petrol	66	07/94 → 12/97					
1.8 i.e. (836AG, 836AL)	Petrol	66	07/94 → 08/99					
1.8 i.e. (836AG, 836AL)	Petrol	66	07/94 → 08/94					
1.9 TD (836AM, 836AN)	Diesel	66	10/94 → 08/99					
2.0 16V (836AA, 836CA)	Petrol	102	06/93 → 08/99					
2.0 16V (836AA, 836CA)	Petrol	102	06/93 → 12/97					
2.0 16V (836AA, 836CA)	Petrol	102	06/93 → 12/97					
2.0 16V (836AA, 836CA)	Petrol	102	06/93 → 08/99					
2.0 16V (836AA, 836CA)	Petrol	102	06/93 → 08/93					
2.0 16V Turbo (836AB)	Petrol	137	06/93 → 12/97					
2.0 16V Turbo (836AB)	Petrol	137	06/93 → 12/97					
2.0 16V Turbo (836AB)	Petrol	137	06/93 → 08/99					
2.0 16V Turbo (836AB)	Petrol	137	06/93 → 08/99					
2.0 16V Turbo (836AB)	Petrol	137	06/93 → 08/93					
2.0 16V Turbo (836AS)	Petrol	142	07/96 → 08/99					

DELTA III (844)

1.4	Petrol	110	09/08 →					
1.4	Petrol	88	09/08 →					
1.4	Petrol	110	09/08 → 07/10					
1.4 16V	Petrol	103	08/10 →					
1.4 BiFuel	Petrol/LPG	88	07/11 →					

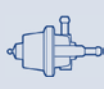

TYPE

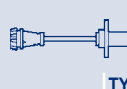

TYPE



TYPE

					WTS05-1	F1						
					ATS04-1	F2		SEN8D	H1			
					SZA103	F1						
					WTS05-1	F1						
								SAG076	H1	BAE504D	GA2155	J2
								SEN8M	H1	BAE680AG		
											ESS514	J1
							SAA101	SAG076	H1	BAE680AG	ESS0095A	J1
											ESS514	J1
					KITRPM36							
				PRT03/04	SZA103	F1	SAA101	SEN8I3	H1	BAE800B	ESS0095A	J1
					RPM36							
					WTS05-1	F1						
					ATS04-1	F2						
					KITRPM36							
				PRT03/04	SZA103	F1		SEN8I3	H1	BAE800B	ESS0095A	J1
					RPM36							
					WTS05-1	F1						
					ATS04-1	F2						
				PRT03/04	SZA103	F1	SAA101	SEN8U	H1			
								SEN8I	H1		ESS0039A	J1
					KITRPM40							
					RPM40							
					WTS05-1	F1						
					ATS04-1	F2						
					KITRPM36							
					RPM36							
					SZA103	F1	SAA101	SEN8I	H1	BAE800B		
					WTS05-1	F1						
					ATS04-1	F2						
								SAD009	H3			
					SPA156	F1		SAC095	H2		GA2073	J2
					SPA156	F1		SAC095	H2	BAE680BQ	GA2073	J2
										BAE680BQ		
										BAE680CD		
										BAE680BQ		

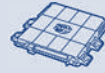
KW

TYPE

TYPE
LANCIA
DELTA III (844)

1.6 D Multijet	Diesel	88	09/08 →					48CPD6G	B3
1.6 D Multijet	Diesel	77	04/11 →						
1.6 D Multijet	Diesel	85	08/08 →						
1.9 D Multijet	Diesel	140	01/09 →					48CPD6G	B3
2.0 D Multijet	Diesel	121	09/08 →					48CPD6G	B3
2.0 D Multijet	Diesel	120	09/08 →						

KAPPA (838A)

2.0 16V Turbo (838AB1AA)	Petrol	151	02/95 → 06/98					SVF015	B6
2.0 16V Turbo (838AB1AA)	Petrol	151	02/95 → 10/01						
2.0 20V (838AA1AA)	Petrol	107	10/94 → 10/01					B3393	B1
2.0 20V (838AA1AA)	Petrol	107	10/94 → 06/96					SVF015	B6
2.0 20V (838AA1AA)	Petrol	107	10/94 → 12/96						
2.0 20V (838AA1AA)	Petrol	107	10/94 → 06/96						
2.0 20V (838AA1AA)	Petrol	107	11/94 → 06/96						
2.0 20V Turbo (838AM1AA)	Petrol	162	06/98 → 10/01					B3393	B1
2.0 20V Turbo (838AM1AA)	Petrol	162	06/98 → 12/00					SVF015	B6
2.0 20V Turbo (838AM1AA)	Petrol	162	06/98 → 12/00						
2.4 20V (838AC1AA, 838AC11A)	Petrol	129	08/94 → 10/01					B3393	B1
2.4 20V (838AC1AA, 838AC11A)	Petrol	129	11/94 → 06/98					SVF015	B6
2.4 20V (838AC1AA, 838AC11A)	Petrol	129	08/94 → 06/98						
2.4 20V (838AC1AA, 838AC11A)	Petrol	129	06/98 → 10/01						
2.4 JTD (838AL1AA)	Diesel	100	06/98 → 12/00						
2.4 JTD (838AL1AA)	Diesel	100	06/98 → 10/01						
2.4 JTD (838AL1AA)	Diesel	100	06/98 → 10/01						
2.4 JTD (838AL1AA)	Diesel	100	06/98 → 10/01						
2.4 T.DS (838AE1AA, 838AH1AA)	Diesel	91	11/94 → 03/98						
3.0 24V (838AD1AA, 838AD11A, 838XD1AA, 838ZD1AA)	Petrol	150	11/94 → 06/98					SVF015	B6
3.0 24V (838AD1AA, 838AD11A, 838XD1AA, 838ZD1AA)	Petrol	150	08/94 → 10/01						
3.0 24V (838AD1AA, 838AD11A, 838XD1AA, 838ZD1AA)	Petrol	150	11/94 → 12/00						

KAPPA Coupé (838)

2.0 20V	Petrol	114	07/96 → 03/01					B3393	B1
2.0 20V	Petrol	114	07/96 → 06/98					SVF015	B6
2.0 20V	Petrol	114	07/96 → 06/98						
2.0 20V	Petrol	114	06/98 → 03/01						
2.0 20V Turbo (838CM)	Petrol	162	06/98 → 03/01					B3393	B1
2.0 20V Turbo (838CM)	Petrol	162	06/98 → 06/00					SVF015	B6
2.0 20V Turbo (838CM)	Petrol	162	06/98 → 06/00						

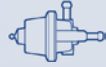

TYPE

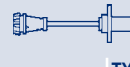

TYPE



TYPE

APS36

SAF001

H4

GA2126

J2

SAF001

H4

SAF001

H4

SAF001

H4

GA2126

J2

APS36

SAF001

H4

GA2126

J2

APS36

SAF001

H4

ATS08

F2

BAE680AG

SPA104

F1

SAD009

H3

SPA129

F1

SAD009

H3

SAC049

H2

SPA104

F1

SAG043

H1

BAE680CY

SAD013

H3

GA2087

J2

ATS08

F2

SAC049

H2

BAE680CY

SAG043

H1

SPA104

F1

SAD009

H3

SAG043

H1

BAE680CY

SAC049

H2

SAG122

H1

APS31

SPA103

F1

SAC088

H2

ESS0066A

J1

ESS537

J1

GA2087

J2

SAG043

H1

BAE680AP

SPA104

F1

GA2087

J2

SAC029

H2

SAD013

H3

SAC049

H2

BAE680CY

SAG043

H1

SAG122

H1

ATS08

F2

SAD013

H3

GA2087

J2

SAC049

H2

BAE680CY

SAG043

H1



KW

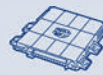

TYPE



TYPE

LANCIA

KAPPA SW (838B)

2.0 20V Turbo (838BM1AA)	Petrol	162	06/98 → 10/01				B3393	B1
2.0 20V Turbo (838BM1AA)	Petrol	162	06/98 → 12/00				SVF015	B6
2.0 20V Turbo (838BM1AA)	Petrol	162	06/98 → 12/00					
2.4 JTD (838BL1AA)	Diesel	100	06/98 → 12/00					
2.4 JTD (838BL1AA)	Diesel	100	06/98 → 10/01					
2.4 JTD (838BL1AA)	Diesel	100	06/98 → 10/01					
2.4 JTD (838BL1AA)	Diesel	100	06/98 → 10/01					

LYBRA (839AX)

1.6 16V (839AXA1A)	Petrol	76	07/99 → 12/00		IAW49F.B1	A1		
1.6 16V (839AXA1A)	Petrol	76	01/01 → 10/05		IAW4EF.B5	A1	46SXF11	B3
1.6 16V (839AXA1A)	Petrol	76	07/99 → 10/05				46SXF8	B3
1.6 16V (839AXA1A)	Petrol	76	07/99 → 10/05	ENGINE: 182B6000				
1.8 16V (839AXB1A, 839AXG1A)	Petrol	96	07/99 → 10/05					
1.9 JTD	Diesel	85	05/01 → 10/05				TB0018	B3
1.9 JTD	Diesel	85	05/01 → 10/05	ENGINE: 2705194 →				
1.9 JTD	Diesel	85	05/01 → 10/05					
1.9 JTD (839AXD1A)	Diesel	77	10/99 → 09/00					
1.9 JTD (839AXD1A)	Diesel	77	07/99 → 09/00					
1.9 JTD (839AXD1A)	Diesel	77	09/99 → 09/00					
1.9 JTD (839AXI1A)	Diesel	81	09/00 → 05/01	ENGINE: 2705194 →				
1.9 JTD (839AXI1A)	Diesel	81	09/00 → 05/01					
1.9 JTD (839AXI1A)	Diesel	81	09/00 → 05/01					
2.0 20V (839AXC11, 839AXC1A)	Petrol	113	07/99 → 09/00					
2.0 20V (839AXC11, 839AXC1A)	Petrol	113	07/99 → 09/00					
2.0 20V (839AXC11, 839AXC1A)	Petrol	113	07/99 → 09/00					
2.0 20V (839AXC11, 839AXC1A)	Petrol	113	10/99 → 09/00					
2.0 20V (839AXH1A)	Petrol	110	09/00 → 10/05					
2.0 20V (839AXH1A)	Petrol	110	09/00 → 10/05					
2.0 20V (839AXH1A)	Petrol	110	09/00 → 10/05					
2.0 20V (839AXH1A)	Petrol	110	10/00 → 09/05					
2.4 JTD	Diesel	110	05/02 → 10/05				TB0018	B3
2.4 JTD	Diesel	110	05/02 → 09/05					
2.4 JTD (839AXE1A)	Diesel	99	07/99 → 02/01				TB0018	B3
2.4 JTD (839AXE1A)	Diesel	99	10/99 → 02/01					
2.4 JTD (839AXE1A)	Diesel	99	09/99 → 02/01					
2.4 JTD (839AXL1A)	Diesel	103	09/00 → 05/02				TB0018	B3
2.4 JTD (839AXL1A)	Diesel	103	09/00 → 05/02					

LYBRA SW (839BX)

1.6 16V (839BXA1A)	Petrol	76	07/99 → 12/00		IAW49F.B1	A1		
1.6 16V (839BXA1A)	Petrol	76	01/01 → 10/05		IAW4EF.B5	A1	46SXF11	B3
1.6 16V (839BXA1A)	Petrol	76	07/99 → 10/05				46SXF8	B3
1.6 16V (839BXA1A)	Petrol	76	07/99 → 10/05	ENGINE: 182B6000				
1.8 16V (839BXB1A, 839BXG1A)	Petrol	96	07/99 → 10/05					
1.9 JTD	Diesel	85	05/01 → 10/05				TB0018	B3



TYPE

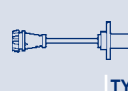

TYPE



TYPE

						SAD013	H3		GA2087	J2
			ATS08	F2		SAC049	H2	BAE680CY		
						SAG043	H1			
	APS31									
			SPA103	F1		SAC088	H2		ESS0066A	J1
									ESS537	J1
									GA2106	J2
			SZA105	F1						
IWP064	KITTPRT05/2					CWM02/1	H1		GA2099	J2
								BAE920AX		
								BAE680G	GA2099	J2
			SPA103	F1		SAC088	H2		ESS0066A	J1
	APS23									
									SUA525	J2
	APS31									
			SPA103	F1		SAC088	H2		ESS0066A	J1
									SUA525	J2
	APS23									
			SPA103	F1		SAC088	H2		ESS0066A	J1
									SUA525	J2
						SAC024	H2		GA2099	J2
						SAD003	H3			
						SAG122	H1			
								BAE680AM		
						SAC024	H2		GA2099	J2
						SAD003	H3			
						SAG122	H1			
								BAE680AM		
	APS23		SPA103	F1		SAC088	H2		ESS0066A	J1
									SUA525	J2
			SPA103	F1		SAC088	H2		ESS0066A	J1
	APS31									
									SUA525	J2
	APS23		SPA103	F1		SAC088	H2		ESS0066A	J1
									SUA525	J2
			SZA105	F1						
IWP064	KITTPRT05/2					CWM02/1	H1		GA2099	J2
								BAE920AX		
								BAE680G	GA2099	J2
			SPA103	F1		SAC088	H2		ESS0066A	J1



KW



TYPE



TYPE

LANCIA

LYBRA SW (839BX)

1.9 JTD	Diesel	85	05/01 → 10/05	ENGINE: 2705194 →				
1.9 JTD	Diesel	85	05/01 → 10/05					
1.9 JTD (839BXD1A)	Diesel	77	10/99 → 09/00					
1.9 JTD (839BXD1A)	Diesel	77	07/99 → 09/00					
1.9 JTD (839BXD1A)	Diesel	77	09/99 → 09/00					
1.9 JTD (839BXI1A)	Diesel	81	09/00 → 05/01	ENGINE: 2705194 →				
1.9 JTD (839BXI1A)	Diesel	81	09/00 → 05/01					
1.9 JTD (839BXI1A)	Diesel	81	09/00 → 05/01					
2.0 20V (839BXC11, 839BXC1A)	Petrol	113	07/99 → 09/00					
2.0 20V (839BXC11, 839BXC1A)	Petrol	113	07/99 → 09/00					
2.0 20V (839BXC11, 839BXC1A)	Petrol	113	07/99 → 09/00					
2.0 20V (839BXC11, 839BXC1A)	Petrol	113	10/99 → 09/00					
2.0 20V (839BXH1A)	Petrol	110	09/00 → 10/05					
2.0 20V (839BXH1A)	Petrol	110	09/00 → 10/05					
2.0 20V (839BXH1A)	Petrol	110	09/00 → 10/05					
2.0 20V (839BXH1A)	Petrol	110	10/00 → 09/05					
2.4 JTD	Diesel	110	05/02 → 10/05				TB0018	B3
2.4 JTD	Diesel	110	05/02 → 09/05					
2.4 JTD (839BXE1A)	Diesel	99	10/99 → 09/00				TB0018	B3
2.4 JTD (839BXE1A)	Diesel	99	10/99 → 09/00					
2.4 JTD (839BXL1A)	Diesel	103	09/00 → 10/05				TB0018	B3
2.4 JTD (839BXL1A)	Diesel	103	09/00 → 05/02					
2.4 JTD (839BXL1A)	Diesel	103	09/00 → 05/02					

MUSA (350)

1.3 D Multijet	Diesel	66	09/06 →	ENGINE: → 1866163	MJD6F3M3	A1		
1.3 D Multijet	Diesel	66	09/06 →	ENGINE: → 1866163	MJD6JFM5	A1		
1.3 D Multijet	Diesel	66	05/09 →		MJD6F3M3/3	A1		
1.3 D Multijet	Diesel	66	07/08 →		MJD6F3M5	A1		
1.3 D Multijet	Diesel	70	03/09 →					
1.3 D Multijet	Diesel	51	10/04 →					
1.3 D Multijet	Diesel	51	10/04 →					
1.3 D Multijet	Diesel	66	09/06 →					
1.3 D Multijet	Diesel	66	09/06 →					
1.4	Petrol	57	09/05 →				44SMF9/1	B3
1.4	Petrol	57	09/05 →				KIT EC2/1	B2
1.4	Petrol	70	10/04 →				TB0009	B3
1.4	Petrol	70	10/04 →					
1.4	Petrol	57	09/05 →	ENGINE: 831A1000				
1.4 LPG	Petrol/LPG	57	11/10 →	ENGINE: 350A1000			44SMF9/1	B3
1.6 D Multijet	Diesel	85	07/08 →					
1.6 D Multijet	Diesel	88	07/08 →					
1.9 D Multijet	Diesel	74	10/04 →					

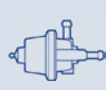

TYPE

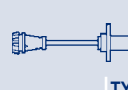

TYPE



TYPE

	APS23							SUA525	J2
	APS31		SPA103	F1		SAC088	H2	ESS0066A	J1
								SUA525	J2
	APS23		SPA103	F1		SAC088	H2	ESS0066A	J1
								SUA525	J2
						SAC024	H2	GA2099	J2
						SAD003	H3		
						SAG122	H1		
								BAE680AM	
						SAC024	H2	GA2099	J2
						SAD003	H3		
						SAG122	H1		
								BAE680AM	
	APS23		SPA103	F1		SAC088	H2	ESS0066A	J1
								SUA525	J2
	APS31		SPA103	F1		SAC088	H2	ESS0066A	J1
								SUA525	J2
	APS23		SPA103	F1		SAC088	H2	ESS0066A	J1
	APS31								
								SUA525	J2
	APS36		SPA146	F1		SAF001	H4		
						SAC093	H2	SUA524	J2
						SAG025	H1		
						SAC093	H2		
						SAG025	H1		
	IWP160		SPA156	F1		CVM03/1	H1	ESS0028A	J1
								GA2208	J2
			SPA156	F1		SAD026	H3	BAE403C	J1
								GA2208	J2
								BAE940A	
	APS36					SAF001	H4		
	APS36					SAF001	H4		
	APS36		ATS20	F2		SAC088	H2	SUA524	J2

KW

TYPE

TYPE
LANCIA
PHEDRA (179)

2.0 (179AXA11)	Petrol	100	09/02 → 11/10					
2.0 (179AXA11)	Petrol	100	09/02 → 11/10					
2.0 D Multijet	Diesel	100	07/06 → 11/10					
2.0 D Multijet	Diesel	100	07/06 → 11/10					
2.0 JTD	Diesel	88	11/07 → 11/10	ENGINE: RHK, RHK(DW10UTED4)			50CAD281	B3
2.0 JTD	Diesel	79	07/03 → 11/10					
2.0 JTD	Diesel	88	06/06 → 11/10					
2.0 JTD (179AXB1A)	Diesel	80	09/02 → 11/10					
2.2 D Multijet	Diesel	125	03/08 → 11/10					
2.2 JTD (179AXC1A)	Diesel	94	09/02 → 06/03					
2.2 JTD (179AXC1A)	Diesel	94	09/02 → 11/10					
3.0 V6	Petrol	150	09/02 → 11/10					

PRISMA (831AB0)

1.3	Petrol	58	01/86 → 02/92					
1.5	Petrol	63	01/83 → 04/86					
1.6	Petrol	77	01/83 → 04/86					
2.0 i.e. Trazione integrale	Petrol	85	04/86 → 12/89					
2.0 i.e. Trazione integrale	Petrol	85	01/88 → 12/89					
2.0 i.e. Trazione integrale	Petrol	85	01/88 → 12/89					
2.0 i.e. Trazione integrale	Petrol	85	01/88 → 12/89					

THEMA (834)

2000 i.e (834AB)	Petrol	86	09/88 → 05/92					
2000 i.e.	Petrol	83	03/86 → 09/88					
2000 i.e. (834BV)	Petrol	85	09/87 → 05/92					
2000 i.e. (834BV)	Petrol	85	05/92 → 05/92					
2000 i.e. 16V (834AA)	Petrol	108	05/88 → 05/92				SVF009	B6
2000 i.e. 16V (834AA)	Petrol	108	05/88 → 08/92					
2000 i.e. 16V (834AI)	Petrol	104	02/89 → 05/92				SVF009	B6
2000 i.e. 16V Turbo (834AL)	Petrol	130	04/89 → 05/92					
2000 i.e. Turbo (834C)	Petrol	122	11/84 → 12/87					
2000 i.e. Turbo (834CV)	Petrol	110	01/88 → 05/90					
2500 Turbo DS (834AE)	Diesel	85	06/88 → 05/92					
2500 Turbo DS (834AM)	Diesel	77	05/88 → 07/92					
2850 V6 i.e. (834AD, 834CD, 834BD)	Petrol	108	06/88 → 05/92					
2850 V6 i.e. (834AD, 834CD, 834BD)	Petrol	108	06/88 → 09/91					
3000 V6 (834GD, 834FD)	Petrol	126	08/92 → 07/94				SVF015	B6
3000 V6 (834GD, 834FD)	Petrol	126	08/92 → 07/94					



TYPE

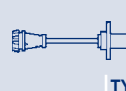

TYPE



TYPE

	APS62		SPA107	F1	SAA118	SAC070	H2			
						SAD033	H3			
			ATS22	F2	SAA118	SAC096	H2			
			SPA172	F1		SAG169	H1			
			SPA107	F1	SAA118					
			SPA172	F1	SAA118	SAC096	H2			
	APS35		SPA107	F1	SAA118					
	APS58		ATS22	F2						
	APS35				SAA118					
	APS62		SPA107	F1	SAA118	SAD008	H3	BAE680BD		
								BAE506F		
			SPA101	F1				BAE504F		
						SEN8D	H1			
	PRT03/04									
			ATS04-1	F2		SEN8D	H1			
			SZA103	F1						
			WTS05-1	F1						
			SPA104	F1						
						SEN8D	H1	BAE504D		
			SPA104	F1		SEN8D	H1	BAE504D	ESS534	J1
								BAE680AG		
			SPA104	F1						
			SPA104	F1		SEN8D	H1	BAE800B		
			SPA104	F1		SEN8D	H1	BAE800B	ESS0174A	J1
						SEN8D	H1			
			SPA104	F1						
			SPA104	F1						
			SPA104	F1						
			SPA129	F1		SAD013	H3			
						SAG066	H1			
			SPA104	F1		SAD009	H3	BAE680W	ESS534	J1
						SAG029	H1			



KW

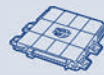

TYPE



TYPE

LANCIA

THEMA SW (834)

2000 16V (834FA)	Petrol	112	05/92 → 07/94			SVF015	B6
2000 i.e. 16V (834AA)	Petrol	108	05/89 → 05/92			SVF009	B6
2000 i.e. 16V (834AA)	Petrol	108	05/89 → 08/92				
2000 i.e. 16V (834AI)	Petrol	104	02/89 → 05/92			SVF009	B6
2000 i.e. 16V Turbo (834AC)	Petrol	133	12/88 → 06/90				
2000 i.e. 16V Turbo (834AL)	Petrol	130	04/89 → 03/93				
2000 Turbo	Petrol	110	01/89 → 03/92				
2500 Turbo DS (834AE)	Diesel	85	06/88 → 05/92				
2500 Turbo DS (834AM)	Diesel	77	05/88 → 07/92				
3000 V6 (834GD, 834FD)	Petrol	126	09/92 → 07/94			SVF015	B6
3000 V6 (834GD, 834FD)	Petrol	126	09/92 → 07/94				

THESIS (841AX)

2.0 Turbo (841AXA1B03)	Petrol	136	07/02 → 07/09				
2.0 Turbo (841AXA1B03)	Petrol	136	07/02 → 07/09				
2.0 Turbo (841AXA1B03)	Petrol	136	07/02 → 07/09				
2.4 (841AXB1B00)	Petrol	125	07/02 → 07/09				
2.4 (841AXB1B00)	Petrol	125	07/02 → 07/09				
2.4 (841AXB1B00)	Petrol	125	07/02 → 07/09				
2.4 D Multijet	Diesel	136	04/06 → 07/09			TB0018	B3
2.4 JTD	Diesel	129	05/03 → 07/09			TB0017	B3
2.4 JTD	Diesel	129	05/03 → 07/09				
2.4 JTD (841AXD1B02)	Diesel	110	07/02 → 07/09			TB0018	B3
3.0 V6 (841AXC1101)	Petrol	158	07/02 → 07/09				
3.0 V6 (841AXC1101)	Petrol	158	07/02 → 07/09				
3.0 V6 (841AXC1101)	Petrol	158	07/02 → 07/03				
3.2 V6	Petrol	169	05/03 → 07/09				
3.2 V6	Petrol	169	05/03 → 07/09				
3.2 V6	Petrol	169	08/03 → 07/09				

Y (840A)

1.1 (840AE)	Petrol	40	11/95 → 09/03			KITEC1/02	B2
1.1 (840AE)	Petrol	40	11/95 → 12/00			B12	B1
1.1 (840AE)	Petrol	40	11/95 → 12/00			KITPF2C	B6
1.1 (840AE)	Petrol	40	11/95 → 09/03				
1.1 (840AE)	Petrol	40	11/95 → 09/03				
1.2 (840AA, 840AF1A)	Petrol	44	01/01 → 09/03	IAW59F.M5/1	A1	KIT EC2/1	B2
1.2 (840AA, 840AF1A)	Petrol	44	01/01 → 09/03	IAW59FM5R/1	A2		
1.2 (840AA, 840AF1A)	Petrol	44	03/96 → 09/03			KITEC1/02	B2
1.2 (840AA, 840AF1A)	Petrol	44	03/96 → 12/00			B12	B1
1.2 (840AA, 840AF1A)	Petrol	44	03/96 → 12/00			KITPF2C	B6
1.2 (840AA, 840AF1A)	Petrol	44	03/96 → 09/03				
1.2 (840AA, 840AF1A)	Petrol	44	03/96 → 09/03				
1.2 (840AA, 840AF1A)	Petrol	44	03/96 → 06/00				
1.2 (840AA, 840AF1A)	Petrol	44	01/03 → 09/03				
1.2 16V (840AD)	Petrol	63	04/97 → 09/03			40SXF1	B3



TYPE



TYPE



TYPE

				SPA104	F1		SAD009	H3	BAE680AG	ESS534	J1
				SPA104	F1						
				SPA104	F1		SEN8D	H1	BAE800B		
				SPA104	F1						
				SPA104	F1				BAE800B		
				SPA104	F1				BAE800B	ESS0174A	J1
				SPA104	F1						
				SPA104	F1						
				SPA104	F1		SAD009	H3	BAE680W	ESS534	J1
							SAG029	H1			
		APS55		ATS10	F2		SAC024	H2	BAE680AM	GA2062	J2
							SAD026	H3			
							SAG122	H1			
							SAC024	H2	BAE680AM	GA2062	J2
							SAD003	H3			
							SAG122	H1			
		APS36								ESS0066A	J1
		APS36					SAC068	H2		ESS0066A	J1
							SAG133	H1		GA2062	J2
		APS23					SAC088	H2		ESS0066A	J1
							SAC029	H2		GA2062	J2
							SAG039	H1			
									BAE680AP		
							SAC029	H2			
							SAG039	H1			
									BAE680AP		
		PRT03/04		KITATS05	F2		CWM02/3	H1	BAE800B	SUA130	J2
				SZA103	F1						
				WTS05-1	F1						
	IWP116/1	KITTPRT05/2		SZA105	F1					GA2022	J2
		PRT03/04		KITATS05	F2		CWM02/3	H1	BAE800B	ESS0095A	J1
				SZA103	F1					SUA130	J2
				WTS05-1	F1						
							SAG121	H1			
							CWM02/8	H1			
	IWP045	KITTPRT05/2	KITRPM40	SZA103	F1				BAE800B	ESS0095A	J1



KW

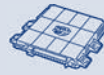

TYPE



TYPE

LANCIA

Y (840A)

1.2 16V (840AD)	Petrol	63	04/97 → 09/03				KITEC1/02	B2
1.2 16V (840AD)	Petrol	63	04/97 → 04/99				KITPF2C	B6
1.2 16V (840AD)	Petrol	63	01/01 → 09/03					
1.2 16V (840AG1A)	Petrol	59	10/00 → 06/03				TB0011	B3
1.2 16V (840AG1A)	Petrol	59	10/00 → 09/03					
1.2 16V (840AG1A)	Petrol	59	10/00 → 06/03					
1.2 16V (840AG1A)	Petrol	59	01/01 → 09/03					
1.4 12V (840AC)	Petrol	55	03/96 → 09/03					
1.4 12V (840AC)	Petrol	55	03/96 → 06/00					

Y10 (156)

1.0 Fire	Petrol	37	03/85 → 02/90					
1.0 Fire	Petrol	37	01/86 → 02/90					
1.0 Fire (156AA)	Petrol	33	03/85 → 06/89					
1.0 Fire (156AE) Cat.	Petrol	33	10/87 → 02/92					
1.0 Fire (156B, 156AD)	Petrol	32	06/85 → 06/91					
1.0 Fire (156B, 156AD)	Petrol	32	01/86 → 06/91					
1.0 Fire (156C)	Petrol	41	03/85 → 07/89					
1.0 Fire Trazione integrale	Petrol	37	12/87 → 02/90					
1.0 Fire Trazione integrale (156AE)	Petrol	33	12/87 → 02/92					
1.0 Turbo (156D)	Petrol	62	03/85 → 02/89					
1.1 Avenue (156AG)	Petrol	40	01/95 → 12/95					
1.1 Avenue Trazione integrale (156AG)	Petrol	40	01/95 → 12/95					
1.1 i.e. Fire (156AG)	Petrol	37	07/89 → 09/95					
1.1 i.e. Fire (156AG)	Petrol	37	09/92 → 09/95					
1.1 i.e. Fire Trazione integrale (156AG)	Petrol	37	09/92 → 12/95					
1.3 i.e. Fire (156AB)	Petrol	56	11/87 → 05/93					
1.3 i.e. Fire (156AF)	Petrol	53	02/89 → 12/95					

YPSILON (843)

1.2	Petrol	44	10/03 → 12/11		IAW5AF.N8/4	A1	KIT EC2/1	B2
1.2	Petrol	44	10/03 → 12/11					
1.2	Petrol	51	08/10 → 12/11	ENGINE: 169A4000			40GTE3F	B3
1.2	Petrol	59	10/03 → 12/11					
1.2	Petrol	59	10/03 → 12/11					
1.3 D Multijet	Diesel	55	09/06 → 12/11		MJD6F3Y2	A1		
1.3 D Multijet	Diesel	55	09/06 → 12/11		MJD6F3Y5	A1		
1.3 D Multijet	Diesel	66	09/06 → 12/11					
1.3 D Multijet	Diesel	77	05/07 → 12/11					
1.3 D Multijet	Diesel	66	09/06 → 12/11					
1.3 JTD	Diesel	51	10/03 → 12/11					
1.3 JTD	Diesel	51	10/03 → 12/11					
1.3 JTD	Diesel	51	10/03 → 09/06					



TYPE

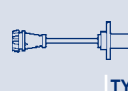

TYPE



TYPE

			RPM40	WTS05-1	F1				SUA133	J2
									GA2022	J2
									BAE680AG	
						SAD026	H3		SUA130	J2
									SUA542	J2
									GA2022	J2
				SPA104	F1	SAD013	H3		SUA130	J2
						SAG121	H1	BAE680AG	ESS514	J1
				SPA104	F1					
									BAE506D	
				SPA104	F1					
				SPA104	F1				BAE506D	
				SPA104	F1					
									BAE506D	
				SPA104	F1					
				SPA104	F1				BAE506D	
				SPA104	F1					
						SEN8D	H1			
									BAE680AG	
									BAE680AG	
				SPA104	F1				BAE506D	
									BAE680AG	
									BAE680AG	
									BAE504D	
									BAE504D	
	IWP160							CWM02/3	H1	BAE800B
								SAC095	H2	
								CWM02/3	H1	BAE800B
								SAD026	H3	GA2208
								SAC093	H2	SUA524
								SAG025	H1	
		APS25		ATS20	F2	SAC093	H2			
		APS36								
						SAG025	H1			
		APS23				SAC093	H2			
						SAG025	H1			
									SUA524	J2

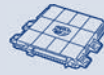
KW

TYPE

TYPE
LANCIA
YPSILON (843)

1.4	Petrol	57	02/06 → 12/11		IAW5SF3.M9	A1	44SMF9/1	B3
1.4	Petrol	57	10/06 → 12/11					
1.4 16V	Petrol	70	10/03 → 12/11				TB0013	B3
1.4 16V	Petrol	70	03/04 → 12/11					
1.4 16V	Petrol	70	10/03 → 12/11					
1.4 16V	Petrol	70	10/03 → 12/11	ENGINE: 843A1000				
1.4 LPG	Petrol/LPG	57	11/10 → 12/11	ENGINE: 350A1000			44SMF9/1	B3

YPSILON (846)

0.9 Twinair	Petrol	63	06/11 →					
1.2	Petrol	51	05/11 →	ENGINE: 169A4000			40GTE3F	B3
1.2 Bifuel	BiFuel	49	05/11 →	ENGINE: 169A4000			40GTE3F	B3
1.3 Multijet	Diesel	70	05/11 →					

ZETA (220)

2.0 16V (220AL5)	Petrol	97	06/99 → 07/00					
2.0 16V (220AL5)	Petrol	97	05/98 → 07/00					
2.0 16V (220AL5)	Petrol	97	09/99 → 07/00					
2.0 16V (220AQ5)	Petrol	100	07/00 → 09/02					
2.0 16V (220AQ5)	Petrol	100	07/00 → 09/02					
2.0 JTD	Diesel	80	04/00 → 09/02					
2.0 JTD (220AN5)	Diesel	80	09/99 → 09/02					
2.0 JTD (220AN5)	Diesel	80	07/01 → 09/02					
2.0 Turbo (220AD5, 220CD5)	Petrol	108	05/95 → 06/95				SVF015	B6
2.0 Turbo (220AD5, 220CD5)	Petrol	108	05/95 → 09/02					
2.0 Turbo (220AD5, 220CD5)	Petrol	108	09/99 → 09/02					
2.0 Turbo (220AD5, 220CD5)	Petrol	108	02/98 → 06/99					

LAND ROVER
DEFENDER Cabrio (LD)

2.2 Td4	Diesel	90	08/11 →				AMM19656	B4
2.4 Td4 4x4	Diesel	90	05/07 →				AMM19656	B4
2.5 Td5 4x4	Diesel	90	06/98 →					

DEFENDER Pick-up (LD_)

2.2 Td4	Diesel	90	08/11 →				AMM19656	B4
2.4 Td4 4x4	Diesel	90	05/07 →				AMM19656	B4
2.4 Td4 4x4	Diesel	90	05/07 →	ENGINE: 25P				
2.5 Td5 4x4	Diesel	90	06/98 →					

DEFENDER Station Wagon (LD)

2.2 Td4	Diesel	90	08/11 →				AMM19656	B4
2.4 Td4 4x4	Diesel	90	05/07 →				AMM19656	B4
2.4 Td4 4x4	Diesel	90	05/07 →	ENGINE: 23P,25P				
2.5 Td5 4x4	Diesel	90	06/98 →					

DISCOVERY I (LJ, LG)

2.5 TDI 4x4	Diesel	83	10/89 → 10/98					
-------------	--------	----	---------------	--	--	--	--	--

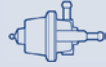

TYPE



TYPE



TYPE

IWP160			SPA156	F1			BAE940A	ESS0028A	J1
						SAC095	H2		
						SAD026	H3	ESS0028A	J1
			SPA156	F1					
								GA2208	J2
							BAE403C		
							BAE680DB		
			SPA146	F1		SAF001	H4		
	APS76					SAA118	SAG028	H1	
							SAG027	H1	
			SPA107	F1	SAA118	SAD033	H3		
							SAG027	H1	
						SAA118			
	APS35		SPA107	F1	SAA118	SAG027	H1		
								SUA494	J2
						SAA118	SAG028	H1	
							SAG027	H1	
								BAE680AF	
							SAC083	H2	
	APS64								
							SAC083	H2	
	APS64								
							SAC083	H2	
	APS64								
							SAC083	H2	
	APS64								
			SPA104	F1					



KW



TYPE



TYPE

LAND ROVER

DISCOVERY II (LJ, LT)

2.5 Td5 4x4	Diesel	102	01/99 → 06/04					
4.0 V8 4x4	Petrol	136	11/98 → 06/04			SVF016	B6	

FREELANDER (LN)

1.8 16V 4x4	Petrol	86	11/00 → 10/06					
1.8 16V 4x4	Petrol	86	11/00 → 10/06	CHASSIS: 1A000001 →				
1.8 i 16V 4x4	Petrol	88	02/98 → 11/00	CHASSIS: 1A000001 →				
1.8 i 16V 4x4	Petrol	88	02/98 → 11/00					
2.0 DI 4x4	Diesel	72	02/98 → 11/00					
2.0 Td4 4x4	Diesel	80	03/01 → 10/06					
2.0 Td4 4x4	Diesel	82	11/00 → 10/06					
2.5 V6 4x4	Petrol	130	11/00 → 10/06					

FREELANDER 2 (FA_)

2.2 eD4	Diesel	110	08/10 →					
2.2 SD4 4x4	Diesel	140	08/10 →					
2.2 Td4 4x4	Diesel	110	10/06 →			AMM19656	B4	
2.2 Td4 4x4	Diesel	112	01/07 →			AMM19656	B4	
2.2 Td4 4x4	Diesel	115	10/06 →			AMM19656	B4	
2.2 Td4 4x4	Diesel	118	10/06 →			AMM19656	B4	

FREELANDER Soft Top

1.8 i 16V 4x4	Petrol	88	02/98 → 10/06					
1.8 i 16V 4x4	Petrol	88	02/98 → 10/06	CHASSIS: 1A000001 →				
2.0 DI 4x4	Diesel	72	02/98 → 10/06					

RANGE ROVER I (AE, AN, HAA, HAB, HAM, HBM, RE, RN)

3.5 4x4	Petrol	107	01/87 → 09/90					
3.5 Vogue 4x4	Petrol	120	10/85 → 09/90					
3.9 4x4 Cat.	Petrol	127	11/88 → 07/94					
3.9 Vogue SEI 4x4	Petrol	134	11/88 → 07/94					
4.3 Vogue LSE 4x4	Petrol	149	09/92 → 07/94					

RANGE ROVER II (LP)

2.5 TD 4x4	Diesel	100	07/94 → 03/02					
2.5 TD 4x4	Diesel	100	07/94 → 03/02	ENGINE: 31428933 →				
3.9 4x4	Petrol	140	07/94 → 03/02					
4.0 4x4	Petrol	136	06/98 → 03/02					
4.6 4x4	Petrol	160	06/98 → 03/02					
4.6 4x4	Petrol	165	07/94 → 03/02					

RANGE ROVER III (LM)

3.0 TD 6 4x4	Diesel	130	03/02 → 08/12					
3.6 TD 8 4x4	Diesel	200	04/06 → 08/12					
4.4 4x4	Petrol	210	03/02 → 08/12					
4.4 4x4	Petrol	225	05/05 → 08/12					

RANGE ROVER SPORT (LS)

3.6 TD 8 4x4	Diesel	200	04/06 →					
--------------	--------	-----	---------	--	--	--	--	--



TYPE

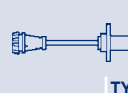

TYPE



TYPE

	APS64		SPA104	F1						
								BAE680AG	GA2070	J2
	APS69					SAG091	H1			
			SGA113	F3						
			SGA113	F3						
						SAG091	H1			
						SAG081	H1			
	APS30		ATS15	F2					PI025	J1
	APS30		ATS15	F2					ESS0020A	J1
						SAG144	H1			
						SAG109	H1			
						SAG109	H1			
						SAG109	H1			
						SAG109	H1			
						SAG109	H1			
	APS69					SAG091	H1			
			SGA113	F3						
						SAG081	H1			
									ESS0039A	J1
									ESS0039A	J1
									ESS0039A	J1
									ESS0039A	J1
									ESS0039A	J1
	APS42		SPA164	F1						
			ATS15	F2						
								BAE680AG	GA2096	J2
								BAE680AG	GA2096	J2
								BAE680AG	GA2096	J2
								BAE680AG	GA2096	J2
	APS57								PI025	J1
						SAC092	H2			
									ESS0076A	J1
									ESS0081A	J1
						SAC092	H2			

KW

TYPE

TYPE
LEXUS
ES (F1, F2)

250	Petrol	118	12/89 → 09/91						
300	Petrol	138	09/91 → 12/97						

GS (JZS147)

300	Petrol	156	03/93 → 08/97						
-----	--------	-----	---------------	--	--	--	--	--	--

GS (UZS161, JZS160)

300	Petrol	161	10/00 → 03/05						
430	Petrol	208	11/00 → 03/05						
300 T3	Petrol	163	08/97 → 10/00						

IS I (JCE1_, GXE1_)

200	Petrol	114	04/99 → 07/05						
300	Petrol	157	09/01 → 07/05						

LS (UCF10)

400	Petrol	180	12/89 → 12/94						
-----	--------	-----	---------------	--	--	--	--	--	--

LS (UCF20)

400	Petrol	194	12/94 → 08/97						
400	Petrol	203	09/98 → 10/00						
400	Petrol	209	09/97 → 10/00						

LS (UCF30)

430	Petrol	207	10/00 → 08/06						
-----	--------	-----	---------------	--	--	--	--	--	--

RX (MCU15)

300 AWD	Petrol	148	10/00 → 05/03						
---------	--------	-----	---------------	--	--	--	--	--	--

RX (MHU3_, GSU3_, MCU3_)

400h AWD	Petrol	155	09/04 → 12/08						
----------	--------	-----	---------------	--	--	--	--	--	--

SC (UZZ40_)

430	Petrol	210	05/01 → 07/10						
-----	--------	-----	---------------	--	--	--	--	--	--

MARUTI
800

0.8	Petrol	26	01/91 → 12/06						
-----	--------	----	---------------	--	--	--	--	--	--

MASERATI
228

2.8 i	Petrol	184	01/88 → 12/90						
2.8 i	Petrol	184	01/88 → 12/90						
2.8 i	Petrol	184	01/88 → 12/90						

3200 GT

3.2 Biturbo V8 32V	Petrol	271	10/98 → 03/02						
3.2 Biturbo V8 32V	Petrol	271	10/98 → 03/02						

420/430 (69, 78, AF3)

420 i	Petrol	138	01/87 → 12/88						
420 i	Petrol	138	01/87 → 12/88						
420 i	Petrol	138	01/87 → 12/88						

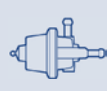

TYPE



TYPE



TYPE

					SAA111				
			SPA168	F1	SAA111				
			SPA168	F1		SAC055	H2		
						SAC055	H2		
						SAC055	H2		
						SAC055	H2		
						SAC055	H2		
			SPA168	F1	SAA111	SAC055	H2		
			SPA168	F1		SAC055	H2		
						SAC055	H2		
						SAC055	H2		
						SAC055	H2		
						SAC066	H2		
			SPA127	F1					
						SAC055	H2		
						SAA106			
			ATS04-1	F2		SEN8D	H1		
			SZA103	F1					
			WTS05-1	F1					
			KITRPM40						
			RPM40						
			ATS04-1	F2		SEN8D	H1		
			SZA103	F1					
			WTS05-1	F1					



KW



TYPE



TYPE

MASERATI

BITURBO (70, 77)

2.24V	Petrol	180	03/89 → 12/94						
2.24V	Petrol	180	03/89 → 12/92						
2.24V	Petrol	180	03/89 → 12/92						
4.24V	Petrol	180	04/90 → 12/94						
4.24V	Petrol	180	04/90 → 12/92						
4.24V	Petrol	180	04/90 → 12/92						
425 i	Petrol	138	09/87 → 12/88						

BITURBO Coupé

2.0	Petrol	136	01/86 → 04/87						
2.0	Petrol	136	01/86 → 04/87						
2.0	Petrol	136	01/86 → 04/87						
Si 2.0	Petrol	151	09/87 → 12/88						
Si 2.0	Petrol	151	09/87 → 12/88						
Si 2.0	Petrol	151	09/87 → 12/88						

BITURBO Spider

2.0	Petrol	136	01/86 → 04/87						
2.0	Petrol	136	01/86 → 04/87						
2.0	Petrol	136	01/86 → 04/87						

GHIBLI II

2.0 24V Biturbo	Petrol	225	01/93 →						
2.0 24V Biturbo	Petrol	225	01/93 →						
2.0 24V Biturbo	Petrol	225	01/93 →						
2.0 24V Biturbo	Petrol	225	03/94 →	ENGINE: DOHC					

QUATTROPORTE IV

2.0 Biturbo	Petrol	211	01/97 →						
2.0 Biturbo	Petrol	211	01/97 →						
2.0 Biturbo	Petrol	211	01/97 →						
2.0 Biturbo	Petrol	211	03/94 →						
2.8 Biturbo	Petrol	209	01/97 →						
2.8 Biturbo	Petrol	209	01/97 →						
2.8 Biturbo	Petrol	209	01/97 →						
2.8 Biturbo	Petrol	209	03/94 →						

SHAMAL

3.2	Petrol	240	12/89 → 11/95						
3.2	Petrol	240	12/89 → 11/95						
3.2	Petrol	240	12/89 → 11/95						

MAZDA

121 I (DA)

1.1	Petrol	42	10/87 → 10/90						
1.3	Petrol	44	10/87 → 11/90						

121 II (DB)

1.3 16V	Petrol	39	11/90 → 03/96						
1.3 i 16V	Petrol	53	11/90 → 03/96						



KW



TYPE



TYPE

MAZDA

121 III (JASM, JBSM)

1.25	Petrol	55	03/96 → 04/03					
1.25	Petrol	55	03/96 → 04/03	ENGINE: DHF,DHG				
1.3	Petrol	37	03/96 → 04/03					
1.3	Petrol	44	03/96 → 04/03					
1.3	Petrol	37	03/96 → 04/03	ENGINE: JJK,JJM				
1.3	Petrol	44	03/96 → 04/03	ENGINE: J4R,J4T				
1.8 D	Diesel	44	03/96 → 04/03					

2 (DE)

1.4 MZR-CD	Diesel	50	01/08 →					
------------	--------	----	---------	--	--	--	--	--

2 (DY)

1.2	Petrol	55	02/05 →					
1.25	Petrol	55	04/03 →					
1.25	Petrol	55	02/05 →					
1.4	Petrol	59	04/03 →					
1.4	Petrol	59	02/05 →					
1.4	Petrol	59	02/05 →					
1.4 CD	Diesel	50	04/03 →	ENGINE: F6JA,F6JB		AMM19770	B4	
1.4 CD	Diesel	50	04/03 →					
1.6	Petrol	74	04/03 →					
1.6	Petrol	74	02/05 →					
1.6	Petrol	74	02/05 →					

3 (BK)

1.4	Petrol	59	02/04 → 06/09					
1.4	Petrol	62	10/03 → 06/09					
1.6	Petrol	77	10/03 → 06/09					
1.6 DI Turbo	Diesel	80	06/04 → 06/09					
1.6 DI Turbo	Diesel	80	06/04 → 06/09					
2.0	Petrol	104	04/04 → 03/06					
2.0	Petrol	110	10/03 → 03/06					
2.0	Petrol	110	10/03 → 06/09					
2.0	Petrol	110	10/03 → 06/09					
2.0 MZR-CD	Diesel	105	12/06 → 06/09					
2.0 MZR-CD	Diesel	105	12/06 → 06/09					
2.3 MPS	Petrol	191	12/06 → 06/09					

3 (BL)

1.6 MZR CD	Diesel	80	06/09 →					
------------	--------	----	---------	--	--	--	--	--

3 Tre volumi (BK)

1.6	Petrol	77	02/04 →					
1.6 DI Turbo	Diesel	80	06/04 →					
1.6 DI Turbo	Diesel	80	06/04 →					
2.0	Petrol	104	04/04 → 03/06					
2.0	Petrol	110	02/04 → 03/06					
2.0	Petrol	110	02/04 →					
2.0 MZR-CD	Diesel	105	12/06 →					

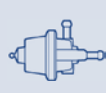

TYPE

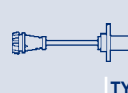

TYPE



TYPE

				SPA170	F1	SAA112			BAE680BZ	
							SAC097	H2		
						SAA112			BAE680AE	
						SAA112			BAE680BZ	
							SAC097	H2		
							SAC097	H2		
				SPA170	F1	SAA112				
							SAG168	H1		
									BAE680DX	
		APS13					SAD037	H3	BAE680BZ	
									BAE680DX	
		APS13					SAD037	H3	BAE680BZ	
									BAE680DX	
									BAE680DX	
				SPA172	F1	SAA118	SAG168	H1		
		APS13					SAD037	H3	BAE680BZ	
									BAE680DX	
									BAE680DX	
				SPA168	F1					
				SPA168	F1		SAC044	H2		
				SPA168	F1		SAC044	H2		
				SPA172	F1	SAA118	SAC096	H2		
							SAG168	H1		
FEI0011										
FEI0011										
				SPA116	F1	SAA115	SAC044	H2		
							SAD036	H3		
						SAA115	SAC044	H2		
							SAD036	H3		
						SAA115	SAC044	H2		
							SAG168	H1		
				SPA168	F1					
				SPA172	F1	SAA118	SAC096	H2		
							SAG168	H1		
FEI0011										
FEI0011										
				SPA116	F1	SAA115	SAD036	H3		
						SAA115	SAC044	H2		



KW



TYPE



TYPE

MAZDA

3 Tre volumi (BK)

2.0 MZR-CD Diesel 105 12/06 →

323 F V (BA)

1.5 16V Petrol 65 07/94 → 09/96

1.8 16V Petrol 84 08/94 → 09/98

2.0 24V Petrol 106 08/94 → 09/98

323 F VI (BJ)

1.4 16V Petrol 54 09/98 → 01/01 ENGINE: → 229827

2.0 Petrol 96 01/01 → 05/04

2.0 D Diesel 52 09/98 → 05/04 CHASSIS: 229828 →

2.0 TD Diesel 66 09/98 → 01/01 CHASSIS: 229828 →

2.0 TD Diesel 74 01/01 → 05/04

323 III (BF)

1.3 Petrol 44 08/85 → 05/89

1.5 Petrol 54 09/87 → 10/89

1.5 Petrol 55 08/85 → 05/89

1.6 GT Petrol 63 11/86 → 10/89

1.6 GT Turbo Petrol 103 10/85 → 11/91

323 III Hatchback (BF)

1.1 Petrol 40 09/85 → 10/89

1.3 Petrol 44 09/85 → 12/87

1.5 Petrol 55 08/85 → 05/89

1.6 GT Turbo (BF1) Petrol 103 10/85 → 08/93

1.6 GT Turbo 4WD (BF2) Petrol 110 08/87 → 10/89

323 III Station Wagon (BW)

1.5 Petrol 54 01/87 → 05/89

1.5 Petrol 55 05/86 → 05/89

1.6 Petrol 63 09/86 → 10/95

1.7 D Diesel 40 11/86 → 08/87

1.7 D Diesel 42 11/86 → 10/89

323 S V (BA)

1.3 16V Petrol 54 08/94 → 09/98

1.5 16V Petrol 65 08/94 → 09/98

1.8 16V Petrol 84 08/94 → 09/98

323 S VI (BJ)

1.4 16V Petrol 54 09/98 → 01/01 ENGINE: → 229827

1.4 16V Petrol 54 09/98 → 01/01

1.5 16V Petrol 65 09/98 → 01/01

1.9 16V Petrol 84 09/98 → 05/04

2.0 Petrol 96 01/01 → 08/03

2.0 D Diesel 52 09/98 → 05/04 CHASSIS: 229828 →

2.0 D Diesel 52 09/98 → 05/04

2.0 TD Diesel 66 09/98 → 05/04 CHASSIS: 229828 →

2.0 TD Diesel 66 09/98 → 05/04

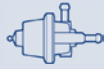

TYPE



TYPE



TYPE

SAD036

H3

SPA168 F1

SPA168 F1

SPA168 F1

SPA168 F1

FEI0014

SPA168 F1

SPA168 F1

SPA168 F1

SAA110

SAA110

SAA110

SAA110

SAA110

SAA110

SAA110

SAA110

SAA110

SAA110

SAA110

SAA110

SAA110

SAA110

SAA110

SPA168 F1

SPA168 F1

SPA168 F1

SPA168 F1

SAG088

H1

SAG088

H1

SAG088

H1

FEI0014

SPA168 F1

SAG088

H1

SPA168 F1

SAG088

H1

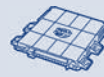
KW

TYPE

TYPE
MAZDA
5 (CR19)

1.8	Petrol	85	03/05 → 03/05
1.8	Petrol	85	03/05 →
2.0	Petrol	107	03/05 → 09/07
2.0	Petrol	107	03/05 →
2.0 CD	Diesel	105	06/05 →
2.0 CD	Diesel	81	03/05 →

6 (GG)

1.8	Petrol	88	08/02 → 03/05
1.8	Petrol	88	08/02 → 08/07
2.0	Petrol	104	06/02 → 03/05
2.0	Petrol	108	03/05 → 03/05
2.0	Petrol	104	06/02 → 08/07
2.0	Petrol	108	03/05 → 08/07
2.0 DI	Diesel	100	06/02 → 08/07
2.0 DI	Diesel	105	06/05 → 08/07
2.0 DI	Diesel	89	08/02 → 08/07
2.3	Petrol	120	03/05 → 03/05
2.3	Petrol	122	06/02 → 08/04
2.3	Petrol	122	06/02 → 08/07
2.3 MPS Turbo	Petrol	191	12/05 → 08/07

6 (GH)

1.8 MZR	Petrol	88	08/07 →
2.0 MZR	Petrol	108	08/07 →
2.5 MZR	Petrol	125	08/07 →

6 2 volumi /Coda spiovente (GH)

1.8 MZR	Petrol	88	08/07 →
2.0 MZR	Petrol	108	08/07 →
2.5 MZR	Petrol	125	08/07 →

6 Hatchback (GG)

1.8	Petrol	88	08/02 → 03/05
1.8	Petrol	88	08/02 → 08/07
2.0	Petrol	104	08/02 → 03/05
2.0	Petrol	108	03/05 → 03/05
2.0	Petrol	104	08/02 → 08/07
2.0	Petrol	108	03/05 → 08/07
2.0 DI	Diesel	100	08/02 → 08/07
2.0 DI	Diesel	105	06/05 → 08/07
2.0 DI	Diesel	89	08/02 → 08/07
2.3	Petrol	122	08/02 → 08/04
2.3	Petrol	122	08/02 → 08/07

6 Station wagon (GH)

2.0 MZR	Petrol	108	02/08 →
---------	--------	-----	---------



TYPE



TYPE



TYPE

FEI0014										
			SPA116	F1	SAA115	SAD036	H3			
FEI0011										
			SPA116	F1	SAA115	SAD036	H3			
			SPA168	F1						
			SPA168	F1						
FEI0014										
			SPA116	F1	SAA115	SAD036	H3			
FEI0011										
FEI0011										
			SPA116	F1	SAA115	SAD036	H3			
			SPA116	F1	SAA115	SAD036	H3			
			SPA168	F1		SAG092	H1			
			SPA168	F1						
			SPA168	F1		SAG092	H1			
FEI0009										
FEI0009										
			SPA116	F1	SAA115	SAD036	H3			
			SPA116	F1	SAA115	SAD036	H3			
					SAA115	SAD036	H3			
					SAA115	SAD036	H3			
					SAA115	SAD036	H3			
					SAA115	SAD036	H3			
					SAA115	SAD036	H3			
					SAA115	SAD036	H3			
					SAA115	SAD036	H3			
FEI0014										
			SPA116	F1	SAA115	SAD036	H3			
FEI0011										
FEI0011										
			SPA116	F1	SAA115	SAD036	H3			
			SPA116	F1	SAA115					
			SPA168	F1		SAG092	H1			
			SPA168	F1						
			SPA168	F1		SAG092	H1			
FEI0009										
			SPA116	F1	SAA115	SAD036	H3			
					SAA115	SAD036	H3			



KW



TYPE



TYPE

MAZDA

6 Station Wagon (GY)

1.8	Petrol	88	08/02 → 03/05
1.8	Petrol	88	08/02 → 08/07
2.0	Petrol	104	08/02 → 03/05
2.0	Petrol	108	03/05 → 03/05
2.0	Petrol	104	08/02 → 08/07
2.0	Petrol	108	03/05 → 08/07
2.0 CiTD 4x4	Diesel	100	10/02 → 02/05
2.0 CiTD 4x4	Diesel	89	10/02 → 02/05
2.0 DI	Diesel	100	08/02 → 08/07
2.0 DI	Diesel	105	06/05 → 08/07
2.0 DI	Diesel	89	08/02 → 08/07
2.3	Petrol	122	08/02 → 03/05
2.3	Petrol	122	08/02 → 08/07
2.3 AWD	Petrol	119	11/02 → 03/05
2.3 AWD	Petrol	119	11/02 → 08/07

626 II (GC)

1.6	Petrol	59	11/82 → 06/87
2.0	Petrol	68	11/86 → 09/87
2.0	Petrol	74	03/83 → 09/87
2.0	Petrol	88	01/86 → 09/87
2.0 D	Diesel	46	01/83 → 06/87

626 II Hatchback (GC)

1.6	Petrol	59	03/83 → 09/87
2.0	Petrol	74	03/83 → 09/87
2.0	Petrol	88	01/86 → 09/87
2.0 D	Diesel	46	03/84 → 06/87

626 III (GD)

2.0	Petrol	66	09/87 → 10/90
2.0 16V	Petrol	109	07/87 → 09/89
2.0 D	Diesel	44	07/87 → 07/91
2.2 12V	Petrol	85	11/87 → 07/91

626 III Coupé (GD)

2.0	Petrol	66	09/87 → 10/90
2.0 16V	Petrol	103	12/87 → 10/90
2.0 16V	Petrol	109	06/87 → 09/89
2.2 12V	Petrol	85	04/88 → 12/91

626 III Hatchback (GD)

2.0	Petrol	66	09/87 → 10/90
2.0 16V	Petrol	103	11/87 → 10/90
2.0 16V	Petrol	109	06/87 → 08/89
2.0 D	Diesel	44	07/87 → 07/91
2.2 12V	Petrol	85	06/88 → 04/92

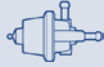

TYPE



TYPE



TYPE

FEI0014

SPA116

F1

FEI0011

FEI0011

SPA116

F1

SAA115

SAD036

H3

SPA116

F1

SAA115

SAG092

H1

SAG092

H1

SPA168

F1

SAG092

H1

SPA168

F1

SPA168

F1

SAG092

H1

FEI0009

SPA116

F1

SAA115

SAD036

H3

FEI0009

SPA116

F1

SAA115

SAD036

H3

SAA106

SAA106

SAA106

SAA106

SAA110

SAA106

SAA106

SAA106

SAA110

SAA106

SAA106

SAA110

SAA110

SAA106

SAA106

SAA106

SAA110

SAA110

SAA106

SAA106

SAA110

SAA110

SAA110



KW



TYPE



TYPE

MAZDA

626 III Station Wagon (GV)

2.0	Petrol	66	10/88 → 09/97
2.0 D	Diesel	44	09/88 → 07/91
2.0 D	Diesel	60	11/94 → 09/97
2.0 D Complex	Diesel	55	05/93 → 11/96
2.2 12V	Petrol	85	03/89 → 11/96

626 IV (GE)

1.8 i	Petrol	77	01/92 → 04/97
1.8 i	Petrol	66	08/94 → 04/97
2.0 D GLX Complex	Diesel	55	12/95 → 04/97
2.0 D GLX Complex	Diesel	55	10/92 → 04/97
2.0 i	Petrol	85	01/92 → 04/97

626 IV Hatchback (GE)

1.8	Petrol	77	08/91 → 04/97
1.8	Petrol	66	08/94 → 04/97
2.0 D GLX Complex	Diesel	55	12/95 → 04/97
2.0 D GLX Complex	Diesel	55	01/93 → 04/97
2.0 i	Petrol	85	08/91 → 04/97
2.5 24V	Petrol	120	08/94 → 04/97
2.5 24V	Petrol	121	01/92 → 04/97

626 V (GF)

1.8	Petrol	66	05/97 → 12/99
1.8	Petrol	74	12/99 → 10/02
2.0	Petrol	100	04/98 → 10/02
2.0	Petrol	85	05/97 → 10/02

626 V Hatchback (GF)

1.8	Petrol	66	05/97 → 12/99
1.8	Petrol	74	12/99 → 10/02
2.0	Petrol	85	05/97 → 10/02
2.0 H.P.	Petrol	100	02/98 → 10/02

626 V Station Wagon (GW)

1.8	Petrol	66	02/98 → 01/00
1.8	Petrol	74	01/00 → 10/02
2.0	Petrol	85	02/98 → 10/02
2.0 DITD	Diesel	66	09/99 → 10/02
2.0 H.P.	Petrol	100	02/98 → 10/02

929 III (HC)

2.2 12V	Petrol	85	01/88 → 04/89
2.2 i	Petrol	100	05/87 → 12/88
3.0	Petrol	125	01/88 → 12/89
3.0 i	Petrol	123	01/90 → 06/91

B-SERIE (UF)

2.5 D	Diesel	63	02/96 → 06/99
2.5 D 4WD	Diesel	57	09/98 → 06/99
2.5 D 4WD	Diesel	63	02/96 → 06/99

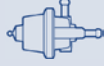

TYPE



TYPE



TYPE

SAA106

SAA110

SAA110

SAA110

SAA106

SPA168

F1

SAA111

SAA111

SPA168

F1

SAA110

SPA168

F1

SAA111

SPA168

F1

SAA111

SAA111

SPA168

F1

SAA110

SPA168

F1

SAA111

SPA168

F1

SAA111

SPA168

F1

SAA111

SPA116

F1

SAG108

H1

SPA116

F1

SAG108

H1

SPA116

F1

SAG108

H1

SPA116

F1

SAG108

H1

SPA116

F1

SAG108

H1

SPA116

F1

SAG108

H1

SPA116

F1

SAG108

H1

SPA116

F1

SAA110

SAA110

SAA110

SAA110

SPA168

F1

SPA168

F1

SPA168

F1



KW



TYPE



TYPE

MAZDA

B-SERIE (UN)

2.5 D	Diesel	57	06/99 →						
2.5 D	Diesel	62	12/02 →						
2.5 D 4WD	Diesel	57	06/99 →						
2.5 D 4WD	Diesel	62	12/02 →						
2.5 TD 4WD	Diesel	80	06/99 → 07/06						

CX-7 (ER)

2.3 MZR DISI Turbo	Petrol	190	10/07 →						
--------------------	--------	-----	---------	--	--	--	--	--	--

DEMIO (DW)

1.3 16V	Petrol	46	01/00 → 02/03						
1.5 16V	Petrol	55	04/00 → 02/03						
1.5 16V	Petrol	55	04/00 → 07/03						

E-SERIE Furgonato (SR2)

E2200 D	Diesel	52	02/97 → 08/02						
E2200 D 4WD	Diesel	52	02/97 → 05/03						

MPV II (LW)

2.0	Petrol	88	08/00 → 04/02						
2.0	Petrol	90	09/99 → 08/00						
2.0 DI	Diesel	100	07/02 → 02/06						
2.3	Petrol	104	07/02 → 06/04						
2.3	Petrol	104	07/02 → 02/06						

MX-3 (EC)

1.6 i	Petrol	79	01/94 →						
1.8 i V6	Petrol	98	01/92 → 01/94						

MX-5 I (NA)

1.8	Petrol	96	02/94 → 04/98						
-----	--------	----	---------------	--	--	--	--	--	--

MX-5 III (NC)

1.8	Petrol	93	03/05 →						
2.0	Petrol	118	03/05 →						

MX-6 (GE)

2.0	Petrol	85	02/92 → 02/97						
2.5 24V	Petrol	121	02/92 → 02/97						
2.5 i 24V	Petrol	120	08/94 → 02/97						

PREMACY (CP)

1.9	Petrol	74	07/99 → 03/05						
1.9	Petrol	84	07/99 → 03/05						
2.0	Petrol	96	11/01 → 03/05						
2.0 TD	Diesel	66	10/99 → 07/00						
2.0 TD	Diesel	74	07/00 → 03/05						

XEDOS 6 (CA)

1.6 16V	Petrol	79	06/94 → 10/99						
1.6 16V	Petrol	83	08/92 → 05/94						
2.0 V6	Petrol	103	06/94 → 10/99						
2.0 V6	Petrol	106	01/92 → 05/94						



KW



TYPE



TYPE

MAZDA

XEDOS 9 (TA)

2.0 24V	Petrol	105	08/93 → 01/00						
2.3 24V	Petrol	155	02/95 → 01/00						
2.5 24V	Petrol	123	07/93 → 07/00						

MERCEDES-BENZ

190 (W201)

2.6	Petrol	118	08/86 → 08/88						
E 1.8 (201.018)	Petrol	80	04/90 → 08/93						
E 2.0	Petrol	87	01/85 → 08/93	ENGINE: 236839 →, 122336 →					
E 2.0	Petrol	93	10/82 → 08/89						
E 2.0 (201.024)	Petrol	90	10/82 → 06/93	ENGINE: 236839 →, 122336 →					
E 2.0 (201.024)	Petrol	90	10/82 → 08/89	ENGINE: M102961					
E 2.3	Petrol	97	09/86 → 08/91	ENGINE: 033730 →, 080065 →					
E 2.3 (201.028)	Petrol	100	10/86 → 08/93	ENGINE: 033730 →, 080065 →					
E 2.3-16	Petrol	125	09/85 → 12/87						
E 2.3-16	Petrol	130	09/85 → 08/88						
E 2.3-16 (201.034)	Petrol	136	04/84 → 01/87						
E 2.5-16	Petrol	143	03/89 → 08/93						
E 2.5-16	Petrol	143	03/89 → 04/90						
E 2.5-16	Petrol	150	09/88 → 08/93						
E 2.6	Petrol	122	09/86 → 12/89						
E 2.6 (201.029)	Petrol	118	09/86 → 08/89	ENGINE: M103942					
E Evolution II 2.5	Petrol	173	05/90 → 08/93						

CABRIOLET (A124)

300 CE-24 (124.061)	Petrol	162	04/92 → 06/93						
---------------------	--------	-----	---------------	--	--	--	--	--	--

CLASSE A (W168)

A 140 (168.031, 168.131)	Petrol	60	01/01 → 08/04						
A 140 (168.031, 168.131)	Petrol	60	07/97 → 08/04						
A 140 (168.031, 168.131)	Petrol	60	01/01 → 08/04						
A 140 (168.031, 168.131)	Petrol	60	01/01 → 08/04						
A 140 (168.031, 168.131)	Petrol	60	07/97 → 08/04						
A 140 (168.031, 168.131)	Petrol	60	01/01 → 08/04						
A 140 (168.031, 168.131)	Petrol	60	07/97 → 12/97						
A 140 (168.031, 168.131)	Petrol	60	05/98 → 08/04	ENGINE: 30040047 →					
A 140 (168.031, 168.131)	Petrol	60	05/98 → 08/04	ENGINE: 30040047 →					
A 140 (168.031, 168.131)	Petrol	60	10/97 → 08/04						
A 160 (168.033, 168.133)	Petrol	75	07/97 → 08/04						
A 160 (168.033, 168.133)	Petrol	75	07/97 → 08/04						
A 160 (168.033, 168.133)	Petrol	75	07/97 → 08/04	ENGINE: 30040047 →					
A 160 (168.033, 168.133)	Petrol	75	07/97 → 08/04	ENGINE: 30040047 →					
A 160 (168.033, 168.133)	Petrol	75	07/97 → 12/97						
A 160 (168.033, 168.133)	Petrol	75	10/97 → 08/04						
A 160 CDI (168.006)	Diesel	55	02/01 → 08/04						
A 160 CDI (168.006)	Diesel	55	02/01 → 08/04						

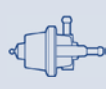

TYPE

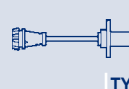

TYPE



TYPE

				SPA168	F1	SAA111				
				SPA168	F1	SAA111				
				SPA168	F1	SAA111				
									ESS528	J1
				SPA136	F1					
				SPA136	F1					
									ESS528	J1
				SPA136	F1					
									ESS528	J1
				SPA136	F1					
				SPA136	F1					
									ESS528	J1
									ESS528	J1
									ESS528	J1
				SPA136	F1					
									ESS528	J1
									ESS528	J1
									ESS528	J1
									ESS528	J1
				SPA136	F1				ESS528	J1
				SPA136	F1	SAC043	H2		ESS528	J1
	APS33		ATS21	F2		SAC012	H2	BAE680CW		
	APS33		ATS21	F2		SAC012	H2		GA2205	J2
			SPA163	F1		SAD033	H3			
						SAG023	H1			
			SPA163	F1		SAD033	H3			
						SAG023-1	H1			
						SAG146	H1			
						SAG023	H1			
						SAG023-1	H1			
								BAE680CW		
	APS33		ATS21	F2		SAC012	H2		GA2205	J2
			SPA163	F1		SAD033	H3			
						SAG023	H1			
						SAG023-1	H1			
						SAG146	H1			
								BAE680CW		
			ATS21	F2		SAC012	H2		SUA509	J3
			SPA163	F1		SAG023	H1			



KW



TYPE



TYPE

MERCEDES-BENZ

CLASSE A (W168)

A 160 CDI (168.006)	Diesel	55	02/01 → 08/04						
A 160 CDI (168.007)	Diesel	44	07/98 → 02/01						
A 160 CDI (168.007)	Diesel	44	07/98 → 02/01						
A 160 CDI (168.007)	Diesel	44	07/98 → 02/01						
A 160 CDI (168.007)	Diesel	44	01/01 → 02/01						
A 170 CDI (168.008)	Diesel	66	07/98 → 02/01						
A 170 CDI (168.008)	Diesel	66	07/98 → 02/01						
A 170 CDI (168.008)	Diesel	66	07/98 → 02/01						
A 170 CDI (168.008)	Diesel	66	01/01 → 02/01						
A 170 CDI (168.009, 168.109)	Diesel	70	02/01 → 08/04						
A 170 CDI (168.009, 168.109)	Diesel	70	02/01 → 08/04						
A 170 CDI (168.009, 168.109)	Diesel	70	02/01 → 08/04						
A 190 (168.032, 168.132)	Petrol	92	03/99 → 08/04						
A 190 (168.032, 168.132)	Petrol	92	03/99 → 08/04						
A 190 (168.032, 168.132)	Petrol	92	03/99 → 08/04						
A 190 (168.032, 168.132)	Petrol	92	03/99 → 08/04						
A 210 (168.035, 168.135)	Petrol	103	03/02 → 08/04						
A 210 (168.035, 168.135)	Petrol	103	03/02 → 08/04						
A 210 (168.035, 168.135)	Petrol	103	03/02 → 08/04	ENGINE: 30045255 →					
A 210 (168.035, 168.135)	Petrol	103	03/02 → 08/04	ENGINE: 30045255 →					

CLASSE A (W169)

A 150 (169.031, 169.331)	Petrol	70	09/04 → 06/12						
A 150 (169.031, 169.331)	Petrol	70	09/04 → 06/12						
A 150 (169.031, 169.331)	Petrol	70	09/04 → 06/12						
A 150 (169.031, 169.331)	Petrol	70	09/04 → 04/09						
A 160 (169.031, 169.331)	Petrol	70	04/09 → 06/12						
A 160 (169.031, 169.331)	Petrol	70	04/09 → 06/12						
A 160 (169.031, 169.331)	Petrol	70	04/09 → 06/12						
A 160 (169.031, 169.331)	Petrol	70	04/09 → 10/11						
A 160 CDI (169.006, 169.306)	Diesel	60	09/04 → 06/12						
A 160 CDI (169.006, 169.306)	Diesel	60	09/04 → 06/12						
A 160 CDI (169.006, 169.306)	Diesel	60	09/04 → 08/05	ENGINE: → 30134434					
A 170 (169.032, 169.332)	Petrol	85	09/04 → 06/12						
A 170 (169.032, 169.332)	Petrol	85	09/04 → 06/12						
A 170 (169.032, 169.332)	Petrol	85	09/04 → 06/12						
A 170 (169.032, 169.332)	Petrol	85	09/04 → 04/09						
A 180 (169.032, 169.332)	Petrol	85	04/09 → 06/12						
A 180 (169.032, 169.332)	Petrol	85	04/09 → 06/12						
A 180 (169.032, 169.332)	Petrol	85	04/09 → 06/12						
A 180 (169.032, 169.332)	Petrol	85	04/09 → 10/11						
A 180 CDI (169.007, 169.307)	Diesel	80	09/04 → 06/12						
A 180 CDI (169.007, 169.307)	Diesel	80	09/04 → 06/12						
A 180 CDI (169.007, 169.307)	Diesel	80	09/04 → 08/05	ENGINE: → 30134434					
A 200 (169.033, 169.333)	Petrol	100	09/04 → 06/12						

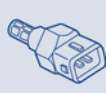
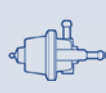

TYPE

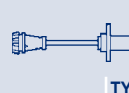

TYPE



TYPE

						SAG023-1	H1			
				ATS21	F2	SAC012	H2			
				SPA163	F1	SAG023	H1			
						SAG023-1	H1			
									SUA509	J3
				ATS21	F2	SAC012	H2			
				SPA163	F1	SAG023	H1			
						SAG023-1	H1			
									SUA509	J3
				ATS21	F2	SAC012	H2		SUA509	J3
				SPA163	F1	SAG023	H1			
						SAG023-1	H1			
		APS33		ATS21	F2	SAC012	H2	BAE680CW	GA2205	J2
				SPA163	F1	SAD033	H3			
						SAG023	H1			
						SAG023-1	H1			
		APS33		ATS21	F2	SAC012	H2	BAE680CW		
				SPA163	F1	SAD033	H3			
						SAG023	H1			
						SAG023-1	H1			
						SAC012	H2		SUA478	J2
						SAG023	H1			
						SAG023-1	H1			
								BAE680CX		
						SAC012	H2			
						SAG023	H1			
						SAG023-1	H1			
								BAE680CX		
				ATS21	F2	SAG023	H1		GA2212	J2
						SAG023-1	H1			
						SAC012	H2			
						SAC012	H2		SUA478	J2
						SAG023	H1			
						SAG023-1	H1			
								BAE680CX		
						SAC012	H2			
						SAG023	H1			
						SAG023-1	H1			
								BAE680CX		
				ATS21	F2	SAG023	H1		GA2212	J2
						SAG023-1	H1			
						SAC012	H2			
						SAC012	H2		SUA478	J2



KW

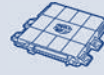

TYPE



TYPE

MERCEDES-BENZ

CLASSE A (W169)

A 200 (169.033, 169.333)	Petrol	100	09/04 → 06/12						
A 200 (169.033, 169.333)	Petrol	100	09/04 → 06/12						
A 200 (169.033, 169.333)	Petrol	100	09/04 → 10/11						
A 200 CDI (169.008, 169.308)	Diesel	103	09/04 → 06/12						
A 200 CDI (169.008, 169.308)	Diesel	103	09/04 → 06/12						
A 200 CDI (169.008, 169.308)	Diesel	103	09/04 → 08/05	ENGINE: → 30134434					
A 200 CDI (169.308)	Diesel	100	09/04 → 06/12						
A200TURBO (169.034, 169.334)	Petrol	142	09/05 → 06/12						
A200TURBO (169.034, 169.334)	Petrol	142	09/05 → 06/12						
A200TURBO (169.034, 169.334)	Petrol	142	09/05 → 06/12						
A200TURBO (169.034, 169.334)	Petrol	142	09/05 → 10/10						

CLASSE B (W245)

B 150 (245.231)	Petrol	70	03/05 → 11/11						
B 150 (245.231)	Petrol	70	03/05 → 11/11						
B 150 (245.231)	Petrol	70	03/05 → 11/11						
B 150 (245.231)	Petrol	70	04/05 → 04/09						
B 160 (245.231)	Petrol	70	04/09 → 11/11						
B 160 (245.231)	Petrol	70	04/09 → 11/11						
B 160 (245.231)	Petrol	70	04/09 → 11/11						
B 160 (245.231)	Petrol	70	04/09 → 04/11						
B 170 (245.232)	Petrol	85	03/05 → 11/11						
B 170 (245.232)	Petrol	85	03/05 → 11/11						
B 170 (245.232)	Petrol	85	03/05 → 11/11						
B 170 (245.232)	Petrol	85	04/05 → 04/09						
B 170 NGT (245.233)	BiFuel	85	04/08 → 11/11						
B 170 NGT (245.233)	BiFuel	85	04/08 → 11/11						
B 170 NGT (245.233)	BiFuel	85	04/08 → 11/11						
B 170 NGT (245.233)	BiFuel	85	05/08 → 04/09						
B 180 (245.232)	Petrol	85	04/09 → 11/11						
B 180 (245.232)	Petrol	85	04/09 → 11/11						
B 180 (245.232)	Petrol	85	04/09 → 11/11						
B 180 (245.232)	Petrol	85	04/09 → 04/11						
B 180 CDI (245.207)	Diesel	80	03/05 → 11/11						
B 180 CDI (245.207)	Diesel	80	03/05 → 11/11						
B 180 CDI (245.207)	Diesel	80	03/05 → 08/05	ENGINE: → 30134434					
B 180 NGT (245.233)	BiFuel	85	04/08 → 11/11						
B 180 NGT (245.233)	BiFuel	85	04/08 → 11/11						
B 180 NGT (245.233)	BiFuel	85	04/08 → 11/11						
B 180 NGT (245.233)	BiFuel	85	05/09 → 04/11						
B 200 (245.233)	Petrol	100	03/05 → 11/11						
B 200 (245.233)	Petrol	100	03/05 → 11/11						
B 200 (245.233)	Petrol	100	03/05 → 11/11						
B 200 (245.233)	Petrol	100	04/05 → 04/11						
B 200 CDI	Diesel	100	03/05 → 11/11						

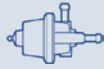

TYPE



TYPE



TYPE

							SAG023	H1		
							SAG023-1	H1		
									BAE680CX	
			ATS21	F2			SAG023	H1	GA2212	J2
							SAG023-1	H1		
							SAC012	H2		
							SAC012	H2		
							SAC012	H2		
							SAG023	H1		
							SAG023-1	H1		
									BAE680CX	
							SAC012	H2		
							SAG023	H1		
							SAG023-1	H1		
									BAE680CX	
							SAC012	H2		
							SAG023	H1		
							SAG023-1	H1		
									BAE680CX	
							SAC012	H2		
							SAG023	H1		
							SAG023-1	H1		
									BAE680CX	
							SAC012	H2		
							SAG023	H1		
							SAG023-1	H1		
									BAE680CX	
							SAG023	H1	GA2212	J2
							SAG023-1	H1		
							SAC012	H2		
							SAC012	H2		
							SAG023	H1		
							SAG023-1	H1		
									BAE680CX	
							SAC012	H2		
							SAG023	H1		
							SAG023-1	H1		
									BAE680CX	
							SAC012	H2		



KW



TYPE



TYPE

MERCEDES-BENZ

CLASSE B (W245)

B 200 CDI (245.208)	Diesel	103	03/05 → 11/11						
B 200 CDI (245.208)	Diesel	103	03/05 → 11/11						
B 200 CDI (245.208)	Diesel	103	03/05 → 08/05	ENGINE: → 30134434					
B 200 TURBO (245.234)	Petrol	142	03/05 → 11/11						
B 200 TURBO (245.234)	Petrol	142	03/05 → 11/11						
B 200 TURBO (245.234)	Petrol	142	03/05 → 11/11						
B 200 TURBO (245.234)	Petrol	142	04/05 → 10/10						

CLASSE C (W202)

C 180 (202.018)	Petrol	89	09/95 → 04/00						
C 180 (202.018)	Petrol	90	03/93 → 04/00						
C 180 (202.018)	Petrol	90	03/93 → 05/00						
C 180 (202.018)	Petrol	89	11/94 → 05/00						
C 180 (202.018)	Petrol	89	11/94 → 05/00						
C 180 (202.018)	Petrol	89	11/94 → 05/00	ENGINE: → 106153, 060038					
C 180 (202.018)	Petrol	90	03/93 → 05/00	ENGINE: → 106153, 060038					
C 180 (202.018)	Petrol	90	09/95 → 05/00						
C 200 (202.020)	Petrol	100	01/94 → 04/00						
C 200 (202.020)	Petrol	100	01/94 → 05/00						
C 200 (202.020)	Petrol	100	01/94 → 05/00						
C 200 (202.020)	Petrol	100	01/94 → 05/00						
C 200 (202.020)	Petrol	100	01/94 → 05/00						
C 200 CDI (202.134)	Diesel	75	03/98 → 05/00						
C 200 CDI (202.134)	Diesel	75	03/98 → 05/00						
C 200 D (202.120)	Diesel	55	03/93 → 05/00						
C 200 Kompressor (202.025)	Petrol	132	10/95 → 05/00						
C 200 Kompressor (202.025)	Petrol	132	10/95 → 05/00						
C 200 Kompressor (202.025)	Petrol	132	10/95 → 05/00						
C 200 Kompressor (202.025)	Petrol	132	10/95 → 05/00						
C 220 (202.022)	Petrol	110	03/93 → 09/96						
C 220 (202.022)	Petrol	110	03/93 → 05/00						
C 220 (202.022)	Petrol	110	03/93 → 05/00						
C 220 CDI (202.133)	Diesel	92	09/97 → 05/00						
C 220 CDI (202.133)	Diesel	92	09/97 → 05/00						
C 220 D	Diesel	55	07/96 → 05/00						
C 220 D	Diesel	55	07/96 → 05/00	ENGINE: 086384 →, 018031 →					
C 220 D (202.121)	Diesel	70	08/93 → 05/00						
C 220 D (202.121)	Diesel	70	08/93 → 05/00	ENGINE: 086384 →, 018031 →					
C 230 Kompressor (202.024)	Petrol	142	10/95 → 05/00						
C 230 Kompressor (202.024)	Petrol	142	10/95 → 05/00						
C 230 Kompressor (202.024)	Petrol	142	10/95 → 05/00						
C 230 Kompressor (202.024)	Petrol	142	10/95 → 05/00						
C 240 (202.026)	Petrol	125	06/97 → 05/00						
C 240 (202.026)	Petrol	125	06/97 → 05/00						
C 240 (202.026)	Petrol	125	06/97 → 05/00						



TYPE



TYPE



TYPE

								SAG023	H1		GA2212	J2
								SAG023-1	H1			
								SAC012	H2			
								SAC012	H2			
								SAG023	H1			
								SAG023-1	H1			
										BAE680CX		
			RP01A									
			RP01A									
				ATS21	F2			SAD033	H3		PI026	J1
								SAC016	H2		PI026	J1
								SAD033	H3			
								SAG146	H1			
								SAG146	H1			
								SAC016	H2			
			RP01A									
				ATS21	F2			SAC016	H2		PI026	J1
								SAD033	H3			
								SAG023	H1			
								SAG023-1	H1			
				ATS21	F2			SAC012	H2			
				SPA163	F1			SAG146	H1			
				SPA136	F1							
				ATS21	F2			SAC016	H2		PI026	J1
								SAD033	H3			
								SAG023	H1			
								SAG023-1	H1			
			RP01A									
				ATS21	F2			SAC043	H2		PI026	J1
								SAD033	H3			
				ATS21	F2			SAC012	H2			
				SPA163	F1			SAG146	H1			
				ATS21	F2							
								SAG146	H1			
				ATS21	F2							
								SAG146	H1			
				ATS21	F2			SAC016	H2		PI026	J1
								SAD033	H3			
								SAG023	H1			
								SAG023-1	H1			
				SPA163	F1			SAD018	H3			
								SAG024	H1			
								SAG024-1	H1			



KW

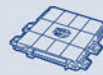

TYPE



TYPE

MERCEDES-BENZ

CLASSE C (W202)

C 240 (202.026)	Petrol	125	06/97 → 04/00						
C 250 D (202.125)	Diesel	83	05/93 → 05/00						
C 250 Turbo-D (202.128)	Diesel	110	10/95 → 05/00						
C 250 Turbo-D (202.128)	Diesel	110	10/95 → 05/00	ENGINE: 015000 →, 007448 →					
C 280 (202.028)	Petrol	142	05/93 → 05/97						
C 280 (202.028)	Petrol	142	05/93 → 05/00						
C 280 (202.028)	Petrol	142	05/93 → 05/00						
C 280 (202.028)	Petrol	142	05/93 → 05/00						
C 280 (202.028)	Petrol	142	05/93 → 05/00						
C 280 (202.028)	Petrol	142	05/93 → 05/97						
C 280 (202.029)	Petrol	145	06/97 → 05/00						
C 280 (202.029)	Petrol	145	06/97 → 05/00						
C 280 (202.029)	Petrol	145	06/97 → 05/00						
C 280 (202.029)	Petrol	145	06/97 → 04/00						
C 36 AMG (202.028)	Petrol	206	05/94 → 04/97						
C 36 AMG (202.028)	Petrol	206	05/94 → 05/00						
C 36 AMG (202.028)	Petrol	206	05/94 → 05/00						
C 36 AMG (202.028)	Petrol	206	05/94 → 05/00						
C 36 AMG (202.028)	Petrol	206	05/94 → 05/00						
C 36 AMG (202.028)	Petrol	206	05/94 → 05/97						
C 43 AMG (202.033)	Petrol	225	08/97 → 05/00						
C 43 AMG (202.033)	Petrol	225	08/97 → 05/00	ENGINE: 60002421 →					
C 43 AMG (202.033)	Petrol	225	08/97 → 05/00	ENGINE: 60002421 →					

CLASSE C (W203)

C 180 (203.035)	Petrol	95	10/00 → 05/02						
C 180 (203.035)	Petrol	95	10/00 → 05/02						
C 180 Kompressor (203.046)	Petrol	105	05/02 → 02/07						
C 180 Kompressor (203.046)	Petrol	105	05/02 → 02/07						
C 180 Kompressor (203.046)	Petrol	105	05/02 → 02/07						
C 200 CDI	Diesel	75	02/01 → 02/07						
C 200 CDI	Diesel	75	02/01 → 02/07						
C 200 CDI	Diesel	75	02/01 → 11/05	ENGINE: → 30497543					
C 200 CDI (203.004)	Diesel	85	09/00 → 02/07						
C 200 CDI (203.004)	Diesel	85	09/00 → 02/07						
C 200 CDI (203.004)	Diesel	85	09/00 → 02/07						
C 200 CDI (203.007)	Diesel	90	04/03 → 02/07						
C 200 CDI (203.007)	Diesel	90	04/03 → 02/07						
C 200 CDI (203.007)	Diesel	90	04/03 → 11/05	ENGINE: → 30497543					
C 200 CGI Kompressor (203.043)	Petrol	125	07/03 → 02/07						
C 200 CGI Kompressor (203.043)	Petrol	125	07/03 → 02/07						
C 200 CGI Kompressor (203.043)	Petrol	125	07/03 → 07/04						
C 200 CGI Kompressor (203.043)	Petrol	125	09/06 → 02/07						
C 200 Kompressor (203.042)	Petrol	120	05/02 → 02/07						
C 200 Kompressor (203.042)	Petrol	120	05/02 → 02/07						



TYPE

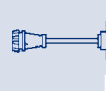

TYPE



TYPE

							BAE680CX			
				ATS21	F2					
				ATS21	F2					
							SAG146	H1		
			RP01A							
							SAC016	H2	PI026	J1
							SAD033	H3		
							SAG023	H1		
							SAG023-1	H1		
									ESS528	J1
		APS33		SPA163	F1		SAD018	H3		
							SAG024	H1		
							SAG024-1	H1		
									BAE680CX	
			RP01A							
							SAC043	H2		
							SAD033	H3		
							SAG023	H1		
							SAG023-1	H1		
									ESS528	J1
		APS33		SPA163	F1		SAD018	H3	BAE680CX	
							SAG023	H1		
							SAG023-1	H1		
							SAG023	H1	SUA572	J3
							SAG023-1	H1		
				ATS21	F2		SAC012	H2	SUA590	J3
				SPA163	F1		SAG023	H1		
							SAG023-1	H1		
				ATS21	F2		SAG023	H1	GA2190	J2
				SPA163	F1		SAG023-1	H1	SUA574	J3
							SAC012	H2		
				ATS21	F2		SAC012	H2	SUA581	J3
				SPA163	F1		SAG023	H1		
							SAG023-1	H1		
				ATS21	F2		SAG023	H1	GA2190	J2
				SPA163	F1		SAG023-1	H1		
							SAC012	H2		
				ATS21	F2		SAG023	H1	SUA590	J3
				SPA163	F1		SAG023-1	H1		
							SAC012	H2		
				ATS21	F2		SAC012	H2	SUA515	J3
				SPA163	F1		SAG023	H1	SUA590	J3



KW



TYPE



TYPE

MERCEDES-BENZ

CLASSE C (W203)

C 200 Kompressor (203.042)	Petrol	120	05/02 → 02/07						
C 200 Kompressor (203.042)	Petrol	120	09/06 → 02/07						
C 200 Kompressor (203.045)	Petrol	120	05/00 → 06/02						
C 200 Kompressor (203.045)	Petrol	120	05/00 → 06/02						
C 220 CDI (203.006)	Diesel	105	05/00 → 02/07						
C 220 CDI (203.006)	Diesel	105	05/00 → 02/07						
C 220 CDI (203.006)	Diesel	100	05/00 → 02/07						
C 220 CDI (203.006)	Diesel	105	05/00 → 02/07						
C 220 CDI (203.008)	Diesel	110	02/03 → 02/07						
C 220 CDI (203.008)	Diesel	110	02/03 → 02/07						
C 220 CDI (203.008)	Diesel	110	02/03 → 11/05	ENGINE: → 30497543					
C 230 (203.052)	Petrol	150	01/05 → 02/07						
C 230 (203.052)	Petrol	150	01/05 → 02/07						
C 230 (203.052)	Petrol	150	06/06 → 02/07	ENGINE: 30417697 →					
C 230 Kompressor (203.040)	Petrol	141	02/04 → 02/07						
C 230 Kompressor (203.040)	Petrol	141	02/04 → 02/07						
C 230 Kompressor (203.040)	Petrol	141	02/04 → 02/07						
C 230 Kompressor (203.040)	Petrol	141	09/06 → 02/07						
C 240 (203.061)	Petrol	125	05/00 → 02/07						
C 240 (203.061)	Petrol	125	05/00 → 02/07						
C 240 (203.061)	Petrol	125	05/00 → 02/07						
C 240 (203.061)	Petrol	125	05/00 → 12/05						
C 240 4-matic (203.081)	Petrol	125	07/02 → 02/07						
C 240 4-matic (203.081)	Petrol	125	07/02 → 02/07						
C 240 4-matic (203.081)	Petrol	125	07/02 → 02/07						
C 240 4-matic (203.081)	Petrol	125	07/02 → 12/05						
C 270 CDI (203.016)	Diesel	125	12/00 → 02/07						
C 270 CDI (203.016)	Diesel	125	12/00 → 02/07						
C 270 CDI (203.016)	Diesel	125	12/00 → 02/07						
C 280 (203.054)	Petrol	170	01/05 → 02/07						
C 280 (203.054)	Petrol	170	01/05 → 02/07						
C 280 (203.054)	Petrol	170	06/06 → 02/07	ENGINE: 30417697 →					
C 280 4-matic (203.092)	Petrol	170	01/05 → 02/07						
C 280 4-matic (203.092)	Petrol	170	01/05 → 02/07						
C 280 4-matic (203.092)	Petrol	170	06/06 → 02/07	ENGINE: 30417697 →					
C 30 CDI AMG (203.018)	Diesel	170	01/03 → 02/07						
C 30 CDI AMG (203.018)	Diesel	170	01/03 → 02/07						
C 30 CDI AMG (203.018)	Diesel	170	01/03 → 02/07						
C 32AMG Kompressor (203.065)	Petrol	260	02/01 → 02/07						
C 32AMG Kompressor (203.065)	Petrol	260	02/01 → 02/07						
C 32AMG Kompressor (203.065)	Petrol	260	02/01 → 02/07						
C 32AMG Kompressor (203.065)	Petrol	260	02/01 → 12/04						
C 32AMG Kompressor (203.065)	Petrol	260	09/06 → 02/07						
C 320 (203.064)	Petrol	160	05/00 → 02/07						



TYPE



TYPE



TYPE

						SAG023-1	H1			
								SUA515	J3	
						SAG023	H1	SUA572	J3	
						SAG023-1	H1			
				ATS21	F2	SAC012	H2	SUA581	J3	
				SPA163	F1	SAG023	H1			
						SAC012	H2	SUA574	J3	
						SAG023-1	H1			
				ATS21	F2	SAG023	H1	GA2190	J2	
				SPA163	F1	SAG023-1	H1			
						SAC012	H2			
						SAC012	H2	BAE680CR	SUA590	J3
						SAD028	H3			
								BAE680CQ		
				ATS21	F2	SAC012	H2	SUA590	J3	
				SPA163	F1	SAG023	H1			
						SAG023-1	H1			
								SUA515	J3	
	APS33			SPA163	F1	SAD018	H3	BAE680CX	SUA572	J3
						SAG023	H1			
						SAG023-1	H1			
						SAC012	H2			
	APS33			SPA163	F1	SAD018	H3	BAE680CX	SUA590	J3
						SAG023	H1			
						SAG023-1	H1			
						SAC012	H2			
				ATS21	F2	SAC012	H2	SUA581	J3	
				SPA163	F1	SAG023	H1			
						SAG023-1	H1			
						SAC012	H2	BAE680CR	SUA590	J3
						SAD028	H3			
								BAE680CQ		
						SAC012	H2	BAE680CR	SUA590	J3
						SAD028	H3			
								BAE680CQ		
				ATS21	F2	SAC012	H2			
				SPA163	F1	SAG023	H1			
						SAG023-1	H1			
	APS60			ATS21	F2	SAD018	H3	BAE680CX	SUA590	J3
				SPA163	F1	SAG023	H1			
						SAG023-1	H1			
						SAC012	H2			
								SUA515	J3	
	APS33			SPA163	F1	SAD018	H3	BAE680CX	SUA572	J3



KW



TYPE



TYPE

MERCEDES-BENZ

CLASSE C (W203)

C 320 (203.064)	Petrol	160	05/00 → 02/07						
C 320 (203.064)	Petrol	160	05/00 → 02/07						
C 320 (203.064)	Petrol	160	05/00 → 07/05						
C 320 4-matic (203.084)	Petrol	160	07/02 → 02/07						
C 320 4-matic (203.084)	Petrol	160	07/02 → 02/07						
C 320 4-matic (203.084)	Petrol	160	07/02 → 02/07						
C 320 4-matic (203.084)	Petrol	160	07/02 → 07/05						
C 320 CDI (203.020)	Diesel	165	01/05 → 10/05	ENGINE: → 40086332					
C 320 CDI (203.020)	Diesel	165	01/05 → 02/07						
C 350 (203.056)	Petrol	200	01/05 → 02/07						
C 350 (203.056)	Petrol	200	01/05 → 02/07						
C 350 (203.056)	Petrol	200	06/06 → 02/07	ENGINE: 30417697 →					
C 350 4-matic (203.087)	Petrol	200	01/05 → 02/07						
C 350 4-matic (203.087)	Petrol	200	01/05 → 02/07						
C 350 4-matic (203.087)	Petrol	200	06/06 → 02/07	ENGINE: 30417697 →					
C 55 AMG (203.076)	Petrol	270	02/04 → 02/07						
C 55 AMG (203.076)	Petrol	270	02/04 → 02/07						
C 55 AMG (203.076)	Petrol	270	02/04 → 02/07						
C 55 AMG (203.076)	Petrol	270	02/04 → 02/07						

CLASSE C (W204)

C 180 CGI (204.049)	Petrol	115	01/07 →						
C 180 CGI (204.049)	Petrol	115	01/07 →						
C 180 CGI (204.049)	Petrol	115	01/07 →						
C 180 Kompressor (204.044, 204.045)	Petrol	115	01/08 →						
C 180 Kompressor (204.044, 204.045)	Petrol	115	01/08 →						
C 180 Kompressor (204.044, 204.045)	Petrol	115	01/08 →						
C 180 Kompressor (204.046)	Petrol	115	01/07 →						
C 180 Kompressor (204.046)	Petrol	115	01/07 →						
C 180 Kompressor (204.046)	Petrol	115	01/07 →						
C 200 CDI (204.007)	Diesel	100	01/07 →						
C 200 CDI (204.007)	Diesel	100	01/07 →						
C 200 CDI (204.007)	Diesel	100	01/07 →						
C 200 CGI (204.048)	Petrol	135	01/07 →						
C 200 CGI (204.048)	Petrol	135	01/07 →						
C 200 CGI (204.048)	Petrol	135	01/07 →						
C 200 Kompressor (204.041)	Petrol	135	01/07 →						
C 200 Kompressor (204.041)	Petrol	135	01/07 →						
C 200 Kompressor (204.041)	Petrol	135	01/07 →						
C 220 CDI	Diesel	120	04/07 → 11/08						
C 220 CDI (204.002)	Diesel	125	12/08 →						
C 220 CDI (204.002)	Diesel	125	12/08 →						

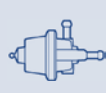

TYPE

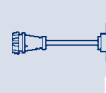

TYPE



TYPE

						SAG023	H1			
						SAG023-1	H1			
						SAC012	H2			
	APS33		SPA163	F1		SAD018	H3	BAE680CX	SUA590	J3
						SAG023	H1			
						SAG023-1	H1			
						SAC012	H2			
						SAC012	H2			
									GA2190	J2
						SAC012	H2	BAE680CR	SUA590	J3
						SAD028	H3			
								BAE680CQ		
						SAC012	H2	BAE680CR	SUA590	J3
						SAD028	H3			
								BAE680CQ		
						SAC012	H2	BAE680CX		
						SAD018	H3			
						SAG023	H1			
						SAG023-1	H1			
						SAC031	H2			
						SAG023	H1			
						SAG023-1	H1			
						SAC012	H2			
						SAG023	H1			
						SAG023-1	H1			
						SAC012	H2		GA2112	J2
						SAG023	H1			
						SAG023-1	H1			
						SAC012	H2		GA2203	J2
						SAG023	H1			
						SAG023-1	H1			
						SAC012	H2		GA2142	J2
						SAG023	H1		SUA566	J3
						SAG023-1	H1			
						SAC012	H2			
						SAG023	H1			
						SAG023-1	H1			
						SAC012	H2			
						SAG023	H1			
						SAG023-1	H1			
						SAC012	H2			
						SAG023	H1		GA2203	J2
						SAG023-1	H1			



KW



TYPE



TYPE

MERCEDES-BENZ

CLASSE C (W204)

C 220 CDI (204.008)	Diesel	125	01/07 →						
C 220 CDI (204.008)	Diesel	125	01/07 →						
C 220 CDI (204.008)	Diesel	125	01/07 →						
C 230 (204.052)	Petrol	150	01/07 →						
C 230 4-matic (204.085)	Petrol	150	07/07 →						
C 250 CDI (204.003)	Diesel	150	08/08 →						
C 250 CDI (204.003)	Diesel	150	08/08 →						
C 250 CGI (204.047)	Petrol	150	07/09 →						
C 250 CGI (204.047)	Petrol	150	07/09 →						
C 280 (204.054)	Petrol	170	01/07 →						
C 280 4-matic (204.081)	Petrol	170	07/07 →						
C 300 (204.054)	Petrol	170	07/09 →						
C 300 4-matic (204.081)	Petrol	170	07/07 →						
C 320 CDI (204.022)	Diesel	165	01/07 →						
C 320 CDI 4-matic (204.089)	Diesel	165	07/07 →						
C 350 (204.056)	Petrol	200	01/07 →						
C 350 4-matic (204.087)	Petrol	200	07/07 →						
C 350 CDI (204.022)	Diesel	165	07/09 →						
C 350 CDI (204.023)	Diesel	195	06/11 →						
C 350 CDI (204.025)	Diesel	170	10/09 →						
C 350 CDI 4-matic (204.089)	Diesel	165	07/09 →						
C 350 CDI 4-matic (204.092)	Diesel	170	10/09 →						
C 350 CGI (204.065)	Petrol	215	09/08 →						
C 63 AMG (204.077)	Petrol	358	01/11 →						
C 63 AMG (204.077)	Petrol	336	02/08 →						

CLASSE C Coupé (C204)

C 180 (204.349)	Petrol	115	06/11 →						
C 250 (204.347)	Petrol	150	06/11 →						
C 63 AMG (204.377)	Petrol	336	06/11 →						
C 63 AMG (204.377)	Petrol	358	01/12 →						
C 63 AMG (204.377)	Petrol	380	01/12 →						

CLASSE C Sportcoupe (CL203)

C 160 Kompressor (203.730)	Petrol	90	05/02 → 05/08						
C 160 Kompressor (203.730)	Petrol	90	05/02 → 05/08						
C 160 Kompressor (203.730)	Petrol	90	09/04 → 07/06						
C 180 (203.735)	Petrol	95	03/01 → 05/02						
C 180 (203.735)	Petrol	95	03/01 → 05/02						
C 180 Kompressor (203.746)	Petrol	105	05/02 → 05/08						
C 180 Kompressor (203.746)	Petrol	105	05/02 → 05/08						
C 180 Kompressor (203.746)	Petrol	105	05/02 → 05/08						
C 200 CDI (203.707)	Diesel	90	03/03 → 05/08						
C 200 CDI (203.707)	Diesel	90	03/03 → 05/08						
C 200 CDI (203.707)	Diesel	90	03/03 → 11/05	ENGINE: → 30497543					

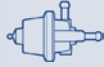

TYPE



TYPE



TYPE

						SAC012	H2		GA2203	J2
						SAG023	H1			
						SAG023-1	H1			
						SAC012	H2	BAE680CQ		
						SAC012	H2	BAE680CQ		
						SAG023	H1		GA2203	J2
						SAG023-1	H1			
						SAC012	H2		GA2142	J2
									SUA566	J3
						SAC012	H2	BAE680CQ		
						SAC012	H2	BAE680CQ		
						SAC012	H2	BAE680CQ		
						SAC012	H2	BAE680CQ		
						SAC012	H2		GA2203	J2
						SAC012	H2		GA2203	J2
						SAC012	H2	BAE680CQ		
						SAC012	H2	BAE680CQ		
						SAC012	H2			
						SAC012	H2			
						SAC012	H2			
						SAC012	H2			
						SAC012	H2			
						SAC012	H2	BAE680CR		
						SAC012	H2			
								BAE680DF		
						SAC012	H2			
						SAC012	H2			
						SAC012	H2	BAE680DF		
						SAC012	H2			
						SAC012	H2			
						SAG023	H1			
						SAG023-1	H1			
						SAC012	H2			
						SAG023	H1		SUA572	J3
						SAG023-1	H1			
				ATS21	F2	SAC012	H2		SUA590	J3
				SPA163	F1	SAG023	H1			
						SAG023-1	H1			
				SPA163	F1	SAG023	H1		GA2190	J2
						SAG023-1	H1			
						SAC012	H2			



KW



TYPE



TYPE

MERCEDES-BENZ

CLASSE C Sportcoupe (CL203)

C 200 CGI Kompressor (203.743)	Petrol	125	03/03 → 05/08						
C 200 CGI Kompressor (203.743)	Petrol	125	03/03 → 05/08						
C 200 CGI Kompressor (203.743)	Petrol	125	03/03 → 05/08						
C 200 Kompressor (203.742)	Petrol	120	05/02 → 05/08						
C 200 Kompressor (203.742)	Petrol	120	05/02 → 05/08						
C 200 Kompressor (203.742)	Petrol	120	08/02 → 04/05						
C 200 Kompressor (203.745)	Petrol	120	03/01 → 05/02						
C 200 Kompressor (203.745)	Petrol	120	03/01 → 05/02						
C 220	Petrol	120	05/02 → 05/08						
C 220	Petrol	120	05/02 → 05/08						
C 220	Petrol	120	05/02 → 04/05						
C 220 CDI (203.706)	Diesel	105	03/01 → 05/08						
C 220 CDI (203.706)	Diesel	105	03/01 → 05/08						
C 220 CDI (203.706)	Diesel	105	03/01 → 05/08						
C 220 CDI (203.708)	Diesel	110	02/04 → 05/08						
C 220 CDI (203.708)	Diesel	110	02/04 → 05/08						
C 220 CDI (203.708)	Diesel	110	02/04 → 11/05	ENGINE: → 30497543					
C 230 (203.752)	Petrol	150	01/05 → 05/08						
C 230 (203.752)	Petrol	150	01/05 → 05/08						
C 230 (203.752)	Petrol	150	06/06 → 05/08	ENGINE: 30417697 →					
C 230 Kompressor (203.740)	Petrol	141	05/02 → 05/08						
C 230 Kompressor (203.740)	Petrol	141	05/02 → 05/08						
C 230 Kompressor (203.740)	Petrol	141	05/02 → 05/08						
C 230 Kompressor (203.747)	Petrol	145	03/01 → 05/02						
C 230 Kompressor (203.747)	Petrol	145	03/01 → 05/02						
C 30 CDI AMG (203.718)	Diesel	170	09/02 → 05/08						
C 30 CDI AMG (203.718)	Diesel	170	09/02 → 05/08						
C 30 CDI AMG (203.718)	Diesel	170	09/02 → 05/08						
C 320 (203.764)	Petrol	160	09/02 → 05/08						
C 320 (203.764)	Petrol	160	09/02 → 05/08						
C 320 (203.764)	Petrol	160	09/02 → 05/08						
C 320 (203.764)	Petrol	160	09/02 → 05/08						
C 350 (203.756)	Petrol	200	01/05 → 05/08						
C 350 (203.756)	Petrol	200	01/05 → 05/08						

CLASSE C Station wagon (S202)

C 180 T (202.078)	Petrol	90	06/96 → 09/00						
C 180 T (202.078)	Petrol	90	06/96 → 09/00						
C 180 T (202.078)	Petrol	90	06/96 → 09/00	ENGINE: → 106153, 060038					
C 180 T (202.081)	Petrol	95	09/00 → 03/01						
C 180 T (202.081)	Petrol	95	09/00 → 03/01						
C 200 T (202.080)	Petrol	100	06/96 → 02/01						



TYPE

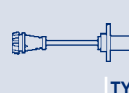

TYPE



TYPE

				ATS21	F2		SAC012	H2		SUA590	J3
				SPA163	F1		SAG023	H1			
							SAG023-1	H1			
				ATS21	F2		SAG023	H1		SUA590	J3
				SPA163	F1		SAG023-1	H1			
							SAC012	H2			
							SAG023	H1		SUA572	J3
							SAG023-1	H1			
							SAG023	H1			
							SAG023-1	H1			
							SAC012	H2			
				ATS21	F2		SAC012	H2		SUA579	J3
				SPA163	F1		SAG023	H1			
							SAG023-1	H1			
							SAG023	H1		GA2190	J2
							SAG023-1	H1			
							SAC012	H2			
							SAC012	H2	BAE680CR	SUA590	J3
							SAD028	H3			
									BAE680CQ		
							SAC012	H2		SUA590	J3
							SAG023	H1			
							SAG023-1	H1			
							SAG023	H1		SUA572	J3
							SAG023-1	H1			
				ATS21	F2		SAC012	H2			
				SPA163	F1		SAG023	H1			
							SAG023-1	H1			
		APS33		SPA163	F1		SAC012	H2	BAE680CX	SUA572	J3
							SAD018	H3			
							SAG023	H1			
							SAG023-1	H1			
							SAC012	H2	BAE680CR	SUA590	J3
							SAD018	H3			
				RP01A	ATS21	F2	SAC016	H2		PI026	J1
							SAD033	H3			
							SAG146	H1			
							SAG023	H1			
							SAG023-1	H1			
				RP01A							



KW



TYPE



TYPE

MERCEDES-BENZ

CLASSE C Station wagon (S202)

C 200 T (202.080)	Petrol	100	06/96 → 03/01						
C 200 T (202.080)	Petrol	100	06/96 → 03/01						
C 200 T (202.080)	Petrol	100	06/96 → 03/01						
C 200 T (202.080)	Petrol	100	06/96 → 03/01						
C 200 T CDI (202.194)	Diesel	75	03/98 → 03/01						
C 200 T CDI (202.194)	Diesel	75	03/98 → 03/01						
C 200 T Kompressor (202.087)	Petrol	120	09/00 → 03/01						
C 200 T Kompressor (202.087)	Petrol	120	09/00 → 03/01						
C 200 T Kompressor (202.082)	Petrol	141	11/96 → 03/01						
C 200 T Kompressor (202.082)	Petrol	141	11/96 → 03/01						
C 220 T CDI (202.193)	Diesel	92	09/97 → 03/01						
C 220 T CDI (202.193)	Diesel	92	09/97 → 03/01						
C 220 T D	Diesel	55	06/96 → 03/01						
C 220 T D	Diesel	55	06/96 → 03/01	ENGINE: 086384 →, 018031 →					
C 220 T D (202.182)	Diesel	70	06/96 → 09/98						
C 220 T D (202.182)	Diesel	70	06/96 → 09/98	ENGINE: 086384 →, 018031 →					
C 230 T Kompressor (202.085)	Petrol	142	06/97 → 09/00						
C 230 T Kompressor (202.085)	Petrol	142	06/97 → 09/00						
C 230 T Kompressor (202.085)	Petrol	142	06/97 → 09/00						
C 230 T Kompressor (202.085)	Petrol	142	06/97 → 09/00						
C 240 T (202.086)	Petrol	125	06/97 → 09/00						
C 240 T (202.086)	Petrol	125	06/97 → 09/00						
C 240 T (202.086)	Petrol	125	06/97 → 09/00						
C 240 T (202.086)	Petrol	125	06/97 → 09/00						
C 240 T (202.088)	Petrol	125	09/00 → 03/01						
C 240 T (202.088)	Petrol	125	09/00 → 03/01						
C 240 T (202.088)	Petrol	125	09/00 → 03/01						
C 240 T (202.088)	Petrol	125	09/00 → 03/01						
C 240 T (202.088)	Petrol	125	09/00 → 02/01						
C 250 T Turbo-D (202.188)	Diesel	110	06/96 → 03/01						
C 250 T Turbo-D (202.188)	Diesel	110	06/96 → 03/01	ENGINE: 015000 →, 007448 →					
C 280 T (202.089)	Petrol	145	06/97 → 03/01						
C 280 T (202.089)	Petrol	145	06/97 → 03/01						
C 280 T (202.089)	Petrol	145	06/97 → 03/01						
C 280 T (202.089)	Petrol	145	06/97 → 03/01						
C 280 T (202.089)	Petrol	145	06/97 → 02/01						
C 43 AMG (202.093)	Petrol	225	08/97 → 03/01						
C 43 AMG (202.093)	Petrol	225	08/97 → 03/01						
C 43 AMG (202.093)	Petrol	225	08/97 → 03/01	ENGINE: 60002421 →					
C 43 AMG (202.093)	Petrol	225	08/97 → 03/01	ENGINE: 60002421 →					
C 43 AMG (202.093)	Petrol	225	10/97 → 02/01						



TYPE



TYPE



TYPE

				ATS21	F2		SAC016	H2		PI026	J1
							SAD033	H3			
							SAG023	H1			
							SAG023-1	H1			
				ATS21	F2		SAC012	H2			
				SPA163	F1		SAG146	H1			
							SAG023	H1			
							SAG023-1	H1			
				ATS21	F2		SAC016	H2		PI026	J1
							SAD033	H3			
				ATS21	F2		SAC012	H2			
				SPA163	F1		SAG146	H1			
				ATS21	F2						
							SAG146	H1			
				ATS21	F2						
							SAG146	H1			
				ATS21	F2		SAC016	H2		PI026	J1
							SAD033	H3			
							SAG023	H1			
							SAG023-1	H1			
				SPA163	F1		SAC012	H2		BAE680CX	
							SAD018	H3			
							SAG023	H1			
							SAG023-1	H1			
	APS33			SPA163	F1		SAC012	H2			
							SAD018	H3			
							SAG023	H1			
							SAG023-1	H1			
										BAE680CX	
				ATS21	F2		SAC012	H2			
							SAG146	H1			
	APS33			SPA163	F1		SAC012	H2			
							SAD018	H3			
							SAG023	H1			
							SAG023-1	H1			
										BAE680CX	
	APS33			SPA163	F1		SAC012	H2			
							SAD018	H3			
							SAG023	H1			
							SAG023-1	H1			
										BAE680CX	



KW



TYPE



TYPE

MERCEDES-BENZ

CLASSE C T-Model (S203)

C 180 (203.235)	Petrol	95	03/01 → 05/02						
C 180 (203.235)	Petrol	95	03/01 → 05/02						
C 180 Kompressor (203.246)	Petrol	105	05/02 → 08/07						
C 180 Kompressor (203.246)	Petrol	105	05/02 → 08/07						
C 180 Kompressor (203.246)	Petrol	105	05/02 → 08/07						
C 200 CDI (203.204)	Diesel	85	03/01 → 08/07						
C 200 CDI (203.204)	Diesel	85	03/01 → 08/07						
C 200 CDI (203.204)	Diesel	85	03/01 → 08/07						
C 200 CDI (203.204, 203.207)	Diesel	75	03/01 → 08/07						
C 200 CDI (203.204, 203.207)	Diesel	75	03/01 → 08/07						
C 200 CDI (203.204, 203.207)	Diesel	75	03/01 → 11/05	ENGINE: → 30497543					
C 200 CDI (203.207)	Diesel	90	04/03 → 08/07						
C 200 CDI (203.207)	Diesel	90	04/03 → 08/07						
C 200 CDI (203.207)	Diesel	90	04/03 → 11/05	ENGINE: → 30497543					
C 200 CGI Kompressor (203.243)	Petrol	125	07/03 → 08/07						
C 200 CGI Kompressor (203.243)	Petrol	125	07/03 → 08/07						
C 200 CGI Kompressor (203.243)	Petrol	125	07/03 → 08/07						
C 200 Kompressor (203.242)	Petrol	120	05/02 → 08/07						
C 200 Kompressor (203.242)	Petrol	120	05/02 → 08/07						
C 200 Kompressor (203.242)	Petrol	120	05/02 → 08/07						
C 200 Kompressor (203.245)	Petrol	120	03/01 → 05/02						
C 200 Kompressor (203.245)	Petrol	120	03/01 → 05/02						
C 220 CDI (203.206)	Diesel	105	03/01 → 08/07						
C 220 CDI (203.206)	Diesel	105	03/01 → 08/07						
C 220 CDI (203.206)	Diesel	105	03/01 → 08/07						
C 220 CDI (203.208)	Diesel	110	02/04 → 08/07						
C 220 CDI (203.208)	Diesel	110	02/04 → 08/07						
C 220 CDI (203.208)	Diesel	110	02/04 → 11/05	ENGINE: → 30497543					
C 230 (203.252)	Petrol	150	01/05 → 08/07						
C 230 (203.252)	Petrol	150	01/05 → 08/07						
C 230 (203.252)	Petrol	150	06/06 → 08/07	ENGINE: 30417697 →					
C 230 Kompressor (203.240)	Petrol	141	02/04 → 08/07						
C 230 Kompressor (203.240)	Petrol	141	02/04 → 08/07						
C 230 Kompressor (203.240)	Petrol	141	02/04 → 07/05						
C 240 (203.261)	Petrol	125	03/01 → 08/07						
C 240 (203.261)	Petrol	125	03/01 → 08/07						
C 240 (203.261)	Petrol	125	03/01 → 08/07						
C 240 (203.261)	Petrol	125	03/01 → 12/05						
C 240 4-matic (203.281)	Petrol	125	07/02 → 08/07						
C 240 4-matic (203.281)	Petrol	125	07/02 → 08/07						
C 240 4-matic (203.281)	Petrol	125	07/02 → 08/07						

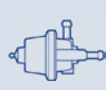

TYPE

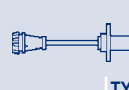

TYPE



TYPE

						SAG023	H1	SUA572	J3
						SAG023-1	H1		
				ATS21	F2	SAC012	H2	SUA590	J3
				SPA163	F1	SAG023	H1		
						SAG023-1	H1		
				ATS21	F2	SAC012	H2	SUA579	J3
				SPA163	F1	SAG023	H1		
						SAG023-1	H1		
				ATS21	F2	SAG023	H1	GA2190	J2
				SPA163	F1	SAG023-1	H1		
						SAC012	H2		
				ATS21	F2	SAG023	H1	GA2190	J2
						SAG023-1	H1		
						SAC012	H2		
				ATS21	F2	SAC012	H2	SUA590	J3
				SPA163	F1	SAG023	H1		
						SAG023-1	H1		
						SAC012	H2	SUA590	J3
						SAG023	H1		
						SAG023-1	H1		
				ATS21	F2	SAC012	H2	SUA579	J3
				SPA163	F1	SAG023	H1		
						SAG023-1	H1		
				ATS21	F2	SAG023	H1	GA2190	J2
						SAG023-1	H1		
						SAC012	H2		
						SAC012	H2	BAE680CR	SUA590
						SAD028	H3		
								BAE680CQ	
						SAG023	H1	SUA590	J3
						SAG023-1	H1		
						SAC012	H2		
		APS33		SPA163	F1	SAD018	H3	BAE680CX	SUA572
						SAG023	H1		
						SAG023-1	H1		
						SAC012	H2		
		APS33		SPA163	F1	SAD018	H3	BAE680CX	SUA590
						SAG023	H1		
						SAG023-1	H1		



KW



TYPE



TYPE

MERCEDES-BENZ

CLASSE C T-Model (S203)

C 240 4-matic (203.281)	Petrol	125	07/02 → 12/05					
C 270 CDI (203.216)	Diesel	125	03/01 → 08/07					
C 270 CDI (203.216)	Diesel	125	03/01 → 08/07					
C 270 CDI (203.216)	Diesel	125	03/01 → 08/07					
C 280 (203.254)	Petrol	170	01/05 → 08/07					
C 280 (203.254)	Petrol	170	01/05 → 08/07					
C 280 (203.254)	Petrol	170	06/06 → 08/07	ENGINE: 30417697 →				
C 280 4-matic (203.292)	Petrol	170	01/05 → 08/07					
C 280 4-matic (203.292)	Petrol	170	01/05 → 08/07					
C 280 4-matic (203.292)	Petrol	170	06/06 → 08/07	ENGINE: 30417697 →				
C 30 CDI AMG (203.218)	Diesel	170	01/03 → 08/07					
C 30 CDI AMG (203.218)	Diesel	170	01/03 → 08/07					
C 30 CDI AMG (203.218)	Diesel	170	01/03 → 08/07					
C 32 AMG Kompressor (203.265)	Petrol	260	03/01 → 08/07					
C 32 AMG Kompressor (203.265)	Petrol	260	03/01 → 08/07					
C 32 AMG Kompressor (203.265)	Petrol	260	03/01 → 08/07					
C 32 AMG Kompressor (203.265)	Petrol	260	03/01 → 12/04					
C 32 AMG Kompressor (203.265)	Petrol	260	03/01 → 01/04					
C 320 (203.264, 203.764)	Petrol	160	03/01 → 08/07					
C 320 (203.264, 203.764)	Petrol	160	03/01 → 08/07					
C 320 (203.264, 203.764)	Petrol	160	03/01 → 08/07					
C 320 (203.264, 203.764)	Petrol	160	03/01 → 08/07					
C 320 4-matic (203.284)	Petrol	160	07/02 → 08/07					
C 320 4-matic (203.284)	Petrol	160	07/02 → 08/07					
C 320 4-matic (203.284)	Petrol	160	07/02 → 08/07					
C 320 4-matic (203.284)	Petrol	160	07/02 → 07/05					
C 320 CDI (203.220)	Diesel	165	06/05 → 08/07					
C 350 (203.256)	Petrol	200	01/05 → 08/07					
C 350 (203.256)	Petrol	200	01/05 → 08/07					
C 350 (203.256)	Petrol	200	06/06 → 08/07	ENGINE: 30417697 →				
C 350 4-matic (203.287)	Petrol	200	01/05 → 08/07					
C 350 4-matic (203.287)	Petrol	200	04/05 → 08/07					
C 350 4-matic (203.287)	Petrol	200	06/06 → 08/07	ENGINE: 30417697 →				
C 55 AMG (203.276)	Petrol	270	02/04 → 08/07					
C 55 AMG (203.276)	Petrol	270	02/04 → 08/07					
C 55 AMG (203.276)	Petrol	270	02/04 → 08/07					
C 55 AMG (203.276)	Petrol	270	02/04 → 08/07					



TYPE

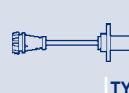

TYPE



TYPE

						SAC012	H2			
				SPA163	F1	SAC012	H2		SUA579	J3
				ATS21	F2	SAG023	H1			
						SAG023-1	H1			
						SAC012	H2	BAE680CR	SUA590	J3
						SAD028	H3			
								BAE680CQ		
						SAC012	H2	BAE680CR	SUA590	J3
						SAD028	H3			
								BAE680CQ		
				ATS21	F2	SAC012	H2			
				SPA163	F1	SAG023	H1			
						SAG023-1	H1			
	APS60			ATS21	F2	SAD018	H3		SUA590	J3
				SPA163	F1	SAG023	H1			
						SAG023-1	H1			
						SAC012	H2			
								BAE680CX		
	APS33			SPA163	F1	SAC012	H2	BAE680CX	SUA572	J3
						SAD018	H3			
						SAG023	H1			
						SAG023-1	H1			
	APS33			SPA163	F1	SAD018	H3	BAE680CX	SUA590	J3
						SAG023	H1			
						SAG023-1	H1			
						SAC012	H2			
						SAC012	H2		GA2190	J2
						SAC012	H2	BAE680CR	SUA590	J3
						SAD028	H3			
								BAE680CQ		
						SAD018	H3	BAE680CR	SUA590	J3
						SAC012	H2			
								BAE680CQ		
						SAC012	H2	BAE680CX		
						SAD018	H3			
						SAG023	H1			
						SAG023-1	H1			



KW



TYPE



TYPE

MERCEDES-BENZ

CLASSE C T-Model (S204)

C 180 CGI (204.249)	Petrol	115	11/09 →						
C 180 Kompressor (204.245)	Petrol	115	01/08 →						
C 180 Kompressor (204.245)	Petrol	115	01/08 →						
C 180 Kompressor (204.245)	Petrol	115	01/08 →						
C 180 Kompressor (204.246)	Petrol	115	08/07 →						
C 180 Kompressor (204.246)	Petrol	115	11/07 →						
C 180 Kompressor (204.246)	Petrol	115	11/07 →						
C 200 CDI (204.201)	Diesel	100	08/10 →						
C 200 CDI (204.201)	Diesel	100	08/10 →						
C 200 CDI (204.207)	Diesel	100	11/07 →						
C 200 CDI (204.207)	Diesel	100	11/07 →						
C 200 CDI (204.207)	Diesel	100	11/07 →						
C 200 Kompressor (204.241)	Petrol	135	08/07 →						
C 200 Kompressor (204.241)	Petrol	135	11/07 →						
C 200 Kompressor (204.241)	Petrol	135	11/07 →						
C 220 CDI	Diesel	120	08/07 → 11/08						
C 220 CDI (204.202)	Diesel	125	12/08 →						
C 220 CDI (204.202)	Diesel	125	12/08 →						
C 220 CDI (204.208)	Diesel	125	11/07 →						
C 220 CDI (204.208)	Diesel	125	11/07 →						
C 220 CDI (204.208)	Diesel	125	11/07 →						
C 220 CDI (204.208)	Diesel	125	08/07 →						
C 230 (204.252)	Petrol	150	11/07 →						
C 230 (204.252)	Petrol	150	08/07 →						
C 250 CDI (204.203)	Diesel	150	01/09 →						
C 250 CDI (204.203)	Diesel	150	01/09 →						
C 250 CGI (204.247)	Petrol	150	07/09 →						
C 250 CGI (204.247)	Petrol	150	07/09 →						
C 280 (204.254)	Petrol	170	11/07 →						
C 280 (204.254)	Petrol	170	08/07 →						
C 320 CDI (204.222)	Diesel	165	11/07 →						
C 320 CDI (204.222)	Diesel	165	08/07 →						
C 320 CDI 4-matic (204.289)	Diesel	165	05/08 →						
C 320 CDI 4-matic (204.289)	Diesel	165	08/07 →						
C 350 (204.256)	Petrol	200	11/07 →						
C 350 (204.256)	Petrol	200	08/07 →						
C 350 CDI (204.223)	Diesel	195	06/11 →						
C 350 CDI (204.225)	Diesel	170	10/09 →						
C 350 CDI 4-matic (204.292)	Diesel	170	10/09 →						
C 63 AMG (204.277)	Petrol	336	02/08 →						
C 63 AMG (204.277)	Petrol	358	01/12 →						

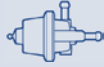

TYPE



TYPE



TYPE

					TYPE					
					SAC031	H2				
					SAC012	H2				
					SAG023	H1				
					SAG023-1	H1				
					SAC012	H2				
					SAG023	H1				
					SAG023-1	H1				
					SAG023	H1				
					SAG023-1	H1				
					SAC012	H2				
					SAG023	H1				
					SAG023-1	H1				
					SAC012	H2				
					SAG023	H1				
					SAG023-1	H1				
					SAC012	H2				
					SAG023	H1		GA2203		J2
					SAG023-1	H1				
					SAC012	H2				
					SAG023	H1				
					SAG023-1	H1				
								GA2203		J2
					SAC012	H2				
								BAE680CQ		
					SAG023	H1				
					SAG023-1	H1				
					SAC012	H2		GA2142		J2
								SUA566		J3
					SAC012	H2				
								BAE680CQ		
					SAC012	H2				
								GA2203		J2
					SAC012	H2				
								GA2203		J2
					SAC012	H2				
								BAE680CQ		
					SAC012	H2				
					SAC012	H2				
					SAC012	H2				
					SAC012	H2		BAE680DF		
					SAC012	H2				



KW



TYPE



TYPE

MERCEDES-BENZ

CLASSE CLC (CL203)

CLC 160 (203.731)	Petrol	95	02/09 → 06/11						
CLC 160 (203.731)	Petrol	95	02/09 → 06/11						
CLC 160 (203.731)	Petrol	95	02/09 → 06/11						
CLC 180 Kompressor (203.746)	Petrol	105	05/08 → 06/11						
CLC 180 Kompressor (203.746)	Petrol	105	05/08 → 06/11						
CLC 180 Kompressor (203.746)	Petrol	105	05/08 → 06/11						
CLC 200 CDI (203.707)	Diesel	90	05/08 → 06/11						
CLC 200 CDI (203.707)	Diesel	90	05/08 → 06/11						
CLC 200 CDI (203.707)	Diesel	90	05/08 → 06/11						
CLC 200 Kompressor (203.741)	Petrol	135	05/08 → 06/11						
CLC 200 Kompressor (203.741)	Petrol	135	05/08 → 06/11						
CLC 200 Kompressor (203.741)	Petrol	135	05/08 → 06/11						
CLC 220 CDI (203.708)	Diesel	110	05/08 → 06/11						
CLC 220 CDI (203.708)	Diesel	110	05/08 → 06/11						
CLC 220 CDI (203.708)	Diesel	110	05/08 → 06/11						
CLC 230 (203.752)	Petrol	150	05/08 → 06/11						
CLC 350 (203.756)	Petrol	200	05/08 → 06/11						

CLASSE E (W124)

E 200 (124.019)	Petrol	100	07/93 → 06/95						
E 200 (124.019)	Petrol	100	06/93 → 06/95	ENGINE: 055902 →					
E 220 (124.022)	Petrol	110	07/93 → 06/95						
E 220 (124.022)	Petrol	110	06/93 → 06/95	ENGINE: 080037 →					
E 220 (124.022)	Petrol	110	06/93 → 06/95						
E 220 (124.022)	Petrol	110	06/93 → 06/95						
E 280 (124.028)	Petrol	145	07/93 → 06/95						
E 280 (124.028)	Petrol	145	06/93 → 06/95	ENGINE: 005790 →					
E 280 (124.028)	Petrol	145	06/93 → 06/95						
E 280 (124.028)	Petrol	145	06/93 → 06/95						
E 280 (124.028)	Petrol	145	09/94 → 06/95						
E 280 (124.029)	Petrol	142	07/93 → 06/95						
E 280 (124.029)	Petrol	142	06/93 → 06/95	ENGINE: 005790 →					
E 280 (124.029)	Petrol	142	06/93 → 06/95						
E 280 (124.029)	Petrol	142	06/93 → 06/95						
E 280 (124.029)	Petrol	142	09/94 → 06/95						
E 300 4-matic (124.230)	Petrol	132	06/93 → 06/95	ENGINE: 002188 →, 008268 →					
E 300 4-matic (124.230)	Petrol	132	06/93 → 06/95	CHASSIS: A368937 →					
E 300 4-matic (124.230)	Petrol	132	09/94 → 06/95						
E 300 D (124.131)	Diesel	100	07/93 → 06/95						
E 320 (124.032)	Petrol	162	07/93 → 06/95						
E 320 (124.032)	Petrol	162	06/93 → 06/95	ENGINE: 004357 →					
E 320 (124.032)	Petrol	162	06/93 → 06/95						
E 320 (124.032)	Petrol	162	06/93 → 06/95						
E 320 (124.032)	Petrol	162	09/94 → 06/95						
E 420 (124.034)	Petrol	205	07/93 → 06/95						

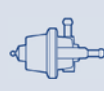

TYPE



TYPE



TYPE

						SAC012	H2				
						SAG023	H1				
						SAG023-1	H1				
						SAC012	H2				
						SAG023	H1				
						SAG023-1	H1				
						SAC012	H2		GA2190		J2
						SAG023	H1				
						SAG023-1	H1				
						SAC012	H2				
						SAG023	H1				
						SAG023-1	H1				
						SAC012	H2		GA2190		J2
						SAG023	H1				
						SAG023-1	H1				
						SAC012	H2	BAE680CQ			
						SAC012	H2	BAE680CQ			

						RP01A					
						ATS21	F2				
						RP01A					
						ATS21	F2				
						SAC043	H2				
						SAD033	H3				
						RP01A					
						ATS21	F2				
						SAC043	H2		ESS528		J1
						SAD033	H3				
									PI027		J1
						RP01A					
						ATS21	F2				
						SAC043	H2		ESS528		J1
						SAD033	H3				
									PI027		J1
						SPA136	F1				
									ESS528		J1
									PI027		J1
						SPA136	F1				
						RP01A					
						ATS21	F2				
						SAC043	H2		ESS528		J1
						SAD033	H3				
									PI027		J1
						RP01A					



KW

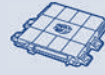

TYPE



TYPE

MERCEDES-BENZ

CLASSE E (W124)

E 420 (124.034)	Petrol	205	06/93 → 06/95						
E 420 (124.034)	Petrol	205	06/93 → 06/95	CHASSIS: → C226335					
E 420 (124.034)	Petrol	205	09/94 → 06/95						
E 500 (124.036)	Petrol	235	07/93 → 06/95						
E 500 (124.036)	Petrol	235	06/93 → 06/95						
E 500 (124.036)	Petrol	235	09/94 → 06/95						
E 60 AMG (124.036)	Petrol	280	05/94 → 06/95						

CLASSE E (W210)

E 200 (210.035)	Petrol	100	06/95 → 08/00						
E 200 (210.035)	Petrol	100	06/95 → 08/00						
E 200 (210.035)	Petrol	100	06/95 → 08/00						
E 200 (210.035)	Petrol	100	06/95 → 08/00						
E 200 (210.035)	Petrol	100	06/95 → 06/98						
E 200 CDI (210.007)	Diesel	75	06/98 → 03/02						
E 200 CDI (210.007)	Diesel	75	06/98 → 03/02						
E 200 CDI (210.007)	Diesel	85	07/99 → 03/02						
E 200 CDI (210.007)	Diesel	75	06/98 → 03/02	ENGINE: 30121322 →					
E 200 CDI (210.007)	Diesel	75	06/98 → 03/02	ENGINE: 30121322 →					
E 200 CDI (210.007)	Diesel	85	07/99 → 03/02	ENGINE: 30121322 →					
E 200 CDI (210.007)	Diesel	85	07/99 → 03/02	ENGINE: 30121322 →					
E 200 D (210.003)	Diesel	65	01/96 → 03/02						
E 200 Kompressor (210.045)	Petrol	137	09/97 → 08/00						
E 200 Kompressor (210.045)	Petrol	137	06/97 → 03/02						
E 200 Kompressor (210.045)	Petrol	137	06/97 → 03/02						
E 200 Kompressor (210.045)	Petrol	137	06/97 → 03/02						
E 200 Kompressor (210.045)	Petrol	137	06/97 → 03/02						
E 200 Kompressor (210.048)	Petrol	120	08/00 → 03/02						
E 200 Kompressor (210.048)	Petrol	120	08/00 → 03/02						
E 220 CDI	Diesel	100	07/99 → 03/02						
E 220 CDI (210.006)	Diesel	105	07/99 → 03/02						
E 220 CDI (210.006)	Diesel	92	06/98 → 07/99						
E 220 CDI (210.006)	Diesel	105	07/99 → 03/02	ENGINE: 30121322 →					
E 220 CDI (210.006)	Diesel	105	07/99 → 03/02	ENGINE: 30121322 →					
E 220 CDI (210.006)	Diesel	92	06/98 → 07/99	ENGINE: 30121322 →					
E 220 CDI (210.006)	Diesel	92	06/98 → 07/99	ENGINE: 30121322 →					
E 220 D	Diesel	55	05/96 → 03/02						
E 220 D (210.004)	Diesel	70	06/95 → 07/99						
E 230 (210.037)	Petrol	110	06/95 → 06/97						
E 230 (210.037)	Petrol	110	06/95 → 06/97						
E 240 (210.061)	Petrol	125	06/97 → 08/00						
E 240 (210.061)	Petrol	125	06/97 → 08/00						
E 240 (210.061)	Petrol	125	06/97 → 08/00	ENGINE: 30370999 →					
E 240 (210.061)	Petrol	125	06/97 → 08/00	ENGINE: 30370999 →					
E 240 (210.061)	Petrol	125	09/97 → 04/00						



TYPE

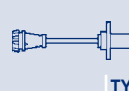

TYPE



TYPE

			SPA136	F1		SAC043	H2			
									ESS528	J1
									PI027	J1
		RP01A								
			SPA136	F1		SAC043	H2		ESS528	J1
									PI027	J1
		RP01A				SAC043	H2		ESS528	J1
		RP01A	ATS21	F2		SAC016	H2		ESS528	J1
						SAD033	H3			
						SAG023	H1			
						SAG023-1	H1			
						SAG146	H1			
			ATS21	F2		SAC012	H2			
			SPA163	F1						
			SPA163	F1		SAC012	H2			
						SAG023	H1			
						SAG023-1	H1			
						SAG023	H1			
						SAG023-1	H1			
		RP01A	ATS21	F2		SAG146	H1			
						SAC016	H2			
						SAD033	H3			
						SAG023	H1			
						SAG023-1	H1			
			ATS21	F2		SAG023	H1			
						SAG023-1	H1			
						SAC012	H2			
			SPA163	F1		SAC012	H2			
			ATS21	F2		SAC012	H2			
						SAG023	H1			
						SAG023-1	H1			
						SAG023	H1			
						SAG023-1	H1			
						SAG146	H1			
			ATS21	F2		SAG146	H1			
		RP01A	ATS21	F2		SAC016	H2		ESS528	J1
						SAG146	H1			
			SPA163	F1		SAC012	H2		PI027	J1
						SAD018	H3			
						SAG023	H1			
						SAG023-1	H1			
									BAE680CX	



KW



TYPE



TYPE

MERCEDES-BENZ

CLASSE E (W210)

E 240 (210.062)	Petrol	125	08/00 → 03/02						
E 240 (210.062)	Petrol	125	08/00 → 03/02						
E 240 (210.062)	Petrol	125	08/00 → 03/02						
E 240 (210.062)	Petrol	125	08/00 → 03/02						
E 250 D (210.010)	Diesel	83	06/95 → 07/99						
E 250 Turbo-D (210.015)	Diesel	110	06/97 → 07/99						
E 270 CDI (210.016)	Diesel	125	07/99 → 03/02						
E 270 CDI (210.016)	Diesel	125	07/99 → 03/02						
E 270 CDI (210.016)	Diesel	125	07/99 → 03/02						
E 280 (210.053)	Petrol	142	01/96 → 02/97						
E 280 (210.053)	Petrol	142	01/96 → 06/97						
E 280 (210.053)	Petrol	142	01/96 → 06/97						
E 290 Turbo-D (210.017)	Diesel	95	03/96 → 07/99						
E 300 D (210.020)	Diesel	100	06/95 → 06/97						
E 320 (210.055)	Petrol	162	06/95 → 02/97						
E 320 CDI (210.026)	Diesel	145	07/99 → 03/02						
E 320 CDI (210.026)	Diesel	145	07/99 → 03/02						
E 320 CDI (210.026)	Diesel	145	07/99 → 03/02						
E 420 (210.072)	Petrol	205	01/96 → 06/97						
E 420 (210.072)	Petrol	205	01/96 → 06/97						
E 420 (210.072)	Petrol	205	01/96 → 06/97						
E 430 (210.070)	Petrol	205	01/01 → 03/02						
E 430 (210.070)	Petrol	205	06/97 → 03/02						
E 430 (210.070)	Petrol	205	06/97 → 03/02						
E 430 (210.070)	Petrol	205	06/97 → 03/02	ENGINE: 30039710 →					
E 430 (210.070)	Petrol	205	06/97 → 03/02	ENGINE: 30039710 →					
E 430 4-matic (210.083)	Petrol	205	01/01 → 03/02						
E 430 4-matic (210.083)	Petrol	205	05/99 → 03/02						
E 430 4-matic (210.083)	Petrol	205	05/99 → 03/02	ENGINE: 30039710 →					
E 430 4-matic (210.083)	Petrol	205	05/99 → 03/02	ENGINE: 30039710 →					
E 430 4-matic (210.083)	Petrol	205	09/99 → 03/02						
E 50 AMG (210.072)	Petrol	255	02/96 → 08/97						
E 50 AMG (210.072)	Petrol	255	02/96 → 08/97						
E 50 AMG (210.072)	Petrol	255	09/96 → 08/97						
E 55 AMG (210.074)	Petrol	260	01/01 → 03/02						
E 55 AMG (210.074)	Petrol	260	08/97 → 03/02						
E 55 AMG (210.074)	Petrol	260	08/97 → 03/02						
E 55 AMG (210.074)	Petrol	260	08/97 → 03/02	ENGINE: 60002693 →					
E 55 AMG (210.074)	Petrol	260	08/97 → 03/02	ENGINE: 60002693 →					
E 55 AMG 4-matic (210.074)	Petrol	260	03/01 → 03/02						
E 55 AMG 4-matic (210.074)	Petrol	260	03/01 → 03/02	ENGINE: 60002693 →					
E 55 AMG 4-matic (210.074)	Petrol	260	03/01 → 03/02	ENGINE: 60002693 →					



TYPE



TYPE



TYPE

	APS33		SPA163	F1		SAC012	H2	BAE680CX		
						SAD018	H3			
						SAG023	H1			
						SAG023-1	H1			
			ATS21	F2		SAG146	H1			
			ATS21	F2		SAG146	H1			
			ATS21	F2		SAC012	H2			
			SPA163	F1		SAG023	H1			
						SAG023-1	H1			
		RP01A								
			ATS21	F2		SAC016	H2		PI027	J1
						SAD033	H3			
			ATS21	F2		SAG146	H1			
			ATS21	F2		SAG146	H1			
		RP01A								
			ATS21	F2		SAC012	H2			
			SPA163	F1		SAG023	H1			
						SAG023-1	H1			
		RP01A	ATS21	F2		SAC012	H2		PI027	J1
						SAD018	H3			
						SAG146	H1			
	APS33									
			SPA163	F1		SAC012	H2	BAE680CX	PI027	J1
						SAD018	H3			
						SAG023	H1			
						SAG023-1	H1			
	APS33									
			SPA163	F1		SAD018	H3	BAE680CX	PI027	J1
						SAG023	H1			
						SAG023-1	H1			
						SAC012	H2			
		RP01A	ATS21	F2		SAD018	H3			
						SAG146	H1			
						SAC012	H2			
	APS33									
			SPA163	F1		SAC012	H2	BAE680CX	PI027	J1
						SAD018	H3			
						SAG023	H1			
						SAG023-1	H1			
	APS33		ATS21	F2		SAC012	H2		PI027	J1
						SAG023	H1			
						SAG023-1	H1			



KW



TYPE



TYPE

MERCEDES-BENZ

CLASSE E (W211)

E 200 CDI (211.004)	Diesel	75	07/02 → 12/08						
E 200 CDI (211.004)	Diesel	75	07/02 → 12/08						
E 200 CDI (211.004)	Diesel	90	07/02 → 12/08						
E 200 CDI (211.004)	Diesel	90	07/02 → 12/08						
E 200 CDI (211.004)	Diesel	75	07/02 → 11/05	ENGINE: → 30497543					
E 200 CDI (211.004)	Diesel	90	07/02 → 11/05	ENGINE: → 30497543					
E 200 CDI (211.007)	Diesel	100	04/06 → 12/08						
E 200 CDI (211.007)	Diesel	100	04/06 → 12/08						
E 200 CDI (211.007)	Diesel	100	04/06 → 12/08						
E 200 CGI	Petrol	125	11/02 → 12/08						
E 200 CGI	Petrol	125	11/02 → 12/08						
E 200 CGI	Petrol	125	11/02 → 06/05						
E 200 Kompressor (211.041)	Petrol	135	04/06 → 12/08						
E 200 Kompressor (211.041)	Petrol	135	04/06 → 12/08						
E 200 Kompressor (211.041)	Petrol	135	04/06 → 12/08						
E 200 Kompressor (211.042)	Petrol	120	11/02 → 12/08						
E 200 Kompressor (211.042)	Petrol	120	11/02 → 12/08						
E 200 Kompressor (211.042)	Petrol	120	11/02 → 07/06						
E 200 NGT (211.041)	BiFuel	120	03/04 → 12/08						
E 200 NGT (211.041)	BiFuel	120	03/04 → 12/08						
E 200 NGT (211.041)	BiFuel	120	03/04 → 12/08						
E 220 CDI	Diesel	120	03/03 → 12/08						
E 220 CDI (211.006)	Diesel	110	03/02 → 12/08						
E 220 CDI (211.006)	Diesel	110	03/02 → 12/08						
E 220 CDI (211.006)	Diesel	100	03/02 → 12/08						
E 220 CDI (211.006)	Diesel	100	03/02 → 12/08						
E 220 CDI (211.006)	Diesel	100	03/02 → 12/08						
E 220 CDI (211.006)	Diesel	110	03/02 → 11/05	ENGINE: → 30497543					
E 220 CDI (211.008)	Diesel	125	04/06 → 12/08						
E 220 CDI (211.008)	Diesel	125	04/06 → 12/08						
E 220 CDI (211.008)	Diesel	125	04/06 → 12/08						
E 230 (211.052)	Petrol	150	09/07 → 12/08						
E 240 (211.061)	Petrol	130	03/02 → 12/08						
E 240 (211.061)	Petrol	130	03/02 → 12/08						
E 240 (211.061)	Petrol	130	03/02 → 12/08						
E 240 (211.061)	Petrol	130	03/02 → 07/06						
E 240 (211.061)	Petrol	130	03/02 → 03/05						
E 240 4-matic (211.080)	Petrol	130	03/03 → 12/08						
E 240 4-matic (211.080)	Petrol	130	03/03 → 12/08						
E 240 4-matic (211.080)	Petrol	130	03/03 → 12/08						
E 240 4-matic (211.080)	Petrol	130	08/03 → 07/05						
E 240 4-matic (211.080)	Petrol	130	09/03 → 12/08						
E 270 CDI (211.016)	Diesel	130	03/02 → 12/08						
E 270 CDI (211.016)	Diesel	130	03/02 → 12/08						



TYPE

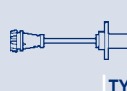

TYPE



TYPE

				ATS21	F2		SAG023	H1		
				SPA163	F1		SAG023-1	H1		
				ATS21	F2		SAG023	H1		
				SPA163	F1		SAG023-1	H1		
							SAC012	H2		
							SAC012	H2		
							SAC012	H2		
							SAG023	H1		
							SAG023-1	H1		
							SAG023	H1		
							SAG023-1	H1		
							SAC012	H2		
							SAC012	H2		
							SAG023	H1		
							SAG023-1	H1		
				ATS21	F2		SAG023	H1		
				SPA163	F1		SAG023-1	H1		
							SAC012	H2		
							SAC012	H2		
							SAG023	H1		
							SAG023-1	H1		
				ATS21	F2		SAG023	H1		
				SPA163	F1		SAG023-1	H1		
							SAC012	H2		
							SAG023	H1		
							SAG023-1	H1		
							SAC012	H2		
				ATS21	F2		SAG023	H1		
				SPA163	F1		SAG023-1	H1		
							SAC012	H2		
							SAG023	H1		
							SAG023-1	H1		
							SAC012	H2		
							SAC012	H2		
							SAG023	H1		
							SAG023-1	H1		
							SAC012	H2	BAE680Q	
		APS33		SPA163	F1		SAD018	H3		
							SAG023	H1		
							SAG023-1	H1		
							SAC012	H2		
									BAE680CX	
		APS33					SAD018	H3		
							SAG023	H1		
							SAG023-1	H1		
							SAC012	H2		
									BAE680CX	
				ATS21	F2		SAC012	H2		
				SPA163	F1		SAG023	H1		



KW

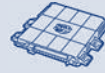

TYPE



TYPE

MERCEDES-BENZ

CLASSE E (W211)

E 270 CDI (211.016)	Diesel	120	03/02 → 12/08						
E 270 CDI (211.016)	Diesel	130	03/02 → 12/08						
E 280 (211.054)	Petrol	170	03/05 → 12/08						
E 280 (211.054)	Petrol	170	03/05 → 12/08						
E 280 (211.054)	Petrol	170	06/06 → 12/08	ENGINE: 30417697 →					
E 280 4-matic (211.092)	Petrol	170	01/06 → 12/08						
E 280 4-matic (211.092)	Petrol	170	01/06 → 12/08						
E 280 4-matic (211.092)	Petrol	170	06/06 → 12/08	ENGINE: 30417697 →					
E 280 CDI (211.020)	Diesel	140	03/05 → 10/05	ENGINE: → 40086332					
E 280 CDI (211.023)	Diesel	130	05/04 → 12/08						
E 280 CDI (211.023)	Diesel	130	05/04 → 12/08						
E 280 CDI (211.023)	Diesel	130	05/04 → 12/08						
E 280 CDI 4-matic	Diesel	140	03/05 → 10/05	ENGINE: → 40086332					
E 300 BlueTEC	Diesel	155	09/07 → 12/08						
E 320 (211.065)	Petrol	165	03/02 → 12/08						
E 320 (211.065)	Petrol	165	03/02 → 12/08						
E 320 (211.065)	Petrol	165	03/02 → 12/08						
E 320 (211.065)	Petrol	165	03/02 → 07/04						
E 320 4-matic (211.082)	Petrol	165	03/03 → 12/08						
E 320 4-matic (211.082)	Petrol	165	03/03 → 12/08						
E 320 4-matic (211.082)	Petrol	165	03/03 → 12/08						
E 320 4-matic (211.082)	Petrol	165	08/03 → 07/04						
E 320 4-matic (211.082)	Petrol	165	09/03 → 03/05						
E 320 CDI (211.022)	Diesel	165	03/05 → 10/05	ENGINE: → 40086332					
E 320 CDI (211.026)	Diesel	150	11/02 → 12/08						
E 320 CDI (211.026)	Diesel	150	11/02 → 12/08						
E 320 CDI (211.026)	Diesel	150	11/02 → 12/08						
E 320 CDI 4-matic	Diesel	165	03/05 → 12/08						
E 350 (211.056)	Petrol	200	03/05 → 12/08						
E 350 (211.056)	Petrol	200	03/05 → 12/08						
E 350 (211.056)	Petrol	200	06/06 → 12/08	ENGINE: 30417697 →					
E 350 4-matic	Petrol	205	08/04 → 08/06						
E 350 4-matic (211.087)	Petrol	200	03/05 → 12/08						
E 350 4-matic (211.087)	Petrol	200	03/05 → 12/08						
E 350 4-matic (211.087)	Petrol	200	06/06 → 12/08	ENGINE: 30417697 →					
E 350 CGI (211.057)	Petrol	215	09/07 → 12/08						
E 400 CDI (211.028)	Diesel	191	02/03 → 12/08	ENGINE: 40004860 →					
E 400 CDI (211.028)	Diesel	191	02/03 → 12/08						
E 400 CDI (211.028)	Diesel	191	02/03 → 12/08						
E 400 CDI (211.028)	Diesel	191	02/03 → 12/08						
E 420 CDI (211.029)	Diesel	231	01/06 → 12/08						
E 500 (211.070)	Petrol	225	03/02 → 12/08						
E 500 (211.070)	Petrol	225	03/02 → 12/08						
E 500 (211.070)	Petrol	225	03/02 → 12/08						

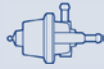

TYPE



TYPE



TYPE

								SAC012	H2		
								SAG023-1	H1		
								SAC012	H2	BAE680CR	
								SAD028	H3		
										BAE680CQ	
								SAC012	H2	BAE680CR	
								SAD028	H3		
										BAE680CQ	
								SAC012	H2		
								SAC012	H2		
								SAG023	H1		
								SAG023-1	H1		
								SAC012	H2		
								SAC012	H2		
	APS33		SPA163		F1			SAD018	H3	BAE680CX	
								SAG023	H1		
								SAG023-1	H1		
								SAC012	H2		
	APS33		SPA163		F1			SAD018	H3		
								SAG023	H1		
								SAG023-1	H1		
								SAC012	H2		
										BAE680CX	
								SAC012	H2		
			ATS21		F2			SAC012	H2		
			SPA163		F1			SAG023	H1		
								SAG023-1	H1		
								SAC012	H2		
								SAC012	H2	BAE680CR	
								SAD028	H3		
										BAE680CQ	
										BAE680CR	
								SAC012	H2	BAE680CR	
								SAD028	H3		
										BAE680CQ	
								SAC012	H2	BAE680CR	
	APS33										
			ATS21		F2			SAC012	H2		
			SPA163		F1			SAG023	H1		
								SAG023-1	H1		
								SAC012	H2		
	APS33		SPA163		F1			SAD018	H3	BAE680CX	
								SAG023	H1		
								SAG023-1	H1		



KW



TYPE



TYPE

MERCEDES-BENZ

CLASSE E (W211)

E 500 (211.070)	Petrol	225	03/02 → 06/05						
E 500 (211.072)	Petrol	285	04/06 → 12/08						
E 500 (211.072)	Petrol	285	04/06 → 12/08						
E 500 (211.072)	Petrol	285	06/06 → 12/08	ENGINE: 30061424 →					
E 500 4-matic (211.083)	Petrol	225	10/03 → 12/08						
E 500 4-matic (211.083)	Petrol	225	10/03 → 12/08						
E 500 4-matic (211.083)	Petrol	225	10/03 → 12/08						
E 500 4-matic (211.083)	Petrol	225	10/03 → 12/06						
E 500 4-matic (211.090)	Petrol	285	04/06 → 12/08						
E 500 4-matic (211.090)	Petrol	285	04/06 → 12/08						
E 500 4-matic (211.090)	Petrol	285	06/06 → 12/08	ENGINE: 30061424 →					
E 55 AMG Kompressor (211.076)	Petrol	350	10/02 → 12/08						
E 55 AMG Kompressor (211.076)	Petrol	350	10/02 → 12/08						
E 55 AMG Kompressor (211.076)	Petrol	350	10/02 → 12/08						
E 55 AMG Kompressor (211.076)	Petrol	350	10/02 → 07/06						
E 63 AMG (211.077, 211.177)	Petrol	378	03/06 → 12/08						
E 63 AMG (211.077, 211.177)	Petrol	378	08/06 → 12/08						

CLASSE E (W212)

E 200 CDI / BlueTEC (212.005, 212.006)	Diesel	100	01/09 →						
E 200 CDI / BlueTEC (212.005, 212.006)	Diesel	100	01/09 →						
E 200 CDI / BlueTEC (212.005, 212.006)	Diesel	100	01/09 →						
E 200 CDI / BlueTEC (212.005, 212.006)	Diesel	100	01/09 →						
E 200 CDI / BlueTEC (212.005, 212.006)	Diesel	100	01/09 →						
E 200 CDI / BlueTEC (212.005, 212.006)	Diesel	100	01/09 →						
E 200 CGI (212.048, 212.148)	Petrol	135	08/09 →						
E 200 CGI (212.048, 212.148)	Petrol	135	08/09 →						
E 200 NGT (212.041)	BiFuel	120	03/11 →						
E 200 NGT (212.041)	BiFuel	120	03/11 →						
E 200 NGT (212.041)	BiFuel	120	03/11 →						
E 220 CDI / BlueTEC (212.001, 212.002)	Diesel	125	01/09 →						
E 220 CDI / BlueTEC (212.001, 212.002)	Diesel	125	01/09 →						
E 220 CDI / BlueTEC (212.001, 212.002)	Diesel	125	01/09 →						
E 220 CDI / BlueTEC (212.001, 212.002)	Diesel	125	01/09 →						

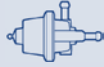

TYPE



TYPE



TYPE

							SAC012	H2			
							SAC012	H2			
							SAD028	H3			
									BAE680CQ		
							SAD018	H3	BAE680CX		
							SAG023	H1			
							SAG023-1	H1			
							SAC012	H2			
							SAC012	H2			
							SAD028	H3			
									BAE680CQ		
	APS33		ATS21	F2			SAD018	H3	BAE680CX		
			SPA163	F1			SAG023	H1			
							SAG023-1	H1			
							SAC012	H2			
							SAD028	H3	BAE680DF		
							SAC012	H2			
							SAG023	H1		GA2165	J2
							SAG023-1	H1		GA2166	J2
										GA2167	J2
										GA2168	J2
										SUA569	J3
										SUA570	J3
							SAC012	H2		GA2142	J2
										SUA566	J3
							SAC012	H2			
							SAG023	H1			
							SAG023-1	H1			
							SAG023	H1		GA2165	J2
							SAG023-1	H1		GA2166	J2
										GA2167	J2
										GA2168	J2



KW



TYPE



TYPE

MERCEDES-BENZ

CLASSE E (W212)

E 220 CDI / BlueTEC (212.001, 212.002)	Diesel	125	01/09 →						
E 220 CDI / BlueTEC (212.001, 212.002)	Diesel	125	01/09 →						
E 250 CDI / BlueTEC (212.003, 212.004)	Diesel	150	01/09 →						
E 250 CDI / BlueTEC (212.003, 212.004)	Diesel	150	01/09 →						
E 250 CDI / BlueTEC (212.003, 212.004)	Diesel	150	01/09 →						
E 250 CDI / BlueTEC (212.003, 212.004)	Diesel	150	01/09 →						
E 250 CDI / BlueTEC (212.003, 212.004)	Diesel	150	01/09 →						
E 250 CGI (212.047, 212.147)	Petrol	150	01/09 →						
E 250 CGI (212.047, 212.147)	Petrol	150	01/09 →						
E 300 (212.054)	Petrol	170	01/09 →						
E 300 (212.055)	Petrol	185	07/11 →						
E 300 CDI (212.020)	Diesel	150	03/11 →						
E 300 CDI / BlueTEC (212.020, 212.021)	Diesel	170	03/11 →						
E 350 4-matic (212.087)	Petrol	200	01/09 → 08/11						
E 350 BlueTEC (212.024)	Diesel	155	01/09 →						
E 350 BlueTEC (212.024)	Diesel	155	01/09 →						
E 350 BlueTEC (212.024)	Diesel	155	01/09 →						
E 350 BlueTEC (212.024)	Diesel	155	01/09 →						
E 350 BlueTEC (212.024)	Diesel	155	01/09 →						
E 350 BlueTEC (212.024)	Diesel	155	01/09 →						
E 350 CDI (212.023)	Diesel	195	03/11 →						
E 350 CDI (212.025)	Diesel	170	01/09 →						
E 350 CDI (212.025)	Diesel	170	01/09 →						
E 350 CDI (212.025)	Diesel	170	01/09 →						
E 350 CDI (212.025)	Diesel	170	01/09 →						
E 350 CDI (212.025)	Diesel	170	01/09 →						
E 350 CDI 4-matic (212.089)	Diesel	170	09/09 →						
E 350 CDI 4-matic (212.089)	Diesel	170	09/09 →						
E 350 CDI 4-matic (212.089)	Diesel	170	09/09 →						
E 350 CDI 4-matic (212.089)	Diesel	170	09/09 →						
E 350 CDI 4-matic (212.089)	Diesel	170	09/09 →						
E 350 CDI 4-matic (212.089)	Diesel	170	09/09 →						
E 350 CDI 4-matic (212.093)	Diesel	195	03/11 →						

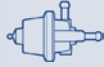

TYPE



TYPE



TYPE

									SUA569	J3
									SUA570	J3
							SAG023	H1	GA2165	J2
							SAG023-1	H1	GA2166	J2
									GA2167	J2
									GA2168	J2
									SUA569	J3
									SUA570	J3
							SAC012	H2	GA2142	J2
							SAC012	H2	SUA566	J3
							SAC012	H2	BAE680CX	
							SAC012	H2		
							SAC012	H2		
							SAC012	H2	BAE680CQ	
							SAC012	H2	GA2165	J2
									GA2166	J2
									GA2167	J2
									GA2168	J2
									SUA569	J3
									SUA570	J3
							SAC012	H2		
							SAC012	H2	GA2165	J2
									GA2166	J2
									GA2167	J2
									GA2168	J2
									SUA569	J3
									SUA570	J3
							SAC012	H2	GA2165	J2
									GA2166	J2
									GA2167	J2
									GA2168	J2
									SUA569	J3
									SUA570	J3
							SAC012	H2		



KW

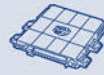

TYPE



TYPE

MERCEDES-BENZ

CLASSE E (W212)

E 350 CGI (212.057)	Petrol	215	01/09 → 08/11						
E 500 (212.072)	Petrol	285	01/09 →						
E 500 4-matic (212.090)	Petrol	285	01/09 →						
E 63 AMG (212.077)	Petrol	386	12/09 →						

CLASSE E Cabriolet (A124)

E 320 (124.066)	Petrol	162	06/93 → 03/98						
E 320 (124.066)	Petrol	162	06/93 → 03/98	ENGINE: 004357 →					
E 320 (124.066)	Petrol	162	06/93 → 03/98						
E 320 (124.066)	Petrol	162	06/93 → 03/98	ENGINE: M104992					
E 320 (124.066)	Petrol	162	09/94 → 03/98						
E 36 AMG (124.066)	Petrol	200	05/94 → 03/98						
E 36 AMG (124.066)	Petrol	200	05/94 → 03/98	ENGINE: 004357 →					
E 36 AMG (124.066)	Petrol	200	05/94 → 03/98						
E 36 AMG (124.066)	Petrol	200	05/94 → 03/98	CHASSIS: → C226335					
E 36 AMG (124.066)	Petrol	200	09/94 → 03/98						

CLASSE E Cabriolet (A207)

E 200 CGI (207.448)	Petrol	135	01/10 →						
E 200 CGI (207.448)	Petrol	135	01/10 →						
E 250 CGI (207.447)	Petrol	150	01/10 →						
E 250 CGI (207.447)	Petrol	150	01/10 →						
E 350 CDI	Diesel	195	04/11 →						
E 350 CDI (207.422)	Diesel	170	01/10 →						
E 350 CGI (207.457)	Petrol	215	01/10 →						
E 500 (207.472)	Petrol	285	01/10 →						

CLASSE E Coupé (C124)

E 220 (124.042)	Petrol	110	07/93 → 06/97						
E 220 (124.042)	Petrol	110	06/93 → 06/97	CHASSIS: C226336 →					
E 320 (124.052)	Petrol	162	07/93 → 06/97						
E 320 (124.052)	Petrol	162	06/93 → 06/97	ENGINE: 004357 →					
E 320 (124.052)	Petrol	162	06/93 → 06/97						
E 320 (124.052)	Petrol	162	06/93 → 06/97	CHASSIS: → C226335					
E 320 (124.052)	Petrol	162	09/94 → 06/97						
E 36 AMG (124.052)	Petrol	195	06/93 → 02/94						
E 36 AMG (124.052)	Petrol	200	05/94 → 06/96						
E 36 AMG (124.052)	Petrol	200	05/94 → 06/97	ENGINE: 004357 →					
E 36 AMG (124.052)	Petrol	200	05/94 → 06/97						
E 36 AMG (124.052)	Petrol	200	05/94 → 06/97						
E 36 AMG (124.052)	Petrol	195	06/93 → 02/94	CHASSIS: → C226335					
E 36 AMG (124.052)	Petrol	200	05/94 → 06/96	CHASSIS: → C226335					
E 36 AMG (124.052)	Petrol	200	09/94 → 06/97						



KW



TYPE



TYPE

MERCEDES-BENZ

CLASSE E Coupé (C207)

E 200 CGI (207.348)	Petrol	135	01/10 →						
E 200 CGI (207.348)	Petrol	135	01/10 →						
E 220 CDI (207.302)	Diesel	125	01/10 →						
E 250 CDI (207.303)	Diesel	150	01/09 →						
E 250 CGI (207.347)	Petrol	150	01/09 →						
E 250 CGI (207.347)	Petrol	150	01/09 →						
E 350	Petrol	200	05/11 →						
E 350 CDI	Diesel	195	04/11 →						
E 350 CDI (207.322)	Diesel	170	01/09 →						
E 350 CGI (207.357)	Petrol	215	01/09 →						
E 500 (207.372)	Petrol	285	01/09 →						

CLASSE E Station wagon (S124)

E 200 T (124.079)	Petrol	100	07/93 → 05/96						
E 200 T (124.079)	Petrol	100	06/93 → 06/96	ENGINE: 028683 →					
E 200 T (124.079)	Petrol	100	06/93 → 05/96						
E 220 T (124.082)	Petrol	110	07/93 → 05/96						
E 220 T (124.082)	Petrol	110	06/93 → 06/96	ENGINE: 079784 →					
E 220 T (124.082)	Petrol	110	06/93 → 06/96						
E 220 T (124.082)	Petrol	110	06/93 → 05/96						
E 280 T (124.088)	Petrol	142	07/93 → 05/96						
E 280 T (124.088)	Petrol	142	06/93 → 06/96	ENGINE: 048697 →					
E 280 T (124.088)	Petrol	142	06/93 → 06/96						
E 280 T (124.088)	Petrol	142	06/93 → 05/96						
E 280 T (124.088)	Petrol	142	09/94 → 06/96						
E 280 T (124.088)	Petrol	145	07/93 → 05/96						
E 280 T (124.088)	Petrol	145	06/93 → 06/96	ENGINE: 048697 →					
E 280 T (124.088)	Petrol	145	06/93 → 06/96						
E 280 T (124.088)	Petrol	145	06/93 → 05/96						
E 280 T (124.088)	Petrol	145	09/94 → 06/96						
E 300 T 4-matic (124.290)	Petrol	132	06/93 → 06/96	ENGINE: 002188 →, 008268 →					
E 300 T 4-matic (124.290)	Petrol	132	06/93 → 06/95						
E 300 T 4-matic (124.290)	Petrol	132	09/94 → 06/96						
E 300 TD (124.191)	Diesel	100	06/93 → 06/96						
E 300 TE-24 AMG (124.091)	Petrol	162	09/94 → 06/96						
E 320 T (124.092)	Petrol	162	07/93 → 05/96						
E 320 T (124.092)	Petrol	162	06/93 → 06/96	ENGINE: 072237 →					
E 320 T (124.092)	Petrol	162	06/93 → 06/96						
E 320 T (124.092)	Petrol	162	06/93 → 05/96						
E 320 T (124.092)	Petrol	162	09/94 → 06/96						
E 36 T AMG (124.092)	Petrol	200	05/94 → 05/96						
E 36 T AMG (124.092)	Petrol	200	05/94 → 06/96	ENGINE: 072237 →					
E 36 T AMG (124.092)	Petrol	200	05/94 → 06/96						
E 36 T AMG (124.092)	Petrol	200	05/94 → 05/96						
E 36 T AMG (124.092)	Petrol	200	09/94 → 06/96						



						SAC012	H2	GA2142	J2
								SUA566	J3
								GA2203	J2
								GA2203	J2
						SAC012	H2	GA2142	J2
								SUA566	J3
						SAC012	H2		
						SAC012	H2		
						SAC012	H2	GA2203	J2
						SAC012	H2	BAE680CR	
								BAE680CQ	
			RP01A						
				ATS21	F2				
								ESS528	J1
			RP01A						
				ATS21	F2				
						SAC043	H2		
								ESS528	J1
			RP01A						
				ATS21	F2				
						SAC043	H2		
								ESS528	J1
								PI027	J1
			RP01A						
				ATS21	F2				
						SAC043	H2		
								ESS528	J1
								PI027	J1
			RP01A						
				ATS21	F2				
						SAC043	H2		
								ESS528	J1
								PI027	J1
			RP01A						
				ATS21	F2				
						SAC043	H2		
								ESS528	J1
								PI027	J1



KW



TYPE



TYPE

MERCEDES-BENZ

CLASSE E Station wagon (S210)

E 200 T (210.235)	Petrol	100	06/96 → 08/00						
E 200 T (210.235)	Petrol	100	06/96 → 08/00						
E 200 T (210.235)	Petrol	100	06/96 → 08/00						
E 200 T (210.235)	Petrol	100	06/96 → 06/98						
E 200 T Kompressor (210.245)	Petrol	137	09/97 → 01/03						
E 200 T Kompressor (210.245)	Petrol	137	06/97 → 03/03						
E 200 T Kompressor (210.245)	Petrol	137	06/97 → 03/03						
E 200 T Kompressor (210.245)	Petrol	137	06/97 → 03/03						
E 200 T Kompressor (210.248)	Petrol	120	08/00 → 03/03						
E 200 T Kompressor (210.248)	Petrol	120	08/00 → 03/03						
E 220 T CDI (210.206)	Diesel	105	07/99 → 03/03						
E 220 T CDI (210.206)	Diesel	92	06/98 → 07/99						
E 220 T CDI (210.206)	Diesel	92	06/98 → 07/99						
E 220 T CDI (210.206)	Diesel	105	07/99 → 03/03	ENGINE: 30121322 →					
E 220 T CDI (210.206)	Diesel	105	07/99 → 03/03	ENGINE: 30121322 →					
E 220 T CDI (210.206)	Diesel	92	06/98 → 07/99	ENGINE: 30121322 →					
E 220 T CDI (210.206)	Diesel	92	06/98 → 07/99	ENGINE: 30121322 →					
E 230 T (210.237)	Petrol	110	06/96 → 06/97						
E 230 T (210.237)	Petrol	110	06/96 → 06/97						
E 240 T (210.261)	Petrol	125	06/97 → 03/03						
E 240 T (210.261)	Petrol	125	06/97 → 03/03	ENGINE: 30370999 →					
E 240 T (210.261)	Petrol	125	06/97 → 03/03	ENGINE: 30370999 →					
E 240 T (210.261)	Petrol	125	10/97 → 03/03						
E 240 T (210.261)	Petrol	125	09/97 → 01/03						
E 240 T (210.262)	Petrol	125	08/00 → 03/03						
E 240 T (210.262)	Petrol	125	08/00 → 03/03						
E 240 T (210.262)	Petrol	125	08/00 → 03/03						
E 240 T (210.262)	Petrol	125	08/00 → 03/03						
E 240 T (210.262)	Petrol	125	08/00 → 01/03						
E 250 T Turbo-D (210.215)	Diesel	110	06/97 → 07/99						
E 270 T CDI (210.216)	Diesel	125	07/99 → 03/03						
E 270 T CDI (210.216)	Diesel	125	07/99 → 03/03						
E 270 T CDI (210.216)	Diesel	125	07/99 → 03/03						
E 280 T (210.263)	Petrol	150	12/96 → 03/03						
E 280 T (210.263)	Petrol	150	12/96 → 03/03	ENGINE: 30370999 →					
E 280 T (210.263)	Petrol	150	12/96 → 03/03	ENGINE: 30370999 →					
E 280 T (210.263)	Petrol	150	11/97 → 03/03						
E 280 T (210.263)	Petrol	150	12/96 → 01/03						
E 290 T Turbo-D (210.217)	Diesel	95	06/96 → 07/99						
E 320 T CDI (210.226)	Diesel	145	07/99 → 03/03						
E 320 T CDI (210.226)	Diesel	145	07/99 → 03/03						
E 320 T CDI (210.226)	Diesel	145	07/99 → 03/03						
E 420 T (210.272)	Petrol	205	06/96 → 06/97						
E 420 T (210.272)	Petrol	205	06/96 → 06/97						



TYPE

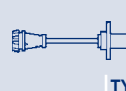

TYPE



TYPE

			RP01A	ATS21	F2		SAC016	H2		ESS528	J1
							SAG023	H1			
							SAG023-1	H1			
							SAG146	H1			
			RP01A								
							SAC016	H2			
							SAG023	H1			
							SAG023-1	H1			
				ATS21	F2		SAG023	H1			
							SAG023-1	H1			
				SPA163	F1		SAC012	H2			
				ATS21	F2		SAC012	H2			
				SPA163	F1						
							SAG023	H1			
							SAG023-1	H1			
							SAG023	H1			
							SAG023-1	H1			
			RP01A	ATS21	F2		SAC016	H2		ESS528	J1
							SAG146	H1			
				SPA163	F1		SAD018	H3		PI027	J1
							SAG023	H1			
							SAG023-1	H1			
							SAC012	H2			
										BAE680CX	
		APS33		SPA163	F1		SAC012	H2		PI027	J1
							SAD018	H3			
							SAG023	H1			
							SAG023-1	H1			
										BAE680CX	
				ATS21	F2		SAG146	H1			
				ATS21	F2		SAC012	H2			
				SPA163	F1		SAG023	H1			
							SAG023-1	H1			
				SPA163	F1		SAD018	H3		PI027	J1
							SAG023	H1			
							SAG023-1	H1			
							SAC012	H2			
										BAE680CX	
				ATS21	F2		SAG146	H1			
				ATS21	F2		SAC012	H2			
				SPA163	F1		SAG023	H1			
							SAG023-1	H1			
			RP01A	ATS21	F2		SAC012	H2		PI027	J1
							SAD018	H3			



KW

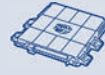

TYPE



TYPE

MERCEDES-BENZ

CLASSE E Station wagon (S210)

E 420 T (210.272)	Petrol	205	06/96 → 06/97						
E 430 T (210.270)	Petrol	205	01/01 → 03/03						
E 430 T (210.270)	Petrol	205	06/97 → 03/03						
E 430 T (210.270)	Petrol	205	06/97 → 03/03	ENGINE: 30039710 →					
E 430 T (210.270)	Petrol	205	06/97 → 03/03	ENGINE: 30039710 →					
E 430 T (210.270)	Petrol	205	11/97 → 03/03						
E 430 T 4-matic (210.283)	Petrol	205	01/01 → 03/03						
E 430 T 4-matic (210.283)	Petrol	205	05/99 → 03/03						
E 430 T 4-matic (210.283)	Petrol	205	05/99 → 03/03	ENGINE: 30039710 →					
E 430 T 4-matic (210.283)	Petrol	205	05/99 → 03/03	ENGINE: 30039710 →					
E 430 T 4-matic (210.283)	Petrol	205	09/99 → 03/03						
E 430 T 4-matic (210.283)	Petrol	205	05/99 → 01/03						
E 55 T AMG (210.274)	Petrol	260	01/01 → 03/03						
E 55 T AMG (210.274)	Petrol	260	08/97 → 03/03						
E 55 T AMG (210.274)	Petrol	260	08/97 → 03/03	ENGINE: 60002693 →					
E 55 T AMG (210.274)	Petrol	260	08/97 → 03/03	ENGINE: 60002693 →					
E 55 T AMG (210.274)	Petrol	260	11/97 → 03/03						
E 55 T AMG 4-matic (210.283)	Petrol	260	03/01 → 03/03						
E 55 T AMG 4-matic (210.283)	Petrol	260	03/01 → 03/03	ENGINE: 60002693 →					
E 55 T AMG 4-matic (210.283)	Petrol	260	03/01 → 03/03	ENGINE: 60002693 →					

CLASSE E T-Model (S211)

350 CGI (211.257)	Petrol	215	05/06 → 07/09						
E 200 CDI (211.207)	Diesel	100	04/06 → 07/09						
E 200 CDI (211.207)	Diesel	100	04/06 → 07/09						
E 200 CDI (211.207)	Diesel	100	04/06 → 07/09						
E 200 Kompressor (211.241)	Petrol	135	04/06 → 07/09						
E 200 Kompressor (211.241)	Petrol	135	04/06 → 07/09						
E 200 Kompressor (211.241)	Petrol	135	04/06 → 07/09						
E 200 T Kompressor (211.242)	Petrol	120	03/03 → 07/09						
E 200 T Kompressor (211.242)	Petrol	120	03/03 → 07/09						
E 200 T Kompressor (211.242)	Petrol	120	03/03 → 07/06						
E 220 CDI (211.206)	Diesel	100	03/03 → 07/09						
E 220 CDI (211.206)	Diesel	100	03/03 → 07/09						
E 220 CDI (211.206)	Diesel	100	03/03 → 11/05	ENGINE: → 30497543					
E 220 T CDI	Diesel	120	03/03 → 07/09						
E 220 T CDI (211.206)	Diesel	110	03/03 → 07/09						
E 220 T CDI (211.206)	Diesel	110	03/03 → 07/09						
E 220 T CDI (211.206)	Diesel	110	03/03 → 11/05	ENGINE: → 30497543					
E 220 T CDI (211.208)	Diesel	125	04/06 → 07/09						
E 220 T CDI (211.208)	Diesel	125	04/06 → 07/09						
E 220 T CDI (211.208)	Diesel	125	04/06 → 07/09						
E 230 T (211.252)	Petrol	150	05/07 → 07/09						
E 240 T (211.261)	Petrol	130	03/03 → 07/09						
E 240 T (211.261)	Petrol	130	03/03 → 07/09						

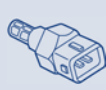
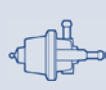

TYPE

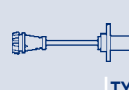

TYPE



TYPE

						SAG146	H1			
	APS33									
		SPA163	F1			SAD018	H3	BAE680CX	PI027	J1
						SAG023	H1			
						SAG023-1	H1			
						SAC012	H2			
	APS33									
		SPA163	F1			SAD018	H3		PI027	J1
						SAG023	H1			
						SAG023-1	H1			
						SAC012	H2			
								BAE680CX		
	APS33									
		SPA163	F1			SAD018	H3	BAE680CX	PI027	J1
						SAG023	H1			
						SAG023-1	H1			
						SAC012	H2			
	APS33	SPA163	F1			SAC012	H2		PI027	J1
						SAG023	H1			
						SAG023-1	H1			
						SAC012	H2			
						SAC012	H2			
						SAG023	H1			
						SAG023-1	H1			
		ATS21	F2			SAG023	H1			
		SPA163	F1			SAG023-1	H1			
						SAC012	H2			
						SAG023	H1			
						SAG023-1	H1			
						SAC012	H2			
						SAC012	H2			
		ATS21	F2			SAG023	H1			
		SPA163	F1			SAG023-1	H1			
						SAC012	H2			
						SAC012	H2			
						SAG023	H1			
						SAG023-1	H1			
						SAC012	H2			
						SAC012	H2			
						SAG023	H1			
						SAG023-1	H1			
						SAC012	H2	BAE680CQ		
	APS33	SPA163	F1			SAD018	H3			
						SAG023	H1			



KW



TYPE



TYPE

MERCEDES-BENZ

CLASSE E T-Model (S211)

E 240 T (211.261)	Petrol	130	03/03 → 07/09						
E 240 T (211.261)	Petrol	130	06/03 → 07/09						
E 240 T (211.261)	Petrol	130	03/03 → 03/05						
E 240 T 4-matic (211.280)	Petrol	130	07/03 → 07/09						
E 240 T 4-matic (211.280)	Petrol	130	07/03 → 07/09						
E 240 T 4-matic (211.280)	Petrol	130	07/03 → 07/09						
E 240 T 4-matic (211.280)	Petrol	130	07/03 → 07/09						
E 240 T 4-matic (211.280)	Petrol	130	09/03 → 07/09						
E 270 T CDI (211.216)	Diesel	130	03/03 → 07/09						
E 270 T CDI (211.216)	Diesel	130	03/03 → 07/09						
E 270 T CDI (211.216)	Diesel	130	03/03 → 07/09						
E 280 T (211.254)	Petrol	170	03/05 → 07/09						
E 280 T (211.254)	Petrol	170	03/05 → 07/09						
E 280 T (211.254)	Petrol	170	06/06 → 07/09	ENGINE: 30417697 →					
E 280 T 4-matic (211.292)	Petrol	170	03/05 → 07/09						
E 280 T 4-matic (211.292)	Petrol	170	03/05 → 07/09						
E 280 T 4-matic (211.292)	Petrol	170	06/06 → 07/09	ENGINE: 30417697 →					
E 280 T CDI (211.220)	Diesel	140	03/05 → 10/05	ENGINE: → 40086332					
E 280 T CDI (211.223)	Diesel	130	05/04 → 07/09						
E 280 T CDI (211.223)	Diesel	130	05/04 → 07/09						
E 280 T CDI (211.223)	Diesel	130	05/04 → 07/09						
E 280 T CDI 4-matic (211.284)	Diesel	140	03/05 → 10/05	ENGINE: → 40086332					
E 320 T (211.265)	Petrol	165	03/03 → 07/09						
E 320 T (211.265)	Petrol	165	03/03 → 07/09						
E 320 T (211.265)	Petrol	165	03/03 → 07/09						
E 320 T (211.265)	Petrol	165	03/03 → 07/09						
E 320 T 4-matic (211.282)	Petrol	165	07/03 → 07/09						
E 320 T 4-matic (211.282)	Petrol	165	07/03 → 07/09						
E 320 T 4-matic (211.282)	Petrol	165	07/03 → 07/09						
E 320 T 4-matic (211.282)	Petrol	165	07/03 → 07/09						
E 320 T 4-matic (211.282)	Petrol	165	09/03 → 03/05						
E 320 T CDI (211.222)	Diesel	165	03/05 → 10/05	ENGINE: → 40086332					
E 320 T CDI (211.226)	Diesel	150	03/03 → 07/09						
E 320 T CDI (211.226)	Diesel	150	03/03 → 07/09						
E 320 T CDI (211.226)	Diesel	150	03/03 → 07/09						
E 320 T CDI 4-matic (211.289)	Diesel	165	03/05 → 10/05	ENGINE: → 40086332					
E 350 T (211.256)	Petrol	200	03/05 → 07/09						
E 350 T (211.256)	Petrol	200	06/06 → 07/09	ENGINE: 30417697 →					
E 350 T 4-matic (211.287)	Petrol	200	03/05 → 07/09						
E 350 T 4-matic (211.287)	Petrol	200	06/06 → 07/09	ENGINE: 30417697 →					
E 500 T (211.270)	Petrol	225	10/03 → 07/09						
E 500 T (211.270)	Petrol	225	10/03 → 07/09						
E 500 T (211.270)	Petrol	225	10/03 → 07/09						
E 500 T (211.270)	Petrol	225	10/03 → 07/09						



TYPE

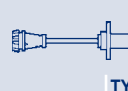

TYPE



TYPE

						SAG023-1	H1		
						SAC012	H2		
								BAE680CX	
	APS33					SAC012	H2		
						SAD018	H3		
						SAG023	H1		
						SAG023-1	H1		
								BAE680CX	
			ATS21	F2		SAC012	H2		
			SPA163	F1		SAG023	H1		
						SAG023-1	H1		
						SAD028	H3	BAE680CR	
						SAC012	H2		
								BAE680CQ	
						SAC012	H2	BAE680CR	
						SAD028	H3		
								BAE680CQ	
						SAC012	H2		
						SAC012	H2		
						SAG023	H1		
						SAG023-1	H1		
						SAC012	H2		
	APS33		SPA163	F1		SAC012	H2	BAE680CX	
						SAD018	H3		
						SAG023	H1		
						SAG023-1	H1		
	APS33					SAC012	H2		
						SAD018	H3		
						SAG023	H1		
						SAG023-1	H1		
								BAE680CX	
						SAC012	H2		
			ATS21	F2		SAC012	H2		
			SPA163	F1		SAG023	H1		
						SAG023-1	H1		
						SAC012	H2		
						SAC012	H2	BAE680CR	
								BAE680CQ	
						SAC012	H2	BAE680CR	
								BAE680CQ	
	APS33		SPA163	F1		SAC012	H2		
						SAD018	H3		
						SAG023	H1		
						SAG023-1	H1		



KW



TYPE



TYPE

MERCEDES-BENZ

CLASSE E T-Model (S211)

E 500 T (211.270)	Petrol	225	10/03 → 03/06					
E 500 T (211.272)	Petrol	285	04/06 → 07/09					
E 500 T (211.272)	Petrol	285	04/06 → 07/09					
E 500 T (211.272)	Petrol	285	06/06 → 07/09	ENGINE: 30061424 →				
E 500 T 4-matic (211.283)	Petrol	225	10/03 → 07/09					
E 500 T 4-matic (211.283)	Petrol	225	10/03 → 07/09					
E 500 T 4-matic (211.283)	Petrol	225	10/03 → 07/09					
E 500 T 4-matic (211.283)	Petrol	225	10/03 → 07/09					
E 500 T 4-matic (211.290)	Petrol	285	04/06 → 07/09					
E 500 T 4-matic (211.290)	Petrol	285	04/06 → 07/09					
E 500 T 4-matic (211.290)	Petrol	285	06/06 → 07/09	ENGINE: 30061424 →				
E 55 T AMG Kompressor (211.276)	Petrol	350	07/03 → 07/09					
E 55 T AMG Kompressor (211.276)	Petrol	350	07/03 → 07/09					
E 55 T AMG Kompressor (211.276)	Petrol	350	07/03 → 07/09					
E 55 T AMG Kompressor (211.276)	Petrol	350	07/03 → 07/09					
E 63 AMG (211.277)	Petrol	378	03/06 → 07/09					

CLASSE E T-Model (S212)

E 200 CDI / BlueTEC (212.205, 212.206)	Diesel	100	11/09 →					
E 200 CDI / BlueTEC (212.205, 212.206)	Diesel	100	11/09 →					
E 200 CDI / BlueTEC (212.205, 212.206)	Diesel	100	11/09 →					
E 200 CDI / BlueTEC (212.205, 212.206)	Diesel	100	11/09 →					
E 200 CDI / BlueTEC (212.205, 212.206)	Diesel	100	11/09 →					
E 200 CDI / BlueTEC (212.205, 212.206)	Diesel	100	11/09 →					
E 200 CGI (212.248)	Petrol	135	11/09 →					
E 200 CGI (212.248)	Petrol	135	11/09 →					
E 220 CDI / BlueTEC (212.202, 212.201)	Diesel	125	11/09 →					
E 220 CDI / BlueTEC (212.202, 212.201)	Diesel	125	11/09 →					
E 220 CDI / BlueTEC (212.202, 212.201)	Diesel	125	11/09 →					
E 220 CDI / BlueTEC (212.202, 212.201)	Diesel	125	11/09 →					

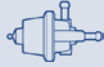

TYPE



TYPE



TYPE

								BAE680CX		
						SAC012	H2			
						SAD028	H3			
								BAE680CQ		
						SAC012	H2	BAE680CX		
						SAD018	H3			
						SAG023	H1			
						SAG023-1	H1			
						SAC012	H2			
						SAD028	H3			
								BAE680CQ		
	APS33		ATS21	F2		SAC012	H2	BAE680CX		
			SPA163	F1		SAD018	H3			
						SAG023	H1			
						SAG023-1	H1			
						SAD028	H3	BAE680DF		
						SAG023	H1		GA2165	J2
						SAG023-1	H1		GA2166	J2
									GA2167	J2
									GA2168	J2
									SUA569	J3
									SUA570	J3
						SAC012	H2		GA2142	J2
									SUA566	J3
						SAG023	H1		GA2165	J2
						SAG023-1	H1		GA2166	J2
									GA2167	J2
									GA2168	J2



KW



TYPE



TYPE

MERCEDES-BENZ

CLASSE E T-Model (S212)

E 220 CDI / BlueTEC (212.202, 212.201)	Diesel	125	11/09 →						
E 220 CDI / BlueTEC (212.202, 212.201)	Diesel	125	11/09 →						
E 250 CDI / BlueTEC (212.203, 212.204)	Diesel	150	11/09 →						
E 250 CDI / BlueTEC (212.203, 212.204)	Diesel	150	11/09 →						
E 250 CDI / BlueTEC (212.203, 212.204)	Diesel	150	11/09 →						
E 250 CDI / BlueTEC (212.203, 212.204)	Diesel	150	11/09 →						
E 250 CDI / BlueTEC (212.203, 212.204)	Diesel	150	11/09 →						
E 250 CDI / BlueTEC (212.203, 212.204)	Diesel	150	11/09 →						
E 250 CGI (212.247)	Petrol	150	11/09 →						
E 250 CGI (212.247)	Petrol	150	11/09 →						
E 300 CDI (212.220)	Diesel	150	03/11 →						
E 350 (212.256)	Petrol	200	08/09 →						
E 350 4-matic (212.287)	Petrol	200	11/09 →						
E 350 BlueTEC (212.224)	Diesel	155	11/09 →						
E 350 BlueTEC (212.224)	Diesel	155	11/09 →						
E 350 BlueTEC (212.224)	Diesel	155	11/09 →						
E 350 BlueTEC (212.224)	Diesel	155	11/09 →						
E 350 BlueTEC (212.224)	Diesel	155	11/09 →						
E 350 BlueTEC (212.224)	Diesel	155	11/09 →						
E 350 CDI (212.223)	Diesel	195	07/11 →						
E 350 CDI (212.225)	Diesel	170	11/09 →						
E 350 CDI (212.225)	Diesel	170	11/09 →						
E 350 CDI (212.225)	Diesel	170	11/09 →						
E 350 CDI (212.225)	Diesel	170	11/09 →						
E 350 CDI (212.225)	Diesel	170	11/09 →						
E 350 CDI 4-matic (212.289)	Diesel	170	11/09 →						
E 350 CDI 4-matic (212.289)	Diesel	170	11/09 →						
E 350 CDI 4-matic (212.289)	Diesel	170	11/09 →						
E 350 CDI 4-matic (212.289)	Diesel	170	11/09 →						
E 350 CDI 4-matic (212.289)	Diesel	170	11/09 →						
E 350 CDI 4-matic (212.289)	Diesel	170	11/09 →						
E 350 CDI 4-matic (212.293)	Diesel	195	07/11 →						
E 350 CGI (212.257)	Petrol	215	11/09 →						
E 500 (212.272)	Petrol	285	11/09 →						
E 63 AMG (212.277)	Petrol	386	08/09 →						

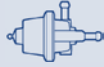

TYPE



TYPE



TYPE

								SUA569	J3
								SUA570	J3
						SAG023	H1	GA2165	J2
						SAG023-1	H1	GA2166	J2
								GA2167	J2
								GA2168	J2
								SUA569	J3
								SUA570	J3
						SAC012	H2	GA2142	J2
								SUA566	J3
						SAC012	H2		
						SAC012	H2		
						SAC012	H2	BAE680CQ	
						SAC012	H2	GA2165	J2
								GA2166	J2
								GA2167	J2
								GA2168	J2
								SUA569	J3
								SUA570	J3
						SAC012	H2		
						SAC012	H2	GA2165	J2
								GA2166	J2
								GA2167	J2
								GA2168	J2
								SUA569	J3
								SUA570	J3
						SAC012	H2	GA2165	J2
								GA2166	J2
								GA2167	J2
								GA2168	J2
								SUA569	J3
								SUA570	J3
						SAC012	H2		
						SAC012	H2	BAE680CR	
								BAE680CQ	
								BAE680DF	



KW



TYPE



TYPE

MERCEDES-BENZ

CLASSE G (W461)

230 GE (461)	Petrol	92	09/94 →					
230 GE (461.238, 461.239)	Petrol	90	02/93 →					
G 290 TD (461.335, 461.336)	Diesel	88	07/97 →					

CLASSE G (W463)

230 GE (463.224, 463.225)	Petrol	93	06/90 → 06/93					
300 GE (463.227, 463.228)	Petrol	125	06/90 →					
300 GE (463.227, 463.228)	Petrol	128	06/90 →					
G 270 CDI (463.322, 463.323)	Diesel	115	10/01 →					
G 270 CDI (463.322, 463.323)	Diesel	115	10/01 →					
G 270 CDI (463.322, 463.323)	Diesel	115	10/01 →					
G 320 (463.230, 463.231)	Petrol	155	09/94 → 11/97					
G 320 (463.230, 463.231)	Petrol	155	09/94 → 12/97	CHASSIS: 001163 →				
G 320 (463.230, 463.231)	Petrol	155	09/94 → 12/97					
G 320 (463.230, 463.231)	Petrol	155	09/94 → 12/97					
G 320 (463.232, 463.233, 463.244, 463.245)	Petrol	158	07/97 →					
G 320 (463.232, 463.233, 463.244, 463.245)	Petrol	158	07/97 →					
G 320 (463.232, 463.233, 463.244, 463.245)	Petrol	158	07/97 →					
G 320 (463.232, 463.233, 463.244, 463.245)	Petrol	158	07/97 → 11/97					
G 36 AMG (463.230)	Petrol	200	01/95 →					
G 36 AMG (463.230)	Petrol	200	01/95 →					
G 400 CDI (463.332, 463.333)	Diesel	184	12/00 →	ENGINE: 40004860 →				
G 400 CDI (463.332, 463.333)	Diesel	184	12/00 →					
G 400 CDI (463.332, 463.333)	Diesel	184	12/00 →					
G 400 CDI (463.332, 463.333)	Diesel	184	12/00 →					
G 500 (463.247, 463.248, 463.249, 463.240, 463.421)	Petrol	218	04/98 →					
G 500 (463.247, 463.248, 463.249, 463.240, 463.421)	Petrol	218	04/98 →					
G 500 (463.247, 463.248, 463.249, 463.240, 463.421)	Petrol	218	04/98 →					
G 500 (463.247, 463.248, 463.249, 463.240, 463.421)	Petrol	218	04/98 → 09/05					
G 500 E (463.228)	Petrol	177	09/93 →	ENGINE: 016683 →				
G 55 AMG (463.243, 463.246)	Petrol	260	01/01 →					
G 55 AMG (463.243, 463.246)	Petrol	260	04/99 →					
G 55 AMG (463.243, 463.246)	Petrol	260	04/99 →					
G 55 AMG (463.243, 463.246)	Petrol	260	04/99 → 03/04					
G 55 AMG (463.270, 463.271)	Petrol	350	06/04 →					
G 55 AMG (463.270, 463.271)	Petrol	350	06/04 →					
G 55 AMG (463.270, 463.271)	Petrol	350	06/04 →					

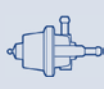

TYPE

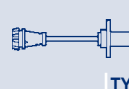

TYPE



TYPE

									PI027	J1
			SPA136	F1						
			ATS21	F2						
			SPA136	F1						
			SPA136	F1					PI027	J1
			SPA136	F1					PI027	J1
			ATS21	F2		SAC012	H2			
			SPA163	F1		SAG023	H1			
						SAG023-1	H1			
		RP01A								
			ATS21	F2						
						SAC043	H2		PI027	J1
						SAD033	H3			
	APS33		SPA163	F1		SAD018	H3		PI027	J1
						SAG023	H1			
						SAG023-1	H1			
								BAE680CX		
						SAC043	H2			
						SAD033	H3			
	APS33									
			ATS21	F2		SAC012	H2			
			SPA163	F1		SAG023	H1			
						SAG023-1	H1			
	APS33		SPA163	F1		SAD018	H3		PI027	J1
						SAG023	H1			
						SAG023-1	H1			
								BAE680CX		
			SPA136	F1						
	APS33									
			SPA163	F1		SAG023	H1			
						SAG023-1	H1			
								BAE680CX		
						SAD018	H3	BAE680CX		
						SAG023	H1			
						SAG023-1	H1			



KW

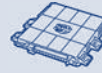

TYPE



TYPE

MERCEDES-BENZ

CLASSE G (W463)

G 55 AMG (463.270, 463.271)	Petrol	368	08/06 →						
G 55 AMG (463.270, 463.271)	Petrol	373	08/08 →						

CLASSE G Cabrio (W463)

230 GE (463.204)	Petrol	93	06/90 → 02/93						
300 GE (463.207)	Petrol	125	09/89 → 09/97						
320 GE (463.208)	Petrol	155	09/94 → 11/97						
320 GE (463.208)	Petrol	155	09/94 → 11/97	CHASSIS: 001163 →					
320 GE (463.208)	Petrol	155	09/94 → 11/97						
G 320 (463.209)	Petrol	158	11/97 →						
G 320 (463.209)	Petrol	158	11/97 →						
G 320 (463.209)	Petrol	158	11/97 →						
G 320 (463.209)	Petrol	158	12/97 → 08/06						
G 400 CDI (463.309)	Diesel	184	12/00 →	ENGINE: 40004860 →					
G 400 CDI (463.309)	Diesel	184	12/00 →						
G 400 CDI (463.309)	Diesel	184	12/00 →						
G 400 CDI (463.309)	Diesel	184	12/00 →						
G 500	Petrol	285	12/09 →						
G 500 (463)	Petrol	218	04/98 →						
G 500 (463)	Petrol	218	04/98 →						
G 500 (463)	Petrol	218	04/98 →						
G 500 (463)	Petrol	218	04/98 → 09/05						

CLASSE GL (X164)

GL 320 CDI / 350 BlueTEC 4-matic (164.824, 164.825)	Diesel	155	12/09 →						
GL 320 CDI 4-matic (164.822)	Diesel	165	09/06 → 05/09						
GL 350 CDI (164.823)	Diesel	195	10/10 →						
GL 350 CDI 4-matic (164.822)	Diesel	165	05/09 →						
GL 420 CDI 4-matic (164.828)	Diesel	225	09/06 → 05/09						
GL 450 4-matic (164.871)	Petrol	250	09/06 →						
GL 450 4-matic (164.871)	Petrol	250	09/06 →						
GL 450 CDI 4-matic (164.828)	Diesel	225	05/09 →						
GL 500 4-matic (164.886)	Petrol	285	09/06 →						
GL 500 4-matic (164.886)	Petrol	285	09/06 →						

CLASSE GLK (X204)

220 CDI (204.902)	Diesel	120	12/08 →						
220 CDI (204.902)	Diesel	120	12/08 →						
220 CDI (204.902)	Diesel	125	12/08 →						
220 CDI (204.902)	Diesel	125	12/08 →						
220 CDI 4-matic (204.984)	Diesel	120	12/08 →						
220 CDI 4-matic (204.984)	Diesel	120	12/08 →						
220 CDI 4-matic (204.984, 204.997)	Diesel	125	12/08 →						
220 CDI 4-matic (204.984, 204.997)	Diesel	125	12/08 →						

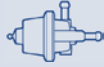

TYPE



TYPE



TYPE

								BAE680CX	
								BAE680CX	
			SPA136	F1					
			SPA136	F1					
		RP01A				SAC043	H2		
			ATS21	F2					
						SAD033	H3		
	APS33		SPA163	F1		SAD018	H3		
						SAG023	H1		
						SAG023-1	H1		
								BAE680CX	
	APS33								
			ATS21	F2		SAC012	H2		
			SPA163	F1		SAG023	H1		
						SAG023-1	H1		
								BAE680CQ	
	APS33		SPA163	F1		SAD018	H3		
						SAG023	H1		
						SAG023-1	H1		
								BAE680CX	
						SAC012	H2		
						SAC012	H2		
						SAC012	H2		
						SAC012	H2		
						SAC012	H2		
						SAC012	H2	BAE680CQ	
						SAD028	H3		
						SAC031	H2		
						SAC012	H2	BAE680CQ	
						SAD028	H3		
						SAG023	H1		
						SAG023-1	H1		
						SAG023	H1	GA2203	J2
						SAG023-1	H1		
						SAG023	H1		
						SAG023-1	H1		
						SAG023	H1	GA2203	J2
						SAG023-1	H1		



KW



TYPE



TYPE

MERCEDES-BENZ

CLASSE GLK (X204)

250 CDI 4-matic (204.982, 204.904)	Diesel	150	09/09 →						
250 CDI 4-matic (204.982, 204.904)	Diesel	150	09/09 →						
280 4-matic (204.981)	Petrol	170	06/08 → 06/09						
300 4-matic (204.981)	Petrol	170	07/09 → 04/11						
320 CDI 4-matic (204.983)	Diesel	165	06/08 →						
350 (204.956)	Petrol	200	04/09 →						
350 4-matic (204.987)	Petrol	200	06/08 → 04/11						
350 CDI 4-matic (204.992)	Diesel	165	07/09 → 01/10						
350 CDI 4-matic (204.992)	Diesel	170	02/10 → 05/10						
350 CDI 4-matic (204.993)	Diesel	195	07/12 →						

CLASSE M (W163)

ML 230 (163.136)	Petrol	110	03/98 → 06/00						
ML 230 (163.136)	Petrol	110	02/98 → 06/05						
ML 230 (163.136)	Petrol	110	02/98 → 06/05						
ML 230 (163.136)	Petrol	110	02/98 → 06/05						
ML 230 (163.136)	Petrol	110	02/98 → 06/05						
ML 270 CDI (163.113)	Diesel	120	12/99 → 06/05						
ML 270 CDI (163.113)	Diesel	120	12/99 → 06/05						
ML 270 CDI (163.113)	Diesel	120	12/99 → 06/05						
ML 320 (163.154)	Petrol	160	01/01 → 08/02						
ML 320 (163.154)	Petrol	160	02/98 → 08/02						
ML 320 (163.154)	Petrol	160	02/98 → 08/02						
ML 320 (163.154)	Petrol	160	02/98 → 08/02	ENGINE: 30358407 →					
ML 320 (163.154)	Petrol	160	02/98 → 08/02	ENGINE: 30358407 →					
ML 350	Petrol	173	02/03 → 06/05						
ML 350	Petrol	173	02/03 → 06/05						
ML 350	Petrol	173	02/03 → 06/05						
ML 350	Petrol	173	02/03 → 06/05						
ML 350 (163.157)	Petrol	180	08/02 → 06/05						
ML 350 (163.157)	Petrol	180	08/02 → 06/05						
ML 350 (163.157)	Petrol	180	08/02 → 06/05						
ML 350 (163.157)	Petrol	180	08/02 → 06/05						
ML 350 (163.157)	Petrol	180	08/02 → 01/03						
ML 400 CDI (163.128)	Diesel	184	09/01 → 06/05	ENGINE: 40004860 →					
ML 400 CDI (163.128)	Diesel	184	09/01 → 06/05						
ML 400 CDI (163.128)	Diesel	184	09/01 → 06/05						
ML 400 CDI (163.128)	Diesel	184	09/01 → 06/05						
ML 430 (163.172)	Petrol	200	01/01 → 06/05						
ML 430 (163.172)	Petrol	200	02/98 → 06/05						
ML 430 (163.172)	Petrol	200	02/98 → 06/05						
ML 430 (163.172)	Petrol	200	02/98 → 06/05						
ML 430 (163.172)	Petrol	200	11/98 → 06/05						



KW



TYPE



TYPE

MERCEDES-BENZ

CLASSE M (W163)

ML 500 (163.175)	Petrol	215	09/01 → 06/05					
ML 500 (163.175)	Petrol	215	09/01 → 06/05					
ML 500 (163.175)	Petrol	215	09/01 → 06/05					
ML 500 (163.175)	Petrol	215	09/01 → 06/05					
ML 55 AMG (163.174)	Petrol	255	02/00 → 06/05					
ML 55 AMG (163.174)	Petrol	255	02/00 → 06/05					
ML 55 AMG (163.174)	Petrol	255	02/00 → 06/05					
ML 55 AMG (163.174)	Petrol	255	02/00 → 06/05					

CLASSE M (W164)

ML 280 CDI 4-matic (164.120)	Diesel	140	07/05 → 10/05	ENGINE: → 40086332				
ML 300 CDI 4-matic (164.120)	Diesel	140	07/09 →					
ML 300 CDI 4-matic (164.121)	Diesel	150	02/10 →					
ML 320 CDI 4-matic (164.122)	Diesel	165	07/05 → 10/05	ENGINE: → 40086332				
ML 350 4-matic (164.186)	Petrol	200	07/05 →					
ML 350 4-matic (164.186)	Petrol	200	06/06 →	ENGINE: 30417697 →				
ML 350 CDI 4-matic	Diesel	155	09/09 →					
ML 350 CDI 4-matic (164.122)	Diesel	165	07/09 →					
ML 350 CDI 4-matic (164.125)	Diesel	170	02/10 →					
ML 420 CDI 4-matic (164.128)	Diesel	225	02/06 → 09/09					
ML 450 CDI 4-matic (164.128)	Diesel	225	09/09 →					
ML 500 4-matic (164.172)	Petrol	285	12/07 →					
ML 500 4-matic (164.175)	Petrol	225	07/05 →					
ML 500 4-matic (164.175)	Petrol	225	07/05 →					
ML 500 4-matic (164.175)	Petrol	225	07/05 →					
ML 500 4-matic (164.175)	Petrol	225	07/05 → 12/07					
ML 63 AMG 4-matic (164.177)	Petrol	375	01/06 →					

CLASSE M (W166)

ML 350 BlueTec 4-matic (166.024)	Diesel	190	06/11 →					
----------------------------------	--------	-----	---------	--	--	--	--	--

CLASSE R (W251, V251)

R 280 (251.054, 251.154)	Petrol	170	01/07 →					
R 280 4-matic (251.062)	Petrol	170	05/07 →					
R 280 CDI (251.121, 251.026, 251.126)	Diesel	140	05/06 →					
R 280 CDI 4-matic (251.020)	Diesel	140	05/06 →					
R 300 (251.054, 251.154)	Petrol	170	07/09 →					
R 300 CDI (251.021, 251.121, 251.026, 251.126)	Diesel	140	07/09 →					
R 300 CDI 4-matic (251.020)	Diesel	140	07/09 →					
R 320 CDI 4-matic (251.022, 251.122)	Diesel	165	01/06 →					
R 350 (251.056, 251.156)	Petrol	200	01/07 →					
R 350 (251.056, 251.156)	Petrol	200	01/07 →	ENGINE: 30417697 →				
R 350 4-matic (251.065, 251.165)	Petrol	200	01/06 →					

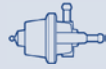

TYPE



TYPE



TYPE

	APS33		SPA163	F1		SAC012	H2	BAE680CX	ESS520	J1
						SAD018	H3			
						SAG023	H1			
						SAG023-1	H1			
			SPA163	F1		SAC012	H2	BAE680CX		
						SAD018	H3			
						SAG023	H1			
						SAG023-1	H1			
						SAC012	H2			
						SAC012	H2			
						SAC012	H2			
						SAC012	H2			
						SAC012	H2			
								BAE680CQ		
						SAC012	H2			
						SAC012	H2			
						SAC012	H2			
						SAC012	H2			
						SAC031	H2			
								BAE680CQ		
						SAD018	H3	BAE680CX		
						SAG023	H1			
						SAG023-1	H1			
						SAC012	H2			
						SAD028	H3	BAE680DF		
						SAC012	H2			
						SAC012	H2	BAE680CQ		
						SAC012	H2	BAE680CQ		
						SAC012	H2			
						SAC012	H2			
						SAC012	H2	BAE680CQ		
						SAC012	H2			
						SAC012	H2			
						SAC012	H2			
						SAC012	H2			
						SAC012	H2			
						SAC012	H2			
								BAE680CQ		
						SAC012	H2			



KW



TYPE



TYPE

MERCEDES-BENZ

CLASSE R (W251, V251)

R 350 4-matic (251.065, 251.165)	Petrol	200	01/06 →						
R 350 4-matic (251.065, 251.165)	Petrol	200	06/06 →	ENGINE: 30417697 →					
R 350 CDI 4-matic (251.022, 251.122)	Diesel	165	07/09 →						
R 350 CDI 4-matic (251.124, 251.125)	Diesel	155	01/06 →						
R 500 4-matic (251.072, 251.172)	Petrol	285	01/07 →						
R 500 4-matic (251.075, 251.175)	Petrol	225	01/06 →						
R 500 4-matic (251.075, 251.175)	Petrol	225	01/06 →						
R 500 4-matic (251.075, 251.175)	Petrol	225	01/06 →						
R 500 4-matic (251.075, 251.175)	Petrol	225	01/06 →						
R 63 AMG (251.077, 251.177)	Petrol	375	02/06 →						

CLASSE S (W140)

3.2	Petrol	162	10/95 → 08/98	CHASSIS: → A220200					
300 SE 2.8 (140.028)	Petrol	145	01/93 → 05/93						
300 SE 2.8 (140.028)	Petrol	145	01/93 → 10/98	ENGINE: 000781 → 001151					
300 SE 2.8 (140.028)	Petrol	145	01/93 → 10/98						
300 SE 2.8 (140.028)	Petrol	145	01/93 → 05/93	CHASSIS: → A220200					
300 SE 2.8 (140.028)	Petrol	145	11/94 → 10/98						
300 SE,SEL/S320 (140.032, 140.033)	Petrol	170	03/91 → 09/98						
300 SE,SEL/S320 (140.032, 140.033)	Petrol	170	03/91 → 10/98						
300 SE,SEL/S320 (140.032, 140.033)	Petrol	170	03/91 → 10/98	ENGINE: 036701 → 073222					
300 SE,SEL/S320 (140.032, 140.033)	Petrol	170	03/91 → 09/98	CHASSIS: → A220200					
300 SE,SEL/S320 (140.032, 140.033)	Petrol	170	11/94 → 10/98						
400 SE,SEL/S420 (140.042, 140.043)	Petrol	210	02/91 → 09/98						
400 SE,SEL/S420 (140.042, 140.043)	Petrol	210	02/91 → 10/98						
400 SE,SEL/S420 (140.042, 140.043)	Petrol	210	09/95 → 10/98						
400 SE,SEL/S420 (140.042, 140.043)	Petrol	210	02/91 → 09/98	CHASSIS: → A220200					
400 SE,SEL/S420 (140.042, 140.043)	Petrol	210	11/94 → 10/98						
500 SE,SEL (140.050, 140.051)	Petrol	240	02/91 → 05/93						
500 SE,SEL (140.050, 140.051)	Petrol	240	02/91 → 10/98						
500 SE,SEL (140.050, 140.051)	Petrol	240	02/91 → 05/93	CHASSIS: → A220200					
500 SE,SEL (140.050, 140.051)	Petrol	240	11/94 → 10/98						
600 SE,SEL (140.056, 140.057)	Petrol	300	04/91 → 12/92						

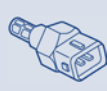
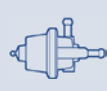

TYPE

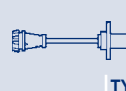

TYPE



TYPE

							SAD028	H3			
										BAE680CQ	
							SAC012	H2			
							SAC012	H2			
							SAC012	H2	BAE680CQ		
							SAC012	H2	BAE680CX		
							SAD018	H3			
							SAG023	H1			
							SAG023-1	H1			
							SAD028	H3	BAE680DF		
										ESS528	J1
		RP01A									
			ATS21	F2							
							SAC043	H2			
										ESS528	J1
										PI027	J1
		RP01A									
			SPA136	F1			SAC016	H2			
			ATS21	F2							
										ESS528	J1
										PI027	J1
		RP01A									
			SPA136	F1			SAC043	H2			
							SAG146	H1			
										ESS528	J1
										PI027	J1
		RP01A									
			SPA136	F1			SAC043	H2			
										ESS528	J1
										PI027	J1
		RP01A	SPA136	F1							



KW



TYPE



TYPE

MERCEDES-BENZ

CLASSE S (W140)

600 SE,SEL (140.056, 140.057)	Petrol	300	04/91 → 12/92	CHASSIS: → A220200					
S 280 (140.028)	Petrol	142	06/93 → 09/98						
S 280 (140.028)	Petrol	142	02/93 → 10/98	ENGINE: 000781 → 001151					
S 280 (140.028)	Petrol	142	02/93 → 10/98						
S 280 (140.028)	Petrol	142	11/94 → 10/98						
S 280 (140.028)	Petrol	142	05/93 → 09/98	CHASSIS: → A220200					
S 350 Turbo-D (140.134)	Diesel	110	05/93 → 06/96	CHASSIS: → A220200					
S 420 (140.042)	Petrol	205	06/93 → 09/98						
S 420 (140.042)	Petrol	205	01/93 → 10/98						
S 420 (140.042)	Petrol	205	09/95 → 10/98						
S 420 (140.042)	Petrol	205	09/95 → 10/98						
S 420 (140.042)	Petrol	205	11/94 → 10/98						
S 420 (140.042)	Petrol	205	05/93 → 09/98	CHASSIS: → A220200					
S 500 (140.050, 140.051)	Petrol	235	06/93 → 09/98						
S 500 (140.050, 140.051)	Petrol	235	01/93 → 10/98						
S 500 (140.050, 140.051)	Petrol	235	09/95 → 10/98						
S 500 (140.050, 140.051)	Petrol	235	09/95 → 10/98						
S 500 (140.050, 140.051)	Petrol	235	11/94 → 10/98						
S 500 (140.050, 140.051)	Petrol	235	05/93 → 09/98	CHASSIS: → A220200					
S 600 (140.056, 140.057)	Petrol	290	06/93 → 09/98						
S 600 (140.056, 140.057)	Petrol	290	01/93 → 10/98						
S 600 (140.056, 140.057)	Petrol	290	09/95 → 10/98						
S 600 (140.056, 140.057)	Petrol	290	09/95 → 10/98						
S 600 (140.056, 140.057)	Petrol	290	01/93 → 09/98	ENGINE: M120980-M120982					
S 600 (140.056, 140.057)	Petrol	290	11/94 → 10/98						

CLASSE S (W220)

S 280 (220.063, 220.163)	Petrol	150	01/01 → 08/05						
S 280 (220.063, 220.163)	Petrol	150	10/98 → 08/05						
S 280 (220.063, 220.163)	Petrol	150	10/98 → 08/05						
S 280 (220.063, 220.163)	Petrol	150	10/98 → 08/05						
S 280 (220.063, 220.163)	Petrol	150	02/99 → 08/05						
S 280 (220.063, 220.163)	Petrol	150	01/99 → 08/05						
S 320 (220.065, 220.165)	Petrol	165	01/01 → 08/05						
S 320 (220.065, 220.165)	Petrol	165	10/98 → 08/05						
S 320 (220.065, 220.165)	Petrol	165	10/98 → 08/05						
S 320 (220.065, 220.165)	Petrol	165	10/98 → 08/05						
S 320 (220.065, 220.165)	Petrol	165	02/99 → 08/02						
S 320 (220.065, 220.165)	Petrol	165	10/98 → 08/02						
S 320 CDI (220.025, 220.125)	Diesel	150	09/02 → 08/05						
S 320 CDI (220.025, 220.125)	Diesel	150	09/02 → 08/05						
S 320 CDI (220.025, 220.125)	Diesel	150	09/02 → 08/05						
S 320 CDI (220.026, 220.126)	Diesel	145	08/99 → 09/02						
S 320 CDI (220.026, 220.126)	Diesel	145	08/99 → 09/02						
S 320 CDI (220.026, 220.126)	Diesel	145	08/99 → 09/02						



TYPE



TYPE



TYPE

									ESS528	J1
			RP01A							
				ATS21	F2					
							SAC043	H2		
									PI027	J1
									ESS528	J1
									ESS528	J1
			RP01A							
				SPA136	F1		SAC043	H2		
							SAD018	H3		
							SAG146	H1		
									PI027	J1
									ESS528	J1
			RP01A							
				SPA136	F1		SAC043	H2		
							SAD018	H3		
							SAG146	H1		
									PI027	J1
									ESS528	J1
			RP01A							
				SPA136	F1					
							SAD018	H3		
							SAG146	H1		
									ESS528	J1
									PI027	J1
			APS33							
				SPA163	F1		SAD018	H3	PI027	J1
							SAG023	H1		
							SAG023-1	H1		
							SAC012	H2		
									BAE680CX	
			APS33							
				SPA163	F1		SAD018	H3	PI027	J1
							SAG023	H1		
							SAG023-1	H1		
							SAC012	H2		
									BAE680CX	
				ATS21	F2		SAC012	H2		
				SPA163	F1		SAG023	H1		
							SAG023-1	H1		
				ATS21	F2		SAC012	H2		
				SPA163	F1		SAG023	H1		
							SAG023-1	H1		



KW

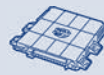

TYPE



TYPE

MERCEDES-BENZ

CLASSE S (W220)

S 350 (220.067, 220.167)	Petrol	180	09/02 → 08/05						
S 350 (220.067, 220.167)	Petrol	180	09/02 → 08/05						
S 350 (220.067, 220.167)	Petrol	180	09/02 → 08/05						
S 350 (220.067, 220.167)	Petrol	180	09/02 → 08/05						
S 350 4-matic (220.087, 220.187)	Petrol	180	06/03 → 08/05						
S 350 4-matic (220.087, 220.187)	Petrol	180	06/03 → 08/05						
S 350 4-matic (220.087, 220.187)	Petrol	180	06/03 → 08/05						
S 350 4-matic (220.087, 220.187)	Petrol	180	06/03 → 08/05						
S 400 CDI (220.028, 220.128)	Diesel	184	06/00 → 08/05	ENGINE: 40004860 →					
S 400 CDI (220.028, 220.128)	Diesel	191	06/03 → 08/05	ENGINE: 40004860 →					
S 400 CDI (220.028, 220.128)	Diesel	184	06/00 → 08/05						
S 400 CDI (220.028, 220.128)	Diesel	184	06/00 → 08/05						
S 400 CDI (220.028, 220.128)	Diesel	184	06/00 → 08/05						
S 400 CDI (220.028, 220.128)	Diesel	191	06/03 → 08/05						
S 400 CDI (220.028, 220.128)	Diesel	191	06/03 → 08/05						
S 400 CDI (220.028, 220.128)	Diesel	191	06/03 → 08/05						
S 430 (220.070, 220.170)	Petrol	205	01/01 → 08/05						
S 430 (220.070, 220.170)	Petrol	205	10/98 → 08/05						
S 430 (220.070, 220.170)	Petrol	205	10/98 → 08/05						
S 430 (220.070, 220.170)	Petrol	205	10/98 → 08/05						
S 430 (220.070, 220.170)	Petrol	205	10/98 → 08/05						
S 430 4-matic (220.083, 220.183)	Petrol	205	09/02 → 08/05						
S 430 4-matic (220.083, 220.183)	Petrol	205	09/02 → 08/05						
S 430 4-matic (220.083, 220.183)	Petrol	205	09/02 → 08/05						
S 430 4-matic (220.083, 220.183)	Petrol	205	09/02 → 08/05						
S 500 (220.075, 220.175, 220.875)	Petrol	225	01/01 → 08/05						
S 500 (220.075, 220.175, 220.875)	Petrol	225	10/98 → 08/05						
S 500 (220.075, 220.175, 220.875)	Petrol	225	10/98 → 08/05						
S 500 (220.075, 220.175, 220.875)	Petrol	225	10/98 → 08/05						
S 500 (220.075, 220.175, 220.875)	Petrol	225	10/98 → 08/05						
S 500 4-matic (220.084, 220.184)	Petrol	225	09/02 → 08/05						
S 500 4-matic (220.084, 220.184)	Petrol	225	09/02 → 08/05						
S 500 4-matic (220.084, 220.184)	Petrol	225	09/02 → 08/05						
S 500 4-matic (220.084, 220.184)	Petrol	225	09/02 → 08/05						
S 55 AMG (220.073, 220.173)	Petrol	265	01/01 → 08/05						
S 55 AMG (220.073, 220.173)	Petrol	265	04/99 → 08/05						
S 55 AMG (220.073, 220.173)	Petrol	265	04/99 → 08/05						
S 55 AMG (220.073, 220.173)	Petrol	265	04/99 → 08/05						
S 55 AMG (220.073, 220.173)	Petrol	265	09/99 → 08/02						
S 55 AMG Kompressor (220.074, 220.174)	Petrol	368	06/02 → 08/05						
S 55 AMG Kompressor (220.074, 220.174)	Petrol	368	06/02 → 08/05						

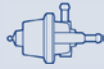

TYPE



TYPE



TYPE

	APS33		SPA163	F1		SAC012	H2	BAE680CX	PI028	J1
						SAD018	H3			
						SAG023	H1			
						SAG023-1	H1			
	APS33		SPA163	F1		SAC012	H2	BAE680CX	PI028	J1
						SAD018	H3			
						SAG023	H1			
						SAG023-1	H1			
	APS33									
	APS33									
			ATS21	F2		SAC012	H2			
			SPA163	F1		SAG023	H1			
						SAG023-1	H1			
						SAC012	H2			
						SAG023	H1			
						SAG023-1	H1			
	APS33									
			SPA163	F1		SAC012	H2	BAE680CX	PI027	J1
						SAD018	H3			
						SAG023	H1			
						SAG023-1	H1			
	APS33		SPA163	F1		SAC012	H2	BAE680CX	PI028	J1
						SAD018	H3			
						SAG023	H1			
						SAG023-1	H1			
	APS33									
			SPA163	F1		SAC012	H2	BAE680CX	PI027	J1
						SAD018	H3			
						SAG023	H1			
						SAG023-1	H1			
	APS33		SPA163	F1		SAC012	H2	BAE680CX	PI028	J1
						SAD018	H3			
						SAG023	H1			
						SAG023-1	H1			
	APS33									
			SPA163	F1		SAD018	H3	BAE680CX		
						SAG023	H1			
						SAG023-1	H1			
						SAC012	H2			
	APS33		SPA163	F1		SAD018	H3	BAE680CX		
						SAG023	H1			
						SAG023	H1			



KW

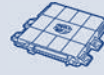

TYPE



TYPE

MERCEDES-BENZ

CLASSE S (W220)

S 55 AMG Kompressor (220.074, 220.174)	Petrol	368	06/02 → 08/05					
S 55 AMG Kompressor (220.074, 220.174)	Petrol	368	09/02 → 08/05					
S 600 (220.176)	Petrol	368	09/02 → 08/05					
S 600 (220.176)	Petrol	368	09/02 → 08/05					
S 600 (220.176)	Petrol	368	09/02 → 08/05					
S 600 (220.878, 220.178)	Petrol	270	01/00 → 08/05					
S 600 (220.878, 220.178)	Petrol	270	01/00 → 08/05					
S 65 AMG (220.179)	Petrol	450	03/04 → 08/05					
S 65 AMG (220.179)	Petrol	450	03/04 → 08/05					
S 65 AMG (220.179)	Petrol	450	03/04 → 08/05					
S 65 AMG (220.179)	Petrol	450	02/05 → 08/05	ENGINE: 40013259 →				

CLASSE S (W221)

S 320 CDI (221.022, 221.122)	Diesel	173	12/05 → 06/09					
S 320 CDI 4-matic (221.080, 221.180)	Diesel	173	10/06 →					
S 350 (221.056, 221.156)	Petrol	200	10/05 →					
S 350 (221.056, 221.156)	Petrol	200	10/05 →					
S 350 (221.056, 221.156)	Petrol	200	06/06 →	ENGINE: 30417697 →				
S 350 4-matic (221.087, 221.187)	Petrol	200	02/08 →					
S 350 4-matic (221.087, 221.187)	Petrol	200	02/08 →	ENGINE: 30417697 →				
S 350 BlueTec (221.026, 221.126)	Diesel	190	04/11 →					
S 350 BlueTEC 4-matic (221.083, 221.183)	Diesel	190	04/11 →					
S 400 Hybrid (221.095, 221.195)	Hybrid	205	01/09 →					
S 420 CDI / S 450 CDI (221.028, 221.128)	Diesel	235	10/06 →					
S 450 (221.070, 221.170)	Petrol	250	12/05 →					
S 450 (221.070, 221.170)	Petrol	250	06/06 →	ENGINE: 30061424 →				
S 450 4-matic (221.084, 221.184)	Petrol	250	12/05 →					
S 450 4-matic (221.084, 221.184)	Petrol	250	12/05 →					
S 450 4-matic (221.084, 221.184)	Petrol	250	06/06 →	ENGINE: 30061424 →				
S 500 (221.071, 221.171)	Petrol	285	10/05 →					
S 500 (221.071, 221.171)	Petrol	285	10/05 →					
S 500 (221.071, 221.171)	Petrol	285	06/06 →	ENGINE: 30061424 →				
S 500 4-matic (221.086, 221.186)	Petrol	285	10/05 →					
S 500 4-matic (221.086, 221.186)	Petrol	285	06/06 →					
S 500 4-matic (221.086, 221.186)	Petrol	285	06/06 →	ENGINE: 30061424 →				
S 600 (221.176)	Petrol	380	12/05 →					
S 600 (221.176)	Petrol	380	12/05 →					
S 600 (221.176)	Petrol	380	12/05 →					
S 63 AMG (221.077, 221.177)	Petrol	386	10/06 →					
S 63 AMG (221.077, 221.177)	Petrol	386	10/06 →					

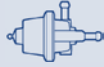

TYPE



TYPE



TYPE

						SAG023-1	H1		
						SAC012	H2		
				ATS21	F2	SAD018	H3		
				SPA163	F1	SAG023	H1		
						SAG023-1	H1		
	APS33			SPA163	F1	SAG023	H1		
						SAG023-1	H1		
						SAD018	H3		
						SAG023	H1		
						SAG023-1	H1		
						SAC012	H2		
						SAC012	H2	ESS0077A	J1
						SAC012	H2		
						SAC012	H2		
						SAD028	H3		
								BAE680CQ	
						SAC012	H2		
								BAE680CQ	
						SAC012	H2		
						SAC012	H2	BAE680CQ	
						SAC012	H2		
						SAC012	H2		
								BAE680CQ	
						SAC012	H2		
						SAD028	H3		
								BAE680CQ	
						SAC012	H2		
						SAD028	H3		
								BAE680CQ	
						SAD018	H3		
						SAG023	H1		
						SAG023-1	H1		
						SAC012	H2	BAE680DF	
						SAD028	H3		



KW



TYPE



TYPE

MERCEDES-BENZ

CLASSE S (W221)

S 65 AMG (221.179)	Petrol	450	12/05 →						
S 65 AMG (221.179)	Petrol	450	12/05 →						
S 65 AMG (221.179)	Petrol	450	12/05 →						
S 65 AMG (221.179)	Petrol	463	04/11 →						
S 65 AMG (221.179)	Petrol	463	04/11 →						
S 65 AMG (221.179)	Petrol	463	04/11 →						

CLASSE S Coupé (C126)

420 SEC (126.046)	Petrol	150	10/85 → 06/91						
420 SEC (126.046)	Petrol	160	10/85 → 12/87						
420 SEC (126.046)	Petrol	165	10/85 → 06/91						
500 SEC (126.044)	Petrol	164	10/85 → 06/91						
500 SEC (126.044)	Petrol	180	09/85 → 06/91						
500 SEC (126.044)	Petrol	185	08/87 → 06/91						
500 SEC (126.044)	Petrol	195	09/85 → 06/91						
500 SEC Cat.	Petrol	185	06/89 → 06/91						
560 SEC (126.045)	Petrol	178	10/85 → 06/91						
560 SEC (126.045)	Petrol	200	10/85 → 12/87						
560 SEC (126.045)	Petrol	205	10/85 → 06/91						
560 SEC (126.045)	Petrol	220	10/85 → 08/87						

CLASSE S Coupé (C140)

SEC/CL 420 (140.063)	Petrol	205	10/94 → 02/99						
SEC/CL 420 (140.063)	Petrol	205	10/94 → 02/99						
SEC/CL 420 (140.063)	Petrol	205	06/96 → 02/99						
SEC/CL 420 (140.063)	Petrol	205	10/94 → 02/99	ENGINE: M119971-M119981					
SEC/CL 420 (140.063)	Petrol	205	11/94 → 02/99						
SEC/CL 500 (140.070)	Petrol	235	10/92 → 02/99						
SEC/CL 500 (140.070)	Petrol	235	09/95 → 02/99						
SEC/CL 500 (140.070)	Petrol	235	09/96 → 02/99						
SEC/CL 500 (140.070)	Petrol	235	06/96 → 02/99						
SEC/CL 500 (140.070)	Petrol	235	10/92 → 02/99	ENGINE: M119970					
SEC/CL 500 (140.070)	Petrol	235	11/94 → 02/99						
SEC/CL 600 (140.076)	Petrol	290	09/92 → 05/96						
SEC/CL 600 (140.076)	Petrol	290	09/92 → 02/99						
SEC/CL 600 (140.076)	Petrol	290	06/96 → 02/99						
SEC/CL 600 (140.076)	Petrol	290	09/95 → 02/99						
SEC/CL 600 (140.076)	Petrol	290	09/92 → 05/96	ENGINE: M120980-M120982					
SEC/CL 600 (140.076)	Petrol	290	11/94 → 02/99						

CLASSE S Coupé (C215)

CL 500 (215.375)	Petrol	225	03/99 → 03/06						
CL 500 (215.375)	Petrol	225	03/99 → 03/06						
CL 500 (215.375)	Petrol	225	03/99 → 03/06						
CL 500 (215.375)	Petrol	225	09/99 → 03/06						
CL 55 AMG (215.373)	Petrol	265	10/99 → 03/06						
CL 55 AMG (215.373)	Petrol	265	10/99 → 03/06						

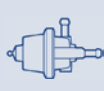

TYPE

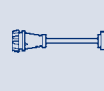

TYPE



TYPE

SAC012	H2
SAG023	H1
SAG023-1	H1
SAC012	H2
SAG023	H1
SAG023-1	H1

ESS528	J1
ESS528	J1
ESS528	J1
ESS528	J1
ESS528	J1
ESS528	J1
ESS528	J1
ESS528	J1
ESS528	J1
ESS528	J1
ESS528	J1
ESS528	J1

RP01A	SPA136	F1	SAC043	H2
			SAD018	H3
			SAG146	H1

ESS528	J1
PI027	J1

RP01A	SPA136	F1	SAC043	H2
			SAD018	H3
			SAG146	H1

BAE680CX

ESS528	J1
PI027	J1

RP01A	SPA136	F1
-------	--------	----

SAG146	H1
SAD018	H3

ESS528	J1
PI027	J1

APS33	SPA163	F1
-------	--------	----

SAD018	H3	BAE680CX
SAG023	H1	
SAG023-1	H1	
SAC012	H2	

APS33	SPA163	F1
-------	--------	----

SAD018	H3	BAE680CX
SAG023	H1	



KW



TYPE



TYPE

MERCEDES-BENZ

CLASSE S Coupé (C215)

CL 55 AMG (215.373)	Petrol	265	10/99 → 03/06						
CL 55 AMG (215.373)	Petrol	265	04/00 → 07/02						
CL 55 AMG Kompressor (215.374)	Petrol	368	06/02 → 03/06						
CL 55 AMG Kompressor (215.374)	Petrol	368	06/02 → 03/06						
CL 55 AMG Kompressor (215.374)	Petrol	368	06/02 → 03/06						
CL 55 AMG Kompressor (215.374)	Petrol	368	06/02 → 03/06						
CL 600 (215.376)	Petrol	368	09/02 → 03/06						
CL 600 (215.376)	Petrol	368	09/02 → 03/06						
CL 600 (215.376)	Petrol	368	09/02 → 03/06						
CL 600 (215.378)	Petrol	270	03/99 → 03/06						
CL 600 (215.378)	Petrol	270	03/99 → 03/06						
CL 600 (215.378)	Petrol	270	03/99 → 03/06						
CL 65 AMG (215.379)	Petrol	450	09/03 → 03/06						
CL 65 AMG (215.379)	Petrol	450	09/03 → 03/06						
CL 65 AMG (215.379)	Petrol	450	09/03 → 03/06						

CLASSE S Coupé (C216)

CL 500 (216.371)	Petrol	285	06/06 →						
CL 500 (216.371)	Petrol	285	06/06 →	ENGINE: 30061424 →					
CL 500 (216.371)	Petrol	285	09/07 → 07/10						
CL 500 4-matic (216.386)	Petrol	285	02/08 →						
CL 600 (216.376)	Petrol	380	08/06 →						
CL 600 (216.376)	Petrol	380	08/06 →						
CL 63 AMG (216.377)	Petrol	386	10/06 →						
CL 65 AMG (216.379)	Petrol	450	10/06 → 09/10						
CL 65 AMG (216.379)	Petrol	450	10/06 → 09/10						
CL 65 AMG (216.379)	Petrol	463	02/11 →						
CL 65 AMG (216.379)	Petrol	463	02/11 →						

CLASSE V (638/2)

V 200 (638.214, 638.294)	Petrol	95	02/97 → 06/03						
V 200 (638.214, 638.294)	Petrol	95	02/97 → 07/03						
V 200 CDI (638.294)	Diesel	75	03/99 → 07/03						
V 200 CDI (638.294)	Diesel	75	03/99 → 07/03						
V 200 CDI (638.294)	Diesel	75	03/99 → 07/03						
V 220 CDI (638.294)	Diesel	90	03/99 → 07/03						
V 220 CDI (638.294)	Diesel	90	03/99 → 07/03						
V 220 CDI (638.294)	Diesel	90	03/99 → 07/03						
V 280 (638.244, 638.294)	Petrol	128	08/97 → 07/03	ENGINE: 004196 →					



TYPE

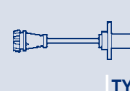

TYPE



TYPE

						SAG023-1	H1		
						SAC012	H2		
	APS60		ATS21	F2		SAC012	H2	BAE680CX	
			SPA163	F1		SAD018	H3		
						SAG023	H1		
						SAG023-1	H1		
			ATS21	F2		SAD018	H3		
			SPA163	F1		SAG023	H1		
						SAG023-1	H1		
	APS33		SPA163	F1		SAD018	H3		
						SAG023	H1		
						SAG023-1	H1		
						SAD018	H3		
						SAG023	H1		
						SAG023-1	H1		
						SAC012	H2		
								BAE680CQ	
								BAE680CX	
						SAC012	H2	BAE680CQ	
						SAG023	H1		
						SAG023-1	H1		
						SAC012	H2	BAE680DF	
						SAG023	H1		
						SAG023-1	H1		
						SAG023	H1		
						SAG023-1	H1		
		RP01A							
						SAC016	H2		
			ATS21	F2		SAC012	H2		
			SPA163	F1		SAG023	H1		
						SAG023-1	H1		
			ATS21	F2		SAC012	H2		
			SPA163	F1		SAG023	H1		
						SAG023-1	H1		
			SPA111	F1					



KW



TYPE



TYPE

MERCEDES-BENZ

CLK (C208)

200 (208.335)	Petrol	100	06/97 → 06/00						
200 (208.335)	Petrol	100	06/97 → 06/02						
200 (208.335)	Petrol	100	06/97 → 06/02						
200 (208.335)	Petrol	100	06/97 → 06/02						
200 (208.335)	Petrol	100	11/99 → 06/02						
200 Kompressor (208.344)	Petrol	120	06/00 → 06/02						
200 Kompressor (208.344)	Petrol	120	06/00 → 06/02						
200 Kompressor (208.345)	Petrol	141	06/97 → 06/00						
200 Kompressor (208.345)	Petrol	141	06/97 → 06/00						
200 Kompressor (208.345)	Petrol	141	06/97 → 06/00						
200 Kompressor (208.345)	Petrol	141	06/97 → 06/00						
200 Kompressor (208.345)	Petrol	141	11/99 → 06/00						
230 Kompressor (208.347)	Petrol	142	06/97 → 06/00						
230 Kompressor (208.347)	Petrol	142	06/97 → 06/00						
230 Kompressor (208.347)	Petrol	142	06/97 → 06/00						
230 Kompressor (208.347)	Petrol	142	06/97 → 06/00						
230 Kompressor (208.347)	Petrol	142	12/99 → 06/00						
230 Kompressor (208.348)	Petrol	145	06/00 → 06/02						
230 Kompressor (208.348)	Petrol	145	06/00 → 06/02						
320 (208.365)	Petrol	160	06/97 → 06/02						
320 (208.365)	Petrol	160	06/97 → 06/02						
320 (208.365)	Petrol	160	06/97 → 06/02	ENGINE: 30370999 →					
320 (208.365)	Petrol	160	06/97 → 06/02	ENGINE: 30370999 →					
320 (208.365)	Petrol	160	12/99 → 06/02						
430 (208.370)	Petrol	205	07/98 → 06/02						
430 (208.370)	Petrol	205	07/98 → 06/02						
430 (208.370)	Petrol	205	07/98 → 06/02						
430 (208.370)	Petrol	205	07/98 → 06/02						
55 AMG (208.374)	Petrol	255	08/99 → 06/02						
55 AMG (208.374)	Petrol	255	08/99 → 06/02						
55 AMG (208.374)	Petrol	255	08/99 → 06/02						
55 AMG (208.374)	Petrol	255	08/99 → 06/02						

CLK (C209)

200 CGI (209.343)	Petrol	125	07/03 → 05/09						
200 CGI (209.343)	Petrol	125	07/03 → 05/09						
200 CGI (209.343)	Petrol	125	07/03 → 05/09						
200 Kompressor (209.341)	Petrol	135	05/07 → 05/09						
200 Kompressor (209.341)	Petrol	135	05/07 → 05/09						
200 Kompressor (209.341)	Petrol	135	05/07 → 05/09						
200 Kompressor (209.342)	Petrol	120	09/02 → 05/09						
200 Kompressor (209.342)	Petrol	120	09/02 → 05/09						
200 Kompressor (209.342)	Petrol	120	09/02 → 05/09						
220 CDI (209.308)	Diesel	110	01/05 → 05/09						
220 CDI (209.308)	Diesel	110	01/05 → 05/09						

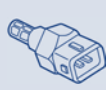
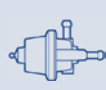

TYPE

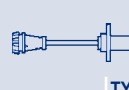

TYPE



TYPE

RP01A										
						SAC016	H2		PI026	J1
						SAG023	H1			
						SAG023-1	H1			
						SAC089	H2			
						SAG023	H1			
						SAG023-1	H1			
			ATS21	F2		SAC016	H2			
						SAD033	H3			
						SAG023	H1			
						SAG023-1	H1			
						SAC089	H2			
			ATS21	F2		SAC016	H2			
						SAD033	H3			
						SAG023	H1			
						SAG023-1	H1			
						SAC089	H2			
						SAG023	H1			
						SAG023-1	H1			
	APS33		SPA163	F1		SAC012	H2	BAE680CX		
						SAD018	H3			
						SAG023	H1			
						SAG023-1	H1			
						SAC089	H2			
	APS33		SPA163	F1		SAC012	H2	BAE680CX		
						SAD018	H3			
						SAG023	H1			
						SAG023-1	H1			
						SAC089	H2			
	APS33		SPA163	F1		SAC012	H2	BAE680CX		
						SAD018	H3			
						SAG023	H1			
						SAG023-1	H1			
						SAC012	H2			
						SAD018	H3			
						SAG023	H1			
						SAG023-1	H1			
			ATS21	F2		SAC012	H2		SUA590	J3
			SPA163	F1		SAG023	H1			
						SAG023-1	H1			
						SAC012	H2			
						SAG023	H1			
						SAG023-1	H1			
			ATS21	F2		SAC012	H2		SUA590	J3
			SPA163	F1		SAG023	H1			
						SAG023-1	H1			
						SAG023	H1			
						SAG023-1	H1			
						SAG023	H1		GA2190	J2
						SAG023-1	H1			



KW



TYPE



TYPE

MERCEDES-BENZ

CLK (C209)

220 CDI (209.308)	Diesel	110	01/05 → 11/05	ENGINE: → 30497543					
240 (209.361)	Petrol	125	06/02 → 05/09						
240 (209.361)	Petrol	125	06/02 → 05/09						
240 (209.361)	Petrol	125	06/02 → 05/09						
240 (209.361)	Petrol	125	06/02 → 05/09						
240 (209.361)	Petrol	120	06/02 → 03/05						
240 (209.361)	Petrol	125	06/02 → 03/05						
270 CDI (209.316)	Diesel	125	10/02 → 05/09						
270 CDI (209.316)	Diesel	125	10/02 → 05/09						
270 CDI (209.316)	Diesel	125	10/02 → 05/09						
280 (209.354)	Petrol	170	01/05 → 05/09						
280 (209.354)	Petrol	170	01/05 → 05/09						
280 (209.354)	Petrol	170	06/06 → 05/09	ENGINE: 30417697 →					
320 (209.365)	Petrol	160	06/02 → 05/09						
320 (209.365)	Petrol	160	06/02 → 05/09						
320 (209.365)	Petrol	160	06/02 → 05/09						
320 (209.365)	Petrol	160	06/02 → 05/09						
320 CDI (209.320)	Diesel	165	01/05 → 10/05	ENGINE: → 40086332					
320 CDI (209.320)	Diesel	165	01/05 → 05/09						
350 (209.356)	Petrol	200	01/05 → 05/09						
350 (209.356)	Petrol	200	01/05 → 05/09						
350 (209.356)	Petrol	200	06/06 → 05/09	ENGINE: 30417697 →					
500 (209.372)	Petrol	285	06/06 → 05/09						
500 (209.372)	Petrol	285	06/06 → 05/09						
500 (209.372)	Petrol	285	06/06 → 05/09						
500 (209.372)	Petrol	285	06/06 → 05/09	ENGINE: 30061424 →					
500 (209.375)	Petrol	225	06/02 → 05/09						
500 (209.375)	Petrol	225	06/02 → 05/09						
500 (209.375)	Petrol	225	06/02 → 05/09						
500 (209.375)	Petrol	225	06/02 → 05/09						
55 AMG (209.376)	Petrol	270	09/02 → 05/09						
55 AMG (209.376)	Petrol	270	09/02 → 05/09						
55 AMG (209.376)	Petrol	270	09/02 → 05/09						
55 AMG (209.376)	Petrol	270	09/02 → 05/09						
63 AMG (209.377)	Petrol	354	04/06 → 05/09						
63 AMG (209.377)	Petrol	373	05/07 → 05/09						
DTM AMG	Petrol	428	06/04 → 05/09						
DTM AMG	Petrol	428	06/04 → 05/09						
DTM AMG	Petrol	428	06/04 → 05/09						

CLK Cabriolet (A208)

200 (208.435)	Petrol	100	03/98 → 03/02						
200 (208.435)	Petrol	100	03/98 → 03/02						
200 (208.435)	Petrol	100	11/99 → 03/02						
200 Kompressor (208.444)	Petrol	120	06/00 → 03/02						

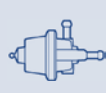

TYPE

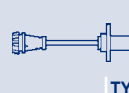

TYPE



TYPE

						SAC012	H2			
	APS33		SPA163	F1		SAC012	H2		SUA590	J3
						SAD018	H3			
						SAG023	H1			
						SAG023-1	H1			
								BAE680CX		
								BAE680CX		
			ATS21	F2		SAC012	H2		SUA581	J3
			SPA163	F1		SAG023	H1			
						SAG023-1	H1			
						SAC012	H2	BAE680CR	SUA590	J3
						SAD028	H3			
								BAE680CQ		
	APS33		SPA163	F1		SAC012	H2	BAE680CX	SUA590	J3
						SAD018	H3			
						SAG023	H1			
						SAG023-1	H1			
						SAC012	H2			
									GA2190	J2
						SAC012	H2	BAE680CR		
						SAD028	H3			
								BAE680CQ		
						SAC012	H2			
						SAG023	H1			
						SAG023-1	H1			
								BAE680CQ		
	APS33		SPA163	F1	SAA118	SAC012	H2	BAE680CX	SUA590	J3
						SAD018	H3			
						SAG023	H1			
						SAG023-1	H1			
	APS33		SPA163	F1		SAC012	H2	BAE680CX	SUA590	J3
						SAD018	H3			
						SAG023	H1			
						SAG023-1	H1			
						SAD028	H3	BAE680DF		
								BAE680DF		
						SAC012	H2			
						SAG023	H1			
						SAG023-1	H1			
						SAG023	H1		PI026	J1
						SAG023-1	H1			
						SAC089	H2			
						SAG023	H1			



KW



TYPE



TYPE

MERCEDES-BENZ

CLK Cabriolet (A208)

200 Kompressor (208.444)	Petrol	120	06/00 → 03/02						
200 Kompressor (208.445)	Petrol	141	03/98 → 06/00						
200 Kompressor (208.445)	Petrol	141	03/98 → 06/00						
200 Kompressor (208.445)	Petrol	141	03/98 → 06/00						
230 Kompressor (208.447)	Petrol	142	03/98 → 06/00						
230 Kompressor (208.447)	Petrol	142	03/98 → 06/00						
230 Kompressor (208.448)	Petrol	145	06/00 → 03/02						
230 Kompressor (208.448)	Petrol	145	06/00 → 03/02						
320 (208.465)	Petrol	160	03/98 → 03/02						
320 (208.465)	Petrol	160	03/98 → 03/02	ENGINE: 30370999 →					
320 (208.465)	Petrol	160	03/98 → 03/02	ENGINE: 30370999 →					
320 (208.465)	Petrol	160	06/98 → 03/02						
430 (208.470)	Petrol	205	09/98 → 03/02						
430 (208.470)	Petrol	205	09/98 → 03/02						
430 (208.470)	Petrol	205	09/98 → 03/02						
430 (208.470)	Petrol	205	08/99 → 03/02						
55 AMG (208.474)	Petrol	255	01/00 → 03/02						
55 AMG (208.474)	Petrol	255	01/00 → 03/02						
55 AMG (208.474)	Petrol	255	01/00 → 03/02						
55 AMG (208.474)	Petrol	255	01/00 → 03/02						

CLK Cabriolet (A209)

CLK 200 CGI (209.443)	Petrol	125	07/03 → 03/10						
CLK 200 CGI (209.443)	Petrol	125	07/03 → 03/10						
CLK 200 Kompressor (209.441)	Petrol	135	05/07 → 03/10						
CLK 200 Kompressor (209.441)	Petrol	135	05/07 → 03/10						
CLK 200 Kompressor (209.441)	Petrol	135	05/07 → 03/10						
CLK 200 Kompressor (209.442)	Petrol	120	02/03 → 03/10						
CLK 200 Kompressor (209.442)	Petrol	120	02/03 → 03/10						
CLK 200 Kompressor (209.442)	Petrol	120	02/03 → 03/10						
CLK 240 (209.461)	Petrol	125	02/03 → 03/10						
CLK 240 (209.461)	Petrol	125	02/03 → 03/10						
CLK 240 (209.461)	Petrol	125	02/03 → 03/10						
CLK 240 (209.461)	Petrol	125	02/03 → 03/10						
CLK 240 (209.461)	Petrol	125	02/03 → 03/05						
CLK 280 (209.454)	Petrol	170	01/05 → 03/10						
CLK 280 (209.454)	Petrol	170	01/05 → 03/10						
CLK 280 (209.454)	Petrol	170	06/06 → 03/10	ENGINE: 30417697 →					
CLK 320 (209.465)	Petrol	160	02/03 → 03/10						
CLK 320 (209.465)	Petrol	160	02/03 → 03/10						
CLK 320 (209.465)	Petrol	160	02/03 → 03/10						
CLK 320 (209.465)	Petrol	160	02/03 → 03/10						
CLK 320 CDI (209.420)	Diesel	165	03/05 → 03/10						
CLK 350 (209.456)	Petrol	200	01/05 → 03/10						
CLK 350 (209.456)	Petrol	200	01/05 → 03/10						



TYPE

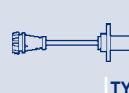

TYPE



TYPE

						SAG023-1	H1			
			ATS21	F2		SAC016	H2			
						SAG023	H1			
						SAG023-1	H1			
			ATS21	F2		SAG023	H1			
						SAG023-1	H1			
						SAG023	H1			
						SAG023-1	H1			
	APS33		SPA163	F1		SAD018	H3	BAE680CX		
						SAG023	H1			
						SAG023-1	H1			
						SAC012	H2			
	APS33		SPA163	F1		SAD018	H3	BAE680CX		
						SAG023	H1			
						SAG023-1	H1			
						SAC012	H2			
						SAC012	H2	BAE680CX		
						SAD018	H3			
						SAG023	H1			
						SAG023-1	H1			
			ATS21	F2		SAG023	H1		SUA590	J3
			SPA163	F1		SAG023-1	H1			
						SAC012	H2			
						SAG023	H1			
						SAG023-1	H1			
			ATS21	F2		SAC012	H2		SUA590	J3
			SPA163	F1		SAG023	H1			
						SAG023-1	H1			
	APS33		SPA163	F1		SAC012	H2		SUA590	J3
						SAD018	H3			
						SAG023	H1			
						SAG023-1	H1			
								BAE680CX		
						SAC012	H2	BAE680CR	SUA590	J3
						SAD028	H3			
								BAE680CQ		
	APS33		SPA163	F1		SAC012	H2	BAE680CX	SUA590	J3
						SAD018	H3			
						SAG023	H1			
						SAG023-1	H1			
						SAC012	H2		GA2190	J2
						SAC012	H2	BAE680CR		
						SAD028	H3			



KW

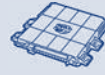

TYPE



TYPE

MERCEDES-BENZ

CLK Cabriolet (A209)

CLK 350 (209.456)	Petrol	200	06/06 → 03/10	ENGINE: 30417697 →					
CLK 500 (209.472)	Petrol	285	06/06 → 03/10						
CLK 500 (209.472)	Petrol	285	06/06 → 03/10						
CLK 500 (209.472)	Petrol	285	06/06 → 03/10						
CLK 500 (209.472)	Petrol	285	06/06 → 03/10						
CLK 500 (209.472)	Petrol	285	06/06 → 03/10	ENGINE: 30061424 →					
CLK 500 (209.475)	Petrol	225	02/03 → 03/10						
CLK 500 (209.475)	Petrol	225	02/03 → 03/10						
CLK 500 (209.475)	Petrol	225	02/03 → 03/10						
CLK 500 (209.475)	Petrol	225	02/03 → 03/10						
CLK 55 AMG (209.476)	Petrol	270	02/03 → 03/10						
CLK 55 AMG (209.476)	Petrol	270	02/03 → 03/10						
CLK 55 AMG (209.476)	Petrol	270	02/03 → 03/10						
CLK 55 AMG (209.476)	Petrol	270	02/03 → 03/10						
CLK 63 AMG (209.477)	Petrol	354	04/06 → 03/10						
CLK AMG DTM	Petrol	428	06/04 → 10/05						

CLS (C218)

CLS 350 CDI (218.323)	Diesel	195	01/11 →						
CLS 350 CDI 4-matic (218.393)	Diesel	195	09/11 →						

CLS (C219)

CLS 280 (219.354)	Petrol	170	07/08 → 12/10						
CLS 300 (219.354)	Petrol	170	04/09 → 12/10						
CLS 320 CDI (219.322)	Diesel	165	01/05 → 10/05	ENGINE: → 40086332					
CLS 320 CDI (219.322)	Diesel	165	01/05 → 12/10						
CLS 350 (219.356)	Petrol	200	10/04 → 12/10						
CLS 350 (219.356)	Petrol	200	10/04 → 12/10						
CLS 350 (219.356)	Petrol	200	06/06 → 12/10	ENGINE: 30417697 →					
CLS 350 (219.357)	Petrol	215	04/06 → 12/10						
CLS 350 CDI (219.322)	Diesel	165	04/09 → 12/10						
CLS 350 CGI (219.357)	Petrol	215	04/09 → 12/10						
CLS 500 (219.372)	Petrol	285	04/06 → 12/10						
CLS 500 (219.372)	Petrol	285	04/06 → 12/10						
CLS 500 (219.372)	Petrol	285	06/06 → 12/10	ENGINE: 30061424 →					
CLS 500 (219.375)	Petrol	225	10/04 → 12/10						
CLS 500 (219.375)	Petrol	225	10/04 → 12/10						
CLS 500 (219.375)	Petrol	225	10/04 → 12/10						
CLS 500 (219.375)	Petrol	225	10/04 → 12/10						
CLS 55 AMG (219.376)	Petrol	350	01/05 → 12/10						
CLS 55 AMG (219.376)	Petrol	350	01/05 → 12/10						
CLS 55 AMG (219.376)	Petrol	350	01/05 → 12/10						
CLS 55 AMG (219.376)	Petrol	350	01/05 → 12/10						
CLS 63 AMG (219.377)	Petrol	378	04/06 → 12/10						

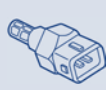
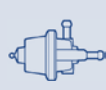

TYPE



TYPE



TYPE

								BAE680CQ		
							SAC012	H2		
							SAD028	H3		
							SAG023	H1		
							SAG023-1	H1		
									BAE680CQ	
	APS33		SPA163	F1			SAC012	H2	BAE680CX	SUA590 J3
							SAD018	H3		
							SAG023	H1		
							SAG023-1	H1		
	APS33		SPA163	F1			SAC012	H2	BAE680CX	SUA590 J3
							SAD018	H3		
							SAG023	H1		
							SAG023-1	H1		
							SAD028	H3	BAE680DF	
							SAC012	H2		
							SAC012	H2		
							SAC012	H2		
							SAC012	H2	BAE680CQ	
							SAC012	H2	BAE680CQ	
							SAC012	H2		
									ESS0077A	J1
							SAC012	H2	BAE680CR	
							SAD028	H3		
									BAE680CQ	
							SAC012	H2	BAE680CR	
							SAC012	H2		
							SAC012	H2	BAE680CR	
							SAC012	H2		
							SAD028	H3		
									BAE680CQ	
							SAC012	H2	BAE680CX	
							SAD018	H3		
							SAG023	H1		
							SAG023-1	H1		
							SAC012	H2	BAE680CX	
							SAD018	H3		
							SAG023	H1		
							SAG023-1	H1		
							SAD028	H3	BAE680DF	



KW

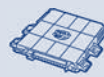

TYPE



TYPE

MERCEDES-BENZ

COUPE (C124)

220 CE (124.042)	Petrol	110	10/92 → 05/93					
220 CE (124.042)	Petrol	110	10/92 → 05/93	ENGINE: 080037 →				
220 CE (124.042)	Petrol	110	10/92 → 05/93					
220 CE (124.042)	Petrol	110	10/92 → 05/93	CHASSIS: C226336 →				
230 CE (124.043) Cat.	Petrol	97	06/89 → 12/92	ENGINE: 146597 →, 147102 →				
300 CE (124.050)	Petrol	132	03/87 → 05/93	ENGINE: 032928 →, 181462 →				
300 CE (124.050)	Petrol	132	03/87 → 05/93					
320 CE (124.052)	Petrol	162	10/92 → 05/93					
320 CE (124.052)	Petrol	162	10/92 → 05/93	ENGINE: 004357 →				
320 CE (124.052)	Petrol	162	10/92 → 05/93					
320 CE (124.052)	Petrol	162	10/92 → 05/93	CHASSIS: → C226335				

KOMBI Station wagon (S123)

280 TE (123.093)	Petrol	136	09/77 → 11/85					
------------------	--------	-----	---------------	--	--	--	--	--

KOMBI Station wagon (S124)

200 TE	Petrol	90	09/88 → 12/89					
200 TE (124.079)	Petrol	100	05/86 → 06/93					
200 TE (124.079)	Petrol	100	05/86 → 06/93	ENGINE: 028683 →				
200 TE (124.081)	Petrol	87	09/88 → 08/92	ENGINE: 036266 →, 009690 →				
200 TE (124.081)	Petrol	87	09/88 → 08/92					
220 TE (124.082)	Petrol	110	10/92 → 05/93					
220 TE (124.082)	Petrol	110	10/92 → 05/93	ENGINE: 079784 →				
230 TE (124.083)	Petrol	100	09/85 → 08/92	ENGINE: 146597 →, 147102 →				
230 TE (124.083)	Petrol	100	09/85 → 08/92					
230 TE (124.083)	Petrol	97	09/85 → 08/92					
230 TE (124.083) Cat.	Petrol	97	06/89 → 08/92	ENGINE: 146597 →, 147102 →				
230 TE (124.083) Cat.	Petrol	97	06/89 → 08/92					
260 TE FGST.	Petrol	118	09/89 → 08/92					
260 TE FGST.	Petrol	122	09/85 → 12/89					
280 TE (124.088)	Petrol	145	10/92 → 06/93					
280 TE (124.088)	Petrol	145	10/92 → 06/93	ENGINE: 048697 →				
300 TE (124.090)	Petrol	132	01/86 → 08/92	ENGINE: 032928 →, 181462 →				
300 TE (124.090)	Petrol	132	01/86 → 08/92					
300 TE (124.090)	Petrol	138	01/86 → 12/89					
300 TE 4-matic (124.290)	Petrol	132	09/86 → 06/93	ENGINE: 002188 →, 008268 →				
300 TE 4-matic (124.290)	Petrol	132	08/89 → 06/93					
300 TE 4-matic (124.290)	Petrol	138	09/86 → 08/89					
300 TE-24 (124.091)	Petrol	162	09/89 → 08/92					
320 TE (124.092)	Petrol	162	10/92 → 06/93					
320 TE (124.092)	Petrol	162	10/92 → 06/93	ENGINE: 072237 →				

SL (R129)

280 (129.058)	Petrol	142	08/93 → 05/98					
280 (129.058)	Petrol	142	08/93 → 10/01	ENGINE: 000949 → 001545				
280 (129.058)	Petrol	142	08/93 → 10/01					
280 (129.058)	Petrol	142	08/93 → 05/98					

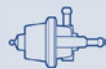

TYPE



TYPE



TYPE

			RP01A			SAC043	H2		
				ATS21	F2				
						SAD033	H3		
								ESS528	J1
				SPA136	F1				
				SPA136	F1				
								ESS528	J1
			RP01A			SAC043	H2		
				ATS21	F2				
						SAD033	H3		
								ESS528	J1
								ESS0126A	J1
								ESS528	J1
			RP01A					ESS528	J1
				ATS21	F2				
				SPA136	F1				
								ESS528	J1
			RP01A			SAC043	H2	ESS528	J1
				ATS21	F2				
				SPA136	F1				
								ESS528	J1
								ESS528	J1
				SPA136	F1				
								ESS528	J1
								ESS528	J1
								ESS528	J1
			RP01A			SAC043	H2	ESS528	J1
				ATS21	F2				
				SPA136	F1				
								ESS528	J1
								ESS528	J1
				SPA136	F1				
						SAC043	H2	ESS528	J1
			RP01A			SAC043	H2	ESS528	J1
				ATS21	F2				
			RP01A						
				ATS21	F2				
						SAC043	H2		
								ESS528	J1



KW



TYPE



TYPE

MERCEDES-BENZ

SL (R129)

280 (129.058)	Petrol	142	09/94 → 10/01						
280 (129.059)	Petrol	150	05/98 → 10/01						
280 (129.059)	Petrol	150	05/98 → 10/01						
280 (129.059)	Petrol	150	05/98 → 10/01						
280 (129.059)	Petrol	150	06/98 → 08/01						
300 SL (129.060)	Petrol	140	03/89 → 08/93						
300 SL (129.060)	Petrol	140	03/89 → 06/93						
300 SL-24 (129.061)	Petrol	170	03/89 → 07/93						
300 SL-24 (129.061)	Petrol	170	03/89 → 06/93						
320 (129.063)	Petrol	170	09/93 → 05/98						
320 (129.063)	Petrol	170	09/93 → 10/01	ENGINE: 011342 → 022858					
320 (129.063)	Petrol	170	09/93 → 10/01						
320 (129.063)	Petrol	170	09/93 → 05/98						
320 (129.063)	Petrol	170	09/94 → 10/01						
320 (129.064)	Petrol	165	05/98 → 10/01						
320 (129.064)	Petrol	165	05/98 → 10/01						
320 (129.064)	Petrol	165	05/98 → 10/01						
320 (129.064)	Petrol	165	06/98 → 08/01						
500 (129.067)	Petrol	235	09/92 → 09/95						
500 (129.067)	Petrol	235	09/92 → 10/01						
500 (129.067)	Petrol	235	09/92 → 05/98						
500 (129.067)	Petrol	235	09/94 → 12/94						
500 (129.068)	Petrol	225	05/98 → 10/01						
500 (129.068)	Petrol	225	05/98 → 10/01						
500 (129.068)	Petrol	225	05/98 → 10/01						
500 SL (129.066)	Petrol	240	09/89 → 08/92						
60 AMG (129.067)	Petrol	280	05/97 → 08/01						
60 AMG (129.067)	Petrol	280	05/97 → 10/01						
600 (129.076)	Petrol	290	07/92 → 05/98						
600 (129.076)	Petrol	290	07/92 → 10/01						
600 (129.076)	Petrol	290	07/92 → 10/01						
600 (129.076)	Petrol	290	09/95 → 10/01						
600 (129.076)	Petrol	290	07/92 → 09/95	ENGINE: M120981					

SL (R230)

280	Petrol	170	03/08 → 01/12						
300	Petrol	170	04/09 → 01/12						
350	Petrol	200	03/06 → 01/12						
350	Petrol	200	03/06 → 01/12						
350	Petrol	232	04/08 → 01/12						
350	Petrol	200	06/06 → 01/12	ENGINE: 30417697 →					
500	Petrol	285	03/06 → 01/12						
500	Petrol	285	03/06 → 01/12						
500	Petrol	285	06/06 → 01/12	ENGINE: 30061424 →					
600	Petrol	380	03/06 → 01/12						

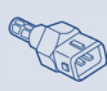
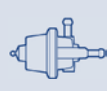

TYPE

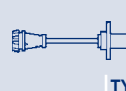

TYPE



TYPE

										PI027	J1
				SPA163	F1		SAD018	H3		PI027	J1
							SAG023	H1			
							SAG023-1	H1			
									BAE680CX		
				SPA136	F1						
										ESS528	J1
				SPA136	F1		SAC043	H2			
										ESS528	J1
			RP01A								
				ATS21	F2						
							SAC043	H2			
										ESS528	J1
										PI027	J1
				SPA163	F1		SAD018	H3		PI027	J1
							SAG023	H1			
							SAG023-1	H1			
									BAE680CX		
			RP01A								
				SPA136	F1		SAC043	H2			
										ESS528	J1
										PI027	J1
				SPA163	F1		SAD018	H3		PI027	J1
							SAG023	H1			
							SAG023-1	H1			
				SPA136	F1		SAC043	H2		ESS528	J1
			RP01A								
							SAG146	H1		PI027	J1
			RP01A								
				ATS21	F2		SAG146	H1		PI027	J1
				SPA136	F1						
							SAD018	H3			
										ESS528	J1
							SAC012	H2	BAE680CQ		
							SAC012	H2	BAE680CQ		
							SAC012	H2			
							SAD028	H3			
							SAC012	H2	BAE680CQ		
									BAE680CQ		
							SAC012	H2			
							SAD028	H3			
									BAE680CQ		
							SAG023	H1			



KW

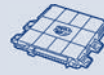

TYPE



TYPE

MERCEDES-BENZ

SL (R230)

600	Petrol	380	03/06 → 01/12						
600	Petrol	380	01/07 → 01/12						
350 (230.467)	Petrol	180	03/03 → 01/12						
350 (230.467)	Petrol	180	03/03 → 01/12						
350 (230.467)	Petrol	180	03/03 → 01/12						
350 (230.467)	Petrol	180	03/03 → 01/12						
350 (230.467)	Petrol	180	03/03 → 12/05						
500 (230.475)	Petrol	225	10/01 → 01/12						
500 (230.475)	Petrol	225	10/01 → 01/12						
500 (230.475)	Petrol	225	10/01 → 01/12						
500 (230.475)	Petrol	225	10/01 → 01/12						
55 AMG	Petrol	380	03/06 → 01/12						
55 AMG	Petrol	380	03/06 → 01/12						
55 AMG	Petrol	380	03/06 → 01/12						
55 AMG (230.474)	Petrol	350	10/01 → 06/02						
55 AMG (230.474)	Petrol	350	10/01 → 06/02						
55 AMG (230.474)	Petrol	350	10/01 → 06/02						
55 AMG Kompressor (230.474)	Petrol	368	06/02 → 01/12						
55 AMG Kompressor (230.474)	Petrol	368	06/02 → 01/12						
55 AMG Kompressor (230.474)	Petrol	368	06/02 → 01/12						
55 AMG Kompressor (230.474)	Petrol	368	06/02 → 01/12						
600 (230.476)	Petrol	368	04/03 → 01/12						
600 (230.476)	Petrol	368	04/03 → 01/12						
600 (230.476)	Petrol	368	04/03 → 01/12						
600 (230.476)	Petrol	368	03/05 → 01/12						
63 AMG (230.470)	Petrol	386	03/08 → 01/12						
65 AMG (230.479)	Petrol	450	03/04 → 01/12						
65 AMG (230.479)	Petrol	450	03/04 → 01/12						
65 AMG (230.479)	Petrol	450	03/04 → 01/12						
65 AMG (230.479)	Petrol	450	03/05 → 01/12						
65 AMG Black Series	Petrol	493	07/08 → 01/12						
65 AMG Black Series	Petrol	493	07/08 → 01/12						
65 AMG Black Series	Petrol	493	07/08 → 01/12						
65 AMG Black Series (230.479)	Petrol	493	07/08 → 01/12						
65 AMG Black Series (230.479)	Petrol	493	07/08 → 01/12						
65 AMG Black Series (230.479)	Petrol	493	07/08 → 01/12						

SLK (R170)

200 Kompressor (170.444)	Petrol	120	03/00 → 04/04						
200 Kompressor (170.444)	Petrol	120	03/00 → 04/04						
230 Kompressor (170.449)	Petrol	145	03/00 → 04/04						
230 Kompressor (170.449)	Petrol	145	03/00 → 04/04						
32 AMG Kompressor (170.466)	Petrol	260	03/01 → 04/04						
32 AMG Kompressor (170.466)	Petrol	260	03/01 → 04/04						
32 AMG Kompressor (170.466)	Petrol	260	03/01 → 04/04						



TYPE

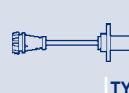

TYPE



TYPE

						SAG023-1	H1			
						SAC012	H2			
	APS33		SPA163	F1		SAC012	H2			
						SAD018	H3			
						SAG023	H1			
						SAG023-1	H1			
								BAE680CX		
	APS33		SPA163	F1		SAC012	H2	BAE680CX	PI028	J1
						SAD018	H3			
						SAG023	H1			
						SAG023-1	H1			
						SAC012	H2	BAE680CX		
						SAG023	H1			
						SAG023-1	H1			
	APS60		ATS21	F2		SAC012	H2	BAE680CX		
			SPA163	F1		SAG023	H1			
						SAG023-1	H1			
	APS60		ATS21	F2		SAC012	H2	BAE680CX		
			SPA163	F1		SAD018	H3			
						SAG023	H1			
						SAG023-1	H1			
	APS60		ATS21	F2		SAD018	H3			
			SPA163	F1		SAG023	H1			
						SAG023-1	H1			
						SAC012	H2			
								BAE680DF		
						SAD018	H3			
						SAG023	H1			
						SAG023-1	H1			
						SAC012	H2			
						SAC012	H2			
						SAG023	H1			
						SAG023-1	H1			
						SAC012	H2			
						SAG023	H1			
						SAG023-1	H1			
	APS60					SAG023	H1			
						SAG023-1	H1			
	APS60					SAG023	H1			
						SAG023-1	H1			
	APS60		ATS21	F2		SAC012	H2	BAE680CX		
			SPA163	F1		SAD018	H3			
						SAG023	H1			



KW



TYPE



TYPE

MERCEDES-BENZ

SLK (R170)

32 AMG Kompressor (170.466)	Petrol	260	03/01 → 04/04					
320 (170.465)	Petrol	160	03/00 → 04/04					
320 (170.465)	Petrol	160	03/00 → 04/04					
320 (170.465)	Petrol	160	03/00 → 04/04					
320 (170.465)	Petrol	160	03/00 → 04/04					

SLK (R171)

200 Kompressor (171.442)	Petrol	120	03/04 → 02/11					
200 Kompressor (171.442)	Petrol	120	03/04 → 02/11					
200 Kompressor (171.442)	Petrol	120	03/04 → 02/11					
200 Kompressor (171.445)	Petrol	135	01/08 → 02/11					
200 Kompressor (171.445)	Petrol	135	01/08 → 02/11					
200 Kompressor (171.445)	Petrol	135	01/08 → 02/11					
280 (171.454)	Petrol	170	01/05 → 02/11					
280 (171.454)	Petrol	170	01/05 → 02/11					
280 (171.454)	Petrol	170	06/06 → 02/11	ENGINE: 30417697 →				
300 (171.454)	Petrol	170	04/09 → 02/11					
350 (171.456)	Petrol	200	06/04 → 02/11					
350 (171.456)	Petrol	200	06/04 → 02/11					
350 (171.456)	Petrol	200	06/06 → 02/11	ENGINE: 30417697 →				
350 (171.458)	Petrol	224	01/08 → 02/11					
55 AMG (171.473)	Petrol	265	06/04 → 02/11					
55 AMG (171.473)	Petrol	265	06/04 → 02/11					
55 AMG (171.473)	Petrol	265	06/04 → 02/11					
55 AMG (171.473)	Petrol	265	06/04 → 02/11					

SLK (R172)

200 (172.448)	Petrol	135	02/11 →					
---------------	--------	-----	---------	--	--	--	--	--

SLR (R199)

5.4 (199.376)	Petrol	460	04/04 →					
5.4 (199.376)	Petrol	460	04/04 →					
5.4 (199.376)	Petrol	460	04/04 →					
5.4 (199.376)	Petrol	460	04/04 →					
5.4 722 Edition	Petrol	478	10/06 →					
5.4 722 Edition	Petrol	478	10/06 →					
5.4 722 Edition	Petrol	478	10/06 →					

SLR ROADSTER (R199)

5.4	Petrol	460	04/07 →					
5.4	Petrol	460	04/07 →					
5.4	Petrol	460	04/07 →					
5.4	Petrol	478	10/06 →					
5.4	Petrol	478	10/06 →					
5.4	Petrol	478	10/06 →					

SLS AMG (C197)

6.2 (197.377)	Petrol	420	03/10 →					
---------------	--------	-----	---------	--	--	--	--	--

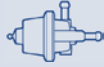

TYPE



TYPE



TYPE

						SAG023-1	H1				
	APS33					SAC012	H2	BAE680CX			
						SAD018	H3				
						SAG023	H1				
						SAG023-1	H1				
						SAC012	H2				
						SAG023	H1				
						SAG023-1	H1				
						SAC012	H2				
						SAD028	H3				
								BAE680CQ			
						SAC012	H2	BAE680CQ			
						SAC012	H2				
						SAD028	H3				
								BAE680CQ			
						SAC012	H2	BAE680CQ			
						SAC012	H2	BAE680CX			
						SAD018	H3				
						SAG023	H1				
						SAG023-1	H1				
						SAC012	H2				
						SAD018	H3				
						SAG023	H1				
						SAG023-1	H1				
						SAC012	H2	BAE680CX			
						SAD018	H3				
						SAG023	H1				
						SAG023-1	H1				
						SAC012	H2	BAE680CX			
						SAG023	H1				
						SAG023-1	H1				
						SAC012	H2	BAE680CX			
						SAG023	H1				
						SAG023-1	H1				
						SAC012	H2				



KW



TYPE



TYPE

MERCEDES-BENZ

SLS AMG Cabriolet (A197)

6.2 (197.477) Petrol 420 06/11 →

SPRINTER 2-t Autobus (901, 902)

214	Petrol	105	02/95 → 03/00					
214	Petrol	105	02/95 → 05/06	CHASSIS: P516380 →				
214	Petrol	105	02/95 → 05/06					
214	Petrol	105	02/95 → 05/06	ENGINE: 60002693 →				
214	Petrol	105	02/95 → 05/06	ENGINE: 60002693 →				
208 CDI	Diesel	60	04/00 → 05/06	ENGINE: → 835761				
208 CDI	Diesel	60	04/00 → 05/06					
208 CDI	Diesel	60	04/00 → 05/06					
208 CDI	Diesel	60	04/00 → 05/06					
208 D	Diesel	58	02/95 → 04/00	CHASSIS: P516380 →				
210 D	Diesel	75	03/97 → 04/00	CHASSIS: P516380				
210 D	Diesel	75	03/97 → 04/00					
211 CDI	Diesel	80	04/00 → 05/06	ENGINE: → 835761				
211 CDI	Diesel	80	04/00 → 05/06					
211 CDI	Diesel	80	04/00 → 05/06					
211 CDI	Diesel	80	04/00 → 05/06					
212 D	Diesel	90	02/95 → 04/00	CHASSIS: P516380	→			
212 D	Diesel	90	02/95 → 04/00					
213 CDI	Diesel	95	04/00 → 05/06	ENGINE: → 835761				
213 CDI	Diesel	95	04/00 → 05/06					
213 CDI	Diesel	95	04/00 → 05/06					
213 CDI	Diesel	95	04/00 → 05/06					
214 NGT	Bifuel	92	04/00 → 05/06			PAS005	B5	
214 NGT	Bifuel	92	04/00 → 05/06					
216 CDI	Diesel	115	04/00 → 05/06			PAS005	B5	
216 CDI	Diesel	115	04/00 → 05/06					
216 CDI	Diesel	115	04/00 → 05/06					

SPRINTER 2-t Furgonato (901, 902)

214	Petrol	105	02/95 → 05/06			PAS005	B5	
214	Petrol	105	02/95 → 03/00					
214	Petrol	105	02/95 → 05/06	CHASSIS: P516380 →				
214	Petrol	105	02/95 → 05/06					
214	Petrol	105	02/95 → 05/06	ENGINE: 60002693 →				
214	Petrol	105	02/95 → 05/06	ENGINE: 60002693 →				
208 CDI	Diesel	60	04/00 → 05/06			PAS005	B5	
208 CDI	Diesel	60	04/00 → 05/06	ENGINE: → 835761				
208 CDI	Diesel	60	04/00 → 05/06					
208 CDI	Diesel	60	04/00 → 05/06					
208 D	Diesel	58	02/95 → 04/00					
210 D	Diesel	75	01/97 → 04/00					
211 CDI	Diesel	80	04/00 → 05/06			PAS005	B5	
211 CDI	Diesel	80	04/00 → 05/06	ENGINE: → 835761				

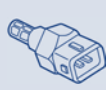
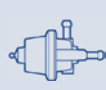

TYPE

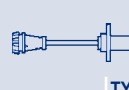

TYPE



TYPE

					SAC012	H2		
			RP01A					
				ATS21	F2			
						SAC016	H2	
						SAG023	H1	
						SAG023-1	H1	
		APS48						
				ATS21	F2	SAC012	H2	
				SPA163	F1	SAG023	H1	
						SAG023-1	H1	
				ATS21	F2			
				ATS21	F2			
						SAG146	H1	
		APS48						
				ATS21	F2	SAC012	H2	
				SPA163	F1	SAG023	H1	
						SAG023-1	H1	
				ATS21	F2			
						SAG146	H1	
		APS48						
				ATS21	F2	SAC012	H2	
				SPA163	F1	SAG023	H1	
						SAG023-1	H1	
						SAG023	H1	
						SAG023-1	H1	
				ATS21	F2	SAC012	H2	
				SPA163	F1	SAG023	H1	
						SAG023-1	H1	
						SAC016	H2	
			RP01A					
				ATS21	F2			
						SAD033	H3	
						SAG023	H1	
						SAG023-1	H1	
				ATS21	F2	SAC012	H2	
		APS48						
				SPA163	F1	SAG023	H1	
						SAG023-1	H1	
				ATS21	F2			
				ATS21	F2	SAG146	H1	
				ATS21	F2	SAC012	H2	
		APS48						



KW



TYPE



TYPE

MERCEDES-BENZ

SPRINTER 2-t Furgonato (901, 902)

211 CDI	Diesel	80	04/00 → 05/06						
211 CDI	Diesel	80	04/00 → 05/06						
212 D	Diesel	90	02/95 → 04/00						
213 CDI	Diesel	95	04/00 → 05/06				PAS005	B5	
213 CDI	Diesel	95	04/00 → 05/06						
213 CDI	Diesel	95	04/00 → 05/06						
214 NGT	Bifuel	92	04/00 → 05/06				PAS005	B5	
214 NGT	Bifuel	92	04/00 → 05/06						
216 CDI	Diesel	115	04/00 → 05/06				PAS005	B5	
216 CDI	Diesel	115	04/00 → 05/06						
216 CDI	Diesel	115	04/00 → 05/06						

SPRINTER 2-t Pianale piatto/Telaio (901, 902)

214	Petrol	105	02/95 → 05/06				PAS005	B5	
214	Petrol	105	02/95 → 03/00						
214	Petrol	105	02/95 → 05/06	CHASSIS: P516380 →					
214	Petrol	105	02/95 → 05/06	ENGINE: 60002693 →					
214	Petrol	105	02/95 → 05/06	ENGINE: 60002693 →					
208 CDI	Diesel	60	04/00 → 05/06				PAS005	B5	
208 CDI	Diesel	60	04/00 → 05/06	ENGINE: → 835761					
208 CDI	Diesel	60	04/00 → 05/06						
208 CDI	Diesel	60	04/00 → 05/06						
208 D	Diesel	58	01/95 → 04/00						
210 D	Diesel	75	01/97 → 04/00						
211 CDI	Diesel	80	04/00 → 05/06				PAS005	B5	
211 CDI	Diesel	80	04/00 → 05/06	ENGINE: → 835761					
211 CDI	Diesel	80	04/00 → 05/06						
211 CDI	Diesel	80	04/00 → 05/06						
212 D	Diesel	90	02/95 → 04/00						
213 CDI	Diesel	95	04/00 → 05/06				PAS005	B5	
213 CDI	Diesel	95	04/00 → 05/06	ENGINE: → 835761					
213 CDI	Diesel	95	04/00 → 05/06						
213 CDI	Diesel	95	04/00 → 05/06						
214 NGT	Bifuel	92	04/00 → 05/06				PAS005	B5	
214 NGT	Bifuel	92	04/00 → 05/06						
216 CDI	Diesel	115	04/00 → 05/06				PAS005	B5	
216 CDI	Diesel	115	04/00 → 05/06						
216 CDI	Diesel	115	04/00 → 05/06						

SPRINTER 3,5-t Autobus (906)

310 CDI (906.731, 906.733, 906.735)	Diesel	70	03/09 →						
310 CDI (906.731, 906.733, 906.735)	Diesel	70	03/09 →						
311 CDI (906.731, 906.733, 906.735)	Diesel	80	06/06 →						



KW



TYPE



TYPE

MERCEDES-BENZ

SPRINTER 3,5-t Autobus (906)

311 CDI (906.731, 906.733, 906.735)	Diesel	80	06/06 →						
311 CDI (906.731, 906.733, 906.735)	Diesel	80	06/06 →						
311 CDI 4x4 (906.731, 906.733, 906.735)	Diesel	80	02/08 →						
311 CDI 4x4 (906.731, 906.733, 906.735)	Diesel	80	02/08 →						
311 CDI 4x4 (906.731, 906.733, 906.735)	Diesel	80	02/08 →						
315 CDI (906.731, 906.733, 906.735)	Diesel	110	06/06 →						
315 CDI (906.731, 906.733, 906.735)	Diesel	110	06/06 →						
315 CDI (906.731, 906.733, 906.735)	Diesel	110	06/06 →						
315 CDI 4x4 (906.731, 906.733, 906.735)	Diesel	110	02/08 →						
315 CDI 4x4 (906.731, 906.733, 906.735)	Diesel	110	02/08 →						
315 CDI 4x4 (906.731, 906.733, 906.735)	Diesel	110	02/08 →						
316 (906.733, 906.735)	Petrol	115	03/09 →						
316 (906.733, 906.735)	Petrol	115	03/09 →						
316 (906.733, 906.735)	Petrol	115	03/09 →						
316 NGT (906.733, 906.735)	Petrol/CNG	115	03/09 →						
316 NGT (906.733, 906.735)	Petrol/CNG	115	03/09 →						
316 NGT (906.733, 906.735)	Petrol/CNG	115	03/09 →						
318 CDI (906.731, 906.733, 906.735)	Diesel	135	02/08 →						
318 CDI 4x4 (906.731, 906.733, 906.735)	Diesel	135	02/08 →						
319 CDI / BlueTEC (906.731, 906.733, 906.735)	Diesel	140	03/09 →						
319 CDI / BlueTEC 4x4 (906.731, 906.733, 906.735)	Diesel	140	03/09 →						
324 (906.733, 906.735)	Petrol	190	06/06 →						
324 (906.733, 906.735)	Petrol	190	06/06 →						

SPRINTER 3,5-t Furgonato (906)

309 CDI (906.631, 906.633, 906.635, 906.637)	Diesel	65	06/06 →						
309 CDI (906.631, 906.633, 906.635, 906.637)	Diesel	65	06/06 →						



TYPE



TYPE



TYPE

						SAG023	H1			
						SAG023-1	H1			
						SAC012	H2		GA2199	J2
						SAG023	H1			
						SAG023-1	H1			
						SAC012	H2		GA2177	J2
						SAG023	H1			
						SAG023-1	H1			
						SAC012	H2		GA2200	J2
						SAG023	H1			
						SAG023-1	H1			
						SAC012	H2			
						SAG023	H1			
						SAG023-1	H1			
						SAC012	H2			
						SAC012	H2		GA2199	J2
									GA2090	J2
									GA2090	J2
						SAC012	H2	BAE680CQ		
						SAD028	H3			
						SAC012	H2		GA2177	J2
						SAG023	H1			



KW



TYPE



TYPE

MERCEDES-BENZ

SPRINTER 3,5-t Furgonato (906)

309 CDI (906.631, 906.633, 906.635, 906.637)	Diesel	65	06/06 →					
310 CDI (906.631, 906.633, 906.635, 906.637)	Diesel	70	03/09 →					
310 CDI (906.631, 906.633, 906.635, 906.637)	Diesel	70	03/09 →					
311 CDI (906.631, 906.633, 906.635, 906.637)	Diesel	80	06/06 →					
311 CDI (906.631, 906.633, 906.635, 906.637)	Diesel	80	06/06 →					
311 CDI (906.631, 906.633, 906.635, 906.637)	Diesel	80	06/06 →					
311 CDI 4x4 (906.631, 906.633, 906.635, 906.637)	Diesel	80	02/08 →					
311 CDI 4x4 (906.631, 906.633, 906.635, 906.637)	Diesel	80	02/08 →					
311 CDI 4x4 (906.631, 906.633, 906.635, 906.637)	Diesel	80	02/08 →					
313 CDI (906.631, 906.633, 906.635, 906.637)	Diesel	95	06/06 →					
313 CDI (906.631, 906.633, 906.635, 906.637)	Diesel	95	06/06 →					
313 CDI (906.631, 906.633, 906.635, 906.637)	Diesel	95	06/06 →					
315 CDI (906.631, 906.633, 906.635, 906.637)	Diesel	110	06/06 →					
315 CDI (906.631, 906.633, 906.635, 906.637)	Diesel	110	06/06 →					
315 CDI (906.631, 906.633, 906.635, 906.637)	Diesel	110	06/06 →					
315 CDI 4x4 (906.631, 906.633, 906.635, 906.637)	Diesel	110	02/08 →					
315 CDI 4x4 (906.631, 906.633, 906.635, 906.637)	Diesel	110	02/08 →					
315 CDI 4x4 (906.631, 906.633, 906.635, 906.637)	Diesel	110	02/08 →					
316 (906.663, 906.635)	Petrol	115	09/08 →					
316 (906.663, 906.635)	Petrol	115	03/09 →					
316 (906.663, 906.635)	Petrol	115	03/09 →					
316 CDI (906.631, 906.633, 906.635, 906.637)	Diesel	120	03/09 →					
316 CDI (906.631, 906.633, 906.635, 906.637)	Diesel	120	03/09 →					

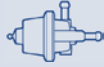

TYPE



TYPE



TYPE

						SAG023-1	H1			
						SAG023	H1		GA2200	J2
						SAG023-1	H1			
						SAC012	H2		GA2177	J2
						SAG023	H1			
						SAG023-1	H1			
						SAC012	H2		GA2199	J2
						SAG023	H1			
						SAG023-1	H1			
						SAC012	H2		GA2200	J2
						SAG023	H1			
						SAG023-1	H1			
						SAC012	H2		GA2177	J2
						SAG023	H1			
						SAG023-1	H1			
						SAC012	H2		GA2200	J2
						SAG023	H1			
						SAG023-1	H1			
						SAC012	H2			
						SAG023	H1			
						SAG023-1	H1			
						SAG023	H1		GA2200	J2
						SAG023-1	H1			



KW



TYPE



TYPE

MERCEDES-BENZ

SPRINTER 3,5-t Furgonato (906)

316 CDI 4x4 (906.631, 906.633, 906.635, 906.637)	Diesel	120	03/09 →					
316 CDI 4x4 (906.631, 906.633, 906.635, 906.637)	Diesel	120	03/09 →					
316 NGT (906.633, 906.635)	Petrol/CNG	115	03/09 →					
316 NGT (906.633, 906.635)	Petrol/CNG	115	03/09 →					
316 NGT (906.633, 906.635)	Petrol/CNG	115	03/09 →					
318 CDI (906.631, 906.633, 906.635, 906.637)	Diesel	135	06/06 →					
318 CDI 4x4 (906.631, 906.633, 906.635, 906.637)	Diesel	135	02/08 →					
319 CDI / BlueTEC (906.631, 906.633, 906.635, 906.637)	Diesel	140	03/09 →					
324 (906.633, 906.635, 906.637)	Petrol	190	06/06 →					
324 (906.633, 906.635, 906.637)	Petrol	190	06/06 →					

SPRINTER 3,5-t Pianale piatto/Telaio (906)

309 CDI (906.131, 906.133, 906.135, 906.231, 906.233...)	Diesel	65	06/06 →					
309 CDI (906.131, 906.133, 906.135, 906.231, 906.233...)	Diesel	65	06/06 →					
309 CDI (906.131, 906.133, 906.135, 906.231, 906.233...)	Diesel	65	06/06 →					
310 CDI (906.131, 906.133, 906.135, 906.231, 906.233...)	Diesel	70	03/09 →					
310 CDI (906.131, 906.133, 906.135, 906.231, 906.233...)	Diesel	70	03/09 →					
311 CDI (906.131, 906.133, 906.135, 906.231, 906.233...)	Diesel	80	06/06 →					
311 CDI (906.131, 906.133, 906.135, 906.231, 906.233...)	Diesel	80	06/06 →					
311 CDI (906.131, 906.133, 906.135, 906.231, 906.233...)	Diesel	80	06/06 →					
311 CDI 4x4 (906.131, 906.133, 906.135, 906.231...)	Diesel	80	02/08 →					
311 CDI 4x4 (906.131, 906.133, 906.135, 906.231...)	Diesel	80	02/08 →					
311 CDI 4x4 (906.131, 906.133, 906.135, 906.231...)	Diesel	80	02/08 →					
313 CDI (906.131, 906.133, 906.135, 906.231, 906.233...)	Diesel	95	06/06 →					
313 CDI (906.131, 906.133, 906.135, 906.231, 906.233...)	Diesel	95	06/06 →					
313 CDI (906.131, 906.133, 906.135, 906.231, 906.233...)	Diesel	95	06/06 →					

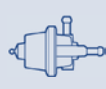

TYPE

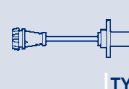

TYPE



TYPE

						SAG023	H1		GA2200	J2
						SAG023-1	H1			
						SAC012	H2			
						SAG023	H1			
						SAG023-1	H1			
						SAC012	H2		GA2177	J2
						SAC012	H2		GA2199	J2
						SAC012	H2		GA2090	J2
						SAC012	H2	BAE680CQ		
						SAD028	H3			
						SAC012	H2		GA2177	J2
						SAG023	H1			
						SAG023-1	H1			
						SAG023	H1		GA2200	J2
						SAG023-1	H1			
						SAC012	H2		GA2177	J2
						SAG023	H1			
						SAG023-1	H1			
						SAC012	H2		GA2199	J2
						SAG023	H1			
						SAG023-1	H1			
						SAC012	H2		GA2200	J2
						SAG023	H1			
						SAG023-1	H1			



KW

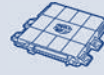

TYPE



TYPE

MERCEDES-BENZ

SPRINTER 3,5-t Pianale piatto/Telaio (906)

315 CDI (906.131, 906.133, 906.135, 906.231, 906.233...)	Diesel	110	06/06 →					
315 CDI (906.131, 906.133, 906.135, 906.231, 906.233...)	Diesel	110	06/06 →					
315 CDI (906.131, 906.133, 906.135, 906.231, 906.233...)	Diesel	110	06/06 →					
315 CDI 4x4 (906.131, 906.133, 906.135, 906.231...)	Diesel	110	02/08 →					
315 CDI 4x4 (906.131, 906.133, 906.135, 906.231...)	Diesel	110	02/08 →					
315 CDI 4x4 (906.131, 906.133, 906.135, 906.231...)	Diesel	110	02/08 →					
316 (906.133, 906.135, 906.233, 906.235)	Petrol	115	09/08 →					
316 (906.133, 906.135, 906.233, 906.235)	Petrol	115	09/08 →					
316 (906.133, 906.135, 906.233, 906.235)	Petrol	115	09/08 →					
316 CDI (906.131, 906.133, 906.135, 906.231, 906.233...)	Diesel	120	03/09 →					
316 CDI (906.131, 906.133, 906.135, 906.231, 906.233...)	Diesel	120	03/09 →					
316 CDI 4x4 (906.131, 906.133, 906.135, 906.231...)	Diesel	120	03/09 →					
316 CDI 4x4 (906.131, 906.133, 906.135, 906.231...)	Diesel	120	03/09 →					
316 NGT (906.133, 906.135, 906.233, 906.235)	Petrol/CNG	115	09/08 →					
316 NGT (906.133, 906.135, 906.233, 906.235)	Petrol/CNG	115	09/08 →					
316 NGT (906.133, 906.135, 906.233, 906.235)	Petrol/CNG	115	03/09 →					
318 CDI (906.131, 906.133, 906.135, 906.231, 906.233...)	Diesel	135	06/06 →					
318 CDI 4x4 (906.131, 906.133, 906.135, 906.231...)	Diesel	135	02/08 →					
319 CDI / BlueTEC (906.131, 906.133, 906.135, 906.231...)	Diesel	140	03/09 →					
319 CDI 4x4 (906.131, 906.133, 906.135, 906.231, 906.235)	Diesel	140	05/11 →					
324 (906.133, 906.135, 906.233, 906.235)	Petrol	190	06/06 →					
324 (906.133, 906.135, 906.233, 906.235)	Petrol	190	06/06 →					

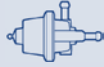

TYPE



TYPE



TYPE

							SAC012	H2		GA2177	J2
							SAG023	H1			
							SAG023-1	H1			
							SAC012	H2		GA2200	J2
							SAG023	H1			
							SAG023-1	H1			
							SAC012	H2			
							SAG023	H1			
							SAG023-1	H1			
							SAG023	H1		GA2200	J2
							SAG023-1	H1			
							SAG023	H1			
							SAG023-1	H1			
							SAG023	H1			
							SAG023-1	H1			
							SAG023	H1			
							SAG023-1	H1			
							SAG023	H1			
							SAG023-1	H1			
							SAC012	H2			
							SAC012	H2		GA2177	J2
							SAC012	H2		GA2199	J2
							SAC012	H2		GA2090	J2
							SAC012	H2			
							SAC012	H2	BAE680CQ		
							SAD028	H3			



KW

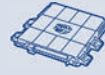

TYPE



TYPE

MERCEDES-BENZ

SPRINTER 3-t Autobus (903)

314	Petrol	105	02/95 → 05/06				PAS005	B5
314	Petrol	105	02/95 → 08/02					
314	Petrol	105	02/95 → 05/06	CHASSIS: P516380 →				
314	Petrol	105	02/95 → 05/06					
314	Petrol	105	02/95 → 05/06					
308 CDI	Diesel	60	04/00 → 05/06				PAS005	B5
308 CDI	Diesel	60	04/00 → 05/06	ENGINE: → 835761				
308 CDI	Diesel	60	04/00 → 05/06					
308 CDI	Diesel	60	04/00 → 05/06					
308 D	Diesel	58	02/95 → 04/00					
310 D 4x4	Diesel	75	05/97 → 08/02					
310 D 4x4	Diesel	75	05/97 → 03/00					
311 CDI	Diesel	80	04/00 → 05/06				PAS005	B5
311 CDI	Diesel	80	04/00 → 05/06	ENGINE: → 835761				
311 CDI	Diesel	80	04/00 → 05/06					
311 CDI	Diesel	80	04/00 → 05/06					
311 CDI 4x4	Diesel	80	08/02 → 05/06				PAS005	B5
311 CDI 4x4	Diesel	80	08/02 → 05/06	ENGINE: → 835761				
311 CDI 4x4	Diesel	80	08/02 → 05/06					
311 CDI 4x4	Diesel	80	08/02 → 05/06					
312 D 2.9	Diesel	90	02/95 → 04/00					
312 D 2.9 4x4	Diesel	90	05/97 → 08/02					
312 D 2.9 4x4	Diesel	90	05/97 → 03/00					
313 CDI	Diesel	95	04/00 → 05/06				PAS005	B5
313 CDI	Diesel	95	04/00 → 05/06	ENGINE: → 835761				
313 CDI	Diesel	95	04/00 → 05/06					
313 CDI	Diesel	95	04/00 → 05/06					
313 CDI 4x4	Diesel	95	08/02 → 05/06				PAS005	B5
313 CDI 4x4	Diesel	95	08/02 → 05/06	ENGINE: → 835761				
313 CDI 4x4	Diesel	95	08/02 → 05/06					
313 CDI 4x4	Diesel	95	08/02 → 05/06					
314 4x4	Petrol	105	08/02 → 05/06				PAS005	B5
314 4x4	Petrol	105	08/02 → 05/06					
314 4x4	Petrol	105	08/02 → 05/06	CHASSIS: R000001 →				
314 4x4	Petrol	105	08/02 → 05/06					
314 4x4	Petrol	105	08/02 → 05/06					
314 NGT	Bifuel	92	04/00 → 05/06				PAS005	B5
316 CDI	Diesel	115	04/00 → 05/06				PAS005	B5
316 CDI	Diesel	115	04/00 → 05/06					
316 CDI	Diesel	115	04/00 → 05/06					
316 CDI 4x4	Diesel	115	08/02 → 05/06				PAS005	B5
316 CDI 4x4	Diesel	115	08/02 → 05/06					
316 CDI 4x4	Diesel	115	08/02 → 05/06					



TYPE



TYPE



TYPE

						SAC016	H2		
			RP01A						
				ATS21	F2				
						SAG023	H1		
						SAG023-1	H1		
				ATS21	F2	SAC012	H2		
	APS48								
				SPA163	F1	SAG023	H1		
						SAG023-1	H1		
				ATS21	F2				
				ATS21	F2				
						SAG146	H1		
				ATS21	F2	SAC012	H2		
	APS48								
				SPA163	F1	SAG023	H1		
						SAG023-1	H1		
				ATS21	F2	SAC012	H2		
	APS48								
				SPA163	F1	SAG023	H1		
						SAG023-1	H1		
				ATS21	F2	SAG146	H1		
				ATS21	F2				
						SAG146	H1		
						SAC012	H2		
	APS48								
						SAG023	H1		
						SAG023-1	H1		
				ATS21	F2	SAC012	H2		
	APS48								
				SPA163	F1	SAG023	H1		
						SAG023-1	H1		
			RP01A			SAC016	H2		
						SAD033	H3		
				ATS21	F2				
						SAG023	H1		
						SAG023-1	H1		
				ATS21	F2	SAC012	H2		
				SPA163	F1	SAG023	H1		
						SAG023-1	H1		
				ATS21	F2	SAC012	H2		
				SPA163	F1	SAG023	H1		
						SAG023-1	H1		



KW

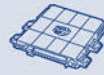

TYPE



TYPE

MERCEDES-BENZ

SPRINTER 3-t Autobus (906)

210 CDI (906.711, 906.713)	Diesel	70	03/09 →						
211 CDI (906.711, 906.713)	Diesel	80	06/06 →						
211 CDI (906.711, 906.713)	Diesel	80	06/06 →						
211 CDI (906.711, 906.713)	Diesel	80	06/06 →						
215 CDI (906.711, 906.713)	Diesel	110	06/06 →						
215 CDI (906.711, 906.713)	Diesel	110	06/06 →						
215 CDI (906.711, 906.713)	Diesel	110	06/06 →						
216 (906.713)	Petrol	115	03/09 →						
216 (906.713)	Petrol	115	03/09 →						
216 (906.713)	Petrol	115	03/09 →						
224 (906.713)	Petrol	190	06/06 →						

SPRINTER 3-t Furgonato (903)

314	Petrol	105	02/95 → 05/06				PAS005	B5	
314	Petrol	105	02/95 → 08/02						
314	Petrol	105	02/95 → 05/06	CHASSIS: P516380 →					
314	Petrol	105	02/95 → 05/06						
314	Petrol	105	02/95 → 05/06						
314	Petrol	105	02/95 → 05/06						
308 CDI	Diesel	60	04/00 → 05/06				PAS005	B5	
308 CDI	Diesel	60	04/00 → 05/06	ENGINE: → 835761					
308 CDI	Diesel	60	04/00 → 05/06						
308 CDI	Diesel	60	04/00 → 05/06						
308 D 2.3	Diesel	58	02/95 → 04/00						
310 D 2.9	Diesel	75	02/95 → 04/00						
310 D 2.9	Diesel	75	01/97 → 04/00						
311 CDI	Diesel	80	04/00 → 05/06				PAS005	B5	
311 CDI	Diesel	80	04/00 → 05/06	ENGINE: → 835761					
311 CDI	Diesel	80	04/00 → 05/06						
311 CDI	Diesel	80	04/00 → 05/06						
311 CDI 4x4	Diesel	80	08/02 → 05/06				PAS005	B5	
311 CDI 4x4	Diesel	80	08/02 → 05/06	ENGINE: → 835761					
311 CDI 4x4	Diesel	80	08/02 → 05/06						
311 CDI 4x4	Diesel	80	08/02 → 05/06						
312 D 2.9	Diesel	90	02/95 → 04/00						
312 D 2.9 4x4	Diesel	90	05/97 → 03/00						
313 CDI	Diesel	95	04/00 → 05/06				PAS005	B5	
313 CDI	Diesel	95	04/00 → 05/06	ENGINE: → 835761					
313 CDI	Diesel	95	04/00 → 05/06						
313 CDI	Diesel	95	04/00 → 05/06						
313 CDI 4x4	Diesel	95	08/02 → 05/06				PAS005	B5	
313 CDI 4x4	Diesel	95	08/02 → 05/06	ENGINE: → 835761					
313 CDI 4x4	Diesel	95	08/02 → 05/06						
313 CDI 4x4	Diesel	95	08/02 → 05/06						
314 4x4	Petrol	105	08/02 → 05/06				PAS005	B5	



KW

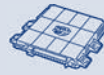

TYPE



TYPE

MERCEDES-BENZ

SPRINTER 3-t Furgonato (903)

314 4x4	Petrol	105	08/02 → 05/06					
314 4x4	Petrol	105	08/02 → 05/06	CHASSIS: R000001 →				
314 4x4	Petrol	105	08/02 → 05/06					
314 NGT	Bifuel	92	04/00 → 05/06				PAS005	B5
316 CDI	Diesel	115	04/00 → 05/06				PAS005	B5
316 CDI	Diesel	115	04/00 → 05/06					
316 CDI	Diesel	115	04/00 → 05/06					
316 CDI 4x4	Diesel	115	08/02 → 05/06				PAS005	B5
316 CDI 4x4	Diesel	115	08/02 → 05/06					
316 CDI 4x4	Diesel	115	08/02 → 05/06					

SPRINTER 3-t Furgonato (906)

209 CDI (906.611, 906.613)	Diesel	65	06/06 →					
209 CDI (906.611, 906.613)	Diesel	65	06/06 →					
209 CDI (906.611, 906.613)	Diesel	65	06/06 →					
210 CDI (906.611, 906.613)	Diesel	70	03/09 →					
210 CDI (906.611, 906.613)	Diesel	70	03/09 →					
211 CDI (906.611, 906.613)	Diesel	80	06/06 →					
211 CDI (906.611, 906.613)	Diesel	80	06/06 →					
211 CDI (906.611, 906.613)	Diesel	80	06/06 →					
213 CDI (906.611, 906.613)	Diesel	95	06/06 →					
213 CDI (906.611, 906.613)	Diesel	95	06/06 →					
213 CDI (906.611, 906.613)	Diesel	95	06/06 →					
215 CDI (906.611, 906.613)	Diesel	110	06/06 →					
215 CDI (906.611, 906.613)	Diesel	110	06/06 →					
215 CDI (906.611, 906.613)	Diesel	110	06/06 →					
216 (906.613)	Petrol	115	09/08 →					
216 (906.613)	Petrol	115	09/08 →					
216 (906.613)	Petrol	115	09/08 →					
216 CDI (906.611, 906.613)	Diesel	120	03/09 →					
216 CDI (906.611, 906.613)	Diesel	120	03/09 →					
218 CDI (906.611, 906.613)	Diesel	135	06/06 →					
219 CDI / BlueTEC (906.611, 906.613)	Diesel	140	03/09 →					
219 CDI / BlueTEC (906.611, 906.613)	Diesel	140	03/09 →					
224 (906.613)	Petrol	190	06/06 →					
224 (906.613)	Petrol	190	06/06 →					

SPRINTER 3-t Pianale piatto/Telaio (903)

314	Petrol	105	02/95 → 05/06				PAS005	B5
314	Petrol	105	02/95 → 05/06	CHASSIS: P516380 →				
314	Petrol	105	02/95 → 05/06					
314	Petrol	105	02/95 → 05/06					
308 CDI	Diesel	60	04/00 → 05/06				PAS005	B5
308 CDI	Diesel	60	04/00 → 05/06	ENGINE: → 835761				

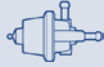

TYPE



TYPE



TYPE

						SAG023	H1		
				ATS21	F2				
						SAG023-1	H1		
				ATS21	F2	SAC012	H2		
				SPA163	F1	SAG023	H1		
						SAG023-1	H1		
				ATS21	F2	SAC012	H2		
				SPA163	F1	SAG023	H1		
						SAG023-1	H1		
						SAC012	H2	GA2177	J2
						SAG023	H1		
						SAG023-1	H1		
						SAG023	H1	GA2200	J2
						SAG023-1	H1		
						SAC012	H2	GA2177	J2
						SAG023	H1		
						SAG023-1	H1		
						SAC012	H2	GA2177	J2
						SAG023	H1		
						SAG023-1	H1		
						SAC012	H2	GA2177	J2
						SAG023	H1		
						SAG023-1	H1		
						SAG023	H1	GA2200	J2
						SAG023-1	H1		
						SAC012	H2	GA2177	J2
						SAG023	H1	GA2090	J2
						SAG023-1	H1		
						SAC012	H2	BAE680CQ	
						SAD028	H3		
						SAC016	H2		
				ATS21	F2				
						SAG023	H1		
						SAG023-1	H1		
				ATS21	F2	SAC012	H2		
	APS48								



KW



TYPE



TYPE

MERCEDES-BENZ

SPRINTER 3-t Pianale piatto/Telaio (903)

308 CDI	Diesel	60	04/00 → 05/06						
308 CDI	Diesel	60	04/00 → 05/06						
308 D 2.3	Diesel	58	02/95 → 04/00						
310 D 2.9	Diesel	75	01/97 → 04/00						
311 CDI	Diesel	80	04/00 → 05/06				PAS005	B5	
311 CDI	Diesel	80	04/00 → 05/06	ENGINE: → 835761					
311 CDI	Diesel	80	04/00 → 05/06						
311 CDI	Diesel	80	04/00 → 05/06						
311 CDI 4x4	Diesel	80	08/02 → 05/06				PAS005	B5	
311 CDI 4x4	Diesel	80	08/02 → 05/06	ENGINE: → 835761					
311 CDI 4x4	Diesel	80	08/02 → 05/06						
311 CDI 4x4	Diesel	80	08/02 → 05/06						
312 D 2.9	Diesel	90	02/95 → 04/00						
313 CDI	Diesel	95	04/00 → 05/06				PAS005	B5	
313 CDI	Diesel	95	04/00 → 05/06	ENGINE: → 835761					
313 CDI	Diesel	95	04/00 → 05/06						
313 CDI	Diesel	95	04/00 → 05/06						
313 CDI 4x4	Diesel	95	08/02 → 05/06				PAS005	B5	
313 CDI 4x4	Diesel	95	08/02 → 05/06	ENGINE: → 835761					
313 CDI 4x4	Diesel	95	08/02 → 05/06						
313 CDI 4x4	Diesel	95	08/02 → 05/06						
314 4x4	Petrol	105	08/02 → 05/06				PAS005	B5	
314 4x4	Petrol	105	08/02 → 05/06	CHASSIS: R000001 →					
314 4x4	Petrol	105	08/02 → 05/06						
314 4x4	Petrol	105	08/02 → 05/06						
314 NGT	Bifuel	92	04/00 → 05/06				PAS005	B5	
316 CDI	Diesel	115	04/00 → 05/06				PAS005	B5	
316 CDI	Diesel	115	04/00 → 05/06						
316 CDI	Diesel	115	04/00 → 05/06						
316 CDI 4x4	Diesel	115	08/02 → 05/06				PAS005	B5	
316 CDI 4x4	Diesel	115	08/02 → 05/06						
316 CDI 4x4	Diesel	115	08/02 → 05/06						

SPRINTER 3-t Pianale piatto/Telaio (906)

209 CDI (906.111, 906.113, 906.211, 906.213)	Diesel	65	06/06 →						
209 CDI (906.111, 906.113, 906.211, 906.213)	Diesel	65	06/06 →						
209 CDI (906.111, 906.113, 906.211, 906.213)	Diesel	65	06/06 →						
210 CDI (906.111, 906.113, 906.211, 906.213)	Diesel	70	03/09 →						
210 CDI (906.111, 906.113, 906.211, 906.213)	Diesel	70	03/09 →						

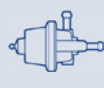

TYPE

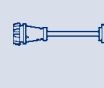

TYPE



TYPE

				SPA163	F1		SAG023	H1		
							SAG023-1	H1		
				ATS21	F2					
				ATS21	F2		SAG146	H1		
				ATS21	F2		SAC012	H2		
		APS48								
				SPA163	F1		SAG023	H1		
							SAG023-1	H1		
				ATS21	F2		SAC012	H2		
		APS48								
				SPA163	F1		SAG023	H1		
							SAG023-1	H1		
				ATS21	F2		SAG146	H1		
				ATS21	F2		SAC012	H2		
		APS48								
				SPA163	F1		SAG023	H1		
							SAG023-1	H1		
							SAC012	H2		
		APS48								
							SAG023	H1		
							SAG023-1	H1		
							SAC016	H2		
				ATS21	F2					
							SAG023	H1		
							SAG023-1	H1		
				ATS21	F2		SAC012	H2		
				SPA163	F1		SAG023	H1		
							SAG023-1	H1		
				ATS21	F2		SAC012	H2		
				SPA163	F1		SAG023	H1		
							SAG023-1	H1		
							SAC012	H2		GA2177
							SAG023	H1		
							SAG023-1	H1		
							SAG023	H1		GA2200
							SAG023-1	H1		J2

KW

TYPE

TYPE
MERCEDES-BENZ
SPRINTER 3-t Pianale piatto/Telaio (906)

211 CDI (906.111, 906.113, 906.211, 906.213)	Diesel	80	06/06 →					
211 CDI (906.111, 906.113, 906.211, 906.213)	Diesel	80	06/06 →					
211 CDI (906.111, 906.113, 906.211, 906.213)	Diesel	80	06/06 →					
213 CDI (906.111, 906.113, 906.211, 906.213)	Diesel	95	03/09 →					
213 CDI (906.111, 906.113, 906.211, 906.213)	Diesel	95	03/09 →					
213 CDI (906.111, 906.113, 906.211, 906.213)	Diesel	95	06/06 →					
213 CDI (906.111, 906.113, 906.211, 906.213)	Diesel	95	06/06 →					
213 CDI (906.111, 906.113, 906.211, 906.213)	Diesel	95	06/06 →					
215 CDI (906.111, 906.113, 906.211, 906.213)	Diesel	110	06/06 →					
215 CDI (906.111, 906.113, 906.211, 906.213)	Diesel	110	06/06 →					
215 CDI (906.111, 906.113, 906.211, 906.213)	Diesel	110	06/06 →					
216 (906.113, 906.213)	Petrol	115	09/08 →					
216 (906.113, 906.213)	Petrol	115	09/08 →					
216 (906.113, 906.213)	Petrol	115	09/08 →					
216 CDI (906.111, 906.113, 906.211, 906.213)	Diesel	120	03/09 →					
216 CDI (906.111, 906.113, 906.211, 906.213)	Diesel	120	03/09 →					
218 CDI (906.111, 906.113, 906.211, 906.213)	Diesel	135	06/06 →					
219 CDI / BlueTEC (906.111, 906.113, 906.211, 906.213)	Diesel	140	03/09 →					
219 CDI / BlueTEC (906.111, 906.113, 906.211, 906.213)	Diesel	140	03/09 →					
224 (906.113, 906.213)	Petrol	190	06/06 →					
224 (906.113, 906.213)	Petrol	190	06/06 →					

SPRINTER 4,6-t Furgonato (906)

413 CDI (906.653, 906.655, 906.657)	Diesel	95	06/06 →					
416 CDI (906.653, 906.655, 906.657)	Diesel	120	03/09 →					
416 CDI (906.653, 906.655, 906.657)	Diesel	120	03/09 →					

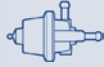

TYPE



TYPE



TYPE

						SAC012	H2		GA2177	J2
						SAG023	H1			
						SAG023-1	H1			
						SAG023	H1		GA2200	J2
						SAG023-1	H1			
						SAC012	H2		GA2177	J2
						SAG023	H1			
						SAG023-1	H1			
						SAC012	H2		GA2177	J2
						SAG023	H1			
						SAG023-1	H1			
						SAC012	H2			
						SAG023	H1			
						SAG023-1	H1			
						SAG023	H1		GA2200	J2
						SAG023-1	H1			
						SAC012	H2		GA2177	J2
						SAG023	H1		GA2090	J2
						SAG023-1	H1			
						SAC012	H2	BAE680CQ		
						SAD028	H3			
						SAC012	H2			
						SAG023	H1			
						SAG023-1	H1			



KW

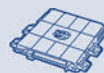

TYPE



TYPE

MERCEDES-BENZ

SPRINTER 4,6-t Furgonato (906)

419 CDI (906.653, 906.655, 906.657)	Diesel	140	03/09 →					
424 (906.953, 906.655, 906.657)	Petrol	190	06/06 →					

SPRINTER 4,6-t Pianale piatto/Telaio (906)

413 CDI (906.153, 906.155, 906.253, 906.255)	Diesel	95	06/06 →					
413 CDI (906.153, 906.155, 906.253, 906.255)	Diesel	95	06/06 →					
413 CDI (906.153, 906.155, 906.253, 906.255)	Diesel	95	06/06 →					
415 CDI (906.153, 906.155, 906.253, 906.255)	Diesel	110	06/06 → 12/10					
415 CDI (906.153, 906.155, 906.253, 906.255)	Diesel	110	06/06 →					
416 CDI (906.153, 906.155, 906.253, 906.255)	Diesel	120	03/09 →					
416 CDI (906.153, 906.155, 906.253, 906.255)	Diesel	120	03/09 →					
418 CDI (906.153, 906.155, 906.253, 906.255)	Diesel	135	06/06 → 12/10					
418 CDI (906.153, 906.155, 906.253, 906.255)	Diesel	135	06/06 →					
419 CDI (906.153, 906.155, 906.253, 906.255)	Diesel	140	03/09 →					
424 (906.153, 906.155, 906.253, 906.255)	Petrol	190	06/06 →					

SPRINTER 4-t Autobus (904)

414	Petrol	105	02/96 → 05/06			PAS005	B5
414	Petrol	105	02/96 → 03/00				
414	Petrol	105	02/96 → 05/06	CHASSIS: P516380 →			
414	Petrol	105	02/96 → 05/06				
414	Petrol	105	02/96 → 05/06				
408 CDI	Diesel	60	04/00 → 05/06			PAS005	B5
408 CDI	Diesel	60	04/00 → 05/06	ENGINE: → 835761			
408 CDI	Diesel	60	04/00 → 05/06				
408 CDI	Diesel	60	04/00 → 05/06				
411 CDI	Diesel	80	04/00 → 05/06			PAS005	B5
411 CDI	Diesel	80	04/00 → 05/06	ENGINE: → 835761			
411 CDI	Diesel	80	04/00 → 05/06				
411 CDI	Diesel	80	04/00 → 05/06				
413 CDI	Diesel	95	04/00 → 05/06			PAS005	B5
413 CDI	Diesel	95	04/00 → 05/06	ENGINE: → 835761			
413 CDI	Diesel	95	04/00 → 05/06				

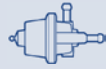

TYPE



TYPE



TYPE

							SAC012	H2		GA2090	J2
							SAC012	H2	BAE680CQ		
							SAC012	H2			
							SAG023	H1			
							SAG023-1	H1			
							SAC012	H2			
										GA2200	J2
							SAG023	H1		GA2200	J2
							SAG023-1	H1			
							SAC012	H2			
										GA2200	J2
							SAC012	H2		GA2090	J2
							SAC012	H2	BAE680CQ		
							SAC016	H2			
			RP01A								
				ATS21	F2						
							SAG023	H1			
							SAG023-1	H1			
				ATS21	F2		SAC012	H2			
	APS48										
				SPA163	F1		SAG023	H1			
							SAG023-1	H1			
				ATS21	F2		SAC012	H2			
	APS48										
				SPA163	F1		SAG023	H1			
							SAG023-1	H1			
				ATS21	F2		SAC012	H2			
	APS48										
				SPA163	F1		SAG023	H1			



KW

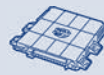

TYPE



TYPE

MERCEDES-BENZ

SPRINTER 4-t Autobus (904)

413 CDI	Diesel	95	04/00 → 05/06					
416 CDI	Diesel	115	04/00 → 05/06				PAS005	B5
416 CDI	Diesel	115	04/00 → 05/06					
416 CDI	Diesel	115	04/00 → 05/06					

SPRINTER 4-t Furgonato (904)

414	Petrol	105	02/96 → 05/06				PAS005	B5
414	Petrol	105	02/96 → 04/00					
414	Petrol	105	02/96 → 05/06	CHASSIS: P516380 →				
414	Petrol	105	02/96 → 05/06					
414	Petrol	105	02/96 → 05/06					
408 CDI	Diesel	60	04/00 → 05/06				PAS005	B5
408 CDI	Diesel	60	04/00 → 05/06	ENGINE: → 835761				
408 CDI	Diesel	60	04/00 → 05/06					
408 CDI	Diesel	60	04/00 → 05/06					
408 D	Diesel	58	02/96 → 05/06					
410 D	Diesel	75	02/96 → 05/06					
410 D	Diesel	75	01/97 → 03/00					
410 D 4x4	Diesel	75	05/97 → 05/06					
410 D 4x4	Diesel	75	05/97 → 03/00					
411 CDI	Diesel	80	04/00 → 05/06				PAS005	B5
411 CDI	Diesel	80	04/00 → 05/06	ENGINE: → 835761				
411 CDI	Diesel	80	04/00 → 05/06					
411 CDI	Diesel	80	04/00 → 05/06					
411 CDI 4x4	Diesel	80	04/00 → 05/06				PAS005	B5
411 CDI 4x4	Diesel	80	04/00 → 05/06	ENGINE: → 835761				
411 CDI 4x4	Diesel	80	04/00 → 05/06					
411 CDI 4x4	Diesel	80	04/00 → 05/06					
412 D	Diesel	90	02/96 → 05/06					
412 D	Diesel	85	01/97 → 03/00					
412 D	Diesel	90	01/97 → 03/00					
412 D 4x4	Diesel	90	05/97 → 05/06					
412 D 4x4	Diesel	85	05/97 → 03/00					
412 D 4x4	Diesel	90	05/97 → 03/00					
413 CDI	Diesel	95	04/00 → 05/06				PAS005	B5
413 CDI	Diesel	95	04/00 → 05/06	ENGINE: → 835761				
413 CDI	Diesel	95	04/00 → 05/06					
413 CDI	Diesel	95	04/00 → 05/06					
413 CDI 4x4	Diesel	95	04/00 → 05/06				PAS005	B5
413 CDI 4x4	Diesel	95	04/00 → 05/06	ENGINE: → 835761				
413 CDI 4x4	Diesel	95	04/00 → 05/06					
413 CDI 4x4	Diesel	95	04/00 → 05/06					
414 4x4	Petrol	105	05/97 → 05/06				PAS005	B5
414 4x4	Petrol	105	05/97 → 03/00					
414 4x4	Petrol	105	05/97 → 05/06	CHASSIS: R000001 →				



TYPE

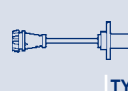

TYPE



TYPE

						SAG023-1	H1		
				ATS21	F2	SAC012	H2		
				SPA163	F1	SAG023	H1		
						SAG023-1	H1		
						SAC016	H2		
			RP01A						
				ATS21	F2				
						SAG023	H1		
						SAG023-1	H1		
				ATS21	F2	SAC012	H2		
	APS48								
				SPA163	F1	SAG023	H1		
						SAG023-1	H1		
				ATS21	F2				
				ATS21	F2				
						SAG146	H1		
				ATS21	F2				
						SAG146	H1		
				ATS21	F2	SAC012	H2		
	APS48								
				SPA163	F1	SAG023	H1		
						SAG023-1	H1		
				ATS21	F2	SAC012	H2		
	APS48								
				SPA163	F1	SAG023	H1		
						SAG023-1	H1		
				ATS21	F2				
						SAG146	H1		
						SAG146	H1		
				ATS21	F2				
						SAG146	H1		
						SAG146	H1		
				ATS21	F2	SAC012	H2		
	APS48								
				SPA163	F1	SAG023	H1		
						SAG023-1	H1		
						SAC012	H2		
	APS48								
						SAG023	H1		
						SAG023-1	H1		
						SAC016	H2		
			RP01A						
				ATS21	F2				



KW

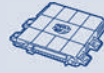

TYPE



TYPE

MERCEDES-BENZ

SPRINTER 4-t Furgonato (904)

414 4x4	Petrol	105	05/97 → 05/06					
414 4x4	Petrol	105	05/97 → 05/06					
416 CDI	Diesel	115	04/00 → 05/06				PAS005	B5
416 CDI	Diesel	115	04/00 → 05/06					
416 CDI	Diesel	115	04/00 → 05/06					
416 CDI 4x4	Diesel	115	04/00 → 05/06				PAS005	B5
416 CDI 4x4	Diesel	115	04/00 → 05/06					
416 CDI 4x4	Diesel	115	04/00 → 05/06					

SPRINTER 4-t Pianale piatto/Telaio (904)

414	Petrol	105	02/96 → 05/06				PAS005	B5
414	Petrol	105	02/96 → 05/06	CHASSIS: P516380 →				
414	Petrol	105	02/96 → 05/06					
414	Petrol	105	02/96 → 05/06					
408 CDI	Diesel	60	04/00 → 05/06				PAS005	B5
408 CDI	Diesel	60	04/00 → 05/06	ENGINE: → 835761				
408 CDI	Diesel	60	04/00 → 05/06					
408 CDI	Diesel	60	04/00 → 05/06					
408 D	Diesel	58	02/96 → 05/06					
410 D	Diesel	75	02/96 → 05/06					
410 D	Diesel	75	01/97 → 03/00					
410 D 4x4	Diesel	75	05/97 → 05/06					
410 D 4x4	Diesel	75	05/97 → 03/00					
411 CDI	Diesel	80	04/00 → 05/06				PAS005	B5
411 CDI	Diesel	80	04/00 → 05/06	ENGINE: → 835761				
411 CDI	Diesel	80	04/00 → 05/06					
411 CDI	Diesel	80	04/00 → 05/06					
411 CDI 4x4	Diesel	80	04/00 → 05/06				PAS005	B5
411 CDI 4x4	Diesel	80	04/00 → 05/06	ENGINE: → 835761				
411 CDI 4x4	Diesel	80	04/00 → 05/06					
411 CDI 4x4	Diesel	80	04/00 → 05/06					
412 D	Diesel	90	02/96 → 05/06					
412 D	Diesel	85	01/97 → 03/00					
412 D	Diesel	90	01/97 → 03/00					
412 D 4x4	Diesel	90	05/97 → 05/06					
412 D 4x4	Diesel	85	05/97 → 03/00					
412 D 4x4	Diesel	90	05/97 → 03/00					
413 CDI	Diesel	95	04/00 → 05/06				PAS005	B5
413 CDI	Diesel	95	04/00 → 05/06	ENGINE: → 835761				
413 CDI	Diesel	95	04/00 → 05/06					
413 CDI 4x4	Diesel	95	04/00 → 05/06				PAS005	B5
413 CDI 4x4	Diesel	95	04/00 → 05/06	ENGINE: → 835761				
413 CDI 4x4	Diesel	95	04/00 → 05/06					
413 CDI 4x4	Diesel	95	04/00 → 05/06					

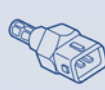
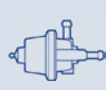

TYPE

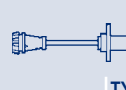

TYPE



TYPE

						SAG023	H1		
						SAG023-1	H1		
				ATS21	F2	SAC012	H2		
				SPA163	F1	SAG023	H1		
						SAG023-1	H1		
				ATS21	F2	SAC012	H2		
				SPA163	F1	SAG023	H1		
						SAG023-1	H1		
						SAC016	H2		
				ATS21	F2				
						SAG023	H1		
						SAG023-1	H1		
				ATS21	F2	SAC012	H2		
	APS48					SAG023	H1		
						SAG023-1	H1		
				ATS21	F2				
				SPA163	F1	SAG023	H1		
						SAG023-1	H1		
				ATS21	F2				
				ATS21	F2				
						SAG146	H1		
				ATS21	F2				
						SAG146	H1		
				ATS21	F2	SAC012	H2		
	APS48					SAG023	H1		
				SPA163	F1	SAG023	H1		
						SAG023-1	H1		
				ATS21	F2	SAC012	H2		
	APS48					SAG023	H1		
				SPA163	F1	SAG023	H1		
						SAG023-1	H1		
				ATS21	F2				
						SAG146	H1		
						SAG146	H1		
				ATS21	F2				
						SAG146	H1		
						SAG146	H1		
				ATS21	F2	SAC012	H2		
	APS48					SAG023	H1		
				SPA163	F1	SAG023	H1		
						SAG023-1	H1		
						SAC012	H2		
	APS48					SAG023	H1		
						SAG023-1	H1		
						SAG023	H1		
						SAG023-1	H1		

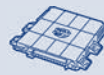

KW

TYPE

TYPE
MERCEDES-BENZ
SPRINTER 4-t Pianale piatto/Telaio (904)

414 4x4	Petrol	105	05/97 → 05/06						PAS005	B5
414 4x4	Petrol	105	05/97 → 05/06	CHASSIS: R000001 →						
414 4x4	Petrol	105	05/97 → 05/06							
414 4x4	Petrol	105	05/97 → 05/06							
416 CDI	Diesel	115	04/00 → 05/06						PAS005	B5
416 CDI	Diesel	115	04/00 → 05/06							
416 CDI	Diesel	115	04/00 → 05/06							
416 CDI 4x4	Diesel	115	04/00 → 05/06						PAS005	B5
416 CDI 4x4	Diesel	115	04/00 → 05/06							
416 CDI 4x4	Diesel	115	04/00 → 05/06							

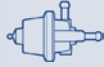
SPRINTER 5-t Furgonato (906)

509 CDI (906.653, 906.655, 906.657)	Diesel	65	06/06 →							
509 CDI (906.653, 906.655, 906.657)	Diesel	65	06/06 →							
509 CDI (906.653, 906.655, 906.657)	Diesel	65	06/06 →							
510 CDI (906.653, 906.655, 906.657)	Diesel	70	03/09 →							
511 CDI (906.653, 906.655, 906.657)	Diesel	80	06/06 →							
511 CDI (906.653, 906.655, 906.657)	Diesel	80	06/06 →							
511 CDI (906.653, 906.655, 906.657)	Diesel	80	06/06 →							
511 CDI (906.653, 906.655, 906.657)	Diesel	80	06/06 →							
513 CDI (906.653, 906.655, 906.657)	Diesel	95	03/09 →							
513 CDI (906.653, 906.655, 906.657)	Diesel	95	03/09 →							
513 CDI (906.653, 906.655, 906.657)	Diesel	95	03/09 →							
515 CDI (906.653, 906.655, 906.657)	Diesel	110	06/06 →							
515 CDI (906.653, 906.655, 906.657)	Diesel	110	06/06 →							
515 CDI (906.653, 906.655, 906.657)	Diesel	110	06/06 →							
516 CDI (906.653, 906.655, 906.657)	Diesel	120	03/09 →							
518 CDI (906.653, 906.655, 906.657)	Diesel	135	06/06 →							
519 CDI / BlueTEC (906.653, 906.655, 906.657)	Diesel	140	03/09 →							



TYPE



TYPE



TYPE

							SAC016	H2		
				ATS21	F2					
							SAG023	H1		
							SAG023-1	H1		
				ATS21	F2		SAC012	H2		
				SPA163	F1		SAG023	H1		
							SAG023-1	H1		
				ATS21	F2		SAC012	H2		
				SPA163	F1		SAG023	H1		
							SAG023-1	H1		
							SAC012	H2	GA2177	J2
							SAG023	H1		
							SAG023-1	H1		
									GA2200	J2
							SAC012	H2	GA2177	J2
							SAG023	H1		
							SAG023-1	H1		
							SAC012	H2		
							SAG023	H1		
							SAG023-1	H1		
							SAC012	H2	GA2177	J2
							SAG023	H1		
							SAG023-1	H1		
									GA2200	J2
							SAC012	H2	GA2177	J2
							SAC012	H2	GA2090	J2



KW

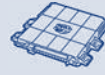

TYPE



TYPE

MERCEDES-BENZ

SPRINTER 5-t Furgonato (906)

524 (906.653, 906.655, 906.657) Petrol 190 06/06 →

SPRINTER 5-t Pianale piatto/Telaio (905)

616 CDI (905.612, 905.613, 905.622, 905.623) Diesel 115 04/01 → 05/06

616 CDI (905.612, 905.613, 905.622, 905.623) Diesel 115 04/01 → 05/06

616 CDI (905.612, 905.613, 905.622, 905.623) Diesel 115 04/01 → 05/06

SPRINTER 5-t Pianale piatto/Telaio (906)

509 CDI (906.153, 906.155, 906.253, 906.255) Diesel 65 06/06 →

509 CDI (906.153, 906.155, 906.253, 906.255) Diesel 65 06/06 →

509 CDI (906.153, 906.155, 906.253, 906.255) Diesel 65 06/06 →

510 CDI (906.153, 906.155, 906.253, 906.255) Diesel 70 03/09 →

510 CDI (906.153, 906.155, 906.253, 906.255) Diesel 70 03/09 →

510 CDI (906.153, 906.155, 906.253, 906.255) Diesel 70 03/09 →

511 CDI (906.153, 906.155, 906.253, 906.255) Diesel 80 06/06 →

511 CDI (906.153, 906.155, 906.253, 906.255) Diesel 80 06/06 →

511 CDI (906.153, 906.155, 906.253, 906.255) Diesel 80 06/06 →

513 CDI (906.135, 906.155, 906.253, 906.255) Diesel 95 06/06 →

513 CDI (906.135, 906.155, 906.253, 906.255) Diesel 95 06/06 →

513 CDI (906.135, 906.155, 906.253, 906.255) Diesel 95 03/09 →

515 CDI (906.153, 906.155, 906.253, 906.255) Diesel 110 06/06 →

515 CDI (906.153, 906.155, 906.253, 906.255) Diesel 110 06/06 →

515 CDI (906.153, 906.155, 906.253, 906.255) Diesel 110 06/06 →

516 (906.153, 906.155, 906.253, 906.255) Petrol 115 09/08 →

516 (906.153, 906.155, 906.253, 906.255) Petrol 115 09/08 →

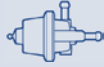

TYPE



TYPE



TYPE

						SAC012	H2	BAE680CQ		
						SAC012	H2			
						SAG023	H1			
						SAG023-1	H1			
						SAC012	H2		GA2177	J2
						SAG023	H1			
						SAG023-1	H1			
						SAC012	H2		GA2200	J2
						SAG023	H1			
						SAG023-1	H1			
						SAC012	H2		GA2177	J2
						SAG023	H1			
						SAG023-1	H1			
						SAG023	H1			
						SAG023-1	H1			
						SAC012	H2			
						SAC012	H2		GA2177	J2
						SAG023	H1			
						SAG023-1	H1			
						SAG023	H1			
						SAG023-1	H1			



KW

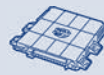

TYPE



TYPE

MERCEDES-BENZ

SPRINTER 5-t Pianale piatto/Telaio (906)

516 (906.153, 906.155, 906.253, 906.255)	Petrol	115	03/09 →					
516 CDI (906.153, 906.155, 906.253, 906.255)	Diesel	120	03/09 →					
516 NGT (906.153, 906.155, 906.253, 906.255)	Petrol/CNG	115	09/08 →					
516 NGT (906.153, 906.155, 906.253, 906.255)	Petrol/CNG	115	09/08 →					
516 NGT (906.153, 906.155, 906.253, 906.255)	Petrol/CNG	115	03/09 →					
518 CDI (906.153, 906.155, 906.253, 906.255)	Diesel	135	06/06 →					
519 CDI / BlueTEC (906.153, 906.155, 906.253, 906.255)	Diesel	140	03/09 →					
524 (906.153, 906.155, 906.253, 906.255)	Petrol	190	06/06 →					

SPRINTER Ribaltabile (905)

616 CDI (905.612, 905.622, 905.623)	Diesel	115	04/01 →					
616 CDI (905.612, 905.622, 905.623)	Diesel	115	04/01 →					
616 CDI (905.612, 905.622, 905.623)	Diesel	115	04/01 →					

Tre volumi (W123)

280 E	Petrol	130	08/76 → 08/81					
280 E (123.033)	Petrol	136	02/76 → 11/85					

Tre volumi (W124)

200 E (124.019)	Petrol	100	10/92 → 06/93					
200 E (124.019)	Petrol	100	10/92 → 06/93	ENGINE: 055902 →				
200 E (124.021)	Petrol	87	09/88 → 08/92	ENGINE: 036266 →, 009690 →				
200 E (124.021)	Petrol	87	09/88 → 08/92					
200 E (124.021)	Petrol	90	09/88 → 12/89					
220 E (124.022)	Petrol	110	10/92 → 06/93					
220 E (124.022)	Petrol	110	10/92 → 06/93	ENGINE: 080037 →				
230 E (124.023)	Petrol	100	01/85 → 06/93	ENGINE: 146597 →, 147102 →				
230 E (124.023)	Petrol	100	01/85 → 06/93					
230 E (124.023)	Petrol	97	12/84 → 03/92					
230 E (124.023) Cat.	Petrol	97	06/89 → 06/93	ENGINE: 146597 →, 147102 →				
230 E (124.023) Cat.	Petrol	97	06/89 → 06/93					
260 E (124.026)	Petrol	118	09/85 → 08/92	ENGINE: 027640 →, 070068 →				
260 E (124.026)	Petrol	118	09/85 → 08/92	CHASSIS: A368937 →				
260 E (124.026)	Petrol	122	09/85 → 12/89	CHASSIS: A368937 →				
260 E 4-matic (124.226)	Petrol	118	09/86 → 08/92	ENGINE: 000453 →				
260 E 4-matic (124.226)	Petrol	118	09/86 → 08/92	CHASSIS: A368937 →				

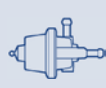

TYPE

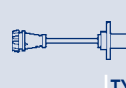

TYPE



TYPE

						SAC012	H2			
									GA2200	J2
						SAG023	H1			
						SAG023-1	H1			
						SAC012	H2			
						SAC012	H2		GA2177	J2
						SAC012	H2		GA2090	J2
						SAC012	H2	BAE680CQ		
						SAC012	H2			
						SAG023	H1			
						SAG023-1	H1			
									ESS0126A	J1
									ESS0126A	J1
					RP01A					
						ATS21	F2			
						SPA136	F1			
									ESS528	J1
									ESS528	J1
					RP01A			SAC043	H2	
						ATS21	F2			
						SPA136	F1			
									ESS528	J1
									ESS528	J1
						SPA136	F1			
									ESS528	J1
						SPA136	F1			
									ESS528	J1
									ESS528	J1
						SPA136	F1			
									ESS528	J1



KW

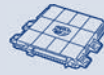

TYPE



TYPE

MERCEDES-BENZ

Tre volumi (W124)

260 E 4-matic (124.226)	Petrol	122	12/86 → 12/89	CHASSIS: A368937 →				
280 E (124.028)	Petrol	145	10/92 → 06/93					
280 E (124.028)	Petrol	145	10/92 → 06/93	ENGINE: 005790 →				
300 E	Petrol	138	06/85 → 08/92	ENGINE: 181462 →				
300 E	Petrol	138	01/85 → 12/85	CHASSIS: A368937 →				
300 E	Petrol	138	06/85 → 08/92	CHASSIS: A368937 →				
300 E (124.030)	Petrol	132	08/85 → 08/92	ENGINE: 181462 →				
300 E (124.030)	Petrol	132	08/85 → 08/92	CHASSIS: A368937 →				
300 E 4-matic	Petrol	138	09/86 → 02/92	ENGINE: 002188 →, 008268 →				
300 E 4-matic	Petrol	138	09/86 → 02/92	CHASSIS: A368937 →				
300 E 4-matic (124.230)	Petrol	132	09/86 → 06/93	ENGINE: 002188 →, 008268 →				
300 E 4-matic (124.230)	Petrol	132	09/86 → 06/93	CHASSIS: A368937 →				
300 E-24 (124.031)	Petrol	162	09/88 → 08/92					
320 E (124.032)	Petrol	162	10/92 → 06/93					
320 E (124.032)	Petrol	162	10/92 → 06/93	ENGINE: 004357 →				
400 E 4.2 (124.034)	Petrol	205	10/92 → 06/93					
400 E 4.2 (124.034)	Petrol	205	10/92 → 06/93	CHASSIS: → C226335				
500 E (124.036)	Petrol	240	01/91 → 06/93					
500 E AMG 6.0	Petrol	275	01/92 → 06/93					

VANEO (414)

1.6 (414.700)	Petrol	60	02/02 → 07/05					
1.6 (414.700)	Petrol	75	02/02 → 07/05					
1.6 (414.700)	Petrol	60	02/02 → 07/05					
1.6 (414.700)	Petrol	60	02/02 → 07/05					
1.6 (414.700)	Petrol	75	02/02 → 07/05					
1.6 (414.700)	Petrol	75	02/02 → 07/05					
1.6 (414.700)	Petrol	60	02/02 → 07/05					
1.6 (414.700)	Petrol	75	02/02 → 07/05					
1.7 CDI (414.700)	Diesel	55	02/02 → 07/05					
1.7 CDI (414.700)	Diesel	55	02/02 → 07/05					
1.7 CDI (414.700)	Diesel	67	02/02 → 07/05					
1.7 CDI (414.700)	Diesel	67	02/02 → 07/05					
1.7 CDI (414.700)	Diesel	55	02/02 → 07/05					
1.7 CDI (414.700)	Diesel	67	02/02 → 07/05					
1.9 (414.700)	Petrol	92	02/02 → 07/05					
1.9 (414.700)	Petrol	92	02/02 → 07/05					
1.9 (414.700)	Petrol	92	02/02 → 07/05	ENGINE: 30040047 →				
1.9 (414.700)	Petrol	92	02/02 → 07/05	ENGINE: 30040047 →				

VIANO (W639)

3,0	Petrol	140	09/03 →					
3,0	Petrol	140	09/03 →					
3,0	Petrol	140	09/03 →					
3,0	Petrol	140	09/03 →					
3,0	Petrol	140	09/03 → 12/07					

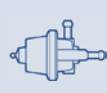

TYPE

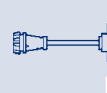

TYPE



TYPE

									ESS528	J1
		RP01A				SAC043	H2		ESS528	J1
			ATS21	F2						
			SPA136	F1						
									ESS528	J1
									ESS528	J1
			SPA136	F1						
									ESS528	J1
			SPA136	F1						
									ESS528	J1
			SPA136	F1		SAC043	H2		ESS528	J1
		RP01A				SAC043	H2		ESS528	J1
			ATS21	F2						
		RP01A	SPA136	F1		SAC043	H2			
									ESS528	J1
		RP01A	SPA136	F1		SAC043	H2		ESS528	J1
		RP01A							ESS528	J1
		APS33	ATS21	F2		SAC012	H2	BAE680CW		
		APS33	ATS21	F2		SAC012	H2	BAE680CW		
			SPA163	F1		SAD033	H3			
						SAG023	H1			
			SPA163	F1		SAD033	H3			
						SAG023	H1			
						SAG023-1	H1			
						SAG023-1	H1			
			ATS21	F2		SAC012	H2		SUA572	J3
			SPA163	F1		SAG023	H1			
			SPA163	F1		SAC012	H2			
						SAG023	H1			
						SAG023-1	H1			
						SAG023-1	H1			
		APS33	ATS21	F2		SAC012	H2	BAE680CW		
			SPA163	F1		SAD033	H3			
						SAG023	H1			
						SAG023-1	H1			
			SPA163	F1		SAC012	H2			
						SAD018	H3			
						SAG023	H1			
						SAG023-1	H1			
									BAE680CX	



KW

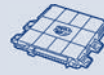

TYPE



TYPE

MERCEDES-BENZ

VIANO (W639)

3.2	Petrol	160	09/03 →						
3.2	Petrol	160	09/03 →						
3.2	Petrol	160	09/03 →						
3.2	Petrol	160	09/03 →						
3.2	Petrol	160	09/03 → 12/07						
3.5	Petrol	190	09/07 →						
3.7	Petrol	170	06/04 →						
3.7	Petrol	170	06/04 →						
3.7	Petrol	170	06/04 →						
3.7	Petrol	170	06/04 → 07/09						
3.7	Petrol	170	06/04 → 08/07						
CDI 2.0	Diesel	80	09/03 →						
CDI 2.0	Diesel	80	09/03 →						
CDI 2.0	Diesel	80	09/03 →						
CDI 2.0	Diesel	85	08/05 →						
CDI 2.0	Diesel	85	08/05 →						
CDI 2.0	Diesel	85	08/05 →						
CDI 2.0 4-matic	Diesel	80	07/05 →						
CDI 2.0 4-matic	Diesel	80	07/05 →						
CDI 2.0 4-matic	Diesel	80	07/05 →						
CDI 2.2	Diesel	110	09/03 →						
CDI 2.2	Diesel	110	09/03 →						
CDI 2.2	Diesel	110	09/03 →						
CDI 2.2 4-matic	Diesel	110	03/06 →						
CDI 2.2 4-matic	Diesel	110	03/06 →						
CDI 2.2 4-matic	Diesel	110	03/06 →						
CDI 3.0	Diesel	150	03/06 →						

VITO / MIXTO Furgonato (W639)

119	Petrol	140	09/03 →						
119	Petrol	140	09/03 →						
119	Petrol	140	09/03 →						
119	Petrol	140	09/03 → 07/08						
119	Petrol	140	10/03 → 12/10						
122	Petrol	160	09/03 →						
122	Petrol	160	09/03 →						
122	Petrol	160	09/03 →						
122	Petrol	160	09/03 → 09/04						
122	Petrol	160	10/03 → 12/10						
126	Petrol	190	09/07 →						
109 CDI	Diesel	65	09/03 → 07/06						
109 CDI	Diesel	65	09/03 → 07/06						
109 CDI	Diesel	65	09/03 → 07/06						
109 CDI	Diesel	70	08/06 →						
109 CDI	Diesel	70	08/06 →						

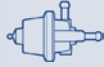

TYPE



TYPE



TYPE

				SPA163	F1		SAC012	H2			
							SAD018	H3			
							SAG023	H1			
							SAG023-1	H1			
									BAE680CX		
							SAC012	H2	BAE680CQ		
				SPA163	F1		SAD018	H3			
							SAG023	H1			
							SAG023-1	H1			
							SAC012	H2			
									BAE680CX		
				SPA163	F1		SAC012	H2		GA2149	J2
							SAG023	H1			
							SAG023-1	H1			
							SAC012	H2			
							SAG023	H1			
							SAG023-1	H1			
							SAC012	H2			
							SAG023	H1			
							SAG023-1	H1			
				SPA163	F1		SAC012	H2		GA2149	J2
							SAG023	H1			
							SAG023-1	H1			
							SAC012	H2			
							SAG023	H1			
							SAG023-1	H1			
							SAC012	H2		GA2149	J2
									BAE680CX		
							SAD018	H3			
							SAG023	H1			
							SAG023-1	H1			
							SAC012	H2			
									BAE680CX		
							SAD018	H3			
							SAG023	H1			
							SAG023-1	H1			
							SAC012	H2			
									BAE680CX		
							SAC012	H2	BAE680CQ		
							SAC012	H2			
							SAG023	H1			
							SAG023-1	H1			
							SAC012	H2			
							SAG023	H1			



KW



TYPE



TYPE

MERCEDES-BENZ

VITO / MIXTO Furgonato (W639)

109 CDI	Diesel	70	08/06 →						
109 CDI	Diesel	65	09/03 →						
110 CDI	Diesel	70	09/10 →						
111 CDI	Diesel	80	09/03 →						
111 CDI	Diesel	80	09/03 →						
111 CDI	Diesel	80	09/03 → 08/07						
111 CDI	Diesel	85	09/07 →						
111 CDI	Diesel	85	09/07 →						
111 CDI	Diesel	85	09/07 →						
111 CDI 4x4	Diesel	80	09/07 →						
111 CDI 4x4	Diesel	80	09/07 →						
111 CDI 4x4	Diesel	80	09/07 →						
113 CDI	Diesel	100	09/10 →						
115 CDI	Diesel	110	09/03 →						
115 CDI	Diesel	110	09/03 →						
115 CDI	Diesel	110	09/03 →						
115 CDI 4x4	Diesel	110	07/06 →						
115 CDI 4x4	Diesel	110	07/06 →						
115 CDI 4x4	Diesel	110	07/06 →						
116 CDI	Diesel	120	09/10 →						
120 CDI	Diesel	150	07/06 →						
122 CDI	Diesel	165	09/10 →						
123 (639.603)	Petrol	170	06/04 → 07/08						
123 (639.603)	Petrol	170	06/04 → 08/07						

VITO Autobus (638)

108 CDI 2.2 (638.194)	Diesel	60	03/99 → 07/03						
108 CDI 2.2 (638.194)	Diesel	60	03/99 → 07/03						
108 CDI 2.2 (638.194)	Diesel	60	03/99 → 07/03						
110 CDI 2.2 (638.194)	Diesel	75	03/99 → 07/03						
110 CDI 2.2 (638.194)	Diesel	75	03/99 → 07/03						
110 CDI 2.2 (638.194)	Diesel	75	03/99 → 07/03						
112 CDI 2.2 (638.194)	Diesel	90	03/99 → 07/03						
112 CDI 2.2 (638.194)	Diesel	90	03/99 → 07/03						
112 CDI 2.2 (638.194)	Diesel	90	03/99 → 07/03						
113 2.0 (638.114, 638.194)	Petrol	95	02/96 → 06/03						
113 2.0 (638.114, 638.194)	Petrol	95	02/96 → 07/03						

VITO Autobus (W639)

119	Petrol	140	09/03 →						
119	Petrol	140	09/03 →						
119	Petrol	140	09/03 →						
119	Petrol	140	09/03 → 07/08						
119	Petrol	140	10/03 → 12/10						
122	Petrol	160	09/03 →						
122	Petrol	160	09/03 →						

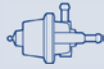

TYPE



TYPE



TYPE

						SAG023-1	H1			
									GA2076	J2
									GA2130	J2
						SAG023	H1			
						SAG023-1	H1			
						SAC012	H2			
						SAC012	H2			
						SAG023	H1			
						SAG023-1	H1			
						SAC012	H2			
						SAG023	H1			
						SAG023-1	H1			
									GA2130	J2
						SAC012	H2			
						SAG023	H1			
						SAG023-1	H1			
									GA2130	J2
						SAC012	H2			
									GA2130	J2
						SAC012	H2			
									BAE680CX	
					ATS21	F2	SAC012	H2		
					SPA163	F1	SAG023	H1		
							SAG023-1	H1		
					ATS21	F2	SAC012	H2		
					SPA163	F1	SAG023	H1		
							SAG023-1	H1		
					ATS21	F2	SAC012	H2		
					SPA163	F1	SAG023	H1		
							SAG023-1	H1		
			RP01A							
							SAC016	H2		
							SAD018	H3		
							SAG023	H1		
							SAG023-1	H1		
							SAC012	H2		
									BAE680CX	
							SAD018	H3		
							SAG023	H1		



KW



TYPE



TYPE

MERCEDES-BENZ

VITO Autobus (W639)

122	Petrol	160	09/03 →						
122	Petrol	160	09/03 → 09/04						
122	Petrol	160	10/03 → 12/10						
123	Petrol	170	06/04 →						
123	Petrol	170	06/04 →						
123	Petrol	170	06/04 →						
123	Petrol	170	06/04 → 07/08						
123	Petrol	170	06/04 → 08/07						
126	Petrol	190	09/07 →						
109 CDI	Diesel	65	09/03 → 07/06						
109 CDI	Diesel	65	09/03 → 07/06						
109 CDI	Diesel	65	09/03 → 07/06						
109 CDI	Diesel	70	09/06 →						
109 CDI	Diesel	70	09/06 →						
109 CDI	Diesel	70	09/06 →						
109 CDI	Diesel	65	09/03 →						
109 CDI 4x4	Diesel	70	09/07 →						
109 CDI 4x4	Diesel	70	09/07 →						
109 CDI 4x4	Diesel	70	09/07 →						
110 CDI	Diesel	70	09/10 →						
111 CDI	Diesel	80	09/03 →						
111 CDI	Diesel	80	09/03 →						
111 CDI	Diesel	80	09/03 → 08/07						
111 CDI (639.701)	Diesel	85	09/07 →						
111 CDI (639.701)	Diesel	85	09/07 →						
111 CDI (639.701)	Diesel	85	09/07 →						
111 CDI 4x4	Diesel	80	09/07 →						
111 CDI 4x4	Diesel	80	09/07 →						
111 CDI 4x4	Diesel	80	09/07 →						
113 CDI	Diesel	100	09/10 →						
115 CDI	Diesel	110	09/03 →						
115 CDI	Diesel	110	09/03 →						
115 CDI	Diesel	110	09/03 →						
115 CDI 4x4	Diesel	110	09/07 →						
115 CDI 4x4	Diesel	110	09/07 →						
115 CDI 4x4	Diesel	110	09/07 →						
116 CDI	Diesel	120	09/10 →						
120 CDI	Diesel	150	07/06 →						
122 CDI	Diesel	165	09/10 →						

VITO Furgonato (638)

108 CDI 2.2 (638.094)	Diesel	60	03/99 → 07/03						
108 CDI 2.2 (638.094)	Diesel	60	03/99 → 07/03						
108 CDI 2.2 (638.094)	Diesel	60	03/99 → 07/03						
110 CDI 2.2 (638.094)	Diesel	75	03/99 → 07/03						



KW



TYPE



TYPE

MERCEDES-BENZ

VITO Furgonato (638)

110 CDI 2.2 (638.094)	Diesel	75	03/99 → 07/03						
110 CDI 2.2 (638.094)	Diesel	75	03/99 → 07/03						
112 CDI 2.2 (638.094)	Diesel	90	03/99 → 07/03						
112 CDI 2.2 (638.094)	Diesel	90	03/99 → 07/03						
112 CDI 2.2 (638.094)	Diesel	90	03/99 → 07/03						
113 2.0 (638.014, 638.094)	Petrol	95	03/97 → 06/03						
113 2.0 (638.014, 638.094)	Petrol	95	03/97 → 07/03						
114 2.3 (638.034, 638.094)	Petrol	105	03/97 → 06/03						
114 2.3 (638.034, 638.094)	Petrol	105	03/97 → 07/03						

MG

MG TF

115	Petrol	85	03/02 →						
120	Petrol	88	03/02 →						
120	Petrol	88	03/02 →	CHASSIS: YD522573 →					
135	Petrol	100	03/02 →						
135	Petrol	100	03/02 →	CHASSIS: YD522573 →					
160	Petrol	118	03/02 →						
160	Petrol	118	03/02 →	CHASSIS: YD522573 →					

MG ZR

105	Petrol	76	06/01 → 04/05						
120	Petrol	86	06/01 → 04/05						
120	Petrol	86	06/01 → 04/05	CHASSIS: YD471565 →					
160	Petrol	118	06/01 → 04/05	CHASSIS: YD471565 →					
2.0 TD	Diesel	74	06/01 → 04/05						

MG ZS

120	Petrol	86	07/01 → 04/05						
180	Petrol	130	07/01 → 04/05						
2.0 TD	Diesel	83	01/04 → 04/05						
2.0 TD	Diesel	74	01/04 → 04/05						

MG ZS Hatchback

120	Petrol	86	07/01 → 10/05						
180	Petrol	130	07/01 → 10/05						
1.6	Petrol	82	11/01 → 10/05	CHASSIS: → YD471063					
2.0 TD	Diesel	83	01/04 → 10/05						
2.0 TD	Diesel	74	01/04 → 10/05						

MG ZT

160	Petrol	118	06/01 → 07/05						
160	Petrol	118	06/01 → 07/05	CHASSIS: YM174263 →					
190	Petrol	140	06/01 → 07/05						
190	Petrol	140	06/01 → 07/05	CHASSIS: YM174263 →					
1.8 16V	Petrol	88	01/03 → 07/05						
1.8 T 16V	Petrol	118	01/03 → 07/05						
2.0 CDTi	Diesel	85	06/02 → 09/03						



TYPE

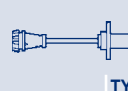

TYPE



TYPE

			SPA163	F1		SAG023	H1		
						SAG023-1	H1		
			ATS21	F2		SAC012	H2		
			SPA163	F1		SAG023	H1		
						SAG023-1	H1		
		RP01A							
						SAC016	H2		
		RP01A							
						SAC016	H2		
		APS69	SGA113	F3					
		APS69							
			SGA113	F3					
		APS69							
			SGA113	F3					
		APS69							
			SGA113	F3					
		APS69							
		APS69							
			SGA113	F3					
			SGA113	F3					
						SAG081	H1		
		APS69	SGA113	F3					
		APS69				SAG144	H1		
			ATS15	F2		SAG081	H1		
						SAG081	H1		
		APS69	SGA113	F3					
		APS69				SAG144	H1		
						SAG091	H1		
			ATS15	F2		SAG081	H1		
						SAG081	H1		
		APS69	SGA113	F3					
		APS69				SAG144	H1		
			SGA113	F3					
			SGA113	F3		SAG144	H1		
		APS30	ATS15	F2					



KW



TYPE



TYPE

MG

MG ZT

2.0 CDTi	Diesel	96	11/02 → 07/05					
2.0 CDTi	Diesel	85	06/02 → 09/03					

MG ZT- T

160	Petrol	118	10/01 → 07/05					
160	Petrol	118	10/01 → 07/05	CHASSIS: YM174263 →				
190	Petrol	140	10/01 → 07/05					
190	Petrol	140	10/01 → 07/05	CHASSIS: YM174263 →				
1.8 16V	Petrol	88	01/03 → 07/05					
1.8 T 16V	Petrol	118	01/03 → 07/05					
2.0 CDTi	Diesel	85	06/02 → 09/03					
2.0 CDTi	Diesel	96	11/02 → 07/05					

MGF (RD)

1.8 i VVC	Petrol	118	10/01 → 03/02					
1.6	Petrol	82	02/00 → 03/02					
1.8 i 16V	Petrol	88	03/95 → 03/02					
1.8 i 16V	Petrol	88	03/95 → 03/02	CHASSIS: YD522573 →				
1.8 i VVC	Petrol	107	03/95 → 03/02					
1.8 i VVC	Petrol	107	03/95 → 03/02	CHASSIS: YD522573 →				

MINI

MINI (R50, R53)

Cooper	Petrol	85	06/01 → 09/06					
Cooper S	Petrol	120	03/02 → 09/06					
Cooper S	Petrol	125	07/04 → 09/06					
One	Petrol	66	06/01 → 09/06					
One D	Diesel	55	06/03 → 09/06					
One D	Diesel	65	06/03 → 09/06					
One D	Diesel	55	04/07 → 09/06					
One D	Diesel	65	04/07 → 09/06					
Works	Petrol	155	11/03 → 09/06					
Works	Petrol	155	12/06 → 09/06					

MINI (R56)

Cooper	Petrol	88	10/06 →					
Cooper	Petrol	88	10/06 → 08/10					
Cooper	Petrol	90	03/10 →					
Cooper	Petrol	85	03/10 →					
Cooper D	Diesel	80	03/07 →					
Cooper D	Diesel	82	06/10 →					
Cooper S	Petrol	128	10/06 →					
Cooper S	Petrol	128	10/06 → 07/10					
Cooper S	Petrol	135	03/10 →					
John Cooper Works	Petrol	155	07/08 →					
One	Petrol	55	03/09 →					
One	Petrol	70	03/07 →					



TYPE

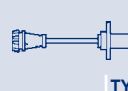

TYPE



TYPE

	APS30		SGA113	F3						
			SGA113	F3						
	APS69		SGA113	F3						
						SAG144	H1			
	APS69		SGA113	F3						
						SAG144	H1			
			SGA113	F3						
			SGA113	F3		SAG144	H1			
	APS30		SGA113	F3						
	APS30		SGA113	F3						
	APS69									
			SGA114	F3		SAG091	H1			
	APS69					SAG091	H1			
			SGA113	F3						
	APS69					SAG091	H1			
			SGA113	F3						
	APS69									
	APS61									
	APS61									
	APS61									
	APS69									
			SPA168	F1		SAC094	H2			
						SAC094	H2			
								SUA516	J3	
								SUA516	J3	
	APS61									
								GA2040	J2	
	APS71		SPA161	F1	SAA118			BAE680BR	GA2040	J2
						SAC072	H2			
						SAC072	H2	BAE680BR		
								BAE680BR		
						SAG167	H1		SUA516	J3
									GA2128	J2
	APS47		SPA161	F1	SAA118					
						SAC072	H2			
						SAC072	H2			
						SAC072	H2			
	APS71									
	APS71								GA2040	J2



KW



TYPE



TYPE

MINI

MINI (R56)

One	Petrol	55	03/09 → 02/10						
One	Petrol	70	03/07 → 02/10						
One	Petrol	72	03/10 →						
One	Petrol	55	03/10 →						
One D	Diesel	66	06/09 → 07/10						
One D	Diesel	66	07/10 →						

MINI Cabriolet (R52)

Cooper	Petrol	85	07/04 → 11/07						
Cooper S	Petrol	125	07/04 → 11/07						
John Cooper Works	Petrol	155	07/04 → 11/07						
One	Petrol	66	07/04 → 11/07						

MINI Cabriolet (R57)

Cooper	Petrol	88	03/09 →						
Cooper	Petrol	88	03/09 → 06/10						
Cooper	Petrol	90	03/10 →						
Cooper	Petrol	85	03/09 →						
Cooper D	Diesel	82	06/10 →						
Cooper S	Petrol	128	03/09 →						
Cooper S	Petrol	128	03/09 → 07/10						
John Cooper Works	Petrol	155	03/09 →						
One	Petrol	72	03/10 →						

MINI CLUBMAN (R55)

Cooper	Petrol	88	10/07 →						
Cooper	Petrol	88	10/07 → 07/10						
Cooper	Petrol	90	03/10 →						
Cooper	Petrol	85	03/10 →						
Cooper D	Diesel	80	10/07 →						
Cooper D	Diesel	82	03/10 →						
Cooper S	Petrol	128	10/07 →						
Cooper S	Petrol	128	10/07 → 07/10						
Cooper S	Petrol	135	03/10 →						
John Cooper Works	Petrol	155	07/08 →						
One	Petrol	72	03/10 →						
One	Petrol	70	03/09 → 02/10						
One D	Diesel	66	03/10 →						

MINI COUNTRYMAN (R60)

Cooper	Petrol	85	06/10 →						
Cooper	Petrol	90	06/10 →						
One	Petrol	72	09/10 →						

MINI Coupé (R58)

Cooper	Petrol	85	09/11 →						
Cooper	Petrol	90	09/11 →						

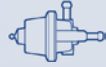

TYPE



TYPE



TYPE

SAC072 H2 BAE680BR

SAC072 H2 BAE680BR

SAC072 H2 BAE680BR

BAE680BR

SAG167 H1

GA2128

J2

APS61

APS61

APS61

APS61

APS71

BAE680BR

SAC072 H2

SAC072 H2 BAE680BR

BAE680BR

GA2128

J2

APS47

SAC072 H2

SAC072 H2

BAE680BR

APS71

BAE680BR

SAC072 H2

SAC072 H2 BAE680BR

BAE680BR

SAG167 H1

GA2128

J2

APS47

SAC072 H2

SAC072 H2

SAC072 H2

SAC072 H2 BAE680BR

BAE680BR

GA2128

J2

BAE680BR

BAE680BR

BAE680BR

BAE680BR

BAE680BR

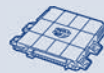
KW

TYPE

TYPE
MINI
MINI Roadster (R59)

Cooper	Petrol	85	02/12 →						
Cooper	Petrol	90	02/12 →						

MITSUBISHI
3000 GT (Z16A)

3.0 i 24V 4WD (Z16A)	Petrol	210	06/94 → 08/99						
3.0 i 24V 4WD (Z16A)	Petrol	210	06/92 → 08/99						

CARISMA (DA_)

1.6 (DA1A)	Petrol	66	07/95 → 07/98						
1.6 (DA1A)	Petrol	73	05/97 → 07/98						
1.6 (DA1A)	Petrol	66	07/95 → 06/06						
1.8 (DA2A)	Petrol	85	07/95 → 06/06						
1.8 16V (DA2A)	Petrol	103	07/95 → 06/06						
1.8 16V GDI (DA2A)	Petrol	92	09/97 → 06/06						
1.9 DI-D	Diesel	85	09/00 → 06/06						
1.9 DI-D (DA5A)	Diesel	75	09/00 → 06/06						
1.9 TD (DA4A)	Diesel	66	10/96 → 09/00						

CARISMA Tre volumi (DA_)

1.6 (DA1A)	Petrol	73	05/97 → 07/98						
1.8 16V GDI (DA2A)	Petrol	92	09/97 → 06/06						
1.9 DI-D	Diesel	85	09/00 → 06/06						
1.9 DI-D (DA5A)	Diesel	75	09/00 → 06/06						
1.9 TD (DA4A)	Diesel	66	10/96 → 09/00						

COLT III (C5_A)

1.6 GTi 16V (C53A)	Petrol	91	04/88 → 05/90						
1.8 Diesel GLX (C54A)	Diesel	44	04/88 → 05/92						
1.8 GTi 16V (C58A) Cat.	Petrol	100	06/90 → 05/92						

COLT IV (CA_A)

1.6 GLXi 16V (CA4A)	Petrol	83	04/92 → 04/96						
1.8 GTi 16V (CA5A)	Petrol	103	04/92 → 04/96						

COLT V (CJ_, CP_)

1300	Petrol	60	09/00 → 09/03						
------	--------	----	---------------	--	--	--	--	--	--

COLT VI (Z3_A, Z2_A)

1.1	Petrol	55	10/04 → 06/12						
1.3	Petrol	70	06/04 → 06/12						
1.5	Petrol	80	06/04 → 06/12						
1.5 DI-D	Diesel	50	08/04 → 06/12						
1.5 DI-D	Diesel	70	08/04 → 06/12						

ECLIPSE I (D2_A)

2.0 i 16V (D22A, D27A)	Petrol	110	04/91 → 11/95						
2.0 i 16V 4WD (D22A, D27A)	Petrol	110	04/91 → 11/95						

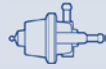

TYPE



TYPE



TYPE

BAE680BR

BAE680BR

SPA142

F1

SAA111

SPA142

F1

SPA142

F1

SAG072

H1

SPA142

F1

SAA111

SAG072

H1

SPA142

F1

SAA111

SAG072

H1

SPA142

F1

SPA169

F1

SAG153

H1

SPA169

F1

SAG153

H1

SAG036

H1

SPA142

F1

SPA142

F1

SPA169

F1

SAG153

H1

SPA169

F1

SAG153

H1

SAG036

H1

SAA111

SAA111

SAA111

SPA142

F1

SPA142

F1

SAA111

SAA111

GA2196

J2

GA2196

J2

GA2196

J2

GA2120

J2

GA2120

J2

SAA111

SAA111

KW

TYPE

TYPE
MITSUBISHI
GALANT IV (E3_A)

1.8 (E32A)	Petrol	66	11/88 → 10/92						
1.8 Turbo-D (E34A)	Diesel	55	11/88 → 10/92						
2.0 (E39A, E38A, E33A)	Petrol	80	04/89 → 10/92						
2.0 4WD (E33A, E38A, E39A)	Petrol	80	04/89 → 10/92						
2.0 GTI 16V (E39A, E38A, E33A)	Petrol	106	11/88 → 10/92						
2.0 GTI 16V (E39A, E38A, E33A)	Petrol	107	11/88 → 10/92						

GALANT IV Tre volumi (E3_A)

1.8 (E32A)	Petrol	63	11/87 → 08/90						
1.8 (E32A)	Petrol	66	11/87 → 10/92						
1.8 Turbo-D (E34A)	Diesel	55	12/87 → 10/92						
2.0 (E39A, E38A, E33A)	Petrol	80	11/87 → 10/92						
2.0 4WD (E39A, E38A, E33A)	Petrol	80	12/88 → 10/92						
2.0 GTI 16V (E39A, E38A, E33A)	Petrol	106	11/87 → 10/92						
2.0 GTI 16V 4WD (E39A, E38A, E33A)	Petrol	106	06/88 → 10/92						

GALANT V (E5_A, E7_A, E8_A)

1.8 GLSI (E52A)	Petrol	93	11/92 → 08/96						
2.0 GLSI (E55A)	Petrol	101	11/92 → 08/96						
2.0 GLSI 4WD (E75A)	Petrol	101	11/92 → 08/96						
2.0 GLSTD (E57A)	Diesel	66	11/92 → 08/96						
2.0 V6-24 (E64A, E54A)	Petrol	110	11/92 → 08/96						
2.5 V6-24 4WD (E88A)	Petrol	125	11/92 → 08/96						

GALANT V Tre volumi (E5_A, E7_A, E8_A)

1.8 GLSI (E52A)	Petrol	93	11/92 → 08/96						
2.0 GLSI (E55A)	Petrol	101	11/92 → 08/96						
2.0 GLSI 4WD (E75A)	Petrol	101	11/92 → 08/96						
2.0 GLSTD (E57A)	Diesel	66	11/92 → 08/96						
2.0 V6-24 (E64A, E54A)	Petrol	110	11/92 → 08/96						
2.5 V6-24 4WD (E88A)	Petrol	125	11/92 → 08/96						

GALANT VI (EA_)

2.4 GDI (EA3A)	Petrol	106	09/00 → 10/04						
2.4 GDI (EA3A)	Petrol	110	02/99 → 09/00						

GALANT VI Station wagon (EA_)

2.4 GDI (EA3W)	Petrol	106	09/00 → 10/03						
2.4 GDI (EA3W)	Petrol	110	02/99 → 10/03						

GRANDIS (NA_W)

2.0 DI-D	Diesel	100	09/05 →						
2.0 DI-D	Diesel	103	02/07 → 03/10						
2.0 DI-D	Diesel	100	09/05 →						
2.4	Petrol	121	04/04 →						

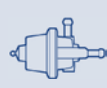

TYPE

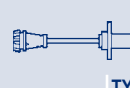

TYPE



TYPE

SAA111

SAA111

SAA111

SAA111

SAA111

SAA111

SAA111

SAA111

SAA111

SAA111

SAA111

SAA111

SAA111

SPA142

F1

SPA142

F1

SPA142

F1

SAA111

SPA142

F1

SAA111

SPA142

F1

SAA111

SPA142

F1

SPA142

F1

SAA111

SPA142

F1

SAA111

SPA142

F1

SPA142

F1

SAA111

SPA127

F1

SPA127

F1

SPA127

F1

SPA127

F1

SPA111

F1

SAC085

H2

SPA111

F1

SAG166

H1

SAA111

KW

TYPE

TYPE
MITSUBISHI
L 200 (K7_T, K6_T)

2.0 (K62T)	Petrol	90	06/96 → 12/07						
2.4 4WD (K75T)	Petrol	97	06/96 → 12/07						
2.5 D (K64T)	Diesel	55	06/96 → 12/07						
2.5 TD 4WD (K74T)	Diesel	73	06/96 → 12/07						
2.5 TD 4WD (K74T)	Diesel	85	09/01 → 12/07						

L 300 Pianale piatto/Telaio (P1_T)

2.0 (P13T)	Petrol	85	07/94 → 04/00						
2.5 TD (P15T)	Diesel	64	11/94 → 04/00						

L 400 / SPACE GEAR Autobus (PD_W, PC_W, PA_V, PB_V)

2.0 16V (PA3V/W, PB3V)	Petrol	85	05/95 → 05/00						
2.4 i 4WD (PD4V/W)	Petrol	97	05/95 → 05/00						
2.5 TD (PA5V/W, PB5V)	Diesel	73	05/95 → 05/00						
2.5 TD 4WD (PD5V/W)	Diesel	73	05/95 → 05/00						
2500 TD	Diesel	64	05/95 → 06/05						

L 400 Furgonato (PD_W, PC_W, PB_V, PA_W, PA_V)

2.0	Petrol	85	06/96 → 03/01						
2500 TD (PD5W, PD5V, PA5W, PA5V)	Diesel	64	09/96 → 06/05						
2500 TD 4WD (PD5W, PD5V, PA5W, PA5V)	Diesel	64	09/96 → 06/05						

LANCER III (C1_A, C6_A)

1.2 (C65A)	Petrol	44	08/86 → 04/88						
1.8 Diesel (C14AS)	Diesel	43	01/84 → 09/86						
1.8 Diesel (C14AS)	Diesel	44	09/86 → 04/88						

LANCER III Station Wagon (C1_V, C3_V)

1.5 12V (C12V)	Petrol	66	09/90 → 12/91						
1.8 4WD (C37V)	Petrol	63	03/89 → 12/90						
1.8 4WD (C37V)	Petrol	69	08/90 → 06/92						
1.8 D (C14V)	Diesel	43	09/85 → 09/86						
1.8 D (C14V)	Diesel	44	08/86 → 06/92						

LANCER IV (C6_A, C7_A)

1.6 16V (C76A, C66A)	Petrol	83	06/92 → 05/94						
1.8 4WD (C77A)	Petrol	71	09/89 → 06/92						
1.8 D (C64A)	Diesel	44	04/88 → 05/92						
1.8 GTi 16V (C68A)	Petrol	100	11/89 → 05/92						
1.8 GTi 16V (C69A)	Petrol	103	06/92 → 12/93						

LANCER IV Tre volumi (C6_A)

1.8 GLX Diesel (C64A)	Diesel	44	04/88 → 05/92						
-----------------------	--------	----	---------------	--	--	--	--	--	--

LANCER SPORTBACK (CX_A)

2.0 DI-D	Diesel	103	06/08 →						
----------	--------	-----	---------	--	--	--	--	--	--

LANCER Tre volumi (CS_A, CT0)

2.0 (CS9A)	Petrol	99	12/03 →						
------------	--------	----	---------	--	--	--	--	--	--

LANCER Tre volumi (CY/Z_A)

2.0 DI-D	Diesel	103	01/08 →						
----------	--------	-----	---------	--	--	--	--	--	--

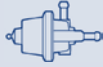

TYPE



TYPE



TYPE

SAA111
SAA111
SAA111
SAA111
SAA111

SAA111
SAA111

SAA111
SAA111
SAA111
SAA111
SAA111

SAA111
SAA111
SAA111

SAA111
SAA111
SAA111

SAA111
SAA111
SAA111
SAA111
SAA111

SPA142 F1

SAA111
SAA111
SAA111

SPA142 F1

SAA111

SAA111

SPA111 F1

SAG072 H1

SPA111 F1



KW



TYPE



TYPE

mitsubishi

LANCER V (CB/D_A)

2.0 Diesel (CB8A)	Diesel	50	06/92 → 12/96						
-------------------	--------	----	---------------	--	--	--	--	--	--

LANCER V Station Wagon (CB_W, CD_W)

1.6 16V (CB4W)	Petrol	83	12/92 → 10/03						
1.6 16V 4WD (CD4W)	Petrol	83	12/92 → 10/03						
2.0 D (CB8W)	Diesel	50	12/92 → 10/03						

LANCER VI (CJ-CP_)

1.5 16V (CK2A)	Petrol	69	12/95 → 08/03						
1.6 16V (CK4A)	Petrol	66	12/95 → 08/03						
2.0 16V EVO	Petrol	206	08/98 → 08/01						

OUTLANDER I (CU_W)

2.0 (CU2W)	Petrol	100	05/03 → 10/06						
2.0 4WD	Petrol	177	05/03 → 10/06						
2.0 4WD (CU2W)	Petrol	100	05/03 → 10/06						
2.0 4WD (CU2W)	Petrol	93	05/03 → 10/06						
2.0 Turbo 4WD (CU2W)	Petrol	148	04/04 → 10/06						
2.4 4WD	Petrol	102	05/03 → 10/06						
2.4 4WD (CU5W)	Petrol	118	11/03 → 10/06						
2.4 4WD (CU5W)	Petrol	119	05/03 → 10/06						

OUTLANDER II (CW_W)

2.0 DI-D	Diesel	103	02/07 → 06/10						
2.0 DI-D	Diesel	103	02/07 → 11/12						
2.0 DI-D	Diesel	103	02/07 → 11/12						
2.2 DI-D 4WD	Diesel	115	08/07 → 11/12						
2.4 4WD	Petrol	125	09/07 → 11/12						

OUTLANDER II Van (CW_W)

2.0 DI-D	Diesel	103	12/06 → 06/10						
----------	--------	-----	---------------	--	--	--	--	--	--

PAJERO CLASSIC (V2_W)

2.5 TD	Diesel	85	07/02 →						
--------	--------	----	---------	--	--	--	--	--	--

PAJERO I (L04_G, L14_G)

2.5 TD (L044G, L049G)	Diesel	64	01/90 → 12/91						
2.5 TD (L044G, L049G)	Diesel	70	11/89 → 11/90						
3.0 V6 (L141G, L146G)	Petrol	104	11/88 → 11/90						

PAJERO I Canvas Top (L04_G)

2.3 TD (L043G, L048G)	Diesel	62	12/82 → 04/86						
2.5 TD (L044G, L049G)	Diesel	62	05/86 → 10/89						
2.5 TD (L044G, L049G)	Diesel	70	11/89 → 11/90						
2.6 (L042G, L047G)	Petrol	76	01/83 → 11/90						

PAJERO II (V3_W, V2_W, V4_W)

2.5 TD 4WD (V24C, V24W)	Diesel	73	12/90 → 10/99						
3.0 V6 24V (V43W, V23W)	Petrol	130	06/97 → 10/99						
3.0 V6 24V (V43W, V23W)	Petrol	133	06/94 → 05/97						
3.0 V6 4WD (V23W, V43W, V23C)	Petrol	110	12/90 → 12/95						
3.5 V6 24V (V25W, V45W)	Petrol	153	06/94 → 10/99						



TYPE

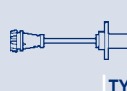

TYPE



TYPE

					SAA111			
					SPA142	F1		
					SPA142	F1		
					SAA111			
					SAA111			
							SAG035	H1
					SAA111			
					SAA111			
					SAA111			
					SAA111			
					SAA111			
					SAA111			
					SAA111			
					SAA111			
					SAA111			
					SPA111	F1		
							SAC085	H2
							SAG166	H1
							SAG167	H1
					SAA111			
					SPA111	F1		
					SAA111			
					SAA111			
					SAA111			
					SAA111			
					SAA111			
					SAA111			
					SAA111			
					SAA111			
					SAA111			
					SAA111			
					SAA111			
					SAA111			
					SAA111			
					SAA111			
					SAA111			
					SAA111			
					SAA111			
					SAA111			
					SAA111			
					SAA111			
					SAA111			
					SAA111			



KW



TYPE



TYPE

mitsubishi

PAJERO II (V3_W, V2_W, V4_W)

3.5 V6 24V (V45W, V25W)	Petrol	143	07/97 → 10/99
-------------------------	--------	-----	---------------

PAJERO II Canvas Top (V2_W, V4_W)

2.5 TD 4WD (V24C, V24W)	Diesel	73	12/90 → 04/00
-------------------------	--------	----	---------------

3.0 V6 (V23W, v43W, V23C)	Petrol	110	12/90 → 12/95
---------------------------	--------	-----	---------------

3.0 V6 24V (V23W, V23C)	Petrol	133	06/94 → 04/00
-------------------------	--------	-----	---------------

PAJERO III Canvas Top (V6_W, V7_W)

2.5 TDi (V64W, V74W)	Diesel	73	04/00 → 12/06
----------------------	--------	----	---------------

3.2 DI-D (V68W, V78W)	Diesel	121	04/00 → 12/06
-----------------------	--------	-----	---------------

3.5 V6 GDI (V65W, V75W)	Petrol	149	04/00 → 12/06
-------------------------	--------	-----	---------------

PAJERO IV (V8_W, V9_W)

3.8 V6 (V87W, V97W)	Petrol	184	02/07 →
---------------------	--------	-----	---------

PAJERO PININ (H6_W, H7_W)

1.8 GDI (H66W)	Petrol	88	10/99 → 06/07
----------------	--------	----	---------------

2.0 GDI (H67W, H77W)	Petrol	95	10/00 → 06/07
----------------------	--------	----	---------------

PAJERO SPORT (K90)

2.5 TD (K94W)	Diesel	73	11/98 →
---------------	--------	----	---------

2.5 TD (K94W)	Diesel	85	07/02 →
---------------	--------	----	---------

2.5 TD (K94W)	Diesel	98	08/03 →
---------------	--------	----	---------

3.0 V6 (K96W)	Petrol	125	06/00 →
---------------	--------	-----	---------

3.0 V6 (K96W)	Petrol	130	11/98 →
---------------	--------	-----	---------

SPACE RUNNER (N1_W, N2_W)

1.8 (N11W)	Petrol	85	06/96 → 08/99
------------	--------	----	---------------

1.8 (N11W)	Petrol	90	09/94 → 08/99
------------	--------	----	---------------

1.8 4WD (N21W)	Petrol	85	06/96 → 08/99
----------------	--------	----	---------------

1.8 4WD (N21W)	Petrol	90	09/94 → 08/99
----------------	--------	----	---------------

2.0 16V	Petrol	98	06/97 → 08/99
---------	--------	----	---------------

SPACE RUNNER (N6_W)

2.0	Petrol	100	08/99 → 08/02
-----	--------	-----	---------------

2.4 GDI	Petrol	110	08/99 → 08/02
---------	--------	-----	---------------

SPACE STAR (DG_A)

1.3 16V (DG1A)	Petrol	60	09/00 → 12/04
----------------	--------	----	---------------

1.3 16V (DG1A)	Petrol	61	12/98 → 12/04
----------------	--------	----	---------------

1.3 16V (DG1A)	Petrol	63	06/98 → 12/04
----------------	--------	----	---------------

1.6 16V (DG3A)	Petrol	72	01/01 → 12/04
----------------	--------	----	---------------

1.8 GDI (DG5A)	Petrol	87	06/98 → 12/04
----------------	--------	----	---------------

1.8 GDI (DG5A)	Petrol	90	06/98 → 12/04
----------------	--------	----	---------------

1.8 MPI	Petrol	82	10/02 → 12/04
---------	--------	----	---------------

1.9 DI-D	Diesel	85	10/02 → 12/04
----------	--------	----	---------------

1.9 DI-D	Diesel	85	10/02 → 07/04
----------	--------	----	---------------

1.9 DI-D (DG4A)	Diesel	75	02/01 → 12/04
-----------------	--------	----	---------------

1.9 DI-D (DG4A)	Diesel	75	02/01 → 07/04
-----------------	--------	----	---------------



KW

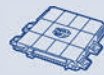

TYPE



TYPE

MITSUBISHI

SPACE WAGON (N3_W, N4_W)

1.8 (N31W)	Petrol	90	09/94 → 10/98						
1.8 4WD (N41W)	Petrol	90	09/94 → 10/98						
2.0 (N33W)	Petrol	98	10/92 → 10/98						
2.0 4WD (N43W)	Petrol	98	10/92 → 10/98						
2.4 i (N34W)	Petrol	102	10/92 → 10/98						

SPACE WAGON (N9_W, N8_W)

2.0 GDI	Petrol	98	10/98 → 12/04						
2.4 GDI	Petrol	108	09/00 → 12/04						
2.4 GDI	Petrol	110	10/98 → 12/04						
2.4 GDI 4WD	Petrol	108	09/00 → 12/04						
2.4 GDI 4WD	Petrol	110	10/98 → 12/04						

NISSAN

100 NX (B13)

1.6	Petrol	66	03/90 → 10/94						
1.6 SR	Petrol	75	09/93 → 10/94						
2.0 GTI	Petrol	105	03/91 → 10/94						

200 SX (S13)

1.8 Turbo	Petrol	124	07/88 → 11/93						
-----------	--------	-----	---------------	--	--	--	--	--	--

200 SX (S14)

2.0 i 16V Turbo	Petrol	147	10/93 → 07/96						
2.0 i 16V Turbo	Petrol	147	08/96 → 12/99						

300 ZX (Z31)

3.0	Petrol	125	01/84 → 12/87						
3.0 TURBO	Petrol	149	05/87 → 10/90						

300 ZX (Z32)

3.0 Twin Turbo	Petrol	197	05/90 → 09/95						
3.0 Twin Turbo	Petrol	208	05/90 → 09/95						

350 Z (Z33)

3.5	Petrol	206	01/05 →						
3.5	Petrol	221	09/02 →						

350 Z Roadster (Z33)

3.5	Petrol	206	03/05 →						
3.5	Petrol	221	04/06 →						

ALMERA I (N15)

1.4	Petrol	64	09/95 → 07/00						
1.4 GX,LX	Petrol	55	09/95 → 07/00						
1.6	Petrol	73	09/95 → 07/00						
1.6 SLX	Petrol	66	09/95 → 07/00						
2.0 D	Diesel	55	11/95 → 07/00						

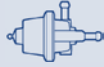

TYPE



TYPE



TYPE

SPA142

F1

SPA142

F1

SPA142

F1

SPA142

F1

SPA142

F1

SPA142

F1

SPA142

F1

SPA142

F1

SPA142

F1

SPA142

F1

SPA137

F1

BAE680DO

SPA137

F1

SPA137

F1

SPA137

F1

SPA137

F1

SGA116

F3

SPA131

F1

SPA131

F1

SPA137

F1

SPA137

F1

SGA116

F3

SGA116

F3

SGA116

F3

SGA116

F3

SGA116

F3

SGA116

F3

SGA116

F3

SGA116

F3

SGA116

F3



KW



TYPE



TYPE

NISSAN

ALMERA I Hatchback (N15)

1.4	Petrol	64	09/95 → 03/00						
1.4 S,GX,LX	Petrol	55	09/95 → 03/00						
1.6	Petrol	73	09/95 → 03/00						
1.6 SR,SLX	Petrol	66	09/95 → 03/00						
2.0 D	Diesel	55	11/95 → 03/00						

ALMERA II (N16)

1.5	Petrol	66	07/00 →						
1.5	Petrol	72	10/02 →						
1.5 dCi	Diesel	60	01/03 →						
1.5 dCi	Diesel	60	01/03 →						
1.5 dCi	Diesel	60	06/03 →						
1.8	Petrol	84	03/01 → 07/02						
1.8	Petrol	85	10/02 →						
1.8	Petrol	84	07/00 →						
2.2 dCi	Diesel	100	09/03 →						
2.2 dCi	Diesel	82	09/03 →						
2.2 Di	Diesel	81	07/00 → 02/03						

ALMERA II Hatchback (N16)

1.5	Petrol	66	03/00 → 07/02						
1.5	Petrol	72	10/02 →						
1.5	Petrol	66	03/00 →						
1.5 dCi	Diesel	60	01/03 →						
1.5 dCi	Diesel	60	01/03 →						
1.5 dCi	Diesel	60	06/03 →						
1.8	Petrol	84	01/00 → 07/02						
1.8	Petrol	85	10/02 →						
1.8	Petrol	84	01/00 →						
2.2 dCi	Diesel	100	09/03 →						
2.2 dCi	Diesel	82	09/03 →						
2.2 Di	Diesel	81	03/00 → 02/03						

ALMERA TINO (V10)

1.8	Petrol	84	08/00 →						
1.8	Petrol	85	12/02 →						
2.0	Petrol	100	08/00 → 01/03						
2.2 dCi	Diesel	100	09/03 →						
2.2 dCi	Diesel	82	09/03 →						
2.2 Di	Diesel	84	08/00 →						

BLUEBIRD (T72 , T12)

1.8 i 16V (RLT72)	Petrol	95	02/89 → 12/90						
2.0 i (HLT72, T12)	Petrol	77	01/88 → 12/90						

BLUEBIRD (U11)

1.8 Turbo	Petrol	99	01/88 → 05/90						
-----------	--------	----	---------------	--	--	--	--	--	--

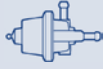

TYPE



TYPE



TYPE

SGA116	F3								
SGA116	F3								
SGA116	F3								
SGA116	F3								
SGA116	F3								

SGA116	F3		SAD029	H3	BAE680BA				
SGA116	F3		SAD029	H3		GA2153		J2	
SPA169	F1		SAD035	H3					
			SAG161	H1					
			SAC010	H1					
SGA116	F3								
SGA116	F3		SAD029	H3		GA2153		J2	
			SAD029	H3	BAE680BA				
SGA116	F3								
SGA116	F3								
SGA116	F3								

SGA116	F3								
SGA116	F3		SAD029	H3		GA2153		J2	
			SAD029	H3					
SPA169	F1		SAD035	H3					
			SAG161	H1					
			SAC010	H1					
SGA116	F3								
SGA116	F3		SAD029	H3		GA2153		J2	
			SAD029	H3					
SGA116	F3								
SGA116	F3								
SGA116	F3								

SGA116	F3		SAD029	H3		GA2194		J2	
SGA116	F3		SAD029	H3		GA2194		J2	
SGA116	F3								
SGA116	F3								
SGA116	F3								
SGA116	F3								

SPA137	F1								
SPA137	F1								
SPA137	F1								



KW



TYPE



TYPE

NISSAN

BLUEBIRD Hatchback (T72, T12)

1.8 i 16V (FRLT72)	Petrol	95	02/89 → 12/90						
1.8 Turbo	Petrol	99	01/88 → 11/92						
2.0 i (FHLT72, T12)	Petrol	77	01/88 → 12/90						

BLUEBIRD Station Wagon (WU11)

2.0 i	Petrol	77	01/88 → 12/90						
-------	--------	----	---------------	--	--	--	--	--	--

INTERSTAR Autobus (X70)

dCi 100	Diesel	73	11/03 →						
dCi 120	Diesel	84	07/02 →						
dCi 140	Diesel	100	11/03 →						
dCi 80	Diesel	60	07/02 → 11/02						
dCi 80	Diesel	60	07/02 →						
dCi 90	Diesel	66	07/02 →						

INTERSTAR Furgonato (X70)

dCi 100	Diesel	73	11/03 →						
dCi 120	Diesel	84	07/02 →						
dCi 140	Diesel	100	11/03 →						
dCi 80	Diesel	60	07/02 → 11/02						
dCi 80	Diesel	60	07/02 →						
dCi 90	Diesel	66	07/02 →						

INTERSTAR Pianale piatto/Telaio

dCi 100	Diesel	73	02/04 →						
dCi 120	Diesel	84	08/03 →						
dCi 140	Diesel	100	11/03 →						

JUKE (F15)

1.6 DIG-T	Petrol	140	06/10 →						
-----------	--------	-----	---------	--	--	--	--	--	--

KUBISTAR (X76)

1.2	Petrol	44	08/03 →						
1.2 16V	Petrol	55	04/06 →						
1.2 16V	Petrol	55	04/06 →						
1.5 dCi	Diesel	42	08/03 →						
1.5 dCi	Diesel	45	08/05 →						
1.5 dCi	Diesel	48	08/03 →						
1.5 dCi	Diesel	60	08/03 →						
1.5 dCi	Diesel	42	08/03 →						
1.5 dCi	Diesel	48	08/03 →						
1.5 dCi	Diesel	60	08/03 →						
1.5 dCi 70	Diesel	50	04/06 →						
1.5 dCi 85	Diesel	62	04/06 →						
1.6 16V	Petrol	70	08/03 →						
1.6 16V	Petrol	70	08/03 →						

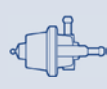
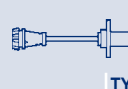
TYPE

TYPE

TYPE

SPA137 F1

SPA137 F1

SPA137 F1

SPA137 F1

SPA169 F1 SAG153 H1

SPA169 F1 SAG153 H1

SGA116 F3

APS34

SPA169 F1 SAG153 H1

SPA169 F1 SAG153 H1

SPA169 F1 SAG153 H1

SPA169 F1 SAG153 H1

SGA116 F3

APS34

SPA169 F1 SAG153 H1

SPA169 F1 SAG153 H1

SPA169 F1 SAG153 H1

SPA169 F1 SAG153 H1

SGA116 F3

GA2109 J2

SPA108 F1 SAD035 H3

SPA108 F1 SAD035 H3

SAG163 H1

SPA169 F1 SAD035 H3

SPA169 F1 SAD035 H3

SPA169 F1 SAD035 H3

SPA169 F1 SAD035 H3

SAG161 H1

SAG161 H1

SAG161 H1

SPA169 F1 SAD035 H3

SPA169 F1 SAD035 H3

 SPA108 F1 SAD035 H3 **BAE680E**

SAG103 H1



KW

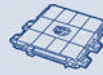

TYPE



TYPE

NISSAN

KUBISTAR Furgonato (X80)

1.2	Petrol	44	08/03 →
1.2 16V	Petrol	55	04/06 →
1.5 dCi	Diesel	48	08/03 →
1.5 dCi	Diesel	60	08/03 →
1.6 16V	Petrol	70	08/03 →
1.6 16V	Petrol	70	08/03 →

LIVINA /GRAND LIVINA (L10)

1.6	Petrol	80	05/10 →
-----	--------	----	---------

MAXIMA II (J30)

3.0 i	Petrol	125	10/88 → 06/94
-------	--------	-----	---------------

MAXIMA QX (A32)

2.0	Petrol	103	02/95 → 08/00
2.5 V6 24V	Petrol	140	02/95 → 08/00

MAXIMA QX (A33)

2.0 V6 24V	Petrol	103	03/00 → 11/03
3.0 V6 24V	Petrol	147	03/00 → 11/03

MAXIMA Station Wagon

2.0 QX	Petrol	103	10/97 →
3.0 QX	Petrol	142	10/97 →

MICRA C+C (K12)

1.4 16V	Petrol	65	08/05 →
1.6 160 SR	Petrol	81	08/05 →
1.6 160 SR	Petrol	81	09/05 → 10/10

MICRA I (K10)

1.2	Petrol	40	07/86 → 07/92
1.2	Petrol	44	07/86 → 07/92

MICRA II (K11)

1.0 i 16V	Petrol	40	08/92 → 12/95			TB0006	B3
1.0 i 16V	Petrol	40	02/98 → 07/00			TB0008	B3
1.0 i 16V	Petrol	40	07/00 → 09/00			SVF016	B6
1.0 i 16V	Petrol	40	12/95 → 02/98			TB0007	B3
1.0 i 16V	Petrol	44	09/00 → 10/02			SVF016	B6
1.0 i 16V	Petrol	40	01/96 → 09/00				
1.0 i 16V	Petrol	44	09/00 → 02/03				
1.0 i 16V	Petrol	40	08/92 → 09/00				
1.3 i 16V	Petrol	55	08/92 → 12/95			TB0005	B3
1.3 i 16V	Petrol	55	02/98 → 07/00			TB0001	B3
1.3 i 16V	Petrol	55	12/95 → 02/98			TB0004	B3
1.3 i 16V	Petrol	55	01/96 → 02/98				
1.3 i 16V	Petrol	55	08/92 → 09/00				
1.4 i 16V	Petrol	60	09/00 → 10/02			SVF016	B6
1.4 i 16V	Petrol	60	09/00 → 02/03				
1.5 D	Diesel	42	02/98 → 02/03				

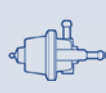

TYPE

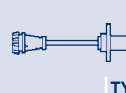

TYPE



TYPE

				SPA108	F1			SAD035	H3			
				SPA108	F1			SAD035	H3			
								SAD035	H3			
								SAD035	H3			
				SPA108	F1			SAD035	H3			
								SAG103	H1			
												BAE680AS
				SPA137	F1							BAE680CL
				SGA116	F3							BAE680N
												BAE680N
				SGA116	F3							BAE680N
				SGA116	F3							BAE680N
				SGA116	F3							BAE680N
				SGA116	F3							BAE680N
				SGA116	F3			SAD029	H3			
				SGA116	F3			SAD029	H3			
												BAE680AS
												BAE680DO
												BAE680DO
				SPA150	F1							
								SAC094	H2			BAE680AN
												BAE680AN
				SGA116	F3							
				SGA116	F3			SAC094	H2			
												ESS0143A
				SPA150	F1							J1
				SGA116	F3							
												ESS0143A
												J1
				SGA116	F3							
								SAC094	H2			ESS0143A
												J1
												SAA118



KW



TYPE



TYPE

NISSAN

MICRA III (K12)

1.0 16V	Petrol	48	01/03 → 05/05
1.0 16V	Petrol	48	01/03 → 06/10
1.2 16V	Petrol	48	01/03 → 05/05
1.2 16V	Petrol	59	01/03 → 05/05
1.2 16V	Petrol	48	01/03 → 06/10
1.2 16V	Petrol	59	01/03 → 06/10
1.4 16V	Petrol	65	01/03 → 05/05
1.4 16V	Petrol	65	01/03 → 06/10
1.5 dCi	Diesel	48	01/03 → 06/10
1.5 dCi	Diesel	50	06/05 → 06/10
1.5 dCi	Diesel	60	09/03 → 06/10
1.5 dCi	Diesel	63	06/05 → 06/10
1.5 dCi	Diesel	48	01/03 → 06/10
1.5 dCi	Diesel	60	09/03 → 06/10
160 SR	Petrol	81	05/05 → 06/10
160 SR	Petrol	81	06/05 → 06/10

MICRA IV (K13)

1.2	Petrol	59	05/10 →
1.2 DIG	Petrol	72	04/11 →

NAVARA (D40)

2.5 dCi 4WD	Diesel	128	07/05 →
-------------	--------	-----	---------

NOTE (E11)

1.4	Petrol	65	03/06 →
1.5 dCi	Diesel	50	03/06 →
1.5 dCi	Diesel	63	03/06 →
1.5 dCi	Diesel	76	07/08 →
1.6	Petrol	81	03/06 →

NV200 Furgonato

1.6 16V	Petrol	81	02/10 →
---------	--------	----	---------

PATHFINDER (R50)

3.3 V6 4WD	Petrol	110	03/98 → 07/00
3.3 V6 4WD	Petrol	125	09/97 → 07/00
3.5 V6 4WD	Petrol	162	11/00 → 12/04

PATHFINDER (R51)

2.5 dCi 4WD	Diesel	128	03/05 →
4.0 4WD	Petrol	198	09/05 →

PATROL GR I (Y60, GR)

2.8 TD (Y60A)	Diesel	85	09/88 → 06/97
4.2 Cat.	Petrol	121	11/88 → 02/98

PATROL GR II Wagon (Y61)

2.8 TD	Diesel	95	06/97 → 05/00
--------	--------	----	---------------

PATROL Station Wagon (W260)

2.8 TD	Diesel	85	06/89 → 11/95
--------	--------	----	---------------

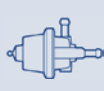

TYPE

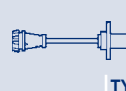

TYPE



TYPE

				SGA116	F3							
								SAD029	H3			
				SGA116	F3							
				SGA116	F3							
								SAD029	H3		GA2028	J2
								SAD029	H3		GA2028	J2
				SGA116	F3							
								SAD029	H3	BAE680R	GA2028	J2
				SPA169	F1			SAD035	H3			
				SPA169	F1			SAD035	H3			
				SPA169	F1			SAD035	H3			
				SPA169	F1			SAD035	H3			
								SAG161	H1			
								SAG161	H1			
				SGA116	F3			SAD029	H3			
										BAE680AS		
											GA2144	J2
											GA2144	J2
				SGA116	F3							
				SGA116	F3			SAD029	H3			
				SPA169	F1			SAD035	H3			
				SPA169	F1			SAD035	H3			
								SAC010	H1			
				SGA116	F3			SAD029	H3	BAE680AS		
										BAE680AS		
				SGA116	F3							
				SGA116	F3							
				SGA116	F3							
				SGA116	F3							
								SAD029	H3			
				SPA131	F1							
				SPA137	F1							
				SGA116	F3							
				SPA131	F1							



KW



TYPE



TYPE

NISSAN

PICK UP (D21)

2.4 i 12V	Petrol	91	04/92 → 02/98					
2.4 i 12V 4WD	Petrol	93	04/92 → 02/98					
2.4 i 12V 4WD	Petrol	93	04/92 → 02/98					
2.4 i 4WD	Petrol	74	03/86 → 04/92					
3.0 i V6 4WD	Petrol	109	09/90 → 02/98					

PICK UP (D22)

2.4 i	Petrol	88	02/98 →					
2.4 i	Petrol	88	02/98 → 11/01					
2.4 i 4WD	Petrol	88	02/98 →					
2.4 i 4WD	Petrol	88	02/98 → 11/01					
2.5 D	Diesel	61	02/98 → 11/01					
2.5 D 4WD	Diesel	61	02/98 → 11/01					
2.5 TD 4WD	Diesel	76	05/98 → 11/01					

PRAIRIE PRO (M11)

2.0 i	Petrol	72	10/88 → 04/92					
2.0 i 4x4	Petrol	72	10/88 → 12/92					
2.4 i	Petrol	98	04/92 → 07/94					
2.4 i 4x4	Petrol	98	04/92 → 07/94					

PRIMASTAR Autobus (X83)

2.0	Petrol	88	03/01 →					
dCi 100	Diesel	74	03/01 → 01/02					
dCi 100	Diesel	74	03/01 →					
dCi 120	Diesel	84	09/06 →					
dCi 140	Diesel	99	07/03 →					
dCi 80	Diesel	60	03/01 → 01/02					
dCi 80	Diesel	60	03/01 →					
dCi 90	Diesel	66	09/06 →					

PRIMASTAR Furgonato (X83)

2.0	Petrol	88	02/03 →					
dCi 100	Diesel	74	09/02 →					
dCi 120	Diesel	84	09/06 →					
dCi 140	Diesel	99	07/03 →					
dCi 80	Diesel	60	09/02 →					
dCi 90	Diesel	66	09/06 →					

PRIMERA (P10)

1.6	Petrol	66	06/90 → 09/94					
1.6	Petrol	66	06/90 → 05/93					
1.6	Petrol	71	06/90 → 09/94					
1.6	Petrol	66	06/90 → 01/96					
2.0 16V	Petrol	85	06/90 → 05/93					
2.0 16V	Petrol	85	06/90 → 01/96					
2.0 16V 4x4	Petrol	85	04/91 → 05/93					
2.0 D	Diesel	55	01/91 → 12/92					
2.0 D	Diesel	55	01/93 → 01/96					



KW



TYPE



TYPE

NISSAN

PRIMERA (P10)

2.0 GT	Petrol	110	06/90 → 05/93					
2.0 GT	Petrol	110	06/93 → 09/94					
2.0 GT	Petrol	110	06/90 → 01/96					

PRIMERA (P11)

1.6 16V	Petrol	78	06/96 → 12/01					
1.8 16V	Petrol	84	08/99 → 12/01					
2.0 16V	Petrol	103	08/99 → 12/01					

PRIMERA (P12)

1.6	Petrol	78	03/02 →					
1.6	Petrol	80	01/02 →					
1.8	Petrol	85	03/02 →					
1.9 dCi	Diesel	88	04/03 →					
2.0	Petrol	103	03/02 →					
2.0	Petrol	103	03/02 →					

PRIMERA Hatchback (P10)

1.6	Petrol	66	06/90 → 05/93					
1.6	Petrol	66	05/93 → 09/94					
1.6	Petrol	71	06/90 → 06/93					
1.6	Petrol	75	06/93 → 09/94					
2.0	Petrol	110	06/93 → 09/94					
2.0 16V	Petrol	85	06/90 → 05/93					
2.0 16V	Petrol	85	06/90 → 01/96					
2.0 16V 4x4	Petrol	85	04/91 → 05/93					
2.0 16V 4x4	Petrol	85	04/91 → 06/96					
2.0 D	Diesel	55	01/91 → 12/92					
2.0 D	Diesel	55	01/93 → 01/96					

PRIMERA Hatchback (P11)

1.6 16V	Petrol	78	09/00 → 12/01					
1.8 16V	Petrol	84	08/99 → 12/01					
2.0 16V	Petrol	103	08/99 → 12/01					

PRIMERA Hatchback (P12)

1.6	Petrol	78	07/02 →					
1.6	Petrol	80	07/02 →					
1.8	Petrol	85	07/02 →					
1.9 dCi	Diesel	88	04/03 →					
2.0	Petrol	103	07/02 →					
2.0	Petrol	103	07/02 →					

PRIMERA Station wagon (WP12)

1.6 Visia	Petrol	80	01/02 →					
1.8	Petrol	85	03/02 →					
1.9 dCi	Diesel	88	04/03 →					
2.0	Petrol	103	03/02 →					
2.0	Petrol	103	03/02 →					

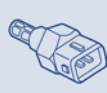
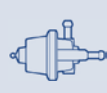

TYPE

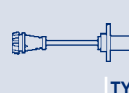

TYPE



TYPE

				SPA126	F1				
				SPA150	F1				
								BAE680DO	
				SGA116	F3				
				SGA116	F3				
				SGA116	F3				
				SGA116	F3		SAD029	H3	GA2194
				SGA116	F3		SAD029	H3	GA2194
				SGA116	F3		SAD029	H3	BAE680BA
				SPA169	F1				GA2194
				SGA116	F3		SAC052	H2	BAE680BE
							SAD029	H3	GA2194
				SPA137	F1				
				SPA150	F1				
				SPA150	F1				
				SPA150	F1				
				SPA150	F1				
				SPA126	F1				
									BAE680DO
				SPA126	F1				
									BAE680DO
				SPA131	F1				
				SPA150	F1				
				SGA116	F3				
				SGA116	F3				
				SGA116	F3				
				SGA116	F3		SAD029	H3	GA2194
				SGA116	F3		SAD029	H3	GA2194
				SGA116	F3		SAD029	H3	GA2194
				SPA169	F1				
				SGA116	F3		SAC052	H2	GA2194
							SAD029	H3	
				SGA116	F3		SAD029	H3	GA2194
				SGA116	F3		SAD029	H3	GA2194
				SPA169	F1				
				SGA116	F3		SAC052	H2	GA2194
							SAD029	H3	



KW



TYPE



TYPE

NISSAN

PRIMERA Traveller (W10)

1.6 i	Petrol	66	07/90 → 05/93						
2.0 D	Diesel	55	07/90 → 12/92						
2.0 D	Diesel	55	01/93 → 12/95						
2.0 i	Petrol	85	07/90 → 07/94						
2.0 i	Petrol	85	07/90 → 03/98						

PRIMERA Traveller (WP11)

1.6 16V	Petrol	66	04/98 → 06/99						
1.6 16V	Petrol	73	04/98 → 12/01						
1.8 16V	Petrol	84	08/99 → 12/01						
2.0 16V	Petrol	103	12/01 → 12/01						
2.0 16V	Petrol	85	06/96 → 06/99						
2.0 16V	Petrol	96	04/98 → 06/99						
2.0 16V	Petrol	103	08/99 → 12/01						
2.0 16V	Petrol	96	04/98 → 12/01						
2.0 TD	Diesel	66	04/98 → 12/01						

QASHQAI / QASHQAI +2 (J10, JJ10)

1.5 dCi	Diesel	78	02/07 →						
1.5 dCi	Diesel	76	08/08 →						
1.5 dCi	Diesel	78	08/08 →						
1.5 dCi	Diesel	81	11/10 →						
1.6	Petrol	84	02/07 →						
1.6	Petrol	84	02/07 →						
2.0	Petrol	103	02/07 →						
2.0 dCi	Diesel	110	02/07 →						
2.0 dCi Trazione integrale	Diesel	110	02/07 →						
2.0 Trazione integrale	Petrol	103	02/07 →						

SERENA (C23M)

1.6 16V	Petrol	71	02/93 → 09/94						
2.0 16V	Petrol	93	11/92 → 09/01						
2.0 D	Diesel	49	11/92 → 09/01						

SUNNY Furgonato (Y10)

1.6 i 16V	Petrol	66	10/92 → 03/00						
1.7 D	Diesel	40	11/90 → 10/92						

SUNNY II (N13)

1.6 i 12V	Petrol	66	10/88 → 06/91						
-----------	--------	----	---------------	--	--	--	--	--	--

SUNNY II Coupé (B12)

1.6 i 12V	Petrol	66	10/88 → 06/91						
-----------	--------	----	---------------	--	--	--	--	--	--

SUNNY II Hatchback (N13)

1.6 i 12V	Petrol	66	06/86 → 10/90						
1.8 GTI 16V	Petrol	92	01/89 → 06/91						

SUNNY II Traveller (B12)

1.6 i 12V	Petrol	66	10/88 → 06/91						
1.6 i 12V 4x4	Petrol	66	10/88 → 08/90						

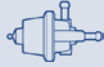

TYPE



TYPE



TYPE

				SPA137	F1					
				SPA131	F1					
				SPA150	F1					
				SPA126	F1					
										BAE680DO
				SGA116	F3					
				SGA116	F3					
				SGA116	F3				ESS0143A	J1
				SGA116	F3					
				SGA116	F3					
				SGA116	F3					
										ESS0143A J1
										ESS0143A J1
				SGA116	F3					
				SPA169	F1	SAD035	H3	SUA577	J3	
						SAC010	H1			
						SAC010	H1			
						SAC010	H1			
						SAD029	H3	BAE680AS	GA2162	J2
									SUA568	J3
						SAD029	H3			
						SAC077	H2	SUA577	J3	
						SAC077	H2	SUA562	J3	
						SAD029	H3			
				SPA150	F1					
				SPA150	F1			BAE680DO		
				SPA150	F1					
				SPA137	F1			BAE680DO		
				SPA131	F1					
								BAE680DO		
								BAE680DO		
								BAE680DO		
								BAE680DO		
				SPA137	F1					
								BAE680DO		
								BAE680DO		

KW

TYPE

TYPE
NISSAN
SUNNY III (N14)

1.4	Petrol	60	10/90 → 05/95					
1.4 i	Petrol	55	10/90 → 05/95					
1.6 i	Petrol	66	10/90 → 05/95					
1.6 i 16V 4WD	Petrol	66	10/90 → 05/95					
2.0 D	Diesel	55	10/90 → 10/92					

SUNNY III Hatchback (N14)

1.4	Petrol	60	10/90 → 05/95					
1.4 i	Petrol	55	10/90 → 05/95					
1.4 i 16V	Petrol	64	10/90 → 05/95					
1.6 i	Petrol	66	10/90 → 05/95					
1.6 i 16V 4x4	Petrol	75	10/92 → 05/95					
2.0 D	Diesel	55	10/90 → 10/92					
2.0 GTI 16V	Petrol	105	10/90 → 05/95					
2.0 GTI-R 4x4	Petrol	162	10/90 → 05/95					

SUNNY III Liftback (N14)

1.4	Petrol	60	10/90 → 05/95					
1.4 i	Petrol	55	10/90 → 05/95					
1.6 i	Petrol	66	10/90 → 05/95					
2.0 D	Diesel	55	10/90 → 10/92					
2.0 i 16V	Petrol	105	10/90 → 05/95					

SUNNY III Traveller (Y10)

1.6 16V 4x4	Petrol	66	11/90 → 05/95					
1.6 i	Petrol	66	06/91 → 03/00					
1.6 i 16V 4x4	Petrol	75	10/92 → 03/00					
2.0 D	Diesel	55	06/91 → 10/92					

TERRANO I (WD21)

2.4 i 4WD	Petrol	76	10/87 → 02/93					
-----------	--------	----	---------------	--	--	--	--	--

TERRANO II (R20)

2.4 i 12V 4WD	Petrol	91	02/93 → 06/96					
2.7 TD 4WD	Diesel	74	02/93 → 01/02					
2.7 TDi 4WD	Diesel	92	05/96 →					
3.0 Di 4WD	Diesel	113	05/02 →					

TIIDA 2 volumi /Coda spiovente (C11X)

1.5 dCi	Diesel	78	09/07 →					
1.6	Petrol	81	09/07 →					
1.8	Petrol	93	09/07 →					
1.8	Petrol	93	09/07 → 03/10					

TIIDA Tre volumi (SC11X)

1.5 dCi	Diesel	78	09/07 →					
1.6	Petrol	81	09/07 →					
1.8	Petrol	93	09/07 →					
1.8	Petrol	93	09/07 → 03/10					

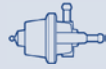

TYPE



TYPE



TYPE

										BAE680DO	
				SPA137	F1					BAE680DO	
				SPA137	F1					BAE680DO	
				SPA137	F1					BAE680DO	
				SPA131	F1					BAE680DO	
										BAE680DO	
				SPA137	F1					BAE680DO	
				SPA137	F1					BAE680DO	
				SPA137	F1					BAE680DO	
				SPA137	F1					BAE680DO	
				SPA131	F1					BAE680DO	
				SPA137	F1					BAE680DO	
				SPA137	F1					BAE680DO	
				SPA137	F1					BAE680DO	
				SPA131	F1					BAE680DO	
				SPA137	F1					BAE680DO	
				SPA137	F1					BAE680DO	
				SPA137	F1					BAE680DO	
				SPA137	F1					BAE680DO	
				SPA131	F1					BAE680DO	
				SPA137	F1					BAE680DO	
							SAG063	H1			
				SGA116	F3						
				SPA169	F1		SAD035	H3			
				SGA116	F3		SAD029	H3		BAE680AS	
							SAD029	H3			
										BAE680AS	
				SPA169	F1		SAD035	H3			
				SGA116	F3		SAD029	H3		BAE680AS	
							SAD029	H3			
										BAE680AS	



KW

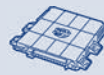

TYPE



TYPE

NISSAN

URVAN Autobus (E24)

2.4 i	Petrol	74	05/89 → 09/93						
2.5 D	Diesel	59	05/89 → 10/96						

URVAN Autobus (V2_)

3.0 Di	Diesel	77	02/02 →						
--------	--------	----	---------	--	--	--	--	--	--

URVAN Furgonato (E24)

2.3 D	Diesel	51	01/88 → 05/97						
2.5 D	Diesel	59	12/88 → 05/97						

URVAN Furgonato (E25)

3.0 d	Diesel	77	02/02 → 01/12						
-------	--------	----	---------------	--	--	--	--	--	--

VANETTE Autobus (C22)

2.4 i (SLC22)	Petrol	74	10/86 → 12/95						
2.4 i (SLC22)	Petrol	77	10/86 → 12/95						

VANETTE CARGO Autobus (HC 23)

1.6 i	Petrol	72	01/96 →						
1.6 i	Petrol	72	01/96 → 11/01						

VANETTE CARGO Furgonato (HC 23)

1.6 i	Petrol	71	01/95 →						
1.6 i	Petrol	71	01/95 → 11/01						

X-TRAIL (T30)

2.0	Petrol	103	07/01 →						
2.0	Petrol	103	09/03 →						
2.0 4x4	Petrol	103	07/01 →						
2.0 4x4	Petrol	103	09/03 →						
2.2 dCi	Diesel	100	12/03 →						
2.2 dCi 4x4	Diesel	100	12/03 →						
2.2 Di 4x4	Diesel	84	07/01 →						
2.5 4x4	Petrol	121	09/02 →						
2.5 4x4	Petrol	121	09/03 →						

X-TRAIL (T31)

2.0	Petrol	104	06/07 →						
2.0	Petrol	103	06/08 →						
2.0 dCi	Diesel	110	06/07 →						
2.0 dCi	Diesel	127	06/07 →						
2.0 FWD	Petrol	103	06/08 → 07/10						
2.0 FWD	Petrol	104	04/07 → 07/10						
2.5 4x4	Petrol	124	06/07 →						

OPEL

AGILA (A) (H00)

1.0	Petrol	44	08/03 → 12/07						
1.0	Petrol	44	08/03 → 12/07						
1.0	Petrol	44	08/03 → 12/07						
1.0 12V	Petrol	43	09/00 → 12/07						
1.0 12V	Petrol	43	09/00 → 08/03						



TYPE



TYPE



TYPE

SPA137 F1

SPA131 F1

SGA116 F3

SPA131 F1

SPA131 F1

SGA116 F3

SPA137 F1

SPA137 F1

SPA150 F1

SGA116 F3

SPA150 F1

SGA116 F3

SGA116 F3 SAC052 H2 BAE680BE

SAD029 H3

SGA116 F3 SAC052 H2

SAD029 H3

SGA116 F3

SGA116 F3

SGA116 F3

SGA116 F3 SAC052 H2 BAE680BE

SAD029 H3

SAD029 H3 BAE680AS

BAE680AS

SAC077 H2

SAC077 H2

BAE680AS

BAE680AS

SAC052 H2 BAE680DI

FEI0004

SPA171 F1 SAA103 SAC092 H2 BAE680BN

SAD026 H3

SAG019 H1

SPA171 F1 SAA103

SPA103 F1 SAG019 H1 BAE680AI



KW



TYPE



TYPE

OPEL

AGILA (A) (H00)

1.2 16V	Petrol	55	09/00 → 12/07					
1.2 16V	Petrol	55	09/00 → 06/04					
1.2 16V Twinport	Petrol	59	07/04 → 12/07					
1.2 16V Twinport	Petrol	59	07/04 → 12/07					
1.2 16V Twinport	Petrol	59	07/04 → 12/07					
1.3 CDTI	Diesel	51	08/03 → 12/07					
1.3 CDTI	Diesel	51	08/03 → 12/07					

AGILA (B) (H08)

1.3 CDTI	Diesel	55	04/08 →					
1.3 CDTI	Diesel	55	04/08 →					

AMPERA

EV 150		111	11/11 →					
--------	--	-----	---------	--	--	--	--	--

ANTARA

2.4	Petrol	104	05/06 →					
3.2 V6	Petrol	167	03/07 →					

ARENA Combi (THB)

1.9 D	Diesel	44	03/98 → 08/01					
-------	--------	----	---------------	--	--	--	--	--

ARENA Furgonato (TB, TF)

1.9 D	Diesel	44	03/98 → 08/01					
-------	--------	----	---------------	--	--	--	--	--

ASCONA C (81_, 86_, 87_, 88_)

1.8	Petrol	62	09/87 → 08/88					
1.8 E	Petrol	74	01/85 → 08/86					
1.8 i	Petrol	85	09/82 → 08/86					
2.0 i	Petrol	85	09/86 → 08/88					
2.0 i GT	Petrol	95	03/87 → 08/88					

ASCONA C 2 volumi /Coda spiovente (84_, 89_)

1.8	Petrol	62	09/87 → 08/88					
1.8 E	Petrol	74	01/85 → 08/86					
1.8 i	Petrol	85	09/82 → 08/86					
2.0 i	Petrol	85	09/86 → 08/88					
2.0 i GT	Petrol	95	03/87 → 08/88					

ASTRA F (56_, 57_)

1.4	Petrol	55	09/91 → 09/93					
1.4	Petrol	60	09/92 → 09/98					
1.4	Petrol	60	09/92 → 09/98					
1.4	Petrol	55	09/91 → 09/93	ENGINE: 14NV				
1.4	Petrol	60	09/92 → 09/98	ENGINE: 14SE-C14SE-X14NZ				
1.4	Petrol	60	09/92 → 02/98					
1.4 i	Petrol	44	09/91 → 09/98			SVF014		B6
1.4 i	Petrol	44	09/91 → 09/98					
1.4 i	Petrol	44	09/91 → 09/98	ENGINE: C14NZ				
1.4 i	Petrol	44	09/91 → 02/98					
1.4 i 16V	Petrol	66	02/96 → 09/98			B3215		B1
1.4 i 16V	Petrol	66	02/96 → 09/98					



TYPE

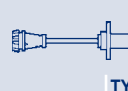

TYPE



TYPE

			SPA171	F1	SAA103				ESS0057A	J1
			SPA103	F1		SAG019	H1	BAE680AJ		
FEI0004			SPA171	F1	SAA103	SAC092	H2	BAE680AL	ESS0057A	J1
						SAD026	H3			
						SAG019	H1			
	APS23					SAC093	H2			
						SAG025	H1			
	SPS001					SAC093	H2			
						SAG025	H1			
					SAA103					
						SAD024	H3			
			SPA171	F1		SAD004	H3			
						SAG159	H1			
						SAG159	H1			
			SPA104	F1						
			SPA104	F1						
			SPA104	F1						
			SPA104	F1						
			SPA104	F1						
			SPA104	F1						
			SPA104	F1						
			SPA104	F1						
			SPA104	F1						
			SSA042	F2						
			SPA104	F1		SAG141	H1			
			SSA042	F2						
								BAE608I		
								BAE608I		
									ESS530	J1
	APS45		SPA104	F1						
			SSA042	F2						
								BAE608I		
									ESS525	J1
	APS45		ATS17	F2		SAC082	H2			
			SPA104	F1		SAD027	H3			



KW

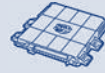

TYPE



TYPE

OPEL

ASTRA F (56_, 57_)

1.4 i 16V	Petrol	66	02/96 → 09/98					
1.4 i 16V	Petrol	66	02/96 → 09/98	ENGINE: 02DF5762 →				
1.4 i 16V	Petrol	66	02/96 → 09/98	ENGINE: X14XE				
1.4 i 16V	Petrol	66	03/96 → 02/98					
1.4 Si	Petrol	60	03/92 → 09/98				B3215	B1
1.4 Si	Petrol	60	03/92 → 09/98				SVF013	B6
1.4 Si	Petrol	60	03/92 → 09/98	ENGINE: 14SE-C14SE-X14NZ				
1.4 Si	Petrol	60	03/92 → 02/98					
1.6	Petrol	55	09/95 → 09/98				B3253	B1
1.6	Petrol	55	09/95 → 09/98				SVF014	B6
1.6	Petrol	55	09/95 → 09/98	ENGINE: 16NZR-C16NZ-X16SZR-				
1.6	Petrol	55	09/95 → 02/98					
1.6 i	Petrol	52	05/93 → 07/96				B3253	B1
1.6 i	Petrol	52	05/93 → 07/96				SVF014	B6
1.6 i	Petrol	55	03/92 → 09/98				SVF014	B6
1.6 i	Petrol	55	03/92 → 08/94				B3253	B1
1.6 i	Petrol	55	08/96 → 09/98				B3253	B1
1.6 i	Petrol	55	03/92 → 09/98					
1.6 i	Petrol	52	05/93 → 07/96	ENGINE: X16SZ				
1.6 i	Petrol	55	03/92 → 08/94	ENGINE: 16NZR-C16NZ-X16SZR-				
1.6 i	Petrol	55	08/96 → 09/98	ENGINE: 16NZR-C16NZ-X16SZR-				
1.6 i	Petrol	52	05/93 → 02/96					
1.6 i	Petrol	55	08/96 → 08/97					
1.6 i 16V	Petrol	74	08/94 → 09/98				B3215	B1
1.6 i 16V	Petrol	74	08/94 → 09/98				SVF013	B6
1.6 i 16V	Petrol	74	08/94 → 09/98					
1.6 i 16V	Petrol	74	08/94 → 09/98	ENGINE: 02DF5762 →				
1.6 i 16V	Petrol	74	08/94 → 09/98	ENGINE: C16SE-X16XEL				
1.6 i 16V	Petrol	74	08/94 → 02/98					
1.6 Si	Petrol	74	05/92 → 12/94				B3215	B1
1.6 Si	Petrol	74	05/92 → 12/94				SVF013	B6
1.6 Si	Petrol	74	05/92 → 12/94	ENGINE: C16SE-X16XEL				
1.7 D	Diesel	42	03/92 → 09/92					
1.7 D	Diesel	42	03/92 → 09/92					
1.7 TD	Diesel	50	11/94 → 09/98					
1.7 TDS	Diesel	60	03/92 → 09/98					
1.8 i	Petrol	66	03/92 → 09/98				B3253	B1
1.8 i	Petrol	66	03/92 → 09/98					
1.8 i	Petrol	66	03/92 → 02/98					
1.8 i	Petrol	66	03/92 → 02/98					
1.8 i 16V	Petrol	85	11/94 → 09/98				B3397	B1



TYPE



TYPE



TYPE

			SSA042	F2						
						SAG124	H1			
								BAE608I		
									ESS530	J1
	APS45		SPA104	F1		SAG141	H1			
			SSA042	F2						
								BAE608I		
									ESS530	J1
	APS45		SPA104	F1		SAD027	H3			
			SSA042	F2		SAG141	H1			
								BAE608I		
									ESS525	J1
	APS45		SPA104	F1		SAG141	H1			
			SSA042	F2						
	APS45		SPA104	F1						
									ESS525	J1
			SSA042	F2						
								BAE608I		
								BAE608I		
								BAE608I		
									ESS525	J1
									ESS525	J1
	APS45		ATS17	F2		SAC082	H2			
			SPA104	F1		SAD027	H3			
			SSA042	F2						
						SAG124	H1			
								BAE608I		
									ESS530	J1
	APS45		SPA104	F1		SAG141	H1		ESS530	J1
			SSA042	F2						
								BAE608I		
			SPA130	F1						
			SSA042	F2						
			SPA123	F1						
			SPA130	F1						
	APS45		SPA104	F1						
			SSA042	F2						
									ESS530	J1
									ESS525	J1
			ATS12	F2		SAC046	H2			



KW

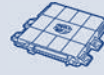

TYPE



TYPE

OPEL

ASTRA F (56_, 57_)

1.8 i 16V	Petrol	85	09/95 → 09/98			SVF015	B6
1.8 i 16V	Petrol	92	06/93 → 10/94			B3397	B1
1.8 i 16V	Petrol	92	09/93 → 10/94			SVF015	B6
1.8 i 16V	Petrol	92	06/93 → 10/94				
1.8 i 16V	Petrol	85	11/94 → 09/98				
1.8 i 16V	Petrol	85	09/95 → 08/97	ENGINE: 14142429 →			
1.8 i 16V	Petrol	85	11/94 → 08/98				
1.8 i 16V	Petrol	92	08/93 → 10/94				
2.0 i	Petrol	85	03/92 → 02/98			SVF015	B6
2.0 i	Petrol	85	03/92 → 09/98				
2.0 i	Petrol	85	03/92 → 09/98				
2.0 i	Petrol	85	03/92 → 09/98	CHASSIS: S2000001 →			
2.0 i	Petrol	85	03/92 → 02/98				
2.0 i 16V	Petrol	100	02/95 → 09/98			B3397	B1
2.0 i 16V	Petrol	100	02/95 → 02/98			SVF015	B6
2.0 i 16V	Petrol	100	02/95 → 09/98				
2.0 i 16V	Petrol	100	02/95 → 09/98	ENGINE: 14142429 →			
2.0 i 16V	Petrol	100	02/95 → 02/98				

ASTRA F 2 volumi /Coda spiovente (53_, 54_, 58_, 59_)

1.4	Petrol	60	09/92 → 01/98			B3215	B1
1.4	Petrol	55	09/91 → 09/93				
1.4	Petrol	60	09/92 → 01/98				
1.4	Petrol	55	09/91 → 09/93	ENGINE: 14NV			
1.4	Petrol	60	09/92 → 01/98	ENGINE: 14SE-C14SE-X14NZ			
1.4 i	Petrol	44	03/92 → 01/98			SVF014	B6
1.4 i	Petrol	44	03/92 → 01/98				
1.4 i	Petrol	44	03/92 → 01/98	ENGINE: C14NZ			
1.4 i 16V	Petrol	66	01/96 → 01/98			B3215	B1
1.4 i 16V	Petrol	66	01/96 → 01/98				
1.4 i 16V	Petrol	66	01/96 → 01/98				
1.4 i 16V	Petrol	66	01/96 → 01/98	ENGINE: 02DF5762 →			
1.4 i 16V	Petrol	66	01/96 → 01/98	ENGINE: X14XE			
1.4 i 16V	Petrol	66	03/96 → 01/98				
1.4 Si	Petrol	60	03/92 → 01/98			B3215	B1
1.4 Si	Petrol	60	03/92 → 01/98			SVF013	B6
1.4 Si	Petrol	60	03/92 → 01/98	ENGINE: 14SE-C14SE-X14NZ			
1.6	Petrol	55	09/95 → 01/98			B3253	B1
1.6	Petrol	55	09/95 → 01/98			SVF014	B6
1.6	Petrol	55	09/97 → 01/98				
1.6 i	Petrol	52	05/93 → 07/96			B3253	B1
1.6 i	Petrol	52	05/93 → 07/96			SVF014	B6
1.6 i	Petrol	55	09/91 → 01/98			B3253	B1
1.6 i	Petrol	55	09/91 → 01/98			SVF014	B6
1.6 i	Petrol	52	05/93 → 07/96	ENGINE: X16SZ			

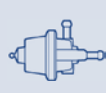

TYPE

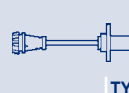

TYPE



TYPE

	APS45		SSA042	F2		SAC046	H2			
						SAD012	H3			
			SSA042	F2		SAD012	H3			
						SAG107	H1			
									ESS530	J1
									ESS530	J1
			SPA104	F1						
			SSA042	F2						
						SAG093	H1			
									ESS530	J1
			ATS12	F2		SAC046	H2			
			SSA042	F2		SAD012	H3			
						SAG107	H1			
									ESS530	J1
			SPA104	F1		SAG141	H1		ESS530	J1
			SSA042	F2						
			SSA042	F2						
									BAE608I	
									BAE608I	
	APS45		SPA104	F1					ESS525	J1
			SSA042	F2						
									BAE608I	
	APS45		ATS17	F2		SAD027	H3			
			SPA104	F1						
			SSA042	F2						
						SAG124	H1			
									BAE608I	
									ESS530	J1
	APS45		SPA104	F1		SAG141	H1		ESS530	J1
			SSA042	F2						
									BAE608I	
	APS45		SPA104	F1		SAD027	H3			
			SSA042	F2		SAG141	H1			
									ESS525	J1
	APS45		SPA104	F1		SAG141	H1			
			SSA042	F2						
	APS45		SPA104	F1		SAD027	H3			
			SSA042	F2		SAG141	H1			
									BAE608I	



KW



TYPE



TYPE

OPEL

ASTRA F 2 volumi /Coda spiovente (53_, 54_, 58_, 59_)

1.6 i	Petrol	55	09/91 → 01/98	ENGINE: 16NZR-C16NZ-X16SZR-			
1.6 i	Petrol	52	05/93 → 02/96				
1.6 i	Petrol	55	08/94 → 09/95				
1.6 i 16V	Petrol	74	08/94 → 01/98			B3215	B1
1.6 i 16V	Petrol	74	08/94 → 01/98			SVF013	B6
1.6 i 16V	Petrol	74	08/94 → 01/98				
1.6 i 16V	Petrol	74	08/94 → 01/98	ENGINE: 02DF5762 →			
1.6 i 16V	Petrol	74	08/94 → 01/98	ENGINE: C16SE-X16XEL			
1.6 Si	Petrol	74	03/92 → 12/94			B3215	B1
1.6 Si	Petrol	74	03/92 → 12/94			SVF013	B6
1.6 Si	Petrol	74	03/92 → 12/94	ENGINE: C16SE-X16XEL			
1.7 D	Diesel	42	12/91 → 09/92				
1.7 TD	Diesel	50	11/94 → 01/98				
1.7 TDS	Diesel	60	12/91 → 01/98				
1.8 i	Petrol	66	09/91 → 01/98			B3253	B1
1.8 i	Petrol	66	09/91 → 01/98			SVF014	B6
1.8 i 16V	Petrol	85	09/94 → 01/98			B3397	B1
1.8 i 16V	Petrol	85	09/95 → 01/98			SVF015	B6
1.8 i 16V	Petrol	92	06/93 → 08/94			B3397	B1
1.8 i 16V	Petrol	92	09/93 → 08/94			SVF015	B6
1.8 i 16V	Petrol	92	06/93 → 08/94				
1.8 i 16V	Petrol	85	09/94 → 01/98				
1.8 i 16V	Petrol	85	09/95 → 08/97	ENGINE: 14142429 →			
1.8 i 16V	Petrol	92	08/93 → 08/94				
2.0 GSI 16V	Petrol	110	09/92 → 01/98			SVF015	B6
2.0 GSI 16V	Petrol	110	09/91 → 01/98				
2.0 GSI 16V	Petrol	110	09/91 → 01/98				
2.0 i	Petrol	85	09/91 → 01/98			SVF015	B6
2.0 i	Petrol	85	09/91 → 01/98				
2.0 i	Petrol	85	09/91 → 01/98	CHASSIS: S2000001 →			
2.0 i 16V	Petrol	100	02/95 → 01/98			B3397	B1
2.0 i 16V	Petrol	100	02/95 → 01/98			SVF015	B6
2.0 i 16V	Petrol	100	02/95 → 01/98	ENGINE: 14142429 →			

ASTRA F Cabriolet (53_B)

1.4 i 16V	Petrol	66	01/96 → 03/01			B3215	B1
1.4 i 16V	Petrol	66	01/96 → 03/01				
1.4 i 16V	Petrol	66	01/96 → 03/01				
1.4 i 16V	Petrol	66	01/96 → 03/01	ENGINE: 02DF5762 →			
1.4 i 16V	Petrol	66	01/96 → 03/01	ENGINE: X14XE			
1.4 i 16V	Petrol	66	03/96 → 02/98				
1.4 Si	Petrol	60	05/93 → 03/01			B3215	B1
1.4 Si	Petrol	60	05/93 → 03/01			SVF013	B6
1.4 Si	Petrol	60	05/93 → 03/01	ENGINE: 14SE-C14SE-X14NZ			



TYPE

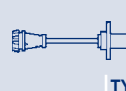

TYPE



TYPE

									BAE608I		
										ESS525	J1
										ESS525	J1
		APS45	ATS17	F2		SAC082	H2			ESS530	J1
			SPA104	F1		SAD027	H3				
			SSA042	F2							
						SAG124	H1				
									BAE608I		
		APS45	SPA104	F1		SAG141	H1			ESS530	J1
			SSA042	F2							
									BAE608I		
			SPA130	F1							
			SPA123	F1							
			SPA130	F1							
		APS45	SPA104	F1						ESS525	J1
			SSA042	F2						ESS530	J1
			ATS12	F2		SAC046	H2			ESS530	J1
		APS45	SSA042	F2		SAC046	H2				
						SAD012	H3				
			SSA042	F2		SAD012	H3				
						SAG107	H1				
										ESS530	J1
			SPA104	F1		SAG093	H1			ESS530	J1
			SSA042	F2							
			SPA104	F1						ESS530	J1
			SSA042	F2							
						SAG093	H1				
			ATS12	F2		SAC046	H2			ESS530	J1
			SSA042	F2		SAD012	H3				
						SAG107	H1				
		APS45	ATS17	F2		SAC082	H2				
			SPA104	F1		SAD027	H3				
			SSA042	F2							
						SAG124	H1				
									BAE608I		
										ESS530	J1
		APS45	SSA042	F2		SAG141	H1				
									BAE608I		



KW



TYPE



TYPE

OPEL

ASTRA F Cabriolet (53_B)

1.4 Si	Petrol	60	05/93 → 02/98					
1.6 i	Petrol	52	03/93 → 08/96				B3253	B1
1.6 i	Petrol	55	01/96 → 03/01				B3253	B1
1.6 i	Petrol	52	03/93 → 08/96					
1.6 i	Petrol	55	01/96 → 03/01					
1.6 i	Petrol	52	03/93 → 08/96	ENGINE: X16SZ				
1.6 i	Petrol	55	01/96 → 03/01	ENGINE: 16NZR-C16NZ-X16SZR-				
1.6 i	Petrol	52	03/93 → 02/96					
1.6 i	Petrol	55	01/96 → 08/97					
1.8 i 16V	Petrol	85	11/94 → 03/01				B3397	B1
1.8 i 16V	Petrol	85	09/95 → 08/98				SVF015	B6
1.8 i 16V	Petrol	85	11/94 → 03/01					
1.8 i 16V	Petrol	85	11/94 → 03/01	ENGINE: 14142429 →				
1.8 i 16V	Petrol	85	11/94 → 08/98					
2.0 i	Petrol	85	03/93 → 10/94				SVF015	B6
2.0 i	Petrol	85	03/93 → 12/93					
2.0 i	Petrol	85	03/93 → 10/94	CHASSIS: S2000001 →				

ASTRA F CLASSIC 2 volumi /Coda spiovente

1.2 i	Petrol	48	03/98 → 08/00					
1.4 i	Petrol	44	01/98 → 08/02				SVF014	B6
1.4 i	Petrol	66	03/98 → 08/00					
1.4 i	Petrol	44	01/98 → 08/00					
1.6 i	Petrol	55	01/98 → 08/02				B3253	B1
1.6 i	Petrol	55	01/98 → 08/02					
1.6 i	Petrol	55	01/98 → 08/02	ENGINE: X16SZR				
1.6 i	Petrol	55	01/98 → 08/00					
1.6 i 16V	Petrol	74	01/98 → 08/02				B3215	B1
1.6 i 16V	Petrol	74	01/98 → 08/02				SVF013	B6
1.6 i 16V	Petrol	74	01/98 → 08/02					
1.6 i 16V	Petrol	74	01/98 → 08/02	ENGINE: X16XEL				
1.6 i 16V	Petrol	74	01/98 → 08/00					
2.0 DI	Diesel	60	03/98 → 08/00					

ASTRA F CLASSIC Station wagon

1.4 i	Petrol	44	01/98 → 01/05				SVF014	B6
1.4 i	Petrol	44	01/98 → 08/00					
1.6 i	Petrol	55	01/98 → 01/05				SVF014	B6
1.6 i	Petrol	55	01/98 → 01/05					
1.6 i	Petrol	55	01/98 → 01/05	ENGINE: X16SZR				
1.6 i	Petrol	55	01/98 → 08/00					
1.6 i 16V	Petrol	74	01/98 → 01/05				B3215	B1
1.6 i 16V	Petrol	74	01/98 → 01/05				SVF013	B6
1.6 i 16V	Petrol	74	01/98 → 01/05					
1.6 i 16V	Petrol	74	01/98 → 01/05	ENGINE: X16XEL				



TYPE

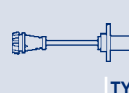

TYPE



TYPE

									ESS530	J1
	APS45		SPA104	F1		SAG141	H1			
	APS45		SPA104	F1		SAD027	H3			
			SSA042	F2						
			SSA042	F2		SAG141	H1			
								BAE608I		
								BAE608I		
								ESS525	J1	
								ESS525	J1	
			ATS12	F2		SAC046	H2			
			SSA042	F2		SAD012	H3			
						SAG107	H1			
								ESS530	J1	
			SSA042	F2				ESS530	J1	
			SPA104	F1						
						SAG093	H1			
			SPA171	F1						
	APS45					SAD027	H3			
								ESS525	J1	
	APS45					SAD027	H3			
						SAG141	H1			
								BAE608I		
								ESS525	J1	
	APS45		ATS17	F2		SAC082	H2			
						SAD027	H3			
						SAG124	H1			
								BAE608I		
								ESS530	J1	
			SPA171	F1						
	APS45									
								ESS525	J1	
	APS45					SAD027	H3			
						SAG141	H1			
								BAE608I		
								ESS525	J1	
	APS45		ATS17	F2		SAC082	H2			
						SAD027	H3			
						SAG124	H1			
								BAE608I		



KW

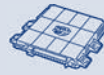

TYPE



TYPE

OPEL

ASTRA F CLASSIC Station wagon

1.6 i 16V	Petrol	74	02/04 → 01/05	ENGINE: Z16XEP				
1.6 i 16V	Petrol	74	01/98 → 08/00					

ASTRA F CLASSIC Tre volumi

1.4 i	Petrol	44	01/98 → 08/02				SVF014	B6
1.4 i	Petrol	44	01/98 → 08/00					
1.6 i	Petrol	55	01/98 → 08/02				B3253	B1
1.6 i	Petrol	55	01/98 → 08/02					
1.6 i	Petrol	55	01/98 → 08/02	ENGINE: 16NZR-C16NZ-X16SZR-				
1.6 i	Petrol	55	01/98 → 08/00					
1.6 i 16V	Petrol	74	01/98 → 08/02				B3215	B1
1.6 i 16V	Petrol	74	01/98 → 08/02				SVF013	B6
1.6 i 16V	Petrol	74	01/98 → 08/02					
1.6 i 16V	Petrol	74	01/98 → 08/02	ENGINE: X16XEL				
1.6 i 16V	Petrol	74	01/98 → 08/00					

ASTRA F Station wagon (51_, 52_)

1.4	Petrol	60	09/92 → 01/98				B3215	B1
1.4	Petrol	55	09/91 → 09/93					
1.4	Petrol	60	09/92 → 01/98					
1.4	Petrol	55	09/91 → 09/93	ENGINE: 14NV				
1.4	Petrol	60	09/92 → 01/98	ENGINE: 14SE-C14SE-X14NZ				
1.4 i	Petrol	44	09/91 → 01/98				SVF014	B6
1.4 i	Petrol	44	09/91 → 01/98					
1.4 i 16V	Petrol	66	02/96 → 01/98				B3215	B1
1.4 i 16V	Petrol	66	02/96 → 01/98					
1.4 i 16V	Petrol	66	02/96 → 01/98					
1.4 i 16V	Petrol	66	02/96 → 01/98	ENGINE: 02DF5762 →				
1.4 i 16V	Petrol	66	02/96 → 01/98	ENGINE: X14XE				
1.4 i 16V	Petrol	66	03/96 → 01/98					
1.4 Si	Petrol	60	03/92 → 01/98				B3215	B1
1.4 Si	Petrol	60	03/92 → 01/98				SVF013	B6
1.4 Si	Petrol	60	03/92 → 01/98	ENGINE: 14SE-C14SE-X14NZ				
1.6	Petrol	55	09/95 → 01/98				B3253	B1
1.6	Petrol	55	09/95 → 01/98				SVF014	B6
1.6	Petrol	55	09/95 → 01/98	ENGINE: 16NZR-C16NZ-X16SZR-				
1.6 i	Petrol	52	05/93 → 07/96				B3253	B1
1.6 i	Petrol	52	05/93 → 07/96				SVF014	B6
1.6 i	Petrol	55	09/91 → 01/98				B3253	B1
1.6 i	Petrol	55	09/91 → 01/98				SVF014	B6
1.6 i	Petrol	52	05/93 → 07/96	ENGINE: X16SZ				
1.6 i	Petrol	55	09/91 → 01/98	ENGINE: 16NZR-C16NZ-X16SZR-				
1.6 i	Petrol	52	05/93 → 02/96					

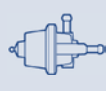

TYPE

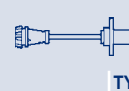

TYPE



TYPE

								BAE608L	
								ESS530	J1
	APS45							ESS525	J1
	APS45					SAD027	H3		
						SAG141	H1		
								BAE608I	
								ESS525	J1
	APS45	ATS17	F2			SAC082	H2		
						SAD027	H3		
						SAG124	H1		
								BAE608I	
								ESS530	J1
		SPA104	F1			SAG141	H1	ESS530	J1
		SSA042	F2						
		SSA042	F2						
								BAE608I	
								BAE608I	
	APS45	SPA104	F1					ESS525	J1
		SSA042	F2						
	APS45	ATS17	F2			SAC082	H2		
		SPA104	F1			SAD027	H3		
		SSA042	F2						
						SAG124	H1		
								BAE608I	
								ESS530	J1
	APS45	SPA104	F1			SAG141	H1	ESS530	J1
		SSA042	F2						
								BAE608I	
	APS45	SPA104	F1			SAD027	H3	ESS525	J1
		SSA042	F2			SAG141	H1		
								BAE608I	
	APS45	SPA104	F1			SAG141	H1		
		SSA042	F2						
	APS45	SPA104	F1			SAD027	H3		
		SSA042	F2			SAG141	H1		
								BAE608I	
								BAE608I	
								ESS525	J1



KW

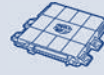

TYPE



TYPE

OPEL

ASTRA F Station wagon (51_, 52_)

1.6 i	Petrol	55	08/94 → 09/95					
1.6 i 16V	Petrol	74	08/94 → 01/98				B3215	B1
1.6 i 16V	Petrol	74	08/94 → 01/98				SVF013	B6
1.6 i 16V	Petrol	74	08/94 → 01/98					
1.6 i 16V	Petrol	74	08/94 → 01/98	ENGINE: 02DF5762 →				
1.6 i 16V	Petrol	74	08/94 → 01/98	ENGINE: C16SE-X16XEL				
1.6 Si	Petrol	74	03/92 → 12/94				B3215	B1
1.6 Si	Petrol	74	03/92 → 12/94				SVF013	B6
1.6 Si	Petrol	74	03/92 → 12/94	ENGINE: C16SE-X16XEL				
1.7 D	Diesel	42	12/91 → 09/92					
1.7 TD	Diesel	50	11/94 → 01/98					
1.7 TDS	Diesel	60	12/91 → 01/98					
1.8 i	Petrol	66	09/91 → 01/98				B3253	B1
1.8 i	Petrol	66	09/91 → 01/98				SVF014	B6
1.8 i 16V	Petrol	85	07/94 → 01/98				B3397	B1
1.8 i 16V	Petrol	85	09/95 → 01/98				SVF015	B6
1.8 i 16V	Petrol	92	06/93 → 01/98				B3397	B1
1.8 i 16V	Petrol	92	09/93 → 01/98				SVF015	B6
1.8 i 16V	Petrol	92	06/93 → 01/98					
1.8 i 16V	Petrol	85	07/94 → 01/98					
1.8 i 16V	Petrol	85	09/95 → 08/97	ENGINE: 14142429 →				
1.8 i 16V	Petrol	85	08/94 → 01/98					
1.8 i 16V	Petrol	92	08/93 → 01/98					
2.0 i	Petrol	85	09/91 → 07/94				SVF015	B6
2.0 i	Petrol	85	09/91 → 07/94					
2.0 i	Petrol	85	09/91 → 07/94	CHASSIS: S2000001 →				
2.0 i 16V	Petrol	100	02/95 → 01/98				B3397	B1
2.0 i 16V	Petrol	100	02/95 → 01/98				SVF015	B6
2.0 i 16V	Petrol	110	03/93 → 01/98				SVF015	B6
2.0 i 16V	Petrol	110	03/93 → 01/98					
2.0 i 16V	Petrol	100	02/95 → 01/98	ENGINE: 14142429 →				

ASTRA F Van (55_)

1.4 i	Petrol	44	10/91 → 01/99				SVF014	B6
1.4 i	Petrol	44	10/91 → 01/99					
1.4 i	Petrol	44	10/91 → 01/99	ENGINE: C14NZ				
1.4 i	Petrol	44	10/91 → 02/98					
1.6 i	Petrol	52	02/93 → 07/96				B3253	B1
1.6 i	Petrol	55	10/91 → 04/93				SVF014	B6
1.6 i	Petrol	55	10/91 → 04/93				B3253	B1
1.6 i	Petrol	52	02/93 → 07/96					
1.6 i	Petrol	52	02/93 → 07/96	ENGINE: X16SZ				
1.6 i	Petrol	55	10/91 → 04/93	ENGINE: 16NZR-C16NZ-X16SZR-				
1.6 i	Petrol	52	02/93 → 02/96					

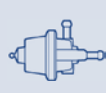

TYPE

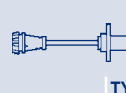

TYPE



TYPE

									ESS525	J1
	APS45		ATS17	F2		SAC082	H2		ESS530	J1
			SPA104	F1		SAD027	H3			
			SSA042	F2						
						SAG124	H1			
								BAE608I		
	APS45		SPA104	F1		SAG141	H1		ESS530	J1
			SSA042	F2						
								BAE608I		
			SPA130	F1						
			SPA123	F1						
			SPA130	F1						
	APS45		SPA104	F1					ESS525	J1
			SSA042	F2					ESS530	J1
			ATS12	F2		SAC046	H2			
	APS45		SSA042	F2		SAC046	H2			
						SAD012	H3			
			SSA042	F2		SAD012	H3			
						SAG107	H1			
									ESS530	J1
									ESS530	J1
			SPA104	F1					ESS530	J1
			SSA042	F2						
						SAG093	H1			
			ATS12	F2		SAC046	H2		ESS530	J1
			SSA042	F2		SAD012	H3			
			SPA104	F1		SAG093	H1		ESS530	J1
			SSA042	F2						
						SAG107	H1			
	APS45		SPA104	F1						
			SSA042	F2						
								BAE608I		
									ESS525	J1
	APS45		SPA104	F1		SAG141	H1			
	APS45		SPA104	F1					ESS525	J1
			SSA042	F2						
			SSA042	F2						
								BAE608I		
								BAE608I		
									ESS525	J1



KW

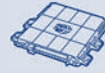

TYPE



TYPE

OPEL

ASTRA F Van (55_)

1.7 D	Diesel	42	12/91 → 09/92					
1.7 TD	Diesel	50	08/94 → 01/99					

ASTRA G 2 volumi /Coda spiovente (F48_, F08_)

1.2 16V	Petrol	48	02/98 → 09/00				SVF016	B6
1.2 16V	Petrol	55	09/00 → 01/05				PAS001	B5
1.2 16V	Petrol	48	02/98 → 09/00					
1.2 16V	Petrol	55	09/00 → 09/03					
1.2 16V	Petrol	55	09/00 → 09/03					
1.4	Petrol	66	09/07 → 12/09				PAS001	B5
1.4	Petrol	66	09/07 → 06/09					
1.4 16V	Petrol	66	02/98 → 01/05				B3215	B1
1.4 16V	Petrol	66	02/98 → 01/05				PAS001	B5
1.4 16V	Petrol	66	02/98 → 01/05				SVF013	B6
1.4 16V	Petrol	66	02/98 → 09/00					
1.4 16V	Petrol	66	02/98 → 01/05	ENGINE: X14XE-Z14XE				
1.4 16V	Petrol	66	02/98 → 01/04					
1.4 16V	Petrol	66	02/98 → 09/00	ENGINE: X14XE				
1.6	Petrol	55	02/98 → 09/00				SVF014	B6
1.6	Petrol	62	09/00 → 01/05				PAS001	B5
1.6	Petrol	76	12/02 → 12/09				PAS001	B5
1.6	Petrol	55	02/98 → 09/00					
1.6	Petrol	62	09/00 → 01/05					
1.6	Petrol	62	09/00 → 01/05					
1.6	Petrol	76	12/02 → 12/09					
1.6	Petrol	76	12/02 → 12/09	ENGINE: 20EL9416 →				
1.6	Petrol	55	02/98 → 09/00	ENGINE: 16NZR-C16NZ- X16SZR-				
1.6	Petrol	62	09/00 → 01/05	ENGINE: Z16SE				
1.6	Petrol	62	09/00 → 01/04					
1.6	Petrol	76	02/03 → 01/04					
1.6 16V	Petrol	74	02/98 → 01/05				B3215	B1
1.6 16V	Petrol	74	02/98 → 01/05				PAS001	B5
1.6 16V	Petrol	74	02/98 → 01/05				SVF013	B6
1.6 16V	Petrol	74	02/98 → 08/00					
1.6 16V	Petrol	74	02/98 → 01/05	ENGINE: C16SEL-X16XEL- Z16XE				
1.6 16V	Petrol	74	03/00 → 01/05	ENGINE: Z16XEP				
1.6 16V	Petrol	74	02/98 → 01/04					
1.7 CDTI	Diesel	59	04/03 → 12/09				PAS001	B5
1.7 CDTI	Diesel	59	04/03 → 01/04	ENGINE: Z17DTL				
1.7 DTI 16V	Diesel	55	02/00 → 01/05				PAS006	B5
1.7 TD	Diesel	50	02/98 → 08/00				PAS006	B5
1.8 16V	Petrol	92	09/00 → 01/05				PAS001	B5
1.8 16V	Petrol	85	02/98 → 09/00					



TYPE

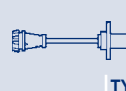

TYPE



TYPE

				SPA130	F1						
				SPA123	F1						
				SPA103	F1	SAA103	SAG019	H1	BAE680AJ	ESS532	J1
				SPA171	F1	SAA103				SUA507	J1
										SUA507	J1
				SPA103	F1		SAG019	H1	BAE680AJ		
										ESS532	J1
FEI0004				SPA171	F1	SAA103	SAC092	H2			
									BAE680AL		
	APS45			ATS17	F2		SAC080	H2	BAE608H	SUA507	J1
				SPA171	F1		SAD027	H3			
							SAG020	H1			
				SPA103	F1						
									BAE608F		
										ESS532	J1
										ESS530	J1
	APS45			SPA103	F1		SAD027	H3		ESS525	J1
				ATS17	F2		SAC063	H2		SUA507	J1
				SPA171	F1		SAC057	H2			
							SAG137	H1			
				SPA171	F1		SAD027	H3			
							SAG020	H1			
							SAG020	H1			
						SAA103					
									BAE608I		
									BAE608G		
										ESS532	J1
										ESS532	J1
	APS45			ATS17	F2		SAC080	H2	BAE608H		
				SPA171	F1		SAD027	H3			
							SAG020	H1			
				SPA103	F1						
									BAE608F		
									BAE608L		
										ESS532	J1
	APS43			SPA171	F1		SAC094	H2			
	APS53						SAG117	H1			
				SPA128	F1		SAG060	H1			
							SAC071	H2			
							SAC071	H2			



KW



TYPE



TYPE

OPEL

ASTRA G 2 volumi /Coda spiovente (F48_, F08_)

1.8 16V	Petrol	85	02/98 → 09/00					
1.8 16V	Petrol	85	02/98 → 09/00					
1.8 16V	Petrol	92	09/00 → 01/05					
1.8 16V	Petrol	92	09/00 → 01/05					
1.8 16V	Petrol	85	02/98 → 08/00					
1.8 16V	Petrol	92	09/00 → 01/04					
2.0 16V	Petrol	100	02/98 → 01/05			B3397		B1
2.0 16V	Petrol	100	02/98 → 01/04			SVF016		B6
2.0 16V	Petrol	100	02/98 → 01/04					
2.0 16V OPC	Petrol	118	11/99 → 09/02			B3397		B1
2.0 16V OPC	Petrol	118	11/99 → 09/02			SVF016		B6
2.0 DI	Diesel	60	02/98 → 01/05			PAS006		B5
2.0 DI	Diesel	60	03/98 → 08/00					
2.0 DI	Diesel	60	02/98 → 01/05	CHASSIS: → 38999999				
2.0 DI	Diesel	60	02/98 → 01/05	CHASSIS: → 38999999				
2.0 DTI 16V	Diesel	74	08/99 → 01/05			PAS001		B5
2.0 DTI 16V	Diesel	74	08/99 → 01/05	CHASSIS: 12000001 → 2H999999				
2.0 DTI 16V	Diesel	74	09/00 → 01/04					
2.0 DTI 16V	Diesel	74	08/99 → 01/05	CHASSIS: → 38999999				
2.0 DTI 16V	Diesel	74	08/99 → 01/05	CHASSIS: → 38999999				
2.0 OPC	Petrol	141	09/02 → 01/05			PAS001		B5
2.0 OPC	Petrol	147	11/02 → 01/05			PAS001		B5
2.0 OPC	Petrol	141	09/02 → 01/05					
2.0 OPC	Petrol	141	09/02 → 01/04					
2.0 OPC	Petrol	147	11/02 → 01/05					
2.0 OPC	Petrol	147	11/02 → 01/04					
2.2 16V	Petrol	108	06/00 → 01/05			PAS001		B5
2.2 16V	Petrol	108	06/00 → 01/05	ENGINE: Z22SE				
2.2 DTI	Diesel	92	09/02 → 01/05			PAS006		B5
2.2 DTI	Diesel	92	09/02 → 01/04					
2.2 DTI	Diesel	92	09/02 → 01/04					
2.2 DTI	Diesel	92	09/02 → 01/05	CHASSIS: → 38999999				
2.2 DTI	Diesel	92	09/02 → 01/05	CHASSIS: → 38999999				

ASTRA G Cabriolet (F67)

1.6	Petrol	76	01/03 → 10/05			PAS001		B5
1.6	Petrol	76	01/03 → 10/05					
1.6	Petrol	76	01/03 → 10/05	ENGINE: 20EL9416 →				
1.6	Petrol	76	02/03 → 08/05					
1.6 16V	Petrol	74	03/01 → 10/05			B3215		B1
1.6 16V	Petrol	74	03/01 → 10/05			PAS001		B5
1.6 16V	Petrol	74	03/01 → 10/05					
1.6 16V	Petrol	74	03/01 → 10/05	ENGINE: C16SEL-X16XEL-Z16XE				



TYPE



TYPE



TYPE

							SAD015	H3			
							SAG116	H1			
							SAD015	H3			
							SAG120	H1			
										ESS532	J1
										ESS532	J1
				ATS12	F2		SAC032	H2			
										ESS532	J1
							SAC032	H2		ESS532	J1
										SUA507	J1
				SPA171	F1						
				SPA103	F1						
							SAG021	H1			
							SAG021-1	H1			
				SPA171	F1						
	APS26										
				SPA103	F1						
							SAG021	H1			
							SAG021-1	H1			
				ATS10	F2		SAC035	H2			
				ATS10	F2		SAC035	H2			
				SPA171	F1		SAG057	H1			
				SPA103	F1					BAE680BL	
				SPA171	F1		SAG057	H1			
				SPA103	F1					BAE680BL	
	APS44			SPA115	F1		SAG083	H1			
										BAE608N	
				SPA171	F1						
				ATS20	F2						
				SPA103	F1						
							SAG021	H1			
							SAG021-1	H1			
				SPA171	F1		SAC057	H2			
							SAG020	H1			
						SAA103					
										ESS532	J1
	APS44			ATS17	F2		SAC080	H2	BAE608H		
				SPA171	F1		SAD027	H3			
							SAG020	H1			
										BAE608F	



KW



TYPE



TYPE

OPEL

ASTRA G Cabriolet (F67)

1.6 16V	Petrol	74	03/01 → 10/05	ENGINE: Z16XEP				
1.6 16V	Petrol	74	03/01 → 08/05					
1.8 16V	Petrol	92	03/01 → 10/05				PAS001	B5
1.8 16V	Petrol	92	03/01 → 10/05					
1.8 16V	Petrol	92	03/01 → 10/05					
1.8 16V	Petrol	92	03/01 → 08/05					
2.0 16V Turbo	Petrol	147	11/02 → 08/05				SVF016	B6
2.0 16V Turbo	Petrol	147	11/02 → 10/05					
2.0 16V Turbo	Petrol	147	11/02 → 10/05					
2.0 OPC	Petrol	141	03/02 → 10/05				PAS001	B5
2.0 OPC	Petrol	141	03/02 → 08/05				SVF016	B6
2.0 OPC	Petrol	141	03/02 → 10/05					
2.2 16V	Petrol	108	03/01 → 10/05				PAS001	B5
2.2 16V	Petrol	108	03/01 → 10/05	ENGINE: Z22SE				
2.2 DTI	Diesel	92	09/02 → 10/05				PAS006	B5
2.2 DTI	Diesel	92	09/02 → 08/05					
2.2 DTI	Diesel	92	09/02 → 08/05					
2.2 DTI	Diesel	92	09/02 → 10/05	CHASSIS: → 38999999				
2.2 DTI	Diesel	92	09/02 → 10/05	CHASSIS: → 38999999				

ASTRA G Coupé (F07_)

1.6 16V	Petrol	74	03/00 → 05/05				PAS001	B5
1.6 16V	Petrol	76	03/00 → 05/05				PAS001	B5
1.6 16V	Petrol	76	03/00 → 05/05	ENGINE: 20EL9416 →				
1.6 16V	Petrol	76	10/03 → 05/05					
1.6 16V	Petrol	76	03/00 → 05/05	ENGINE: Z16XEP				
1.6 16V	Petrol	76	02/03 → 02/05					
1.8 16V	Petrol	92	09/00 → 05/05				PAS001	B5
1.8 16V	Petrol	85	03/00 → 10/00					
1.8 16V	Petrol	85	03/00 → 10/00					
1.8 16V	Petrol	85	03/00 → 10/00					
1.8 16V	Petrol	92	09/00 → 05/05					
1.8 16V	Petrol	92	09/00 → 05/05					
1.8 16V	Petrol	85	03/00 → 08/00					
1.8 16V	Petrol	92	09/00 → 02/05					
2.0 16V Turbo	Petrol	140	09/00 → 08/01				SVF016	B6
2.0 16V Turbo	Petrol	140	09/00 → 08/01				PAS001	B5
2.0 16V Turbo	Petrol	141	08/01 → 05/05				PAS001	B5
2.0 16V Turbo	Petrol	141	08/01 → 02/05				SVF016	B6
2.0 16V Turbo	Petrol	147	11/02 → 02/05				SVF016	B6
2.0 16V Turbo	Petrol	141	08/01 → 05/05					
2.0 16V Turbo	Petrol	147	11/02 → 05/05					
2.0 16V Turbo	Petrol	147	11/02 → 05/05					
2.2 16V	Petrol	108	09/00 → 05/05				PAS001	B5
2.2 16V	Petrol	108	09/00 → 05/05	ENGINE: Z22SE				

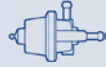

TYPE



TYPE



TYPE

										BAE608L		
											ESS532	J1
									SAC071	H2		
									SAD015	H3		
									SAG120	H1		
											ESS532	J1
									SPA103	F1		
									ATS10	F2		
									SAC035	H2		
									SAG057	H1		
									ATS10	F2		
									SAC035	H2		
									SPA103	F1		
									SPA171	F1		
									SAG057	H1		
		APS44							SPA115	F1		
									SAG083	H1		
											BAE608N	
									SPA171	F1		
									ATS20	F2		
									SPA103	F1		
									SAG021	H1		
									SAG021-1	H1		
									SPA171	F1		
											SAA103	
									SAC057	H2		
									SAG020	H1		
											BAE608L	
											ESS532	J1
									SAC071	H2		
									SAC071	H2		
									SAD015	H3		
									SAG116	H1		
									SAD015	H3		
									SAG120	H1		
											ESS532	J1
											ESS532	J1
									SPA103	F1		
									SAC035	H2	BAE680BL	
									SAG057	H1		
									ATS10	F2		
									SAC035	H2		
									SPA103	F1		
											BAE680BL	
									SPA103	F1		
											BAE680BL	
									SPA171	F1		
									SAG057	H1		
									ATS10	F2		
									SAC035	H2		
									SAG057	H1		
									APS44			
									SPA115	F1		
									SAG083	H1		
											BAE608N	



KW



TYPE



TYPE

OPEL

ASTRA G Coupé (F07_)

2.2 DTI	Diesel	92	09/02 → 05/05				PAS006	B5
2.2 DTI	Diesel	92	09/02 → 02/05					
2.2 DTI	Diesel	92	09/02 → 02/05					
2.2 DTI	Diesel	92	09/02 → 05/05	CHASSIS: → 38999999				
2.2 DTI	Diesel	92	09/02 → 05/05	CHASSIS: → 38999999				

ASTRA G Furgonato (F70)

1.6	Petrol	55	01/99 → 09/00				SVF014	B6
1.6	Petrol	62	09/00 → 04/05				PAS001	B5
1.6	Petrol	55	01/99 → 09/00					
1.6	Petrol	62	09/00 → 04/05					
1.6	Petrol	62	09/00 → 04/05					
1.6	Petrol	62	09/00 → 04/05	ENGINE: Z16SE				
1.6	Petrol	62	09/00 → 06/04					
1.7 TD	Diesel	50	01/99 → 04/05				PAS006	B5
1.7 TD	Diesel	50	01/99 → 08/00					
2.0 DI	Diesel	60	01/99 → 04/05				PAS006	B5
2.0 DI	Diesel	60	01/99 → 08/00					
2.0 DI	Diesel	60	01/99 → 04/05	CHASSIS: → 38999999				
2.0 DI	Diesel	60	01/99 → 04/05	CHASSIS: → 38999999				

ASTRA G Station wagon (F35_)

1.2 16V	Petrol	48	02/98 → 09/00				SVF016	B6
1.2 16V	Petrol	55	09/00 → 07/04				PAS001	B5
1.2 16V	Petrol	55	09/00 → 09/03					
1.2 16V	Petrol	55	09/00 → 09/03					
1.4	Petrol	66	09/07 → 12/09				PAS001	B5
1.4	Petrol	66	09/07 → 07/09					
1.4 16V	Petrol	66	06/98 → 07/04				B3215	B1
1.4 16V	Petrol	66	06/98 → 07/04				PAS001	B5
1.4 16V	Petrol	66	06/98 → 07/04				SVF013	B6
1.4 16V	Petrol	66	06/98 → 09/00					
1.4 16V	Petrol	66	06/98 → 07/04	ENGINE: X14XE-Z14XE				
1.4 16V	Petrol	66	06/98 → 06/04					
1.4 16V	Petrol	66	06/98 → 09/00	ENGINE: X14XE				
1.6	Petrol	55	02/98 → 09/00				SVF014	B6
1.6	Petrol	62	09/00 → 07/04				PAS001	B5
1.6	Petrol	76	12/02 → 07/09				PAS001	B5
1.6	Petrol	55	02/98 → 09/00					
1.6	Petrol	62	09/00 → 07/04					
1.6	Petrol	62	09/00 → 07/04					
1.6	Petrol	76	12/02 → 07/09					
1.6	Petrol	76	12/02 → 07/09	ENGINE: 20EL9416 →				
1.6	Petrol	62	09/00 → 07/04	ENGINE: Z16SE				
1.6	Petrol	62	09/00 → 06/04					
1.6	Petrol	76	02/03 → 06/04					

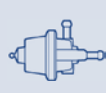

TYPE

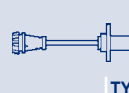

TYPE



TYPE

				SPA171	F1					
				ATS20	F2					
				SPA103	F1					
							SAG021	H1		
							SAG021-1	H1		
	APS45			SPA103	F1		SAD027	H3	ESS525	J1
				ATS17	F2		SAC063	H2		
							SAG137	H1		
				SPA171	F1		SAD027	H3		
							SAG020	H1		
								BAE608G		
									ESS532	J1
				SPA171	F1		SAG060	H1		
				SPA128	F1					
				SPA171	F1					
				SPA103	F1					
							SAG021	H1		
							SAG021-1	H1		
				SPA103	F1	SAA103	SAG019	H1	BAE680AJ	ESS532
				SPA171	F1	SAA103				
				SPA103	F1		SAG019	H1	BAE680AJ	
									ESS532	J1
				SPA171	F1	SAA103	SAC092	H2		
								BAE680AL		
	APS45			ATS17	F2		SAC080	H2	BAE608H	
				SPA171	F1		SAD027	H3		
							SAG020	H1		
				SPA103	F1				BAE608F	
									ESS532	J1
									ESS530	J1
	APS45			SPA103	F1		SAD027	H3	ESS525	J1
				ATS17	F2		SAC063	H2		
				SPA171	F1		SAC057	H2	ESS0089A	J1
							SAG137	H1		
				SPA171	F1		SAD027	H3		
							SAG020	H1		
							SAG020	H1		
						SAA103			BAE608G	
									ESS532	J1
									ESS532	J1



KW



TYPE



TYPE

OPEL

ASTRA G Station wagon (F35_)

1.6 16V	Petrol	74	02/98 → 07/04					B3215	B1
1.6 16V	Petrol	74	02/98 → 07/04					PAS001	B5
1.6 16V	Petrol	74	02/98 → 07/04					SVF013	B6
1.6 16V	Petrol	74	02/98 → 08/00						
1.6 16V	Petrol	74	02/98 → 07/04	ENGINE: C16SEL-X16XEL-Z16XE					
1.6 16V	Petrol	74	03/00 → 07/04	ENGINE: Z16XEP					
1.6 16V	Petrol	74	02/98 → 06/04						
1.6 CNG	Petrol/CNG	71	03/03 → 07/04					PAS001	B5
1.6 CNG	Petrol/CNG	71	03/03 → 07/04						
1.6 CNG	Petrol/CNG	71	03/03 → 07/04						
1.6 CNG	Petrol/CNG	71	03/03 → 07/04	ENGINE: Z16YNG					
1.7 CDTI	Diesel	59	04/03 → 07/09					PAS001	B5
1.7 CDTI	Diesel	59	04/03 → 07/09						
1.7 CDTI	Diesel	59	04/03 → 07/09	ENGINE: Z17DTL					
1.7 DTI 16V	Diesel	55	02/00 → 07/04					PAS006	B5
1.7 TD	Diesel	50	02/98 → 08/00					PAS006	B5
1.8 16V	Petrol	92	09/00 → 07/04					PAS001	B5
1.8 16V	Petrol	85	02/98 → 09/00						
1.8 16V	Petrol	85	02/98 → 09/00						
1.8 16V	Petrol	85	02/98 → 09/00						
1.8 16V	Petrol	92	09/00 → 07/04						
1.8 16V	Petrol	92	09/00 → 07/04						
1.8 16V	Petrol	85	02/98 → 08/00						
1.8 16V	Petrol	92	09/00 → 06/04						
2.0 16V	Petrol	100	02/98 → 07/04					B3397	B1
2.0 16V	Petrol	100	02/98 → 06/04					SVF016	B6
2.0 16V	Petrol	100	02/98 → 06/04						
2.0 DI	Diesel	60	02/98 → 07/04					PAS006	B5
2.0 DI	Diesel	60	02/98 → 08/00						
2.0 DI	Diesel	60	02/98 → 07/04	CHASSIS: → 38999999					
2.0 DI	Diesel	60	02/98 → 07/04	CHASSIS: → 38999999					
2.0 DTI 16V	Diesel	74	08/99 → 07/04					PAS001	B5
2.0 DTI 16V	Diesel	74	08/99 → 07/04	CHASSIS: 12000001 → 2H999999					
2.0 DTI 16V	Diesel	74	09/00 → 06/04						
2.0 DTI 16V	Diesel	74	08/99 → 07/04	CHASSIS: → 38999999					
2.0 DTI 16V	Diesel	74	08/99 → 07/04	CHASSIS: → 38999999					
2.0 OPC	Petrol	141	09/02 → 07/04					PAS001	B5
2.0 OPC	Petrol	141	09/02 → 07/04						
2.0 OPC	Petrol	141	09/02 → 06/04						
2.0 OPC	Petrol	147	11/02 → 07/04						
2.0 OPC	Petrol	147	11/02 → 06/04						
2.0 OPC	Petrol	147	11/02 → 07/04						



TYPE



TYPE



TYPE

	APS45		ATS17	F2		SAC080	H2	BAE608H		
			SPA171	F1		SAD027	H3			
						SAG020	H1			
			SPA103	F1						
								BAE608F		
								BAE608L		
									ESS532	J1
			ATS17	F2		SAC080	H2			
			SPA171	F1		SAD027	H3			
						SAG020	H1			
								BAE608F		
	APS43		SPA171	F1		SAC094	H2			
						SAG174	H1			
	APS53									
						SAG117	H1			
			SPA128	F1		SAG060	H1			
						SAC071	H2			
						SAC071	H2			
						SAD015	H3			
						SAG116	H1			
						SAD015	H3			
						SAG120	H1			
									ESS532	J1
									ESS532	J1
			ATS12	F2		SAC032	H2			
									ESS532	J1
			SPA171	F1						
			SPA103	F1						
						SAG021	H1			
						SAG021-1	H1			
			SPA171	F1						
	APS26									
			SPA103	F1						
						SAG021	H1			
						SAG021-1	H1			
			ATS10	F2		SAC035	H2			
			SPA171	F1		SAG057	H1			
			SPA103	F1				BAE680BL		
			ATS10	F2		SAC035	H2			
			SPA103	F1				BAE680BL		
						SAG057	H1			



KW

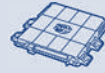

TYPE



TYPE

OPEL

ASTRA G Station wagon (F35_)

2.2 16V	Petrol	108	03/01 → 07/04			PAS001	B5
2.2 16V	Petrol	108	03/01 → 07/04	ENGINE: Z22SE			
2.2 DTI	Diesel	92	09/02 → 07/04			PAS006	B5
2.2 DTI	Diesel	92	09/02 → 06/04				
2.2 DTI	Diesel	92	09/02 → 06/04				
2.2 DTI	Diesel	92	09/02 → 07/04	CHASSIS: → 38999999			
2.2 DTI	Diesel	92	09/02 → 07/04	CHASSIS: → 38999999			

ASTRA G Tre volumi (F69_)

1.2 16V	Petrol	48	09/98 → 09/00			SVF016	B6
1.2 16V	Petrol	55	09/00 → 01/05			PAS001	B5
1.2 16V	Petrol	55	09/00 → 09/03				
1.2 16V	Petrol	55	09/00 → 09/03				
1.4	Petrol	66	09/07 → 12/09			PAS001	B5
1.4	Petrol	66	09/07 → 01/09				
1.4	Petrol	66	09/07 → 06/09				
1.4 16V	Petrol	66	09/98 → 01/05			B3215	B1
1.4 16V	Petrol	66	09/98 → 01/05			PAS001	B5
1.4 16V	Petrol	66	09/98 → 01/05			SVF013	B6
1.4 16V	Petrol	66	09/98 → 09/00				
1.4 16V	Petrol	66	09/98 → 01/05	ENGINE: X14XE-Z14XE			
1.4 16V	Petrol	66	09/98 → 01/04				
1.4 16V	Petrol	66	09/98 → 09/00	ENGINE: X14XE			
1.6	Petrol	55	09/98 → 09/00			SVF014	B6
1.6	Petrol	62	09/00 → 01/05			PAS001	B5
1.6	Petrol	76	12/02 → 12/09			PAS001	B5
1.6	Petrol	55	09/98 → 09/00				
1.6	Petrol	62	09/00 → 01/05				
1.6	Petrol	62	09/00 → 01/05				
1.6	Petrol	76	12/02 → 12/09				
1.6	Petrol	76	12/02 → 12/09	ENGINE: 20EL9416 →			
1.6	Petrol	62	09/00 → 01/05	ENGINE: Z16SE			
1.6	Petrol	55	09/98 → 08/00				
1.6	Petrol	62	09/00 → 01/04				
1.6	Petrol	76	02/03 → 01/04				
1.6 16V	Petrol	74	09/98 → 01/05			B3215	B1
1.6 16V	Petrol	74	09/98 → 01/05			PAS001	B5
1.6 16V	Petrol	74	09/98 → 01/05			SVF013	B6
1.6 16V	Petrol	74	09/98 → 08/00				
1.6 16V	Petrol	74	09/98 → 01/05	ENGINE: C16SEL-X16XEL-Z16XE			
1.6 16V	Petrol	74	09/98 → 01/05	ENGINE: Z16XEP			
1.6 16V	Petrol	74	09/98 → 01/04				
1.7 CDTI	Diesel	59	04/03 → 12/09			PAS001	B5
1.7 CDTI	Diesel	59	04/03 → 12/09				



TYPE

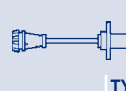

TYPE



TYPE

	APS44		SPA115	F1		SAG083	H1			
								BAE608N		
			SPA171	F1						
			ATS20	F2						
			SPA103	F1						
						SAG021	H1			
						SAG021-1	H1			
			SPA103	F1	SAA103	SAG019	H1	BAE680AJ	ESS532	J1
			SPA171	F1	SAA103					
			SPA103	F1		SAG019	H1	BAE680AJ		
									ESS532	J1
FEI0004			SPA171	F1		SAC092	H2			
					SAA103					
								BAE680AL		
	APS45		ATS17	F2	SAA103	SAC080	H2	BAE608H		
			SPA171	F1		SAD027	H3			
						SAG020	H1			
			SPA103	F1						
								BAE608F		
									ESS532	J1
									ESS530	J1
	APS45		SPA103	F1		SAD027	H3			
			ATS17	F2		SAC063	H2			
			SPA171	F1		SAC057	H2			
						SAG137	H1			
			SPA171	F1		SAD027	H3			
						SAG020	H1			
						SAG020	H1			
					SAA103					
								BAE608G		
									ESS525	J1
									ESS532	J1
									ESS532	J1
	APS45		ATS17	F2		SAC080	H2	BAE608H		
			SPA171	F1		SAD027	H3			
						SAG020	H1			
			SPA103	F1						
								BAE608F		
								BAE608L		
									ESS532	J1
	APS43		SPA171	F1		SAC094	H2			
						SAG174	H1			



KW



TYPE



TYPE

OPEL

ASTRA G Tre volumi (F69_)

1.7 CDTI	Diesel	59	04/03 → 01/04	ENGINE: Z17DTL				
1.7 DTI 16V	Diesel	55	02/00 → 01/05				PAS006	B5
1.7 TD	Diesel	50	09/98 → 08/00				PAS006	B5
1.8 16V	Petrol	92	06/00 → 01/05				PAS001	B5
1.8 16V	Petrol	85	09/98 → 09/00					
1.8 16V	Petrol	85	09/98 → 09/00					
1.8 16V	Petrol	85	09/98 → 09/00					
1.8 16V	Petrol	92	06/00 → 01/05					
1.8 16V	Petrol	92	06/00 → 01/05					
1.8 16V	Petrol	85	09/98 → 08/00					
1.8 16V	Petrol	92	06/00 → 01/04					
2.0 16V	Petrol	100	09/98 → 01/05				B3397	B1
2.0 16V	Petrol	100	09/98 → 01/04				SVF016	B6
2.0 16V	Petrol	100	09/98 → 01/04					
2.0 DI	Diesel	60	09/98 → 01/05				PAS006	B5
2.0 DI	Diesel	60	09/98 → 08/00					
2.0 DI	Diesel	60	09/98 → 01/05	CHASSIS: → 38999999				
2.0 DI	Diesel	60	09/98 → 01/05	CHASSIS: → 38999999				
2.0 DTI 16V	Diesel	74	08/99 → 01/05				PAS001	B5
2.0 DTI 16V	Diesel	74	08/99 → 01/05	CHASSIS: 12000001 → 2H999999				
2.0 DTI 16V	Diesel	74	09/00 → 01/04					
2.0 DTI 16V	Diesel	74	08/99 → 01/05	CHASSIS: → 38999999				
2.0 DTI 16V	Diesel	74	08/99 → 01/05	CHASSIS: → 38999999				
2.2 16V	Petrol	108	03/01 → 01/05				PAS001	B5
2.2 16V	Petrol	108	03/01 → 01/05	ENGINE: Z22SE				
2.2 DTI	Diesel	92	09/02 → 01/05				PAS006	B5
2.2 DTI	Diesel	92	09/02 → 01/04					
2.2 DTI	Diesel	92	09/02 → 01/04					
2.2 DTI	Diesel	92	09/02 → 01/05	CHASSIS: → 38999999				
2.2 DTI	Diesel	92	09/02 → 01/05	CHASSIS: → 38999999				

ASTRA GTC J

1.4	Petrol	74	10/11 →					
1.4	Petrol	103	10/11 →					
1.4	Petrol	88	10/11 →					
1.6	Petrol	132	10/11 →					
1.8	Petrol	103	10/11 →					
2.0 CDTi	Diesel	121	10/11 →					

ASTRA H (L48)

1.2	Petrol	48	10/06 →				PAS001	B5
1.2	Petrol	59	08/05 →				PAS001	B5
1.2	Petrol	59	03/07 → 03/09					
1.2	Petrol	59	02/07 → 03/09					
1.3 CDTi	Diesel	66	08/05 →				PAS001	B5

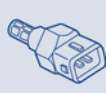
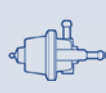

TYPE

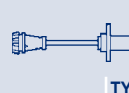

TYPE



TYPE

APS53										
								SAG117	H1	
			SPA128	F1				SAG060	H1	
								SAC071	H2	
								SAC071	H2	
								SAD015	H3	
								SAG116	H1	
								SAD015	H3	
								SAG120	H1	
										ESS532 J1
										ESS532 J1
			ATS12	F2				SAC032	H2	
										ESS532 J1
			SPA171	F1						
			SPA103	F1						
								SAG021	H1	
								SAG021-1	H1	
			SPA171	F1						
APS26										
			SPA103	F1						
								SAG021	H1	
								SAG021-1	H1	
APS44										
			SPA115	F1						BAE608N
			SPA171	F1						
			ATS20	F2						
			SPA103	F1						
								SAG021	H1	
								SAG021-1	H1	
FEI0004										
								SAA103		
								SAA103		
								SAA103		
								SAA103	SAC092	H2
										BAE680CS
										BAE680CS
APS49										
			SPA171	F1						
			SPA171	F1	SAA103			SAC092	H2	
										BAE680AL
										SUA548 J2
			ATS20	F2				SAC093	H2	GA2180 J2



KW



TYPE



TYPE

OPEL

ASTRA H (L48)

1.3 CDTI	Diesel	66	08/05 →	ENGINE: Z13DTH		40CDSF1	B3
1.3 CDTI	Diesel	66	08/05 →				
1.4	Petrol	55	04/04 → 10/04			PAS001	B5
1.4	Petrol	59	04/04 → 10/04			PAS001	B5
1.4	Petrol	66	03/04 →			PAS001	B5
1.4	Petrol	66	03/04 →				
1.4	Petrol	66	03/04 →				
1.4	Petrol	55	09/04 → 10/04				
1.4	Petrol	59	09/04 → 10/04				
1.4	Petrol	66	03/04 → 03/10				
1.4 LPG	Petrol/LPG	66	08/09 →			PAS001	B5
1.4 LPG	Petrol/LPG	66	08/09 → 12/09				
1.4 LPG	Petrol/LPG	66	08/09 → 03/10				
1.6	Petrol	77	03/04 →			PAS001	B5
1.6	Petrol	85	12/06 →			PAS001	B5
1.6	Petrol	77	03/04 →				
1.6	Petrol	77	03/04 →	ENGINE: 20EL5306 →			
1.6	Petrol	85	12/06 →				
1.6	Petrol	77	03/04 →	ENGINE: Z16XEP			
1.6	Petrol	77	03/04 → 03/07				
1.6 Turbo	Petrol	132	02/07 →			PAS001	B5
1.7 CDTI	Diesel	59	03/04 →			PAS001	B5
1.7 CDTI	Diesel	74	03/04 →			PAS001	B5
1.7 CDTI	Diesel	81	02/07 →			PAS001	B5
1.7 CDTI	Diesel	81	02/07 →			TB0002	B3
1.7 CDTI	Diesel	92	02/07 →			PAS001	B5
1.7 CDTI	Diesel	92	02/07 →			TB0002	B3
1.7 CDTI	Diesel	59	03/04 → 09/05	ENGINE: Z17DTL			
1.7 CDTI	Diesel	74	03/04 →				
1.7 CDTI	Diesel	74	03/04 → 08/07	ENGINE: Z17DTH			
1.8	Petrol	103	01/06 →			PAS001	B5
1.8	Petrol	103	01/06 →			TB0012	B3
1.8	Petrol	92	03/04 →			PAS001	B5
1.8	Petrol	92	03/04 →			TB0012	B3
1.8	Petrol	92	03/04 →				
1.8	Petrol	92	03/04 → 02/09				
1.9 CDTI	Diesel	110	09/04 →			48CPD4	B3
1.9 CDTI	Diesel	110	09/04 →	ENGINE: Z19DTH		CAD191	B2
1.9 CDTI	Diesel	110	09/04 →			PAS001	B5
1.9 CDTI	Diesel	74	09/05 →			PAS001	B5
1.9 CDTI	Diesel	74	09/05 →	ENGINE: Z19DTL		48CPD1	B3
1.9 CDTI	Diesel	88	06/04 →			PAS001	B5
1.9 CDTI	Diesel	88	06/04 →	ENGINE: Z19DT		48CPD1	B3
1.9 CDTI 16V	Diesel	88	04/04 →			PAS001	B5

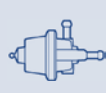

TYPE

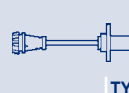

TYPE



TYPE

						SAG025	H1		
FEI0004				SAA103					
		SPA171	F1						
FEI0004		SPA103	F1	SAA103	SAC092	H2		ESS0028A	J1
					SAD026	H3		SUA548	J2
					SAG019	H1			
								BAE680AL	
								BAE680AL	
								BAE680AL	
FEI0004					SAC092	H2			
				SAA103					
								BAE680AL	
	APS44	SPA171	F1		SAC057	H2		ESS0028A	J1
				SAA103	SAC062	H2		ESS0028A	J1
					SAG020	H1			
				SAA103					
								SUA548	J2
								BAE608L	
								SUA548	J2
				SAA103	SAC092	H2			
APS43		SPA171	F1		SAC094	H2			
APS43		SPA171	F1		SAC094	H2			
		SPA171	F1						
		SPA171	F1						
	APS53								
					SAG174	H1			
	APS53								
				SAA103	SAC062	H2		ESS0028A	J1
					SAD033	H3		SUA548	J2
					SAC071	H2		ESS0028A	J1
					SAD007	H3		GA2148	J2
					SAG120	H1			
								SUA548	J2
		ATS20	F2		SAC068	H2		GA2195	J2
					SAG133	H1			
					SAC088	H2		GA2195	J2
		ATS20	F2					GA2180	J2
		ATS20	F2		SAC068	H2		GA2180	J2



KW

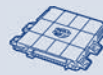

TYPE



TYPE

OPEL

ASTRA H (L48)

1.9 CDTI 16V	Diesel	88	04/04 →						
2.0 Turbo	Petrol	125	03/04 →				PAS001	B5	
2.0 Turbo	Petrol	147	09/04 →				PAS001	B5	
2.0 Turbo	Petrol	177	03/05 →				PAS001	B5	
2.0 Turbo	Petrol	125	03/04 →						
2.0 Turbo	Petrol	147	09/04 →						
2.0 Turbo	Petrol	177	03/05 →						
2.0 Turbo	Petrol	177	09/05 →						
2.0 Turbo	Petrol	125	03/04 → 02/09						
2.0 Turbo	Petrol	147	09/04 → 03/10						
2.0 Turbo	Petrol	177	09/05 → 03/10						
2.0 Turbo	Petrol	125	03/04 → 02/09						

ASTRA H GTC (L08)

1.2	Petrol	48	10/06 →				PAS001	B5	
1.2	Petrol	59	08/05 →				PAS001	B5	
1.2	Petrol	59	03/07 → 03/09						
1.2	Petrol	59	02/07 → 03/09						
1.3 CDTI	Diesel	66	04/05 →				PAS001	B5	
1.3 CDTI	Diesel	66	04/05 →	ENGINE: Z13DTH			40CDSF1	B3	
1.3 CDTI	Diesel	66	04/05 →						
1.4	Petrol	55	03/05 →				PAS001	B5	
1.4	Petrol	66	03/05 →				PAS001	B5	
1.4	Petrol	66	03/05 →						
1.4	Petrol	66	03/05 →						
1.4	Petrol	55	09/05 → 02/09						
1.4	Petrol	66	03/05 → 03/09						
1.4	Petrol	66	03/05 →	CHASSIS: → 65125614					
1.6	Petrol	77	03/05 →				PAS001	B5	
1.6	Petrol	85	12/06 →				PAS001	B5	
1.6	Petrol	77	03/05 →						
1.6	Petrol	77	03/05 →	ENGINE: 20EL5306 →					
1.6	Petrol	77	03/05 →	ENGINE: Z16XEP					
1.6	Petrol	77	03/05 → 03/08	CHASSIS: → 65125614					
1.6	Petrol	85	12/06 →	CHASSIS: → 65125614					
1.6 Turbo	Petrol	132	02/07 →				PAS001	B5	
1.7 CDTI	Diesel	59	03/05 →				PAS001	B5	
1.7 CDTI	Diesel	74	03/05 →				PAS001	B5	
1.7 CDTI	Diesel	81	02/07 →				PAS001	B5	
1.7 CDTI	Diesel	81	02/07 →				TB0002	B3	
1.7 CDTI	Diesel	92	02/07 →				PAS001	B5	
1.7 CDTI	Diesel	92	02/07 →				TB0002	B3	
1.7 CDTI	Diesel	59	03/05 → 03/07	ENGINE: Z17DTL					
1.7 CDTI	Diesel	74	03/05 →						
1.7 CDTI	Diesel	74	09/05 → 05/07	ENGINE: Z17DTH					



TYPE

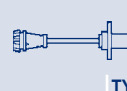

TYPE



TYPE

						SAG133	H1		
			ATS10	F2		SAC035	H2	GA2092	J2
			ATS10	F2		SAC035	H2	GA2092	J2
			ATS10	F2		SAC035	H2		
			SPA103	F1		SAG057	H1		
			SPA103	F1		SAG057	H1		
			SPA171	F1		SAG057	H1		
			SPA103	F1					
								BAE680BL	
								BAE680BL	
								BAE680BL	
								SUA549	J2
			SPA171	F1					
			SPA171	F1	SAA103	SAC092	H2		
								BAE680AL	
								SUA548	J2
			ATS20	F2		SAC093	H2	GA2180	J2
						SAG025	H1		
FEI0004						SAA103			
FEI0004			SPA103	F1	SAA103	SAC092	H2	ESS0028A	J1
						SAD026	H3		
						SAG019	H1		
								BAE680AL	
								BAE680AL	
								SUA548	J2
			SPA171	F1		SAC057	H2	ESS0028A	J1
					SAA103	SAC062	H2	ESS0028A	J1
						SAG020	H1	GA2148	J2
					SAA103				
								BAE608L	
								SUA548	J2
								SUA548	J2
					SAA103	SAC092	H2		
			SPA171	F1					
APS43			SPA171	F1		SAC094	H2		
			SPA171	F1					
			SPA171	F1					
			SPA171	F1					
APS53									
						SAG174	H1		
APS53									



KW

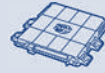

TYPE



TYPE

OPEL

ASTRA H GTC (L08)

1.8	Petrol	103	01/06 →			PAS001	B5
1.8	Petrol	103	01/06 →			TB0012	B3
1.8	Petrol	92	03/05 →			PAS001	B5
1.8	Petrol	92	03/05 →			TB0012	B3
1.8	Petrol	92	03/05 →				
1.8	Petrol	92	03/05 → 03/08				
1.9 CDTI	Diesel	110	03/05 →			PAS001	B5
1.9 CDTI	Diesel	74	01/06 →			PAS001	B5
1.9 CDTI	Diesel	88	09/05 →			PAS001	B5
1.9 CDTI	Diesel	110	03/05 →				
1.9 CDTI 16V	Diesel	88	03/05 →			PAS001	B5
1.9 CDTI 16V	Diesel	88	03/05 →				
2.0 Turbo	Petrol	125	03/05 →			PAS001	B5
2.0 Turbo	Petrol	147	03/05 →			PAS001	B5
2.0 Turbo	Petrol	177	08/05 →			PAS001	B5
2.0 Turbo	Petrol	125	03/05 →				
2.0 Turbo	Petrol	147	03/05 →				
2.0 Turbo	Petrol	177	08/05 →				
2.0 Turbo	Petrol	125	03/05 → 02/09				
2.0 Turbo	Petrol	147	03/05 → 09/09				
2.0 Turbo	Petrol	177	08/05 → 03/09				
2.0 Turbo	Petrol	125	03/05 → 02/09				

ASTRA H Station wagon (L35)

1.3 CDTI	Diesel	66	08/05 →			PAS001	B5
1.3 CDTI	Diesel	66	08/05 →	ENGINE: Z13DTH		40CDSF1	B3
1.3 CDTI	Diesel	66	08/05 →				
1.4	Petrol	55	08/04 →			PAS001	B5
1.4	Petrol	66	08/04 →			PAS001	B5
1.4	Petrol	66	08/04 →				
1.4	Petrol	66	08/04 →				
1.4	Petrol	55	09/04 → 09/05				
1.4	Petrol	66	08/04 → 03/10				
1.6	Petrol	77	08/04 →			PAS001	B5
1.6	Petrol	85	12/06 →			PAS001	B5
1.6	Petrol	77	08/04 →				
1.6	Petrol	77	08/04 →	ENGINE: 20EL5306 →			
1.6	Petrol	77	08/04 →	ENGINE: Z16XEP			
1.6	Petrol	77	08/04 → 03/07				
1.6	Petrol	85	02/07 →				
1.6 Turbo	Petrol	132	02/07 →			PAS001	B5
1.7 CDTI	Diesel	59	08/04 →			PAS001	B5
1.7 CDTI	Diesel	74	08/04 →			PAS001	B5
1.7 CDTI	Diesel	81	02/07 →			PAS001	B5
1.7 CDTI	Diesel	81	02/07 →			TB0002	B3



TYPE

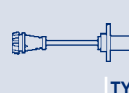

TYPE



TYPE

					SAA103	SAC062	H2	SUA548	J2	
						SAD033	H3			
						SAC071	H2			
						SAD007	H3			
						SAG120	H1			
								SUA548	J2	
				ATS10	F2	SAC068	H2	GA2195	J2	
						SAC088	H2	GA2195	J2	
				ATS20	F2			GA2195	J2	
						SAG133	H1			
				ATS10	F2	SAC068	H2	GA2195	J2	
						SAG133	H1			
				ATS10	F2	SAC035	H2	GA2092	J2	
				ATS10	F2	SAC035	H2	GA2092	J2	
				SPA171	F1	SAC035	H2	GA2055	J2	
				SPA103	F1	SAG057	H1			
				SPA103	F1	SAG057	H1			
						SAG057	H1			
								BAE680BL		
								BAE680BL		
								BAE680BL		
								SUA549	J2	
				ATS20	F2	SAC093	H2	GA2180	J2	
						SAG025	H1			
FEI0004						SAA103				
FEI0004				SPA103	F1	SAA103	SAC092	H2	ESS0028A	J1
							SAD026	H3	GA2148	J2
							SAG019	H1		
								BAE680AL		
								BAE680AL		
	APS44			SPA171	F1	SAC057	H2	ESS0028A	J1	
						SAA103	SAC062	H2	ESS0028A	J1
							SAG020	H1		
						SAA103				
								BAE608L		
								SUA548	J2	
								SUA548	J2	
						SAA103	SAC092	H2		
	APS43			SPA171	F1	SAC094	H2			
	APS43			SPA171	F1	SAC094	H2			
				SPA171	F1					



KW



TYPE



TYPE

OPEL

ASTRA H Station wagon (L35)

1.7 CDTI	Diesel	92	02/07 →				PAS001	B5
1.7 CDTI	Diesel	92	02/07 →				TB0002	B3
1.7 CDTI	Diesel	59	08/04 → 09/05	ENGINE: Z17DTL				
1.7 CDTI	Diesel	74	08/04 → 03/07	ENGINE: Z17DTH				
1.8	Petrol	103	08/05 →				PAS001	B5
1.8	Petrol	92	08/04 →				PAS001	B5
1.8	Petrol	92	08/04 →				TB0012	B3
1.8	Petrol	103	10/05 →					
1.8	Petrol	103	08/05 →					
1.8	Petrol	92	08/04 →					
1.8	Petrol	92	08/04 → 02/09					
1.9 CDTI	Diesel	103	12/04 →				PAS001	B5
1.9 CDTI	Diesel	110	09/04 →				PAS001	B5
1.9 CDTI	Diesel	110	09/04 →	ENGINE: Z19DTH			CAD191	B2
1.9 CDTI	Diesel	74	09/05 →				PAS001	B5
1.9 CDTI	Diesel	88	09/05 →				PAS001	B5
1.9 CDTI	Diesel	110	09/04 →					
1.9 CDTI 16V	Diesel	88	08/04 →				PAS001	B5
1.9 CDTI 16V	Diesel	88	08/04 →					
2.0 Turbo	Petrol	125	08/04 →				PAS001	B5
2.0 Turbo	Petrol	147	09/04 →				PAS001	B5
2.0 Turbo	Petrol	125	08/04 →					
2.0 Turbo	Petrol	147	09/04 →					
2.0 Turbo	Petrol	125	08/04 → 02/09					
2.0 Turbo	Petrol	147	09/04 → 03/10					
2.0 Turbo	Petrol	125	08/04 → 02/09					

ASTRA H Tre volumi (L69)

1.3 CDTI	Diesel	66	02/07 →				PAS001	B5
1.3 CDTI	Diesel	66	02/07 →	ENGINE: Z13DTH			40CDSF1	B3
1.6	Petrol	85	02/07 →				PAS001	B5
1.7 CDTI	Diesel	74	02/07 →				PAS001	B5
1.7 CDTI	Diesel	81	02/07 →				PAS001	B5
1.8	Petrol	103	02/07 →				PAS001	B5

ASTRA H TwinTop (L67)

1.6	Petrol	77	09/05 →				PAS001	B5
1.6	Petrol	85	12/06 →				PAS001	B5
1.6	Petrol	77	09/05 →					
1.6	Petrol	77	09/05 →	ENGINE: 20EL5306 →				
1.6	Petrol	85	12/06 →					
1.6	Petrol	77	09/05 →	ENGINE: Z16XEP				
1.6	Petrol	77	09/05 → 03/08	CHASSIS: → 65125614				
1.6 Turbo	Petrol	132	02/07 →				PAS001	B5
1.8	Petrol	103	09/05 →				PAS001	B5
1.8	Petrol	92	09/05 →				PAS001	B5

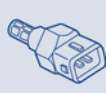
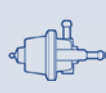

TYPE

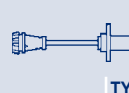

TYPE



TYPE

				SPA171	F1							
				APS53								
				APS53								
								SAC062	H2	ESS0028A	J1	
								SAC071	H2	ESS0028A	J1	
								SAD007	H3			
								SAA103				
										SUA548	J2	
								SAG120	H1			
										SUA548	J2	
				ATS20	F2			SAC068	H2	GA2195	J2	
								SAC088	H2	GA2195	J2	
				ATS20	F2					GA2180	J2	
								SAG133	H1			
				ATS20	F2			SAC068	H2	GA2180	J2	
								SAG133	H1			
				ATS10	F2			SAC035	H2	GA2092	J2	
				ATS10	F2			SAC035	H2	GA2092	J2	
				SPA103	F1			SAG057	H1			
				SPA103	F1			SAG057	H1			
										BAE680BL		
										BAE680BL		
										SUA549	J2	
										SUA548	J2	
				SPA171	F1							
				SPA171	F1							
										SUA548	J2	
				SPA171	F1			SAC057	H2	ESS0028A	J1	
								SAA103	SAC062	H2	ESS0028A	J1
								SAG020	H1			
								SAA103				
										GA2148	J2	
										BAE608L		
										SUA548	J2	
								SAA103	SAC092	H2		
								SAA103	SAC062	H2	SUA548	J2
									SAC071	H2	ESS0028A	J1



KW



TYPE



TYPE

OPEL

ASTRA H TwinTop (L67)

1.8	Petrol	92	09/05 →				TB0012	B3
1.8	Petrol	103	09/05 →					
1.8	Petrol	92	09/05 →					
1.8	Petrol	92	09/05 → 03/08					
1.9 CDTI	Diesel	110	09/05 →				PAS001	B5
1.9 CDTI	Diesel	110	09/05 →	ENGINE: Z19DTH			CAD191	B2
1.9 CDTI	Diesel	110	09/05 →					
2.0 Turbo	Petrol	125	09/05 →				PAS001	B5
2.0 Turbo	Petrol	147	09/05 →				PAS001	B5
2.0 Turbo	Petrol	125	09/05 →					
2.0 Turbo	Petrol	147	09/05 →					
2.0 Turbo	Petrol	125	09/05 → 02/09					
2.0 Turbo	Petrol	147	09/05 → 10/10					
2.0 Turbo	Petrol	125	09/05 → 02/09					

ASTRA H Van (L70)

1.3 CDTI	Diesel	66	08/05 →				PAS001	B5
1.3 CDTI	Diesel	66	08/05 →	ENGINE: Z13DTH			40CDSF1	B3
1.7 CDTI	Diesel	74	03/04 →				PAS001	B5
1.7 CDTI	Diesel	81	02/07 →				PAS001	B5
1.7 CDTI	Diesel	81	02/07 →				TB0002	B3
1.7 CDTI	Diesel	92	02/07 →				PAS001	B5
1.7 CDTI	Diesel	92	02/07 →				TB0002	B3
1.7 CDTI	Diesel	74	08/04 → 03/07	ENGINE: Z17DTH				
1.9 CDTI	Diesel	110	09/04 →				PAS001	B5
1.9 CDTI	Diesel	110	09/04 →	ENGINE: Z19DTH			CAD191	B2
1.9 CDTI	Diesel	88	09/05 →				PAS001	B5
1.9 CDTI 16V	Diesel	88	08/04 →				PAS001	B5

ASTRA J

1.3 CDTI	Diesel	70	12/09 →					
1.4	Petrol	64	12/09 →					
1.4	Petrol	74	12/09 →					
1.4 LPG	Petrol/LPG	103	01/12 →					
1.4 Turbo	Petrol	103	12/09 →					
1.4 Turbo	Petrol	88	10/10 →					
1.6	Petrol	85	12/09 →					
1.6 Turbo	Petrol	132	12/09 →					
1.7 CDTI	Diesel	81	12/09 →				TB0002	B3
1.7 CDTI	Diesel	92	12/09 →				TB0002	B3
2.0 CDTi	Diesel	118	12/09 →					
2.0 CDTi	Diesel	121	06/11 →					

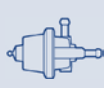

TYPE

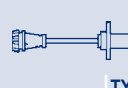

TYPE



TYPE

						SAD007	H3				
						SAD033	H3				
						SAG120	H1				
										SUA548	J2
			ATS10	F2		SAC068	H2			GA2195	J2
						SAG133	H1				
			ATS10	F2		SAC035	H2			GA2055	J2
			ATS10	F2		SAC035	H2			GA2055	J2
			SPA103	F1		SAG057	H1				
			SPA103	F1		SAG057	H1				
										BAE680BL	
										BAE680BL	
										SUA549	J2
						SAG174	H1				
			APS53								
			APS49		SPA146	F1					
			FEI0004				SAA103				
			FEI0004				SAA103				
							SAA103				
							SAA103				
							SAA103				
							SAA103			BAE680CS	
							SAA103	SAC092	H2	BAE680CS	
						SPA171	F1				
						SPA171	F1				
			APS49		SPA171	F1					
			APS49								



KW

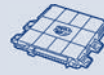

TYPE



TYPE

OPEL

ASTRA J Sports Tourer

1.3 CDTi	Diesel	70	10/10 →					
1.4	Petrol	74	10/10 →					
1.4 LPG	Petrol/LPG	103	01/12 →					
1.4 Turbo	Petrol	103	10/10 →					
1.4 Turbo	Petrol	88	10/10 →					
1.6	Petrol	85	10/10 →					
1.6 Turbo	Petrol	132	10/10 →					
2.0 CDTi	Diesel	118	10/10 →					
2.0 CDTi	Diesel	121	08/11 →					

ASTRA J Tre volumi

1.6	Petrol	85	06/12 →					
1.6 Turbo	Petrol	132	06/12 →					

CALIBRA A (85_)

2.0 i	Petrol	85	06/90 → 03/97				SVF015	B6
2.0 i	Petrol	85	06/90 → 07/97					
2.0 i	Petrol	85	06/90 → 07/97					
2.0 i	Petrol	85	06/90 → 03/97					
2.0 i 16V	Petrol	100	02/94 → 08/96				SVF015	B6
2.0 i 16V	Petrol	100	09/96 → 07/97				B3397	B1
2.0 i 16V	Petrol	100	02/94 → 07/97					
2.0 i 16V	Petrol	100	02/94 → 07/97					
2.0 i 16V	Petrol	100	02/94 → 07/97					
2.0 i 16V	Petrol	110	06/90 → 02/94					
2.0 i 16V	Petrol	110	06/90 → 02/94					
2.0 i 16V	Petrol	100	02/94 → 07/97	ENGINE: 14142429 →				
2.0 i 16V	Petrol	100	02/94 → 08/96					
2.0 i 16V 4x4	Petrol	100	02/94 → 08/96				SVF015	B6
2.0 i 16V 4x4	Petrol	100	09/96 → 07/97				B3397	B1
2.0 i 16V 4x4	Petrol	100	02/94 → 07/97					
2.0 i 16V 4x4	Petrol	100	02/94 → 07/97					
2.0 i 16V 4x4	Petrol	100	02/94 → 07/97					
2.0 i 16V 4x4	Petrol	110	06/90 → 02/94					
2.0 i 16V 4x4	Petrol	110	06/90 → 02/94					
2.0 i 16V 4x4	Petrol	100	02/94 → 07/97	ENGINE: 14142429 →				
2.0 i 16V 4x4	Petrol	100	02/94 → 08/96					
2.0 i 4x4	Petrol	85	06/90 → 03/97				SVF015	B6
2.0 i 4x4	Petrol	85	06/90 → 07/97					
2.0 i 4x4	Petrol	85	06/90 → 07/97					
2.0 i 4x4	Petrol	85	06/90 → 03/97					
2.0 i Turbo 4x4	Petrol	150	03/92 → 03/97				SVF015	B6
2.0 i Turbo 4x4	Petrol	150	03/92 → 07/97					
2.0 i Turbo 4x4	Petrol	150	03/92 → 07/97					
2.0 i Turbo 4x4	Petrol	150	03/92 → 03/97					
2.5 i V6	Petrol	125	04/93 → 07/97					

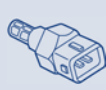
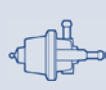

TYPE

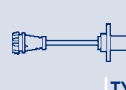

TYPE



TYPE

	APS49		SPA146	F1					
FEI0004					SAA103				
					SAA103				
					SAA103				
					SAA103				
					SAA103			BAE680CS	
					SAA103	SAC092	H2	BAE680CS	
	APS49								
	APS49								
								BAE680CS	
						SAC092	H2	BAE680CS	
			SPA104	F1		SAG093	H1		PI024
			SSA042	F2					
									ESS530
			ATS12	F2		SAC046	H2		PI024
			SPA104	F1		SAD012	H3		
			SSA042	F2					
			SPA104	F1		SAG093	H1		ESS530
			SSA042	F2					PI024
						SAG107	H1		
									ESS530
			ATS12	F2		SAC046	H2		PI024
			SPA104	F1		SAD012	H3		
			SSA042	F2					
			SPA104	F1		SAG093	H1		ESS530
			SSA042	F2					PI024
						SAG107	H1		
									ESS530
			SPA104	F1		SAG093	H1		PI024
			SSA042	F2					
									ESS530
			SPA104	F1		SAG093	H1		PI024
			SSA042	F2					
									ESS530
			SPA104	F1					PI024



KW



TYPE



TYPE

OPEL

CALIBRA A (85_)

2.5 i V6	Petrol	125	04/93 → 07/97	CHASSIS: S1035179 →, R9003233 →				
2.5 i V6	Petrol	125	04/93 → 03/97					

CAMPO (TF_)

2.5 TD (TFR54)	Diesel	56	07/94 →					
2.5 TD 4x4 (TFS54)	Diesel	56	07/94 →					

COMBO (71_)

1.2	Petrol	33	07/94 → 10/01				SVF014	B6
1.2	Petrol	33	07/94 → 10/01					
1.2	Petrol	33	07/94 → 10/01	ENGINE: X12SZ				
1.2	Petrol	33	09/94 → 10/01					
1.4	Petrol	44	07/94 → 10/01				B3253	B1
1.4	Petrol	44	07/94 → 10/01				SVF014	B6
1.4	Petrol	60	07/94 → 10/01				B3215	B1
1.4	Petrol	60	07/94 → 10/01				SVF013	B6
1.4	Petrol	44	07/94 → 10/01	ENGINE: X14SZ				
1.4	Petrol	60	07/94 → 10/01	ENGINE: C14SE				
1.4	Petrol	44	09/94 → 10/01					
1.4	Petrol	60	08/94 → 10/01					
1.4 16V	Petrol	66	08/99 → 10/01				SVF013	B6
1.4 16V	Petrol	66	08/99 → 10/01					
1.4 16V	Petrol	66	08/99 → 10/01					
1.4 16V	Petrol	66	08/99 → 10/01	CHASSIS: S3000001 →				
1.4 16V	Petrol	66	08/99 → 10/01	ENGINE: C14SEL				
1.7 D	Diesel	44	07/94 → 10/01					

COMBO Cassone / Furgonato / Promiscuo

1.3 CDTI 16V	Diesel	51	08/05 →					
1.3 CDTI 16V	Diesel	51	08/05 →					
1.3 CDTI 16V	Diesel	55	10/05 →					
1.3 CDTI 16V	Diesel	55	10/05 →					
1.4 16V	Petrol	66	08/05 →					
1.4 16V	Petrol	66	08/05 →					
1.4 16V	Petrol	66	08/05 →					
1.4 16V	Petrol	66	08/05 → 01/12					
1.6	Petrol	64	10/01 →					
1.6	Petrol	64	10/01 →					
1.6	Petrol	64	10/01 →					
1.6	Petrol	64	10/01 →	ENGINE: Z16SE				
1.6	Petrol	64	10/01 → 08/04					
1.6 CNG 16V	Petrol/CNG	69	06/06 →					
1.6 CNG 16V	Petrol/CNG	71	04/05 →					
1.6 CNG 16V	Petrol/CNG	69	06/06 →					
1.6 CNG 16V	Petrol/CNG	71	04/05 →					
1.6 CNG 16V	Petrol/CNG	71	04/05 →					

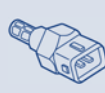

TYPE

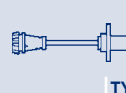

TYPE



TYPE

						SAC025	H2				
										ESS530	J1
						SAA110					
						SAA110					
						SPA171	F1		SAG141	H1	
						SSA042	F2				
										BAE608I	
											ESS525
		APS45				SPA171	F1		SAD027	H3	
						SSA042	F2		SAG141	H1	
		APS45				SPA171	F1		SAG141	H1	
						SSA042	F2				
										BAE608I	
										BAE608I	
											ESS525
											ESS532
		APS45				ATS17	F2		SAC082	H2	ESS532
						SPA171	F1				
						SSA042	F2				
									SAG124	H1	
											ESS530
						SSA042	F2				J1
									SAC093	H2	
									SAG025	H1	
									SAC093	H2	
									SAG025	H1	
	FEI0004					ATS17	F2	SAA103	SAC092	H2	
						SPA103	F1		SAD026	H3	
									SAG019	H1	
											BAE680AL
						ATS17	F2		SAC063	H2	
						SPA171	F1		SAD027	H3	
									SAG020	H1	
											BAE608G
											ESS532
						SPA171	F1		SAD027	H3	J1
						SPA171	F1		SAC080	H2	ESS0089A
									SAG020	H1	
									SAD027	H3	
									SAG020	H1	



KW



TYPE



TYPE

OPEL

COMBO Cassone / Furgonato / Promiscuo

1.7 CDTI 16V	Diesel	74	12/04 → 01/11	ENGINE: Z17DTH					
1.7 CDTI 16V	Diesel	74	12/04 →						
1.7 DI 16V	Diesel	48	10/01 →						
1.7 DTI 16V	Diesel	55	10/01 →						

COMBO Cassone / Furgonato / Promiscuo (X12)

1.3 CDTI	Diesel	66	02/12 →						
1.6 CDTi	Diesel	66	02/12 →						
1.6 CDTi	Diesel	74	02/12 →						
1.6 CDTi	Diesel	77	02/12 →						
2.0 CDTI	Diesel	99	02/12 →						

COMBO Tour

1.3 CDTI 16V	Diesel	51	10/04 →						
1.3 CDTI 16V	Diesel	51	10/04 →						
1.3 CDTI 16V	Diesel	55	10/05 →						
1.3 CDTI 16V	Diesel	55	10/05 →						
1.4	Petrol	66	10/04 →						
1.4	Petrol	66	10/04 →						
1.4	Petrol	66	10/04 →						
1.4	Petrol	66	10/04 → 01/12						
1.6	Petrol	64	10/01 →						
1.6	Petrol	64	04/05 →						
1.6	Petrol	64	10/01 →						
1.6	Petrol	64	10/01 →						
1.6	Petrol	64	10/01 →	ENGINE: Z16SE					
1.6	Petrol	64	10/01 → 08/04						
1.6 CNG	Petrol/CNG	69	06/06 →						
1.6 CNG	Petrol/CNG	71	04/05 →						
1.6 CNG	Petrol/CNG	69	06/06 →						
1.6 CNG	Petrol/CNG	71	04/05 →						
1.6 CNG	Petrol/CNG	71	04/05 →						
1.7 CDTI 16V	Diesel	74	12/04 → 01/11	ENGINE: Z17DTH					
1.7 CDTI 16V	Diesel	74	12/04 →						
1.7 DI 16V	Diesel	48	10/01 →						
1.7 DTI 16V	Diesel	55	10/01 →						

COMBO Tour (X12)

1.6 CDTi	Diesel	66	02/12 →						
1.6 CDTi	Diesel	74	02/12 →						
1.6 CDTi	Diesel	77	02/12 →						
2.0 CDTI	Diesel	99	02/12 →						

CORSA A 2 volumi /Coda spiovente (93_, 94_, 98_, 99_)

1.0	Petrol	33	09/82 → 03/93	CHASSIS: K4000001 →					
1.2	Petrol	33	09/82 → 08/90	CHASSIS: K4000001 →					
1.2 S	Petrol	40	09/82 → 02/90	CHASSIS: K4000001 →					
1.3 i	Petrol	44	09/86 → 09/90				SVF014	B6	

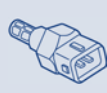
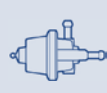

TYPE

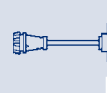

TYPE



TYPE

APS53

SPA171

F1

SAG117

H1

SAG117

H1

APS36

SPA146

F1

SAF001

H4

APS36

SAF001

H4

APS36

SAF001

H4

APS36

SAF001

H4

APS36

SAF001

H4

SAC093

H2

SAG025

H1

SAC093

H2

SAG025

H1

FEI0004

SPA103

F1

SAA103

SAC092

H2

SAD026

H3

SAG019

H1

BAE680AL

SPA171

F1

SAC063

H2

ATS17

F2

SAD027

H3

SAG020

H1

BAE608G

ESS532

J1

SPA171

F1

SAD027

H3

SPA171

F1

SAC080

H2

SAG020

H1

SAD027

H3

SAG020

H1

APS53

SPA171

F1

SAG117

H1

SAG117

H1

APS36

SAF001

H4

APS36

SAF001

H4

APS36

SAF001

H4

APS36

SAF001

H4

SSA042

F2

SSA042

F2

SSA042

F2



KW

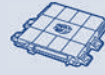

TYPE



TYPE

OPEL

CORSA A 2 volumi /Coda spiovente (93_, 94_, 98_, 99_)

1.3 i	Petrol	44	09/86 → 09/90	CHASSIS: K4000001 →				
1.3 S	Petrol	51	09/82 → 10/89	CHASSIS: K4000001 →				
1.4 i	Petrol	40	01/85 → 03/93				SVF014	B6
1.4 i	Petrol	44	01/90 → 03/93				SVF014	B6
1.4 i	Petrol	40	01/85 → 03/93	CHASSIS: K4000001 →				
1.4 i	Petrol	44	01/90 → 03/93	CHASSIS: K4000001 →				
1.4 i	Petrol	40	01/90 → 03/93					
1.4 S	Petrol	53	01/90 → 03/93	CHASSIS: K4000001 →				
1.4 Si	Petrol	60	09/91 → 03/93				B3215	B1
1.4 Si	Petrol	60	09/91 → 03/93				SVF013	B6
1.4 Si	Petrol	60	09/91 → 03/93	CHASSIS: K4000001 →				
1.4 Si	Petrol	60	09/91 → 03/93	ENGINE: C14SE				
1.5 D	Diesel	37	09/87 → 03/93					
1.5 TD	Diesel	49	03/88 → 03/93	CHASSIS: K4000001 →				
1.6 GSI	Petrol	55	08/88 → 09/92				B3253	B1
1.6 GSI	Petrol	55	08/88 → 09/92				SVF014	B6
1.6 GSI	Petrol	72	09/89 → 03/93				SVF015	B6
1.6 GSI	Petrol	74	05/88 → 03/92				B3215	B1
1.6 GSI	Petrol	74	05/88 → 03/92				SVF012	B6
1.6 GSI	Petrol	55	08/88 → 09/92	CHASSIS: K4000001 →				
1.6 GSI	Petrol	72	09/89 → 03/93	CHASSIS: K4000001 →				
1.6 GSI	Petrol	74	05/88 → 03/92	CHASSIS: K4000001 →				
1.6 GSI	Petrol	55	04/89 → 09/92					

CORSA A TR (91_, 92_, 96_, 97_)

1.0	Petrol	33	09/82 → 09/92	CHASSIS: K4000001 →				
1.2 i	Petrol	33	09/89 → 03/93				SVF014	B6
1.2 i	Petrol	33	09/89 → 03/93	CHASSIS: K4000001 →				
1.2 i	Petrol	33	09/90 → 03/93					
1.2 N	Petrol	33	01/85 → 10/87	CHASSIS: K4000001 →				
1.2 S	Petrol	40	09/82 → 03/93	CHASSIS: K4000001 →				
1.2 S	Petrol	43	09/82 → 10/87	CHASSIS: K4000001 →				
1.3	Petrol	44	09/85 → 10/87	CHASSIS: K4000001 →				
1.3 S	Petrol	51	09/82 → 10/87	CHASSIS: K4000001 →				
1.4 i	Petrol	44	10/89 → 03/93				SVF014	B6
1.4 i	Petrol	44	10/89 → 03/93	CHASSIS: K4000001 →				
1.4 i	Petrol	44	01/90 → 03/93					
1.4 S	Petrol	53	09/89 → 03/93	CHASSIS: K4000001 →				
1.5 TD	Diesel	49	10/87 → 03/93					
1.5 TD	Diesel	49	10/87 → 03/93	CHASSIS: K4000001 →				

CORSA B (73_, 78_, 79_)

1.2 i	Petrol	33	03/93 → 09/00				SVF014	B6
1.2 i	Petrol	33	03/93 → 09/00				SVF014	B6
1.2 i	Petrol	33	03/93 → 09/00					
1.2 i	Petrol	33	03/93 → 09/00	CHASSIS: → V6999999				

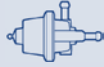

TYPE



TYPE



TYPE

				SSA042	F2				
				SSA042	F2				
								ESS525	J1
				SSA042	F2				
				SSA042	F2				
								ESS525	J1
				SSA042	F2				
						SAG141	H1	PI024	J1
				SSA042	F2				
								BAE608I	
				SPA130	F1				
				SSA042	F2				
				SPA115	F1				
								ESS530	J1
								PI024	J1
				SSA042	F2				
				SSA042	F2				
				SSA042	F2				
								ESS525	J1
				SSA042	F2				
				SSA042	F2				
								ESS525	J1
				SSA042	F2				
				SSA042	F2				
				SSA042	F2				
				SSA042	F2				
				SSA042	F2				
				SSA042	F2				
				SSA042	F2			ESS525	J1
				SSA042	F2				
				SPA130	F1				
				SSA042	F2				
		APS45		SSA042	F2			ESS525	J1
		APS45		SSA042	F2	SAG141	H1	ESS525	J1
								GA2197	J2
				SPA104	F1				



KW



TYPE



TYPE

OPEL

CORSA B (73_, 78_, 79_)

1.2 i	Petrol	33	03/93 → 09/00	CHASSIS: → V6999999				
1.2 i	Petrol	33	03/93 → 09/00	ENGINE: X12SZ				
1.2 i	Petrol	33	03/93 → 09/00	ENGINE: X12SZ				
1.2 i 16V	Petrol	48	03/98 → 09/00				SVF016	B6
1.2 i 16V	Petrol	48	03/98 → 09/00					
1.2 i 16V	Petrol	48	03/98 → 08/00					
1.2 i 16V	Petrol	48	03/98 → 08/00					
1.4 i	Petrol	44	03/93 → 09/00				B3253	B1
1.4 i	Petrol	44	03/93 → 09/00					
1.4 i	Petrol	44	03/93 → 09/00	CHASSIS: → V6999999				
1.4 i	Petrol	44	03/93 → 09/00	ENGINE: X14SZ				
1.4 i 16V	Petrol	63	08/97 → 09/00				B3215	B1
1.4 i 16V	Petrol	63	08/97 → 09/00				SVF013	B6
1.4 i 16V	Petrol	66	09/94 → 09/00				B3215	B1
1.4 i 16V	Petrol	66	09/94 → 09/00				SVF013	B6
1.4 i 16V	Petrol	66	09/94 → 09/00	CHASSIS: → V6999999				
1.4 i 16V	Petrol	63	08/97 → 09/00	CHASSIS: S3000001 →				
1.4 i 16V	Petrol	66	09/94 → 09/00	CHASSIS: S3000001 →				
1.4 i 16V	Petrol	63	08/97 → 09/00	ENGINE: C14SEL				
1.4 i 16V	Petrol	66	09/94 → 09/00	ENGINE: X14XE				
1.4 i 16V	Petrol	63	02/98 → 08/00					
1.4 i 16V	Petrol	66	09/94 → 08/99					
1.4 Si	Petrol	60	03/93 → 09/00				B3215	B1
1.4 Si	Petrol	60	03/93 → 09/00				SVF013	B6
1.4 Si	Petrol	60	03/93 → 09/00	CHASSIS: → V6999999				
1.4 Si	Petrol	60	03/93 → 08/00					
1.5 D	Diesel	37	03/93 → 09/00					
1.5 TD	Diesel	49	03/93 → 09/00					
1.6 GSI 16V	Petrol	80	03/93 → 09/00				B3215	B1
1.6 GSI 16V	Petrol	80	03/93 → 09/00				SVF013	B6
1.6 GSI 16V	Petrol	80	03/93 → 09/00	CHASSIS: → V6999999				
1.6 GSI 16V	Petrol	80	03/93 → 09/00	CHASSIS: S3000001 →				
1.6 GSI 16V	Petrol	80	03/93 → 08/00					
1.6 i 16V	Petrol	74	08/97 → 09/00				B3215	B1
1.6 i 16V	Petrol	74	08/97 → 09/00				SVF013	B6
1.6 i 16V	Petrol	78	09/94 → 09/00				B3215	B1
1.6 i 16V	Petrol	78	09/94 → 09/00				SVF013	B6
1.6 i 16V	Petrol	74	08/97 → 09/00					
1.6 i 16V	Petrol	78	09/94 → 09/00	CHASSIS: → V6999999				
1.6 i 16V	Petrol	74	08/97 → 09/00	CHASSIS: S3000001 →				
1.6 i 16V	Petrol	78	09/94 → 09/00	CHASSIS: S3000001 →				
1.6 i 16V	Petrol	74	08/97 → 09/00	ENGINE: C16SEL-X16XE				
1.6 i 16V	Petrol	78	09/94 → 09/00	ENGINE: C16XE				
1.6 i 16V	Petrol	74	05/98 → 08/00					

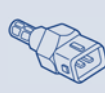

TYPE

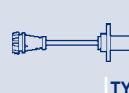

TYPE



TYPE

				SPA104	F1						
										BAE608I	
										BAE608I	
				SPA103	F1	SAA103	SAG019	H1		SUA507	J1
				SSA042	F2						
										BAE680AJ	
										ESS532	J1
		APS45		SSA042	F2		SAD027	H3		ESS525	J1
							SAG141	H1		GA2197	J2
				SPA104	F1						
										BAE608I	
				SPA171	F1		SAC082	H2		SUA507	J1
				SSA042	F2						
		APS45		ATS17	F2		SAC082	H2		SUA507	J1
				SSA042	F2		SAD027	H3			
				SPA104	F1						
							SAG124	H1			
							SAG124	H1			
										BAE608I	
										BAE608I	
										ESS532	J1
										ESS532	J1
		APS45		SSA042	F2		SAG141	H1		SUA507	J1
				SPA104	F1						
										ESS532	J1
				SSA042	F2						
				SSA042	F2						
				SSA042	F2		SAC082	H2		SUA507	J1
							SAD027	H3			
				SPA104	F1						
							SAG124	H1			
										ESS532	J1
		APS45		ATS17	F2		SAC082	H2		SUA507	J1
				SPA171	F1						
		APS45		ATS17	F2		SAC082	H2		GA2197	J2
				SSA042	F2		SAD027	H3		SUA507	J1
				SSA042	F2						
				SPA104	F1						
							SAG124	H1			
							SAG124	H1			
										BAE608I	
										BAE608I	
										ESS532	J1



KW



TYPE



TYPE

OPEL

CORSA B (73_, 78_, 79_)

1.6 i 16V	Petrol	78	09/94 → 08/99					
1.7 D	Diesel	44	02/96 → 09/00					

CORSA B Furgonato (73_)

1.4 i	Petrol	44	08/99 → 09/00				B3253	B1
1.4 i	Petrol	44	08/99 → 09/00				SVF014	B6
1.4 i	Petrol	44	08/99 → 09/00	ENGINE: X14SZ				
1.7 D	Diesel	44	08/99 → 09/00					

CORSA C (F08, F68)

1.0	Petrol	44	06/03 → 12/09					
1.0	Petrol	43	09/00 → 12/09					
1.0	Petrol	43	09/00 → 08/03					
1.0	Petrol	44	06/03 → 12/09					
1.0	Petrol	44	09/03 → 08/05					
1.0	Petrol	44	06/03 → 12/09					
1.0	Petrol	44	09/03 → 09/06					
1.2	Petrol	55	09/00 → 12/09					
1.2	Petrol	55	09/00 → 06/04					
1.2 Twinport	Petrol	59	07/04 → 12/09					
1.2 Twinport	Petrol	59	07/04 → 12/09					
1.2 Twinport	Petrol	59	07/04 → 12/09					
1.2 Twinport	Petrol	59	07/04 → 09/06					
1.3 CDTI	Diesel	51	06/03 → 12/09					
1.3 CDTI	Diesel	51	06/03 → 12/09					
1.4	Petrol	66	09/00 → 12/09					
1.4	Petrol	66	09/00 → 12/09					
1.4	Petrol	66	09/00 → 12/09					
1.4 Twinport	Petrol	66	06/03 → 12/09					
1.4 Twinport	Petrol	66	06/03 → 12/09					
1.4 Twinport	Petrol	66	09/03 → 08/05					
1.4 Twinport	Petrol	66	09/03 → 12/09					
1.4 Twinport	Petrol	66	09/03 → 09/06					
1.7 CDTI	Diesel	74	06/03 → 12/09					
1.7 CDTI	Diesel	74	09/03 → 09/06	ENGINE: Z17DTH				
1.7 DI	Diesel	48	09/00 → 12/09					
1.7 DTI	Diesel	55	09/00 → 12/09					
1.8	Petrol	92	09/00 → 12/09				TB0012	B3
1.8	Petrol	92	09/00 → 12/09					
1.8	Petrol	92	09/00 → 12/09					

CORSA C Furgonato (F08, W5L)

1.2	Petrol	59	07/05 →					
1.2	Petrol	59	07/05 →					
1.2	Petrol	59	07/05 →					
1.2	Petrol	59	07/05 → 09/06					
1.2 16V	Petrol	55	09/00 →					



TYPE



TYPE



TYPE

									ESS532	J1
			SSA042	F2						
	APS45		SPA171	F1		SAD027	H3		ESS525	J1
			SSA042	F2		SAG141	H1			
								BAE608I		
			SSA042	F2						
FEI0004			SPA171	F1	SAA103	SAC092	H2		ESS0089A	J1
			SPA171	F1	SAA103				ESS0089A	J1
			SPA103	F1		SAG019	H1	BAE680AI		
						SAD026	H3			
			SPA103	F1						
						SAG019	H1			
								BAE680BN		
			SPA171	F1	SAA103			BAE680AJ	ESS0089A	J1
			SPA103	F1		SAG019	H1			
FEI0004			SPA103	F1	SAA103	SAC092	H2		ESS0089A	J1
						SAD026	H3			
						SAG019	H1			
								BAE680AL		
	APS23					SAC093	H2			
						SAG025	H1			
	APS44		ATS17	F2		SAC080	H2		ESS0089A	J1
			SPA171	F1		SAD027	H3			
						SAG020	H1			
FEI0004			SPA171	F1	SAA103	SAC092	H2		ESS0089A	J1
						SAD026	H3			
			SPA103	F1						
						SAG019	H1			
								BAE680AL		
	APS43		SPA171	F1						
	APS53									
						SAG117	H1			
			SSA042	F2		SAG117	H1			
						SAC071	H2		ESS0089A	J1
						SAD007	H3			
						SAG120	H1			
FEI0004			SPA171	F1	SAA103	SAC092	H2			
						SAD026	H3			
						SAG019	H1			
								BAE680AL		
			SPA171	F1	SAA103	SAG019	H1	BAE680AJ		



KW



TYPE



TYPE

OPEL

CORSA C Furgonato (F08, W5L)

1.2 16V	Petrol	55	09/00 → 06/04					
1.2 16V	Petrol	55	09/00 →	ENGINE: Z14XE				
1.3 CDTI 16V	Diesel	51	08/05 →					
1.3 CDTI 16V	Diesel	51	08/05 →					
1.4	Petrol	66	08/03 →					
1.4	Petrol	66	09/03 → 09/06					
1.7 CDTI	Diesel	74	09/03 → 09/06	ENGINE: Z17DTH				
1.7 DI 16V	Diesel	48	09/00 →					
1.7 DTI 16V	Diesel	55	09/00 →					

CORSA D

1.0	Petrol	44	07/06 →					
1.0	Petrol	48	01/10 →					
1.0	Petrol	44	07/06 →					
1.0	Petrol	44	07/06 → 10/09					
1.2	Petrol	63	06/10 →			PAS002	B5	
1.2	Petrol	51	06/10 →					
1.2	Petrol	59	07/06 →					
1.2	Petrol	59	07/06 →					
1.2 LPG	Petrol/LPG	59	09/09 →					
1.2 LPG	Petrol/LPG	61	06/11 →					
1.2 LPG	Petrol/LPG	63	08/11 →					
1.3 CDTI	Diesel	70	06/10 →					
1.3 CDTI	Diesel	55	07/06 →					
1.3 CDTI	Diesel	55	07/06 →					
1.3 CDTI	Diesel	66	07/06 →					
1.3 CDTI	Diesel	66	07/06 →					
1.4	Petrol	64	09/09 →					
1.4	Petrol	66	07/06 →					
1.4	Petrol	74	06/10 →					
1.4	Petrol	64	01/10 →					
1.4	Petrol	66	07/06 → 11/10					
1.4 LPG	Petrol/LPG	64	09/09 →					
1.4 LPG	Petrol/LPG	66	07/06 →					
1.4 LPG	Petrol/LPG	66	07/06 →					
1.4 LPG	Petrol/LPG	66	09/09 → 11/10					
1.6 Turbo	Petrol	110	05/07 →					
1.6 Turbo	Petrol	141	02/07 →					
1.6 Turbo	Petrol	155	07/11 →					
1.6 Turbo	Petrol	110	02/07 →					
1.6 Turbo	Petrol	141	02/07 →					
1.7 CDTI	Diesel	92	07/06 →			TB0002	B3	
1.7 CDTI	Diesel	96	06/10 →					



TYPE



TYPE



TYPE

				SPA103	F1					
								BAE608F		
	APS23						SAC093	H2	ESS0070A	J1
							SAG025	H1		
				SPA171	F1	SAA103	SAC092	H2		
									BAE680AL	
	APS53									
							SAG117	H1		
							SAG117	H1		
FEI0004				SPA171	F1	SAA103	SAC092	H2	ESS0028A	J1
FEI0004						SAA103				
							SAD026	H3		
									BAE680BN	
FEI0004						SAA103				
FEI0004						SAA103				
FEI0004				SPA171	F1	SAA103	SAC092	H2	BAE680AL	ESS0028A
							SAD026	H3		
FEI0004				SPA171	F1	SAA103	SAC092	H2	BAE680AL	
FEI0004										
FEI0004						SAA103				
	APS49			SPA146	F1					
				SPA146	F1		SAC093	H2		
							SAG025	H1		
							SAC093	H2		
							SAG025	H1		
FEI0004										
FEI0004						SAA103	SAC092	H2		
FEI0004						SAA103				
									BAE680AL	
FEI0004						SAA103				
FEI0004				SPA171	F1	SAA103	SAC092	H2	ESS0028A	J1
							SAD026	H3		
									BAE680AL	
						SAA103				
						SAA103	SAC092	H2	GA2074	J2
						SAA103				
							SAC092	H2	GA2074	J2
							SAD026	H3		
				SPA171	F1					
				SPA171	F1					



KW



TYPE



TYPE

OPEL

CORSA D Van

1.0	Petrol	48	01/10 →						
1.0	Petrol	44	08/06 →						
1.2	Petrol	51	06/10 →						
1.2	Petrol	59	07/09 →						
1.2	Petrol	63	06/10 →						
1.3 CDTI	Diesel	70	06/10 →						
1.3 CDTI	Diesel	55	07/06 →						

FRONTERA A (5_MWL4)

2.2 i (54MWL4)	Petrol	100	03/95 → 10/98					SVF015	B6
2.2 i (54MWL4)	Petrol	100	03/95 → 10/98	CHASSIS: → TV899999					
2.4 i (53MWL4)	Petrol	92	03/92 → 08/95					SVF015	B6
2.4 i (53MWL4)	Petrol	92	03/92 → 10/98						

FRONTERA A Sport (5_SUD2)

2.0 i (52SUD2, 55SUD2)	Petrol	85	03/92 → 08/95					SVF015	B6
2.0 i (52SUD2, 55SUD2)	Petrol	85	03/92 → 10/98						
2.0 i (52SUD2, 55SUD2)	Petrol	85	03/92 → 10/98						

FRONTERA B (6B_)

2.2 DTI	Diesel	88	09/02 →						
2.2 DTI	Diesel	88	09/02 → 09/04	ENGINE: 3V500001 →					
2.2 DTI (6B_ZC, 6B_VF, 6B_66, 6B_76)	Diesel	85	10/98 → 09/02	ENGINE: 3V500001 →					
2.2 DTI (6B_ZC, 6B_VF, 6B_66, 6B_76)	Diesel	85	10/98 → 09/02						
2.2 DTI (6B_ZC, 6B_VF, 6B_66, 6B_76)	Diesel	85	10/98 → 09/02						
2.2 i (6B_ZC, 6B_VF, 6B_66, 6B_76)	Petrol	100	10/98 →	CHASSIS: → YV599999				SVF013	B6
2.2 i (6B_ZC, 6B_VF, 6B_66, 6B_76)	Petrol	100	10/98 →						
2.2 i (6B_ZC, 6B_VF, 6B_66, 6B_76)	Petrol	100	10/98 →						
2.2 i (6B_ZC, 6B_VF, 6B_66, 6B_76)	Petrol	100	10/98 →						
2.2 i (6B_ZC, 6B_VF, 6B_66, 6B_76)	Petrol	100	10/98 →	ENGINE: X22SE-Y22SE					
3.2 i (6B1VF, 6B1_6)	Petrol	151	10/98 →						

INSIGNIA

1.4	Petrol	103	04/11 →						
1.6	Petrol	85	07/08 →						
1.6 Turbo	Petrol	132	07/08 →						
1.8	Petrol	103	07/08 →						
2.0 Biturbo CDTI	Diesel	140	07/08 →						
2.0 Biturbo CDTI 4x4	Diesel	140	05/09 →						
2.0 CDTI	Diesel	118	07/08 →						



TYPE

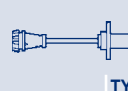

TYPE



TYPE

FEI0004					SAA103				
					SAA103				
FEI0004					SAA103				
FEI0004					SAA103	SAC092	H2	BAE680AL	
FEI0004					SAA103				
	APS49		SPA146	F1					
			SPA146	F1					
						SAD013	H3		ESS0039A
						SAG093	H1		
			SPA104	F1					ESS0039A
									J1
			SPA104	F1		SAD013	H3		ESS0039A
						SAG093	H1		J1
			SPA171	F1					
			SPA103	F1					
			SPA103	F1					
						SAG021	H1		
						SAG021-1	H1		
	APS44		SPA115	F1		SAC036	H2		ESS0039A
						SAD027	H3		J1
						SAG051	H1		
								BAE608M	
	APS44								ESS0039A
									J1
						SAA103			
						SAA103		BAE680CS	GA2103
						SAA103	SAC092	H2	BAE680CS
						SAA103		BAE680CS	GA2103
			SPA171	F1					GA2172
			SPA171	F1					J2
	APS49		SPA171	F1					GA2172
									J2



KW

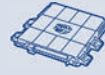

TYPE



TYPE

OPEL

INSIGNIA

2.0 CDTi	Diesel	81	07/08 →						
2.0 CDTi	Diesel	96	07/08 →						
2.0 CDTi 4x4	Diesel	118	06/10 →						
2.8 V6 Turbo 4x4	Petrol	191	07/08 →						

INSIGNIA Sports Tourer

1.4	Petrol	103	09/11 →						
1.6	Petrol	85	07/08 →						
1.6 Turbo	Petrol	132	01/09 →						
1.8	Petrol	103	07/08 →						
2.0 Biturbo CDTi	Diesel	140	07/08 →						
2.0 Biturbo CDTi 4x4	Diesel	140	07/08 →						
2.0 CDTi	Diesel	118	07/08 →						
2.0 CDTi	Diesel	81	07/08 →						
2.0 CDTi	Diesel	96	07/08 →						
2.0 CDTi 4x4	Diesel	118	06/10 →						
2.8 V6 Turbo 4x4	Petrol	191	10/08 →						

INSIGNIA Tre volumi

1.4	Petrol	103	04/11 →						
1.6	Petrol	85	07/08 →						
1.6 Turbo	Petrol	132	01/09 →						
1.8	Petrol	103	07/08 →						
2.0 Biturbo CDTi	Diesel	140	07/08 →						
2.0 Biturbo CDTi 4x4	Diesel	140	07/08 →						
2.0 CDTi	Diesel	118	07/08 →						
2.0 CDTi	Diesel	81	07/08 →						
2.0 CDTi	Diesel	96	07/08 →						
2.0 CDTi 4x4	Diesel	118	06/10 →						
2.8 V6 Turbo 4x4	Petrol	191	07/08 →						

KADETT E (39_, 49_)

1.8	Petrol	84	09/87 → 08/90				SVF012	B6	
1.8	Petrol	84	09/87 → 08/90	CHASSIS: J5273428 →					
1.8 i	Petrol	85	09/84 → 08/86	CHASSIS: J5273428 →					

KADETT E 2 volumi /Coda spiovente (33_, 34_, 43_, 44_)

2.0 GSI 16V	Petrol	115	12/87 → 08/91						
-------------	--------	-----	---------------	--	--	--	--	--	--

KADETT E Cabriolet (43B_)

1.3 S	Petrol	55	03/87 → 02/93	CHASSIS: J5273428 →					
1.4 i	Petrol	44	01/90 → 08/91				SVF014	B6	
1.4 i	Petrol	44	01/90 → 08/91						
1.4 S	Petrol	55	08/90 → 02/93	CHASSIS: J5273428 →					
1.6 i	Petrol	60	07/89 → 02/93	CHASSIS: J5273428 →					

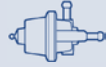

TYPE



TYPE



TYPE

	APS49		SPA171	F1				GA2172	J2
	APS49		SPA171	F1				GA2172	J2
	APS49		SPA171	F1					
			SPA171	F1					
					SAA103				
					SAA103		BAE680CS	GA2103	J2
					SAA103	SAC092	H2	BAE680CS	
					SAA103		BAE680CS	GA2103	J2
			SPA171	F1				GA2172	J2
			SPA171	F1					
	APS49		SPA171	F1				GA2172	J2
	APS49		SPA171	F1				GA2172	J2
	APS49		SPA171	F1				GA2172	J2
	APS49		SPA171	F1					
			SPA171	F1					
					SAA103				
					SAA103		BAE680CS	GA2103	J2
					SAA103	SAC092	H2	BAE680CS	
					SAA103		BAE680CS	GA2103	J2
			SPA171	F1				GA2172	J2
			SPA171	F1					
	APS49		SPA171	F1				GA2172	J2
	APS49		SPA171	F1				GA2172	J2
	APS49		SPA171	F1				GA2172	J2
	APS49		SPA171	F1					
			SPA171	F1					
			SSA042	F2					
			SSA042	F2					
			SPA104	F1				PI024	J1
			SSA042	F2					
			SPA104	F1					
			SSA042	F2					
			SSA042	F2					
			SSA042	F2					



KW



TYPE



TYPE

OPEL

KADETT E Combo (38_, 48_)

1.4 i	Petrol	44	08/91 → 07/94					SVF014	B6
1.4 i	Petrol	44	08/91 → 07/94	CHASSIS: J5273428 →					
1.4 S	Petrol	55	07/89 → 08/91	CHASSIS: J5273428 →					
1.6 i	Petrol	55	08/91 → 07/94					B3253	B1
1.6 i	Petrol	55	08/91 → 07/94					SVF014	B6
1.6 i	Petrol	55	08/91 → 07/94	CHASSIS: J5273428 →					

KADETT E Furgonato (37_, 47_)

1.2	Petrol	40	09/84 → 07/86	CHASSIS: J5273428 →					
1.3 N	Petrol	44	09/84 → 07/89						
1.4 i	Petrol	44	01/90 → 08/91					SVF014	B6
1.4 i	Petrol	44	01/90 → 08/91						
1.6 D	Diesel	40	08/84 → 08/88						
1.6 i	Petrol	55	08/89 → 09/93					B3253	B1
1.6 i	Petrol	55	08/89 → 09/93					SVF014	B6
1.6 i	Petrol	55	08/89 → 12/91						
1.6 i	Petrol	55	08/89 → 08/93						
1.7 D	Diesel	42	08/88 → 09/92						
1.8 i	Petrol	66	08/84 → 09/92					SVF014	B6
1.8 i	Petrol	66	08/84 → 09/92	CHASSIS: J5273428 →					

KADETT E Station wagon (35_, 36_, 45_, 46_)

1.8 i	Petrol	85	09/84 → 08/86	CHASSIS: J5273428 →					
-------	--------	----	---------------	---------------------	--	--	--	--	--

MERIVA

1.3 CDTI	Diesel	51	04/05 → 05/10						
1.3 CDTI	Diesel	51	04/05 → 05/10						
1.3 CDTI	Diesel	55	09/03 → 05/10						
1.3 CDTI	Diesel	55	09/03 → 05/10						
1.4 16V Twinport	Petrol	66	07/04 → 05/10						
1.4 16V Twinport	Petrol	66	07/04 → 05/10						
1.4 16V Twinport	Petrol	66	09/04 → 05/10						
1.4 16V Twinport	Petrol	66	07/04 → 03/10						
1.4 16V Twinport LPG	Petrol/LPG	66	07/04 → 05/10						
1.4 16V Twinport LPG	Petrol/LPG	66	07/04 → 03/10						
1.6	Petrol	64	05/03 → 05/10						
1.6	Petrol	64	05/03 → 05/10						
1.6	Petrol	64	05/03 → 05/10						
1.6	Petrol	77	01/06 → 05/10						
1.6	Petrol	77	01/06 → 05/10						
1.6	Petrol	64	05/03 → 05/10	ENGINE: Z16SE					
1.6 16V	Petrol	74	05/03 → 01/06						
1.6 16V	Petrol	74	05/03 → 01/06						
1.6 16V	Petrol	74	05/03 → 01/06						
1.6 16V	Petrol	74	05/03 → 01/06	ENGINE: Z16XE					
1.6 Turbo	Petrol	132	09/05 → 05/10						
1.6 Turbo	Petrol	132	09/05 → 05/10						

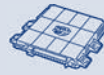
KW

TYPE

TYPE
OPEL
MERIVA

1.7 CDTI	Diesel	74	09/03 → 05/10							TB0002	B3
1.7 CDTI	Diesel	92	09/06 → 05/10							TB0002	B3
1.7 CDTI	Diesel	74	09/03 → 09/09	ENGINE: Z17DTH,Z17DT							
1.7 DTI	Diesel	55	09/03 → 05/10								
1.8	Petrol	92	05/03 → 05/10							TB0012	B3
1.8	Petrol	92	05/03 → 05/10								
1.8	Petrol	92	05/03 → 05/10								

MERIVA B

1.3 CDTI	Diesel	70	06/10 →								
1.4	Petrol	74	06/10 →								
1.4	Petrol	103	06/10 →								
1.4	Petrol	88	06/10 →								
1.4 LPG	Petrol/LPG	88	06/11 →								
1.7 CDTI	Diesel	74	06/10 →								
1.7 CDTI	Diesel	81	06/10 →								
1.7 CDTI	Diesel	96	06/10 →								

MOKKA

1.4 4x4	Petrol	103	06/12 →								
1.6	Petrol	85	06/12 →								

MONTEREY A (UBS_)

3.1 TD (UBS69_)	Diesel	84	09/91 → 07/98								
-----------------	--------	----	---------------	--	--	--	--	--	--	--	--

MONTEREY B

3.5 V6 24V	Petrol	158	07/98 → 08/99								
------------	--------	-----	---------------	--	--	--	--	--	--	--	--

MOVANO Combi (J9)

1.9 DTI	Diesel	59	09/00 → 10/01								
1.9 DTI	Diesel	60	10/01 →								
2.2 DTI	Diesel	66	09/00 →								
2.5 D	Diesel	59	07/98 → 09/00								
2.5 DTi	Diesel	84	10/01 →								
2.8 dTi	Diesel	84	06/99 → 10/01	ENGINE: 2762408 →							

MOVANO Furgonato (F9)

1.9 DTI	Diesel	59	09/00 → 10/01								
1.9 DTI	Diesel	60	10/01 →								
2.2 DTI	Diesel	66	09/00 →								
2.5 D	Diesel	59	01/99 → 09/00								
2.5 DTi	Diesel	84	10/01 →								
2.5 DTi	Diesel	73	10/03 →								
2.8 dTi	Diesel	84	06/99 → 10/01	ENGINE: 2762408 →							

MOVANO Pianale piatto/Telaio (U9, E9)

2.2 DTI	Diesel	66	09/00 →								
2.5 D	Diesel	59	07/98 → 09/00								
2.5 DTi	Diesel	84	10/01 →								
2.8 dTi	Diesel	84	06/99 → 10/01	ENGINE: 2762408 →							

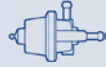

TYPE



TYPE



TYPE

	APS43		SPA171	F1				SUA573	J3
			SPA171	F1					
	APS53								
						SAG117	H1	SUA573	J3
						SAC071	H2	GA2213	J2
						SAD007	H3		
						SAG120	H1		
	APS49		SPA146	F1					
FEI0004					SAA103			GA2114	J2
					SAA103				
					SAA103				
					SAA103				
			SPA171	F1					
			SPA171	F1					
			SPA171	F1					
					SAA103				
					SAA103				
					SAA110				
	APS44								
			SPA169	F1					
			SPA169	F1		SAG153	H1		
			SPA169	F1		SAG153	H1		
			SPA160	F1					
			SPA169	F1		SAG153	H1		
			SPA160	F1					
			SPA169	F1					
			SPA169	F1		SAG153	H1		
			SPA169	F1		SAG153	H1		
			SPA160	F1					
			SPA169	F1		SAG153	H1		
			SPA160	F1					
			SPA169	F1		SAG153	H1		
			SPA160	F1					
			SPA169	F1		SAG153	H1		
			SPA160	F1					



KW

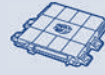

TYPE



TYPE

OPEL

MOVANO Ribaltabile (H9)

2.2 DTI	Diesel	66	09/00 →					
2.5 D	Diesel	59	01/99 → 09/00					
2.5 DTi	Diesel	73	10/03 →					
2.8 dTI	Diesel	84	06/99 → 10/01	ENGINE: 2762408 →				

OMEGA A (16_, 17_, 19_)

1.8	Petrol	85	09/86 → 03/94				SVF012	B6
1.8	Petrol	65	09/87 → 03/94					
1.8	Petrol	65	09/87 → 03/94	CHASSIS: P1132204 →				
1.8	Petrol	85	09/86 → 01/88					
1.8	Petrol	85	09/86 → 03/94	CHASSIS: K1000099 →				
1.8 N	Petrol	60	09/86 → 08/87					
1.8 N	Petrol	60	09/86 → 08/87					
1.8 S	Petrol	66	09/86 → 03/94					
1.8 S	Petrol	66	09/86 → 12/88					
2.0	Petrol	73	09/90 → 02/92	CHASSIS: L1019855 →			SVF015	B6
2.0	Petrol	74	09/90 → 02/92	CHASSIS: L1019855 →			SVF015	B6
2.0	Petrol	90	09/86 → 03/94	CHASSIS: L1019855 →			SVF015	B6
2.0	Petrol	73	09/90 → 03/94	CHASSIS: P1132204 →				
2.0	Petrol	74	09/90 → 03/94	CHASSIS: P1132204 →				
2.0	Petrol	90	09/86 → 03/94					
2.0	Petrol	90	09/86 → 01/88					
2.0	Petrol	73	09/90 → 03/94					
2.0	Petrol	74	09/90 → 03/94					
2.0	Petrol	73	09/90 → 02/92	CHASSIS: K1000099 →				
2.0	Petrol	74	09/90 → 02/92	CHASSIS: K1000099 →				
2.0	Petrol	90	09/86 → 03/94	CHASSIS: K1000099 →				
2.0 i	Petrol	85	09/86 → 03/94	CHASSIS: L1019855 →			SVF015	B6
2.0 i	Petrol	85	09/86 → 03/94					
2.0 i	Petrol	85	09/86 → 01/88					
2.0 i	Petrol	85	09/86 → 03/94	CHASSIS: K1000099 →				
2.3 D	Diesel	54	10/86 → 03/94	CHASSIS: K1000099 →				
2.3 TD	Diesel	66	10/86 → 08/88	CHASSIS: K1000099 →				
2.4 i	Petrol	92	09/88 → 03/94				SVF015	B6
2.4 i	Petrol	92	09/88 → 03/94					
2.4 i	Petrol	92	09/88 → 03/94	CHASSIS: K1000099 →				
2.6 i	Petrol	110	09/90 → 03/94				SVF015	B6
2.6 i	Petrol	110	09/90 → 03/94					
2.6 i	Petrol	110	09/90 → 03/94	CHASSIS: K1000099 →				
3.0 (3000)	Petrol	115	03/87 → 12/87					
3.0 (3000)	Petrol	115	03/87 → 12/87	CHASSIS: P1132204 →				
3.0 (3000)	Petrol	130	03/87 → 09/90					
3.0 (3000)	Petrol	130	03/87 → 12/89					
3.0 (3000)	Petrol	130	01/88 → 09/90					
3.0 (3000)	Petrol	130	03/87 → 12/89	CHASSIS: K1000099 →				

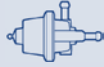

TYPE



TYPE



TYPE

				SPA169	F1		SAG153	H1	
				SPA160	F1				
							SAG153	H1	
				SPA160	F1				
				SPA104	F1		SAG093	H1	PI024 J1
				SPA104	F1		SAG093	H1	
				SSA042	F2				
				SSA042	F2				
									ESS530 J1
				SPA104	F1				
				SSA042	F2				
				SPA104	F1		SAG093	H1	
				SSA042	F2				
				SSA042	F2				
				SSA042	F2				
				SPA104	F1		SAG093	H1	PI024 J1
				SSA042	F2				
							SAG093	H1	PI024 J1
							SAG093	H1	PI024 J1
									ESS530 J1
									ESS530 J1
									ESS530 J1
				SPA104	F1		SAG093	H1	PI024 J1
				SSA042	F2				
									ESS530 J1
				SSA042	F2				
				SSA042	F2				
				SPA104	F1				PI024 J1
				SSA042	F2				
									ESS530 J1
				SPA104	F1				PI024 J1
				SSA042	F2				
									ESS530 J1
				SPA104	F1				PI024 J1
				SSA042	F2				
				SPA104	F1				PI024 J1
				SPA129	F1				
				SSA042	F2				
									ESS530 J1



KW

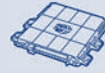

TYPE



TYPE

OPEL

OMEGA A (16_, 17_, 19_)

3.0 24V (3000)	Petrol	147	09/89 → 03/94				SVF015	B6
3.0 24V (3000)	Petrol	150	09/89 → 03/94				SVF015	B6
3.0 24V (3000)	Petrol	147	09/89 → 03/94	CHASSIS: P1132204 →				
3.0 24V (3000)	Petrol	147	09/89 → 03/94	CHASSIS: K1000099 →				
3.0 24V (3000)	Petrol	150	09/89 → 03/94	CHASSIS: K1000099 →				
3.0 24V Evolution500	Petrol	169	03/91 → 07/92					
3.6 24V Lotus	Petrol	277	08/90 → 09/92	CHASSIS: P1132204 →				
3.6 24V Lotus	Petrol	277	08/90 → 09/92					

OMEGA A Station wagon (66_, 67_)

1.8	Petrol	85	09/86 → 03/94				SVF012	B6
1.8	Petrol	65	09/87 → 03/94					
1.8	Petrol	65	09/87 → 01/88					
1.8	Petrol	85	09/86 → 01/88					
1.8	Petrol	85	09/86 → 03/94	CHASSIS: K1000099 →				
1.8 N	Petrol	60	09/86 → 08/87					
1.8 N	Petrol	60	09/86 → 08/87					
1.8 S	Petrol	66	09/86 → 03/94					
1.8 S	Petrol	66	09/86 → 01/88					
2.0	Petrol	74	09/90 → 02/92	CHASSIS: L1019855 →			SVF015	B6
2.0	Petrol	90	09/86 → 03/94	CHASSIS: L1019855 →			SVF015	B6
2.0	Petrol	74	09/90 → 03/94	CHASSIS: P1132204 →				
2.0	Petrol	90	09/86 → 03/94					
2.0	Petrol	90	09/86 → 03/94	CHASSIS: P1132204 →				
2.0	Petrol	74	09/90 → 03/94					
2.0	Petrol	74	09/90 → 02/92	CHASSIS: K1000099 →				
2.0	Petrol	90	09/86 → 03/94	CHASSIS: K1000099 →				
2.0 i	Petrol	73	09/90 → 02/92	CHASSIS: L1019855 →			SVF015	B6
2.0 i	Petrol	85	09/86 → 03/94	CHASSIS: L1019855 →			SVF015	B6
2.0 i	Petrol	73	09/90 → 03/94	CHASSIS: P1132204 →				
2.0 i	Petrol	85	09/86 → 03/94					
2.0 i	Petrol	85	09/86 → 01/88					
2.0 i	Petrol	73	09/90 → 03/94					
2.0 i	Petrol	73	09/90 → 02/92	CHASSIS: K1000099 →				
2.0 i	Petrol	85	09/86 → 03/94	CHASSIS: K1000099 →				
2.3 D	Diesel	54	09/86 → 03/94	CHASSIS: K1000099 →				
2.3 TD	Diesel	66	09/86 → 08/88	CHASSIS: K1000099 →				
2.4 i	Petrol	92	09/88 → 03/94				SVF015	B6
2.4 i	Petrol	92	09/88 → 03/94					
2.4 i	Petrol	92	09/88 → 03/94	CHASSIS: K1000099 →				
2.6 i	Petrol	110	09/90 → 03/94				SVF015	B6
2.6 i	Petrol	110	09/90 → 03/94					
2.6 i	Petrol	110	09/90 → 03/94	CHASSIS: K1000099 →				
3.0	Petrol	115	03/87 → 12/88					
3.0	Petrol	115	01/88 → 03/94					



TYPE



TYPE



TYPE

									PI024	J1
				SPA104	F1				PI024	J1
				SSA042	F2					
									ESS530	J1
									ESS530	J1
									PI024	J1
				SSA042	F2					
									ESS0057A	J1
				SPA104	F1		SAG093	H1	PI024	J1
				SPA104	F1		SAG093	H1		
				SSA042	F2					
				SSA042	F2					
									ESS530	J1
				SPA104	F1					
				SSA042	F2					
				SPA104	F1		SAG093	H1		
				SSA042	F2					
				SSA042	F2					
				SPA104	F1		SAG093	H1	PI024	J1
				SSA042	F2					
							SAG093	H1	PI024	J1
									ESS530	J1
									ESS530	J1
				SSA042	F2					
				SPA104	F1		SAG093	H1	PI024	J1
				SSA042	F2					
							SAG093	H1	PI024	J1
									ESS530	J1
									ESS530	J1
				SSA042	F2					
				SSA042	F2					
				SPA104	F1				PI024	J1
				SSA042	F2					
									ESS530	J1
				SPA104	F1				PI024	J1
				SSA042	F2					
									ESS530	J1
				SPA104	F1					
				SSA042	F2					



KW



TYPE



TYPE

OPEL

OMEGA A Station wagon (66_, 67_)

3.0	Petrol	130	03/87 → 09/90					
3.0	Petrol	130	03/87 → 12/89					
3.0	Petrol	130	01/88 → 09/90	CHASSIS: 0109242 →				
3.0	Petrol	115	03/87 → 03/94					
3.0	Petrol	115	03/87 → 12/87	CHASSIS: K1000099 →				
3.0	Petrol	130	03/87 → 12/89	CHASSIS: K1000099 →				
3.0 24V	Petrol	147	09/89 → 03/94			SVF015		B6
3.0 24V	Petrol	147	09/89 → 03/94	CHASSIS: P1132204 →				
3.0 24V	Petrol	147	09/89 → 03/94	CHASSIS: K1000099 →				
3.0 24V Omega 3000	Petrol	150	08/89 → 03/94	CHASSIS: K1000099 →				
3.0 Cat.	Petrol	130	01/88 → 03/94	CHASSIS: L1019855 →		SVF015		B6
3.0 Cat.	Petrol	130	03/87 → 12/90					
3.0 Cat.	Petrol	130	01/88 → 03/94					
3.0 Cat.	Petrol	130	01/88 → 03/94	CHASSIS: 0011335 →				
3.0 Cat.	Petrol	130	03/87 → 03/94					
3.0 Cat.	Petrol	130	12/87 → 03/94	CHASSIS: K1000099 →				

OMEGA B (25_, 26_, 27_)

2.0	Petrol	85	03/94 → 09/99			SVF015		B6
2.0	Petrol	85	03/94 → 08/98			SVF015		B6
2.0	Petrol	85	03/94 → 09/99					
2.0	Petrol	85	03/94 → 12/00					
2.0	Petrol	85	03/94 → 12/00					
2.0	Petrol	85	03/94 → 08/98	CHASSIS: X1093314 →				
2.0	Petrol	85	03/94 → 08/98	CHASSIS: X1093314 →				
2.0 16V	Petrol	100	03/94 → 09/99			B3397		B1
2.0 16V	Petrol	100	03/94 → 09/99			SVF015		B6
2.0 16V	Petrol	100	03/94 → 09/99	ENGINE: 14194717 →				
2.0 16V	Petrol	100	03/94 → 08/99	CHASSIS: X1093314 →				
2.0 DTI 16V	Diesel	74	09/97 → 09/00					
2.0 DTI 16V	Diesel	74	09/97 → 09/00					
2.2 16V	Petrol	106	09/99 → 07/03			TB0012		B3
2.2 16V	Petrol	106	09/99 → 07/03					
2.2 DTI 16V	Diesel	81	09/00 → 07/03					
2.2 DTI 16V	Diesel	88	09/00 → 07/03					
2.2 DTI 16V	Diesel	81	09/00 → 07/03					
2.2 DTI 16V	Diesel	88	09/00 → 07/03					
2.5 DTi	Diesel	110	09/01 → 07/03					
2.5 TD	Diesel	96	04/94 → 07/03					
2.5 V6	Petrol	125	03/94 → 09/00	CHASSIS: → T1999999		SVF015		B6
2.5 V6	Petrol	125	03/94 → 09/00					
2.5 V6	Petrol	125	03/94 → 09/00	CHASSIS: T1003098 →				
2.5 V6	Petrol	125	03/94 → 09/00	ENGINE: → 08149313				
2.5 V6	Petrol	125	03/94 → 09/00	CHASSIS: X1093314 →				
2.6 V6	Petrol	132	09/00 → 07/03					

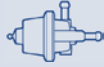

TYPE



TYPE



TYPE

				SPA104	F1					PI024	J1
				SPA129	F1						
				SSA042	F2						
										PI024	J1
										ESS530	J1
										ESS530	J1
										PI024	J1
				SSA042	F2						
										ESS530	J1
										ESS530	J1
				SPA104	F1						
				SPA129	F1						
				SSA042	F2						
										PI024	J1
										ESS530	J1
				SPA104	F1						
				SSA042	F2						
				SPA104	F1						
				SSA042	F2						
										ESS532	J1
										ESS532	J1
				ATS12	F2		SAC046	H2			
				SSA042	F2		SAD012	H3			
							SAG107	H1			
										ESS532	J1
				SPA171	F1		SAG021	H1			
							SAG021-1	H1			
				SPA171	F1		SAC032	H2	BAE680BK	ESS532	J1
				SSA042	F2						
				SPA171	F1		SAG021	H1			
				SPA171	F1		SAG021	H1			
							SAG021-1	H1			
							SAG021-1	H1			
										PI025	J1
	APS42										
				SPA104	F1						
				SSA042	F2						
							SAG055	H1			
										ESS532	J1
				SPA171	F1		SAC021	H2	BAE680BJ	ESS530	J1



KW



TYPE



TYPE

OPEL

OMEGA B (25_, 26_, 27_)

2.6 V6	Petrol	132	09/00 → 07/03	ENGINE: → 08149313				
3.0 V6	Petrol	155	04/94 → 02/01	CHASSIS: → T1999999			SVF015	B6
3.0 V6	Petrol	155	04/94 → 02/01					
3.0 V6	Petrol	155	04/94 → 02/01	CHASSIS: T1003098 →				
3.0 V6	Petrol	155	04/94 → 02/01	ENGINE: → 08149313				
3.0 V6	Petrol	155	04/94 → 02/01	CHASSIS: X1093314 → Y1999999				
3.2 V6	Petrol	160	02/01 → 07/03					
3.2 V6	Petrol	160	02/01 → 07/03	ENGINE: → 08149313				

OMEGA B Station wagon (21_, 22_, 23_)

2.0	Petrol	85	03/94 → 09/99				SVF015	B6
2.0	Petrol	85	03/94 → 09/99					
2.0	Petrol	85	03/94 → 08/98	CHASSIS: X1093314 →				
2.0 16V	Petrol	100	03/94 → 09/99				B3397	B1
2.0 16V	Petrol	100	03/94 → 09/99				SVF015	B6
2.0 16V	Petrol	100	03/94 → 09/99	ENGINE: 14194717 →				
2.0 16V	Petrol	100	03/94 → 08/99	CHASSIS: X1093314 →				
2.0 DTI 16V	Diesel	74	09/97 → 09/00					
2.0 DTI 16V	Diesel	74	09/97 → 09/00					
2.2 16V	Petrol	106	09/99 → 07/03				TB0012	B3
2.2 DTI 16V	Diesel	81	09/00 → 07/03					
2.2 DTI 16V	Diesel	88	09/00 → 07/03					
2.2 DTI 16V	Diesel	81	09/00 → 07/03					
2.2 DTI 16V	Diesel	88	09/00 → 07/03					
2.5 DTi	Diesel	110	09/01 → 07/03					
2.5 TD	Diesel	96	04/94 → 07/01					
2.5 V6	Petrol	125	03/94 → 09/00	CHASSIS: → T1999999			SVF015	B6
2.5 V6	Petrol	125	03/94 → 09/00					
2.5 V6	Petrol	125	03/94 → 09/00	CHASSIS: T1003098 →				
2.5 V6	Petrol	125	03/94 → 09/00	ENGINE: → 08149313				
2.5 V6	Petrol	125	03/94 → 09/00	CHASSIS: X1093314 →				
2.6	Petrol	138	05/94 → 05/99					
2.6 V6	Petrol	132	09/00 → 07/03					
2.6 V6	Petrol	132	09/00 → 07/03	ENGINE: → 08149313				
3.0 V6	Petrol	155	04/94 → 02/01	CHASSIS: → T1999999			SVF015	B6
3.0 V6	Petrol	155	04/94 → 02/01					
3.0 V6	Petrol	155	04/94 → 02/01	CHASSIS: T1003098 →				
3.0 V6	Petrol	155	04/94 → 02/01	ENGINE: → 08149313				
3.0 V6	Petrol	155	04/94 → 02/01	CHASSIS: X1093314 → Y1999999				
3.2 V6	Petrol	160	02/01 → 07/03					
3.2 V6	Petrol	160	02/01 → 07/03	ENGINE: → 08149313				

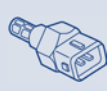
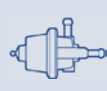

TYPE

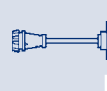

TYPE



TYPE

						SAG055	H1			
					SPA104	F1				
					SSA042	F2				
							SAG055	H1		
										ESS532
										J1
					SPA171	F1	SAC021	H2	BAE680BJ	ESS530
							SAG055	H1		J1
					SPA104	F1				
					SSA042	F2				
										ESS532
										J1
					ATS12	F2	SAC046	H2		
					SSA042	F2	SAD012	H3		
							SAG107	H1		
										ESS532
										J1
					SPA171	F1	SAG021	H1		
							SAG021-1	H1		
					SPA171	F1	SAC032	H2	BAE680BK	ESS532
					SPA171	F1	SAG021	H1		J1
					SPA171	F1	SAG021	H1		
							SAG021-1	H1		
							SAG021-1	H1		
										PI025
										J1
	APS42									
					SPA104	F1				
					SSA042	F2				
							SAG055	H1		
										ESS532
										J1
					SPA171	F1				
					SPA171	F1	SAC021	H2	BAE680BJ	ESS530
							SAG055	H1		J1
					SPA104	F1				
					SSA042	F2				
							SAG055	H1		
										ESS532
										J1
					SPA171	F1	SAC021	H2	BAE680BJ	ESS530
							SAG055	H1		J1



KW

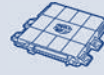

TYPE



TYPE

OPEL

SENATOR B (29_)

2.5 i	Petrol	103	09/90 → 09/93					
2.5 i	Petrol	103	09/90 → 09/93	CHASSIS: 0053436 →				
2.6 i	Petrol	110	09/90 → 09/93			SVF015	B6	
2.6 i	Petrol	110	09/90 → 09/93					
2.6 i	Petrol	110	09/90 → 09/93	CHASSIS: K1000099 →				
3.0	Petrol	115	09/87 → 09/93					
3.0	Petrol	115	09/87 → 09/93					
3.0	Petrol	130	01/88 → 09/90					
3.0	Petrol	130	01/88 → 09/90	CHASSIS: 0109242 →				
3.0	Petrol	115	09/87 → 09/93	CHASSIS: K1000099 →				
3.0	Petrol	130	01/88 → 12/89	CHASSIS: K1000099 →				
3.0 24V	Petrol	150	09/89 → 09/93			SVF015	B6	
3.0 24V	Petrol	150	09/89 → 09/93					
3.0 24V	Petrol	150	09/89 → 09/93	CHASSIS: K1000099 →				

SIGNUM

1.8	Petrol	103	09/05 →			TB0012	B3	
1.8	Petrol	90	05/03 →			TB0012	B3	
1.8	Petrol	103	09/05 →					
1.8	Petrol	90	05/03 →					
1.8	Petrol	90	05/03 →					
1.9 CDTI	Diesel	74	08/05 →	ENGINE: Z19DT		48CPD1	B3	
1.9 CDTI	Diesel	88	04/04 →	ENGINE: Z19DT		48CPD1	B3	
1.9 CDTI	Diesel	110	04/04 →					
1.9 CDTI	Diesel	88	04/04 →					
1.9 CDTI	Diesel	110	04/04 →					
1.9 CDTI	Diesel	74	08/05 →					
2.0 DTI	Diesel	74	05/03 →			48CPD4	B3	
2.0 DTI	Diesel	74	05/03 →	ENGINE: → 17G23740				
2.0 DTI	Diesel	74	05/03 →	ENGINE: → 17G23740				
2.0 DTI	Diesel	74	05/03 → 09/05	ENGINE: 17G23741 →				
2.0 Turbo	Petrol	129	05/03 →					
2.2 direct	Petrol	114	05/03 →			TB0014	B3	
2.2 direct	Petrol	114	05/03 →					
2.2 direct	Petrol	114	05/03 →					
2.2 direct	Petrol	114	05/03 → 09/08					
2.2 DTI	Diesel	92	05/03 →					
2.2 DTI	Diesel	92	05/03 →	ENGINE: → 17G23740				
2.2 DTI	Diesel	92	05/03 →	ENGINE: → 17G23740				
2.8 V6 Turbo	Petrol	169	09/05 →					
2.8 V6 Turbo	Petrol	169	09/05 →					
2.8 V6 Turbo	Petrol	184	01/06 →					
2.8 V6 Turbo	Petrol	169	09/05 → 09/07					
2.8 V6 Turbo	Petrol	184	01/06 → 09/08					
3.0 V6 CDTI	Diesel	130	05/03 →					



TYPE

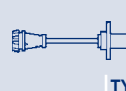

TYPE



TYPE

				SPA104	F1				PI024	J1
				SSA042	F2					
				SPA104	F1					
				SSA042	F2					
									ESS530	J1
				SPA104	F1				PI024	J1
				SSA042	F2					
				SPA104	F1				PI024	J1
				SSA042	F2					
									ESS530	J1
									ESS530	J1
				SPA104	F1					
				SSA042	F2					
									ESS530	J1
						SAA103	SAC062	H2		
							SAC071	H2	ESS0089A	J1
							SAD033	H3		
							SAD007	H3		
							SAG120	H1		
				ATS20	F2		SAC068	H2	GA2125	J2
				ATS20	F2		SAC088	H2		
							SAG133	H1		
							SAC088	H2		
				SPA171	F1					
							SAG021	H1		
							SAG021-1	H1		
							SAG069	H1		
				SPA171	F1				ESS0089A	J1
	APS44			SPA115	F1		SAC062	H2	ESS0089A	J1
							SAD015	H3	GA2100	J2
							SAG083	H1		
									BAE680BM	
				SPA171	F1					
							SAG021	H1		
							SAG021-1	H1		
				ATS10	F2		SAD004	H3		
				SPA171	F1					
				SPA171	F1		SAD004	H3		
									BAE680CF	
									BAE680CF	
				SPA115	F1					



KW



TYPE



TYPE

OPEL

SIGNUM

3.0 V6 CDTI	Diesel	135	09/05 →					
3.2 V6	Petrol	155	05/03 →					
3.2 V6	Petrol	155	05/03 → 09/05					

SINTRA

2.2 DTI	Diesel	85	07/97 → 04/99					
2.2 DTI	Diesel	85	07/97 → 04/99					

SPEEDSTER

2.0 Turbo	Petrol	147	04/03 →					
2.0 Turbo	Petrol	147	04/03 →					
2.0 Turbo	Petrol	147	04/03 → 09/05					
2.0 Turbo	Petrol	147	04/03 → 09/06					
2.2	Petrol	108	09/00 →					
2.2	Petrol	108	09/00 →	ENGINE: Z22SE				

TIGRA (95_)

1.4 16V	Petrol	63	08/97 → 12/00			SVF013	B6
1.4 16V	Petrol	66	07/94 → 12/00			B3215	B1
1.4 16V	Petrol	66	07/94 → 12/00			SVF013	B6
1.4 16V	Petrol	63	08/97 → 12/00				
1.4 16V	Petrol	63	08/97 → 12/00				
1.4 16V	Petrol	66	07/94 → 12/00	CHASSIS: → V6999999			
1.4 16V	Petrol	63	08/97 → 12/00	CHASSIS: S3000001 →			
1.4 16V	Petrol	66	07/94 → 12/00	CHASSIS: S3000001 →			
1.4 16V	Petrol	63	08/97 → 12/00	ENGINE: C14SEL			
1.4 16V	Petrol	66	07/94 → 12/00	ENGINE: X14XE			
1.4 16V	Petrol	63	08/97 → 08/99				
1.4 16V	Petrol	66	08/94 → 08/99				
1.6 16V	Petrol	74	08/97 → 08/98			B3215	B1
1.6 16V	Petrol	74	08/97 → 08/98			SVF013	B6
1.6 16V	Petrol	78	07/94 → 08/98			B3215	B1
1.6 16V	Petrol	78	07/94 → 08/98			SVF013	B6
1.6 16V	Petrol	74	08/97 → 08/98				
1.6 16V	Petrol	78	07/94 → 08/98	CHASSIS: → V6999999			
1.6 16V	Petrol	74	08/97 → 08/98	CHASSIS: S3000001 →			
1.6 16V	Petrol	78	07/94 → 08/98	CHASSIS: S3000001 →			
1.6 16V	Petrol	74	08/97 → 08/98	ENGINE: C16SEL			
1.6 16V	Petrol	78	07/94 → 08/98	ENGINE: X16XE			
1.6 16V	Petrol	78	08/94 → 08/98				

TIGRA TwinTop

1.3 CDTI	Diesel	51	06/04 →				
1.3 CDTI	Diesel	51	06/04 →				
1.4	Petrol	66	06/04 →				
1.4	Petrol	66	06/04 →				
1.4	Petrol	66	09/04 →				
1.4	Petrol	66	06/04 → 12/09				



TYPE

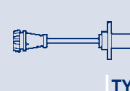

TYPE



TYPE

				SPA115	F1						
				SPA171	F1		SAC021	H2		ESS0089A	J1
									BAE680CH		
				SSA042	F2		SAG021	H1			
							SAG021-1	H1			
				ATS10	F2		SAC035	H2			
				SPA171	F1		SAG057	H1			
				SPA103	F1					BAE680BL	
	APS44			SPA115	F1		SAG083	H1			
										BAE608N	
	APS45		ATS17	F2			SAC082	H2			
	APS45		ATS17	F2			SAC082	H2		SUA507	J1
			SSA042	F2			SAD027	H3			
			SPA171	F1							
			SSA042	F2							
			SPA104	F1							
							SAG124	H1			
							SAG124	H1			
										BAE608I	
										BAE608I	
										ESS532	J1
										ESS532	J1
	APS45		ATS17	F2			SAC082	H2		ESS532	J1
			SPA171	F1						SUA507	J1
	APS45		ATS17	F2			SAC082	H2		SUA507	J1
			SSA042	F2			SAD027	H3			
			SSA042	F2							
			SPA104	F1							
							SAG124	H1			
							SAG124	H1			
										BAE608I	
										BAE608I	
										ESS532	J1
	APS23						SAC093	H2		ESS0070A	J1
							SAG025	H1			
FEI0004			SPA171	F1	SAA103		SAC092	H2		ESS0089A	J1
							SAD026	H3			
			SPA103	F1			SAG019	H1			
										BAE680AL	



KW



TYPE



TYPE

OPEL

TIGRA TwinTop

1.8	Petrol	92	06/04 →					TB0012	B3
1.8	Petrol	92	06/04 →						
1.8	Petrol	92	06/04 →						

VECTRA A (86_, 87_)

1.4 S	Petrol	55	09/88 → 06/92						
1.6	Petrol	60	09/88 → 05/93						
1.6 i	Petrol	52	09/93 → 11/95					B3253	B1
1.6 i	Petrol	52	09/93 → 11/95					SVF014	B6
1.6 i	Petrol	55	09/88 → 11/95					SVF014	B6
1.6 i	Petrol	55	09/88 → 10/90					B3253	B1
1.6 i	Petrol	55	09/93 → 11/95					B3253	B1
1.6 i	Petrol	55	09/93 → 11/95					SVF014	B6
1.6 i	Petrol	55	01/95 → 11/95						
1.6 i	Petrol	52	09/93 → 11/95	ENGINE: X16SZ					
1.6 i	Petrol	52	09/93 → 08/95						
1.6 i	Petrol	55	09/93 → 08/95						
1.7 TD	Diesel	60	03/90 → 11/95						
1.8 i Cat.	Petrol	66	03/90 → 11/95					B3253	B1
1.8 i Cat.	Petrol	66	03/90 → 11/95	CHASSIS: → L1000123					
1.8 i Cat.	Petrol	66	03/90 → 11/95	CHASSIS: → P7999999					
1.8 S	Petrol	65	09/88 → 07/89	CHASSIS: → L1000123					
1.8 S 4x4	Petrol	65	01/89 → 07/89	CHASSIS: → L1000123					
2.0	Petrol	74	09/88 → 09/89					SVF012	B6
2.0	Petrol	74	09/88 → 09/89						
2.0 i	Petrol	85	09/88 → 08/90					SVF012	B6
2.0 i	Petrol	85	09/90 → 10/90					SVF015	B6
2.0 i	Petrol	95	09/88 → 08/90					SVF012	B6
2.0 i	Petrol	95	09/90 → 09/92					SVF015	B6
2.0 i	Petrol	85	09/88 → 10/90	CHASSIS: → L1000123					
2.0 i	Petrol	95	09/88 → 09/92	CHASSIS: → L1000123					
2.0 i	Petrol	85	09/88 → 10/90	CHASSIS: → P7999999					
2.0 i	Petrol	95	09/88 → 09/92						
2.0 i	Petrol	85	09/88 → 10/90						
2.0 i	Petrol	85	09/88 → 10/90						
2.0 i	Petrol	95	09/88 → 09/92						
2.0 i 16V	Petrol	100	06/94 → 11/95					B3397	B1
2.0 i 16V	Petrol	100	06/94 → 08/95					SVF015	B6
2.0 i 16V	Petrol	100	06/94 → 11/95						
2.0 i 16V	Petrol	100	06/94 → 08/95						
2.0 i 16V 4x4	Petrol	100	06/94 → 11/95					B3397	B1
2.0 i 16V 4x4	Petrol	100	06/94 → 08/95					SVF015	B6
2.0 i 16V 4x4	Petrol	100	06/94 → 11/95						
2.0 i 16V 4x4	Petrol	100	06/94 → 08/95						
2.0 i 4x4	Petrol	85	01/89 → 08/90					SVF012	B6



TYPE

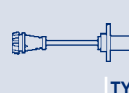

TYPE



TYPE

							SAC071	H2		ESS0089A	J1
							SAD007	H3			
							SAG120	H1			
				SSA042	F2						
				SSA042	F2						
		APS45		SSA042	F2		SAG141	H1			
		APS45		SSA042	F2						
		APS45								ESS525	J1
		APS45					SAG093	H1			
				SPA104	F1						
										BAE608I	
										ESS525	J1
										ESS525	J1
				SPA130	F1						
		APS45								ESS525	J1
				SSA042	F2						
							SAG093	H1			
				SSA042	F2						
				SSA042	F2						
										ESS530	J1
										PI024	J1
				SSA042	F2						
				SSA042	F2						
							SAG093	H1			
							SAG093	H1		ESS530	J1
										ESS530	J1
										PI024	J1
										PI024	J1
				ATS12	F2		SAC061	H2			
				SSA042	F2		SAD012	H3			
										ESS530	J1
				ATS12	F2		SAC061	H2			
				SSA042	F2		SAD012	H3			
										ESS530	J1



KW



TYPE



TYPE

OPEL

VECTRA A (86_, 87_)

2.0 i 4x4	Petrol	85	09/90 → 10/90				SVF015	B6
2.0 i 4x4	Petrol	95	01/89 → 08/90				SVF012	B6
2.0 i 4x4	Petrol	95	09/90 → 09/92				SVF015	B6
2.0 i 4x4	Petrol	85	01/89 → 10/90	CHASSIS: → L1000123				
2.0 i 4x4	Petrol	95	01/89 → 09/92	CHASSIS: → L1000123				
2.0 i 4x4	Petrol	85	01/89 → 10/90	CHASSIS: → P7999999				
2.0 i 4x4	Petrol	95	01/89 → 09/92					
2.0 i 4x4	Petrol	85	01/89 → 10/90					
2.0 i Turbo 4x4	Petrol	150	06/94 → 11/95					
2.0 i Turbo 4x4	Petrol	150	06/94 → 08/95	CHASSIS: S1008893 →				
2.5 CD 4x4	Petrol	125	01/93 → 08/95					
2.5 V6	Petrol	125	02/93 → 08/95				SVF015	B6
2.5 V6	Petrol	125	02/93 → 11/95	CHASSIS: S1035179 →				
2.5 V6	Petrol	125	02/93 → 08/95					
2000 16V 4x4	Petrol	110	01/89 → 10/90					
2000 16V 4x4	Petrol	110	08/89 → 10/90	CHASSIS: S1008893 →				
2000/GT 16V	Petrol	110	01/89 → 06/94					
2000/GT 16V	Petrol	110	08/89 → 06/94					

VECTRA A 2 volumi /Coda spiovente (88_, 89_)

1.4 S	Petrol	55	04/88 → 06/92					
1.6 i	Petrol	55	09/93 → 11/95				B3253	B1
1.6 i	Petrol	55	09/93 → 11/95				SVF014	B6
1.6 i	Petrol	55	09/93 → 08/95					
1.6 i Cat.	Petrol	55	09/88 → 11/95				B3253	B1
1.6 i Cat.	Petrol	55	09/88 → 11/95				SVF014	B6
1.6 i Cat.	Petrol	55	09/88 → 08/95					
1.6 S	Petrol	60	09/88 → 05/93					
1.7 TD	Diesel	60	03/90 → 11/95					
1.8 i Cat.	Petrol	66	03/90 → 11/95				SVF014	B6
1.8 i Cat.	Petrol	66	03/90 → 11/95	CHASSIS: → L1000123				
1.8 i Cat.	Petrol	66	03/90 → 11/95	CHASSIS: → P7999999				
1.8 S	Petrol	65	09/88 → 07/89	CHASSIS: → L1000123				
2.0	Petrol	74	09/88 → 09/89				SVF012	B6
2.0	Petrol	74	04/88 → 09/89					
2.0	Petrol	74	08/88 → 09/89					
2.0 i	Petrol	85	09/88 → 08/90				SVF012	B6
2.0 i	Petrol	85	09/90 → 10/90				SVF015	B6
2.0 i	Petrol	85	09/88 → 10/90	CHASSIS: → L1000123				
2.0 i	Petrol	85	09/88 → 10/90	CHASSIS: → P7999999				
2.0 i	Petrol	85	09/88 → 10/90					
2.0 i	Petrol	85	09/88 → 10/90					
2.0 i 16V	Petrol	100	06/94 → 11/95				B3397	B1
2.0 i 16V	Petrol	100	06/94 → 08/95				SVF015	B6
2.0 i 16V	Petrol	100	06/94 → 11/95					



KW



TYPE



TYPE

OPEL

VECTRA A 2 volumi /Coda spiovente (88_, 89_)

2.0 i 16V	Petrol	110	02/89 → 10/90				
2.0 i 16V	Petrol	100	06/94 → 08/95				
2.0 i 16V	Petrol	110	08/89 → 10/90	ENGINE: 20XEJ			
2.0 i GT	Petrol	95	09/88 → 08/90			SVF012	B6
2.0 i GT	Petrol	95	09/90 → 08/95			SVF015	B6
2.0 i GT	Petrol	95	09/88 → 11/95	CHASSIS: → L1000123			
2.0 i GT	Petrol	95	09/88 → 11/95				
2.0 i GT	Petrol	95	09/88 → 08/95				
2.5 V6	Petrol	125	02/93 → 08/95			SVF015	B6
2.5 V6	Petrol	125	02/93 → 11/95	CHASSIS: S1035179 →			
2.5 V6	Petrol	125	02/93 → 08/95				

VECTRA B (36_)

1.6 i	Petrol	55	10/95 → 04/02			SVF014	B6
1.6 i	Petrol	55	10/95 → 04/02			SVF014	B6
1.6 i	Petrol	55	10/95 → 04/02				
1.6 i	Petrol	55	10/95 → 04/02	ENGINE: X16SZR-X16XEL			
1.6 i	Petrol	55	10/95 → 04/02	ENGINE: X16SZR-X16XEL			
1.6 i	Petrol	55	10/95 → 04/02	ENGINE: Z16XE-Y16XE-X16XEL			
1.6 i	Petrol	55	10/95 → 04/02	ENGINE: Z16XE-Y16XE-X16XEL			
1.6 i 16V	Petrol	74	10/95 → 04/02			B3215	B1
1.6 i 16V	Petrol	74	10/95 → 04/02			SVF013	B6
1.6 i 16V	Petrol	74	10/95 → 04/02				
1.6 i 16V	Petrol	74	11/95 → 04/02	CHASSIS: W1285447 →, W7154259 →			
1.6 i 16V	Petrol	74	10/95 → 04/02	ENGINE: X16XEL-Y16XE			
1.8 i 16V	Petrol	85	10/95 → 09/00			B3397	B1
1.8 i 16V	Petrol	85	10/95 → 09/00			SVF015	B6
1.8 i 16V	Petrol	92	09/00 → 04/02			TB0012	B3
1.8 i 16V	Petrol	85	10/95 → 09/00	ENGINE: → 25037067			
1.8 i 16V	Petrol	85	09/98 → 09/00				
1.8 i 16V	Petrol	92	09/00 → 04/02				
1.8 i 16V	Petrol	85	10/95 → 09/00	ENGINE: X18XE			
2.0 DTI 16V	Diesel	74	09/00 → 04/02				
2.0 DTI 16V	Diesel	74	06/97 → 04/02				
2.0 DTI 16V	Diesel	74	09/97 → 08/00				
2.0 DTI 16V	Diesel	74	06/97 → 04/02				
2.0 i	Petrol	82	10/95 → 02/02				
2.0 i 16V	Petrol	100	10/95 → 09/00			B3397	B1
2.0 i 16V	Petrol	100	10/95 → 09/00			SVF015	B6
2.0 i 16V	Petrol	100	10/95 → 09/00				
2.2 DTI 16V	Diesel	92	09/00 → 04/02				
2.2 DTI 16V	Diesel	92	09/00 → 04/02				

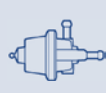

TYPE

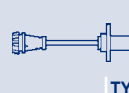

TYPE



TYPE

						SAG093	H1		PI024	J1
									ESS530	J1
									ESS530	J1
					SSA042	F2				
						SAG093	H1		PI024	J1
									ESS530	J1
						SAC025	H2			
									ESS530	J1
		APS45			SSA042	F2				
		APS45			SPA104	F1	SAD027	H3		
					SSA042	F2	SAG141	H1		
									BAE608I	
									BAE608I	
									BAE608F	
									BAE608F	
		APS44			ATS17	F2	SAC080	H2	BAE608H	
					SPA104	F1	SAD027	H3		
					SSA042	F2	SAG020	H1		
							SAG116	H1		
									ESS532	J1
					ATS12	F2	SAD012	H3		
							SAG107	H1		
							SAC071	H2		
							SAC061	H2		
							SAG116	H1		
							SAG120	H1		
									ESS532	J1
		APS26								
					SPA171	F1	SAG021	H1		
					SPA103	F1				
							SAG021-1	H1		
									ESS532	J1
					ATS12	F2	SAC046	H2	ESS532	J1
							SAD012	H3		
							SAG107	H1		
		APS26			SPA103	F1	SAG021	H1		
							SAG021-1	H1		

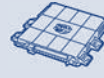

KW

TYPE

TYPE
OPEL
VECTRA B (36_)

2.2 i 16V	Petrol	108	09/00 → 04/02				B3397	B1
2.2 i 16V	Petrol	108	09/00 → 04/02					
2.2 i 16V	Petrol	108	09/00 → 04/02	ENGINE: Z22SE				
2.5 i V6	Petrol	125	10/95 → 08/97	CHASSIS: → V7999999			SVF015	B6
2.5 i V6	Petrol	125	09/97 → 09/00	CHASSIS: W1000001 →			SVF016	B6
2.5 i V6	Petrol	125	10/95 → 09/00					
2.6 i V6	Petrol	125	09/00 → 04/02					
i 500 2.5	Petrol	143	05/98 → 09/00				SVF016	B6

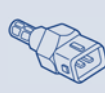
VECTRA B 2 volumi /Coda spiovente (38_)

1.6 i	Petrol	55	10/95 → 07/03				SVF014	B6
1.6 i	Petrol	55	10/95 → 07/03				SVF014	B6
1.6 i	Petrol	55	10/95 → 07/03					
1.6 i	Petrol	55	10/95 → 07/03	ENGINE: X16SZR-X16XEL				
1.6 i	Petrol	55	10/95 → 07/03	ENGINE: X16SZR-X16XEL				
1.6 i	Petrol	55	10/95 → 07/03	ENGINE: Z16XE-Y16XE-X16XEL				
1.6 i	Petrol	55	10/95 → 07/03	ENGINE: Z16XE-Y16XE-X16XEL				
1.6 i 16V	Petrol	74	10/95 → 07/02				SVF013	B6
1.6 i 16V	Petrol	74	10/95 → 07/02					
1.6 i 16V	Petrol	74	10/95 → 07/02					
1.6 i 16V	Petrol	74	11/95 → 07/02	CHASSIS: W1285447 →, W7154259 →				
1.6 i 16V	Petrol	74	10/95 → 07/02	ENGINE: X16XEL-Y16XE				
1.8 i 16V	Petrol	85	10/95 → 09/00				B3397	B1
1.8 i 16V	Petrol	85	10/95 → 09/00				SVF015	B6
1.8 i 16V	Petrol	92	09/00 → 07/03				TB0012	B3
1.8 i 16V	Petrol	85	10/95 → 09/00	ENGINE: → 25037067				
1.8 i 16V	Petrol	85	09/98 → 09/00					
1.8 i 16V	Petrol	92	09/00 → 07/03					
1.8 i 16V	Petrol	85	10/95 → 09/00	ENGINE: X18XE				
2.0 DTI 16V	Diesel	74	09/00 → 07/03					
2.0 DTI 16V	Diesel	74	06/97 → 07/03					
2.0 DTI 16V	Diesel	74	09/97 → 08/00					
2.0 DTI 16V	Diesel	74	06/97 → 07/03					
2.0 i	Petrol	82	10/95 → 02/02					
2.0 i 16V	Petrol	100	10/95 → 09/00				B3397	B1
2.0 i 16V	Petrol	100	10/95 → 09/00				SVF015	B6
2.0 i 16V	Petrol	100	10/95 → 09/00					
2.2 DTI 16V	Diesel	92	09/00 → 07/03					
2.2 DTI 16V	Diesel	92	09/00 → 07/03					
2.2 DTI 16V	Diesel	92	09/00 → 09/02					
2.2 i 16V	Petrol	108	09/00 → 07/03					
2.2 i 16V	Petrol	108	09/00 → 07/03					



TYPE

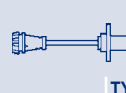

TYPE



TYPE

	APS44		SPA115	F1		SAC061	H2		ESS532	J1
						SAG083	H1			
								BAE608N		
			SPA104	F1		SAC025	H2		ESS532	J1
			SPA103	F1		SAC021	H2	BAE680BJ	ESS532	J1
						SAC025	H2		ESS532	J1
	APS45		SSA042	F2						
	APS45		SPA104	F1		SAD027	H3			
			SSA042	F2		SAG141	H1			
								BAE608I		
								BAE608I		
								BAE608F		
								BAE608F		
	APS44		ATS17	F2		SAC080	H2	BAE608H		
			SPA104	F1		SAD027	H3			
			SSA042	F2		SAG020	H1			
						SAG116	H1			
									ESS532	J1
			ATS12	F2		SAD012	H3			
						SAG107	H1			
						SAC071	H2			
						SAC061	H2			
						SAG116	H1			
						SAG120	H1			
									ESS532	J1
	APS26									
			SPA171	F1		SAG021	H1			
			SPA103	F1						
						SAG021-1	H1			
									ESS532	J1
			ATS12	F2		SAC046	H2		ESS532	J1
						SAD012	H3			
						SAG107	H1			
	APS26		SPA171	F1		SAG021	H1			
						SAG021-1	H1			
			SPA103	F1						
	APS44		SPA115	F1		SAC061	H2		ESS532	J1
						SAG083	H1			

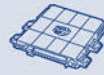
KW

TYPE

TYPE
OPEL
VECTRA B 2 volumi /Coda spiovente (38_)

2.2 i 16V	Petrol	108	09/00 → 09/02					
2.2 i 16V	Petrol	108	09/00 → 07/03	ENGINE: Z22SE				
2.5	Petrol	144	10/99 → 06/00					
2.5 i V6	Petrol	125	10/95 → 08/97	CHASSIS: → V7999999			SVF015	B6
2.5 i V6	Petrol	125	09/97 → 09/00	CHASSIS: W1000001 →			SVF016	B6
2.5 i V6	Petrol	125	10/95 → 09/00					
2.6 i V6	Petrol	125	09/00 → 07/03					
2.6 i V6	Petrol	125	09/00 → 09/02					
2.6 i V6	Petrol	125	09/00 → 09/02					

VECTRA B Station wagon (31_)

1.6 i	Petrol	55	11/96 → 06/00				SVF014	B6
1.6 i	Petrol	55	11/96 → 06/00	ENGINE: X16SZR-X16XEL				
1.6 i	Petrol	55	11/96 → 06/00	ENGINE: Z16XE-Y16XE-X16XEL				
1.8 i 16V	Petrol	92	09/00 → 07/03				TB0012	B3
1.8 i 16V	Petrol	92	09/00 → 07/03					
2.0 DTI 16V	Diesel	74	09/00 → 07/03					
2.0 DTI 16V	Diesel	74	06/97 → 07/03					
2.0 DTI 16V	Diesel	74	09/97 → 08/00					
2.0 DTI 16V	Diesel	74	06/97 → 07/03					
2.0 i	Petrol	82	11/96 → 02/02					
2.2 DTI 16V	Diesel	92	09/00 → 07/03					
2.2 DTI 16V	Diesel	92	09/00 → 07/03					
2.2 DTI 16V	Diesel	92	09/00 → 09/02					
2.2 i 16V	Petrol	108	09/00 → 07/03					
2.2 i 16V	Petrol	108	09/00 → 07/03	ENGINE: Z22SE				
2.6 i V6	Petrol	125	09/00 → 07/03					
2.6 i V6	Petrol	125	09/00 → 09/02					
2.6 i V6	Petrol	125	09/00 → 09/02					
i 500 2.5	Petrol	143	05/98 → 09/00				SVF016	B6
i 500 2.5	Petrol	143	05/98 → 06/00					

VECTRA C

1.6	Petrol	77	01/06 →					
1.6	Petrol	77	01/06 →					
1.6 16V	Petrol	74	06/04 →					
1.6 16V	Petrol	74	06/04 →					
1.6 16V	Petrol	74	06/04 →					
1.6 16V	Petrol	74	06/04 →	ENGINE: Z16XE				
1.8	Petrol	103	01/06 →				TB0012	B3
1.8	Petrol	81	04/02 →				TB0012	B3
1.8	Petrol	103	01/06 →					
1.8	Petrol	81	04/02 →					
1.8	Petrol	81	04/02 →					
1.8 16V	Petrol	90	04/02 →				TB0012	B3



TYPE

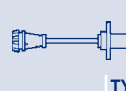

TYPE



TYPE

						SAG107	H1			
								BAE608N		
									ESS532	J1
					SPA104	F1	SAC025	H2	ESS532	J1
					SPA171	F1	SAC021	H2		
					SPA103	F1			BAE680BJ	
									ESS532	J1
	APS45		SSA042	F2						
								BAE608I		
								BAE608F		
						SAC071	H2			
						SAG120	H1			
	APS26									
					SPA171	F1	SAG021	H1		
					SPA103	F1				
							SAG021-1	H1		
									ESS532	J1
	APS26		SPA171	F1		SAG021	H1			
						SAG021-1	H1			
			SPA103	F1						
	APS44		SPA115	F1		SAG083	H1		ESS532	J1
								BAE608N		
			SPA171	F1		SAC021	H2			
			SPA103	F1				BAE680BJ		
									ESS532	J1
						SAC025	H2			
									ESS532	J1
			SPA171	F1	SAA103	SAC057	H2		ESS0089A	J1
						SAG020	H1			
	APS44		ATS17	F2		SAC080	H2		ESS0089A	J1
			SPA171	F1		SAD027	H3			
						SAG020	H1			
								BAE608F		
					SAA103	SAC062	H2			
						SAC071	H2		ESS0089A	J1
						SAD033	H3			
						SAD007	H3			
						SAG120	H1			
						SAC071	H2		ESS0089A	J1



KW



TYPE



TYPE

OPEL

VECTRA C

1.8 16V	Petrol	90	04/02 →					
1.8 16V	Petrol	90	04/02 →					
1.9 CDTI	Diesel	110	04/04 →			48CPD4	B3	
1.9 CDTI	Diesel	74	10/05 →	ENGINE: Z19DT		48CPD1	B3	
1.9 CDTI	Diesel	88	04/04 →	ENGINE: Z19DT		48CPD1	B3	
1.9 CDTI	Diesel	110	04/04 →					
1.9 CDTI	Diesel	74	10/05 →					
1.9 CDTI	Diesel	88	04/04 →					
2.0 16V Turbo	Petrol	129	03/03 →					
2.0 DTI 16V	Diesel	74	04/02 →					
2.0 DTI 16V	Diesel	74	04/02 →	ENGINE: → 17G23740				
2.0 DTI 16V	Diesel	74	04/02 →	ENGINE: → 17G23740				
2.0 DTI 16V	Diesel	74	04/02 → 09/05	ENGINE: 17G23741 →				
2.2 16V	Petrol	108	04/02 →					
2.2 16V	Petrol	108	04/02 →	ENGINE: Z22SE				
2.2 16V	Petrol	108	04/02 → 09/05					
2.2 direct	Petrol	114	10/03 →			TB0014	B3	
2.2 direct	Petrol	114	10/03 →					
2.2 direct	Petrol	114	10/03 →					
2.2 direct	Petrol	114	10/03 →	ENGINE: Z22SE				
2.2 direct	Petrol	114	10/03 → 10/08					
2.2 DTI 16V	Diesel	92	04/02 →					
2.2 DTI 16V	Diesel	92	04/02 →	ENGINE: → 17G23740				
2.2 DTI 16V	Diesel	92	04/02 →	ENGINE: → 17G23740				
2.2 DTI 16V	Diesel	92	04/02 → 09/05	ENGINE: 17G23741 →				
2.8 V6 Turbo	Petrol	169	08/05 →					
2.8 V6 Turbo	Petrol	169	08/05 →					
2.8 V6 Turbo	Petrol	184	08/06 →					
2.8 V6 Turbo	Petrol	188	08/05 →					
2.8 V6 Turbo	Petrol	188	08/05 →					
2.8 V6 Turbo	Petrol	169	08/05 → 09/07					
2.8 V6 Turbo	Petrol	184	08/06 → 10/08					
2.8 V6 Turbo	Petrol	188	08/05 → 10/08					
3.0 CDTI	Diesel	130	06/03 →					
3.0 CDTI	Diesel	135	08/05 →					
3.2 V6	Petrol	155	08/02 →					
3.2 V6	Petrol	155	08/02 → 09/05					

VECTRA C GTS

1.6	Petrol	74	08/05 →					
1.6	Petrol	74	08/05 →					
1.6	Petrol	77	01/06 →					
1.6	Petrol	77	01/06 →					
1.6	Petrol	74	08/05 →					
1.6	Petrol	74	08/05 →	ENGINE: Z16XE				

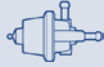

TYPE



TYPE



TYPE

						SAD007	H3			
						SAG120	H1			
			ATS20	F2		SAC068	H2			
						SAG133	H1			
			ATS20	F2		SAC088	H2			
			ATS20	F2		SAC088	H2			
			SPA171	F1					ESS0089A	J1
			SPA103	F1						
						SAG021	H1			
						SAG021-1	H1			
						SAG069	H1			
	APS44		SPA115	F1		SAG083	H1			
								BAE608N		
								BAE680BM		
	APS44		SPA115	F1		SAC062	H2		ESS0089A	J1
						SAD015	H3			
						SAG083	H1			
								BAE608N		
								BAE680BM		
			SPA103	F1						
						SAG021	H1			
						SAG021-1	H1			
						SAG069	H1			
			ATS10	F2		SAD004	H3			
			SPA171	F1						
			SPA171	F1		SAD004	H3			
			ATS10	F2		SAD004	H3			
			SPA171	F1						
								BAE680CF		
								BAE680CF		
								BAE680CF		
			SPA115	F1						
			SPA115	F1						
			SPA171	F1		SAC021	H2		ESS0089A	J1
			SPA103	F1				BAE680CH		
			ATS17	F2		SAC080	H2			
			SPA171	F1		SAD027	H3			
			SPA171	F1	SAA103	SAC057	H2			
						SAG020	H1			
						SAG020	H1			
								BAE608F		



KW



TYPE



TYPE

OPEL

VECTRA C GTS

1.8	Petrol	103	01/06 →					TB0012	B3
1.8	Petrol	103	01/06 →						
1.8 16V	Petrol	90	08/02 →						
1.8 16V	Petrol	90	08/02 →						
1.8 16V	Petrol	90	08/02 →						
1.9 CDTI	Diesel	110	04/04 →					48CPD4	B3
1.9 CDTI	Diesel	74	10/05 →	ENGINE: Z19DT				48CPD1	B3
1.9 CDTI	Diesel	88	04/04 →	ENGINE: Z19DT				48CPD1	B3
1.9 CDTI	Diesel	110	04/04 →						
1.9 CDTI	Diesel	74	10/05 →						
1.9 CDTI	Diesel	88	04/04 →						
2.0 16V Turbo	Petrol	129	03/03 →						
2.0 DTI 16V	Diesel	74	08/02 →						
2.0 DTI 16V	Diesel	74	08/02 →	ENGINE: → 17G23740					
2.0 DTI 16V	Diesel	74	08/02 →	ENGINE: → 17G23740					
2.0 DTI 16V	Diesel	74	08/02 → 09/05	ENGINE: 17G23741 →					
2.2 16V	Petrol	108	08/02 →						
2.2 16V	Petrol	108	08/02 →	ENGINE: Z22SE					
2.2 direct	Petrol	114	10/03 →					TB0014	B3
2.2 direct	Petrol	114	10/03 →						
2.2 direct	Petrol	114	10/03 →						
2.2 direct	Petrol	114	10/03 →	ENGINE: Z22SE					
2.2 direct	Petrol	114	10/03 → 10/08						
2.2 DTI 16V	Diesel	92	08/02 →						
2.2 DTI 16V	Diesel	92	08/02 →	ENGINE: → 17G23740					
2.2 DTI 16V	Diesel	92	08/02 →	ENGINE: → 17G23740					
2.2 DTI 16V	Diesel	92	08/02 → 09/05	ENGINE: 17G23741 →					
2.8 V6 Turbo	Petrol	169	08/05 →						
2.8 V6 Turbo	Petrol	169	08/05 →						
2.8 V6 Turbo	Petrol	184	08/06 →						
2.8 V6 Turbo	Petrol	188	08/05 →						
2.8 V6 Turbo	Petrol	188	08/05 →						
2.8 V6 Turbo	Petrol	206	08/06 →						
2.8 V6 Turbo	Petrol	169	08/05 → 09/07						
2.8 V6 Turbo	Petrol	184	08/06 → 10/08						
2.8 V6 Turbo	Petrol	188	09/05 → 10/08						
2.8 V6 Turbo	Petrol	206	08/06 → 10/08						
3.0 CDTI	Diesel	130	06/03 →						
3.0 CDTI	Diesel	135	08/05 →						
3.2 V6	Petrol	155	08/02 →						
3.2 V6	Petrol	155	08/02 → 09/05						



TYPE

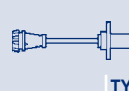

TYPE



TYPE

				SAA103	SAC062	H2		
					SAD033	H3		
					SAC071	H2		
					SAD007	H3		
					SAG120	H1		
				ATS20	F2	SAC068	H2	
					SAG133	H1		
				ATS20	F2	SAC088	H2	
				ATS20	F2	SAC088	H2	
				SPA171	F1			
				SPA103	F1			
						SAG021	H1	
						SAG021-1	H1	
						SAG069	H1	
APS44		SPA115	F1		SAG083	H1		
							BAE608N	
APS44		SPA115	F1		SAC062	H2		
						SAD015	H3	
						SAG083	H1	
							BAE608N	
							BAE680BM	
				SPA103	F1			
						SAG021	H1	
						SAG021-1	H1	
						SAG069	H1	
				ATS10	F2	SAD004	H3	
				SPA171	F1			
				SPA171	F1	SAD004	H3	
				ATS10	F2	SAD004	H3	
				SPA171	F1			
				SPA171	F1	SAD004	H3	
							BAE680CF	
							BAE680CF	
							BAE680CF	
							BAE680CF	
				SPA115	F1			
				SPA115	F1			
				SPA171	F1	SAC021	H2	
				SPA103	F1		BAE680CH	



KW

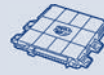

TYPE



TYPE

OPEL

VECTRA C Station wagon

1.6	Petrol	77	01/06 →					
1.6	Petrol	77	10/06 →					
1.6 16V	Petrol	74	06/04 →					
1.6 16V	Petrol	74	06/04 →					
1.6 16V	Petrol	74	06/04 →					
1.6 16V	Petrol	74	06/04 →	ENGINE: Z16XE				
1.8	Petrol	103	01/06 →			TB0012	B3	
1.8	Petrol	90	10/03 →			TB0012	B3	
1.8	Petrol	103	01/06 →					
1.8	Petrol	90	10/03 →					
1.8	Petrol	90	10/03 →					
1.9 CDTI	Diesel	88	04/04 →	ENGINE: Z19DT		48CPD1	B3	
1.9 CDTI	Diesel	110	04/04 →					
1.9 CDTI	Diesel	74	10/05 →					
1.9 CDTI	Diesel	88	04/04 →					
1.9 CDTI	Diesel	110	04/04 →					
2.0 DTI	Diesel	74	10/03 →					
2.0 DTI	Diesel	74	10/03 →	ENGINE: → 17G23740				
2.0 DTI	Diesel	74	10/03 →	ENGINE: → 17G23740				
2.0 DTI	Diesel	74	10/03 → 09/05	ENGINE: 17G23741 →				
2.0 Turbo	Petrol	129	10/03 →					
2.2 direct	Petrol	114	10/03 →			TB0014	B3	
2.2 direct	Petrol	114	10/03 →					
2.2 direct	Petrol	114	10/03 →					
2.2 direct	Petrol	114	10/03 →	ENGINE: Z22SE				
2.2 direct	Petrol	114	10/03 → 10/08					
2.2 DTI	Diesel	92	10/03 →					
2.2 DTI	Diesel	92	10/03 →	ENGINE: → 17G23740				
2.2 DTI	Diesel	92	10/03 →	ENGINE: → 17G23740				
2.2 DTI	Diesel	92	10/03 → 09/05	ENGINE: 17G23741 →				
2.8 V6 Turbo	Petrol	169	08/05 →					
2.8 V6 Turbo	Petrol	169	08/05 →					
2.8 V6 Turbo	Petrol	184	01/07 →					
2.8 V6 Turbo	Petrol	188	08/05 →					
2.8 V6 Turbo	Petrol	188	08/05 →					
2.8 V6 Turbo	Petrol	206	01/07 →					
2.8 V6 Turbo	Petrol	169	08/05 → 09/07					
2.8 V6 Turbo	Petrol	184	01/07 → 10/08					
2.8 V6 Turbo	Petrol	188	08/05 → 10/08					
2.8 V6 Turbo	Petrol	206	01/07 → 10/08					
3.0 V6 CDTI	Diesel	130	10/03 →					
3.2 V6	Petrol	155	10/03 →					
3.2 V6	Petrol	155	10/03 → 09/05					

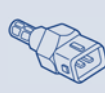

TYPE

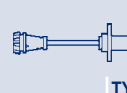

TYPE



TYPE

			SPA171	F1						
					SAA103	SAG020	H1			
	APS44		ATS17	F2		SAC080	H2			
			SPA171	F1		SAD027	H3			
						SAG020	H1			
								BAE608F		
					SAA103	SAC062	H2			
						SAC071	H2			
						SAD033	H3			
						SAD007	H3			
						SAG120	H1			
			ATS20	F2		SAC068	H2		GA2125	J2
			ATS20	F2		SAC088	H2			
			ATS20	F2		SAC088	H2			
						SAG133	H1			
			SPA103	F1						
						SAG021	H1			
						SAG021-1	H1			
						SAG069	H1			
			SPA171	F1						
	APS44		SPA115	F1		SAC062	H2		GA2100	J2
						SAD015	H3			
						SAG083	H1			
								BAE608N		
								BAE680BM		
			SPA103	F1						
						SAG021	H1			
						SAG021-1	H1			
						SAG069	H1			
			ATS10	F2		SAD004	H3			
			SPA171	F1						
			SPA171	F1		SAD004	H3			
			ATS10	F2		SAD004	H3			
			SPA171	F1						
			SPA171	F1		SAD004	H3			
								BAE680CF		
								BAE680CF		
								BAE680CF		
								BAE680CF		
			SPA115	F1						
			SPA171	F1		SAC021	H2			
			SPA103	F1				BAE680CH		



KW



TYPE



TYPE

OPEL

VIVARO Combi (J7)

1.9 DI	Diesel	60	08/01 →						
1.9 DTI	Diesel	74	08/01 →						
2.0 16V	Petrol	88	08/01 →						
2.0 CDTi	Diesel	66	08/06 →						
2.0 CDTi	Diesel	84	08/06 →						
2.0 ECOTEC	Petrol	86	08/06 →						
2.5 DTi	Diesel	99	05/03 →						

VIVARO Furgonato (F7)

1.9 DTI	Diesel	74	08/01 →						
2.0 16V	Petrol	88	08/01 →						
2.0 CDTi	Diesel	66	08/06 →						
2.0 CDTi	Diesel	84	08/06 →						
2.0 ECOTEC	Petrol	86	08/06 →						
2.5 DTi	Diesel	99	05/03 →						

VIVARO Pianale piatto/Telaio (E7)

2.0 16V	Petrol	88	08/06 →						
2.0 CDTi	Diesel	66	01/06 →						
2.0 CDTi	Diesel	84	08/06 →						
2.0 ECOTEC	Petrol	86	08/06 →						

ZAFIRA A (F75_)

1.6 16V	Petrol	74	04/99 → 06/05					B3215	B1
1.6 16V	Petrol	74	04/99 → 06/05					SVF013	B6
1.6 16V	Petrol	74	04/99 → 06/05						
1.6 16V	Petrol	74	04/99 → 08/99						
1.6 16V	Petrol	74	04/99 → 06/05	ENGINE: Z16XE-Z16XEL					
1.6 16V	Petrol	74	04/99 → 08/99	ENGINE: X16XEL					
1.6 16V	Petrol	74	08/99 → 06/05	ENGINE: Z16XE					
1.6 CNG	Petrol/CNG	71	09/01 → 06/05						
1.6 CNG	Petrol/CNG	71	09/01 → 06/05						
1.6 CNG	Petrol/CNG	71	09/01 → 06/05						
1.6 CNG	Petrol/CNG	71	09/01 → 06/05	ENGINE: Z16YNG					
1.8 16V	Petrol	92	09/00 → 06/05					TB0012	B3
1.8 16V	Petrol	85	04/99 → 09/00						
1.8 16V	Petrol	85	04/99 → 09/00						
1.8 16V	Petrol	85	04/99 → 09/00						
1.8 16V	Petrol	92	09/00 → 06/05						
1.8 16V	Petrol	92	09/00 → 06/05						
1.8 16V	Petrol	85	04/99 → 08/00						
2.0 DI 16V	Diesel	60	10/99 → 06/05					PAS004	B5
2.0 DI 16V	Diesel	60	10/99 → 08/00						
2.0 DI 16V	Diesel	60	10/99 → 06/05	CHASSIS: → 38999999					
2.0 DI 16V	Diesel	60	10/99 → 06/05	CHASSIS: → 38999999					
2.0 DTI 16V	Diesel	74	09/00 → 06/05					PAS004	B5
2.0 DTI 16V	Diesel	74	09/00 → 06/05	CHASSIS: → 38999999					



TYPE

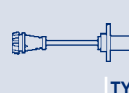

TYPE



TYPE

				SPA169	F1		SAG153	H1		
				SPA169	F1					
		APS44		SPA108	F1		SAD035	H3		
							SAC077	H2		
							SAC077	H2		
				SPA108	F1		SAD035	H3		
							SAG153	H1		
				SPA169	F1					
		APS44		SPA108	F1		SAD035	H3	BAE680E	
							SAC077	H2		
							SAC077	H2		
				SPA108	F1		SAD035	H3		
							SAG153	H1		
				SPA108	F1		SAD035	H3		
							SAC077	H2		
							SAC077	H2		
				SPA108	F1		SAD035	H3		
				ATS17	F2		SAC080	H2	BAE608H	
				SPA171	F1		SAD027	H3		
							SAG020	H1		
				SPA103	F1				BAE608F	
									ESS530	J1
									ESS532	J1
				ATS17	F2		SAC080	H2	BAE608H	ESS0057A
				SPA171	F1		SAD027	H3		
							SAG020	H1		
									BAE608F	
							SAC071	H2		ESS532
							SAC071	H2		J1
							SAD015	H3		
							SAG116	H1		
							SAD015	H3		
							SAG120	H1		
									ESS532	J1
				SPA171	F1					
				SPA103	F1					
							SAG021	H1		
							SAG021-1	H1		
				SPA103	F1					
							SAG021	H1		



KW



TYPE



TYPE

OPEL

ZAFIRA A (F75_)

2.0 DTI 16V	Diesel	74	09/00 → 06/05	CHASSIS: → 38999999				
2.0 OPC	Petrol	141	09/01 → 06/05					
2.0 OPC	Petrol	141	09/01 → 06/05					
2.0 OPC	Petrol	147	11/02 → 06/05					
2.0 OPC	Petrol	147	11/02 → 06/05					
2.2 16V	Petrol	108	09/00 → 06/05					
2.2 16V	Petrol	108	09/00 → 06/05	ENGINE: Z22SE				
2.2 DTI 16V	Diesel	92	01/02 → 06/05					
2.2 DTI 16V	Diesel	92	01/02 → 06/05					
2.2 DTI 16V	Diesel	92	03/02 → 06/05					
2.2 DTI 16V	Diesel	92	01/02 → 06/05	CHASSIS: → 38999999				
2.2 DTI 16V	Diesel	92	01/02 → 06/05	CHASSIS: → 38999999				

ZAFIRA B (A05)

1.6	Petrol	77	07/05 →					
1.6	Petrol	77	07/05 →					
1.6	Petrol	85	01/08 →					
1.6	Petrol	77	07/05 →	ENGINE: Z16XEP				
1.6 CNG	Petrol/CNG	69	01/06 →					
1.6 CNG	Petrol/CNG	69	01/06 →					
1.6 CNG	Petrol/CNG	69	01/06 →					
1.6 CNG Turbo	Petrol/CNG	110	04/09 →					
1.7 CDTI	Diesel	81	01/08 →			TB0002		B3
1.7 CDTI	Diesel	92	01/08 →			TB0002		B3
1.8	Petrol	103	07/05 →					
1.8	Petrol	103	07/05 →	ENGINE: Z18XER				
1.9 CDTI	Diesel	74	07/05 →	ENGINE: Z19DTL		48CPD1		B3
1.9 CDTI	Diesel	88	07/05 →	ENGINE: Z19DT		48CPD1		B3
1.9 CDTI	Diesel	110	07/05 →					
1.9 CDTI	Diesel	74	07/05 →					
1.9 CDTI	Diesel	88	07/05 →					
1.9 CDTI	Diesel	110	07/05 →					
2.0	Petrol	147	07/05 →					
2.0	Petrol	147	07/05 →					
2.0	Petrol	177	01/06 →					
2.0	Petrol	177	01/06 →					
2.2	Petrol	110	07/05 →			TB0014		B3
2.2	Petrol	110	07/05 →					
2.2	Petrol	110	07/05 →					

ZAFIRA B Van

1.6 CNG Turbo	Petrol/CNG	110	04/09 →					
1.7 CDTI	Diesel	81	01/08 →			TB0002		B3
1.8	Petrol	103	07/05 →					



TYPE



TYPE



TYPE

						SAG021-1	H1			
			ATS10	F2		SAC035	H2	BAE680BL		
			SPA103	F1		SAG057	H1			
			ATS10	F2		SAC035	H2	BAE680BL		
			SPA103	F1		SAG057	H1			
	APS44		SPA115	F1		SAG083	H1			
								BAE608N		
			ATS20	F2						
			SPA171	F1						
			SPA103	F1						
						SAG021	H1			
						SAG021-1	H1			
	APS44		SPA171	F1	SAA103	SAC057	H2		GA2164	J2
						SAG020	H1			
					SAA103	SAC062	H2			
								BAE608L		
			SPA171	F1		SAC080	H2		ESS0057A	J1
						SAD027	H3			
						SAG020	H1			
					SAA103					
			SPA171	F1						
			SPA171	F1						
					SAA103	SAC062	H2		GA2164	J2
								BAE608L		
			ATS10	F2		SAC068	H2		GA2188	J2
			ATS20	F2		SAC088	H2		GA2188	J2
			ATS20	F2		SAC088	H2		GA2188	J2
						SAG133	H1			
			ATS10	F2		SAC035	H2	BAE680BL	GA2047	J2
			SPA103	F1		SAG057	H1			
			ATS10	F2		SAC035	H2	BAE680BL	GA2049	J2
			SPA171	F1		SAG057	H1			
	APS44					SAC062	H2	BAE680BM	GA2093	J2
						SAD015	H3			
						SAG083	H1			
					SAA103					
					SAA103					



KW



TYPE



TYPE

OPEL

ZAFIRA TOURER C (P12)

1.4	Petrol	103	10/11 →					
1.4	Petrol	88	10/11 →					
1.6 CNG	Petrol/CNG	110	12/11 →					
1.8	Petrol	103	12/11 →					
1.8	Petrol	85	10/11 →					
1.8	Petrol	103	10/11 →					
1.8	Petrol	88	10/11 →					

PEUGEOT

1007 (KM_)

1.4	Petrol	54	04/05 →					
1.4 16V	Petrol	65	10/05 →	ENGINE: KFUET3J4			50SMP1	B3
1.4 16V	Petrol	65	10/05 →					
1.4 HDi	Diesel	50	04/05 →				AMM19765	B4
1.4 HDi	Diesel	50	04/05 →					
1.6 16V	Petrol	80	04/05 →				TB0015	B3
1.6 HDi	Diesel	80	06/07 →					
1.6 HDi	Diesel	80	06/07 →					

106 I (1A, 1C)

1.0	Petrol	33	09/91 → 04/96					
1.0	Petrol	37	09/91 → 04/96					
1.0	Petrol	33	07/92 → 04/96					
1.0	Petrol	37	07/92 → 04/96					
1.0	Petrol	33	09/91 → 04/96	ENGINE: C(TU9)				
1.0	Petrol	33	09/91 → 04/96	ENGINE: TU9M				
1.0	Petrol	37	09/91 → 04/96	ENGINE: C(TU9)				
1.0	Petrol	37	09/91 → 04/96	ENGINE: TU9M				
1.1	Petrol	44	09/91 → 04/96				KITPF2C	B6
1.1	Petrol	44	09/91 → 04/96	ENGINE: TU1JP			B35/00	B1
1.1	Petrol	44	09/91 → 04/96	ENGINE: TU1MZ				
1.1	Petrol	44	09/91 → 12/92					
1.1	Petrol	44	09/91 → 04/96	ENGINE: TU1M(CDY)				
1.1	Petrol	44	08/92 → 04/96					
1.1	Petrol	44	09/91 → 04/96	ENGINE: C(TU1)				
1.1	Petrol	44	09/91 → 04/96	ENGINE: TU1M				
1.3	Petrol	72	10/93 → 04/96	ENGINE: TU2J2			B13	B1
1.3	Petrol	72	01/96 → 04/96				PF16080067	B6
1.3	Petrol	72	10/93 → 04/96					
1.3	Petrol	72	10/93 → 04/96	ENGINE: TU2J2				
1.3	Petrol	72	10/93 → 04/96					
1.4	Petrol	55	09/91 → 04/96				KITPF2C	B6
1.4	Petrol	69	09/91 → 04/96				KITPF2C	B6
1.4	Petrol	69	09/91 → 04/96				SVF015	B6
1.4	Petrol	55	09/91 → 04/96					

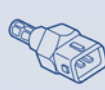
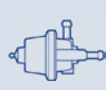

TYPE

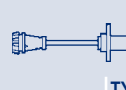

TYPE



TYPE

					SAA103					
					SAA103					
					SAA103					
					SAA103					
					SAA103					
										BAE680CS
										BAE680CS
										BAE680CS

	FEI0002	APS77		SPA107	F1	SAA118	SAG164	H1		GA2198	J2
		APS77		SPA161	F1	SAA118	SAG164	H1	BAE680CA	GA2198	J2
				ATS22	F2	SAA118	SAC100	H2			
				SPA172	F1		SAG167	H1			
		APS77		SPA107	F1	SAA118	SAG164	H1		GA2198	J2
		APS38		ATS22	F2	SAA118	SAC096	H2			
				SPA172	F1		SAG167	H1			

				SPA104	F1		SAG156	H1		ESS0034A	J1
				SPA104	F1		SAG156	H1		ESS0034A	J1
									BAE680CV		
									BAE680CV		
									SUA386		J3
									ESS273		J1
									SUA386		J3
									ESS273		J1
				KITATS05	F2		SAG156	H1		ESS0034A	J1
		PRT03/04		SZA102	F1						
				SPA104	F1						
									BAE507BK		
									BAE680CV		
									SUA386		J3
									ESS273		J1
			KITRPM36	SZA101	F1						
		PRT03E/04					SAD028	H3	BAE680CV	ESS0095A	J1
			RPM36								
							SAG156	H1		GA2207	J2
				SPA102	F1		SAG156	H1		ESS0034A	J1
							SAG156	H1	BAE680CV	ESS0095A	J1
									ESS273		J1
									ESS273		J1



KW

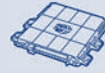

TYPE



TYPE

PEUGEOT

106 I (1A, 1C)

1.4	Petrol	55	01/92 → 04/96						
1.4	Petrol	55	09/91 → 04/96						
1.4	Petrol	69	09/91 → 04/96						
1.4	Petrol	55	09/91 → 04/96	ENGINE: TU3M(KDY)- TU3MC(KDX)					
1.4	Petrol	55	12/92 → 04/96						
1.4	Petrol	69	09/91 → 04/96	ENGINE: TU3M(KDY)- TU3MC(KDX)					
1.4	Petrol	55	09/91 → 04/96	ENGINE: C					
1.4	Petrol	69	09/91 → 04/96	ENGINE: C					
1.6	Petrol	65	06/93 → 04/96				KITPF2C	B6	
1.6	Petrol	65	06/93 → 01/95				SVF015	B6	
1.6	Petrol	76	01/94 → 04/96				KITPF2C	B6	
1.6	Petrol	76	01/94 → 04/96	ENGINE: TU5J2			B13	B1	
1.6	Petrol	65	06/93 → 04/96						
1.6	Petrol	76	01/94 → 04/96						
1.6	Petrol	76	01/94 → 04/96	ENGINE: TU5J2					

106 II (1)

1.0 i	Petrol	37	01/97 →						
1.0 i	Petrol	37	01/97 → 02/98						
1.0 i	Petrol	37	09/99 →						
1.0 i	Petrol	37	01/97 → 05/05						
1.1 i	Petrol	40	01/97 →				B03	B1	
1.1 i	Petrol	40	12/97 →						
1.1 i	Petrol	40	01/97 → 02/98						
1.1 i	Petrol	40	09/99 →						
1.1 i	Petrol	40	01/97 → 05/05						
1.4 i	Petrol	55	06/97 → 11/98			IAW1AP.40/3	A1		
1.4 i	Petrol	55	12/97 → 04/00	ENGINE: TU3JP+		IAW1AP.81	A1		
1.5 D	Diesel	42	04/98 →						
1.6 S16	Petrol	87	05/96 → 12/00	ENGINE: TU5J4-L3			B17	B1	
1.6 S16	Petrol	87	09/00 → 07/03			IAW48P2.80/1	A1		

106 Van (1_)

1.0	Petrol	33	07/92 → 04/96						
-----	--------	----	---------------	--	--	--	--	--	--

107

1.0	Petrol	50	06/05 →						
1.0	Petrol	50	06/05 →						
1.0	Petrol	50	06/05 →						
1.4 HDi	Diesel	40	06/05 →						
1.4 HDi	Diesel	40	06/05 →						



TYPE



TYPE



TYPE

			SPA104	F1						
									GA2207	J2
									GA2207	J2
									BAE507BK	
									BAE680CV	
									BAE507BK	
									SUA386	J3
									SUA386	J3
	APS29		SPA102	F1	SAG156	H1	BAE680CV	ESS0095A	J1	
	APS29		SPA104	F1	SAG156	H1	BAE680CV	ESS0095A	J1	
		KITRPM40								
			SPA104	F1					GA2207	J2
									GA2207	J2
		RPM40								
			SPA164	F1	SAG028	H1				
					SAG156	H1				
					SAG027	H1				
							BAE680AF			
					SAG028	H1				
			SPA164	F1						
					SAG156	H1				
					SAG027	H1				
							BAE680AF			
					SAA118					
									BAE680CV	
	APS75		SPA162	F1	SAC091	H2	BAE680CB	GA2225	J2	
					SAD025	H3				
					SAG152	H1				
			ATS22	F2	SAA118	SAC100	H2	SUA560	J3	
			SPA172	F1	SAG167	H1				



KW

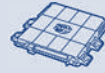

TYPE



TYPE

PEUGEOT

205 I (741A/C)

1.0	Petrol	33	02/83 → 10/87					
1.1	Petrol	36	02/83 → 10/87					
1.1	Petrol	37	02/83 → 10/87					
1.4	Petrol	44	02/83 → 10/87					
1.4	Petrol	53	02/83 → 10/87					
1.4	Petrol	58	10/85 → 10/87					
1.4	Petrol	59	02/83 → 10/87					
1.6	Petrol	55	08/86 → 10/87					
1.6	Petrol	55	08/86 → 10/87					
1.6 GTI	Petrol	76	12/84 → 10/87					
1.6 GTI	Petrol	76	12/84 → 10/87					
1.7 Diesel	Diesel	44	10/83 → 10/87					
1.9 GTI	Petrol	94	10/86 → 10/87					
1.9 GTI	Petrol	94	10/86 → 10/87					

205 I Cabriolet (741B, 20D)

1.1 CJ	Petrol	44	10/89 → 12/90					
1.1 CJ	Petrol	44	10/89 → 12/94	CHASSIS: S24902801 →				
1.1 CJ	Petrol	44	10/89 → 12/94					
1.1 CJ	Petrol	44	10/89 → 12/94					
1.1 CJ	Petrol	44	10/89 → 12/94					
1.4 CJ	Petrol	44	03/88 → 05/89					
1.4 CJ	Petrol	49	03/89 → 12/94					
1.4 CJ	Petrol	55	05/91 → 12/94					
1.4 CJ	Petrol	55	05/91 → 12/94					
1.4 CJ	Petrol	55	06/91 → 12/94					
1.4 CT	Petrol	58	04/86 → 12/88					
1.6 CJ	Petrol	65	08/92 → 12/94			PF90/018		B6
1.6 CJ	Petrol	65	08/92 → 12/92			B04		B1
1.6 CJ	Petrol	65	08/92 → 12/94					
1.6 CJ	Petrol	65	08/92 → 12/94					
1.6 CTI	Petrol	76	04/86 → 10/87			SVF010		B6
1.6 CTI	Petrol	76	04/86 → 10/90					
1.9 CTI	Petrol	75	10/87 → 10/94			SVF010		B6
1.9 CTI	Petrol	75	10/87 → 12/94					
1.9 CTI	Petrol	75	10/87 → 12/94					

205 II (20A/C)

1.0	Petrol	37	08/92 → 05/97					
1.0	Petrol	33	10/87 → 09/98					
1.0	Petrol	33	10/87 → 09/98					
1.0	Petrol	33	10/87 → 09/98					
1.1	Petrol	44	07/89 → 09/98			B03		B1
1.1	Petrol	44	07/89 → 09/98			KITPF2C		B6
1.1	Petrol	44	01/97 → 09/98	ENGINE: TU1ML3				
1.1	Petrol	36	10/87 → 10/90					



KW



TYPE



TYPE

PEUGEOT

205 II (20A/C)

1.1	Petrol	44	07/89 → 09/98					
1.1	Petrol	44	07/89 → 12/90					
1.1	Petrol	44	01/92 → 09/98	ENGINE: TU1ML3				
1.1	Petrol	44	07/89 → 01/96	CHASSIS: S24902801 →				
1.1	Petrol	40	10/87 → 10/90					
1.3 Rallye	Petrol	74	10/87 → 10/90					
1.4	Petrol	55	07/88 → 12/90					
1.4	Petrol	55	01/96 → 07/98	ENGINE: 18081179 →				
1.4	Petrol	55	09/92 → 12/95	ENGINE: → 1808178				
1.4	Petrol	44	10/87 → 05/89					
1.4	Petrol	49	10/87 → 10/90					
1.4	Petrol	53	01/87 → 07/88					
1.4	Petrol	55	07/88 → 09/98					
1.4	Petrol	55	07/88 → 09/98					
1.4	Petrol	55	07/88 → 09/98					
1.4	Petrol	58	07/88 → 12/88					
1.4	Petrol	62	06/87 → 12/89					
1.4	Petrol	63	10/87 → 12/89					
1.4 Cat.	Petrol	44	10/87 → 10/90					
1.6	Petrol	66	11/90 → 07/92					
1.6 Aut.	Petrol	58	01/91 → 12/92			B04		B1
1.6 Aut.	Petrol	65	01/91 → 12/92			B04		B1
1.6 Aut.	Petrol	65	01/91 → 09/98	ENGINE: XU5M3Z				
1.6 Aut.	Petrol	65	11/90 → 09/98					
1.6 Aut.	Petrol	58	10/90 → 09/98					
1.6 Aut.	Petrol	65	05/90 → 09/98					
1.6 Aut.	Petrol	65	05/90 → 09/98					
1.6 GTI	Petrol	76	10/87 → 12/89					
1.6 GTI	Petrol	76	10/88 → 12/89					
1.6 GTI	Petrol	85	10/87 → 12/89					
1.6 GTI	Petrol	85	10/87 → 12/89					
1.7 Diesel	Diesel	44	07/87 → 12/89					
1.8 TD	Diesel	57	01/90 → 09/98					
1.9 Diesel	Diesel	47	10/87 → 09/98					
1.9 GTI	Petrol	88	10/87 → 10/94			SVF010		B6
1.9 GTI	Petrol	94	10/87 → 09/98			SVF010		B6
1.9 GTI	Petrol	88	10/87 → 10/94					
1.9 GTI	Petrol	94	10/87 → 09/98					
1.9 GTI Cat.	Petrol	75	10/87 → 07/94			SVF010		B6
1.9 GTI Cat.	Petrol	75	10/87 → 07/94					

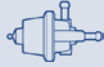

TYPE



TYPE



TYPE

									SUA287	J3
				SPA104	F1					
				SZA102	F1					
									BAE680AF	
									SUA287	J3
									SUA287	J3
				SPA104	F1					
									BAE680AF	
									BAE680CV	
									SUA287	J3
									SUA287	J3
									SUA287	J3
									ESS0034A	J1
									GA2184	J2
									SUA287	J3
									SUA287	J3
									SUA287	J3
									SUA287	J3
									SUA287	J3
									SUA287	J3
									BAE680AF	
		PRT03/04		SZA102	F1					
									BAE680AF	
									SUA287	J3
									SUA287	J3
									GA2184	J2
									ESS0034A	J1
									GA2160	J2
									SUA287	J3
									GA2160	J2
									SUA287	J3
									SUA287	J3
									SUA287	J3
									SUA287	J3
									SUA287	J3
									GA2160	J2
									GA2160	J2
									SUA287	J3
									SUA287	J3
									GA2160	J2
									SUA287	J3



KW

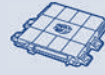

TYPE



TYPE

PEUGEOT

206 2 volumi /Coda spiovente (2A/C)

1.1 i	Petrol	44	07/00 → 09/01	ENGINE: TU1JP,L4	IAW48P2.70	A1		
1.1 i	Petrol	44	08/01 → 10/05	ENGINE: TU1JP,L	IAW48P2.76	A1		
1.1 i	Petrol	44	09/98 →	ENGINE: TU1JP			CA0077265/1	B6
1.1 i	Petrol	44	09/98 →	ENGINE: TU1JP+			B30/01	B1
1.1 i	Petrol	44	09/98 → 12/98				KITPF2C	B6
1.1 i	Petrol	44	09/98 →					
1.1 i	Petrol	44	09/98 → 11/98					
1.1 i	Petrol	44	03/00 →					
1.1 i	Petrol	44	09/98 →					
1.1 i	Petrol	44	09/99 →					
1.1 i	Petrol	44	01/01 →	ENGINE: TU1JP				
1.1 i	Petrol	44	10/01 →	ENGINE: TU1JP				
1.4 16V	Petrol	65	10/03 →	ENGINE: KFUET3J4			50SMP1	B3
1.4 16V	Petrol	65	10/03 →					
1.4 HDi	Diesel	51	09/02 → 02/07					
1.4 HDi eco 70	Diesel	50	09/01 →				AMM19765	B4
1.4 HDi eco 70	Diesel	50	09/01 →					
1.4 i	Petrol	55	09/98 → 02/00	ENGINE: TU3JP	IAW1AP.82/1	A1		
1.4 i	Petrol	55	09/98 → 09/00	ENGINE: TU3JP+	IAW1AP.81/1	A1		
1.4 i	Petrol	55	09/98 → 01/01	ENGINE: TU3JP,K	IAW1AP.84/1	A1		
1.4 i	Petrol	55	09/98 →	ENGINE: TU3JP			B36	B1
1.4 i	Petrol	55	09/98 →	ENGINE: TU3JP			CA0077265/1	B6
1.4 i	Petrol	55	09/98 → 12/98				KITPF2C	B6
1.4 i	Petrol	55	09/98 → 12/00	ENGINE: TU3JP(Z,L,L3)			B27	B1
1.4 i	Petrol	55	01/00 → 11/00	ENGINE: TU3JP,L3			B32/01	B1
1.4 i	Petrol	55	09/98 →					
1.4 i	Petrol	55	09/98 →					
1.4 i	Petrol	55	09/98 → 11/98					
1.4 i	Petrol	55	03/00 →					
1.4 i	Petrol	55	09/99 →					
1.4 i	Petrol	55	01/01 →	ENGINE: TU3JP				
1.4 i	Petrol	55	10/01 →	ENGINE: TU3JP				
1.4 LPG	Petrol/LPG	55	05/06 → 09/07					
1.6 16V	Petrol	80	12/00 →				TB0015	B3
1.6 16V	Petrol	80	12/00 →					
1.6 16V	Petrol	80	12/00 → 09/02					
1.6 16V	Petrol	80	01/01 →	ENGINE: TU5JP				
1.6 16V	Petrol	80	10/01 →	ENGINE: TU5JP4				
1.6 HDi 110	Diesel	80	05/04 →					
1.6 HDi 110	Diesel	80	05/04 →					
1.6 i	Petrol	65	09/98 → 11/98					
1.6 i	Petrol	65	09/98 → 12/00					
1.6 i	Petrol	65	09/98 → 12/00					
1.6 i	Petrol	65	09/99 → 12/00					



KW



TYPE



TYPE

PEUGEOT

206 2 volumi /Coda spiovente (2A/C)

1.6 i	Petrol	65	09/98 → 12/00	ENGINE: TU5JP				
1.9 D	Diesel	51	09/98 → 11/01					
1.9 D	Diesel	51	09/99 → 11/01					
1.9 D	Diesel	51	09/98 → 12/00	ENGINE: DW8				
2.0 HDI 90	Diesel	66	12/99 →					
2.0 HDI 90	Diesel	66	12/99 →					
2.0 HDI 90	Diesel	66	12/99 → 05/02					
2.0 HDI 90	Diesel	66	03/02 →	ENGINE: DW10TD				
2.0 RC	Petrol	130	07/03 →					
2.0 S16	Petrol	99	04/99 → 10/00	ENGINE: EW10J4,D3	IAW48P2.316	A1		
2.0 S16	Petrol	100	06/99 →	ENGINE: EW10J4			B33	B1
2.0 S16	Petrol	99	04/99 → 10/00	ENGINE: EW10J4			B33	B1
2.0 S16	Petrol	100	06/99 →					
2.0 S16	Petrol	100	06/99 →					
2.0 S16	Petrol	99	04/99 → 10/00					
2.0 S16	Petrol	99	09/99 → 10/00					
2.0 S16	Petrol	100	01/01 →	ENGINE: EW10J4				
2.0 S16	Petrol	100	10/01 →	ENGINE: EW10J4				

206 CC (2D)

1.6 16V	Petrol	80	09/00 →				TB0015	B3
1.6 16V	Petrol	80	09/00 →					
1.6 16V	Petrol	80	09/00 → 09/02					
1.6 16V	Petrol	80	09/00 →	ENGINE: TU5JP				
1.6 16V	Petrol	80	01/01 →	ENGINE: TU5JP				
1.6 HDi 110	Diesel	80	04/05 →					
1.6 HDi 110	Diesel	80	04/05 →					
2.0 S16	Petrol	100	09/00 →	ENGINE: EW10J4			B33	B1
2.0 S16	Petrol	100	09/00 →					
2.0 S16	Petrol	100	09/00 →					
2.0 S16	Petrol	100	09/00 →					
2.0 S16	Petrol	100	01/01 →	ENGINE: EW10J4				

206 SW (2E/K)

1.1	Petrol	44	07/02 → 10/05	ENGINE: TU1JP,L	IAW48P2.76	A1		
1.1	Petrol	44	07/02 →	ENGINE: TU1JP			B35/00	B1
1.1	Petrol	44	07/02 →	ENGINE: TU1JP			CA0077265/1	B6
1.1	Petrol	44	07/02 →	ENGINE: TU1JP+			B30/01	B1
1.1	Petrol	44	07/02 →					
1.1	Petrol	44	07/02 →					
1.4	Petrol	55	07/02 →	ENGINE: TU3JP			B36	B1
1.4	Petrol	55	07/02 →	ENGINE: TU3JP			CA0077265/1	B6
1.4	Petrol	55	07/02 →					
1.4	Petrol	55	07/02 →					
1.4 16V	Petrol	65	10/03 →	ENGINE: KFUET3J4			50SMP1	B3
1.4 16V	Petrol	65	10/03 →					



TYPE

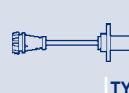

TYPE



TYPE

										GA2002	J2
			SPA107	F1	SAA118	SAG028	H1				
						SAG027	H1				
										SUA384	J3
					SAA118	SAC096	H2			GA2204	J2
						SAG027	H1				
						SAG157	H1				
										SUA494	J2
	APS77		SPA107	F1	SAA118	SAC070	H2				
										GA2002	J2
		RPM58	IATS04/01	F2	SAA118	SAC070	H2				
			SPA107	F1		SAG027	H1				
			SPA107	F1	SAA118	SAG028	H1				
						SAG027	H1				
										GA2006	J2
										GA2005	J2
	APS77		SPA107	F1	SAA118	SAD033	H3				
						SAG164	H1				
			SPA167	F1							
										GA2002	J2
										GA2005	J2
	APS38		ATS22	F2	SAA118	SAC096	H2				
			SPA172	F1		SAG167	H1				
										GA2002	J2
		RPM58	IATS04/01	F2	SAA118	SAC070	H2				
			SPA107	F1		SAD033	H3				
						SAG027	H1				
										GA2005	J2
										GA2005	J2
IPM002	APS77	RPM58	SPA107	F1	SAA118	SAD033	H3				
						SAG164	H1				
										GA2005	J2
FEI0002	APS77	RPM58	SPA107	F1	SAA118	SAD033	H3				
						SAG164	H1				
	APS77	RPM58	SPA107	F1	SAA118	SAG164	H1	BAE680CA			



KW



TYPE



TYPE

PEUGEOT

206 SW (2E/K)

1.4 HDi	Diesel	50	07/02 →				AMM19765	B4
1.4 HDi	Diesel	50	07/02 →					
1.6 16V	Petrol	80	07/02 →				TB0015	B3
1.6 16V	Petrol	80	07/02 →					
1.6 16V	Petrol	80	07/02 → 09/02					
1.6 16V	Petrol	80	07/02 →	ENGINE: TU5JP				
1.6 HDi 110	Diesel	80	05/04 →					
1.6 HDi 110	Diesel	80	05/04 →					
2.0 16V	Petrol	100	07/02 →	ENGINE: EW10J4			B33	B1
2.0 16V	Petrol	100	07/02 →					
2.0 16V	Petrol	100	07/02 →					
2.0 16V	Petrol	100	07/02 →					
2.0 HDi	Diesel	66	07/02 →					
2.0 HDi	Diesel	66	07/02 →	ENGINE: DW10TD				

206 Tre volumi

1.4	Petrol	55	03/07 →					
1.4 HDi eco 70	Diesel	50	09/08 →					
1.6 16V	Petrol	80	03/07 →				TB0015	B3

206 Van

1.4 HDi	Diesel	50	09/01 → 03/09					
1.9 D	Diesel	51	09/01 → 05/07					

206+ (T3E)

1.4 HDi eco 70	Diesel	50	01/09 →					
1.4 i	Petrol	54	09/10 →					

207 (WA_, WC_)

1.4	Petrol	53	02/06 →	ENGINE: ET3				
1.4	Petrol	53	02/06 →					
1.4	Petrol	53	02/06 →	ENGINE: TU3A				
1.4 16V	Petrol	65	02/06 →	ENGINE: KFUET3J4			50SMP1	B3
1.4 16V	Petrol	70	06/07 →	ENGINE: KFTTU3AE5			44GTE3P	B3
1.4 16V	Petrol	65	02/06 →	ENGINE: ET3				
1.4 16V	Petrol	70	06/07 →					
1.4 16V	Petrol	65	02/06 →					
1.4 16V	Petrol	70	06/07 → 04/12					
1.4 16V	Petrol	65	02/06 →	ENGINE: ET3J4				
1.4 HDi	Diesel	50	02/06 →					
1.4 HDi	Diesel	50	02/06 →					
1.4 HDi	Diesel	50	02/06 →	ENGINE: DV4TD				
1.4 HDi	Diesel	50	02/06 →	ENGINE: DV4TD				
1.6 16V	Petrol	80	02/06 →					
1.6 16V	Petrol	80	02/06 →	ENGINE: TU5JP4				
1.6 16V RC	Petrol	128	02/07 →					
1.6 16V RC	Petrol	128	04/07 →					
1.6 16V RC	Petrol	128	02/07 →	ENGINE: EP6DTS				



TYPE

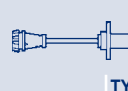

TYPE



TYPE

				ATS22	F2	SAA118	SAC100	H2	SUA495	J2
				SPA172	F1		SAG167	H1		
	APS77			SPA107	F1	SAA118	SAD033	H3		
							SAG164	H1		
				SPA167	F1					
									GA2005	J2
	APS38			ATS22	F2	SAA118	SAC096	H2		
				SPA172	F1		SAG167	H1		
									GA2005	J2
		RPM58		IATS04/01	F2	SAA118	SAC070	H2		
				SPA107	F1		SAD033	H3		
							SAG157	H1		
							SAC096	H2	GA2204	J2
									SUA494	J2
	FEI0002					SAA118				
							SAG167	H1		
				SPA161	F1	SAA118	SAG167	H1		
							SAG167	H1		
				SPA107	F1					
							SAG167	H1		
				SPA107	F1					
	IPM012					SAA118	SAG164	H1		
									GA2043	J2
	IPM012									
	APS71			SPA161	F1	SAA118			GA2215	J2
				SPA161	F1	SAA118	SAG164	H1	BAE680CA	GA2215
									BAE680BR	
									GA2043	J2
				ATS22	F2		SAC100	H2		
				SPA172	F1		SAG168	H1		
									SUA519	J3
									SUA520	J3
				SPA161	F1		SAG164	H1		
									GA2043	J2
	APS47			SPA161	F1					
							SAC072	H2		
									GA2043	J2



KW



TYPE



TYPE

PEUGEOT

207 (WA_, WC_)

1.6 16V Turbo	Petrol	110	02/06 →						
1.6 16V Turbo	Petrol	115	10/09 →						
1.6 16V Turbo	Petrol	110	07/06 →						
1.6 16V Turbo	Petrol	110	12/06 →	ENGINE: EP6DT					
1.6 16V VTi	Petrol	88	02/07 →						
1.6 16V VTi	Petrol	88	02/07 → 06/09						
1.6 16V VTi	Petrol	88	03/07 → 12/11						
1.6 16V VTi	Petrol	88	02/07 →	ENGINE: EP6					
1.6 HDi	Diesel	66	02/06 →						
1.6 HDi	Diesel	66	02/06 →						
1.6 HDi	Diesel	80	02/06 →						
1.6 HDi	Diesel	80	02/06 →						
1.6 HDi	Diesel	66	02/06 →	ENGINE: DV6ATED					
1.6 HDi	Diesel	66	02/06 →	ENGINE: DV6ATED4					
1.6 HDi	Diesel	80	02/06 →	ENGINE: DV6TED4					
1.6 HDi	Diesel	80	02/06 →	ENGINE: DV6TED4					
1.6 HDi 110	Diesel	82	08/09 →						

207 CC (WD_)

1.6 16V	Petrol	88	02/07 →						
1.6 16V	Petrol	88	03/07 →						
1.6 16V	Petrol	88	02/07 →	ENGINE: EP6					
1.6 16V Turbo	Petrol	110	02/07 →						
1.6 16V Turbo	Petrol	115	10/09 →						
1.6 16V Turbo	Petrol	110	02/07 →	ENGINE: EP6DT					
1.6 HDi	Diesel	80	02/07 →						
1.6 HDi	Diesel	80	02/07 →						
1.6 HDi	Diesel	82	08/09 →						
1.6 HDi	Diesel	80	02/07 →	ENGINE: DV6TED4					
1.6 HDi	Diesel	80	02/07 →	ENGINE: DV6TED4					

207 SW (WK_)

1.4	Petrol	54	06/07 →						
1.4	Petrol	54	06/07 →	ENGINE: TU3A					
1.4 16V	Petrol	70	06/07 →						
1.6 16V	Petrol	88	06/07 →						
1.6 16V	Petrol	88	06/07 →	ENGINE: EP6					
1.6 16V RC	Petrol	128	02/07 →						
1.6 HDi	Diesel	80	06/07 →						
1.6 HDi	Diesel	80	06/07 →						
1.6 HDi	Diesel	66	06/07 →						
1.6 HDi	Diesel	66	06/07 →						
1.6 HDi	Diesel	82	08/09 →						
1.6 HDi	Diesel	66	06/07 →	ENGINE: DV6ATED4					
1.6 HDi	Diesel	66	06/07 →	ENGINE: DV6ATED4					
1.6 HDi	Diesel	80	06/07 →	ENGINE: DV6TED4					

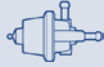

TYPE



TYPE



TYPE

		APS47		SPA161	F1				GA2077	J2
		APS47						SAC072	H2	
									GA2043	J2
		APS71		SPA161	F1				GA2215	J2
								SAC072	H2	
									BAE680BR	
									GA2043	J2
				ATS22	F2			SAC096	H2	
				SPA172	F1			SAG167	H1	
				ATS22	F2			SAC096	H2	
				SPA172	F1			SAG167	H1	
									SUA519	J3
									SUA520	J3
									SUA519	J3
									SUA520	J3
								SAG167	H1	
		APS71		SPA161	F1				GA2215	J2
									BAE680BR	
									GA2043	J2
		APS47		SPA161	F1			SAC072	H2	
		APS47								
									GA2043	J2
		APS38		ATS22	F2			SAC096	H2	
				SPA172	F1			SAG167	H1	
								SAG167	H1	
									SUA519	J3
									SUA520	J3
									GA2215	J2
									GA2043	J2
		APS71		SPA161	F1				BAE680BR	GA2215
		APS71		SPA161	F1				BAE680BR	GA2215
									GA2043	J2
		APS47								
		APS38		ATS22	F2			SAC096	H2	
				SPA172	F1			SAG167	H1	
								SAC096	H2	
								SAG167	H1	
								SAG167	H1	
									SUA519	J3
									SUA520	J3
									SUA519	J3



KW

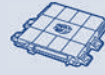

TYPE



TYPE

PEUGEOT

207 SW (WK_)

1.6 HDi	Diesel	80	06/07 →	ENGINE: DV6TED4				
---------	--------	----	---------	-----------------	--	--	--	--

207 Tre volumi

1.4	Petrol	54	12/07 →					
-----	--------	----	---------	--	--	--	--	--

207 Van

1.4 HDi	Diesel	50	04/07 →					
---------	--------	----	---------	--	--	--	--	--

1.6 HDi	Diesel	66	04/07 →					
---------	--------	----	---------	--	--	--	--	--

208

1.4	Petrol	70	03/12 →					
-----	--------	----	---------	--	--	--	--	--

1.4 HDi	Diesel	50	03/12 →					
---------	--------	----	---------	--	--	--	--	--

1.4 HDi	Diesel	50	03/12 →					
---------	--------	----	---------	--	--	--	--	--

1.6	Petrol	88	03/12 →					
-----	--------	----	---------	--	--	--	--	--

1.6 HDi	Diesel	68	03/12 →					
---------	--------	----	---------	--	--	--	--	--

1.6 HDi	Diesel	68	03/12 →					
---------	--------	----	---------	--	--	--	--	--

1.6 HDi	Diesel	84	03/12 →					
---------	--------	----	---------	--	--	--	--	--

1.6 HDi	Diesel	84	03/12 →					
---------	--------	----	---------	--	--	--	--	--

3008

1.6 HDi	Diesel	80	06/09 →					
---------	--------	----	---------	--	--	--	--	--

1.6 HDi	Diesel	82	08/10 →					
---------	--------	----	---------	--	--	--	--	--

1.6 THP	Petrol	110	06/09 →					
---------	--------	-----	---------	--	--	--	--	--

1.6 THP	Petrol	115	06/09 →					
---------	--------	-----	---------	--	--	--	--	--

1.6 VTi	Petrol	88	06/09 →					
---------	--------	----	---------	--	--	--	--	--

306 (7B, N3, N5)

1.1	Petrol	44	06/94 → 05/01					
-----	--------	----	---------------	--	--	--	--	--

B03	B1
------------	----

1.1	Petrol	44	06/94 → 05/01					
-----	--------	----	---------------	--	--	--	--	--

KITPF2C	B6
----------------	----

1.1	Petrol	44	06/94 → 05/01	ENGINE: TU1MZ				
-----	--------	----	---------------	---------------	--	--	--	--

1.1	Petrol	44	06/94 → 12/97					
-----	--------	----	---------------	--	--	--	--	--

1.1	Petrol	44	09/99 → 05/01					
-----	--------	----	---------------	--	--	--	--	--

1.1	Petrol	44	06/94 → 12/95					
-----	--------	----	---------------	--	--	--	--	--

1.1	Petrol	44	01/96 → 04/97					
-----	--------	----	---------------	--	--	--	--	--

1.1	Petrol	44	06/94 → 04/97					
-----	--------	----	---------------	--	--	--	--	--

1.4 SL	Petrol	55	06/94 → 05/01					
--------	--------	----	---------------	--	--	--	--	--

B14	B1
------------	----

1.4 SL	Petrol	55	06/94 → 05/01					
--------	--------	----	---------------	--	--	--	--	--

KITPF2C	B6
----------------	----

1.4 SL	Petrol	55	06/94 → 05/01	ENGINE: KDX(TU3MC) KFX(TU3JP)KFW(TU3JP)				
--------	--------	----	---------------	--	--	--	--	--

B3387	B1
--------------	----

1.4 SL	Petrol	55	01/96 → 12/98	ENGINE: TU3JP,L3				
--------	--------	----	---------------	------------------	--	--	--	--

B24/00	B1
---------------	----

1.4 SL	Petrol	55	01/00 → 11/00	ENGINE: TU3JP,L3				
--------	--------	----	---------------	------------------	--	--	--	--

B32/01	B1
---------------	----

1.4 SL	Petrol	55	06/94 → 05/01	ENGINE: TU3MC				
--------	--------	----	---------------	---------------	--	--	--	--

1.4 SL	Petrol	55	06/94 → 12/98					
--------	--------	----	---------------	--	--	--	--	--

1.4 SL	Petrol	55	10/00 → 05/01					
--------	--------	----	---------------	--	--	--	--	--

1.4 SL	Petrol	55	06/94 → 05/01	ENGINE: TU3JPL,3				
--------	--------	----	---------------	------------------	--	--	--	--

1.4 SL	Petrol	55	06/94 → 05/01	ENGINE: TU3JPL,3				
--------	--------	----	---------------	------------------	--	--	--	--

1.4 SL	Petrol	55	06/94 → 12/97					
--------	--------	----	---------------	--	--	--	--	--

1.4 SL	Petrol	55	01/96 → 05/01					
--------	--------	----	---------------	--	--	--	--	--

1.4 SL	Petrol	55	05/97 → 05/01					
--------	--------	----	---------------	--	--	--	--	--

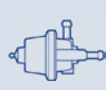

TYPE

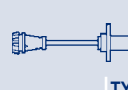

TYPE



TYPE

								SUA520	J3
			SPA107	F1					
							SAG167	H1	
							SAG167	H1	
								BAE680BR	
								SUA564	J3
								SUA565	J3
								BAE680BR	
								SUA564	J3
								SUA565	J3
								SUA564	J3
								SUA565	J3
							SAG167	H1	
							SAG167	H1	
	APS47						SAC072	H2	GA2118
	APS47						SAC072	H2	GA2118
	APS71						SAC072	H2	BAE680BR
			KITATS05	F2			SAG028	H1	ESS0034A
									GA2193
	PRT03/04		SZA102	F1					
			SPA104	F1					
							SAG027	H1	
								BAE680CV	
								BAE680AF	
								SUA141	J3
FEI0002	PRT03E/04		KITATS05	F2	SAA118	SAD033	H3	BAE680AF	ESS0014A
			SPA102	F1		SAG028	H1		GA2193
	PRT03/04		SZA102	F1					
	APS76								
	APS77		SPA167	F1		SAG164	H1		
		KITRPM40	SZA101	F1					
		RPM40							
			SPA104	F1					
			IATS04	F2					
			SPA164	F1		SAC064	H2		



KW



TYPE



TYPE

PEUGEOT

306 (7B, N3, N5)

1.4 SL	Petrol	55	06/94 → 02/98					
1.4 SL	Petrol	55	05/97 → 05/01					
1.4 SL	Petrol	55	09/99 → 05/01					
1.4 SL	Petrol	55	06/94 → 04/97					
1.4 SL	Petrol	55	01/97 → 05/01	ENGINE: C(TU3-2)				
1.4 SL	Petrol	55	01/97 → 05/01	ENGINE: TU3JP				
1.6	Petrol	72	10/00 → 05/01	ENGINE: NFT			B3388	B1
1.6	Petrol	72	10/00 → 05/01					
1.6	Petrol	72	10/00 → 05/01					
1.6	Petrol	72	10/00 → 05/01	ENGINE: TU5JP				
1.6 SR	Petrol	65	06/94 → 10/00	ENGINE: TU5JP			B31/2	B1
1.6 SR	Petrol	65	06/94 → 04/97				SVF015	B6
1.6 SR	Petrol	65	06/98 → 02/99					
1.6 SR	Petrol	65	06/94 → 10/00					
1.6 SR	Petrol	65	06/94 → 12/97					
1.6 SR	Petrol	65	06/98 → 10/00					
1.6 SR	Petrol	65	06/94 → 02/98					
1.6 SR	Petrol	65	03/98 → 10/00					
1.6 SR	Petrol	65	09/99 → 10/00					
1.6 SR	Petrol	65	05/97 → 06/98					
1.6 SR	Petrol	65	01/97 → 10/00					
1.6 SR	Petrol	65	01/97 → 10/00	ENGINE: TU5JP				
1.8	Petrol	74	10/95 → 04/97					
1.8 16V	Petrol	81	03/97 → 05/01				B22/1	B1
1.8 16V	Petrol	81	03/97 → 05/01	ENGINE: XU7JP,K				
1.8 16V	Petrol	81	03/97 → 11/98					
1.8 16V	Petrol	81	03/97 → 05/01	ENGINE: XU7JP,K				
1.8 16V	Petrol	81	09/99 → 05/01					
1.8 16V	Petrol	81	03/97 → 05/01	ENGINE: XU7JP4				
1.8 ST	Petrol	74	06/94 → 02/98	ENGINE: XU7JP	IAW8P.10/3	A1		
1.8 ST	Petrol	74	06/94 → 04/01	ENGINE: XU7JPZ	IAW8P.10/2	A1		
1.8 ST	Petrol	74	06/94 → 05/01				B04	B1
1.8 ST	Petrol	74	06/94 → 05/01				PF90/018	B6
1.8 ST	Petrol	74	01/96 → 05/01				PF16080067	B6
1.8 ST	Petrol	74	06/94 → 05/01	ENGINE: XU7JP,L3				
1.8 ST	Petrol	74	06/94 → 05/01	ENGINE: XU7JP,L3				
1.8 ST	Petrol	74	09/99 → 05/01					
1.8 ST	Petrol	74	06/94 → 04/97					
1.8 ST	Petrol	74	01/97 → 05/01	ENGINE: XU7JP4				
1.9 D	Diesel	51	09/98 → 05/01					
1.9 D	Diesel	51	09/99 → 05/01					
1.9 D	Diesel	55	03/98 → 05/01					
1.9 D	Diesel	55	09/99 → 05/01					
1.9 D	Diesel	51	09/98 → 05/01	ENGINE: XUD9				

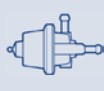

TYPE

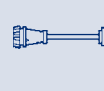

TYPE



TYPE

							SAG156	H1			
							SAD030	H3			
							SAG027	H1			
									BAE680CV	SUA141	J3
										SUA383	J3
										SUA376	J2
	APS77		SPA167	F1	SAA118	SAD030	H3				
						SAG027	H1				
										SUA376	J2
	APS29								BAE680CV	SUA141	J3
	APS76										
			SPA102	F1		SAG028	H1			ESS0014A	J1
			SPA104	F1							
			SPA164	F1							
						SAG156	H1				
						SAD030	H3				
						SAG027	H1				
									BAE680AF		
										SUA455	J2
										SUA376	J2
									BAE680AF		
					SAA118	SAG028	H1			ESS0091A	J1
	PRT03/04	KITRPM36	SZA101	F1							
	APS76										
		RPM36									
						SAG027	H1				
										SUA376	J2
	PRT03E/04				SAA118	SAG028	H1	BAE680AF		ESS0014A	J1
	PRT03/04	KITRPM36	SZA101	F1							
		RPM36									
						SAG027	H1				
										SUA141	J3
										SUA376	J2
			SPA167	F1	SAA118	SAG028	H1				
						SAG027	H1				
						SAG028	H1				
						SAG027	H1				
										SUA383	J3



KW



TYPE



TYPE

PEUGEOT

306 (7B, N3, N5)

1.9 D	Diesel	55	03/98 → 05/01	ENGINE: (DW8)				
1.9 SLD	Diesel	47	06/94 → 05/01					
1.9 SLD	Diesel	47	09/99 → 05/01					
1.9 SLD	Diesel	50	06/94 → 05/01					
1.9 SLD	Diesel	50	09/99 → 05/01					
1.9 SLD	Diesel	47	06/94 → 06/94					
1.9 SLD	Diesel	50	07/96 → 04/97					
1.9 SRDT	Diesel	66	06/94 → 05/01					
1.9 SRDT	Diesel	66	09/99 → 05/01					
1.9 SRDT	Diesel	66	06/94 → 04/97					
2.0	Petrol	97	03/97 → 05/01				B04	B1
2.0	Petrol	97	03/97 → 05/01				PF16080067	B6
2.0	Petrol	97	03/97 → 05/01	ENGINE: (ES9J4-XU10J4RS)			CA0005504	B6
2.0	Petrol	97	03/97 → 12/98					
2.0	Petrol	97	09/99 → 05/01					
2.0	Petrol	97	03/97 → 05/01	ENGINE: XU10J4RS				
2.0 HDI 90	Diesel	66	06/99 → 05/01					
2.0 HDI 90	Diesel	66	09/99 → 05/01					
2.0 HDI 90	Diesel	66	06/99 → 05/01	ENGINE: DW10TD				
2.0 S16	Petrol	110	05/96 → 10/00	ENGINE: XU10J4RS	IAW1AP.10	A1		
2.0 S16	Petrol	112	05/96 → 10/00	ENGINE: XU10J4RS	IAW1AP.10	A1		
2.0 S16	Petrol	110	06/94 → 06/95				SVF015	B6
2.0 S16	Petrol	112	06/94 → 06/95				SVF015	B6
2.0 S16	Petrol	110	06/94 → 05/01	ENGINE: XU10J4RS				
2.0 S16	Petrol	110	06/94 → 05/01	ENGINE: XU10J4RS				
2.0 S16	Petrol	112	06/94 → 05/01	ENGINE: XU10J4RS				
2.0 S16	Petrol	112	06/94 → 05/01	ENGINE: XU10J4RS				
2.0 S16	Petrol	110	06/94 → 05/01					
2.0 S16	Petrol	110	06/94 → 05/01					
2.0 S16	Petrol	110	09/99 → 05/01					
2.0 S16	Petrol	112	06/94 → 05/01					
2.0 S16	Petrol	112	06/94 → 05/01					
2.0 S16	Petrol	112	09/99 → 05/01					
2.0 S16	Petrol	110	06/94 → 05/01	ENGINE: XU10J4(RFT)				
2.0 S16	Petrol	110	08/94 → 04/97					
2.0 S16	Petrol	112	06/94 → 04/97					
2.0 ST	Petrol	89	07/94 → 05/01				B04	B1
2.0 ST	Petrol	89	07/94 → 05/01	ENGINE: XU10J2CK				
2.0 ST	Petrol	89	07/94 → 05/01	ENGINE: XU10J2CK				
2.0 ST	Petrol	89	09/99 → 05/01					
2.0 ST	Petrol	89	07/94 → 04/97					



KW

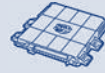

TYPE



TYPE

PEUGEOT

306 2 volumi /Coda spiovente (7A, 7C, N3, N5)

1.1	Petrol	44	05/93 → 05/01				B03	B1
1.1	Petrol	44	05/93 → 05/01				KITPF2C	B6
1.1	Petrol	44	05/93 → 12/97					
1.1	Petrol	44	09/99 → 05/01					
1.1	Petrol	44	05/93 → 12/95					
1.1	Petrol	44	01/96 → 04/97					
1.1	Petrol	44	05/93 → 04/97					
1.4	Petrol	55	05/93 → 05/01				KITPF2C	B6
1.4	Petrol	55	05/93 → 05/01	ENGINE: TU3JP,L3			B24/00	B1
1.4	Petrol	55	01/94 → 05/01				B14	B1
1.4	Petrol	55	01/00 → 11/00	ENGINE: TU3JP,L3			B32/01	B1
1.4	Petrol	55	05/93 → 05/01					
1.4	Petrol	55	05/93 → 12/98					
1.4	Petrol	55	10/00 → 05/01					
1.4	Petrol	55	05/93 → 12/97					
1.4	Petrol	55	01/96 → 05/01					
1.4	Petrol	55	05/97 → 05/01					
1.4	Petrol	55	05/93 → 02/98					
1.4	Petrol	55	05/97 → 05/01					
1.4	Petrol	55	09/99 → 05/01					
1.4	Petrol	55	05/93 → 04/97					
1.4	Petrol	55	09/96 → 04/97					
1.4	Petrol	55	05/93 → 04/97					
1.4	Petrol	55	01/98 → 05/01	ENGINE: C(TU3-2)				
1.6	Petrol	65	05/93 → 10/00	ENGINE: TU5JP			B31/2	B1
1.6	Petrol	65	05/93 → 04/97				SVF015	B6
1.6	Petrol	65	06/98 → 02/99					
1.6	Petrol	72	10/00 → 05/01					
1.6	Petrol	65	05/93 → 10/00					
1.6	Petrol	65	05/93 → 12/97					
1.6	Petrol	65	06/98 → 10/00					
1.6	Petrol	72	10/00 → 05/01					
1.6	Petrol	65	05/93 → 02/98					
1.6	Petrol	65	03/98 → 10/00					
1.6	Petrol	65	09/99 → 10/00					
1.6	Petrol	65	05/97 → 06/98					
1.6	Petrol	65	01/97 → 10/00	ENGINE: TU5JP				
1.8	Petrol	74	05/93 → 02/98	ENGINE: XU7JP	IAW8P.10/3	A1		
1.8	Petrol	74	05/93 → 04/01	ENGINE: XU7JPZ	IAW8P.10/2	A1		
1.8	Petrol	74	09/97 → 04/99	ENGINE: XU7JPK	IAW8P1.A/2	A1		
1.8	Petrol	74	05/93 → 05/01				B04	B1
1.8	Petrol	74	05/93 → 05/01				PF90/018	B6
1.8	Petrol	74	09/99 → 05/01					
1.8	Petrol	74	05/93 → 04/97					

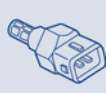
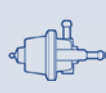

TYPE

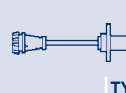

TYPE



TYPE

				KITATS05	F2		SAG028	H1		GA2193	J2
				SPA104	F1						
							SAG027	H1			
										BAE680CV	
										BAE680AF	
										SUA141	J3
FEI0002	PRT03E/04			KITATS05	F2	SAA118	SAG028	H1		ESS0014A	J1
				SPA102	F1					GA2193	J2
	APS76										
	APS77			SPA167	F1		SAG164	H1			
				SPA104	F1						
				IATS04	F2						
				SPA164	F1		SAC064	H2			
							SAG156	H1			
							SAD030	H3			
							SAG027	H1			
										BAE680CV	PB507
										BAE680AF	
										SUA141	J3
										SUA383	J3
	APS29									BAE680CV	SUA141
	APS76										
	APS77			SPA167	F1	SAA118	SAD030	H3			
				SPA102	F1		SAG028	H1		ESS0014A	J1
				SPA104	F1						
				SPA164	F1						
							SAG027	H1			
							SAG156	H1			
							SAD030	H3			
							SAG027	H1			
										BAE680AF	
										SUA376	J2
	PRT03E/04			SPA102	F1	SAA118	SAG028	H1		ESS0014A	J1
							SAG027	H1			
										BAE680AF	SUA141
											J3

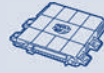

KW

TYPE

TYPE
PEUGEOT
306 2 volumi /Coda spiovente (7A, 7C, N3, N5)

1.8	Petrol	74	05/97 → 04/99					
1.8 16V	Petrol	81	03/97 → 11/98					
1.8 16V	Petrol	81	03/97 → 05/01					
1.8 16V	Petrol	81	09/99 → 05/01					
1.8 D	Diesel	43	05/93 → 05/01					
1.8 D	Diesel	43	09/99 → 05/01					
1.8 D	Diesel	43	05/93 → 04/97					
1.9 D	Diesel	51	09/98 → 05/01					
1.9 D	Diesel	47	05/93 → 05/01					
1.9 D	Diesel	47	09/99 → 05/01					
1.9 D	Diesel	50	06/94 → 05/01					
1.9 D	Diesel	50	09/99 → 05/01					
1.9 D	Diesel	51	09/99 → 05/01					
1.9 D	Diesel	55	03/98 → 05/01					
1.9 D	Diesel	55	09/99 → 05/01					
1.9 D	Diesel	47	05/93 → 06/94					
1.9 DT	Diesel	66	05/93 → 05/01					
1.9 DT	Diesel	66	09/99 → 05/01					
1.9 DT	Diesel	66	05/93 → 04/97					
2.0 16V	Petrol	97	03/97 → 10/00	ENGINE: XU10J4RS	IAW1AP.10	A1		
2.0 16V	Petrol	97	03/97 → 12/98					
2.0 16V	Petrol	97	03/97 → 05/01					
2.0 16V	Petrol	97	03/97 → 05/01					
2.0 16V	Petrol	97	09/99 → 05/01					
2.0 HDI 90	Diesel	66	06/99 → 05/01					
2.0 HDI 90	Diesel	66	09/99 → 05/01					
2.0 HDI 90	Diesel	66	06/99 → 05/01	ENGINE: DW10TD				
2.0 S16	Petrol	110	05/96 → 10/00	ENGINE: XU10J4RS	IAW1AP.10	A1		
2.0 S16	Petrol	112	05/96 → 10/00	ENGINE: XU10J4RS	IAW1AP.10	A1		
2.0 S16	Petrol	110	06/94 → 06/95			SVF015	B6	
2.0 S16	Petrol	112	05/93 → 06/95			SVF015	B6	
2.0 S16	Petrol	110	06/94 → 05/01					
2.0 S16	Petrol	110	06/94 → 05/01					
2.0 S16	Petrol	110	09/99 → 05/01					
2.0 S16	Petrol	112	05/93 → 05/01					
2.0 S16	Petrol	112	05/93 → 05/01					
2.0 S16	Petrol	112	05/93 → 05/01					
2.0 S16	Petrol	112	09/99 → 05/01					
2.0 S16	Petrol	110	01/97 → 05/01	ENGINE: XU10J4RS				
2.0 S16	Petrol	110	08/94 → 04/97					
2.0 S16	Petrol	112	08/93 → 04/97					
2.0 XSi	Petrol	89	05/93 → 05/01			B04	B1	
2.0 XSi	Petrol	89	05/93 → 05/01			PF90/018	B6	

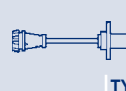

TYPE



TYPE



TYPE

							BAE680AF			
APS76										
					SAA118	SAG028	H1	ESS0091A	J1	
						SAG027	H1			
		SPA102	F1	SAA118	SAG028	H1				
					SAG027	H1				
								SUA141	J3	
		SPA167	F1	SAA118	SAG028	H1				
					SAG028	H1				
					SAG027	H1				
					SAG028	H1		SUA141	J3	
					SAG027	H1				
					SAG027	H1				
					SAG028	H1				
					SAG027	H1				
								SUA141	J3	
		SPA102	F1	SAA118	SAG028	H1				
					SAG027	H1				
								SUA141	J3	
APS76										
					SAA118	SAD008	H3	BAE680AY	ESS0091A	J1
						SAG028	H1			
						SAG027	H1			
					SAA118	SAG028	H1			
						SAG027	H1			
								SUA460	J2	
						SAC064	H2		ESS0014A	J1
						SAD013	H3			
						SAG028	H1			
						SAG027	H1			
						SAC064	H2		ESS0014A	J1
						SAD013	H3			
						SAG028	H1			
						SAG027	H1			
								SUA376	J2	
								SUA141	J3	
								SUA141	J3	
		SPA102	F1		SAG028	H1		ESS0014A	J1	



KW

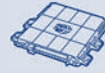

TYPE



TYPE

PEUGEOT

306 2 volumi /Coda spiovente (7A, 7C, N3, N5)

2.0 XSi	Petrol	89	05/93 → 05/01	ENGINE: (ES9J4-XU10J4RS)			CA0005504	B6
2.0 XSi	Petrol	89	09/99 → 05/01					
2.0 XSi	Petrol	89	08/93 → 04/97					
2.0 XSi	Petrol	89	01/97 → 05/01	ENGINE: XU10J4RS				

306 Break (7E, N3, N5)

1.4	Petrol	55	03/97 → 04/02				B14	B1
1.4	Petrol	55	03/97 → 04/02				KITPF2C	B6
1.4	Petrol	55	03/97 → 04/02	ENGINE: KFX(TU3JP) KFW(TU3JP)			B3387	B1
1.4	Petrol	55	03/97 → 04/02	ENGINE: TU3JP,L3			B24/00	B1
1.4	Petrol	55	01/00 → 11/00	ENGINE: TU3JP,L3			B32/01	B1
1.4	Petrol	55	03/97 → 04/02					
1.4	Petrol	55	03/97 → 04/02	ENGINE: TU3MC				
1.4	Petrol	55	03/97 → 12/98					
1.4	Petrol	55	10/00 → 03/02					
1.4	Petrol	55	03/97 → 04/02	ENGINE: TU3JPL,3				
1.4	Petrol	55	03/97 → 04/02	ENGINE: TU3JPL,3				
1.4	Petrol	55	05/97 → 03/02					
1.4	Petrol	55	03/97 → 02/98					
1.4	Petrol	55	09/99 → 04/02					
1.4	Petrol	55	10/00 → 04/02					
1.4	Petrol	55	05/97 → 06/98					
1.4	Petrol	55	03/97 → 04/02	ENGINE: C(TU3-2)				
1.4	Petrol	55	03/97 → 04/02	ENGINE: TU3JP				
1.6	Petrol	65	03/97 → 10/00	ENGINE: TU5JP			B31/2	B1
1.6	Petrol	72	10/00 → 04/02	ENGINE: NFT			B3388	B1
1.6	Petrol	65	05/97 → 05/98					
1.6	Petrol	65	06/98 → 02/99					
1.6	Petrol	72	10/00 → 03/02					
1.6	Petrol	65	03/97 → 10/00					
1.6	Petrol	65	03/97 → 12/97					
1.6	Petrol	65	06/98 → 10/00					
1.6	Petrol	72	10/00 → 04/02					
1.6	Petrol	65	03/97 → 02/98					
1.6	Petrol	65	03/98 → 10/00					
1.6	Petrol	65	09/99 → 10/00					
1.6	Petrol	72	10/00 → 04/02					
1.6	Petrol	65	05/97 → 06/98					
1.8	Petrol	74	03/97 → 02/98	ENGINE: XU7JP	IAW8P.10/3	A1		
1.8	Petrol	74	03/97 → 04/01	ENGINE: XU7JPZ	IAW8P.10/2	A1		
1.8	Petrol	74	09/97 → 04/99	ENGINE: XU7JPK	IAW8P1.A/2	A1		
1.8	Petrol	74	03/97 → 04/02				B04	B1
1.8	Petrol	74	03/97 → 04/02	ENGINE: XU7JP,L3				
1.8	Petrol	74	03/97 → 04/02	ENGINE: XU7JP,L3				



TYPE



TYPE



TYPE

						SAG027	H1			
								BAE680AF	SUA141	J3
									SUA376	J2
FEI0002	PRT03E/04		IATS04	F2	SAA118	SAC064	H2		ESS0091A	J1
			SPA102	F1		SAD030	H3			
						SAG028	H1			
	PRT03/04		SZA102	F1						
	APS76									
	APS77		SPA167	F1						
		KITRPM40	SZA101	F1						
		RPM40								
			SPA164	F1						
						SAG156	H1			
						SAG027	H1			
						SAG164	H1			
								BAE680AF		
									SUA383	J3
									SUA376	J2
									SUA376	J2
	APS29									
	APS76									
	APS77		SPA167	F1						
			SPA102	F1		SAG028	H1		ESS0091A	J1
			SPA104	F1						
			SPA164	F1						
					SAA118	SAD030	H3		ESS0091A	J1
						SAG156	H1			
						SAD030	H3			
						SAG027	H1			
						SAG027	H1			
								BAE680AF		
	PRT03E/04		SPA102	F1	SAA118	SAG028	H1		ESS0091A	J1
	PRT03/04	KITRPM36	SZA101	F1						
		RPM36								



KW



TYPE



TYPE

PEUGEOT

306 Break (7E, N3, N5)

1.8	Petrol	74	09/99 → 04/02						
1.8	Petrol	74	05/97 → 03/02						
1.8	Petrol	74	03/97 → 04/02	ENGINE: XU7JP4					
1.8 16V	Petrol	81	03/97 → 11/98						
1.8 16V	Petrol	81	03/97 → 04/02						
1.8 16V	Petrol	81	09/99 → 04/02						
1.8 16V	Petrol	81	03/97 → 04/02	ENGINE: XU7JP4					
1.9 D	Diesel	51	09/98 → 04/02						
1.9 D	Diesel	50	03/97 → 04/02						
1.9 D	Diesel	50	09/99 → 04/02						
1.9 D	Diesel	51	09/99 → 04/02						
1.9 D	Diesel	55	03/98 → 04/02						
1.9 D	Diesel	55	09/99 → 04/02						
1.9 D	Diesel	50	01/98 → 04/02	ENGINE: XUD9TE					
1.9 D	Diesel	51	09/98 → 04/02	ENGINE: XUD9TE					
1.9 D	Diesel	55	03/98 → 04/02	ENGINE: (DW8)					
1.9 TD	Diesel	66	02/97 → 04/02						
1.9 TD	Diesel	66	09/99 → 04/02						
2.0	Petrol	97	03/97 → 04/02				B04		B1
2.0	Petrol	97	03/97 → 12/98						
2.0	Petrol	97	03/97 → 04/02						
2.0	Petrol	97	09/99 → 04/02						
2.0	Petrol	97	03/97 → 04/02	ENGINE: XU10J4RS					
2.0 HDI 90	Diesel	66	06/99 → 04/02						
2.0 HDI 90	Diesel	66	06/99 → 12/01	ENGINE: DW10TD					

306 Cabriolet (7D, N3, N5)

1.6	Petrol	72	10/00 → 04/02	ENGINE: NFT			B3388		B1
1.6	Petrol	72	10/00 → 04/02						
1.6	Petrol	72	10/00 → 04/02						
1.8	Petrol	74	03/94 → 02/98	ENGINE: XU7JP	IAW8P.10/3	A1			
1.8	Petrol	74	03/94 → 04/01	ENGINE: XU7JPZ	IAW8P.10/2	A1			
1.8	Petrol	74	09/97 → 04/99	ENGINE: XU7JPK	IAW8P1.A/2	A1			
1.8	Petrol	74	03/94 → 04/02				B04		B1
1.8	Petrol	74	03/94 → 04/02				PF90/018		B6
1.8	Petrol	74	09/99 → 04/02						
1.8	Petrol	74	03/94 → 04/97						
1.8	Petrol	74	05/97 → 04/99						
1.8	Petrol	74	03/94 → 04/95						
1.8	Petrol	74	05/98 → 04/02						
1.8 16V	Petrol	81	07/00 → 04/02						
2.0	Petrol	89	03/94 → 04/02				B04		B1
2.0	Petrol	89	03/94 → 04/02				PF90/018		B6
2.0	Petrol	89	03/94 → 04/02	ENGINE: (ES9J4-XU10J4RS)			CA0005504		B6
2.0	Petrol	89	09/99 → 04/02						

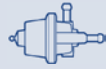

TYPE



TYPE



TYPE

						SAG027	H1			
								BAE680AF		
									SUA376	J2
	APS76									
					SAA118	SAG028	H1		ESS0091A	J1
						SAG027	H1			
									SUA376	J2
		SPA167	F1	SAA118	SAG028	H1				
				SAA118	SAG028	H1				
					SAG027	H1				
					SAG027	H1				
					SAG028	H1				
					SAG027	H1				
									SUA383	J3
									SUA383	J3
									SUA383	J3
				SAA118	SAG028	H1				
					SAG027	H1				
				SAA118	SAD008	H3			ESS0091A	J1
	APS76									
						SAG028	H1			
						SAG027	H1			
									SUA376	J2
				SAA118						
									SUA460	J2
	APS77		SPA167	F1	SAA118	SAD030	H3			
						SAG027	H1			
	PRT03E/04		SPA102	F1	SAA118	SAG028	H1		ESS0014A	J1
						SAG027	H1			
								BAE680AF		
								BAE680AF		
									SUA138	J3
									SUA455	J2
					SAA118	SAG027	H1		SUA455	J2
	PRT03E/04					SAG028	H1		ESS0014A	J1
						SAG027	H1			



KW

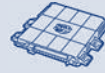

TYPE



TYPE

PEUGEOT

306 Cabriolet (7D, N3, N5)

2.0	Petrol	89	03/94 → 04/97					
2.0	Petrol	89	03/94 → 04/95					
2.0	Petrol	89	05/98 → 04/02					
2.0 16V	Petrol	97	03/97 → 10/00	ENGINE: XU10J4RS	IAW1AP.10	A1		
2.0 16V	Petrol	97	03/97 → 04/02				B3385	B1
2.0 16V	Petrol	97	03/97 → 12/98					
2.0 16V	Petrol	97	03/97 → 04/02					
2.0 16V	Petrol	97	09/99 → 04/02					

307 (3A/C)

1.4	Petrol	55	04/02 → 09/03	ENGINE: KFW(TU3JP)			42SXPP31	B3
1.4	Petrol	55	05/05 →	ENGINE: TU3JP			B35/00	B1
1.4	Petrol	55	08/00 →					
1.4	Petrol	55	08/00 →	ENGINE: ET3				
1.4	Petrol	55	08/00 → 05/05					
1.4	Petrol	55	08/00 →					
1.4 16V	Petrol	65	11/03 →	ENGINE: KFUET3J4			50SMP1	B3
1.4 16V	Petrol	65	11/03 →	ENGINE: ET3				
1.4 16V	Petrol	65	11/03 →					
1.4 HDi	Diesel	50	10/01 →				AMM19765	B4
1.4 HDi	Diesel	50	10/01 →					
1.4 HDi	Diesel	50	10/01 → 05/05					
1.6 16V	Petrol	80	08/00 →				TB0015	B3
1.6 16V	Petrol	80	08/00 →					
1.6 16V	Petrol	80	06/05 →					
1.6 Bioflex	BiFuel	80	09/07 →					
1.6 HDi	Diesel	66	04/05 →					
1.6 HDi	Diesel	66	04/05 →					
1.6 HDi	Diesel	66	04/05 → 05/05					
1.6 HDi 110	Diesel	80	02/04 →					
1.6 HDi 110	Diesel	80	02/04 →					
1.6 HDi 110	Diesel	80	06/05 →					
1.6 HDi 110	Diesel	80	02/04 → 05/05					
1.6 HDi 110	Diesel	80	04/06 →	ENGINE: DW10ATED				
2.0 16V	Petrol	100	08/00 →		IAW48P2.36/1	A1		
2.0 16V	Petrol	103	03/05 →					
2.0 16V	Petrol	130	06/05 →					
2.0 16V	Petrol	100	08/00 →					
2.0 16V	Petrol	103	03/05 →					
2.0 16V	Petrol	100	08/00 → 05/05					
2.0 HDi 110	Diesel	79	08/00 →	ENGINE: RHS(DW10ATED)			52SXP31	B3
2.0 HDi 110	Diesel	79	08/00 →					
2.0 HDi 110	Diesel	79	04/06 →	ENGINE: DW12TD				
2.0 HDi 135	Diesel	100	10/03 →	ENGINE: RHR(DW10BTED4)			50CDDP8	B3
2.0 HDi 135	Diesel	100	10/03 →					



KW



TYPE



TYPE

PEUGEOT

307 (3A/C)

2.0 HDi 135	Diesel	100	10/03 →					
2.0 HDi 135	Diesel	100	10/03 → 05/05					
2.0 HDi 135	Diesel	100	04/06 →	ENGINE: DW12TD				
2.0 HDi 90	Diesel	66	08/00 →					
2.0 HDi 90	Diesel	66	08/00 →					
2.0 HDi 90	Diesel	66	08/00 → 05/05					

307 Break (3E)

1.4	Petrol	55	04/02 → 09/03	ENGINE: TU3JP,KFW(TU3JP)			42SXPP31	B3
1.4	Petrol	55	04/02 → 09/03					
1.4 16V	Petrol	65	11/03 →	ENGINE: KFUET3J4			50SMP1	B3
1.4 16V	Petrol	65	11/03 →	ENGINE: ET3				
1.4 16V	Petrol	65	11/03 →					
1.4 16V	Petrol	65	06/05 → 06/06	ENGINE: TU3JP4				
1.4 HDi	Diesel	50	03/02 →				AMM19765	B4
1.4 HDi	Diesel	50	03/02 →					
1.6 16V	Petrol	80	03/02 →				TB0015	B3
1.6 16V	Petrol	80	03/02 →					
1.6 16V	Petrol	80	06/05 →					
1.6 16V	Petrol	80	06/05 → 06/06	ENGINE: TU3JP4				
1.6 Bioflex	BiFuel	80	09/07 →					
1.6 HDi	Diesel	66	04/05 →					
1.6 HDi	Diesel	66	04/05 →					
1.6 HDi	Diesel	66	04/05 →	ENGINE: SIEMENSSYSTEM				
1.6 HDi 110	Diesel	80	02/04 →					
1.6 HDi 110	Diesel	80	02/04 →					
1.6 HDi 110	Diesel	80	06/05 →					
1.6 HDi 110	Diesel	80	02/04 → 05/05					
2.0	Petrol	100	03/02 →			IAW48P2.36/1	A1	
2.0	Petrol	100	03/02 →					
2.0	Petrol	100	03/02 → 05/05					
2.0 16V	Petrol	103	03/05 →	ENGINE: EW10J4			B33	B1
2.0 16V	Petrol	103	03/05 →					
2.0 16V	Petrol	130	06/05 →					
2.0 16V	Petrol	103	03/05 →					
2.0 HDi 110	Diesel	79	03/02 →					
2.0 HDi 110	Diesel	79	03/02 → 05/05					
2.0 HDi 110	Diesel	79	06/05 → 03/06	ENGINE: DW10ATED				
2.0 HDi 135	Diesel	100	02/04 →	ENGINE: RHR(DW10BTED4)			50CDDP8	B3
2.0 HDi 135	Diesel	100	02/04 →					
2.0 HDi 135	Diesel	100	02/04 →					
2.0 HDi 135	Diesel	100	02/04 → 05/05					
2.0 HDi 135	Diesel	100	06/05 → 03/06	ENGINE: DW10ATED				
2.0 HDi 90	Diesel	66	03/02 →					
2.0 HDi 90	Diesel	66	03/02 → 05/05					



TYPE

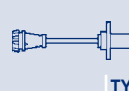

TYPE



TYPE

			SPA172	F1							
										SUA456	J3
										SUA510	J3
	APS38		SPA172	F1	SAA118					SUA456	J3
										SUA493	J2
						SAG157	H1				
						SAG164	H1				
IPM012											
	APS77		SPA107	F1	SAA118	SAG164	H1	BAE680CA			
										GA2035	J2
			SPA172	F1	SAA118	SAC100	H2			SUA494	J2
						SAG167	H1				
	APS77		SPA107	F1	SAA118	SAG126	H1			ESS0015A	J1
										GA2000	J2
			SPA161	F1							
										GA2035	J2
						SAG167	H1				
	APS38		ATS22	F2	SAA118	SAC096	H2				
			SPA172	F1		SAG167	H1				
										SUA517	J3
	APS38		ATS22	F2	SAA118	SAC096	H2				
						SAG167	H1				
			SPA172	F1							
										SUA467	J2
		RPM58	IATS04/01	F2	SAA118	SAC070	H2			GA2000	J2
			SPA107	F1							
						SAG157	H1				
	APS77		SPA172	F1	SAA118	SAC070	H2				
	APS77		SPA107	F1	SAA118	SAC070	H2				
						SAG164	H1				
	APS38		SPA172	F1	SAA118					SUA494	J2
										SUA467	J2
										SUA517	J3
	APS38		ATS22	F2	SAA118	SAG169	H1			SUA493	J2
			SPA172	F1							
										SUA467	J2
										SUA517	J3
	APS38		SPA172	F1	SAA118						
						SAG157	H1			SUA467	J2



KW



TYPE



TYPE

PEUGEOT

307 Break (3E)

2.0 HDi 90	Diesel	66	03/02 →	ENGINE: SIEMENSSYSTEM				
------------	--------	----	---------	-----------------------	--	--	--	--

307 CC (3B)

1.6 16V	Petrol	80	02/05 →					
1.6 16V	Petrol	80	02/05 →					
2.0 16V	Petrol	130	10/03 →	ENGINE: EW10J4S	IAW6LPA.02	A1		
2.0 16V	Petrol	103	03/05 →	ENGINE: EW10J4			B33	B1
2.0 16V	Petrol	100	10/03 → 05/05					
2.0 16V	Petrol	103	03/05 →					
2.0 16V	Petrol	130	10/03 →					
2.0 16V	Petrol	100	10/03 →					
2.0 16V	Petrol	100	10/03 →					
2.0 16V	Petrol	103	03/05 →					
2.0 HDi 135	Diesel	100	06/05 →	ENGINE: RHR(DW10BTED4)			50CDDP8	B3
2.0 HDi 135	Diesel	100	06/05 →					
2.0 HDi 135	Diesel	100	06/05 →					
2.0 HDi 135	Diesel	100	07/06 →	ENGINE: DW12TD				

307 SW (3H)

1.4	Petrol	55	04/02 → 09/03	ENGINE: KFW(TU3JP)			42SXPP31	B3
1.4	Petrol	55	04/02 → 09/03					
1.4 16V	Petrol	65	11/03 →	ENGINE: KFUET3J4			50SMP1	B3
1.4 16V	Petrol	65	11/03 →	ENGINE: ET3				
1.4 16V	Petrol	65	11/03 →					
1.4 16V	Petrol	65	06/05 → 06/06	ENGINE: TU3JP4				
1.6 16V	Petrol	80	03/02 →				TB0015	B3
1.6 16V	Petrol	80	03/02 →					
1.6 16V	Petrol	80	06/05 →					
1.6 16V	Petrol	80	06/05 → 06/06	ENGINE: TU3JP4				
1.6 Bioflex	BiFuel	80	09/07 →					
1.6 HDi 110	Diesel	80	02/04 →					
1.6 HDi 110	Diesel	80	02/04 →					
1.6 HDi 110	Diesel	80	02/04 → 05/05					
1.6 HDi 90	Diesel	66	12/06 →					
2.0 16V	Petrol	100	03/02 →		IAW48P2.36/1	A1		
2.0 16V	Petrol	103	03/05 →	ENGINE: EW10J4			B33	B1
2.0 16V	Petrol	103	03/05 →					
2.0 16V	Petrol	100	03/02 →					
2.0 16V	Petrol	103	03/05 →					
2.0 16V	Petrol	100	03/02 → 05/05					
2.0 HDi 110	Diesel	79	03/02 →					
2.0 HDi 110	Diesel	79	03/02 → 05/05					
2.0 HDi 110	Diesel	79	06/05 → 03/06	ENGINE: DW10ATED				
2.0 HDi 135	Diesel	100	02/04 →	ENGINE: RHR(DW10BTED4)			50CDDP8	B3
2.0 HDi 135	Diesel	100	02/04 →					
2.0 HDi 135	Diesel	100	02/04 →					



TYPE

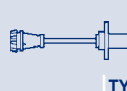

TYPE



TYPE

								SUA517	J3
	APS77	SPA107	F1	SAA118	SAG126	H1		ESS0015A	J1
								GA2042	J2
	APS62								
	APS77	SPA172	F1	SAA118	SAC070	H2		GA2042	J2
	APS77	SPA107	F1	SAA118	SAC070	H2		GA2042	J2
		IATS04/01	F2	SAA118	SAC070	H2		GA2000	J2
		SPA107	F1						
					SAG164	H1			
	APS38	ATS22	F2	SAA118	SAG169	H1		SUA456	J3
		SPA172	F1					SUA493	J2
								SUA510	J3
					SAG164	H1			
IPM012									
	APS77	SPA107	F1	SAA118	SAG164	H1	BAE680CA		
								GA2035	J2
	APS77	SPA107	F1	SAA118	SAD033	H3		ESS0015A	J1
					SAG126	H1		GA2000	J2
		SPA161	F1						
								GA2035	J2
					SAG167	H1			
	APS38	ATS22	F2	SAA118	SAC096	H2			
		SPA172	F1		SAG167	H1			
								SUA467	J2
					SAG167	H1			
		IATS04/01	F2		SAC070	H2		GA2000	J2
	APS77	SPA172	F1		SAC070	H2			
		SPA107	F1		SAD033	H3			
					SAG164	H1			
					SAG157	H1			
	APS38	SPA172	F1	SAA118				SUA494	J2
								SUA467	J2
								SUA517	J3
	APS38	ATS22	F2	SAA118	SAG169	H1		SUA493	J2
		SPA172	F1						



KW

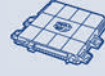

TYPE



TYPE

PEUGEOT

307 SW (3H)

2.0 HDi 135	Diesel	100	02/04 → 05/05						
2.0 HDi 135	Diesel	100	06/05 → 03/06	ENGINE: DW10ATED					
2.0 HDi 90	Diesel	66	03/02 →						
2.0 HDi 90	Diesel	66	03/02 → 05/05						
2.0 HDi 90	Diesel	66	03/02 →	ENGINE: SIEMENSSYSTEM					

308 (4A_, 4C_)

1.4 16V	Petrol	70	09/07 →						
1.4 16V	Petrol	72	12/09 →						
1.4 16V	Petrol	70	09/07 → 03/10						
1.4 16V	Petrol	72	04/10 →						
1.6 16V	Petrol	103	09/07 →						
1.6 16V	Petrol	110	09/07 →						
1.6 16V	Petrol	128	03/08 →						
1.6 16V	Petrol	88	09/07 →						
1.6 16V	Petrol	103	11/07 →						
1.6 16V	Petrol	115	10/09 →						
1.6 GTI	Petrol	147	07/10 →						
1.6 HDi	Diesel	66	09/07 →						
1.6 HDi	Diesel	80	09/07 →						
1.6 HDi	Diesel	66	09/07 →						
1.6 HDi	Diesel	80	09/07 →						
1.6 HDi	Diesel	82	12/09 →						
2.0 HDi	Diesel	100	09/07 →						
2.0 HDi	Diesel	100	09/07 →						

308 CC

1.6 16V	Petrol	103	06/09 →						
1.6 16V	Petrol	110	06/09 →						
1.6 16V	Petrol	88	06/09 →						
1.6 16V	Petrol	115	09/09 →						
1.6 16V	Petrol	115	06/09 →						
1.6 HDi	Diesel	82	06/09 →						

308 SW

1.4 16V	Petrol	70	09/07 →						
1.4 16V	Petrol	72	12/09 →						
1.4 16V	Petrol	70	05/08 →						
1.4 16V	Petrol	70	05/08 → 03/10						
1.4 16V	Petrol	72	04/10 →						
1.6 16V	Petrol	103	09/07 →						
1.6 16V	Petrol	110	09/07 →						
1.6 16V	Petrol	128	03/08 →						
1.6 16V	Petrol	88	09/07 →						
1.6 16V	Petrol	103	05/08 →						
1.6 16V	Petrol	110	05/08 →						
1.6 16V	Petrol	128	05/08 →						

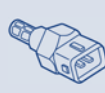

TYPE

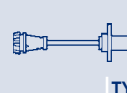

TYPE



TYPE

								SUA467	J2
								SUA517	J3
	APS38		SPA172	F1	SAA118				
						SAG157	H1	SUA467	J2
								SUA517	J3
	APS71		SPA161	F1	SAA118			GA2158	J2
	APS71								
								BAE680BR	
								BAE680BR	
	APS47							GA2059	J2
	APS47		SPA161	F1	SAA118	SAC072	H2	GA2118	J2
	APS47		SPA161	F1	SAA118	SAC072	H2		
	APS71		SPA161	F1	SAA118			BAE680BR	GA2158
						SAC072	H2		
								GA2118	J2
								GA2118	J2
	APS38		ATS22	F2	SAA118	SAC096	H2		
	APS38		ATS22	F2	SAA118	SAC096	H2		
			SPA172	F1		SAG167	H1		
			SPA172	F1		SAG167	H1		
						SAG167	H1		
	APS38		ATS22	F2	SAA118	SAC096	H2		
			SPA172	F1		SAG169	H1		
	APS47					SAC072	H2		
	APS47					SAC072	H2	GA2118	J2
	APS71					SAC072	H2	BAE680BR	
						SAC072	H2		
								GA2118	J2
						SAG167	H1		
	APS71		SPA161	F1	SAA118				
	APS71					SAC072	H2		
						SAC072	H2		
								BAE680BR	
								BAE680BR	
	APS47								
	APS47		SPA161	F1	SAA118			GA2118	J2
	APS47		SPA161	F1	SAA118			GA2118	J2
	APS71		SPA161	F1	SAA118			GA2111	J2
						SAC072	H2		
						SAC072	H2		
						SAC072	H2		



KW



TYPE



TYPE

PEUGEOT

308 SW

1.6 16V	Petrol	88	05/08 →						
1.6 16V	Petrol	115	10/09 →						
1.6 Bioflex	BiFuel	82	03/09 →				TB0015	B3	
1.6 HDi	Diesel	66	09/07 →						
1.6 HDi	Diesel	80	09/07 →						
1.6 HDi	Diesel	66	09/07 →						
1.6 HDi	Diesel	80	09/07 →						
1.6 HDi	Diesel	82	12/09 →						
2.0 HDi	Diesel	100	09/07 →						
2.0 HDi	Diesel	100	09/07 →						

309 I (10C, 10A)

1.1	Petrol	40	10/85 → 07/89						
1.3	Petrol	47	10/85 → 07/89	ENGINE: G1A					
1.3	Petrol	47	10/85 → 07/89						
1.4	Petrol	55	03/89 → 07/89						
1.4	Petrol	49	03/89 → 07/89	ENGINE: TU3M(KDY,Z)					
1.4	Petrol	55	03/89 → 07/89	ENGINE: TU3M(KDY,Z)					
1.4	Petrol	62	03/89 → 07/89	ENGINE: TU3M(KDY,Z)					
1.4	Petrol	49	03/89 → 07/89						
1.4	Petrol	62	03/89 → 07/89						
1.5	Petrol	63	06/87 → 12/89						
1.6	Petrol	76	11/85 → 09/88						
1.6	Petrol	53	08/87 → 07/89						
1.6	Petrol	55	10/85 → 07/89						
1.6	Petrol	59	10/86 → 07/89						
1.6	Petrol	69	10/86 → 07/89						
1.6 Cat.	Petrol	55	09/86 → 06/88						
1.9	Petrol	72	03/86 → 07/89						
1.9	Petrol	80	07/88 → 07/89						
1.9	Petrol	75	10/85 → 07/89						
1.9 D	Diesel	47	06/86 → 07/89						
1.9 GTI	Petrol	88	07/88 → 07/89						
1.9 GTI	Petrol	94	10/86 → 07/89						
1.9 GTI	Petrol	88	07/88 → 07/89						
1.9 GTI	Petrol	94	10/86 → 07/89						

309 II (3C, 3A)

1.1	Petrol	44	08/90 → 12/93						
1.1	Petrol	44	10/90 → 12/93						
1.4	Petrol	55	07/89 → 12/93						
1.4	Petrol	55	06/90 → 12/93						
1.6	Petrol	65	07/89 → 12/93				CP90/011	B6	
1.6	Petrol	65	07/89 → 12/93	ENGINE: XU5M2Z					
1.6	Petrol	65	01/91 → 12/93	ENGINE: XU5MZ					
1.6	Petrol	65	01/91 → 12/93						



TYPE



TYPE



TYPE

						SAC072	H2	BAE680BR		
									GA2118	J2
						SAG167	H1			
	APS38		ATS22	F2	SAA118	SAC096	H2			
	APS38		ATS22	F2	SAA118	SAC096	H2			
			SPA172	F1		SAG167	H1			
			SPA172	F1		SAG167	H1			
						SAG167	H1			
	APS38		ATS22	F2	SAA118	SAC096	H2			
			SPA172	F1		SAG169	H1			
									SUA287	J3
								BAE507AK		
									SUA287	J3
			SPA104	F1					SUA287	J3
								BAE507AK		
								BAE507AK		
								BAE507AK		
									SUA287	J3
									SUA287	J3
									SUA287	J3
			SPA104	F1					SUA287	J3
									SUA287	J3
									SUA287	J3
			SPA104	F1					SUA287	J3
			SPA104	F1					SUA287	J3
									SUA287	J3
			SPA102	F1					SUA287	J3
			SPA104	F1					PI024	J1
			SPA104	F1					PI024	J1
									SUA287	J3
									SUA287	J3
			SPA104	F1					SUA287	J3
									SUA287	J3
			SPA104	F1		SAG150	H1		SUA287	J3
	PRT03/04									
			SZA102	F1						
								BAE680AF		



KW



TYPE



TYPE

PEUGEOT

309 II (3C, 3A)

1.6	Petrol	68	07/89 → 12/93					
1.6	Petrol	69	07/89 → 12/93					
1.8 Diesel	Diesel	44	07/89 → 12/93					
1.8 TD	Diesel	57	11/89 → 12/93					
1.9	Petrol	72	08/89 → 12/93				SVF010	B6
1.9	Petrol	80	10/90 → 12/93					
1.9 Diesel	Diesel	47	07/89 → 12/93					
1.9 GTI	Petrol	88	07/89 → 12/93				SVF010	B6
1.9 GTI 16V	Petrol	116	02/90 → 07/90				SVF010	B6
1.9 GTI 16V	Petrol	116	08/89 → 07/90					

4007 (GP_)

2.2 HDi	Diesel	115	02/07 →					
2.2 HDi	Diesel	115	02/07 →					

405 I (15B)

1.4	Petrol	47	01/87 → 07/92					
1.6	Petrol	53	01/91 → 12/92				B04	B1
1.6	Petrol	65	07/87 → 12/92				CP90/011	B6
1.6	Petrol	65	01/91 → 12/92				B04	B1
1.6	Petrol	65	01/92 → 12/92				PF90/018	B6
1.6	Petrol	66	10/89 → 12/92				CP90/011	B6
1.6	Petrol	66	01/91 → 12/92				B04	B1
1.6	Petrol	66	01/92 → 12/92				PF90/018	B6
1.6	Petrol	69	01/91 → 12/92				B04	B1
1.6	Petrol	65	07/87 → 12/92	ENGINE: XU5M3Z				
1.6	Petrol	66	10/89 → 12/92	ENGINE: XU5MZ				
1.6	Petrol	65	01/91 → 12/92	ENGINE: XU5M2Z				
1.6	Petrol	65	09/90 → 12/92					
1.8 Turbo Diesel	Diesel	66	03/88 → 12/92					
1.9	Petrol	88	07/88 → 12/92				SVF010	B6
1.9	Petrol	80	07/88 → 12/92					
1.9	Petrol	93	09/90 → 12/92					
1.9 4x4	Petrol	80	07/88 → 12/92					
1.9 4x4	Petrol	93	09/90 → 07/92					
1.9 Diesel	Diesel	51	03/88 → 12/92					
1.9 Injection	Petrol	77	07/87 → 12/92				SVF010	B6
1.9 Sport MI-16	Petrol	108	04/88 → 12/92				SVF010	B6
1.9 Sport MI-16	Petrol	116	07/87 → 11/91				SVF010	B6
1.9 SPort MI-16 4x4	Petrol	108	04/88 → 12/92				SVF010	B6

405 I Break (15E)

1.6	Petrol	53	01/91 → 08/92				B04	B1
1.6	Petrol	55	01/91 → 08/92				B04	B1
1.6	Petrol	65	10/88 → 08/92				CP90/011	B6
1.6	Petrol	65	01/91 → 08/92				B04	B1
1.6	Petrol	65	01/92 → 08/92				PF90/018	B6

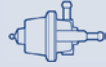

TYPE



TYPE



TYPE

SUA287	J3
SUA287	J3
SUA287	J3
SUA287	J3
SPA104	F1
SUA287	J3
SPA104	F1
SUA287	J3
SUA287	J3
SPA104	F1
SUA287	J3
SUA287	J3
SPA104	F1

ATS22	F2	SAA118	SAC096	H2
SPA172	F1		SAG167	H1

SPA104	F1			
			SAG150	H1
			SAG150	H1

PRT03/04
PRT03/04

SZA102	F1			
SZA102	F1			
			BAE680AF	
			SUA230	J3
SPA104	F1			
SPA104	F1			
			BAE680AF	
SPA104	F1			
			BAE680AF	
			SUA230	J3
SPA104	F1			
SPA104	F1			
SPA104	F1			
SPA104	F1			

SAG150	H1
--------	----



KW

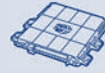

TYPE



TYPE

PEUGEOT

405 I Break (15E)

1.6	Petrol	66	10/88 → 08/92				CP90/011	B6
1.6	Petrol	66	01/91 → 08/92				B04	B1
1.6	Petrol	66	01/92 → 08/92				PF90/018	B6
1.6	Petrol	69	01/91 → 08/92				B04	B1
1.6	Petrol	65	09/90 → 08/92					
1.8 TD	Diesel	66	10/88 → 08/92					
1.9	Petrol	77	10/88 → 08/92				SVF010	B6
1.9	Petrol	88	10/88 → 08/92				SVF010	B6
1.9	Petrol	80	10/88 → 08/92					
1.9 4x4	Petrol	80	10/88 → 08/92					
1.9 D	Diesel	47	10/88 → 08/92					
1.9 D	Diesel	51	10/88 → 08/92					

405 II (4B)

1.4	Petrol	55	08/92 → 10/95					
1.6	Petrol	65	08/92 → 10/95				B04	B1
1.6	Petrol	65	08/92 → 10/95				PF90/018	B6
1.6	Petrol	65	08/92 → 10/95	ENGINE: XU5M3K				
1.6	Petrol	65	08/92 → 10/95	ENGINE: XU5JPZ				
1.6	Petrol	65	08/92 → 10/95	ENGINE: XU5JPZ				
1.8	Petrol	74	05/93 → 10/95	ENGINE: XU7JP	IAW8P.10/3	A1		
1.8	Petrol	74	10/92 → 10/95	ENGINE: XU7JPZ	IAW8P.10/2	A1		
1.8	Petrol	74	08/92 → 10/95				B04	B1
1.8	Petrol	74	08/92 → 10/95				B3385	B1
1.8	Petrol	74	08/92 → 10/95				PF90/018	B6
1.8	Petrol	74	08/92 → 10/95	ENGINE: XU7JPK,TR				
1.8	Petrol	74	08/92 → 10/95	ENGINE: XU7JPK,TR				
1.9 D	Diesel	47	08/92 → 10/95					
1.9 D	Diesel	50	06/94 → 10/95					
1.9 D	Diesel	47	08/92 → 06/94					
1.9 D	Diesel	50	07/94 → 10/95					
2.0	Petrol	89	08/92 → 10/95				PF90/018	B6
2.0	Petrol	89	08/92 → 10/95				SVF015	B6
2.0	Petrol	89	08/92 → 10/95	ENGINE: XU10J2CZ				
2.0	Petrol	89	08/92 → 10/95	ENGINE: XU10J2CZ				
2.0 16V	Petrol	110	06/94 → 06/95				SVF015	B6
2.0 16V	Petrol	110	06/94 → 10/95					
2.0 16V	Petrol	110	06/94 → 10/95					
2.0 MI-16	Petrol	112	08/92 → 06/95				SVF015	B6
2.0 MI-16	Petrol	112	08/92 → 10/95					
2.0 MI-16	Petrol	112	08/92 → 10/95					
2.0 T 16 X4	Petrol	144	08/92 → 10/95				B04	B1
2.0 T 16 X4	Petrol	144	08/92 → 10/95				PF90/018	B6
2.0 T 16 X4	Petrol	144	08/92 → 10/95	ENGINE: XU10J4TEZ				
2.0 T 16 X4	Petrol	144	08/92 → 10/95	ENGINE: XU10J4TEZ				

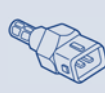

TYPE

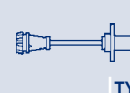

TYPE



TYPE

								BAE680AF	
								SUA230	J3
			SPA104	F1					
			SPA104	F1					
			SPA104	F1					
			SPA104	F1					
								SUA230	J3
								SUA230	J3
						SAG156	H1	BAE680CV	
	PRT03E/04		SPA102	F1		SAG150	H1	BAE680AF	
	PRT03/04								
		KITRPM36	SZA101	F1					
		RPM36							
	APS29		SPA102	F1		SAG150	H1	BAE680AF	
	PRT03E/04								
		KITRPM36	SZA101	F1					
		RPM36							
			SPA102	F1					
			SPA102	F1					
								SUA230	J3
								SUA230	J3
	PRT03E/04		SPA102	F1		SAG150	H1	BAE680AF	
		KITRPM36	SZA101	F1					
		RPM36							
						SAC064	H2		
						SAG150	H1		
						SAC064	H2		
						SAG150	H1		
						SAC064	H2		
						SAG150	H1		
		KITRPM40	SZA101	F1					
		RPM40							



KW

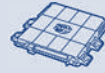

TYPE



TYPE

PEUGEOT

405 II (4B)

2.0 T 16 X4	Petrol	144	08/92 → 10/95	ENGINE: XU10J4TE,Z(RGZ)					
2.0 X4	Petrol	89	08/92 → 10/95				PF90/018	B6	
2.0 X4	Petrol	89	08/92 → 10/95	ENGINE: XU10J2CZ					
2.0 X4	Petrol	89	08/92 → 10/95	ENGINE: XU10J2CZ					

405 II Break (4E)

1.4	Petrol	55	08/92 → 10/96						
1.6	Petrol	65	08/92 → 10/96				B04	B1	
1.6	Petrol	65	08/92 → 12/95				PF90/018	B6	
1.6	Petrol	65	01/96 → 10/96				PF16080067	B6	
1.8	Petrol	74	05/93 → 10/96	ENGINE: XU7JP	IAW8P.10/3	A1			
1.8	Petrol	74	10/92 → 10/96	ENGINE: XU7JPZ	IAW8P.10/2	A1			
1.8	Petrol	74	08/92 → 10/96				B04	B1	
1.8	Petrol	74	08/92 → 10/96				B3385	B1	
1.8	Petrol	74	08/92 → 12/95				PF90/018	B6	
1.8	Petrol	74	01/96 → 10/96				PF16080067	B6	
1.9 D	Diesel	47	08/92 → 10/96						
1.9 D	Diesel	50	06/94 → 10/96						
1.9 D	Diesel	47	08/92 → 06/94						
1.9 D	Diesel	50	07/94 → 10/96						
2.0	Petrol	89	08/92 → 10/96				SVF015	B6	
2.0	Petrol	89	08/92 → 12/95				PF90/018	B6	
2.0	Petrol	89	01/96 → 10/96				PF16080067	B6	
2.0 4x4	Petrol	89	08/92 → 12/95				PF90/018	B6	
2.0 4x4	Petrol	89	08/92 → 10/96						

406 (8B)

1.6	Petrol	65	06/97 → 02/01	ENGINE: XU5JPZ	IAW8P.14/1	A1			
1.6	Petrol	65	11/95 → 05/04				B04	B1	
1.6	Petrol	65	01/96 → 05/04				PF16080067	B6	
1.6	Petrol	65	11/95 → 12/97	ENGINE: XU5JPZ					
1.6	Petrol	65	11/95 → 12/97	ENGINE: XU5JPZ					
1.6	Petrol	65	11/95 → 05/04	ENGINE: XU5JPZ					
1.6	Petrol	65	09/99 → 05/04						
1.6	Petrol	65	11/95 → 12/97	ENGINE: I(XU5JP)					
1.6	Petrol	65	01/98 → 05/04	ENGINE: I(XU5JP)					
1.8	Petrol	66	07/97 → 10/00	ENGINE: XU7JB	IAW1AP.20/2	A1			
1.8	Petrol	66	05/97 → 05/04				B04	B1	
1.8	Petrol	66	05/97 → 05/04				PF16080067	B6	
1.8	Petrol	66	05/97 → 12/00				KITPF2C	B6	
1.8	Petrol	66	01/98 → 05/04				B22/1	B1	
1.8	Petrol	66	04/98 → 05/04	ENGINE: XU7JB			B32/00	B1	
1.8	Petrol	66	09/97 → 11/98						
1.8	Petrol	66	05/97 → 05/04	ENGINE: XU7JB					
1.8	Petrol	66	05/97 → 05/04	ENGINE: XU7JB					
1.8	Petrol	66	05/97 → 05/04	ENGINE: XU7JPK,TR					



TYPE

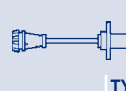

TYPE



TYPE

								BAE700AK		
	PRT03E/04					SAG150	H1	BAE680AF		
		KITRPM36	SZA101	F1						
		RPM36								
						SAG156	H1	BAE680CV		
	PRT03E/04		SPA102	F1		SAG150	H1	BAE680AF		
	APS29		SPA102	F1		SAG150	H1	BAE680AF		
	PRT03E/04									
			SPA102	F1						
			SPA102	F1						
									SUA230	J3
									SUA230	J3
	PRT03E/04		SPA102	F1		SAG150	H1	BAE680AF		
	PRT03E/04					SAG150	H1	BAE680AF		
	PRT03E/04				SAA118	SAG028	H1	BAE680AF		
		KITRPM36								
		RPM36								
			SZA101	F1						
						SAG027	H1			
									SUA380	J2
									SUA381	J2
IWP049/1	PRT03E/04				SAA118	SAG028	H1		ESS0092A	J1
	APS76									
		KITRPM40								
		RPM40								
		KITRPM40	SZA101	F1						



KW



TYPE



TYPE

PEUGEOT

406 (8B)

1.8	Petrol	66	05/97 → 05/04	ENGINE: XU7JPK,TR				
1.8	Petrol	66	09/99 → 05/04					
1.8	Petrol	66	09/97 → 03/99					
1.8	Petrol	74	10/96 → 03/99					
1.8	Petrol	66	05/97 → 12/97	ENGINE: I(XU7JP)(XU7JP4)				
1.8	Petrol	66	01/98 → 05/04	ENGINE: I(XU7JP-XU7JP4)				
1.8 16V	Petrol	81	11/95 → 10/00				B22/1	B1
1.8 16V	Petrol	85	10/00 → 05/04	ENGINE: 6FZ(EW7J4)			B3389	B1
1.8 16V	Petrol	81	11/95 → 11/98					
1.8 16V	Petrol	81	04/99 → 10/00					
1.8 16V	Petrol	85	10/00 → 05/04					
1.8 16V	Petrol	81	11/95 → 10/00					
1.8 16V	Petrol	85	10/00 → 05/04					
1.8 16V	Petrol	81	09/99 → 10/00					
1.8 16V	Petrol	85	10/00 → 04/02					
1.8 16V	Petrol	85	10/00 → 05/04	ENGINE: EW7J4				
1.9 D	Diesel	55	10/96 → 05/04					
1.9 D	Diesel	55	09/99 → 05/04					
1.9 D	Diesel	55	10/96 → 12/97	ENGINE: (XUD9SD,XUD9TE)				
1.9 TD	Diesel	66	01/96 → 05/04					
1.9 TD	Diesel	66	09/99 → 05/04					
2.0 16V	Petrol	100	08/00 → 06/04	ENGINE: EW10J4	IAW48P3.3J	A1		
2.0 16V	Petrol	100	08/00 → 06/01	ENGINE: EW10J4	IAW48P2.39/1	A1		
2.0 16V	Petrol	97	11/95 → 05/04	ENGINE: EW10J4	IAW48P3.3J	A1		
2.0 16V	Petrol	99	01/99 → 08/00	ENGINE: EW10J4	IAW48P3.3J	A1		
2.0 16V	Petrol	99	05/99 → 08/00	ENGINE: EW10J4,L3	IAW48P2.317	A1		
2.0 16V	Petrol	97	11/95 → 05/04				B3385	B1
2.0 16V	Petrol	97	11/95 → 04/98	ENGINE: EW10J4			B33	B1
2.0 16V	Petrol	97	01/97 → 03/99					
2.0 16V	Petrol	100	08/00 → 05/04					
2.0 16V	Petrol	100	08/00 → 06/04					
2.0 16V	Petrol	99	01/99 → 03/99					
2.0 16V	Petrol	100	08/00 → 06/04					
2.0 16V	Petrol	97	11/95 → 05/04					
2.0 16V	Petrol	99	01/99 → 08/00					
2.0 16V	Petrol	100	08/00 → 03/02					
2.0 16V	Petrol	97	09/99 → 05/04					
2.0 16V	Petrol	99	09/99 → 08/00					
2.0 16V	Petrol	100	08/00 → 05/04	ENGINE: I(XU10J2TE-XU10J4R)				
2.0 16V	Petrol	100	01/01 → 06/04					
2.0 16V	Petrol	97	11/95 → 12/97	ENGINE: I(10J2TE-XU10J4R)				
2.0 16V	Petrol	97	01/98 → 05/04	ENGINE: I(XU10J2TE-XU10J4R)				

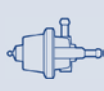

TYPE

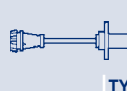

TYPE



TYPE

			RPM40								
								SAG027	H1		
										BAE680AF	
										BAE680AF	
										SUA380	J2
										SUA381	J2
						SAA118	SAD008	H3		BAE680AY	
		APS76									
		APS45									
			SPA107	F1	SAA118	SAC070	H2			SUA468/1	J2
						SAG028	H1				
						SAG027	H1				
						SAG027	H1				
						SAG157	H1				
										GA2003	J2
						SAG028	H1			ESS0092A	J1
						SAG027	H1				
										SUA382	J3
						SAG028	H1				
						SAG027	H1				
						SAA118	SAD008	H3		BAE680AY	
		APS76									
			RPM58	IATS04/01	F2						
				SPA107	F1	SAA118	SAC070	H2			
				SPA107	F1						
							SAG027	H1			
							SAG028	H1			
						SAA118	SAG028	H1			
							SAG157	H1			
							SAG027	H1			
							SAG027	H1			
										SUA381	J2
										GA2003	J2
										SUA380	J2
										SUA381	J2



KW



TYPE



TYPE

PEUGEOT

406 (8B)

2.0 16V	Petrol	97	01/01 → 05/04					
2.0 16V	Petrol	99	01/99 → 08/00	ENGINE: I(XU10J2TE-XU10J4R)				
2.0 16V HPI	Petrol	103	05/01 → 05/04	ENGINE: RLZEW10D			60CPM1	B3
2.0 16V HPI	Petrol	103	05/01 → 05/04					
2.0 HDi 110	Diesel	80	06/98 → 08/01					
2.0 HDi 110	Diesel	79	08/01 → 05/04					
2.0 HDi 110	Diesel	80	06/98 → 03/99					
2.0 HDi 110	Diesel	80	09/99 → 08/01					
2.0 HDi 110	Diesel	80	04/99 → 05/00					
2.0 HDi 110	Diesel	80	03/99 → 05/00					
2.0 HDi 90	Diesel	66	02/99 → 05/04					
2.0 HDi 90	Diesel	66	02/99 → 05/99					
2.0 HDi 90	Diesel	66	09/99 → 05/04					
2.0 HDi 90	Diesel	66	04/99 → 05/00					
2.0 HDi 90	Diesel	66	03/99 → 05/00					
2.1 TD 12V	Diesel	80	01/96 → 05/04					
2.1 TD 12V	Diesel	80	09/99 → 05/04					
2.1 TD 12V	Diesel	80	01/96 → 12/97	ENGINE: (XUD11BTE)				
2.2	Petrol	116	07/00 → 05/04	ENGINE: 3FZ(EW12J4)			60CPM2	B3
2.2	Petrol	116	07/00 → 05/04	ENGINE: 3FZ(EW12J4)			KITBLOW	B2
2.2	Petrol	116	07/00 → 05/04					
2.2	Petrol	116	07/00 → 05/04					
2.2	Petrol	116	07/00 → 03/02					
2.2	Petrol	116	01/01 → 05/04	ENGINE: EW12J4				
2.2 HDi	Diesel	98	03/00 → 05/04					
2.2 HDi	Diesel	98	01/01 → 05/04					
3.0 V6	Petrol	152	03/00 → 05/04					
3.0 V6	Petrol	152	03/00 → 05/04					
3.0 V6	Petrol	152	01/01 → 05/04					

406 Break (8E/F)

1.8	Petrol	66	07/97 → 10/00	ENGINE: XU7JB	IAW1AP.20/2	A1		
1.8	Petrol	66	05/97 → 10/04				B04	B1
1.8	Petrol	66	05/97 → 10/04				PF16080067	B6
1.8	Petrol	66	05/97 → 12/00				KITPF2C	B6
1.8	Petrol	66	01/98 → 10/04				B22/1	B1
1.8	Petrol	66	09/97 → 11/98					
1.8	Petrol	66	09/99 → 10/04					
1.8	Petrol	66	09/97 → 06/04					
1.8	Petrol	74	10/96 → 03/99					
1.8	Petrol	66	05/97 → 12/97	ENGINE: I(XU7JP)(XU7JP4)				
1.8	Petrol	66	01/98 → 10/04	ENGINE: I(XU7JP-XU7JP4)				
1.8 16V	Petrol	85	10/00 → 10/04	ENGINE: 6FZ(EW7J4)			B3389	B1
1.8 16V	Petrol	85	10/00 → 10/04					



TYPE

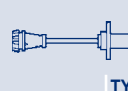

TYPE



TYPE

										GA2003	J2
										SUA381	J2
				SPA107	F1	SAA118	SAG157	H1			
	APS35			SPA107	F1	SAA118	SAG028	H1			
				SPA107	F1	SAA118					
							SAG157	H1			
							SAG027	H1			
										SUA462	J2
										SUA530	J2
				SPA107	F1	SAA118	SAG028	H1			
				SPA167	F1						
							SAG027	H1			
										SUA462	J2
										SUA530	J2
							SAG028	H1			
							SAG027	H1			
										SUA382	J3
				SPA107	F1	SAA118	SAC070	H2			
							SAG027	H1			
							SAG126	H1			
										GA2003	J2
	APS35			SPA172	F1	SAA118	SAG027	H1			
										SUA494	J2
	APS62			SPA107	F1	SAA118	SAD013	H3	BAE680BD	ESS0092A	J1
							SAG027	H1			
										GA2003	J2
	IWP049/1					SAA118	SAG028	H1			
	APS76										
							SAG027	H1			
									BAE680AF		
									BAE680AF		
										SUA380	J2
										SUA381	J2
				SPA107	F1	SAA118	SAC070	H2		SUA468/1	J2



KW



TYPE



TYPE

PEUGEOT

406 Break (8E/F)

1.8 16V	Petrol	85	10/00 → 10/04						
1.8 16V	Petrol	85	10/00 → 04/02						
1.8 16V	Petrol	85	10/00 → 10/04	ENGINE: EW7J4					
1.8 16V	Petrol	85	10/00 → 10/04	ENGINE: I(XU7JP-XU7JP4)					
2.0 16V	Petrol	100	10/00 → 10/04	ENGINE: EW10J4	IAW48P3.3J	A1			
2.0 16V	Petrol	100	10/00 → 06/01	ENGINE: EW10J4	IAW48P2.39/1	A1			
2.0 16V	Petrol	99	01/99 → 10/00	ENGINE: EW10J4	IAW48P3.3J	A1			
2.0 16V	Petrol	100	10/00 → 10/04						
2.0 16V	Petrol	100	10/00 → 10/04						
2.0 16V	Petrol	99	01/99 → 03/99						
2.0 16V	Petrol	99	01/99 → 10/00						
2.0 16V	Petrol	100	10/00 → 03/02						
2.0 16V	Petrol	99	09/99 → 10/00						
2.0 16V	Petrol	100	10/00 → 10/04	ENGINE: I(XU10J2TE-XU10J4R)					
2.0 16V	Petrol	100	01/01 → 10/04						
2.0 16V	Petrol	99	01/99 → 10/00	ENGINE: I(XU10J2TE-XU10J4R)					
2.0 16V HPi	Petrol	103	05/01 → 10/04	ENGINE: EW10J4	IAW48P3.3J	A1			
2.0 16V HPi	Petrol	103	05/01 → 10/04	ENGINE: RLZEW10D			60CPM1	B3	
2.0 16V HPi	Petrol	103	05/01 → 10/04						
2.0 HDi 110	Diesel	80	02/99 → 04/04						
2.0 HDi 110	Diesel	79	08/01 → 10/04						
2.0 HDi 110	Diesel	80	02/99 → 03/99						
2.0 HDi 110	Diesel	80	09/99 → 04/04						
2.0 HDi 110	Diesel	80	04/99 → 05/00						
2.0 HDi 110	Diesel	80	06/00 → 04/04						
2.0 HDi 110	Diesel	80	03/99 → 05/00						
2.0 HDi 90	Diesel	66	02/99 → 10/04						
2.0 HDi 90	Diesel	66	02/99 → 05/99						
2.0 HDi 90	Diesel	66	09/99 → 10/04						
2.0 HDi 90	Diesel	66	04/99 → 05/00						
2.0 HDi 90	Diesel	66	06/00 → 10/04						
2.0 HDi 90	Diesel	66	03/99 → 05/00						
2.2	Petrol	116	07/00 → 10/04	ENGINE: 3FZ(EW12J4)			60CPM2	B3	
2.2	Petrol	116	07/00 → 10/04	ENGINE: 3FZ(EW12J4)			KITBLOW	B2	
2.2	Petrol	116	07/00 → 10/04						
2.2	Petrol	116	07/00 → 10/04						
2.2	Petrol	116	07/00 → 03/02						
2.2	Petrol	116	01/01 → 10/04	ENGINE: EW12J4					
2.2 HDi	Diesel	98	03/00 → 10/04						
2.2 HDi	Diesel	98	01/01 → 10/04						
3.0 V6	Petrol	152	03/00 → 06/04						
3.0 V6	Petrol	152	03/00 → 10/04						

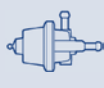

TYPE

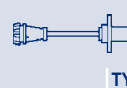

TYPE



TYPE

							SAG027	H1			
							SAG157	H1			
										GA2003	J2
										SUA381	J2
			RPM58	IATS04/01	F2	SAA118	SAG070	H2			
				SPA107	F1		SAG027	H1			
				SPA107	F1						
						SAA118	SAG028	H1			
							SAG157	H1			
							SAG027	H1			
										SUA381	J2
										GA2003	J2
										SUA381	J2
				SPA107	F1	SAA118	SAG157	H1			
	APS35			SPA107	F1	SAA118	SAG028	H1		GA2204	J2
				SPA107	F1	SAA118				GA2204	J2
							SAG157	H1			
							SAG027	H1			
										SUA462	J2
										SUA494	J2
										SUA530	J2
				SPA107	F1	SAA118	SAG028	H1		GA2204	J2
				SPA167	F1						
							SAG027	H1			
										SUA462	J2
										SUA494	J2
										SUA530	J2
				SPA107	F1	SAA118	SAC070	H2			
							SAG027	H1			
							SAG126	H1			
										GA2003	J2
	APS35			SPA172	F1	SAA118	SAG027	H1			
										SUA494	J2
	APS62										
				SPA107	F1	SAA118	SAD013	H3	BAE680BD		



KW



TYPE



TYPE

PEUGEOT

406 Break (8E/F)

3.0 V6	Petrol	152	03/00 → 10/04
3.0 V6	Petrol	152	01/01 → 10/04

406 Coupé (8C)

2.0 16V	Petrol	100	10/00 → 12/04	ENGINE: EW10J4	IAW48P3.3J	A1		
2.0 16V	Petrol	100	10/00 → 06/01	ENGINE: EW10J4	IAW48P2.39/1	A1		
2.0 16V	Petrol	97	03/97 → 12/04	ENGINE: EW10J4	IAW48P3.3J	A1		
2.0 16V	Petrol	99	01/99 → 10/00	ENGINE: EW10J4	IAW48P3.3J	A1		
2.0 16V	Petrol	97	03/97 → 12/04				B3385	B1
2.0 16V	Petrol	97	03/97 → 03/99					
2.0 16V	Petrol	100	10/00 → 12/04					
2.0 16V	Petrol	100	10/00 → 12/04					
2.0 16V	Petrol	99	01/99 → 03/99					
2.0 16V	Petrol	99	01/99 → 10/00					
2.0 16V	Petrol	100	10/00 → 03/02					
2.0 16V	Petrol	97	09/99 → 12/04					
2.0 16V	Petrol	99	09/99 → 10/00					
2.0 16V	Petrol	100	10/00 → 12/04	ENGINE: I(XU10J2TE-XU10J4R)				
2.0 16V	Petrol	100	01/01 → 12/04					
2.0 16V	Petrol	97	03/97 → 12/97	ENGINE: I(10J2TE-XU10J4R)				
2.0 16V	Petrol	97	01/98 → 12/04	ENGINE: I(XU10J2TE-XU10J4R)				
2.0 16V	Petrol	97	01/01 → 12/04					
2.0 16V	Petrol	99	01/99 → 10/00	ENGINE: I(XU10J2TE-XU10J4R)				
2.2	Petrol	116	03/02 → 12/04					
2.2 HDi	Diesel	98	03/00 → 12/04					
2.2 HDi	Diesel	98	01/01 → 12/04					
3.0 V6	Petrol	152	03/00 → 12/04					
3.0 V6	Petrol	152	03/00 → 12/04					
3.0 V6	Petrol	152	01/01 → 12/04					
3.0 V6 24V	Petrol	140	03/97 → 11/98					
3.0 V6 24V	Petrol	140	03/97 → 12/04					
3.0 V6 24V	Petrol	140	09/99 → 12/04					
3.0 V6 24V	Petrol	140	03/97 → 12/97	ENGINE: I(ES9J4)				
3.0 V6 24V	Petrol	140	01/98 → 12/04	ENGINE: I(ES9J4)				
3.0 V6 24V	Petrol	140	01/01 → 12/04					

407 (6D_)

1.6 HDi 110	Diesel	80	05/04 →
1.6 HDi 110	Diesel	80	05/04 →
1.8	Petrol	85	05/04 →
1.8 16V	Petrol	92	09/05 →
2.0	Petrol	100	05/04 →
2.0 16V	Petrol	103	09/05 →

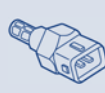

TYPE

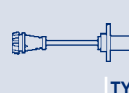

TYPE



TYPE

							SAG027	H1				
											GA2003	J2
							SAA118	SAG028	H1	BAE680AY		
	APS76											
		RPM58	IATS04/01	F2	SAA118	SAC070		H2				
			SPA107	F1		SAG027		H1				
			SPA107	F1								
					SAA118	SAG028		H1				
						SAG157		H1				
						SAG027		H1				
						SAG027		H1				
											SUA381	J2
											GA2003	J2
											SUA380	J2
											SUA381	J2
											GA2003	J2
											SUA381	J2
			SPA107	F1	SAA118	SAC070		H2				
	APS35		SPA172	F1	SAA118	SAG027		H1				
											SUA494	J2
	APS62		SPA107	F1	SAA118	SAD013		H3	BAE680BD			
						SAG027		H1				
											GA2003	J2
	APS76											
			SPA120	F1	SAA118	SAG028		H1				
						SAG027		H1				
											SUA380	J2
											SUA381	J2
											GA2003	J2
	APS38		ATS22	F2	SAA118	SAC096		H2		SUA465		J3
			SPA172	F1		SAG167		H1				
	APS77		SPA107	F1	SAA118	SAC070		H2		SUA464		J2
	APS77				SAA118	SAC070		H2				
			SPA107	F1	SAA118	SAC070		H2		SUA464		J2
	APS77				SAA118	SAC070		H2				



KW



TYPE



TYPE

PEUGEOT

407 (6D_)

2.0 Bioflex	Petrol/Ethanol	103	01/09 →					
2.0 HDi	Diesel	103	08/08 →	ENGINE: RHR(DW10BTED4)			50CDDP8	B3
2.0 HDi	Diesel	103	08/08 →					
2.0 HDi 135	Diesel	100	05/04 →	ENGINE: RHR(DW10BTED4)			50CDDP8	B3
2.0 HDi 135	Diesel	100	05/04 →					
2.0 HDi 135	Diesel	100	05/04 →					
2.2	Petrol	116	05/04 →	ENGINE: 3FZ(EW12J4)			60CPM2	B3
2.2	Petrol	116	05/04 →	ENGINE: 3FZ(EW12J4)			KITBLOW	B2
2.2	Petrol	116	05/04 →					
2.2	Petrol	116	05/04 →					
2.2 16V	Petrol	120	09/05 →	ENGINE: 3FY(EW12J4)			60CPM	B3
2.2 16V	Petrol	120	09/05 →					
2.2 HDi 170	Diesel	125	05/06 →					
2.2 HDi 170	Diesel	125	05/06 →					
2.7 HDi	Diesel	150	10/05 →					
3.0	Petrol	155	05/04 →					

407 Coupé (6C_)

2.0 HDi	Diesel	100	10/05 →	ENGINE: RHR(DW10BTED4)			50CDDP9	B3
2.0 HDi	Diesel	103	09/08 → 12/09	ENGINE: RHR(DW10BTED4)			50CDDP8	B3
2.0 HDi	Diesel	100	10/05 →					
2.0 HDi	Diesel	100	10/05 →					
2.2 16V	Petrol	120	10/05 →	ENGINE: 3FY(EW12J4)			60CPM2	B3
2.2 16V	Petrol	120	10/05 →	ENGINE: 3FY(EW12J4)			KITBLOW	B2
2.2 16V	Petrol	120	10/05 →					
2.7 HDi	Diesel	150	10/05 →					
3.0 V6	Petrol	155	10/05 →					

407 SW (6E_)

1.6 HDi 110	Diesel	80	05/04 →					
1.6 HDi 110	Diesel	80	05/04 →					
1.8	Petrol	85	05/04 →					
1.8 16V	Petrol	92	09/05 →					
2.0	Petrol	100	05/04 →					
2.0 16V	Petrol	103	09/05 →					
2.0 HDi	Diesel	103	08/08 →	ENGINE: RHR(DW10BTED4)			50CDDP8	B3
2.0 HDi	Diesel	103	08/08 →					
2.0 HDi 135	Diesel	100	05/04 →	ENGINE: RHR(DW10BTED4)			50CDDP8	B3
2.0 HDi 135	Diesel	100	05/04 →					
2.0 HDi 135	Diesel	100	05/04 →					
2.2	Petrol	116	05/04 →					
2.2	Petrol	116	05/04 →					
2.2 16V	Petrol	120	09/05 →	ENGINE: 3FY(EW12J4)			60CPM	B3
2.2 16V	Petrol	120	09/05 →					
2.2 HDi 170	Diesel	125	05/06 →					
2.2 HDi 170	Diesel	125	05/06 →					



TYPE



TYPE



TYPE

				SPA107	F1						
										SUA582	J3
	APS38		ATS22	F2	SAA118	SAC096	H2			SUA465	J3
			SPA172	F1		SAG169	H1				
			SPA172	F1	SAA118	SAC070	H2			SUA464	J2
						SAD033	H3				
	APS77				SAA118	SAC070	H2				
			ATS22	F2	SAA118	SAC096	H2				
						SAG167	H1				
			SPA107	F1							
	APS62		SPA107	F1	SAA118	SAD008	H3	BAE680BD		SUA464	J2
			ATS22	F2	SAA118	SAC096	H2			SUA582	J3
						SAG169	H1				
	APS77				SAA118	SAC070	H2				
			SPA107	F1						GA2075	J2
	APS62		SPA107	F1	SAA118	SAD008	H3	BAE680BD			
	APS38		ATS22	F2	SAA118	SAC096	H2			SUA465	J3
			SPA172	F1		SAG167	H1				
	APS77		SPA107	F1	SAA118	SAC070	H2			SUA464	J2
	APS77				SAA118	SAC070	H2				
			SPA107	F1	SAA118	SAC070	H2			SUA464	J2
	APS77				SAA118	SAC070	H2				
										SUA582	J3
	APS38		ATS22	F2	SAA118	SAC096	H2			SUA465	J3
			SPA172	F1		SAG169	H1				
			SPA172	F1	SAA118	SAC070	H2			SUA464	J2
						SAD033	H3				
	APS77				SAA118	SAC070	H2				
			ATS22	F2	SAA118	SAC096	H2				
						SAG167	H1				



KW



TYPE



TYPE

PEUGEOT

407 SW (6E_)

2.7 HDi	Diesel	150	10/05 →						
3.0	Petrol	155	05/04 →						

5008

1.6 16V	Petrol	115	09/09 →						
1.6 16V	Petrol	88	09/09 →						
1.6 HDi	Diesel	80	09/09 →						
1.6 HDi	Diesel	82	08/10 →						

504 Coupé

2.7	Petrol	106	10/77 → 08/84						
-----	--------	-----	---------------	--	--	--	--	--	--

505 (551A)

2.0 TI,STI	Petrol	81	08/79 → 10/86						
2.2	Petrol	85	05/81 → 10/84						
2.8 GTI V6	Petrol	105	06/86 → 12/93						

508

1.6 VTi	Petrol	85	11/10 →						
1.6 VTi	Petrol	88	11/10 →						
1.6 THP	Petrol	115	11/10 →						
1.6 HDi	Diesel	82	11/10 →						
1.6 HDi	Diesel	82	11/10 →						
1.6 HDi	Diesel	82	11/10 →						
2.0 HDi	Diesel	103	11/10 →						
2.0 HDi	Diesel	103	11/10 →						
2.0 HDi	Diesel	103	11/10 →						
2.2 HDi	Diesel	150	11/10 →						
2.2 HDi	Diesel	150	11/10 →						
2.2 HDi	Diesel	150	11/10 →						

604 (561A_)

2.7 TI,STI	Petrol	106	08/77 → 05/83						
------------	--------	-----	---------------	--	--	--	--	--	--

605 (6B)

2.0	Petrol	89	06/89 → 06/94					SVF015	B6
2.0	Petrol	84	06/89 → 09/99	ENGINE: XU10MZ					
2.0	Petrol	89	06/89 → 09/99	ENGINE: XU10J2K					
2.0	Petrol	89	06/93 → 06/94						
2.0	Petrol	79	02/90 → 09/99						
2.0	Petrol	89	06/89 → 09/99						
2.0	Petrol	79	02/90 → 09/99	ENGINE: XU10J2Z(RFZ)					
2.0	Petrol	84	06/89 → 09/99	ENGINE: XU10J2Z(RFZ)					
2.0	Petrol	89	06/89 → 09/99	ENGINE: XU10J2Z(RFZ)					
2.0	Petrol	89	10/90 → 06/94						
2.0	Petrol	79	01/94 → 09/99						
2.0	Petrol	84	01/94 → 09/99						
2.0	Petrol	89	01/94 → 09/99						
2.0 16V	Petrol	97	07/94 → 09/99					B3385	B1
2.0 16V	Petrol	97	01/97 → 12/98						

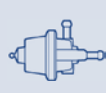

TYPE

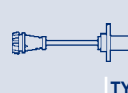

TYPE



TYPE

			SPA107	F1						
	APS62		SPA107	F1	SAA118	SAD008	H3	BAE680BD	SUA464	J2
	APS47					SAC072	H2		GA2086	J2
	APS71					SAC072	H2	BAE680BR		
						SAG167	H1			
						SAG167	H1			
									ESS0126A	J1
									ESS0171A	J1
									ESS0171A	J1
			SPA129	F1		SAG066	H1			
								BAE680BR		
									GA2046	J2
									GA2063	J2
									SUA557	J3
									SUA558	J3
									SUA559	J3
									SUA557	J3
									SUA558	J3
									SUA559	J3
									SUA557	J3
									SUA558	J3
									SUA559	J3
									ESS0126A	J1
	PRT03/04		SZA102	F1						
	PRT03/04		SZA102	F1						
	APS29									
						SAG150	H1			
						SAG150	H1		ESS0095A	J1
								BAE507BK		
								BAE507BK		
								BAE507BK		
								BAE680AF		
									GA2025	J2
									GA2025	J2
									GA2025	J2
						SAG150	H1	BAE680AY	ESS0095A	J1
	APS76									



KW

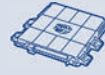

TYPE



TYPE

PEUGEOT

605 (6B)

2.0 Turbo	Petrol	104	07/92 → 06/94					SVF015	B6
2.0 Turbo	Petrol	108	07/94 → 06/95					SVF015	B6
2.0 Turbo	Petrol	108	07/91 → 09/99						
2.0 Turbo	Petrol	104	07/92 → 09/99						
2.0 Turbo	Petrol	108	07/94 → 05/99						
2.1 TD 12V	Diesel	80	08/94 → 09/99						
2.1 Turbo Diesel	Diesel	80	06/89 → 09/99						
2.5 Turbo Diesel	Diesel	95	07/94 → 09/99						
3.0	Petrol	123	08/89 → 06/94						
3.0	Petrol	123	10/89 → 09/99						
3.0 SV 24	Petrol	147	08/89 → 09/99						
3.0 SV 24	Petrol	147	08/89 → 09/99						
3.0 V6	Petrol	140	04/97 → 05/99						
3.0 V6	Petrol	140	04/97 → 09/99						

607 (9D, 9U)

2.0	Petrol	100	02/00 →						
2.0	Petrol	100	02/00 →						
2.0	Petrol	100	02/00 →						
2.0	Petrol	100	02/00 → 03/02						
2.0 HDi	Diesel	100	09/05 →	ENGINE: RHR(DW10BTED4)				50CDDP8	B3
2.0 HDi	Diesel	100	09/05 →						
2.0 HDi	Diesel	80	05/00 → 11/04						
2.0 HDi	Diesel	100	09/05 →						
2.0 HDi	Diesel	80	05/00 →						
2.0 HDi	Diesel	79	03/01 → 07/04						
2.2 16V	Petrol	116	02/00 →	ENGINE: 3FZ(EW12J4)				60CPM2	B3
2.2 16V	Petrol	116	02/00 →	ENGINE: 3FZ(EW12J4)				KITBLOW	B2
2.2 16V	Petrol	120	09/05 →						
2.2 16V	Petrol	116	02/00 →	ENGINE: → 941438					
2.2 16V	Petrol	116	12/04 →						
2.2 16V	Petrol	116	02/00 →						
2.2 16V	Petrol	120	09/05 →						
2.2 16V	Petrol	116	02/00 →						
2.2 16V	Petrol	116	02/00 →						
2.2 16V	Petrol	116	02/00 → 03/02						
2.2 16V	Petrol	116	02/00 →	ENGINE: EW12J4					
2.2 HDi	Diesel	98	02/00 →	ENGINE: 4HX(DW12TED4/FAP)				50CDDP1	B3
2.2 HDi	Diesel	98	02/00 → 11/04						
2.2 HDi	Diesel	125	05/06 →						
2.2 HDi	Diesel	98	02/00 →						
2.2 HDi	Diesel	125	05/06 →						
2.7 HDi 24V	Diesel	150	12/04 →						
3.0 V6 24V	Petrol	152	02/00 → 11/04						



TYPE

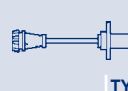

TYPE



TYPE

									BAE680AF		
			SPA102	F1		SAG150	H1		ESS0095A	J1	
						SAG150	H1		ESS0095A	J1	
									BAE680AF		
			SPA102	F1		SAG150	H1				
			SPA102	F1		SAG150	H1				
						SAG150	H1				
			SPA102	F1							
			SPA102	F1		SAG150	H1		ESS0095A	J1	
	APS45					SAD013	H3		ESS0095A	J1	
						SAG150	H1				
	APS76										
						SAG150	H1		ESS0095A	J1	
		RPM58	IATS04/01	F2	SAA118	SAC070	H2				
			SPA107	F1		SAD033	H3				
						SAG027	H1				
						SAG126	H1				
	APS38		ATS22	F2	SAA118	SAC096	H2				
	APS35					SAG169	H1				
			SPA172	F1	SAA118	SAG027	H1				
					SAA118						
	APS77				SAA118	SAC070	H2				
			SPA107	F1							
			SPA172	F1							
					SAA118	SAC070	H2				
						SAD033	H3				
						SAD033	H3				
						SAG027	H1				
						SAG126	H1				
									GA2002	J2	
	APS35										
			ATS22	F2	SAA118	SAC096	H2				
			SPA172	F1	SAA118	SAG027	H1		SUA373	J2	
						SAG167	H1				
									GA2081	J2	
	APS62										



KW

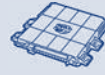

TYPE



TYPE

PEUGEOT

607 (9D, 9U)

3.0 V6 24V	Petrol	155	12/04 →					
3.0 V6 24V	Petrol	152	02/00 →					
3.0 V6 24V	Petrol	155	08/04 →					
3.0 V6 24V	Petrol	155	03/04 →					
3.0 V6 24V	Petrol	152	02/00 →	ENGINE: ES8J4S				

806 (221)

1.9 TD	Diesel	66	07/95 → 08/02					
1.9 TD	Diesel	68	05/97 → 08/02					
2.0	Petrol	89	06/94 → 08/02			B04	B1	
2.0	Petrol	89	06/94 → 12/95			PF90/018	B6	
2.0	Petrol	89	01/96 → 08/02			PF16080067	B6	
2.0	Petrol	89	06/94 → 08/02	ENGINE: XU10J2CZ				
2.0	Petrol	89	06/94 → 08/02	ENGINE: XU10J2CZ				
2.0	Petrol	89	06/94 → 12/00	ENGINE: C(XU10J2- XU10J2TE-XU10J4R)				
2.0 16V	Petrol	100	09/00 → 08/02	ENGINE: EW10J4		B33	B1	
2.0 16V	Petrol	97	05/98 → 09/00			B3385	B1	
2.0 16V	Petrol	97	05/98 → 09/00	ENGINE: EW10J4		B33	B1	
2.0 16V	Petrol	97	05/98 → 12/98					
2.0 16V	Petrol	100	09/00 → 08/02					
2.0 16V	Petrol	100	09/00 → 08/02					
2.0 16V	Petrol	97	05/98 → 09/00					
2.0 16V	Petrol	100	09/00 → 08/02					
2.0 HDi	Diesel	80	08/99 → 08/02					
2.0 HDi	Diesel	80	09/99 → 08/02					
2.0 HDi	Diesel	80	08/99 → 12/00	ENGINE: DW10				
2.0 HDi	Diesel	80	01/01 → 08/02	ENGINE: DW10				
2.0 HDi	Diesel	80	07/01 → 08/02					
2.0 HDi 16V	Diesel	80	08/99 → 08/02					
2.0 HDi 16V	Diesel	80	01/01 → 08/02	ENGINE: DW10				
2.0 HDi 16V	Diesel	80	07/01 → 08/02					
2.0 Turbo	Petrol	108	06/94 → 06/95			SVF015	B6	
2.0 Turbo	Petrol	108	06/94 → 08/02					

807 (E)

2.0	Petrol	100	06/02 →	ENGINE: EW10J4	IAW48P2.34/2	A1	
2.0	Petrol	100	06/02 →				
2.0	Petrol	100	06/02 →				
2.0 16V	Petrol	103	09/05 →				
2.0 HDi	Diesel	100	06/06 →	ENGINE: RHR(DW10BTED4)		50CDDP8	B3
2.0 HDi	Diesel	79	06/02 →	ENGINE: RHK(DW10UTED4)		50CDSP6	B3
2.0 HDi	Diesel	88	02/06 →	ENGINE: RHK(DW10UTED4)		50CDSP6	B3
2.0 HDi	Diesel	88	02/06 → 11/07	ENGINE: RHK(DW10UTED4)		50CDSP3	B3
2.0 HDi	Diesel	88	11/07 →	ENGINE: RHK(DW10UTED4)		50CAD281	B3
2.0 HDi	Diesel	79	06/02 →				



TYPE

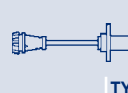

TYPE



TYPE

APPS									
APPS	Model	Code	Type	Part 1	Part 2	Part 3	Part 4	Part 5	Part 6
APPS62		SPA107	F1	SAA118	SAG027	H1	BAE680BD		
				SAA118	SAD008	H3	BAE680BD		
								GA2002	J2
APPS62		SPA102	F1	SAA118	SAG150	H1		SUA146	J3
				SAA118	SAG150	H1		SUA146	J3
				SAA118	SAG150	H1	BAE680AF	ESS0095A	J1
APPS36	KITRPM36 RPM36	SZA101	F1						
								SUA378	J2
				SAA118	SAD008	H3		ESS0095A	J1
APPS76		SPA107	F1	SAA118	SAC070	H2			
					SAD033	H3			
					SAG150	H1			
					SAG157	H1			
APPS35		SPA107	F1	SAA118	SAG028	H1			
					SAG027	H1			
								SUA463	J2
								SUA494	J2
APPS35		SPA107	F1	SAA118				SUA467	J2
								SUA146	J3
								SUA494	J2
								SUA467	J2
APPS35		SPA107	F1	SAA118				SAA118	SAG150
								H1	BAE680AF
APPS62		SPA107	F1	SAA118	SAC070	H2			
					SAD033	H3			
APPS77		SPA107	F1	SAA118	SAC070	H2			
APPS35		ATS22	F2	SAA118	SAC096	H2			



KW



TYPE



TYPE

PEUGEOT

807 (E)

2.0 HDi	Diesel	100	06/06 →					
2.0 HDi	Diesel	100	06/06 →					
2.0 HDi	Diesel	79	06/02 → 12/06					
2.2	Petrol	116	06/02 →	ENGINE: 3FZ(EW12J4)			60CPM2	B3
2.2	Petrol	116	06/02 →	ENGINE: 3FZ(EW12J4)			KITBLOW	B2
2.2	Petrol	116	06/02 →					
2.2	Petrol	116	06/02 →					
2.2 HDi	Diesel	94	06/02 →					
2.2 HDi	Diesel	125	06/06 →					
2.2 HDi	Diesel	125	06/06 →					
2.2 HDi	Diesel	94	06/02 → 07/06					
3.0 V6	Petrol	150	06/02 →					

BIPPER (AA_)

1.4	Petrol	54	01/10 →					
1.4	Petrol	54	02/08 →					
1.4 HDi	Diesel	50	02/08 →					
1.4 HDi	Diesel	50	02/08 →					

BIPPER Tepee

1.4	Petrol	54	04/08 →					
1.4 HDi	Diesel	50	04/08 →					

BOXER Autobus

2.2 HDi 100	Diesel	74	04/06 →				AMM19656	B4
2.2 HDi 100	Diesel	74	04/06 →					
2.2 HDi 100	Diesel	74	04/06 →					
2.2 HDi 100	Diesel	74	04/06 →	ENGINE: PUMA100				
2.2 HDi 120	Diesel	88	04/06 →				AMM19656	B4
2.2 HDi 120	Diesel	88	04/06 →					
2.2 HDi 120	Diesel	88	04/06 →					
2.2 HDi 120	Diesel	88	04/06 →	ENGINE: PUMA120				
2.2 HDi 130	Diesel	96	03/11 →				AMM19656	B4
3.0 HDi 160	Diesel	116	04/06 →					
3.0 HDi 160	Diesel	116	04/06 →					
3.0 HDi 160	Diesel	116	04/06 →					
3.0 HDi 160	Diesel	116	04/06 →	ENGINE: F30DT				
3.0 HDi 175	Diesel	130	03/11 →					

BOXER Autobus (230P)

1.9 TD	Diesel	66	08/94 → 04/02					
1.9 TD	Diesel	68	03/94 → 04/02					
2.0 i	Petrol	80	03/94 → 04/02				B04	B1
2.0 i	Petrol	80	03/94 → 04/02				B3385	B1
2.0 i	Petrol	80	03/94 → 12/95				PF90/018	B6
2.0 i	Petrol	80	01/96 → 04/02				PF16080067	B6
2.0 i	Petrol	80	03/94 → 04/02	ENGINE: XU10J2U				
2.0 i	Petrol	80	03/94 → 04/02	ENGINE: XU10J2U				



TYPE

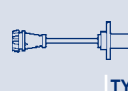

TYPE



TYPE

				ATS22	F2	SAA118	SAC096	H2	SUA456	J3
				SPA172	F1		SAG169	H1		
									SUA467	J2
				SPA107	F1	SAA118	SAC070	H2		
							SAD033	H3		
	APS35			SPA107	F1	SAA118				
				ATS22	F2	SAA118	SAC096	H2		
				SPA172	F1		SAG167	H1		
									SUA467	J2
	APS62			SPA107	F1	SAA118			BAE680BD	
				SPA107	F1					
						SAA118	SAG164	H1		
				ATS22	F2	SAA118	SAG167	H1		
				SPA172	F1					
				SPA107	F1					
							SAG167	H1		
						SAA113			SUA587	J3
									SUA588	J3
									SUA589	J3
									SUA512	J3
						SAA113			SUA587	J3
									SUA588	J3
									SUA589	J3
									SUA512	J3
									SUA587	J3
									SUA588	J3
									SUA589	J3
									SUA512	J3
							SAF001	H4		
				SPA102	F1	SAA118				
						SAA118				
						SAA118	SAC070	H2		
							SAG150	H1		
	PRT03/04	KITRPM36	SZA101	F1						
		RPM36								



KW



TYPE



TYPE

PEUGEOT

BOXER Autobus (230P)

2.0 i	Petrol	80	03/94 → 02/02					
2.5 D	Diesel	63	08/94 → 04/02					
2.5 TD	Diesel	76	07/94 → 04/02					
2.5 TDI	Diesel	79	01/97 → 04/02					
2.5 TDI 4x4	Diesel	79	01/97 → 04/02					
2.8 HDi	Diesel	94	11/00 → 04/02					
2.8 HDi	Diesel	93	10/00 → 11/01					
2.8 HDi 4x4	Diesel	94	10/00 → 04/02					

BOXER Autobus (244, Z_)

2.0	Petrol	81	04/02 →					
2.0	Petrol	81	04/02 →					
2.0	Petrol	81	04/02 →					
2.0	Petrol	81	04/02 → 05/06					
2.0 HDi	Diesel	62	04/02 →					
2.2 HDi	Diesel	74	04/02 →					
2.8 HDi	Diesel	94	04/02 →					
2.8 HDi 4x4	Diesel	94	04/02 →					

BOXER Furgonato

2.2 HDi 100	Diesel	74	04/06 →			AMM19656	B4
2.2 HDi 100	Diesel	74	04/06 →				
2.2 HDi 100	Diesel	74	04/06 →				
2.2 HDi 120	Diesel	88	04/06 →			AMM19656	B4
2.2 HDi 120	Diesel	88	04/06 →				
2.2 HDi 120	Diesel	88	04/06 →				
2.2 HDi 120	Diesel	88	04/06 →	ENGINE: PUMA120			
2.2 HDi 130	Diesel	96	03/11 →			AMM19656	B4
3.0 HDi 160	Diesel	116	04/06 →				
3.0 HDi 160	Diesel	116	04/06 →				
3.0 HDi 160	Diesel	116	04/06 →				
3.0 HDi 160	Diesel	116	04/06 →	ENGINE: F30DT			
3.0 HDi 175	Diesel	130	03/11 →				

BOXER Furgonato (230L)

1.9 D	Diesel	50	07/99 → 04/02				
1.9 DT 4x4	Diesel	66	03/96 → 09/98				
1.9 TD	Diesel	66	07/99 → 04/02				
2.0 4x4	Petrol	80	03/96 → 09/98				
2.0 HDi	Diesel	62	08/01 → 04/02				
2.0 i	Petrol	80	06/94 → 04/02			B04	B1
2.0 i	Petrol	80	06/94 → 12/95			PF90/018	B6
2.0 i	Petrol	80	01/96 → 04/02			PF16080067	B6
2.0 i	Petrol	80	06/94 → 04/02	ENGINE: XU10J2U			
2.0 i	Petrol	80	06/94 → 04/02	ENGINE: XU10J2U			
2.0 i	Petrol	80	06/94 → 04/02				
2.0 i	Petrol	80	06/94 → 02/02				



KW

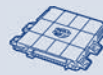

TYPE



TYPE

PEUGEOT

BOXER Furgonato (230L)

2.5 D 4x4	Diesel	63	07/99 → 04/02					
2.5 TDI	Diesel	79	01/97 → 04/02					
2.5 TDI 4x4	Diesel	79	07/99 → 04/02					
2.8 HDi	Diesel	94	11/00 → 04/02					
2.8 HDi	Diesel	93	10/00 → 11/01					
2.8 HDi 4x4	Diesel	94	10/00 → 04/02					

BOXER Furgonato (244)

2.0	Petrol	81	04/02 →					
2.0	Petrol	81	04/02 →					
2.0	Petrol	81	04/02 →					
2.0	Petrol	81	04/02 → 05/06					
2.0 HDi	Diesel	62	04/02 →					
2.2 HDi	Diesel	74	04/02 →					
2.8 HDi	Diesel	94	04/02 →					
2.8 HDi	Diesel	107	04/04 →					
2.8 HDi 4x4	Diesel	94	04/02 →					

BOXER Pianale piatto/Telaio

2.2 HDi 100	Diesel	74	04/06 →				AMM19656	B4
2.2 HDi 100	Diesel	74	04/06 →					
2.2 HDi 100	Diesel	74	04/06 →					
2.2 HDi 120	Diesel	88	04/06 →				AMM19656	B4
2.2 HDi 120	Diesel	88	04/06 →					
2.2 HDi 120	Diesel	88	04/06 →					
2.2 HDi 120	Diesel	88	04/06 →	ENGINE: PUMA120				
2.2 HDi 130	Diesel	96	03/11 →				AMM19656	B4
3.0 HDi 160	Diesel	116	04/06 →					
3.0 HDi 160	Diesel	116	04/06 →					
3.0 HDi 160	Diesel	116	04/06 →					
3.0 HDi 160	Diesel	116	04/06 →	ENGINE: F30DT				
3.0 HDi 175	Diesel	130	03/11 →					

BOXER Pianale piatto/Telaio (244)

2.0 HDi	Diesel	62	04/02 →					
2.2 HDi	Diesel	74	04/02 →					
2.8 HDi	Diesel	94	04/02 →					
2.8 HDi	Diesel	107	04/04 →					
2.8 HDi 4x4	Diesel	94	04/02 →					

BOXER Pianale piatto/Telaio (ZCT_)

1.9 TD	Diesel	66	12/98 → 04/02					
1.9 TD	Diesel	68	07/96 → 04/02					
2.0	Petrol	81	12/01 → 04/02					
2.0	Petrol	81	02/02 → 04/02					
2.0 i	Petrol	80	06/94 → 04/02				B04	B1
2.0 i	Petrol	80	06/94 → 12/95				PF90/018	B6
2.0 i	Petrol	80	01/96 → 04/02				PF16080067	B6

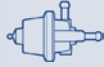

TYPE



TYPE



TYPE

					SAA118				
					SAA118				
					SAA118				
				SPA103	F1		SAG089	H1	ESS0066A J1
									ESS0066A J1
									ESS0066A J1
				SPA167	F1	SAA118	SAC070	H2	
							SAD033	H3	
							SAG157	H1	
								BAE680AF	
						SAA118			ESS0066A J1
						SAA118	SAG157	H1	ESS0066A J1
				SPA103	F1		SAG089	H1	ESS0066A J1
							SAG089	H1	ESS0066A J1
				SPA103	F1		SAG089	H1	ESS0066A J1
						SAA113			SUA587 J3
									SUA588 J3
									SUA589 J3
						SAA113			SUA587 J3
									SUA588 J3
									SUA589 J3
									SUA512 J3
									SUA587 J3
									SUA588 J3
									SUA589 J3
									SUA512 J3
							SAF001	H4	
						SAA118			ESS0066A J1
						SAA118	SAG157	H1	ESS0066A J1
				SPA103	F1		SAG089	H1	ESS0066A J1
							SAG089	H1	ESS0066A J1
				SPA103	F1		SAG089	H1	ESS0066A J1
						SAA118			
						SAA118			
							SAC070	H2	
								BAE680AF	
						SAA118	SAC070	H2	



KW

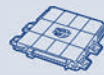

TYPE



TYPE

PEUGEOT

BOXER Pianale piatto/Telaio (ZCT_)

2.0 i	Petrol	80	06/94 → 04/02	ENGINE: XU10J2U				
2.0 i	Petrol	80	06/94 → 04/02	ENGINE: XU10J2U				
2.0 i	Petrol	80	06/94 → 04/02					
2.0 i	Petrol	80	06/94 → 02/02					
2.5 D	Diesel	63	03/94 → 04/02					
2.5 D 4x4	Diesel	63	07/99 → 04/02					
2.5 TD	Diesel	76	03/94 → 04/02					
2.5 TDI	Diesel	79	01/97 → 04/02					
2.5 TDI 4x4	Diesel	79	07/99 → 04/02					
2.8 HDi	Diesel	94	11/00 → 04/02					
2.8 HDi	Diesel	93	10/00 → 11/01					

EXPERT (224)

1.8	Petrol	74	10/96 → 09/00					
1.9 D	Diesel	51	12/03 → 10/06					
1.9 TD	Diesel	66	02/96 →					
1.9 TD	Diesel	66	09/99 →					
2.0	Petrol	100	12/03 →	ENGINE: EW10J4			B33	B1
2.0	Petrol	100	07/00 →					
2.0	Petrol	100	07/00 →					
2.0	Petrol	100	07/00 →					
2.0	Petrol	100	07/00 → 12/00					
2.0 HDi	Diesel	80	07/00 →					
2.0 HDi	Diesel	69	10/00 → 11/03					
2.0 HDi	Diesel	80	07/00 → 10/06					
2.0 HDi	Diesel	69	01/03 → 11/03	ENGINE: DW10-HDI				
2.0 HDi	Diesel	69	07/01 → 11/03					
2.0 HDi	Diesel	80	01/03 →	ENGINE: DW10-HDI				
2.0 HDi	Diesel	80	07/01 → 01/07					
2.0 HDi 16V	Diesel	80	07/00 →					
2.0 HDi 16V	Diesel	80	05/02 →					
2.0 HDi 16V	Diesel	80	01/03 →	ENGINE: DW10-HDI				
2.0 HDi 16V	Diesel	80	07/01 → 01/07					

EXPERT Furgonato (222)

1.6	Petrol	58	02/96 →					
1.6	Petrol	58	09/99 →					
1.8	Petrol	74	10/96 → 09/00					
1.9 D	Diesel	51	02/96 →					
1.9 D	Diesel	51	09/99 →					
1.9 D 70	Diesel	51	12/98 →					
1.9 TD	Diesel	66	02/96 →					
1.9 TD	Diesel	68	02/96 →					
1.9 TD	Diesel	66	09/99 →					
1.9 TD	Diesel	68	09/99 →					
2.0	Petrol	100	12/03 →	ENGINE: EW10J4			B33	B1

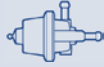

TYPE



TYPE



TYPE

	PRT03/04	KITRPM36	SZA101	F1						
		RPM36								
						SAG150	H1			
								BAE680AF		
						SAA118				
						SAA118				
						SAA118				
						SAA118				
						SAA118				
			SPA103	F1		SAG089	H1		ESS0066A	J1
									ESS0066A	J1
						SAA118			BAE680AF	
			SPA107	F1						
						SAA118	SAG028	H1	SUA146	J3
							SAG027	H1		
			SPA107	F1	SAA118	SAC070	H2			
						SAD033	H3			
						SAG027	H1			
						SAG157	H1			
	APS35				SAA118	SAG027	H1			
			SPA107	F1						
			SPA107	F1						
									SUA463	J2
									SUA467	J2
									SUA463	J2
									SUA467	J2
	APS35				SAA118					
			SPA172	F1						
									SUA463	J2
									SUA467	J2
						SAG028	H1			
						SAG027	H1			
					SAA118				BAE680AF	
					SAA118	SAG028	H1		SUA146	J3
						SAG027	H1			
			SPA107	F1	SAA118					
					SAA118	SAG028	H1		SUA146	J3
					SAA118	SAG028	H1		SUA146	J3
						SAG027	H1			
						SAG027	H1			



KW

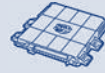

TYPE



TYPE

PEUGEOT

EXPERT Furgonato (222)

2.0	Petrol	100	09/02 →						
2.0	Petrol	100	09/02 →						
2.0 HDi	Diesel	69	07/00 →						
2.0 HDi	Diesel	80	07/00 →						
2.0 HDi	Diesel	80	07/00 →						
2.0 HDi	Diesel	80	07/00 → 10/06						
2.0 HDi	Diesel	80	05/02 →						
2.0 HDi	Diesel	69	01/03 →	ENGINE: DW10-HDI					
2.0 HDi	Diesel	69	07/01 → 01/07						
2.0 HDi	Diesel	80	01/03 →	ENGINE: DW10-HDI					
2.0 HDi	Diesel	80	01/03 →	ENGINE: DW10-HDI					
2.0 HDi	Diesel	80	07/01 → 01/07						
2.0 HDi	Diesel	80	07/01 → 01/07						

EXPERT Furgonato (VF3A_, VF3U_, VF3X_)

1.6 HDi 90 16V	Diesel	66	01/07 →						
1.6 HDi 90 16V	Diesel	66	01/07 →						
1.6 HDi 90 16V	Diesel	66	01/07 →	ENGINE: DV6TED4					
2.0 16V	Petrol	103	01/07 →						
2.0 16V	Petrol	103	01/07 →	ENGINE: EW10J4					
2.0 16V	Petrol	103	01/07 →	ENGINE: EW10J4					
2.0 HDi 120	Diesel	88	01/07 →	ENGINE: RHK(DW10UTED4)		50CDSP6		B3	
2.0 HDi 120	Diesel	88	01/07 → 11/07	ENGINE: RHK(DW10UTED4)		50CDSP3		B3	
2.0 HDi 120	Diesel	88	11/07 →	ENGINE: RHK(DW10UTED4)		50CAD281		B3	
2.0 HDi 120	Diesel	88	01/07 →						
2.0 HDi 120	Diesel	88	01/07 →						
2.0 HDi 120	Diesel	88	01/07 →						
2.0 HDi 120	Diesel	88	01/07 →	ENGINE: DW10TEDA					
2.0 HDi 140	Diesel	100	01/07 →						
2.0 HDi 140	Diesel	100	01/07 →						

EXPERT Pianale piatto/Telaio

1.6 HDi 90	Diesel	66	01/07 →						
1.6 HDi 90	Diesel	66	01/07 →						
1.6 HDi 90	Diesel	66	01/07 →	ENGINE: DV6TED4					
2.0 HDi 120	Diesel	88	01/07 →	ENGINE: RHK(DW10UTED4)		50CDSP6		B3	
2.0 HDi 120	Diesel	88	01/07 → 11/07	ENGINE: RHK(DW10UTED4)		50CDSP3		B3	
2.0 HDi 120	Diesel	88	11/07 →	ENGINE: RHK(DW10UTED4)		50CAD281		B3	
2.0 HDi 120	Diesel	88	01/07 →						
2.0 HDi 120	Diesel	88	01/07 →						
2.0 HDi 120	Diesel	88	01/07 →						
2.0 HDi 120	Diesel	88	01/07 →	ENGINE: DW10TEDA					
2.0 HDi 140	Diesel	100	01/07 →						
2.0 HDi 140	Diesel	100	01/07 →						



TYPE



TYPE



TYPE

			SPA107	F1	SAA118	SAC070	H2		
						SAD033	H3		
	APS35		SPA107	F1	SAA118	SAG027	H1		
	APS35				SAA118				
	APS35				SAA118				
			SPA107	F1					
			SPA172	F1					
								SUA463	J2
								SUA467	J2
								SUA463	J2
								SUA463	J2
								SUA467	J2
								SUA467	J2
	APS38		ATS22	F2	SAA118	SAC096	H2		
						SAG167	H1		
								SUA512	J3
			SPA107	F1	SAA118				
								GA2036	J2
								GA2037	J2
	APS38		ATS22	F2	SAA118	SAC096	H2		
								SUA587	J3
								SUA588	J3
								SUA589	J3
								SUA512	J3
	APS38		ATS22	F2	SAA118	SAC096	H2		
						SAG169	H1		
	APS38		ATS22	F2	SAA118	SAC096	H2		
						SAG167	H1		
								SUA512	J3
	APS38		ATS22	F2	SAA118	SAC096	H2		
								SUA587	J3
								SUA588	J3
								SUA589	J3
								SUA512	J3
	APS38		ATS22	F2	SAA118	SAC096	H2		
						SAG169	H1		



KW



TYPE



TYPE

PEUGEOT

EXPERT Pianale piatto/Telaio (223)

1.6	Petrol	58	02/96 →					
1.6	Petrol	58	09/99 →					
1.9 D	Diesel	51	06/98 → 11/03					
1.9 D	Diesel	51	02/96 →					
1.9 D	Diesel	51	09/99 →					
1.9 TD	Diesel	66	02/96 →					
1.9 TD	Diesel	68	02/96 →					
1.9 TD	Diesel	66	09/99 →					
1.9 TD	Diesel	68	09/99 →					
2.0 HDi	Diesel	80	10/00 → 10/06					

EXPERT Tepee (VF3V_)

1.6 HDi 90 16V	Diesel	66	01/07 →					
1.6 HDi 90 16V	Diesel	66	01/07 →					
1.6 HDi 90 16V	Diesel	66	01/07 →	ENGINE: DV6TED4				
2.0 16V	Petrol	103	01/07 →					
2.0 16V	Petrol	103	01/07 →	ENGINE: EW10J4				
2.0 16V	Petrol	103	01/07 →	ENGINE: EW10J4				
2.0 HDi 120	Diesel	88	01/07 →	ENGINE: RHK(DW10UTED4)		50CDSP6	B3	
2.0 HDi 120	Diesel	88	01/07 → 11/07	ENGINE: RHK(DW10UTED4)		50CDSP3	B3	
2.0 HDi 120	Diesel	88	11/07 →	ENGINE: RHK(DW10UTED4)		50CAD281	B3	
2.0 HDi 120	Diesel	88	01/07 →					
2.0 HDi 120	Diesel	88	01/07 →					
2.0 HDi 120	Diesel	88	01/07 →					
2.0 HDi 120	Diesel	88	01/07 →	ENGINE: DW10TEDA				
2.0 HDi 140	Diesel	100	01/07 →					
2.0 HDi 140	Diesel	100	01/07 →					

PARTNER Pianale piatto/Telaio

1.6 HDi	Diesel	55	01/09 →					
1.6 HDi	Diesel	66	01/09 →					

RANCH

1.6	Petrol	88	04/10 →					
1.6	Petrol	66	04/08 →					
1.6	Petrol	80	04/08 →					
1.6	Petrol	72	08/10 →					
1.6 HDi	Diesel	55	04/08 →					
1.6 HDi	Diesel	66	04/08 →					
1.6 HDi	Diesel	80	04/08 →					
1.6 HDi	Diesel	55	04/08 →					
1.6 HDi	Diesel	66	04/08 →					
1.6 HDi	Diesel	80	04/08 →					
1.6 HDi 90	Diesel	68	04/10 →					

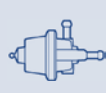

TYPE

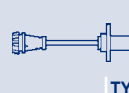

TYPE



TYPE

						SAG028	H1		
						SAG027	H1		
			SPA107	F1					
					SAA118	SAG028	H1	SUA146	J3
						SAG027	H1		
					SAA118	SAG028	H1	SUA146	J3
					SAA118	SAG028	H1	SUA146	J3
						SAG027	H1		
						SAG027	H1		
			SPA107	F1					
	APS38		ATS22	F2	SAA118	SAC096	H2		
						SAG167	H1		
								SUA512	J3
			SPA107	F1	SAA118				
								GA2036	J2
								GA2037	J2
	APS38		ATS22	F2	SAA118	SAC096	H2	SUA587	J3
								SUA588	J3
								SUA589	J3
								SUA512	J3
	APS38		ATS22	F2	SAA118	SAC096	H2		
						SAG169	H1		
						SAG167	H1		
						SAG167	H1		
	APS71							BAE680BR	
			SPA161	F1	SAA118				
			SPA161	F1	SAA118	SAG167	H1		
								BAE680BR	
	APS38		ATS22	F2	SAA118	SAC096	H2	SUA584	J3
	APS38		ATS22	F2	SAA118	SAC096	H2		
	APS38		ATS22	F2	SAA118	SAC096	H2		
						SAG167	H1		
						SAG167	H1		
						SAG167	H1		
						SAG167	H1		



KW



TYPE



TYPE

PEUGEOT

RANCH Furgonato

1.6	Petrol	66	04/08 →					
1.6	Petrol	80	04/08 →					
1.6	Petrol	72	11/10 →					
1.6	Petrol	88	04/10 →					
1.6 HDi	Diesel	55	04/08 →					
1.6 HDi	Diesel	66	04/08 →					
1.6 HDi	Diesel	80	04/08 →					
1.6 HDi	Diesel	55	04/08 →					
1.6 HDi	Diesel	66	04/08 →					
1.6 HDi	Diesel	80	04/08 →					

RANCH Furgonato (5)

1.4	Petrol	54	11/02 → 10/06					
1.4 BiFuel	Petrol/CNG	55	04/03 →					
1.6	Petrol	80	09/00 → 10/02					
1.6	Petrol	80	09/00 → 10/02					
1.6 HDi 75	Diesel	55	02/06 →					
1.6 HDi 90	Diesel	66	02/06 →					
1.6 HDi 90	Diesel	66	02/06 →					
1.9 D	Diesel	51	06/96 →					
1.9 D	Diesel	51	09/02 →					
1.9 D 4x4	Diesel	51	04/04 →					
2.0 HDi	Diesel	66	04/00 →					
2.0 HDi	Diesel	66	04/00 → 08/02					
2.0 HDi	Diesel	66	01/01 →					
2.0 HDi 4x4	Diesel	66	04/04 →					

RANCH MPV / Space wagon (5F)

1.1	Petrol	44	01/02 →	ENGINE: TU1JP			B35/00	B1
1.1	Petrol	44	09/00 →					
1.1	Petrol	44	06/96 →					
1.1	Petrol	44	03/98 →					
1.1	Petrol	44	09/00 → 08/02					
1.1	Petrol	44	06/96 →					
1.1	Petrol	44	06/96 → 01/98					
1.1	Petrol	44	09/02 →					
1.1	Petrol	44	07/96 → 08/02					
1.4	Petrol	55	06/96 → 06/97	ENGINE: TU3JP	IAW1AP.40	A1		
1.4	Petrol	55	06/96 →	ENGINE: KFX(TU3JP) KFW(TU3JP)			B3387	B1
1.4	Petrol	55	06/96 →	ENGINE: TU3JP,L3			B24/00	B1
1.4	Petrol	55	06/96 → 12/00				KITPF2C	B6
1.4	Petrol	55	01/00 → 11/00	ENGINE: TU3JP,L3			B32/01	B1
1.4	Petrol	54	11/02 → 10/06					
1.4	Petrol	55	06/96 →					
1.4	Petrol	55	06/96 → 12/98					



TYPE

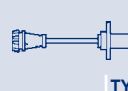

TYPE



TYPE

			SPA161	F1	SAA118						
			SPA161	F1	SAA118	SAG167	H1				
						SAC072	H2	BAE680BR			
								BAE680BR			
	APS38		ATS22	F2	SAA118	SAC096	H2				
	APS38		ATS22	F2	SAA118	SAC096	H2				
	APS38		ATS22	F2	SAA118	SAC096	H2				
						SAG167	H1				
						SAG167	H1				
						SAG167	H1				
						SAD030	H3				
FEI0002	APS77		SPA107	F1	SAA118	SAG164	H1				
			SPA107	F1		SAD030	H3				
						SAG167	H1				
			ATS22	F2	SAA118	SAC096	H2				
			ATS22	F2	SAA118	SAC096	H2				
						SAG167	H1				
			SPA107	F1	SAA118						
						SAG150	H1				
			SPA107	F1	SAA118	SAG150	H1				
			SPA172	F1	SAA118	SAG027	H1				
						SAG157	H1		GA2033	J2	
									SUA377	J2	
			SPA172	F1							
	APS77					SAG164	H1				
			SPA107	F1	SAA118				ESS0034A	J1	
			SPA164	F1							
			SPA167	F1							
									GA2193	J2	
						SAG156	H1				
						SAD030	H3				
									BAE680AF		
FEI0002			SPA107	F1							
FEI0002			IATS04	F2	SAA118	SAC064	H2		GA2002	J2	
	APS76										



KW

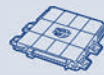

TYPE



TYPE

PEUGEOT

RANCH MPV / Space wagon (5F)

1.4	Petrol	55	09/00 →					
1.4	Petrol	55	06/96 →	ENGINE: TU3JPL,3				
1.4	Petrol	55	06/96 →	ENGINE: TU3JPL,3				
1.4	Petrol	55	06/96 →					
1.4	Petrol	55	04/98 →					
1.4	Petrol	55	09/00 → 08/02					
1.4	Petrol	55	06/96 → 01/98					
1.4	Petrol	55	07/96 → 06/98					
1.6 16V	Petrol	80	07/01 →			TB0015		B3
1.6 16V	Petrol	80	07/01 → 08/02					
1.6 16V	Petrol	80	07/01 → 09/02					
1.6 16V	Petrol	80	09/02 →					
1.6 16V	Petrol	80	07/01 →	ENGINE: TU5JP4				
1.6 HDi 75	Diesel	55	02/06 →					
1.6 HDi 90	Diesel	66	02/06 →					
1.6 HDi 90	Diesel	66	02/06 →					
1.8	Petrol	66	05/97 →	ENGINE: XU7JB		B32/00		B1
1.8	Petrol	66	05/97 → 12/00			KITPF2C		B6
1.8	Petrol	66	01/98 →			B22/1		B1
1.8	Petrol	66	05/97 →	ENGINE: XU7JB				
1.8	Petrol	66	05/97 → 12/98					
1.8	Petrol	66	05/97 →					
1.8	Petrol	66	05/97 → 08/02					
1.9 D	Diesel	51	12/98 →					
1.9 D	Diesel	50	06/96 →					
1.9 D	Diesel	51	05/96 → 12/98					
1.9 D	Diesel	51	09/02 →					
1.9 D	Diesel	50	06/96 → 12/00	ENGINE: XUD9				
1.9 D	Diesel	50	01/01 →	ENGINE: DW8				
1.9 D	Diesel	51	12/98 → 12/00	ENGINE: XUD9				
1.9 D	Diesel	51	01/01 →	ENGINE: DW8				
1.9 D 4x4	Diesel	51	04/04 → 08/05					
2.0 HDi	Diesel	66	02/00 →					
2.0 HDi	Diesel	66	02/00 → 08/02					
2.0 HDi	Diesel	66	01/01 →					
2.0 HDi	Diesel	66	07/00 → 08/02					
2.0 HDi 4x4	Diesel	66	04/04 → 08/05					

RCZ

1.6 16V	Petrol	115	03/10 →					
1.6 16V	Petrol	147	06/10 →					



TYPE

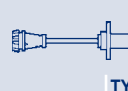

TYPE



TYPE

	APS77					SAG164	H1			
		KITRPM40	SZA101	F1						
		RPM40								
			SPA107	F1						
			SPA164	F1		SAD030	H3			
			SPA167	F1						
						SAG156	H1			
								BAE680AF		
	APS77		SPA107	F1	SAA118	SAG167	H1			
			SPA167	F1		SAG126	H1			
						SAD030	H3			
						SAG164	H1			
									GA2002	J2
			ATS22	F2	SAA118	SAC096	H2			
			ATS22	F2	SAA118	SAC096	H2			
						SAG167	H1			
IWP049/1		KITRPM40	SZA101	F1						
		RPM40								
	APS76									
					SAA118	SAG150	H1		ESS0092A	J1
								BAE680AF		
			SPA107	F1	SAA118					
					SAA118					
					SAA118					
						SAG150	H1			
									SUA371	J3
									SUA405	J3
									SUA371	J3
									SUA405	J3
			SPA107	F1	SAA118					
			SPA172	F1	SAA118	SAG027	H1			
						SAG157	H1			
									SUA377	J2
									GA2033	J2
					SAA118					
	APS47					SAC072	H2			
						SAC072	H2			



KW



TYPE



TYPE

PORSCHE

911

2.7	Petrol	121	09/75 → 06/77					
3.0 SC	Petrol	150	08/80 → 07/83					
3.0 SC Carrera	Petrol	132	07/77 → 06/80					
3.0 SC Carrera	Petrol	147	09/75 → 06/77					
3.3 SC Turbo	Petrol	221	09/77 → 06/87					
3.3 Turbo	Petrol	221	06/86 → 08/89					

911 (964)

3.3 Turbo	Petrol	235	08/90 → 09/93					
3.6 Turbo	Petrol	265	01/93 → 09/93					

911 (993)

3.6 Carrera	Petrol	200	10/93 → 08/95				SVF015	B6
3.6 Carrera	Petrol	210	08/95 → 09/97				SVF015	B6
3.6 Carrera 4	Petrol	200	07/94 → 08/95				SVF015	B6
3.6 Carrera 4	Petrol	210	08/95 → 09/97				SVF015	B6
3.6 Turbo 4	Petrol	300	03/95 → 09/97				SVF015	B6
3.8 Carrera 4	Petrol	221	08/95 → 09/97				SVF015	B6
3.8 Carrera RS	Petrol	221	06/95 → 09/97				SVF015	B6

911 (996)

3.4 Carrera	Petrol	221	09/97 → 09/01				SVF016	B6
3.4 Carrera 4	Petrol	221	09/98 → 09/01				SVF016	B6
3.6 Carrera	Petrol	235	10/01 → 07/04				SVF016	B6
3.6 Carrera 4	Petrol	235	10/01 → 07/04				SVF016	B6
3.6 Carrera 4S	Petrol	254	02/03 → 07/04				SVF016	B6
3.6 Carrera S	Petrol	254	02/03 → 07/04				SVF016	B6
3.6 GT2	Petrol	340	04/01 → 08/05					
3.6 GT2	Petrol	355	10/03 → 08/05					
3.6 GT3	Petrol	265	03/99 → 08/01				SVF016	B6
3.6 GT3	Petrol	280	09/03 → 08/05				SVF016	B6
3.6 Turbo 4	Petrol	309	06/00 → 08/05					
3.6 Turbo 4S	Petrol	331	02/03 → 08/05					

911 (997)

3.6 Carrera	Petrol	239	07/04 → 12/08					
3.8 Carrera 4S	Petrol	261	07/04 → 12/08					
3.8 Carrera S	Petrol	261	07/04 → 12/08					

911 Cabriolet

3.0 SC	Petrol	150	08/82 → 07/83					
--------	--------	-----	---------------	--	--	--	--	--

911 Cabriolet (993)

3.6 Carrera	Petrol	200	07/94 → 08/95				SVF015	B6
3.6 Carrera	Petrol	210	08/95 → 09/97				SVF015	B6
3.6 Carrera 4	Petrol	200	07/94 → 08/95				SVF015	B6
3.6 Carrera 4	Petrol	210	08/95 → 09/97				SVF015	B6
3.8 Carrera	Petrol	221	08/95 → 08/95				SVF015	B6
3.8 Carrera 4	Petrol	221	08/95 → 09/97				SVF015	B6

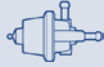

TYPE



TYPE



TYPE

ESS0126A J1

ESS0122A J1

ESS0126A J1

ESS0126A J1

ESS0124A J1

ESS0124A J1

ESS0124A J1

ESS0124A J1

ATS19 F2

ATS10 F2

ATS10 F2

ATS10 F2

ATS10 F2

SAD026 H3

SAD026 H3

SAD026 H3

ESS0122A J1



KW



TYPE



TYPE

PORSCHE

911 Cabriolet (996)

3.4 Carrera	Petrol	221	02/98 → 09/01					SVF016	B6
3.4 Carrera 4	Petrol	221	09/98 → 09/01					SVF016	B6
3.6 Carrera	Petrol	235	10/01 → 07/04					SVF016	B6
3.6 Carrera 4	Petrol	235	10/01 → 07/04					SVF016	B6
3.6 Carrera 4S	Petrol	254	06/02 → 07/04					SVF016	B6
3.6 Carrera S	Petrol	254	06/02 → 07/04					SVF016	B6
3.6 Turbo 4	Petrol	309	10/03 → 08/05						
3.6 Turbo 4S	Petrol	331	10/03 → 08/05						

911 Cabriolet (997)

3.6 Carrera	Petrol	239	04/05 → 12/08						
3.6 Carrera 4	Petrol	239	04/05 → 12/08						
3.8 Carrera 4S	Petrol	261	04/05 → 12/08						
3.8 Carrera S	Petrol	261	04/05 → 12/08						

911 Targa

2.7	Petrol	121	09/75 → 06/77						
3.0 SC Carrera	Petrol	132	07/77 → 06/80						
3.0 SC Carrera	Petrol	147	09/75 → 06/77						

911 Targa (993)

3.6 Carrera	Petrol	210	08/95 → 09/97					SVF015	B6
-------------	--------	-----	---------------	--	--	--	--	--------	----

911 Targa (996)

3.6	Petrol	235	12/01 → 07/04					SVF016	B6
-----	--------	-----	---------------	--	--	--	--	--------	----

914

2.0	Petrol	74	01/72 → 12/75						
-----	--------	----	---------------	--	--	--	--	--	--

924

2.0	Petrol	92	11/75 → 08/89						
2.0 Turbo	Petrol	125	11/78 → 06/80						

928

4.7 S	Petrol	228	08/83 → 07/86						
5.0 GT	Petrol	243	01/89 → 07/91						
5.0 GT	Petrol	243	01/89 → 07/91						
5.0 S,S4	Petrol	235	08/86 → 07/91						
5.0 S,S4	Petrol	235	08/86 → 07/91						
5.0 S4 Cat.	Petrol	235	08/86 → 07/91						
5.0 S4 Cat.	Petrol	235	08/86 → 07/91						
5.4 GTS	Petrol	257	08/91 → 11/95						
5.4 GTS	Petrol	257	08/91 → 11/95						

944

2.5	Petrol	118	08/87 → 07/88						
2.5 TURBO	Petrol	184	09/87 → 07/91						
3.0 S2	Petrol	155	12/88 → 07/91						

944 Cabriolet

3.0 S2	Petrol	155	12/88 → 07/91						
--------	--------	-----	---------------	--	--	--	--	--	--

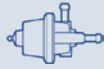

TYPE



TYPE



TYPE

ATS10 F2

ATS10 F2

SAD026 H3

SAD026 H3

SAD026 H3

SAD026 H3

ESS0126A J1

ESS0126A J1

ESS0126A J1

PI024 J1

ESS0126A J1

ESS0126A J1

SPA129 F1

SPA129 F1

SAD021 H3

SAG047 H1

SPA129 F1

SAD021 H3

SAG047 H1

SPA129 F1

SAD021 H3

SAG047 H1

SPA129 F1

SAD021 H3

SAG047 H1

SAG047 H1

SAG047 H1

SAG047 H1

SAG047 H1

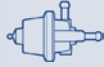

TYPE



TYPE



TYPE

SAG047 H1

SAG047 H1

SAC094 H2

SAC094 H2

SPA111 F1 SAD026 H3

SPA111 F1 SAD026 H3

SPA111 F1 SAD026 H3

SPA111 F1 SAD026 H3

SPA111 F1

SAC094 H2

SPA111 F1

SPA111 F1

SPA111 F1

SPA111 F1

SPA111 F1

SPA111 F1

SPA111 F1

SPA111 F1

ATS10 F2

SPA111 F1 SAD026 H3

SPA111 F1 SAD026 H3

SPA111 F1

BAE680AG

BAE680AG

BAE680AG



KW



TYPE



TYPE

PROTON

PERSONA Tre volumi

1.6 Petrol 82 03/08 →

SAGA II Tre volumi

1.3 Petrol 70 04/10 →

SATRIA (C9_M)

1.3 Petrol 55 07/96 →

SATRIA NEO

1.3 Petrol 70 02/07 → 09/08

1.6 Petrol 81 02/07 →

WIRA

1.3 Petrol 55 08/00 →

1.5 Petrol 64 08/00 →

WIRA 2 volumi /Coda spiovente

1.3 Petrol 55 08/00 →

1.5 Petrol 64 08/00 →

RENAULT

11 (B/C37_)

1.4 (B/C372, B/C37C) Petrol 44 03/83 → 12/88

1.4 (B/C373) Petrol 50 03/83 → 12/85

1.4 (B/C373) Petrol 53 05/83 → 12/85

1.4 (B/C373, B/C37R) Petrol 49 03/83 → 12/88

1.4 Turbo (B/C375) Petrol 77 04/84 → 12/86

1.4 Turbo (B/C375) Petrol 85 10/86 → 12/88

1.7 (B/C376) Petrol 59 10/83 → 12/87

1.7 (B/C37D) Petrol 64 06/87 → 12/88

1.7 (B/C37F) Petrol 55 10/84 → 12/88

1.7 (B/C37L) Petrol 54 10/86 → 12/88

1.7 (B/C37N) Petrol 65 10/86 → 12/88

18 (134_)

1.6 Turbo (1345) Petrol 80 10/80 → 09/82

1.6 Turbo (1345) Petrol 92 10/82 → 07/86

1.6 Turbo Inj. Petrol 82 09/82 → 07/86

18 Variable (135_)

2.0 Petrol 121 04/11 → 07/86

19 I (B/C53_)

1.2 Petrol 40 09/88 → 12/92

1.4 Petrol 59 01/88 → 12/92

1.4 Petrol 59 09/88 → 12/92

1.4 (B/C532) Cat. Petrol 43 01/89 → 04/92

1.4 (B/C532) Cat. Petrol 43 02/91 → 04/92

1.7 Petrol 79 06/89 → 04/92

1.7 (B/C53B) Petrol 54 09/88 → 04/92

1.7 (B/C53B) Petrol 54 09/88 → 04/92

1.7 (B/C53B) Petrol 54 02/91 → 04/92

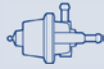

TYPE



TYPE



TYPE

BAE680AG

BAE680AG

BAE680AG

BAE680AG

BAE680AG

BAE680AG

BAE680AG

BAE680AG

BAE680AG

PI024 J1

PI024 J1

PI024 J1

PI024 J1

PI024 J1

PI024 J1

PI024 J1

PI024 J1

ESS0144A J1

PI024 J1

PI024 J1

PI024 J1

PI024 J1

PI024 J1

PI024 J1

SUA351 J3

ESS0130A J1

SUA351 J3

ATS14 F2

SUA351 J3

PI024 J1

SPA160 F1

ESS0130A J1

PI024 J1

SUA351 J3



KW

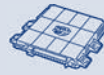

TYPE



TYPE

RENAULT

19 I (B/C53_)

1.7 (B/C53C)	Petrol	66	09/88 → 04/92					
1.7 (B/C53C)	Petrol	66	09/88 → 04/92					
1.7 (B/C53C)	Petrol	66	02/91 → 04/92					
1.8 16V (B/C53D)	Petrol	99	06/89 → 04/92					
1.8 16V (B/C53D)	Petrol	99	06/89 → 04/92					

19 I Cabriolet (D53_)

1.7	Petrol	70	07/91 → 04/92					
1.7	Petrol	70	07/91 → 04/92					
1.8 16V (D53D)	Petrol	101	07/91 → 04/92					

19 I Chamade (L53_)

1.2	Petrol	40	09/88 → 12/92					
1.4 (L532, L53P)	Petrol	43	07/88 → 04/92					
1.4 (L532, L53P)	Petrol	43	09/88 → 04/92					
1.7 (L53B)	Petrol	54	10/89 → 04/92					
1.7 (L53C)	Petrol	66	07/88 → 04/92					
1.7 (L53C)	Petrol	66	07/88 → 04/92					
1.7 (L53F)	Petrol	79	08/88 → 12/92					
1.8 16V (L53D)	Petrol	99	10/89 → 04/92					
1.8 16V (L53D)	Petrol	99	10/89 → 04/92					

19 I Furgonato (S53_)

1.2	Petrol	40	09/88 → 12/92					
1.4	Petrol	59	09/88 → 12/92					

19 II (B/C53_)

1.2	Petrol	40	04/92 → 12/95					
1.4	Petrol	59	01/92 → 12/95					
1.4	Petrol	59	01/92 → 12/95					
1.4 (B/C532)	Petrol	43	04/92 → 12/95					
1.4 (B/C532)	Petrol	43	04/92 → 12/95					
1.4 (B/C535)	Petrol	55	01/92 → 12/95			B3354		B1
1.4 (B/C535)	Petrol	55	01/92 → 12/95					
1.7 (B/C53B)	Petrol	54	04/92 → 12/95					
1.7 (B/C53C)	Petrol	66	04/92 → 12/95			SVF015		B6
1.8 (5/353A)	Petrol	66	04/92 → 12/95					
1.8 (5/353A)	Petrol	66	04/92 → 12/95					
1.8 (5/353F, B/C538)	Petrol	79	05/94 → 12/95					
1.8 (5/353F, B/C538)	Petrol	79	05/94 → 12/95					
1.8 (B/C538)	Petrol	81	04/92 → 05/94					
1.8 (B/C538)	Petrol	81	04/92 → 05/94					
1.8 (B/C53Y)	Petrol	65	04/92 → 12/95					
1.8 (B/C53Y)	Petrol	65	04/92 → 12/95					
1.8 16V (B/C53D)	Petrol	99	04/92 → 12/95					
1.8 16V (B/C53D)	Petrol	99	04/92 → 12/95					



TYPE



TYPE



TYPE

				SPA160	F1		SAD035	H3	PI024	J1
							SAG128	H1		
									SUA351	J3
				ATS14	F2		SAD035	H3	PI024	J1
				SPA160	F1					
				SPA160	F1		SAD035	H3		
							SAG128	H1		
				SPA160	F1					
									SUA351	J3
				ATS14	F2				ESS0130A	J1
									SUA351	J3
				SPA160	F1				ESS0130A	J1
				SPA160	F1		SAD035	H3	PI024	J1
							SAG128	H1		
									PI024	J1
				ATS14	F2		SAD035	H3	PI024	J1
				SPA160	F1					
									SUA351	J3
									SUA351	J3
									SUA351	J3
							SAD035	H3	PI024	J1
							SAG095	H1	SUA351	J3
		APS45		ATS14	F2		SAG095	H1	ESS0130A	J1
									PI024	J1
		APS45		ATS14	F2		SAD035	H3	PI024	J1
				SPA160	F1		SAG095	H1		
		APS45					SAG095	H1	PI024	J1
		APS45					SAG128	H1	PI024	J1
		APS45		SPA160	F1		SAD035	H3	ESS0130A	J1
							SAG128	H1		
		APS45		SPA160	F1		SAD035	H3	PI024	J1
							SAG128	H1		
		APS45		SPA160	F1		SAD035	H3	PI024	J1
							SAG128	H1		
		APS45		SPA160	F1		SAD035	H3	ESS0131A	J1
							SAG128	H1	PI024	J1
		APS45		ATS14	F2		SAD035	H3	PI024	J1
				SPA160	F1		SAG128	H1		



KW



TYPE



TYPE

RENAULT

19 II Cabriolet (D53_, 853_)

1.7 (D53C)	Petrol	66	04/92 → 09/93					
1.7 (D53C)	Petrol	66	04/92 → 09/93					
1.8 (D53V, 853F, D53C)	Petrol	79	07/94 → 06/96					
1.8 (D53V, 853F, D53C)	Petrol	79	07/94 → 06/96					
1.8 (D53Y)	Petrol	65	04/92 → 06/96					
1.8 (D53Y)	Petrol	65	04/92 → 06/96					
1.8 16V (D53D)	Petrol	99	04/92 → 06/96					
1.8 16V (D53D)	Petrol	99	04/92 → 06/96					

19 II Chamade (L53_)

1.4	Petrol	59	10/94 → 11/95					
1.4 (532)	Petrol	43	04/92 → 12/95					
1.4 (532)	Petrol	43	04/92 → 12/95					
1.4 (L535)	Petrol	55	11/93 → 12/95			B3354		B1
1.4 (L535)	Petrol	55	11/93 → 12/95					
1.7 (L53B)	Petrol	54	04/92 → 12/95					
1.7 (L53B)	Petrol	54	04/92 → 12/95					
1.7 (L53C)	Petrol	66	04/92 → 12/95					
1.8	Petrol	67	05/92 → 09/94					
1.8 (453A/F)	Petrol	66	04/92 → 12/95					
1.8 (453A/F)	Petrol	66	04/92 → 12/95					
1.8 (L538)	Petrol	81	04/92 → 05/94					
1.8 (L538)	Petrol	81	04/92 → 05/94					
1.8 (L53V, L538)	Petrol	79	05/94 → 12/95					
1.8 (L53V, L538)	Petrol	79	05/94 → 12/95					
1.8 (L53Y)	Petrol	65	04/92 → 12/95					
1.8 (L53Y)	Petrol	65	04/92 → 12/95					
1.8 16V (L53D)	Petrol	99	04/92 → 12/95					
1.8 16V (L53D)	Petrol	99	04/92 → 12/95					

19 II Furgonato (S53_)

1.2	Petrol	40	03/92 → 12/95					
1.4	Petrol	59	03/92 → 12/95					

21 (B48_)

1.7 (B48E)	Petrol	66	09/89 → 06/94					
1.7 (B48E)	Petrol	66	09/89 → 06/94					
1.7 (B48F)	Petrol	54	09/89 → 10/92					
2.0 (B48C)	Petrol	88	09/89 → 12/93					
2.0 (B48R/Y)	Petrol	99	02/90 → 10/92					
2.0 (B48R/Y)	Petrol	99	02/90 → 10/92					
2.2 (B48K)	Petrol	79	09/89 → 06/94					

21 Station wagon (K48_)

1.7 (K/S481)	Petrol	55	06/86 → 03/93					
1.7 (K48E)	Petrol	66	10/89 → 12/93					
1.7 (K48E)	Petrol	69	06/86 → 12/89					
1.7 (K48E)	Petrol	66	10/89 → 12/93					



TYPE

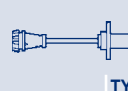

TYPE



TYPE

	APS45		SPA160	F1		SAD035	H3		
						SAG095	H1		
	APS45		SPA160	F1		SAD035	H3		
						SAG128	H1		
	APS45		SPA160	F1		SAD035	H3	ESS0130A	J1
						SAG128	H1		
	APS45		ATS14	F2		SAD035	H3		
			SPA160	F1		SAG128	H1		
								PI024	J1
	APS45		ATS14	F2		SAG095	H1	ESS0131A	J1
								PI024	J1
	APS45		ATS14	F2		SAD035	H3	ESS0131A	J1
			SPA160	F1		SAG095	H1		
	APS45					SAG095	H1	ESS0131A	J1
								PI024	J1
						SAD035	H3	PI024	J1
						SAD035	H3		
	APS45		SPA160	F1		SAD035	H3	ESS0131A	J1
						SAG128	H1	PI024	J1
	APS45		SPA160	F1		SAD035	H3	PI024	J1
						SAG128	H1		
	APS45		SPA160	F1		SAD035	H3	PI024	J1
						SAG128	H1	ESS0131A	J1
	APS45		ATS14	F2		SAD035	H3	PI024	J1
			SPA160	F1		SAG128	H1		
								SUA351	J3
								SUA351	J3
	APS45		SPA160	F1		SAD035	H3	PI024	J1
						SAG095	H1		
	APS45		SPA160	F1		SAG095	H1	PI024	J1
	APS45					SAG095	H1		
	APS45		ATS14	F2		SAD035	H3	PI024	J1
			SPA160	F1		SAG095	H1		
	APS45		SPA160	F1		SAD035	H3	PI024	J1
			SPA160	F1					
	APS45		SPA160	F1		SAD035	H3		
	APS45					SAD035	H3		
						SAG095	H1		



KW



TYPE



TYPE

RENAULT

21 Station wagon (K48_)

1.7 (K48E)	Petrol	69	01/89 → 12/89
1.7 (K48F) Cat.	Petrol	54	05/88 → 06/93
1.7 (K48F) Cat.	Petrol	54	01/89 → 06/93
2.0	Petrol	86	07/89 → 06/92
2.0 (K483)	Petrol	85	06/86 → 12/88
2.0 (K48C)	Petrol	88	03/86 → 12/93
2.0 (K48C)	Petrol	88	03/86 → 12/93
2.0 4x4	Petrol	88	03/89 → 12/93
2.2 (K48K)	Petrol	79	06/86 → 11/93

21 Tre volumi (L48_)

1.7 (L481)	Petrol	55	03/86 → 12/87
1.7 (L482)	Petrol	65	03/86 → 03/93
1.7 (L48E)	Petrol	66	09/89 → 02/94
1.7 (L48E)	Petrol	69	03/86 → 02/94
1.7 (L48E)	Petrol	66	09/89 → 02/94
1.7 (L48E)	Petrol	69	03/86 → 02/94
1.7 (L48E)	Petrol	69	01/89 → 02/94
1.7 (L48M, L48F)	Petrol	54	07/86 → 02/94
1.7 (L48M, L48F)	Petrol	54	01/89 → 02/94
2.0	Petrol	78	05/91 → 10/93
2.0	Petrol	86	04/86 → 06/89
2.0 (L483)	Petrol	85	03/86 → 12/88
2.0 (L48C)	Petrol	88	03/86 → 12/93
2.0 (L48C)	Petrol	88	03/86 → 12/93
2.0 Turbo (L485)	Petrol	129	04/87 → 03/90
2.0 Turbo 4x4	Petrol	129	08/89 → 10/93
2.2 (L48K)	Petrol	79	07/86 → 02/94

25 (B29_)

2.0 (B297)	Petrol	74	04/84 → 12/92
2.0 (B297)	Petrol	74	04/84 → 12/92
2.0 12V	Petrol	103	06/88 → 12/93
2.0 12V	Petrol	103	06/88 → 12/93
2.0 12V (B294)	Petrol	99	06/89 → 12/92
2.0 12V (B294)	Petrol	99	06/89 → 12/92
2.2 (B29B)	Petrol	79	09/86 → 12/92
2.2 (B29B)	Petrol	79	09/86 → 06/88
2.2 (B29B)	Petrol	79	09/86 → 12/92
2.2 (B29E)	Petrol	89	04/84 → 12/89
2.8 V6 Injection (B29F)	Petrol	110	06/87 → 12/92
2.8 V6 Injection (B29F)	Petrol	110	06/87 → 12/92

30 (127_)

2.6 TX (1278)	Petrol	105	10/78 → 12/83
---------------	--------	-----	---------------

4 (112_)

1.1 (1128, S128)	Petrol	25	06/78 → 06/90
------------------	--------	----	---------------



TYPE

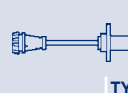

TYPE



TYPE

						SAG128	H1			
	APS45		SPA160	F1		SAG095	H1			
						SAG128	H1			
						SAD035	H3			
	APS45					SAD035	H3			
	APS45					SAD035	H3			
						SAG095	H1			
	APS45					SAG095	H1			
	APS45		SPA160	F1		SAD035	H3			
			SPA160	F1						
			SPA160	F1						
	APS45		SPA160	F1		SAD035	H3			
	APS45		SPA160	F1		SAD035	H3			
						SAG095	H1			
						SAG095	H1			
						SAG128	H1			
	APS45		SPA160	F1		SAG095	H1			
						SAG128	H1			
			SPA160	F1						
						SAD035	H3			
	APS45					SAD035	H3			
	APS45					SAD035	H3			
						SAG095	H1			
			ATS14	F2		SAD035	H3			
			ATS14	F2		SAD035	H3			
	APS45		SPA160	F1		SAD035	H3			
			ATS14	F2						
			SPA160	F1						
			SPA160	F1		SAD035	H3		ESS0144A	J1
									PI024	J1
			SPA160	F1		SAD035	H3		ESS0144A	J1
									PI024	J1
			SPA160	F1		SAD035	H3		ESS0144A	J1
			SPA131	F1						
									PI024	J1
						SAD035	H3		ESS0144A	J1
		RP03A	ATS14	F2		SAD035	H3			
			SPA160	F1						
									ESS0117A	J1
										BK2A



KW

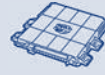

TYPE



TYPE

RENAULT

5 (122_)

1.4 Turbo (8220)	Petrol	118	06/80 → 01/85						
------------------	--------	-----	---------------	--	--	--	--	--	--

9 (L42_)

1.4 Turbo	Petrol	85	12/86 → 12/89						
1.7 (L426)	Petrol	59	09/84 → 12/88						
1.7 (L42F)	Petrol	54	10/86 → 12/88						
1.7 (L42L)	Petrol	55	10/86 → 12/88						

AVANTIME (DE0_)

2.0 16V Turbo (DE0U, DE0V)	Petrol	120	11/01 → 05/03						
2.2 dCi (DE01)	Diesel	110	05/02 → 05/03						
3.0 V6 (DE04, DE0T)	Petrol	152	09/01 → 05/03						

CLIO Grandtour (KR0/1_)

1.2 16V Hi-Flex (KR0S)	BiFuel	55	07/08 →						
1.2 16V Hi-Flex (KR0S)	BiFuel	55	07/08 →	ENGINE: D4F740					
1.2 16V (KR02, KR0J)	Petrol	55	02/08 →						
1.2 16V (KR02, KR0J)	Petrol	55	02/08 →	ENGINE: D4F740					
1.2 16V (KR0E)	Petrol	58	02/08 →						
1.2 16V (KR0E)	Petrol	58	02/08 →	ENGINE: D4F764					
1.2 16V (KR0E)	Petrol	58	02/08 → 09/08						
1.2 16V (KR0P)	Petrol	74	02/08 →						
1.5 dCi	Diesel	48	02/10 →						
1.5 dCi (KR0F)	Diesel	63	02/08 →						
1.5 dCi (KR0F)	Diesel	63	02/08 →	ENGINE: K9K766					
1.5 dCi (KR0F)	Diesel	63	02/08 → 10/08						
1.5 dCi (KR0G)	Diesel	50	02/08 →						
1.5 dCi (KR0G)	Diesel	50	02/08 → 10/08						
1.5 dCi (KR0H)	Diesel	78	02/08 →						
1.5 dCi (KR0H)	Diesel	78	02/08 →	ENGINE: K9K764					
1.5 dCi (KR0H)	Diesel	78	02/08 → 07/08						
1.5 dCi (KR1C, KR1N)	Diesel	76	02/08 →						
1.5 dCi (KR1C, KR1N)	Diesel	76	02/08 → 07/08						
1.5 dCi (KR1C, KR1N)	Diesel	76	02/08 →	ENGINE: K9K772					
1.5 dCi (KR1C, KR1N)	Diesel	76	02/08 →	ENGINE: K9K772					
1.6 16V (KR0B)	Petrol	82	02/08 →						
1.6 16V (KR0B)	Petrol	82	02/08 →	ENGINE: K4M800,K4M801					
1.6 16V (KR10)	Petrol	94	11/08 →						

CLIO I (B/C/S57_, 5/357_)

1.1	Petrol	34	01/91 → 01/93						
1.1	Petrol	34	01/91 → 01/93						
1.2 (5/357Y, 5/357K)	Petrol	40	01/96 → 09/98			B03		B1	
1.2 (5/357Y, 5/357K)	Petrol	40	01/96 → 06/97						
1.2 (5/357Y, 5/357K)	Petrol	40	07/97 → 09/98						
1.2 (B/C/S572)	Petrol	44	05/90 → 03/96	ENGINE: E5F710		18385		B3	
1.2 (B/C/S577)	Petrol	40	01/96 → 12/96			B03		B1	
1.2 (B/C/S577)	Petrol	40	01/96 → 12/96						



TYPE

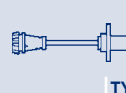

TYPE



TYPE

									ESS0117A	J1
									PI024	J1
									PI024	J1
									ESS0144A	J1
									PI024	J1
	APS28		SPA108	F1		SAD035	H3		GA2132	J2
	APS23		SPA169	F1		SAG153	H1			
	APS62					SAD008	H3	BAE680BD	GA2132	J2
						SAD035	H3	BAE680CU		
						CVS02	H1			
						SAD035	H3	BAE680CU		
						CVS02	H1			
						SAD035	H3	BAE680CU		
						CVS02	H1			
						SAC010	H1			
						SAD035	H3	BAE680CU		
						SAC010	H1			
						SAD035	H3			
						CVS02	H1			
						SAC010	H1			
						SAD035	H3			
						SAC010	H1			
						SAD035	H3			
						CVS02	H1			
						SAC010	H1			
						SAD035	H3			
						SAC010	H1			
									SUA513	J3
									SUA514	J3
						SAD035	H3			
						CVS02	H1			
						SAD035	H3			
									SUA266	J3
									SUA472	J2
FEI0001	APS45					SAD035	H3		SUA266	J3
						SAG158	H1			
						SAG163	H1			
	APS45					SAG095	H1		ESS0090A	J1
									SUA266	J3



KW

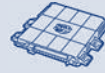

TYPE



TYPE

RENAULT

CLIO I (B/C57_, 5/357_)

1.2 (B/C/S57A, B/C57S, 5/357F, 5/357J, 5/357L, 5/357R)	Petrol	43	05/90 → 09/98	ENGINE: D7F			B23/00	B1
1.2 (B/C/S57A, B/C57S, 5/357F, 5/357J, 5/357L, 5/357R)	Petrol	43	05/90 → 09/98					
1.2 (B/C/S57A, B/C57S, 5/357F, 5/357J, 5/357L, 5/357R)	Petrol	43	05/90 → 09/98					
1.2 (B/C/S57A, B/C57S, 5/357F, 5/357J, 5/357L, 5/357R)	Petrol	43	05/90 → 03/97					
1.2 (B/C/S57A, B/C57S, 5/357F, 5/357J, 5/357L, 5/357R)	Petrol	43	04/97 → 09/98					
1.2 (B/C/S57A, B/C57S, 5/357F, 5/357J, 5/357L, 5/357R)	Petrol	43	05/90 → 01/93					
1.2 (B/C57R)	Petrol	40	01/91 → 06/96	ENGINE: E7F706			18385	B3
1.2 (B/C57R)	Petrol	40	01/91 → 06/96				KITPF2C	B6
1.2 (B/C57R)	Petrol	40	01/91 → 01/96				B03	B1
1.2 (B/C57R)	Petrol	40	01/91 → 06/96					
1.2 (B/C57R)	Petrol	40	01/91 → 01/96	ENGINE: C3G700				
1.2 (B/C57R)	Petrol	40	01/91 → 01/93					
1.4	Petrol	59	01/91 → 09/98					
1.4	Petrol	59	01/91 → 09/98					
1.4	Petrol	59	01/91 → 12/97					
1.4	Petrol	59	01/91 → 01/93					
1.4	Petrol	59	01/91 → 01/93					
1.4 (B/C57T, B/C57Y)	Petrol	58	01/91 → 09/98				B3354	B1
1.4 (B/C57T, B/C57Y)	Petrol	58	01/91 → 09/98					
1.4 (B57J, C57J)	Petrol	55	01/91 → 09/98					
1.4 (B57J, C57J)	Petrol	55	01/91 → 03/97					
1.4 (B57J, C57J)	Petrol	55	04/97 → 09/98					
1.4 (B57J, C57J)	Petrol	55	01/91 → 01/93					
1.4 (B57J, C57J)	Petrol	55	01/91 → 01/93					
1.8 (B/C578)	Petrol	66	08/94 → 09/98					
1.8 (B/C578)	Petrol	66	08/94 → 09/98					
1.8 (B/C57C, B/C57U)	Petrol	65	01/91 → 09/98					
1.8 16V (C57D)	Petrol	99	01/91 → 03/96					
1.8 16V (C57D)	Petrol	99	01/91 → 03/96					
1.8 16V (C57D)	Petrol	99	07/91 → 06/94					
1.8 Rsi (B/C579)	Petrol	80	01/93 → 08/95					
1.8 Rsi (B/C579)	Petrol	80	01/93 → 08/95					
1.8 Rsi (B/C57H)	Petrol	79	08/95 → 09/98					
1.9 D (B/C/S576, B/C/S57L)	Diesel	47	01/91 → 02/98					
Williams (B/C57M)	Petrol	108	01/94 → 09/98					
Williams (B/C57M)	Petrol	108	01/94 → 09/98					
Williams (B/C57M)	Petrol	108	01/94 → 12/96					



TYPE



TYPE



TYPE

	APS45		ATS14	F2		SAD035	H3		ESS0090A	J1
			SPA160	F1						
						SAG158	H1			
						SAG163	H1			
									SUA266	J3
	APS45		KITATS05	F2		SAD035	H3		ESS0090A	J1
			SPA160	F1		SAG163	H1			
								BAE504L		
									SUA472	J2
			ATS14	F2		SAD035	H3		ESS0130A	J1
			SPA160	F1						
						SAG158	H1			
									SUA266	J3
									SUA472	J2
	APS45		ATS14	F2		SAG128	H1		ESS0090A	J1
			SPA160	F1						
	APS45								ESS0090A	J1
						SAG158	H1			
						SAG163	H1			
									SUA266	J3
									SUA472	J2
	APS45		SPA160	F1		SAD035	H3			
						SAG128	H1			
	APS45		SPA160	F1		SAD035	H3		ESS0090A	J1
	APS45		ATS14	F2		SAD035	H3			
			SPA160	F1		SAG158	H1			
									SUA266	J3
	APS45		SPA160	F1		SAD035	H3			
						SAG128	H1			
	APS45		SPA160	F1		SAD035	H3			
									SUA265	J3
	APS45		ATS14	F2		SAD035	H3			
			SPA160	F1						
						SAG158	H1			



KW

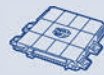

TYPE



TYPE

RENAULT

CLIO I Furgonato (S57_)

1.2	Petrol	40	01/91 → 09/98					B03	B1
1.2	Petrol	44	01/91 → 09/98	ENGINE: D7F				B23/00	B1
1.2	Petrol	40	01/91 → 09/98						
1.2	Petrol	44	01/91 → 09/98						
1.2	Petrol	44	01/91 → 09/98						
1.9 D	Diesel	48	01/91 → 02/98						

CLIO II (BB0/1/2_, CB0/1/2_)

1.2	Petrol	55	06/01 → 10/03						
1.2 (BB0A, BB0F, BB10, BB1K, BB28, BB2D, BB2H, CB0A...)	Petrol	43	09/98 →	ENGINE: D7F720,D7F726, D7F746,D7F766,D7F764				18385	B3
1.2 (BB0A, BB0F, BB10, BB1K, BB28, BB2D, BB2H, CB0A...)	Petrol	43	09/98 →	ENGINE: D7F				B23/00	B1
1.2 (BB0A, BB0F, BB10, BB1K, BB28, BB2D, BB2H, CB0A...)	Petrol	43	12/03 → 05/04	ENGINE: D7F720,D7F746, D7F726,D7F766,D7F764				36SXR31	B3
1.2 (BB0A, BB0F, BB10, BB1K, BB28, BB2D, BB2H, CB0A...)	Petrol	43	09/98 →						
1.2 (BB0A, BB0F, BB10, BB1K, BB28, BB2D, BB2H, CB0A...)	Petrol	43	09/98 → 09/99						
1.2 (BB0A, BB0F, BB10, BB1K, BB28, BB2D, BB2H, CB0A...)	Petrol	43	10/99 → 03/02						
1.2 (BB0A, BB0F, BB10, BB1K, BB28, BB2D, BB2H, CB0A...)	Petrol	43	09/98 →						
1.2 (BB0A, CB0A)	Petrol	44	03/99 → 05/01	ENGINE: D7F722				18385	B3
1.2 (BB0A, CB0A)	Petrol	44	03/99 → 05/01						
1.2 16V	Petrol	54	06/06 →	ENGINE: D4F706,D4F712				SMR00102Y	B3
1.2 16V (BB05, BB0W, BB11, BB27, BB2T, BB2U, BB2V, CB05...)	Petrol	55	06/01 →	ENGINE: D4F706,D4F712, D4F714,D4F722,D4F728				SMR00102Y	B3
1.2 16V (BB05, BB0W, BB11, BB27, BB2T, BB2U, BB2V, CB05...)	Petrol	55	06/01 →	ENGINE: D4F712,D4F714, D4F722,D4F706,D4F728					
1.2 16V (BB05, BB0W, BB11, BB27, BB2T, BB2U, BB2V, CB05...)	Petrol	55	06/01 →						
1.2 16V (BB05, BB0W, BB11, BB27, BB2T, BB2U, BB2V, CB05...)	Petrol	55	06/01 →						
1.4 (B/CB0C)	Petrol	55	09/98 → 05/05					B3395	B1
1.4 (B/CB0C)	Petrol	55	09/98 → 05/05						
1.4 (B/CB0C)	Petrol	55	09/98 → 05/05	ENGINE: I(E7J)					
1.4 (B/CB0C)	Petrol	55	09/98 → 05/05	ENGINE: K4J					
1.4 (B/CB0C)	Petrol	55	01/01 → 05/05	ENGINE: E7J					
1.4 16V (B/CB0L)	Petrol	70	10/99 → 08/00						
1.4 16V (B/CB0L)	Petrol	70	10/99 → 09/04						

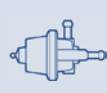

TYPE

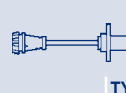

TYPE



TYPE

	APS45		KITATS05	F2		SAG163	H1		ESS0090A	J1
			SPA160	F1						
	APS45		KITATS05	F2					ESS0090A	J1
			SPA160	F1						
									SUA265	J3
IWP099									GA2227	J2
FEI0001			SPA108	F1		SAD035	H3	BAE680Z	GA2227	J2
	APS45									
	APS44									
						SAG163	H1			
FEI0001			SPA108	F1		SAD035	H3		GA2227	J2
IWP099										
			SPA108	F1		SAD035	H3		GA2009	J2
						SAG163	H1			
	APS45		SPA108	F1		SAD035	H3	BAE680E	GA2227	J2
						SAG129	H1	BAE680Z		
									SUA393	J2
									GA2008	J2
									GA2010	J2
IWP142								BAE680E		
			SPA108	F1		SAD035	H3		GA2227	J2



KW



TYPE



TYPE

RENAULT

CLIO II (BB0/1/2_, CB0/1/2_)

1.4 16V (B/CB0L)	Petrol	70	10/99 → 09/04					
1.4 16V (B/CB0P)	Petrol	72	08/00 → 10/07					
1.4 16V (B/CB0P)	Petrol	72	08/00 →					
1.4 16V (B/CB0P)	Petrol	72	08/00 →					
1.4 16V (B/CB0P)	Petrol	72	08/00 → 05/05					
1.5 dCi	Diesel	74	01/04 →					
1.5 dCi	Diesel	74	01/04 → 01/05					
1.5 dCi	Diesel	74	04/07 →	ENGINE: K9K712				
1.5 dCi	Diesel	74	04/07 →	ENGINE: K9K712				
1.5 dCi (B/C2J)	Diesel	50	08/04 →					
1.5 dCi (B/C2J)	Diesel	50	08/04 → 01/05					
1.5 dCi (B/C2J)	Diesel	50	04/07 →	ENGINE: K9K714				
1.5 dCi (B/C2J)	Diesel	50	04/07 →	ENGINE: K9K714				
1.5 dCi (B/CB03)	Diesel	59	06/01 → 10/03					
1.5 dCi (B/CB03)	Diesel	59	06/01 → 10/03					
1.5 dCi (B/CB07)	Diesel	48	06/01 →					
1.5 dCi (B/CB07)	Diesel	48	06/01 → 10/02					
1.5 dCi (B/CB07)	Diesel	48	06/01 →					
1.5 dCi (B/CB07)	Diesel	48	06/01 → 01/05					
1.5 dCi (B/CB07)	Diesel	48	06/01 →					
1.5 dCi (B/CB07)	Diesel	48	04/07 →	ENGINE: K9K700,K9K704				
1.5 dCi (B/CB07)	Diesel	48	04/07 →	ENGINE: K9K700,K9K704				
1.5 dCi (B/CB08)	Diesel	60	06/01 →					
1.5 dCi (B/CB08)	Diesel	60	06/01 → 10/02					
1.5 dCi (B/CB08)	Diesel	60	06/01 →					
1.5 dCi (B/CB08)	Diesel	60	06/01 → 01/05					
1.5 dCi (B/CB08)	Diesel	60	06/01 →					
1.5 dCi (B/CB08)	Diesel	60	04/07 →	ENGINE: K9K702				
1.5 dCi (B/CB08)	Diesel	60	04/07 →	ENGINE: K9K702				
1.5 dCi (B/CB3M)	Diesel	47	06/05 →					
1.5 dCi (B/CB3M)	Diesel	47	04/07 →	ENGINE: K9K740				
1.5 dCi (B/CB3M)	Diesel	47	04/07 →	ENGINE: K9K740				
1.5 dCi (B/CB3N)	Diesel	62	02/07 →					
1.5 dCi (B/CB3N)	Diesel	62	02/07 → 06/09					
1.5 dCi (B/CB3N)	Diesel	62	04/07 →	ENGINE: K9K718				
1.5 dCi (B/CB3N)	Diesel	62	04/07 →	ENGINE: K9K718				
1.6 (B/CB0D)	Petrol	66	09/98 → 05/05			B3355		B1
1.6 (B/CB0D)	Petrol	66	09/98 → 05/05					
1.6 (B/CB0D)	Petrol	66	09/98 → 01/02					
1.6 (B/CB0D)	Petrol	66	09/98 → 12/00					
1.6 (B/CB0D)	Petrol	66	01/01 → 05/05					
1.6 (B/CB0D)	Petrol	66	09/99 → 05/05					
1.6 (B/CB0D)	Petrol	66	09/98 → 05/05	ENGINE: I(K7M)				
1.6 (B/CB0D)	Petrol	66	09/98 → 05/05	ENGINE: K7M				



TYPE

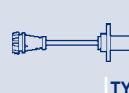

TYPE



TYPE

						SAG027	H1			
IWP142						SAG159	H1			
			SPA108	F1		SAD035	H3		GA2009	J2
						SAG143	H1			
								BAE680E		
	APS51		SPA169	F1		SAC010	H1			
			SPA108	F1						
									SUA513	J3
									SUA514	J3
	APS37					SAC010	H1			
			SPA108	F1						
									SUA513	J3
									SUA514	J3
	APS37					SAC010	H1			
						SAD035	H3			
	APS37		SPA169	F1		SAC010	H1		SUA411	J3
	APS34									
						SAD035	H3			
			SPA108	F1						
						SAG161	H1			
									SUA513	J3
									SUA514	J3
	APS37		SPA169	F1		SAC010	H1		SUA411	J3
	APS34									
						SAD035	H3			
			SPA108	F1						
						SAG161	H1			
									SUA513	J3
									SUA514	J3
						SAC010	H1			
									SUA513	J3
									SUA514	J3
	APS37									
						SAC010	H1			
									SUA513	J3
									SUA514	J3
	APS45					SAD035	H3	BAE680E	GA2227	J2
						SAG028	H1			
			SPA108	F1						
						SAG129	H1			
						SAG143	H1			
						SAG027	H1			
									SUA393	J2
									GA2008	J2

KW

TYPE

TYPE
RENAULT
CLIO II (BB0/1/2_, CB0/1/2_)

1.6 16V	Petrol	82	10/01 → 12/08				
1.6 16V (BB01, BB0H, BB0T, BB14, BB1D, BB1R, BB2KL...)	Petrol	79	09/98 → 10/07				
1.6 16V (BB01, BB0H, BB0T, BB14, BB1D, BB1R, BB2KL...)	Petrol	79	09/98 →				
1.6 16V (BB01, BB0H, BB0T, BB14, BB1D, BB1R, BB2KL...)	Petrol	79	09/98 →				
1.6 16V (BB01, BB0H, BB0T, BB14, BB1D, BB1R, BB2KL...)	Petrol	79	09/98 → 05/05				
1.6 16V (BB01, BB0H, BB0T, BB14, BB1D, BB1R, BB2KL...)	Petrol	79	01/01 →	ENGINE: K7M			
1.6 Hi-Flex (CB0H)	BiFuel	86	01/05 → 02/10				
1.9 D (B/CB0E)	Diesel	47	09/98 → 05/05				
1.9 D (B/CB0J)	Diesel	48	02/00 → 05/01				
1.9 dTi (B/CB0U)	Diesel	59	12/99 → 05/05				
1.9 dTi (B/CB0U)	Diesel	59	12/99 → 01/05				
1.9 dTi (B/CB0U)	Diesel	59	01/01 → 05/05				
2.0 16V Sport	Petrol	132	01/04 → 05/05				
2.0 16V Sport	Petrol	132	01/04 →				
2.0 16V Sport (CB0M)	Petrol	124	02/00 → 05/05				
2.0 16V Sport (CB0M)	Petrol	124	02/00 →				
2.0 16V Sport (CB0M)	Petrol	124	02/00 →				
2.0 16V Sport (CB0M)	Petrol	124	02/00 →	ENGINE: F4R			
3.0 V6 Sport (CB1A)	Petrol	166	11/00 → 12/02				
3.0 V6 Sport (CB1H, CB1U, CB2S)	Petrol	187	12/02 →				

CLIO II Furgonato (SB0/1/2_)

1.1 (SB0A, SB0F, SB1K, SB2D)	Petrol	43	09/98 →	ENGINE: D7F		B23/00	B1
1.1 (SB0A, SB0F, SB1K, SB2D)	Petrol	43	09/98 →				
1.1 (SB0A, SB0F, SB1K, SB2D)	Petrol	43	09/98 → 09/99				
1.1 (SB0A, SB0F, SB1K, SB2D)	Petrol	43	10/99 → 03/02				
1.1 (SB0A, SB0F, SB1K, SB2D)	Petrol	43	09/98 →				
1.1 (SB0A, SB0F, SB1K, SB2D)	Petrol	43	09/98 →	ENGINE: I(D7F)			
1.2 (SB0A, SB0F, SB10)	Petrol	44	03/99 → 10/03	ENGINE: D7F722,D7F726,D7F746		18385	B3
1.2 (SB0A, SB0F, SB10)	Petrol	44	03/99 → 10/03				
1.5 dCi	Diesel	59	06/01 → 10/04				
1.5 dCi	Diesel	60	11/03 →				
1.5 dCi	Diesel	59	06/01 → 10/04				
1.5 dCi	Diesel	60	11/03 → 01/05				
1.5 dCi	Diesel	60	11/03 →				
1.5 dCi	Diesel	60	04/07 →	ENGINE: K9K702,K9K710,K9K716			

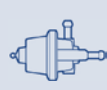

TYPE

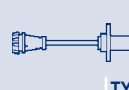

TYPE



TYPE

IWP143										
IWP142										
			SPA108	F1		SAD035	H3		GA2009	J2
						SAG159	H1			
								BAE680E		
									GA2010	J2
			SPA108	F1						
						SAG159	H1		SUA394	J3
			SPA108	F1		SAG160	H1			
			SPA169	F1		SAG161	H1			
			SPA108	F1						
									SUA412	J3
IWP042										
			SPA108	F1		SAG160	H1			
IWP042								BAE680E		
			SPA108	F1		SAD035	H3		GA2009	J2
						SAG140	H1			
									GA2010	J2
	APS62		SPA167	F1		SAD008	H3	BAE680BD		
	APS62					SAD008	H3	BAE680BD		
									GA2010	J2
									GA2227	J2
FEI0001			SPA108	F1		SAD035	H3		GA2227	J2
	APS45									
	APS44									
						SAG163	H1			
									SUA393	J2
FEI0001			SPA108	F1		SAD035	H3		GA2227	J2
	APS37		SPA108	F1		SAC010	H1			
	APS37					SAC010	H1			
						SAD035	H3			
			SPA108	F1						
						SAD035	H3			
									SUA513	J3



KW

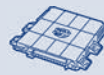

TYPE



TYPE

RENAULT

CLIO II Furgonato (SB0/1/2_)

1.5 dCi	Diesel	60	04/07 →	ENGINE: K9K702,K9K710,K9K716				
1.5 dCi (SB07)	Diesel	48	06/01 →					
1.5 dCi (SB07)	Diesel	48	06/01 → 10/02					
1.5 dCi (SB07)	Diesel	48	06/01 →					
1.5 dCi (SB07)	Diesel	48	06/01 → 01/05					
1.5 dCi (SB07)	Diesel	48	06/01 →					
1.5 dCi (SB07)	Diesel	48	04/07 →	ENGINE: K9K700,K9K704				
1.5 dCi (SB07)	Diesel	48	04/07 →	ENGINE: K9K700,K9K704				
1.9 D (SB0E)	Diesel	47	09/98 →					
1.9 D (SB0J)	Diesel	48	02/00 → 05/01					
1.9 DTi (SB0U)	Diesel	59	02/00 → 05/01					

CLIO III (BR0/1, CR0/1)

1.2	Petrol	43	08/06 →					
1.2 16V	Petrol	58	06/05 →					
1.2 16V	Petrol	58	06/05 →					
1.2 16V	Petrol	58	10/05 → 09/08					
1.2 16V	Petrol	58	06/05 →	ENGINE: D4F				
1.2 16V Hi-Flex (BR1U, CR1U)	BiFuel	55	07/08 →					
1.2 16V Hi-Flex (BR1U, CR1U)	BiFuel	55	07/08 →	ENGINE: D4F740,D4F742				
1.2 16V (BR02, BR0J, BR11, CR02, CR0J, CR11)	Petrol	55	06/05 →					
1.2 16V (BR02, BR0J, BR11, CR02, CR0J, CR11)	Petrol	55	06/05 → 06/07					
1.2 16V (BR02, BR0J, BR11, CR02, CR0J, CR11)	Petrol	55	06/05 →					
1.2 16V (BR02, BR0J, BR11, CR02, CR0J, CR11)	Petrol	55	06/05 →	ENGINE: D4F				
1.2 16V (BR0P, CR0P)	Petrol	74	05/07 →					
1.2 16V (BR0P, CR0P)	Petrol	74	05/07 → 06/07					
1.2 16V (BR0R, BR1D, BR1L, CR0R)	Petrol	48	09/06 → 06/09	ENGINE: D4F740		36SXR31		B3
1.2 16V (BR0R, BR1D, BR1L, CR0R)	Petrol	48	06/05 →					
1.2 16V (BR0R, BR1D, BR1L, CR0R)	Petrol	48	06/05 → 06/07					
1.2 16V (BR0R, BR1D, BR1L, CR0R)	Petrol	48	06/05 →	ENGINE: D4F740				
1.2 16V (BR0R, BR1D, BR1L, CR0R)	Petrol	48	06/05 →	ENGINE: D4F				
1.4 16V	Petrol	72	06/05 →					
1.4 16V	Petrol	72	06/05 →	ENGINE: K4J				
1.5 dCi	Diesel	48	05/05 →					
1.5 dCi	Diesel	47	06/05 →					

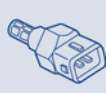
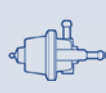

TYPE

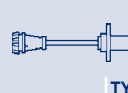

TYPE



TYPE

									SUA514	J3
	APS37		SPA169	F1		SAC010	H1			
	APS34									
						SAD035	H3			
			SPA108	F1						
						SAG161	H1			
									SUA513	J3
									SUA514	J3
						SAG159	H1		SUA394	J3
			SPA108	F1		SAG160	H1			
			SPA108	F1						
									GA2039	J2
			SPA108	F1		SAD035	H3	BAE680CU	GA2039	J2
						SAG163	H1			
						SAC010	H1			
									GA2031	J2
						SAD035	H3	BAE680CU		
						CVS02	H1			
			SPA147	F1		SAD035	H3	BAE680CU	GA2039	J2
			SPA108	F1						
						SAG163	H1			
									GA2031	J2
			SPA147	F1		SAD035	H3	BAE680CU	GA2039	J2
			SPA108	F1						
			SPA147	F1		SAD035	H3	BAE680CU	GA2039	J2
			SPA108	F1						
						CVS02	H1			
									GA2031	J2
								BAE680E	GA2039	J2
									GA2031	J2
	APS37					SAC010	H1			
						SAC010	H1			



KW

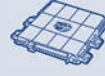

TYPE



TYPE

RENAULT

CLIO III (BR0/1, CR0/1)

1.5 dCi	Diesel	48	05/05 →						
1.5 dCi	Diesel	48	05/05 →	ENGINE: K9K752					
1.5 dCi	Diesel	60	11/07 →						
1.5 dCi (BR0H, CR0H)	Diesel	78	06/05 →						
1.5 dCi (BR0H, CR0H)	Diesel	78	06/05 →	ENGINE: K9K764					
1.5 dCi (BR0H, CR0H)	Diesel	78	06/05 → 07/08						
1.5 dCi (BR0H, CR0H)	Diesel	78	06/05 →	ENGINE: DCI					
1.5 dCi (BR17, CR17)	Diesel	63	06/05 →						
1.5 dCi (BR17, CR17)	Diesel	63	06/05 →	ENGINE: K9K766					
1.5 dCi (BR17, CR17)	Diesel	63	06/05 → 10/08						
1.5 dCi (BR17, CR17)	Diesel	63	06/05 →	ENGINE: DCI					
1.5 dCi (BR1C, CR1C)	Diesel	76	06/05 →						
1.5 dCi (C/BR1G)	Diesel	50	06/05 →						
1.5 dCi (C/BR1G)	Diesel	50	06/05 → 10/08						
1.6 16V (BR05, BR0B, BR0Y, BR15, BR1J, BR1M, BR1Y, CR0B...)	Petrol	82	06/05 →						
1.6 16V (BR05, BR0B, BR0Y, BR15, BR1J, BR1M, BR1Y, CR0B...)	Petrol	82	06/05 →	ENGINE: K4M800,K4M801					
1.6 16V (BR05, BR0B, BR0Y, BR15, BR1J, BR1M, BR1Y, CR0B...)	Petrol	82	06/05 →	ENGINE: K4M					
1.6 16V (BR09, BR0T, CR09, CR0T)	Petrol	65	06/05 →						
1.6 16V (BR09, BR0T, CR09, CR0T)	Petrol	65	06/05 →	ENGINE: K4M					
1.6 16V GT (BR10, CR10)	Petrol	94	06/09 →						
1.6 Hi-Flex	BiFuel	86	05/05 → 02/10						
2.0 16V (BR0C, BR0K, CR0C, CR0K)	Petrol	102	09/06 →						
2.0 16V Sport	Petrol	145	02/06 →						
2.0 16V Sport	Petrol	145	02/06 →						
2.0 16V Sport	Petrol	145	02/06 →	ENGINE: F4R830					
2.0 16V Sport	Petrol	148	09/08 →						
2.0 16V Sport	Petrol	148	09/08 →						
2.0 16V Sport	Petrol	148	09/08 →	ENGINE: F4R830					

ESPACE I (J11_)

2.2 (J117)	Petrol	79	07/86 → 12/90						
2.2 Quadra (J117)	Petrol	79	01/88 → 12/90						

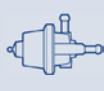

TYPE

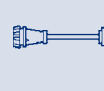

TYPE



TYPE

						SAD035	H3			
						CVS02	H1			
						SAC010	H1			
				SPA169	F1	SAD035	H3			
						CVS02	H1			
						SAC010	H1			
									SUA518	J3
				SPA169	F1	SAD035	H3			
						CVS02	H1			
						SAC010	H1			
									SUA518	J3
						SAC010	H1			
				SPA169	F1	SAD035	H3			
						SAC010	H1			
						SAD035	H3	BAE680E	GA2039	J2
						CVS02	H1			
									GA2031	J2
						SAD035	H3	BAE680E	GA2039	J2
									GA2031	J2
						SAD035	H3			
				SPA108	F1					
						SAD029	H3		GA2039	J2
						SAC010	H1		GA2039	J2
						SAD035	H3			
						CVS02	H1			
						SAC010	H1			
						SAD035	H3			
						CVS02	H1			
						SAD035	H3		PI024	J1
						SAD035	H3			



KW



TYPE



TYPE

RENAULT

ESPACE II (J/S63_)

2.0 (J636)	Petrol	76	01/91 → 10/96	ENGINE: (ES9J4-XU10J4RS)				CA0005504	B6
2.0 (J636)	Petrol	76	01/91 → 10/96						
2.0 (J636)	Petrol	76	01/91 → 10/96						
2.0 (J636)	Petrol	76	05/92 → 01/93	ENGINE: F3R728,729,742,768,769					
2.2 (J/S637, J63G)	Petrol	79	01/91 → 10/96						
2.2 (J/S637, J63G)	Petrol	79	01/91 → 10/96						
2.8 V6 (J638, J63J)	Petrol	110	01/91 → 10/96						
2.8 V6 (J638, J63J)	Petrol	110	01/91 → 09/96						
2.8 V6 (J638, J63J)	Petrol	110	01/91 → 10/96						

ESPACE III (JE0_)

1.9 dTi (JE0M)	Diesel	72	02/99 → 10/02						
2.0	Petrol	102	09/01 → 10/02						
2.0	Petrol	102	09/01 → 10/02						
2.0 16V (JE0N, JE0L, JE02)	Petrol	103	10/98 → 10/02						
2.0 16V (JE0N, JE0L, JE02)	Petrol	103	10/98 → 10/02						
2.2 12V TD (JE0E, JE0H, JE0P)	Diesel	83	01/97 → 10/00						
2.2 dCi (JE0K)	Diesel	95	10/00 → 10/02						
2.2 dCi (JE0S)	Diesel	85	07/00 → 10/02						
3.0 V6 24V (JE0G, JE0R)	Petrol	140	10/98 → 12/98						
3.0 V6 24V (JE0G, JE0R)	Petrol	140	10/98 → 10/02						

ESPACE IV (JK0/1_)

1.9 dCi (JK0U)	Diesel	85	04/03 → 02/05						
1.9 dCi (JK0U, JK0G)	Diesel	88	11/02 →						
1.9 dCi (JK0U, JK0G)	Diesel	88	04/03 → 01/05						
2.0 (JK09)	Petrol	100	11/02 →						
2.0 (JK0K)	Petrol	98	11/02 → 02/05						
2.0 (JK0N, JK1D)	Petrol	125	04/05 →						
2.0 dCi (JK01, JK02, JK1J, JK1K)	Diesel	110	01/06 →						
2.0 dCi (JK03, JK04)	Diesel	127	01/06 →						
2.0 Turbo (JK0B, JK0N)	Petrol	120	11/02 →	ENGINE: F4R-794, 795, 796, 797					
2.0 Turbo (JK0B, JK0N)	Petrol	120	11/02 →						
2.2 dCi (JK07)	Diesel	102	02/06 →						
2.2 dCi (JK0H)	Diesel	110	11/02 →						
2.2 dCi (JK0H)	Diesel	110	11/02 → 01/05						
3.0 dCi (JK0J, JK0V)	Diesel	130	11/02 →						
3.5 V6 (JK00, JK0F, JK0P, JK0S, JK0W)	Petrol	177	11/02 →						

FLUENCE (L30_)

1.5 dCi (L30A)	Diesel	63	02/10 →						
1.5 dCi (L30B)	Diesel	78	02/10 →						
1.5 dCi (L30D, L30L)	Diesel	81	02/10 →						
1.5 dCi (L30S)	Diesel	66	02/10 →						



TYPE

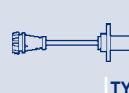

TYPE



TYPE

		APS45		SPA160	F1		SAD035	H3		
							SAG158	H1		
									BAE801AK	
		APS45		SPA160	F1		SAD035	H3		
							SAG158	H1		
		APS45		SPA160	F1		SAD035	H3		
			RP03A							
							SAG158	H1		
				SPA169	F1		SAG140	H1		
				SPA108	F1		SAD035	H3	BAE680E	GA2132
							SAG140	H1		
IWP042				SPA108	F1		SAD035	H3	BAE680E	GA2132
							SAG140	H1		
									SUA398	J3
		APS23		SPA169	F1		SAG140	H1	ESS535	J1
							SAG140	H1		
		APS76								
				SPA120	F1	SAA118	SAG150	H1		GA2132
				SPA108	F1					
				SPA169	F1					
				SPA108	F1					
				SPA108	F1		SAD035	H3	BAE680E	
				SPA108	F1		SAD035	H3		
				SPA108	F1		SAD035	H3	BAE680E	
							SAC077	H2		
							SAC077	H2		
IWP098										
		APS28		SPA108	F1		SAD035	H3	BAE680E	
							SAG153	H1		
		APS23		SPA169	F1		SAG153	H1		
				SPA108	F1					
				SPA115	F1					
				SGA116	F3					
									SUA585	J3
									SUA585	J3
									SUA585	J3
							SAD035	H3	SUA585	J3



KW



TYPE



TYPE

RENAULT

FLUENCE (L30_)

1.6 16V (L301, L30F, L30P, L30R) Petrol 81 02/10 →

2.0 16V (L30C, L30G, L30T, L30V) Petrol 103 02/10 →

FUEGO (136_)

1.6 Turbo (1365) Petrol 97 08/83 → 10/85

GRAND SCÉNIC II (JM0/1_)

1.5 dCi (JM02, JM13) Diesel 74 04/04 →

1.5 dCi (JM02, JM13) Diesel 74 04/04 →

1.5 dCi (JM02, JM13) Diesel 74 04/04 → 01/05

1.5 dCi (JM1E) Diesel 78 05/05 →

1.6 Petrol 83 04/04 → 01/05

1.6 Petrol 83 04/04 →

1.6 Petrol 83 04/04 →

1.6 Petrol 83 04/04 →

1.6 Petrol 83 04/04 → 04/09

1.9 dCi (JM0G, JM12, JM1G, JM2C) Diesel 88 04/04 → 01/05

1.9 dCi (JM14) Diesel 96 05/05 →

2.0 Petrol 120 04/04 →

2.0 Petrol 120 11/07 →

2.0 Petrol 99 04/04 →

2.0 Petrol 99 11/07 →

2.0 dCi (JM1K) Diesel 110 09/05 →

GRAND SCÉNIC III (JZ0/1_)

1.4 16V (JZ0F) Petrol 96 02/09 →

1.5 dCi Diesel 78 02/09 →

1.6 16V (JZ0U) Petrol 81 02/09 → ENGINE: K4M9766,K4M858

1.6 16V (JZ0U) Petrol 81 02/09 →

2.0 16V (JZ0G) Petrol 103 05/09 →

2.0 16V (JZ0G) Petrol 103 02/09 →

2.0 dCi (JZ0L) Diesel 118 04/09 →

2.0 dCi (JZ0Y) Diesel 110 02/09 →

KANGOO (KC0/1_)

1.2 (KC0A, KC0K, KC0F, KC01) Petrol 43 07/03 → 06/04 ENGINE: D7F710,D7F720, D7F722,D7F726,D7F744, D7F746 **36SXR31** B3

1.2 (KC0A, KC0K, KC0F, KC01) Petrol 43 02/98 → **B23/00** B1

1.2 (KC0A, KC0K, KC0F, KC01) Petrol 43 08/97 →

1.2 (KC0A, KC0K, KC0F, KC01) Petrol 43 08/97 → 09/99

1.2 (KC0A, KC0K, KC0F, KC01) Petrol 43 10/99 → 03/02

1.2 (KC0A, KC0K, KC0F, KC01) Petrol 43 08/97 →

1.2 16V (KC03, KC05, KC06, KC0T, KC0W) Petrol 55 06/01 → ENGINE: D4F712,D4F714,D4F716 **SMR00102Y** B3



KW



TYPE



TYPE

RENAULT

KANGOO (KC0/1_)

1.2 16V (KC03, KC05, KC06, KC0T, KC0W)	Petrol	55	06/01 →					
1.2 16V (KC03, KC05, KC06, KC0T, KC0W)	Petrol	55	06/01 →					
1.4 (KC0C, KC0H, KC0B, KC0M)	Petrol	55	08/97 →				B3395	B1
1.4 (KC0C, KC0H, KC0B, KC0M)	Petrol	55	08/97 →					
1.4 (KC0C, KC0H, KC0B, KC0M)	Petrol	55	09/99 →					
1.5 dCi	Diesel	42	07/03 →					
1.5 dCi	Diesel	50	06/05 →					
1.5 dCi	Diesel	62	06/05 →					
1.5 dCi	Diesel	42	07/03 →					
1.5 dCi	Diesel	50	06/08 → 10/09					
1.5 dCi	Diesel	62	06/05 → 06/08					
1.5 dCi (KC07)	Diesel	48	12/01 →					
1.5 dCi (KC07)	Diesel	48	12/01 → 10/02					
1.5 dCi (KC07)	Diesel	48	12/01 →					
1.5 dCi (KC07)	Diesel	48	12/01 →					
1.5 dCi (KC08, KC09)	Diesel	60	07/02 →					
1.5 dCi (KC08, KC09)	Diesel	60	07/02 → 10/02					
1.5 dCi (KC08, KC09)	Diesel	60	07/02 →					
1.5 dCi (KC08, KC09)	Diesel	60	07/02 → 01/05					
1.5 dCi (KC08, KC09)	Diesel	60	07/03 →					
1.6	Petrol	66	09/99 → 06/01					
1.6 16V	Petrol	70	06/01 →					
1.6 16V	Petrol	70	06/01 →					
1.6 16V	Petrol	70	06/01 → 12/07					
1.6 16V 4x4 (KC0P, KC0S, KC0L)	Petrol	70	10/01 →					
1.6 16V 4x4 (KC0P, KC0S, KC0L)	Petrol	70	10/01 →					
1.6 16V 4x4 (KC0P, KC0S, KC0L)	Petrol	70	10/01 → 12/07					
1.9 dCi 4x4	Diesel	62	10/03 → 01/05					
1.9 dCi 4x4	Diesel	62	10/03 →					
1.9 dCi 4x4 (KC0V)	Diesel	59	10/01 →					
1.9 dTi (KC0U)	Diesel	59	02/00 →					
1.9 dTi (KC0U)	Diesel	59	05/00 →					
D 55 1.9 (KC0D)	Diesel	40	08/97 →					
D 65 1.9 (KC0E, KC02, KC0J, KC0N)	Diesel	47	08/97 →					



TYPE

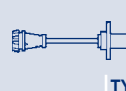

TYPE



TYPE

			SPA108	F1		SAD035	H3	BAE680CU		
						SAG163	H1			
	APS45		SPA108	F1		SAD035	H3			
						SAG028	H1			
						SAG027	H1			
	APS37		SPA108	F1		SAC010	H1		SUA586	J3
	APS37		SPA169	F1					SUA586	J3
	APS37		SPA169	F1					SUA586	J3
						SAD035	H3			
						SAC010	H1			
						SAC010	H1			
	APS37		SPA169	F1		SAC010	H1		SUA586	J3
	APS34									
						SAD035	H3			
						SAG161	H1			
	APS37		SPA169	F1		SAD035	H3		SUA586	J3
	APS34									
						SAG161	H1			
			SPA108	F1						
						SAC010	H1			
			SPA108	F1						
			SPA108	F1		SAD035	H3			
						SAG143	H1			
						SAG160	H1			
			SPA108	F1		SAD035	H3	BAE680E		
						SAG143	H1			
						SAG160	H1			
			SPA108	F1						
									ESS535	J1
			SPA169	F1		SAG153	H1		ESS535	J1
			SPA169	F1		SAG161	H1			
						SAG153	H1			
						SAG159	H1			
			SPA169	F1		SAG159	H1			



KW

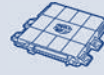

TYPE



TYPE

RENAULT

KANGOO / GRAND KANGOO (KW0/1_)

1.5 dCi (KW0A)	Diesel	50	06/08 → 10/09				
1.5 dCi (KW0B)	Diesel	63	02/08 →				
1.5 dCi (KW0B)	Diesel	63	02/08 → 10/09				
1.5 dCi (KW0C, KW0F)	Diesel	76	02/08 →				
1.5 dCi (KW0C, KW0F)	Diesel	76	02/09 → 10/09				
1.6 (KW00, KW0Y)	Petrol	64	02/08 →				
1.6 16V Hi-Flex	BiFuel	78	02/08 →				
1.6 16V (KW0D)	Petrol	78	02/08 →				

KANGOO BE BOP (KW0/1_)

1.5 dCi (KW0F)	Diesel	76	02/09 →				
1.5 dCi (KW0F)	Diesel	76	02/09 → 10/09				
1.6 (KW0D)	Petrol	78	02/09 →				
1.6 (KW0D)	Petrol	78	02/09 →				

KANGOO Express (FC0/1_)

1.2 (FC01, FC0A, FC0F)	Petrol	43	02/98 →			B23/00	B1
1.2 (FC01, FC0A, FC0F)	Petrol	43	08/97 →				
1.2 (FC01, FC0A, FC0F)	Petrol	43	08/97 → 09/99				
1.2 (FC01, FC0A, FC0F)	Petrol	43	10/99 → 03/02				
1.2 (FC01, FC0A, FC0F)	Petrol	43	08/97 →				
1.2 (FC1A)	Petrol	44	07/98 → 07/01				
1.2 16V (FC05)	Petrol	55	10/01 →	ENGINE: D4F712,D4F714, D4F730		SMR00102Y	B3
1.2 16V (FC05)	Petrol	55	10/01 →				
1.2 16V (FC05)	Petrol	55	10/01 →				
1.4 (FC0C, FC0B, FC0H, FC0M)	Petrol	55	08/97 →			B3395	B1
1.4 (FC0C, FC0B, FC0H, FC0M)	Petrol	55	08/97 →				
1.4 (FC0C, FC0B, FC0H, FC0M)	Petrol	55	09/99 →				
1.5 dCi	Diesel	45	10/05 →				
1.5 dCi (FC07, FC1R)	Diesel	48	12/01 →				
1.5 dCi (FC07, FC1R)	Diesel	48	12/01 → 10/02				
1.5 dCi (FC07, FC1R)	Diesel	48	12/01 →				
1.5 dCi (FC07, FC1R)	Diesel	48	12/01 → 01/05				
1.5 dCi (FC07, FC1R)	Diesel	48	12/01 →				
1.5 dCi (FC08, FC09)	Diesel	60	04/03 →				
1.5 dCi (FC08, FC09)	Diesel	60	04/03 →				
1.5 dCi (FC08, FC09)	Diesel	60	04/03 → 01/05				
1.5 dCi (FC08, FC09)	Diesel	60	04/03 →				
1.5 dCi (FC1E)	Diesel	50	06/05 →				
1.5 dCi (FC1E)	Diesel	50	06/05 → 06/08				
1.5 dCi (FC1G)	Diesel	62	06/05 →				
1.5 dCi (FC1G)	Diesel	62	06/05 → 06/08				
1.5 dCi (FC1R)	Diesel	42	12/02 →				
1.5 dCi (FC1R)	Diesel	42	12/02 → 01/05				
1.5 dCi (FC1R)	Diesel	42	12/02 →				



KW



TYPE



TYPE

RENAULT

KANGOO Express (FC0/1_)

1.6 16V	Petrol	70	10/01 →
1.6 16V	Petrol	70	10/01 →
1.6 16V 4x4 (FC0L, FC0P, FC0S)	Petrol	70	10/01 →
1.6 16V 4x4 (FC0L, FC0P, FC0S)	Petrol	70	10/01 →
1.6 16V 4x4 (FC0L, FC0P, FC0S)	Petrol	70	10/01 → 12/07
1.6 16V bivalent	Petrol/CNG	60	06/05 → 12/06
1.9 D (FC0J)	Diesel	48	09/99 → 06/03
1.9 dCi (FC0V)	Diesel	62	07/03 → 01/05
1.9 dCi 4x4 (FC0V)	Diesel	59	10/01 →
1.9 dCi 4x4 (FC0V)	Diesel	59	10/01 → 01/05
1.9 dCi 4x4 (FC0V)	Diesel	62	07/03 → 01/05
1.9 dCi 4x4 (FC0V)	Diesel	62	07/03 →
1.9 dTi (FC0U)	Diesel	59	02/00 →
1.9 dTi (FC0U)	Diesel	59	05/00 →
D 55 1.9 (FC0D)	Diesel	40	08/97 →
D 65 1.9 (FC0E, FC02, FC0J, FC0N)	Diesel	47	08/97 →

KANGOO Express (FW0/1_)

1.5 dCi	Diesel	50	02/08 →
1.5 dCi (FW0F)	Diesel	76	02/08 →
1.5 dCi (FW0F)	Diesel	76	02/08 →
1.5 dCi 85 (FW0A, FW0B)	Diesel	63	02/08 →
1.5 dCi 85 (FW0A, FW0B)	Diesel	63	02/08 →
1.6	Petrol	64	02/08 →
1.6 16V	Petrol	78	02/08 →
1.6 16V LPG	Petrol/LPG	72	02/08 →

KOLEOS (HY_)

2.0 dCi (HY0K)	Diesel	110	09/08 →
2.0 dCi 4x4 (HY0B)	Diesel	127	09/08 →
2.0 dCi 4x4 (HY0K)	Diesel	110	09/08 →

LAGUNA Coupé (DT0/1)

2.0 16V Turbo	Petrol	125	09/08 →
2.0 dCi	Diesel	127	09/08 →
2.0 dCi (DT01, DT09, DT12, DT1D)	Diesel	110	09/08 →
2.0 dCi GT (DT11, DT1E, DT1N)	Diesel	131	09/08 →
3.0 dCi	Diesel	177	01/12 →

LAGUNA I (B56_, 556_)

1.6 16V (B568, B561)	Petrol	79	05/98 → 02/01
1.6 16V (B568, B561)	Petrol	79	11/97 → 03/01
1.6 16V (B568, B561)	Petrol	79	11/97 → 03/01
1.8	Petrol	69	06/95 → 02/01
1.8	Petrol	70	06/95 → 06/98
1.8 (B56A/B)	Petrol	66	11/93 → 03/01



TYPE

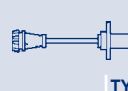

TYPE



TYPE

			SPA108	F1		SAD035	H3	BAE680E		
						SAG143	H1			
			SPA108	F1		SAD035	H3	BAE680E		
						SAG143	H1			
						SAG160	H1			
			SPA108	F1						
						SAG160	H1			
			SPA108	F1						
			SPA169	F1		SAG153	H1		ESS535	J1
			SPA108	F1						
			SPA108	F1						
									ESS535	J1
			SPA169	F1		SAG161	H1		ESS535	J1
						SAG153	H1			
						SAG159	H1			
			SPA169	F1		SAG159	H1			
						SAC010	H1			
						SAC010	H1			
						SAD035	H3			
						SAC010	H1			
						SAD035	H3			
						SAD035	H3			
						SAG160	H1			
						SAG160	H1			
						SAC077	H2			
						SAC077	H2			
						SAC077	H2			
						SAD035	H3			
	APS46					SAC077	H2			
	APS46					SAC077	H2			
	APS46									
	APS46									
IWP142										
	APS44		SPA108	F1		SAD035	H3			
						SAG159	H1			
						SAD035	H3			
						SAD035	H3			
	APS45		SPA160	F1		SAD035	H3		ESS0090A	J1



KW



TYPE



TYPE

RENAULT

LAGUNA I (B56_, 556_)

1.8 (B56A/B)	Petrol	66	11/93 → 03/01					
1.8 (B56S/T/0)	Petrol	66	08/95 → 03/01					
1.8 (B56S/T/0)	Petrol	66	08/95 → 03/01					
1.8 (B56S/T/0)	Petrol	66	08/95 → 04/97	ENGINE: F3P670,678				
1.8 (B56Z)	Petrol	69	08/95 → 03/01					
1.8 (B56Z)	Petrol	69	08/95 → 03/01					
1.8 (B56Z)	Petrol	69	08/95 → 04/97	ENGINE: F3P670,678				
1.8 16V (B563, B564)	Petrol	88	04/98 → 03/01					
1.8 16V (B563, B564)	Petrol	88	04/98 → 03/01					
1.9 dCi (B56W)	Diesel	79	09/99 → 03/01					
1.9 dTi (B56J)	Diesel	72	10/97 → 03/01					
1.9 dTi (B56J)	Diesel	72	10/97 → 09/99					
2.0	Petrol	103	06/95 → 02/01	ENGINE: N7Q700,N7Q704		60XR9		B3
2.0	Petrol	70	11/93 → 03/01			60XR9		B3
2.0	Petrol	84	06/95 → 02/01	ENGINE: F3R768		60XR9		B3
2.0	Petrol	80	03/99 → 03/01					
2.0	Petrol	84	06/95 → 02/01					
2.0	Petrol	84	06/95 → 02/01					
2.0	Petrol	70	11/93 → 04/97	ENGINE: F7R722,723				
2.0 (556A)	Petrol	102	09/99 → 02/01					
2.0 (B56C/H/N)	Petrol	83	11/93 → 03/01					
2.0 (B56C/H/N)	Petrol	83	11/93 → 03/01					
2.0 (B56C/H/N)	Petrol	83	11/93 → 04/97	ENGINE: F7R722,723				
2.0 16V (556A/B)	Petrol	103	09/99 → 03/01					
2.0 16V (556A/B)	Petrol	103	09/99 → 03/01					
2.0 16V (B56D/M)	Petrol	102	06/95 → 03/01					
2.0 16V (B56D/M)	Petrol	102	06/95 → 03/01					
2.2 D (B56F/2)	Diesel	61	11/93 → 03/01					
3.0 (B56E/R, B565)	Petrol	123	11/93 → 03/01					
3.0 (B56E/R, B565)	Petrol	123	11/93 → 03/01					
3.0 (B56E/R, B565)	Petrol	123	11/93 → 04/97	ENGINE: Z7X765-Z7X760				

LAGUNA I Grandtour (K56_)

1.6 16V (K568)	Petrol	79	05/98 → 02/01					
1.6 16V (K568)	Petrol	79	11/97 → 03/01					
1.6 16V (K568)	Petrol	79	11/97 → 03/01					
1.8 (K56S/T/0)	Petrol	66	09/95 → 03/01					
1.8 (K56S/T/0)	Petrol	66	09/95 → 03/01					
1.8 (K56S/T/0)	Petrol	66	09/95 → 04/97	ENGINE: F3P670,678				
1.8 (K56Z)	Petrol	69	09/95 → 03/01					
1.8 (K56Z)	Petrol	69	09/95 → 03/01					
1.8 (K56Z)	Petrol	69	09/95 → 04/97	ENGINE: F3P670,678				
1.8 16V (K563, K564)	Petrol	88	04/98 → 03/01					
1.8 16V (K563, K564)	Petrol	88	04/98 → 03/01					
1.9 dCi (K56W)	Diesel	79	09/99 → 03/01					



TYPE

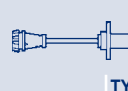

TYPE



TYPE

						SAG158	H1			
	APS45		SPA160	F1		SAD035	H3		ESS0090A	J1
						SAG158	H1			
								BAE801AK		
	APS45		SPA160	F1		SAD035	H3		ESS0090A	J1
						SAG158	H1			
								BAE801AK		
	IWP042		SPA108	F1		SAD035	H3		BAE680E	
						SAG140	H1			
			SPA169	F1						
			SPA169	F1		SAG131	H1			
						SAG114	H1			
						SAD035	H3			
						SAD035	H3			
						SAG140	H1			
								BAE801AK		
						SAD035	H3			
	APS45		SPA160	F1		SAD035	H3			
						SAG128	H1			
								BAE801AK		
			SPA108	F1		SAD035	H3		BAE680E	
						SAG140	H1			
	APS45					SAD028	H3			
						SAG140	H1			
			SPA160	F1		SAG140	H1			
	APS45		ATS14	F2		SAD013	H3			
			SPA160	F1		SAG158	H1			
								BAE801AK		
	IWP142									
		APS44	SPA108	F1		SAD035	H3		BAE680E	
						SAG159	H1			
		APS45	SPA160	F1		SAD035	H3		ESS0090A	J1
						SAG158	H1			
								BAE801AK		
		APS45	SPA160	F1		SAD035	H3		ESS0090A	J1
						SAG158	H1			
								BAE801AK		
	IWP042		SPA108	F1		SAD035	H3		BAE680E	
						SAG140	H1			
			SPA169	F1		SAG140	H1			



KW

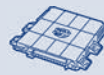

TYPE



TYPE

RENAULT

LAGUNA I Grandtour (K56_)

1.9 dTi (K56J)	Diesel	72	10/97 → 03/01						
1.9 dTi (K56J)	Diesel	72	10/97 → 09/99						
2.0	Petrol	84	10/98 → 01/01						
2.0	Petrol	84	10/98 → 01/01						
2.0 (K56C/H)	Petrol	83	09/95 → 03/01						
2.0 (K56C/H)	Petrol	83	09/95 → 03/01						
2.0 16V (A56A/B)	Petrol	103	09/99 → 03/01						
2.0 16V (A56A/B)	Petrol	103	09/99 → 03/01						
2.0 16V (K56D/M)	Petrol	102	09/95 → 03/01						
2.0 16V (K56D/M)	Petrol	102	09/95 → 03/01						
2.2 D (K56F/2, S56F)	Diesel	61	09/95 → 03/01						
3.0 24V (K56V)	Petrol	140	03/97 → 12/98						
3.0 24V (K56V)	Petrol	140	03/97 → 03/01						

LAGUNA II (BG0/1_)

1.6 16V (BG0A, BG0L)	Petrol	79	03/01 →						
1.6 16V (BG0A, BG0L)	Petrol	79	03/01 →						
1.6 16V (BG1G, BG1H)	Petrol	82	02/05 →						
1.6 16V (BG1G, BG1H)	Petrol	82	02/05 →						
1.8 16V (BG06, BG0J, BG0M)	Petrol	85	03/01 →						
1.8 16V (BG06, BG0J, BG0M)	Petrol	85	03/01 →						
1.8 16V (BG06, BG0J, BG0M)	Petrol	85	03/01 → 09/07						
1.8 16V (BG0B, BG0C, BG0J, BG0M, BG0V)	Petrol	89	03/01 →						
1.8 16V (BG0B, BG0C, BG0J, BG0M, BG0V)	Petrol	89	03/01 →						
1.8 16V (BG0B, BG0M)	Petrol	88	03/01 →						
1.8 16V (BG0B, BG0M)	Petrol	88	03/01 →						
1.9 dCi	Diesel	79	03/01 →						
1.9 dCi (BG05)	Diesel	68	03/04 → 01/05						
1.9 dCi (BG05)	Diesel	68	03/04 →						
1.9 dCi (BG08, BG0G)	Diesel	88	03/01 →						
1.9 dCi (BG08, BG0G)	Diesel	88	04/01 →						
1.9 dCi (BG0E)	Diesel	77	06/01 → 01/05						
1.9 dCi (BG0E)	Diesel	77	06/01 →						
1.9 dCi (BG0R)	Diesel	74	10/01 →						
1.9 dCi (BG0R)	Diesel	74	10/01 → 01/05						
1.9 dCi (BG1A, BG1V)	Diesel	96	05/05 →						
1.9 dCi (BG1A, BG1W)	Diesel	81	01/05 →						
2.0 16V	Petrol	125	01/05 →						
2.0 16V	Petrol	150	01/05 →						
2.0 16V	Petrol	98	08/02 →						
2.0 16V (BG00, BG0K, BG0P, BG0W)	Petrol	99	08/02 →						



TYPE



TYPE



TYPE

				SPA169	F1		SAG131	H1			
							SAG114	H1			
							SAD035	H3			
							SAG140	H1			
		APS45		SPA160	F1		SAD035	H3			
							SAG158	H1			
							SAD035	H3			
							SAG140	H1			
		APS45					SAD028	H3			
							SAG140	H1			
				SPA160	F1		SAG140	H1			
		APS76									
				SPA120	F1	SAA118	SAG150	H1			
				SPA108	F1		SAD035	H3		GA2173	J2
							SAG159	H1			
				SPA169	F1		SAD035	H3	BAE680E	GA2173	J2
							SAG159	H1			
		IWP042		SPA108	F1		SAD035	H3		GA2173	J2
							SAG103	H1			
							SAG160	H1			
		IWP042		SPA108	F1		SAD035	H3	BAE680E	GA2173	J2
							SAG159	H1			
		IWP042		SPA108	F1		SAD035	H3	BAE680E	GA2173	J2
							SAG159	H1			
										ESS535	J1
				SPA108	F1						
							SAG153	H1			
		APS28		SPA169	F1		SAG153	H1			
		APS23									
				SPA108	F1						
										ESS535	J1
				SPA169	F1		SAG153	H1		ESS535	J1
				SPA108	F1						
		APS67		SPA169	F1		SAG153	H1			
				SPA169	F1		SAG153	H1			
				SPA108	F1		SAD035	H3	BAE680E		
				SPA108	F1		SAD035	H3	BAE680E		
				SPA108	F1						
				SPA108	F1		SAD035	H3	BAE680E	GA2173	J2



KW



TYPE



TYPE

RENAULT

LAGUNA II (BG0/1_)

2.0 16V (BG00, BG0K, BG0P, BG0W)	Petrol	99	08/02 →					
2.0 16V (BG00, BG0K, BG0P, BG0W)	Petrol	99	08/02 → 09/07					
2.0 16V IDE (BG0N)	Petrol	103	04/01 →					
2.0 16V IDE (BG0N)	Petrol	103	04/01 →					
2.0 16V Turbo (BG0S, BG0Z, BG1L, BG1M)	Petrol	120	01/03 →	ENGINE: F4R-765,786,787,887				
2.0 16V Turbo (BG0S, BG0Z, BG1L, BG1M)	Petrol	120	01/03 → 08/03					
2.0 16V Turbo (BG0S, BG0Z, BG1L, BG1M)	Petrol	120	09/03 →					
2.0 16V Turbo (BG0S, BG0Z, BG1L, BG1M)	Petrol	120	01/03 →					
2.0 dCi (BG14, BG1S)	Diesel	127	01/06 →					
2.0 dCi (BG1T)	Diesel	110	08/05 →					
2.2 dCi	Diesel	102	05/05 →					
2.2 dCi (BG09)	Diesel	85	04/04 → 01/05					
2.2 dCi (BG0F)	Diesel	110	10/01 →					
2.2 dCi (BG0F)	Diesel	110	10/01 → 01/05					
3.0 V6 24V (BG01, BG02, BG0D, BG0Y)	Petrol	152	03/01 →					

LAGUNA II Grandtour (KG0/1_)

1.6 16V	Petrol	82	02/05 →					
1.6 16V	Petrol	82	02/05 →					
1.6 16V (KG0A, KG0L)	Petrol	79	03/01 →					
1.6 16V (KG0A, KG0L)	Petrol	79	03/01 →					
1.8 16V	Petrol	89	03/01 →					
1.8 16V	Petrol	89	03/01 →					
1.8 16V (KG0B, KG0M)	Petrol	88	03/01 →					
1.8 16V (KG0B, KG0M)	Petrol	88	03/01 →					
1.8 16V (KG0J)	Petrol	85	03/01 →					
1.8 16V (KG0J)	Petrol	85	03/01 →					
1.8 16V (KG0J)	Petrol	85	03/01 → 09/07					
1.9 dCi	Diesel	79	03/01 →					
1.9 dCi (KG05)	Diesel	68	03/04 → 01/05					
1.9 dCi (KG05)	Diesel	68	03/04 →					
1.9 dCi (KG0E)	Diesel	77	06/01 → 01/05					
1.9 dCi (KG0E)	Diesel	77	06/01 →					
1.9 dCi (KG0E, KG0R)	Diesel	74	10/01 →					
1.9 dCi (KG0E, KG0R)	Diesel	74	10/01 → 01/05					
1.9 dCi (KG0G)	Diesel	88	03/01 →					
1.9 dCi (KG0G)	Diesel	88	04/01 →					
1.9 dCi (KG1A, KG1W)	Diesel	81	01/05 →					

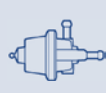

TYPE

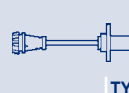

TYPE



TYPE

							SAG159	H1		
							SAG160	H1		
			SPA108	F1			SAD035	H3	BAE680E	
							SAG159	H1		
IWP098										
	APS28									
			SPA108	F1						
							SAD035	H3	BAE680E	GA2173
	APS46						SAC077	H2		
	APS46						SAC077	H2		
							SAG153	H1		
			SPA108	F1						
	APS23		SPA169	F1			SAG153	H1		GA2117
			SPA108	F1						
	APS62						SAD008	H3	BAE680BD	GA2173
			SPA169	F1			SAD035	H3	BAE680E	GA2173
							SAG159	H1		
			SPA108	F1			SAD035	H3	BAE680E	GA2173
							SAG159	H1		
IWP042			SPA108	F1			SAD035	H3	BAE680E	GA2173
							SAG159	H1		
IWP042			SPA108	F1			SAD035	H3	BAE680E	GA2173
							SAG159	H1		
IWP042			SPA108	F1			SAD035	H3	BAE680E	GA2173
							SAG103	H1		
							SAG160	H1		
										ESS535
			SPA108	F1						J1
							SAG153	H1		
			SPA108	F1						ESS535
			SPA169	F1			SAG153	H1		ESS535
			SPA108	F1						J1
	APS28		SPA108	F1			SAG153	H1		
	APS23									
			SPA169	F1			SAG153	H1		



KW



TYPE



TYPE

RENAULT

LAGUNA II Grandtour (KG0/1_)

1.9 dCi (KG1V)	Diesel	96	05/05 →						
2.0 16V	Petrol	125	01/05 →						
2.0 16V	Petrol	150	01/05 →						
2.0 16V (KG00, KG0K, KG0W)	Petrol	99	08/02 →						
2.0 16V (KG00, KG0K, KG0W)	Petrol	99	08/02 →						
2.0 16V (KG00, KG0K, KG0W)	Petrol	99	08/02 → 09/07						
2.0 16V IDE (KG0N)	Petrol	103	04/01 →						
2.0 16V IDE (KG0N)	Petrol	103	04/01 →						
2.0 16V Turbo (KG0S, KG0Z, KG1L, KG1M)	Petrol	120	01/03 →	ENGINE: F4R-765,786,787,887					
2.0 16V Turbo (KG0S, KG0Z, KG1L, KG1M)	Petrol	120	01/03 → 08/03						
2.0 16V Turbo (KG0S, KG0Z, KG1L, KG1M)	Petrol	120	09/03 →						
2.0 16V Turbo (KG0S, KG0Z, KG1L, KG1M)	Petrol	120	01/03 →						
2.0 dCi (KG1S)	Diesel	127	01/06 →						
2.0 dCi (KG1T)	Diesel	110	08/05 →						
2.2 dCi	Diesel	102	05/05 →						
2.2 dCi (KG09)	Diesel	85	04/04 → 01/05						
2.2 dCi (KG0F)	Diesel	110	10/01 →						
2.2 dCi (KG0F)	Diesel	110	10/01 → 01/05						
3.0 V6 24V (KG0D)	Petrol	152	03/01 →						

LAGUNA III (BT0/1)

1.5 dCi (BT00, BT0A, BT0T, BT1J)	Diesel	81	10/07 →						
1.5 dCi (BT00, BT0A, BT0T, BT1J)	Diesel	81	10/07 → 06/08						
1.6 16V (BT04, BT0D, BT0U)	Petrol	81	10/07 →						
2.0 16V (BT05, BT0F, BT0W)	Petrol	103	10/07 →						
2.0 16V Turbo	Petrol	125	10/07 →						
2.0 dCi (BT01, BT09, BT12, BT1S)	Diesel	110	10/07 →						
2.0 dCi (BT08, BT0K, BT0J, BT14, BT1A, BT1D)	Diesel	96	10/07 →						
2.0 dCi (BT0M, BT0N, BT19)	Diesel	127	01/08 →						
2.0 dCi GT (BT1E, BT1N)	Diesel	131	03/08 →						
2.0 GT	Petrol	150	03/08 →						
3.0 dCi (BT03, BT13)	Diesel	173	09/08 →						

LAGUNA III Sportour (KT0/1)

1.5 dCi (KT0A)	Diesel	81	10/07 →						
1.5 dCi (KT0A)	Diesel	81	02/08 → 06/08						
1.6 16V (KT0D)	Petrol	81	10/07 →						
2.0 16V (KT0F, KT0W)	Petrol	103	10/07 →						



TYPE



TYPE



TYPE

	APS67		SPA169	F1		SAG153	H1			
			SPA108	F1		SAD035	H3	BAE680E		
			SPA108	F1		SAD035	H3	BAE680E		
			SPA108	F1		SAD035	H3	BAE680E	GA2173	J2
						SAG159	H1			
						SAG160	H1			
			SPA108	F1		SAD035	H3	BAE680E		
						SAG159	H1			
IWP098										
	APS28									
			SPA108	F1						
						SAD035	H3	BAE680E	GA2173	J2
	APS46					SAC077	H2			
	APS46					SAC077	H2			
						SAG153	H1			
			SPA108	F1						
	APS23		SPA169	F1		SAG153	H1		GA2117	J2
			SPA108	F1						
	APS62					SAD008	H3	BAE680BD	GA2173	J2
						SAD035	H3			
						SAC010	H1			
						SAD035	H3			
						SAD029	H3		GA2057	J2
						SAD035	H3			
	APS46					SAC077	H2		GA2121	J2
	APS46					SAC077	H2		GA2121	J2
	APS46					SAC077	H2		GA2121	J2
	APS46					SAC077	H2		GA2121	J2
			SPA147	F1		SAD035	H3			
	APS46									
						SAD035	H3			
						SAC010	H1			
						SAD035	H3			
						SAD029	H3			



KW

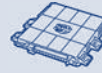

TYPE



TYPE

RENAULT

LAGUNA III Sportour (KT0/1)

2.0 16V Turbo	Petrol	125	10/07 →						
2.0 dCi (KT01, KT08, KT0K, KT0J, KT1A, KT1D)	Diesel	96	10/07 →						
2.0 dCi (KT01, KT09, KT12, KT1S)	Diesel	110	10/07 →						
2.0 dCi (KT0M, KT0N, KT19)	Diesel	127	01/08 →						
2.0 dCi GT (KT11, KT1E, KT1N)	Diesel	131	03/08 →						
2.0 GT	Petrol	150	03/08 →						
3.0 dCi (KT03, KT13)	Diesel	173	09/08 →						

LATITUDE (L70_)

2.0 16V (L70B)	Petrol	103	02/11 →						
2.0 16V eco2	BiFuel	103	02/11 →						

LOGAN (LS_)

1.4	Petrol	55	09/04 →						
1.5 dCi	Diesel	50	04/07 →						
1.5 dCi	Diesel	50	04/07 → 06/09						
1.6	Petrol	64	09/04 →						
1.6	Petrol	77	04/07 →						
1.6	Petrol	77	04/07 →						

LOGAN Station wagon (KS_)

1.4	Petrol	55	10/07 →						
1.5 dCi	Diesel	50	04/07 →						
1.5 dCi	Diesel	50	04/07 → 06/09						
1.6	Petrol	64	04/07 →						
1.6	Petrol	77	04/07 →						
1.6	Petrol	77	04/07 →						

MASTER I Autobus (T_)

28-35 2,5 TD	Diesel	72	08/89 → 07/98						
28-35 2.0	Petrol	58	10/86 → 07/98						
28-35 2.0	Petrol	58	10/86 → 07/98						
28-35 2.0	Petrol	58	03/89 → 07/98						
28-35 2.1 D	Diesel	44	03/89 → 07/98						
28-35 2.4 D	Diesel	52	03/89 → 08/89						
28-35 2.5 D	Diesel	55	08/89 → 07/98						
30 2,2	Petrol	67	08/80 → 07/98						
35 2,5 TD	Diesel	69	08/89 → 07/98						

MASTER I Furgonato (T_)

28-35 2,5 D	Diesel	55	08/89 → 07/98						
28-35 2,5 TD	Diesel	72	08/89 → 07/98						
28-35 2.0	Petrol	58	10/86 → 07/98						
28-35 2.0	Petrol	58	10/86 → 07/98						
28-35 2.0	Petrol	58	03/89 → 07/98						
28-35 2.1 D	Diesel	44	03/89 → 07/98						
28-35 2.4 D	Diesel	52	03/89 → 08/89						

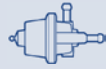

TYPE



TYPE



TYPE

						SAD035	H3		
	APS46					SAC077	H2		
	APS46					SAC077	H2		
	APS46					SAC077	H2		
	APS46					SAC077	H2		
						SAD035	H3		
	APS46								
								BAE680DA	
								BAE680DA	
			SPA108	F1		SAD035	H3		
	APS37					SAD035	H3		
						SAC010	H1		
			SPA108	F1		SAD035	H3		
			SPA108	F1		SAD035	H3		
						SAG160	H1		
			SPA108	F1		SAD035	H3		
	APS37					SAD035	H3		
						SAC010	H1		
			SPA108	F1		SAD035	H3		
			SPA108	F1		SAD035	H3		
						SAG160	H1		
								SUA239	J3
			ATS14	F2					
			SPA160	F1					
								SUA239	J3
								SUA239	J3
								SUA239	J3
								SUA239	J3
	APS45		SPA160	F1		SAD035	H3	SUA239	J3
								SUA239	J3
								SUA239	J3
			ATS14	F2					
			SPA160	F1					
								SUA239	J3
								SUA239	J3
								SUA239	J3



KW



TYPE



TYPE

RENAULT

MASTER I Furgonato (T__)

30 2,2	Petrol	67	08/80 → 07/98						
30 2,2	Petrol	67	03/89 → 07/98						
35 2,5 TD	Diesel	69	08/89 → 07/98						

MASTER I Pianale piatto/Telaio (P__)

28-35 2.0	Petrol	58	10/86 → 07/98						
28-35 2.0	Petrol	58	10/86 → 07/98						
28-35 2.0	Petrol	58	03/89 → 07/98						
28-35 2.5 D	Diesel	52	03/89 → 07/98						

MASTER II Autobus (JD)

1.9 dCi 80	Diesel	60	11/01 →						
1.9 dCi 80	Diesel	60	11/01 → 01/05						
1.9 DTI	Diesel	59	09/00 →						
2.2 dCi 90	Diesel	66	09/00 →						
2.2 dCi 90	Diesel	66	09/00 → 01/05						
2.2 dCi 90	Diesel	66	09/00 → 06/02						
2.5 D	Diesel	59	07/98 → 01/01						
2.5 dCi	Diesel	84	01/04 → 01/05						
2.5 dCi 100 (JDCV)	Diesel	73	10/03 → 10/06						
2.5 dCi 120	Diesel	84	10/01 →						
2.5 dCi 120	Diesel	84	10/01 → 01/05						
2.8 dTi	Diesel	84	07/98 → 10/01						
2.8 dTi	Diesel	84	08/00 → 10/01						
3.0 dCi 140 (JD0T)	Diesel	100	10/03 →						

MASTER II Furgonato (FD)

1.9 dCi 80	Diesel	60	11/01 →						
1.9 dCi 80	Diesel	60	11/01 → 01/05						
1.9 DTI	Diesel	59	09/00 →						
2.2 dCi 90	Diesel	66	09/00 →						
2.2 dCi 90	Diesel	66	09/00 → 01/05						
2.2 dCi 90	Diesel	66	09/00 → 06/02						
2.5 D	Diesel	59	07/98 → 01/01						
2.5 dCi	Diesel	84	01/04 → 01/05						
2.5 dCi 100 (FD0U, FD0V)	Diesel	73	10/03 → 10/06						
2.5 dCi 120	Diesel	84	10/01 →						
2.5 dCi 120	Diesel	84	10/01 → 01/05						
2.8 dTi	Diesel	84	07/98 → 10/01						
3.0 dCi 120	Diesel	85	06/05 →						
3.0 dCi 140 (HD0S, FD0S, HD1S)	Diesel	100	10/03 →						
3.0 dCi 160	Diesel	115	06/05 →						



KW



TYPE



TYPE

RENAULT

MASTER II Pianale piatto/Telaio (ED/HD/UD)

2.2 dCi 90	Diesel	66	09/00 →					
2.2 dCi 90	Diesel	66	09/00 → 01/05					
2.2 dCi 90	Diesel	66	09/00 → 06/02					
2.5 D	Diesel	59	07/98 → 01/01					
2.5 dCi	Diesel	84	01/04 → 01/05					
2.5 dCi 100 (ED4V, ED8V)	Diesel	73	10/03 → 10/06					
2.5 dCi 120	Diesel	84	10/01 →					
2.5 dCi 120	Diesel	84	10/01 → 01/05					
2.8 dTi	Diesel	84	07/98 → 10/01					
3.0 dCi 120	Diesel	85	06/05 →					
3.0 dCi 140 (ED0S, UD0S)	Diesel	100	10/03 →					
3.0 dCi 160	Diesel	115	06/05 →					

MEGANE CC (EZ0/1_)

1.4 TCe (EZ0F, EZ1V)	Petrol	96	06/10 →					
----------------------	--------	----	---------	--	--	--	--	--

MEGANE I (BA0/1_)

1.4 16V (BA0D, BA1H, BA0W, BA10)	Petrol	70	03/99 → 10/02					
1.4 16V (BA0D, BA1H, BA0W, BA10)	Petrol	70	03/99 → 08/03					
1.4 16V (BA0D, BA1H, BA0W, BA10)	Petrol	70	03/99 → 08/03					
1.4 e (BA0E, BA0V)	Petrol	55	01/96 → 08/03			B3354		B1
1.4 e (BA0E, BA0V)	Petrol	55	01/96 → 08/03					
1.4 e (BA0E, BA0V)	Petrol	55	01/96 → 08/97					
1.4 e (BA0E, BA0V)	Petrol	55	09/97 → 04/98					
1.6 16V (BA11, BA04, BA0B, BA1J)	Petrol	79	03/99 → 10/02					
1.6 16V (BA11, BA04, BA0B, BA1J)	Petrol	79	03/99 → 08/03					
1.6 16V (BA11, BA04, BA0B, BA1J)	Petrol	79	03/99 → 08/03					
1.6 e (BA0F, BA0S)	Petrol	66	01/96 → 03/99			B3355		B1
1.6 e (BA0F, BA0S)	Petrol	66	01/96 → 03/99	ENGINE: K7M		B28/00		B1
1.6 e (BA0F, BA0S)	Petrol	66	01/96 → 03/99					
1.6 e (BA0F, BA0S)	Petrol	66	01/96 → 08/97					
1.6 e (BA0F, BA0S)	Petrol	66	05/98 → 03/99					
1.6 e (BA0F, BA0S)	Petrol	66	07/98 → 03/99					
1.6 e (BA0F, BA0S)	Petrol	66	09/97 → 04/98					
1.6 e (BA0F, BA0S)	Petrol	66	09/97 → 06/98					
1.6 i (BA0L)	Petrol	55	01/96 → 03/99	ENGINE: K7M		B28/00		B1
1.6 i (BA0L)	Petrol	55	01/96 → 03/99					
1.6 i (BA0L)	Petrol	55	01/96 → 03/99					
1.6 i (BA0L)	Petrol	55	01/96 → 08/97					
1.6 i (BA0L)	Petrol	55	05/98 → 03/99					



KW

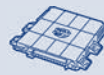

TYPE



TYPE

RENAULT

MEGANE I (BA0/1_)

1.6 i (BA0L)	Petrol	55	09/97 → 04/98					
1.8 16V (BA06, BA12, BA1A, BA1M, BA1R)	Petrol	85	01/01 → 08/03				B3390	B1
1.8 16V (BA06, BA12, BA1A, BA1M, BA1R)	Petrol	85	01/01 → 08/03					
1.9 D Eco (B/SA0U, BA0A)	Diesel	47	06/98 → 08/03					
1.9 dCi	Diesel	77	03/99 → 08/03					
1.9 dCi (BA05, BA1F)	Diesel	75	02/01 → 08/03					
1.9 dT (B/SA0K, B/SA0Y)	Diesel	66	01/96 → 08/03					
1.9 dTi (BA08, BA0N)	Diesel	72	03/97 → 02/01					
1.9 dTi (BA08, BA0N)	Diesel	72	03/97 → 02/99					
1.9 dTi (BA08, BA0N)	Diesel	72	07/98 → 02/01					
1.9 dTi (BA1U)	Diesel	59	02/01 → 08/03					
2.0 i	Petrol	80	03/99 → 08/03	ENGINE: (ES9J4-XU10J4RS)			CA0005504	B6
2.0 i	Petrol	80	03/99 → 08/03					
2.0 i (BA0G)	Petrol	84	01/96 → 08/03	ENGINE: F3R750,F3R751			60XR9	B3
2.0 i (BA0G)	Petrol	84	01/96 → 08/03	ENGINE: (ES9J4-XU10J4RS)			CA0005504	B6
2.0 i (BA0G)	Petrol	84	01/96 → 08/03					
2.0 i (BA0G)	Petrol	84	01/96 → 08/03					
2.0 i (BA0G)	Petrol	84	09/99 → 08/03					
2.0 i (BA0G)	Petrol	84	10/98 → 08/03					
2.0 i (BA0G)	Petrol	84	05/97 → 02/99	ENGINE: F3R796				

MEGANE I Cabriolet (EA0/1_)

1.4 16V (EA0D, EA1H, EA0W, EA10)	Petrol	70	03/99 → 08/03					
1.4 16V (EA0D, EA1H, EA0W, EA10)	Petrol	70	03/99 → 08/03					
1.6 16V (EA0B, EA04, EA11)	Petrol	79	03/99 → 08/03					
1.6 16V (EA0B, EA04, EA11)	Petrol	79	03/99 → 08/03					
2.0 (EA0G)	Petrol	84	04/97 → 08/03	ENGINE: (ES9J4-XU10J4RS)			CA0005504	B6
2.0 (EA0G)	Petrol	84	04/97 → 08/03					
2.0 (EA0G)	Petrol	84	04/97 → 08/03					
2.0 (EA0G)	Petrol	84	09/99 → 08/03					
2.0 16V	Petrol	102	01/02 → 08/03					
2.0 16V	Petrol	102	01/02 → 08/03					
2.0 16V IDE (EA03, EA0P, EA14)	Petrol	103	11/99 → 08/03					
2.0 16V IDE (EA03, EA0P, EA14)	Petrol	103	11/99 → 08/03					
2.0 i (EA0G)	Petrol	80	03/99 → 08/03	ENGINE: (ES9J4-XU10J4RS)			CA0005504	B6
2.0 i (EA0G)	Petrol	80	03/99 → 08/03					
2.0 i (EA0G)	Petrol	80	03/99 → 08/03					
2.0 i (EA0G)	Petrol	80	03/99 → 08/03	ENGINE: F3R750,751				

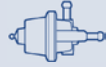

TYPE



TYPE



TYPE

						SAG163	H1			
				SPA108	F1	SAD035	H3	BAE680E		
						SAG159	H1			
						SAG161	H1			
									ESS535	J1
				SPA169	F1	SAG131	H1		ESS535	J1
						SAG140	H1			
				SPA169	F1	SAG131	H1			
						SAG114	H1			
						SAG161	H1			
				SPA169	F1	SAG140	H1			
						SAD035	H3			
		APS45				SAD035	H3			
						SAG028	H1			
						SAG027	H1			
						SAG143	H1			
								BAE801EK		
				SPA108	F1	SAD035	H3			
						SAG159	H1			
				SPA108	F1	SAD035	H3			
						SAG140	H1			
		APS45				SAD035	H3			
						SAG028	H1			
						SAG027	H1			
				SPA108	F1	SAD035	H3	BAE680E		
						SAG140	H1			
				SPA108	F1	SAD035	H3			
						SAG140	H1			
						SAD035	H3			
						SAG143	H1			
								BAE801EK		



KW

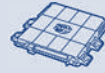

TYPE



TYPE

RENAULT

MEGANE I Classic (LA0/1_)

1.4 16V (LA0D, LA1H, IA0W, LA10)	Petrol	70	03/99 → 08/03					
1.4 16V (LA0D, LA1H, IA0W, LA10)	Petrol	70	03/99 → 08/03					
1.6 16V (La04, LA11, LA0B, LA1C, LA1J)	Petrol	79	03/99 → 08/03					
1.6 16V (La04, LA11, LA0B, LA1C, LA1J)	Petrol	79	03/99 → 08/03					
1.8 16V (LA06, LA12, LA1A, LA1M, LA1R)	Petrol	85	01/01 → 08/03			B3390		B1
1.8 16V (LA06, LA12, LA1A, LA1M, LA1R)	Petrol	85	01/01 → 08/03					
1.9 dCi (LA05, LA1F)	Diesel	75	02/01 → 08/03					
1.9 dTi (LA08, LA0N)	Diesel	72	03/97 → 02/01					
1.9 dTi (LA08, LA0N)	Diesel	72	03/97 → 02/99					
1.9 dTi (LA08, LA0N)	Diesel	72	07/98 → 02/01					
1.9 dTi (LA1U)	Diesel	59	02/01 → 08/03					
2.0 i (LA0G)	Petrol	80	03/99 → 08/03	ENGINE: (ES9J4-XU10J4RS)		CA0005504		B6
2.0 i (LA0G)	Petrol	80	03/99 → 08/03					

MEGANE I Coach (DA0/1_)

1.4 16V (DA0D, DA1H, DA0W, DA10)	Petrol	70	03/99 → 08/03					
1.4 16V (DA0D, DA1H, DA0W, DA10)	Petrol	70	03/99 → 08/03					
1.6 16V (DA0B, DA04, DA11)	Petrol	79	03/99 → 08/03					
1.6 16V (DA0B, DA04, DA11)	Petrol	79	03/99 → 08/03					
1.6 e (DA0F)	Petrol	66	03/96 → 03/99			B3355		B1
1.6 e (DA0F)	Petrol	66	03/96 → 03/99	ENGINE: K7M		B28/00		B1
1.6 e (DA0F)	Petrol	66	03/96 → 03/99					
1.6 e (DA0F)	Petrol	66	03/96 → 08/97					
1.6 e (DA0F)	Petrol	66	05/98 → 03/99					
1.6 e (DA0F)	Petrol	66	07/98 → 03/99					
1.6 e (DA0F)	Petrol	66	09/97 → 04/98					
1.6 e (DA0F)	Petrol	66	09/97 → 06/98					
1.9 dCi	Diesel	77	03/99 → 09/00					
1.9 dCi (DA05, DA1F)	Diesel	75	02/01 → 08/03					
1.9 dTi (DA0N)	Diesel	72	03/97 → 02/01					
1.9 dTi (DA0N)	Diesel	72	03/97 → 06/98					
1.9 dTi (DA0N)	Diesel	72	07/98 → 02/01					
2.0 16V	Petrol	102	01/02 → 08/03					
2.0 16V (DA0H)	Petrol	108	03/96 → 11/99					
2.0 16V (DA0H)	Petrol	108	03/96 → 11/99					
2.0 16V IDE (DA03, DA0P, DA14)	Petrol	103	11/99 → 08/03					
2.0 16V IDE (DA03, DA0P, DA14)	Petrol	103	11/99 → 08/03					



TYPE

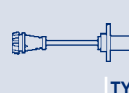

TYPE



TYPE

IWP142			SPA108	F1		SAD035	H3		
						SAG159	H1		
IWP142			SPA108	F1		SAD035	H3	BAE680E	
						SAG143	H1		
			SPA108	F1		SAD035	H3		
						SAG159	H1		
	APS37		SPA169	F1		SAG131	H1		ESS535
			SPA169	F1		SAG131	H1		J1
						SAG114	H1		
						SAG161	H1		
			SPA169	F1		SAG161	H1		
						SAD035	H3		
			SPA108	F1		SAD035	H3		
						SAG159	H1		
			SPA108	F1		SAD035	H3		
						SAG143	H1		
	APS45		ATS14	F2		SAD035	H3		
			SPA160	F1		SAG160	H1		
						SAG128	H1		
						SAG159	H1		
						SAG143	H1		
						SAG163	H1		
						SAG129	H1		
								ESS535	J1
			SPA169	F1		SAG131	H1	ESS535	J1
			SPA169	F1		SAG131	H1		
						SAG114	H1		
						SAG161	H1		
			SPA108	F1		SAG140	H1	BAE680E	
	APS45					SAD028	H3		
						SAG140	H1		
			SPA108	F1		SAD035	H3		
						SAG140	H1		



KW



TYPE



TYPE

RENAULT

MEGANE I Coach (DA0/1_)

2.0 i	Petrol	80	03/99 → 08/03	ENGINE: (ES9J4-XU10J4RS)		CA0005504	B6
2.0 i	Petrol	80	03/99 → 08/03				
2.0 i (DA0G)	Petrol	84	03/96 → 08/03	ENGINE: (ES9J4-XU10J4RS)		CA0005504	B6
2.0 i (DA0G)	Petrol	84	03/96 → 08/03				
2.0 i (DA0G)	Petrol	84	03/96 → 08/03				
2.0 i (DA0G)	Petrol	84	09/99 → 08/03				
2.0 i (DA0G)	Petrol	84	10/98 → 08/03				
2.0 i (DA0G)	Petrol	84	03/96 → 04/97	ENGINE: F3R750,751			

MEGANE I Grandtour (KA0/1_)

1.4 16V (KA0D, KA1H, KA0W, KA10)	Petrol	70	03/99 → 08/03				
1.4 16V (KA0D, KA1H, KA0W, KA10)	Petrol	70	03/99 → 08/03				
1.4 e (KA0V)	Petrol	55	03/99 → 08/03			B3354	B1
1.4 e (KA0V)	Petrol	55	03/99 → 08/03				
1.6 16V (KA0B, KA04, KA11)	Petrol	79	03/99 → 08/03				
1.6 16V (KA0B, KA04, KA11)	Petrol	79	03/99 → 08/03				
1.6 e (KA0F)	Petrol	66	03/99 → 08/03			B3355	B1
1.6 e (KA0F)	Petrol	66	03/99 → 08/03				
1.8 16V (KA0S, KA12, KA1A, KA1M, KA1R)	Petrol	85	01/01 → 08/03			B3390	B1
1.8 16V (KA0S, KA12, KA1A, KA1M, KA1R)	Petrol	85	01/01 → 08/03				
1.9 D (KA0J, KA0R)	Diesel	47	04/99 → 08/03				
1.9 dCi (KA05, KA1F)	Diesel	75	02/01 → 08/03				
1.9 dTi (KA0N)	Diesel	72	03/99 → 02/01				
1.9 dTi (KA1U)	Diesel	59	02/01 → 08/03				

MEGANE II (BM0/1_, CM0/1_)

1.4 16V	Petrol	60	10/03 → 01/05				
1.4 16V	Petrol	60	10/03 →				
1.4 16V	Petrol	60	10/03 →				
1.4 16V (BM0B, CM0B)	Petrol	72	11/02 →				
1.4 16V (BM0B, CM0B)	Petrol	72	02/05 →				
1.4 16V (BM0B, CM0B)	Petrol	72	11/07 →				
1.4 16V (BM0B, CM0B)	Petrol	72	11/02 →				
1.4 16V (BM0B, CM0B)	Petrol	72	11/02 → 10/08				
1.5 dCi	Diesel	63	05/05 →				
1.5 dCi	Diesel	74	10/03 →				
1.5 dCi	Diesel	74	10/03 → 01/05				
1.5 dCi	Diesel	78	05/05 →				
1.5 dCi	Diesel	63	05/05 → 03/09				
1.5 dCi	Diesel	74	10/03 →				
1.5 dCi	Diesel	76	01/07 →				
1.5 dCi	Diesel	76	01/07 →				



KW



TYPE



TYPE

RENAULT

MEGANE II (BM0/1_, CM0/1_)

1.5 dCi	Diesel	78	05/05 →						
1.5 dCi (BM0F, CM0F)	Diesel	60	11/02 →						
1.5 dCi (BM0F, CM0F)	Diesel	60	11/02 →						
1.5 dCi (BM0F, CM0F)	Diesel	60	11/02 →						
1.6	Petrol	77	06/05 →						
1.6	Petrol	77	06/05 →						
1.6 16V	Petrol	82	01/06 →						
1.6 16V	Petrol	82	01/06 →						
1.6 16V (BM0C, CM0C)	Petrol	83	11/02 →						
1.6 16V (BM0C, CM0C)	Petrol	83	02/05 →						
1.6 16V (BM0C, CM0C)	Petrol	83	11/02 →						
1.6 Flex-Fuel	BiFuel	77	01/07 →						
1.9 dCi	Diesel	81	05/05 →						
1.9 dCi	Diesel	96	05/05 →						
1.9 dCi	Diesel	68	03/04 →						
1.9 dCi (BM0G, CM0G)	Diesel	88	11/02 →						
2.0	Petrol	169	08/06 → 11/07						
2.0 16V (BM0U, CM0U)	Petrol	99	11/02 →						
2.0 16V (BM0U, CM0U)	Petrol	99	11/07 →						
2.0 16V Turbo	Petrol	120	05/04 →	ENGINE: F4R-776					
2.0 16V Turbo	Petrol	120	08/04 → 11/07						
2.0 16V Turbo	Petrol	120	11/07 →						
2.0 16V Turbo	Petrol	120	05/04 →						
2.0 dCi	Diesel	127	01/07 →						
2.0 dCi (BM1K, CM1K)	Diesel	110	09/05 →						
2.0 Renault Sport	Petrol	165	05/04 → 11/07						
2.0 Renault Sport	Petrol	165	11/07 →						
2.0 Renault Sport	Petrol	165	05/04 →						

MEGANE II Coupé-Cabriolet (EM0/1_)

1.5 dCi (EM16)	Diesel	76	01/07 →						
1.5 dCi (EM16)	Diesel	76	01/07 →						
1.5 dCi (EM1E)	Diesel	78	03/06 →						
1.5 dCi (EM1E)	Diesel	78	03/06 →						
1.6	Petrol	83	09/03 → 01/05						
1.6	Petrol	83	02/05 →						
1.6	Petrol	83	09/03 →						
1.6	Petrol	83	09/03 →						
1.6	Petrol	83	10/03 →						
1.6 16V	Petrol	82	01/06 →						
1.6 16V	Petrol	82	01/06 →						
1.9 dCi	Diesel	81	05/05 →						
1.9 dCi	Diesel	96	05/05 →						
1.9 dCi	Diesel	88	09/03 →						
2.0	Petrol	99	09/03 →						

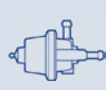

TYPE

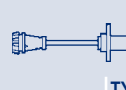

TYPE



TYPE

						SAD035	H3		
	APS51		SPA169	F1		SAC010	H1		
						SAD035	H3		
						SAG161	H1		
						SAD035	H3		
						SAG160	H1		
						SAD035	H3		
						SAG160	H1		
			SPA108	F1		SAD035	H3	BAE680E	
			SPA169	F1					
						SAG143	H1		
			SPA108	F1					
	APS67								
	APS67					SAG153	H1		
			SPA169	F1		SAG153	H1		
			SPA169	F1		SAG153	H1		
			SPA108	F1					
IWP042			SPA108	F1		SAD035	H3		
			SPA147	F1					
IWP098									
			SPA108	F1					
			SPA147	F1					
						SAD035	H3	BAE680E	
	APS46					SAC077	H2		
	APS46					SAC077	H2		
			SPA108	F1					
			SPA147	F1					
						SAD035	H3		
						SAC010	H1		
						SAD035	H3		
						SAC010	H1		
						SAD035	H3		
			SPA108	F1					
			SPA169	F1					
						SAD035	H3		
						SAG103	H1		
						SAG160	H1		
						SAD035	H3		
						SAG103	H1		
	APS67								
	APS67					SAG153	H1		
			SPA169	F1		SAG153	H1		
			SPA108	F1		SAD035	H3		



KW



TYPE



TYPE

RENAULT

MEGANE II Coupé-Cabriolet (EM0/1_)

2.0	Petrol	99	11/07 →						
2.0 16V Turbo	Petrol	120	05/04 → 11/07						
2.0 16V Turbo	Petrol	120	11/07 →						
2.0 16V Turbo	Petrol	120	05/04 →						
2.0 dCi	Diesel	110	09/05 →						

MEGANE II Station wagon (KM0/1_)

1.4	Petrol	72	08/03 → 01/05						
1.4	Petrol	72	02/05 →						
1.4	Petrol	72	11/07 →						
1.4	Petrol	72	08/03 →						
1.4	Petrol	72	08/03 →						
1.4	Petrol	72	10/03 → 05/09						
1.5 dCi	Diesel	60	08/03 →						
1.5 dCi	Diesel	60	08/03 →						
1.5 dCi	Diesel	63	05/05 →						
1.5 dCi	Diesel	74	02/04 →						
1.5 dCi	Diesel	74	02/04 → 01/05						
1.5 dCi	Diesel	60	08/03 →						
1.5 dCi	Diesel	63	05/05 → 03/09						
1.5 dCi	Diesel	74	02/04 →						
1.5 dCi (KM13)	Diesel	76	01/07 →						
1.5 dCi (KM13)	Diesel	76	01/07 →						
1.5 dCi (KM16, KM1E)	Diesel	78	05/05 →						
1.5 dCi (KM16, KM1E)	Diesel	78	05/05 →						
1.6	Petrol	83	08/03 → 01/05						
1.6	Petrol	83	02/05 →						
1.6	Petrol	83	08/03 →						
1.6	Petrol	83	08/03 →						
1.6	Petrol	83	10/03 → 05/09						
1.6 16V	Petrol	82	01/06 →						
1.6 16V	Petrol	82	01/06 → 05/09						
1.6 16V Hi-Flex	BiFuel	77	02/08 →						
1.9 dCi	Diesel	81	05/05 →						
1.9 dCi	Diesel	96	05/05 →						
1.9 dCi	Diesel	68	03/04 →						
1.9 dCi	Diesel	88	08/03 →						
2.0	Petrol	99	08/03 → 11/07						
2.0	Petrol	99	11/07 →						
2.0	Petrol	99	08/03 →						
2.0 dCi	Diesel	110	09/05 →						



TYPE



TYPE



TYPE

				SPA147	F1					
				SPA108	F1					
				SPA147	F1					
							SAD035	H3	BAE680E	
	APS46						SAC077	H2		
				SPA108	F1					
				SPA169	F1					
				SPA147	F1					
							SAD035	H3	BAE680E	
							SAG159	H1		
							SAG160	H1		
	APS51			SPA169	F1		SAC010	H1		
							SAD035	H3		
				SPA169	F1		SAD035	H3		
				SPA169	F1		SAC010	H1		
				SPA108	F1					
							SAG161	H1		
							SAC010	H1		
							SAD035	H3		
							SAC010	H1		
							SAD035	H3		
				SPA169	F1		SAC010	H1		
							SAD035	H3		
				SPA108	F1					
				SPA169	F1					
							SAD035	H3	BAE680E	
							SAG103	H1		
							SAG160	H1		
							SAD035	H3		
							SAG160	H1		
				SPA108	F1					
	APS67									
	APS67						SAG153	H1		
				SPA169	F1		SAG153	H1		
				SPA169	F1		SAG153	H1		
				SPA108	F1					
				SPA147	F1					
							SAD035	H3	BAE680E	
	APS46						SAC077	H2		

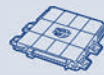
KW

TYPE

TYPE
RENAULT
MEGANE II Tre volumi (LM0/1_)

1.4	Petrol	60	09/03 → 01/05						
1.4	Petrol	72	09/03 → 01/05						
1.4	Petrol	72	02/05 →						
1.4	Petrol	72	11/07 →						
1.4	Petrol	60	09/03 →						
1.4	Petrol	72	09/03 →						
1.4	Petrol	72	09/03 →						
1.4	Petrol	72	10/03 →						
1.5 dCi	Diesel	60	09/03 →						
1.5 dCi	Diesel	60	09/03 →						
1.5 dCi	Diesel	63	05/05 →						
1.5 dCi	Diesel	74	02/04 →						
1.5 dCi	Diesel	78	05/05 →						
1.5 dCi	Diesel	60	09/03 →						
1.5 dCi	Diesel	63	05/05 → 03/09						
1.5 dCi	Diesel	74	02/04 →						
1.5 dCi	Diesel	76	01/07 →						
1.5 dCi	Diesel	76	01/07 →						
1.5 dCi	Diesel	78	05/05 → 03/09						
1.6	Petrol	77	05/05 →						
1.6	Petrol	83	09/03 → 01/05						
1.6	Petrol	83	02/05 →						
1.6	Petrol	83	09/03 →						
1.6	Petrol	83	09/03 →						
1.6	Petrol	83	10/03 →						
1.6 16V	Petrol	82	01/06 →						
1.6 16V	Petrol	82	01/06 →						
1.9 dCi	Diesel	96	05/05 →						
1.9 dCi	Diesel	68	03/04 →						
1.9 dCi (LM0G, LM1G, LM2C)	Diesel	88	09/03 →						
1.9 dCi (LM14, LM1D)	Diesel	81	05/05 →						
2.0	Petrol	99	09/03 → 11/07						
2.0	Petrol	99	11/07 →						
2.0	Petrol	99	09/03 →						

MEGANE III 2 volumi /Coda spiovente (BZ0_)

1.2 TCe	Petrol	85	03/12 →	ENGINE: H5F400					
1.4 TCe (BZ0F, BZ1V)	Petrol	96	04/09 →						
1.5 dCi	Diesel	63	12/09 →						
1.5 dCi	Diesel	78	02/09 →						
1.5 dCi (BZ09, BZ0D)	Diesel	81	02/09 →						
1.5 dCi (BZ0C)	Diesel	66	11/08 →						
1.6 16V (BZ0H)	Petrol	74	11/08 →						
1.6 16V (BZ0H)	Petrol	74	11/08 →						
1.6 16V (BZ1B, BZ1H)	Petrol	81	11/08 →						



KW

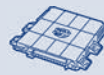

TYPE



TYPE

RENAULT

MEGANE III 2 volumi /Coda spiovente (BZ0_)

1.6 16V Bifuel (BZ03)	BiFuel	81	11/08 →
1.9 dCi (BZ0N, BZ0J)	Diesel	96	11/08 →
2.0 CVT (BZ0G, BZ1P)	Petrol	103	02/09 →
2.0 dCi (BZ0L)	Diesel	118	04/09 →
2.0 dCi (BZ0Y)	Diesel	110	10/10 →

MEGANE III Coupé (DZ0/1_)

1.4 TCe (DZ0F, DZ1V)	Petrol	96	04/09 →
1.5 dCi (DZ09, DZ0D, DZ1F, DZ1G)	Diesel	81	02/09 →
1.5 dCi (DZ0A)	Diesel	63	11/08 →
1.5 dCi (DZ0B)	Diesel	78	02/09 →
1.5 dCi (DZ0C, DZ1A)	Diesel	66	11/08 →
1.6 16V (DZ0H)	Petrol	74	11/08 →
1.6 16V (DZ0H)	Petrol	74	06/09 →
1.6 16V (DZ0U, DZ1B, DZ1H)	Petrol	81	11/08 →
1.6 16V Bifuel (DZ03, DZ1Y)	BiFuel	81	11/08 →
1.9 dCi (DZ0N, DZ0J, DZ1J, DZ1K)	Diesel	96	11/08 →
2.0 CVT (DZ0G, DZ1E)	Petrol	103	05/09 →
2.0 dCi (DZ0L)	Diesel	118	04/09 →
2.0 dCi (DZ0Y)	Diesel	110	04/09 →
2.0 TCe (DZ0K)	Petrol	132	11/08 →

MEGANE III Grandtour (KZ0/1)

1.4 TCe (KZ0F, KZ1V)	Petrol	96	05/09 →
1.5 dCi (KZ09, KZ0D, KZ1G, KZ1M, KZ1W)	Diesel	81	02/09 →
1.5 dCi (KZ0C, KZ1A)	Diesel	66	05/09 →
1.5 dCi (KZ1M, KZ1W)	Diesel	78	02/09 →
1.6 16V (KZ0H)	Petrol	74	05/09 →
1.6 16V (KZ0H)	Petrol	74	05/09 →
1.6 16V (KZ0U, KZ1B, KZ1U)	Petrol	81	05/09 →
1.6 16V Bifuel (KZ03)	BiFuel	81	11/08 →
1.9 dCi (KZ0J, KZ0N, KZ1S)	Diesel	96	05/09 →
2.0 CVT (KZ0G, KZ1P)	Petrol	103	06/09 →
2.0 CVT (KZ0G, KZ1P)	Petrol	103	05/09 →
2.0 dCi (KZ0L)	Diesel	118	04/09 →
2.0 dCi (KZ0Y)	Diesel	110	10/10 →

MEGANE Scenic (JA0/1_)

1.6 16V (JA0B, JA04, JA11)	Petrol	79	08/99 → 10/99
1.6 16V (JA0B, JA04, JA11)	Petrol	79	04/98 → 10/99
1.6 16V (JA0B, JA04, JA11)	Petrol	79	04/98 → 10/99
1.9 dTi (JA0N)	Diesel	72	04/97 → 09/99
1.9 dTi (JA0N)	Diesel	72	07/98 → 09/99
2.0 i (JA0G)	Petrol	80	01/99 → 09/99



KW

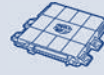

TYPE



TYPE

RENAULT

MEGANE Scenic (JA0/1_)

2.0 i (JA0G) Petrol 80 01/99 → 09/99

MODUS / GRAND MODUS (F/JP0_)

1.2 (FP0C, FP0K, FP0P) Petrol 48 05/05 → 06/07

1.2 (FP0C, FP0K, FP0P) Petrol 48 05/05 →

1.2 (FP0C, FP0K, FP0P) Petrol 48 05/05 → ENGINE: D4F740

1.2 (JP0C, JP0K, FP0C, FP0K, FP0P, JP0P, JP0T) Petrol 55 12/04 → 06/07

1.2 (JP0C, JP0K, FP0C, FP0K, FP0P, JP0P, JP0T) Petrol 55 12/04 →

1.2 (JP0C, JP0K, FP0C, FP0K, FP0P, JP0P, JP0T) Petrol 55 12/04 →

1.2 (JP0S) Petrol 58 12/04 →

1.2 (JP0S) Petrol 58 12/04 → ENGINE: D4F764

1.2 (JP0S) Petrol 58 04/05 →

1.2 16V Hi-Flex BiFuel 55 10/08 →

1.2 16V (JP0W) Petrol 74 05/07 →

1.4 (JP01, JP0J) Petrol 72 12/04 →

1.5 dCi (FP0D, JP0D) Diesel 60 09/04 → 01/05

1.5 dCi (FP0D, JP0D) Diesel 60 09/04 →

1.5 dCi (FP0E, JP0E) Diesel 48 12/04 →

1.5 dCi (FP0E, JP0E) Diesel 48 12/04 →

1.5 dCi (FP0E, JP0E) Diesel 48 12/04 → 01/05

1.5 dCi (FP0E, JP0E) Diesel 48 12/04 → ENGINE: K9K752

1.5 dCi (FP0F, JP0F) Diesel 63 12/04 →

1.5 dCi (FP0F, JP0F) Diesel 63 12/04 →

1.5 dCi (FP0F, JP0F) Diesel 63 08/06 → 07/08

1.5 dCi (FP0G, JP0G) Diesel 50 12/04 →

1.5 dCi (FP0G, JP0G) Diesel 50 12/04 → 01/05

1.5 dCi (FP0G, JP0G) Diesel 50 12/04 →

1.5 dCi (FP0G, JP0G) Diesel 50 12/04 →

1.5 dCi (JP02) Diesel 76 05/07 → 07/08

1.5 dCi (JP02) Diesel 76 05/07 →

1.5 dCi (JP02) Diesel 76 05/07 →

1.5 dCi (JP0G, JP0H) Diesel 78 05/05 →

1.5 dCi (JP0G, JP0H) Diesel 78 05/05 → 07/08

1.6 (JP03, JP0B, JP0U, JP0Y, JP1G) Petrol 82 12/04 →

1.6 (JP03, JP0B, JP0U, JP0Y, JP1G) Petrol 82 12/04 → 01/05

1.6 (JP03, JP0B, JP0U, JP0Y, JP1G) Petrol 82 12/04 →

1.6 (JP0L, JP0V) Petrol 65 12/04 →



TYPE

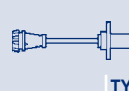

TYPE



TYPE

						SAG140	H1			
					SPA108	F1				
							SAD035	H3	SUA476	J2
							CVS02	H1		
					SPA108	F1				
							SAD035	H3	BAE680CU	SUA476
							SAG163	H1		
							SAD035	H3	GA2187	J2
							CVS02	H1		
							SAC010	H1		
									BAE680CU	
							SAD035	H3	GA2187	J2
					SPA169	F1	SAD035	H3	SUA476	J2
					SPA108	F1				
							SAC010	H1		
	APS37				SPA169	F1	SAC010	H1		
							SAD035	H3		
					SPA108	F1				
							CVS02	H1		
					SPA169	F1	SAD035	H3	SUA511	J3
							SAG161	H1		
							SAC010	H1		
					SPA169	F1	SAC010	H1	SUA511	J3
					SPA108	F1				
							SAD035	H3		
							SAG161	H1		
							SAC010	H1		
									GA2044	J2
									SUA552	J3
					SPA169	F1	SAD035	H3	SUA511	J3
							SAC010	H1		
					SPA169	F1	SAC010	H1	BAE680E	SUA476
					SPA108	F1				
							SAD035	H3		
							SAD035	H3	SUA476	J2

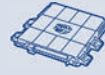
KW

TYPE

TYPE
RENAULT
RAPID Furgonato (F40_, G40_)

1.0	Petrol	27	07/89 → 08/91					
1.1 (F401)	Petrol	33	07/89 → 08/91					
1.1 (F40H)	Petrol	33	07/89 → 08/91					
1.2 (F406, G40A)	Petrol	40	09/91 → 03/98					
1.2 (F406, G40A)	Petrol	40	09/91 → 03/98	ENGINE: C3G				
1.4 (F407) Cat.	Petrol	43	08/88 → 03/98					
1.4 (F407) Cat.	Petrol	43	08/88 → 03/98					
1.4 (F407) Cat.	Petrol	43	09/91 → 03/98					
1.4 (F40D)	Petrol	58	01/94 → 03/98			B3354		B1
1.4 (F40M)	Petrol	44	03/86 → 08/91					
1.4 (F40M)	Petrol	44	07/89 → 08/91					
1.4 (F40U, F40V)	Petrol	55	09/91 → 03/98			B3354		B1
1.4 (F40U, F40V)	Petrol	55	09/91 → 03/98					
1.4 (F40U, F40V)	Petrol	55	09/91 → 03/98					
1.6 D (F404)	Diesel	40	07/89 → 03/97					
1.9 D (F40P, F40N, F40E)	Diesel	47	09/91 → 10/97					
1.9 D (F40R)	Diesel	40	09/94 → 03/98					

SAFRANE I (B54_)

2.0 (B540)	Petrol	77	11/92 → 07/96	ENGINE: (ES9J4-XU10J4RS)		CA0005504		B6
2.0 (B540)	Petrol	77	11/92 → 07/96					
2.0 12V (B542, B54E)	Petrol	97	04/92 → 07/96					
2.0 12V (B542, B54E)	Petrol	97	04/92 → 07/96					
2.2 (B541)	Petrol	79	04/92 → 07/96					
2.2 (B541)	Petrol	79	04/92 → 07/96					
2.2 (B543)	Petrol	101	04/92 → 07/96					
2.2 (B543)	Petrol	101	04/92 → 07/96					
3.0 Biturbo 4x4 (B545)	Petrol	193	02/93 → 07/96					
3.0 Biturbo 4x4 (B545)	Petrol	193	02/93 → 07/96					
3.0 V6 (B54B, B544)	Petrol	123	12/92 → 07/96					
3.0 V6 (B54B, B544)	Petrol	123	12/92 → 07/96					

SAFRANE II (B54_)

2.9 24V (B54N)	Petrol	140	03/99 → 12/00					
3.0 V6 (B54M)	Petrol	123	07/96 → 12/00					

SANDERO/STEPWAY

1.4	Petrol	55	02/09 →					
1.6	Petrol	62	11/10 →					
1.6	Petrol	75	12/07 →					
1.6	Petrol	76	12/07 →					

SCÉNIC I (JA0/1_)

1.4 16V (JA0D, JA1H, Ja0W, JA10)	Petrol	70	09/99 → 04/03					
1.4 16V (JA0D, JA1H, Ja0W, JA10)	Petrol	70	09/99 → 08/03					



TYPE

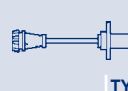

TYPE



TYPE

								SUA278	J3
								SUA278	J3
								SUA278	J3
	APS45		SPA160	F1		SAG158	H1	ESS0090A	J1
							BAE504L		
	APS45					SAG158	H1	ESS0130A	J1
								PI024	J1
								SUA266	J3
	APS45		SPA160	F1		SAD035	H3	ESS0090A	J1
								PI024	J1
								SUA278	J3
	APS45		SPA160	F1		SAD035	H3	ESS0090A	J1
						SAG163	H1	PI024	J1
								SUA266	J3
								SUA265	J3
								SUA265	J3
			SPA160	F1					
	APS45		SPA160	F1		SAG158	H1		
	APS45		ATS14	F2		SAD035	H3		
			SPA160	F1		SAG158	H1		
	APS45		ATS14	F2		SAD035	H3		
			SPA160	F1		SAG158	H1		
	APS45		ATS14	F2		SAD035	H3		
			SPA160	F1		SAG158	H1		
			SPA160	F1		SAD013	H3		
						SAG158	H1		
	APS45		ATS14	F2		SAD013	H3		
			SPA160	F1		SAG158	H1		
			SPA160	F1		SAG150	H1		
	APS45		SPA160	F1		SAG158	H1		
			SPA108	F1					
			SPA108	F1					
			SPA108	F1					
			SPA108	F1					
IWP142									
			SPA108	F1		SAD035	H3	BAE680E	



KW

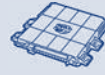

TYPE



TYPE

RENAULT

SCÉNIC I (JA0/1_)

1.4 16V (JA0D, JA1H, Ja0W, JA10)	Petrol	70	09/99 → 08/03					
1.6	Petrol	75	03/01 → 08/03					
1.8 16V (JA12, JA1R, JA1M, JA1A)	Petrol	85	01/01 → 08/03			B3390	B1	
1.8 16V (JA12, JA1R, JA1M, JA1A)	Petrol	85	01/01 → 08/03					
1.8 4x4	Petrol	85	07/00 → 04/01					
1.8 4x4	Petrol	85	07/00 → 04/01					
1.9 dCi (JA05, JA1F)	Diesel	75	09/99 → 08/03					
1.9 dCi (JA05, JA1F)	Diesel	75	10/00 → 08/03					
1.9 dCi RX4	Diesel	75	11/00 → 08/03					
1.9 dTi (JA0N)	Diesel	72	09/99 → 08/03					
1.9 dTi (JA1U)	Diesel	59	02/01 → 08/03					
2.0 16V	Petrol	103	09/99 → 08/03	ENGINE: F4R744		60XR32	B3	
2.0 16V	Petrol	103	09/99 → 08/03					
2.0 16V	Petrol	103	09/99 → 08/03					
2.0 16V (JA1B, JA1D)	Petrol	102	07/00 → 08/03					
2.0 16V (JA1B, JA1D)	Petrol	102	07/00 → 08/03					
2.0 16V RX4	Petrol	102	06/00 → 08/03	ENGINE: F4R744		60XR32	B3	
2.0 16V RX4	Petrol	102	06/00 → 08/03					
2.0 16V RX4	Petrol	102	06/00 → 08/03					

SCÉNIC II (JM0/1_)

1.4 (JM0B, JM0H, JM1A)	Petrol	72	06/03 → 01/05					
1.4 (JM0B, JM0H, JM1A)	Petrol	72	02/05 →					
1.4 (JM0B, JM0H, JM1A)	Petrol	72	06/03 →					
1.4 (JM0B, JM0H, JM1A)	Petrol	72	06/03 →					
1.5 dCi (JM02, JM13)	Diesel	74	11/03 →					
1.5 dCi (JM02, JM13)	Diesel	74	11/03 →					
1.5 dCi (JM02, JM13)	Diesel	74	11/03 → 01/05					
1.5 dCi (JM0F)	Diesel	60	06/03 → 12/06					
1.5 dCi (JM0F)	Diesel	60	06/03 →					
1.5 dCi (JM0F)	Diesel	60	06/03 → 01/05					
1.5 dCi (JM0F)	Diesel	60	06/03 →					
1.5 dCi (JM0F)	Diesel	60	06/03 →					
1.5 dCi (JM16)	Diesel	76	01/07 →					
1.5 dCi (JM16)	Diesel	76	01/07 →					
1.5 dCi (JM1E)	Diesel	78	05/05 →					
1.5 dCi (JM1E)	Diesel	78	06/06 →					
1.5 dCi (JM1F)	Diesel	63	05/05 → 12/06					
1.5 dCi (JM1F)	Diesel	63	05/05 →					
1.5 dCi (JM1F)	Diesel	63	05/05 →					
1.6 (JM0C, JM0J, JM1B)	Petrol	83	06/03 → 01/05					
1.6 (JM0C, JM0J, JM1B)	Petrol	83	02/05 →					



TYPE



TYPE



TYPE

						SAG159	H1		
				SPA108	F1				
				SPA108	F1	SAD035	H3		
						SAG140	H1		
				SPA108	F1	SAD035	H3		
						SAG140	H1		
	APS37			SPA169	F1	SAG131	H1		
								ESS535	J1
	APS37			SPA169	F1	SAG161	H1	ESS535	J1
				SPA169	F1	SAG131	H1		
				SPA169	F1	SAG161	H1		
				SPA108	F1	SAD035	H3	BAE680E	
						SAG140	H1		
	IWP042			SPA108	F1	SAD035	H3	BAE680E	
						SAG140	H1		
				SPA108	F1	SAD035	H3	BAE680E	
						SAG159	H1		
				SPA108	F1				
				SPA169	F1				
						SAD035	H3	BAE680E	
						SAG159	H1		
	APS51			SPA169	F1	SAC010	H1		
						SAD035	H3		
				SPA108	F1				
	APS51								
				SPA169	F1	SAC010	H1		
				SPA108	F1				
						SAD035	H3		
						SAG161	H1		
						SAC010	H1		
						SAD035	H3		
	APS51			SPA169	F1	SAD035	H3		
						SAC010	H1		
	APS51								
				SPA169	F1	SAC010	H1		
						SAD035	H3		
				SPA108	F1				
				SPA169	F1				



KW

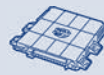

TYPE



TYPE

RENAULT

SCÉNIC II (JM0/1_)

1.6 (JM0C, JM0J, JM1B)	Petrol	83	06/03 →					
1.6 (JM0C, JM0J, JM1B)	Petrol	83	06/03 →					
1.6 (JM0C, JM0J, JM1B)	Petrol	83	06/03 →					
1.6 (JM0C, JM0J, JM1B)	Petrol	83	06/03 → 04/09					
1.6 16V (JM1R)	Petrol	82	01/07 →					
1.6 16V (JM1R)	Petrol	82	01/07 →					
1.6 16V (JM1R)	Petrol	82	01/07 →					
1.9 dCi (JM0G, JM12, JM1G, JM2C)	Diesel	88	06/03 →					
1.9 dCi (JM0G, JM12, JM1G, JM2C)	Diesel	88	06/03 → 01/05					
1.9 dCi (JM14)	Diesel	96	05/05 →					
1.9 dCi (JM15)	Diesel	81	05/05 →					
2.0 (JM05, JM0U, JM1N, JM1U, JM2V)	Petrol	99	06/03 →					
2.0 (JM05, JM0U, JM1N, JM1U, JM2V)	Petrol	99	11/07 →					
2.0 16V Turbo (JM0W)	Petrol	120	05/04 →	ENGINE: F4R-776				
2.0 16V Turbo (JM0W)	Petrol	120	05/04 →					
2.0 16V Turbo (JM0W)	Petrol	120	11/07 →					
2.0 dCi (JM1K)	Diesel	110	09/05 →					

SCÉNIC III (JZ0/1_)

1.4 16V (JZ0F)	Petrol	96	02/09 →					
1.5 dCi	Diesel	78	02/09 →					
1.9 dCi	Diesel	96	02/09 →					
2.0 16V (JZ0G, JZ1E)	Petrol	103	05/09 →					
2.0 16V (JZ0G, JZ1E)	Petrol	103	02/09 →					
2.0 dCi (JZ0L)	Diesel	118	04/09 →					
2.0 dCi (JZ0Y)	Diesel	110	02/09 →					

SPORT SPIDER (EF0_)

2.0 16V	Petrol	110	03/95 → 10/99					
---------	--------	-----	---------------	--	--	--	--	--

SUPER 5 (B/C40_)

1.0 (B/C400)	Petrol	30	10/84 → 10/88					
1.1 (B/C401)	Petrol	34	10/84 → 10/88					
1.1 (B/C401, B/C40H)	Petrol	33	07/89 → 08/90					
1.2 (B/C40F)	Petrol	40	07/89 → 08/90					
1.4 (B/C403)	Petrol	52	07/89 → 07/89					
1.4 (B/C40J)	Petrol	49	06/87 → 07/89					
1.4 (B/C40J)	Petrol	49	07/89 → 07/89					
1.4 (B/C40M)	Petrol	44	06/87 → 08/90					
1.4 (B/C40M)	Petrol	44	07/89 → 08/90					
1.6 D (B/C404)	Diesel	40	08/85 → 06/89					
1.6 D (B/C404)	Diesel	40	07/89 → 12/96					
1.7 (B/C408)	Petrol	54	10/86 → 03/95					



TYPE

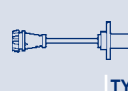

TYPE



TYPE

							SAC010	H1	BAE680E		
							SAD035	H3			
							SAG103	H1			
							SAG160	H1			
							SAC010	H1			
							SAD035	H3			
							SAG160	H1			
						SPA169	F1		SAG153	H1	
						SPA108	F1				
		APS67							SAG153	H1	
		APS67									
						SPA108	F1		SAD035	H3	BAE680E
						SPA147	F1				
		IWP098									
						SPA108	F1		SAD035	H3	BAE680E
						SPA147	F1				
		APS46							SAC077	H2	
									BAE680CP		GA2181 J2
							SAD035	H3			
							SAC077	H2			
									BAE680DA		
											GA2181 J2
							SAC077	H2			
							SAC077	H2			
							SAG158	H1			
									BK2A		
									BK2A		
										SUA278	J3
										SUA278	J3
										SUA278	J3
										PI024	J1
										SUA278	J3
										PI024	J1
										SUA278	J3
										SUA220	J3
										SUA265	J3
		APS45					SAG095	H1		ESS0144A	J1



KW



TYPE



TYPE

RENAULT

SUPER 5 (B/C40_)

1.7 (B/C40K, B/C40G)	Petrol	64	07/89 → 03/95					
1.7 i (C409)	Petrol	69	10/86 → 08/91					
1.7 i (C409)	Petrol	69	06/88 → 08/91					

SUPER 5 Furgonato (S40_)

1.1 (S401)	Petrol	34	07/89 → 12/96					
1.2 (S40F, S407)	Petrol	44	07/89 → 12/96					
1.6 D (S404)	Diesel	40	10/84 → 06/89					
1.6 D (S404)	Diesel	40	07/89 → 12/96					

THALIA I (LB0/1/2_)

1.2 16V	Petrol	55	04/02 →	ENGINE: D4F712			SMR00102Y	B3
1.2 16V	Petrol	55	04/02 →					
1.4	Petrol	55	08/00 →					
1.4	Petrol	55	08/00 →					
1.4 16V	Petrol	72	08/00 →					
1.5 dCi	Diesel	47	06/05 →					
1.5 dCi	Diesel	48	04/02 →					
1.5 dCi	Diesel	48	04/02 → 10/02					
1.5 dCi	Diesel	50	02/03 →					
1.5 dCi	Diesel	60	06/01 → 10/02					
1.5 dCi	Diesel	48	04/02 →					
1.5 dCi	Diesel	60	06/01 →					
1.5 dCi	Diesel	60	02/03 → 01/05					
1.5 dCi	Diesel	47	09/08 → 10/08					
1.5 dCi	Diesel	48	04/02 →					
1.5 dCi	Diesel	60	06/01 →					
1.6 16V	Petrol	79	04/02 →					

THALIA II (LU1/2_)

1.2 16V (LU2V)	Petrol	55	09/08 →					
1.5 dCi	Diesel	47	09/08 → 10/08					
1.5 dCi	Diesel	62	09/08 → 10/08					

TRAFIC Autobus (TXW)

1.7	Petrol	50	08/92 → 08/94					
1.9 D	Diesel	44	06/97 → 03/01					
2.2	Petrol	70	05/89 → 06/94					
2.2	Petrol	74	06/94 → 10/97					
2.2 4x4	Petrol	70	05/89 → 06/94					
2.2 4x4	Petrol	74	06/94 → 10/97					
2.5 D	Diesel	55	05/89 → 03/01					

TRAFIC Furgonato (TXX)

1.9 D	Diesel	44	06/97 → 03/01					
2.2 4x4	Petrol	70	05/89 → 06/94					
2.2 4x4	Petrol	74	06/94 → 10/97					

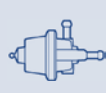

TYPE

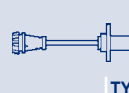

TYPE



TYPE

								SUA278	J3
	APS45					SAD035	H3	ESS0144A	J1
			SPA160	F1					
								SUA278	J3
								SUA278	J3
								SUA220	J3
								SUA265	J3
IWP099									
			SPA108	F1		SAG163	H1		
			SPA108	F1		SAD035	H3		
						SAG163	H1		
			SPA108	F1		SAG159	H1	BAE680E	
	APS37								
	APS37		SPA169	F1		SAC010	H1		
	APS34								
	APS37								
	APS34								
						SAD035	H3		
			SPA169	F1		SAC010	H1		
			SPA108	F1					
						SAC010	H1		
						SAG161	H1		
						SAG161	H1		
			SPA108	F1		SAG159	H1	BAE680E	
			SPA108	F1					
						SAC010	H1		
						SAC010	H1		
			SPA160	F1					
						SAG159	H1	SUA187	J3
	APS45		SPA160	F1					
	APS45		SPA160	F1		SAD035	H3		
	APS45		SPA160	F1					
	APS45		SPA160	F1					
								SUA187	J3
						SAG159	H1	SUA187	J3
	APS45		SPA160	F1				PI024	J1
	APS45		SPA160	F1		SAD035	H3		



KW



TYPE



TYPE

RENAULT

TRAFIC II Autobus (JL)

1.9 dCi 100 (JLOC)	Diesel	74	03/01 →						
1.9 dCi 100 (JLOC)	Diesel	74	03/01 → 01/05						
1.9 dCi 80 (JLOB)	Diesel	60	03/01 →						
1.9 dCi 80 (JLOB)	Diesel	60	03/01 → 01/05						
2.0 (JLOA)	Petrol	88	03/01 →						
2.0 16V	Petrol	86	08/06 →						
2.0 dCi 115 (JLOH)	Diesel	84	08/06 →						
2.0 dCi 115 (JLOH)	Diesel	84	08/06 →	ENGINE: M9R780,M9R782, M9R786,M9R692,M9R630					
2.0 dCi 90 (JLOH)	Diesel	66	08/06 →						
2.5 dCi 135 (JLOD)	Diesel	99	05/03 →						
2.5 dCi 135 (JLOD)	Diesel	99	05/03 → 01/05						
2.5 dCi 145 (JLOJ)	Diesel	107	08/06 →	ENGINE: G9U630					

TRAFIC II Furgonato (FL)

1.9 dCi 100 (FLOC)	Diesel	74	03/01 →						
1.9 dCi 100 (FLOC)	Diesel	74	03/01 → 01/05						
1.9 dCi 80 (FLOB)	Diesel	60	03/01 →						
1.9 dCi 80 (FLOB)	Diesel	60	03/01 → 01/05						
2.0 (FLOA)	Petrol	88	03/01 →						
2.0 16V	Petrol	86	08/06 →						
2.0 dCi 115 (FLO1, FLOU)	Diesel	84	08/06 →						
2.0 dCi 115 (FLO1, FLOU)	Diesel	84	08/06 →	ENGINE: M9R780,M9R782, M9R786,M9R692					
2.0 dCi 90 (FLOH)	Diesel	66	08/06 →						
2.0 dCi 90 (FLOH)	Diesel	66	08/06 →	ENGINE: M9R780,M9R782, M9R630					
2.5 dCi 135 (FLOD)	Diesel	99	05/03 →						
2.5 dCi 135 (FLOD)	Diesel	99	05/03 → 01/05						
2.5 dCi 145 (FLOJ)	Diesel	107	08/06 →	ENGINE: G9U630					
2.5 DTi	Diesel	99	03/03 → 07/03						

TRAFIC II Pianale piatto/Telaio (EL)

1.9 dCi 100 (EL0C)	Diesel	74	03/01 →						
1.9 dCi 100 (EL0C)	Diesel	74	09/01 → 01/05						
1.9 dCi 80 (EL0B)	Diesel	60	03/01 →						
1.9 dCi 80 (EL0B)	Diesel	60	08/03 → 01/05						
2.0 (ELOA)	Petrol	88	09/01 → 07/06						
2.0 (ELOA)	Petrol	88	03/01 →						
2.0 dCi 115 (EL0H)	Diesel	84	08/06 →						
2.0 dCi 115 (EL0H)	Diesel	84	08/06 →	ENGINE: M9R780,M9R782, M9R786					
2.0 dCi 90 (EL0H)	Diesel	66	08/06 →						
2.0 dCi 90 (EL0H)	Diesel	66	08/06 →	ENGINE: M9R780,M9R782					
2.5 dCi 135 (EL0D)	Diesel	99	03/03 → 01/05						
2.5 dCi 135 (EL0D)	Diesel	99	03/01 →						



TYPE



TYPE



TYPE

	APS37		SPA169	F1		SAG153	H1		
			SPA108	F1					
	APS37		SPA169	F1		SAG153	H1		
			SPA108	F1					
			SPA108	F1		SAD035	H3		
IWP042			SPA108	F1		SAD035	H3		
						SAC077	H2		
						CVS02	H1		
						SAC077	H2		
	APS23		SPA169	F1		SAG153	H1		
			SPA108	F1					
						CVS02	H1		
	APS37		SPA169	F1		SAG153	H1		
			SPA108	F1					
	APS37		SPA169	F1		SAG153	H1		
			SPA108	F1					
			SPA108	F1		SAD035	H3	BAE680E	
IWP042			SPA108	F1		SAD035	H3		
						SAC077	H2		
						CVS02	H1		
						SAC077	H2		
						CVS02	H1		
	APS23		SPA169	F1		SAG153	H1		
			SPA108	F1					
						CVS02	H1		
			SPA108	F1					
	APS37					SAG153	H1		
			SPA108	F1					
	APS37					SAG153	H1		
			SPA108	F1					
			SPA108	F1					
						SAD035	H3	BAE680E	
						SAC077	H2		
						CVS02	H1		
						SAC077	H2		
						CVS02	H1		
			SPA108	F1					
						SAG153	H1		

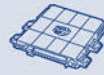
KW

TYPE

TYPE
RENAULT
TRAFIC II Pianale piatto/Telaio (EL)

2.5 dCi 145 (EL0J) Diesel 107 08/06 → ENGINE: G9U630

TRAFIC Pianale piatto/Telaio (PXX)

1.7 Petrol 50 05/89 → 08/94

2.0 [RWD] Petrol 59 05/89 → 10/97

2.2 Petrol 74 09/94 → 04/98

2.2 4x4 Petrol 74 09/94 → 04/98

2.5 D Diesel 51 05/89 → 03/01

TWINGO I (C06_)

1.2 (C063, C064) Petrol 40 03/93 → 10/96

B03 B1

1.2 (C063, C064) Petrol 40 03/93 → 10/96

KITPF2C B6

1.2 (C063, C064) Petrol 40 03/93 → 10/96 ENGINE: D4F-D7F

1.2 (C066, C068) Petrol 43 05/96 → 01/00 ENGINE: D4F

1.2 (C067) Petrol 40 05/96 → 01/00 ENGINE: D4F

1.2 16V (C060) Petrol 44 08/04 → ENGINE: D4F708

SMR00102Y B3

1.2 16V (C060) Petrol 44 12/05 → 05/07 ENGINE: D4F708

36SXR31 B3

1.2 16V (C060) Petrol 44 08/04 →

1.2 16V (C060) Petrol 44 08/04 →

1.2 16V (C06C, C06D, C06K) Petrol 55 01/01 → ENGINE: D4F702

SMR00102Y B3

1.2 16V (C06C, C06D, C06K) Petrol 55 02/04 → ENGINE: D4F702

36SXR31 B3

1.2 16V (C06C, C06D, C06K) Petrol 55 01/01 →

1.2 16V (C06C, C06D, C06K) Petrol 55 01/01 →

TWINGO I Furgonato (S06_)

1.2 (S063, S064) Petrol 40 03/93 → 05/96

B03 B1

1.2 (S063, S064) Petrol 40 03/93 → 05/96

1.2 (S063, S064) Petrol 40 03/93 → 05/96 ENGINE: D4F-D7F

1.2 (S063, S064) Petrol 40 10/93 → 05/96

1.2 (S066, S068) Petrol 43 05/96 →

B23/00 B1

1.2 (S066, S068) Petrol 43 05/96 → 12/99

1.2 (S066, S068) Petrol 43 03/97 →

1.2 (S066, S068) Petrol 43 05/96 → 12/96

TWINGO II (CN0_)

1.2 (CN0D) Petrol 43 03/07 →

1.2 (CN0D) Petrol 43 03/07 → 04/09

1.2 (CN0D) Petrol 43 03/07 → ENGINE: D7F800

1.2 16V (CN04, CN0A, CN0B) Petrol 55 03/07 → 06/07

1.2 16V (CN0K, CN0V) Petrol 56 03/07 →

1.2 Turbo (CN0C, CN0F) Petrol 74 03/07 →

1.5 dCi (CN0E) Diesel 47 03/07 →

1.5 dCi (CN0E) Diesel 47 03/07 → ENGINE: K9K740

1.5 dCi (CN0E) Diesel 47 03/07 → 10/08

1.5 dCi (CN0U) Diesel 62 04/08 →

1.6 RS (CN0N, CN0R, CN0S) Petrol 98 05/08 →

1.6 RS (CN0N, CN0R, CN0S) Petrol 98 05/08 → 02/09

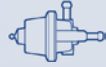

TYPE



TYPE



TYPE

						CVS02	H1			
				SPA160	F1					
				SPA160	F1					
						SAD035	H3			
						SAD035	H3			
									SUA187	J3
	APS45		KITATS05	F2		SAG158	H1	BAE504L	ESS0090A	J1
			SPA160	F1					SUA149	J2
									GA2011	J2
									GA2007	J2
									GA2007	J2
						SAD035	H3			
						SAG163	H1			
IWP099										
			SPA108	F1		SAD035	H3	BAE680CU		
						SAG163	H1			
	APS45		SPA160	F1					ESS0090A	J1
									SUA390	J2
									GA2011	J2
									SUA149	J2
									SUA417	J2
	APS45									
			SPA108	F1						
									SUA390	J2
			SPA147	F1		SAD035	H3			
			SPA108	F1						
						CVS02	H1			
			SPA108	F1						
			SPA147	F1		SAD035	H3	BAE680CU	GA2179	J2
			SPA147	F1		SAD035	H3			
	APS37					SAD035	H3		SUA563	J3
						CVS02	H1			
						SAC010	H1			
						SAD035	H3			
						SAD035	H3			
						SAC010	H1			



KW



TYPE



TYPE

RENAULT

VEL SATIS (BJ0_)

2.0 16 V Turbo	Petrol	125	04/04 →						
2.0 16V Turbo (BJ0K)	Petrol	120	06/02 → 08/03						
2.0 16V Turbo (BJ0K)	Petrol	120	06/02 →						
2.0 dCi (BJ03)	Diesel	110	08/05 →						
2.0 dCi (BJ03, BJ0B)	Diesel	127	01/06 →						
2.0 Turbo	Petrol	108	04/05 →						
2.2 dCi	Diesel	83	12/04 → 01/05						
2.2 dCi (BJ0E, BJ0F)	Diesel	110	06/02 →						
2.2 dCi (BJ0E, BJ0F)	Diesel	110	06/02 → 01/05						
2.2 dCi (BJ0E, BJ0F, BJ0G, BJ0H)	Diesel	102	09/04 → 01/05						
2.2 dCi (BJ0E, BJ0F, BJ0G, BJ0H)	Diesel	102	09/04 →						
2.2 dCi (BJ0H)	Diesel	85	04/04 → 01/05						
3.0 dCi (BJ0J, BJ0N)	Diesel	130	06/02 →						
3.5 V6 (BJ0R, BJ0V, BJ0U)	Petrol	177	06/02 →						

ROLLS-ROYCE

GHOST

6.6 V12	Petrol	420	12/09 →						
---------	--------	-----	---------	--	--	--	--	--	--

PHANTOM

6.75	Petrol	338	03/03 →						
------	--------	-----	---------	--	--	--	--	--	--

PHANTOM Coupé

6.75 V12	Petrol	338	09/08 →						
----------	--------	-----	---------	--	--	--	--	--	--

PHANTOM Drophead Coupe

6.75 V12	Petrol	338	06/07 →						
----------	--------	-----	---------	--	--	--	--	--	--

ROVER

100 / METRO (XP)

114 GSi	Petrol	76	10/94 → 10/95						
114 GTI 16V	Petrol	76	08/91 → 12/98						
114 GTI/GT 16V Cat.	Petrol	66	03/90 → 12/98						

100 Cabriolet (XP)

114	Petrol	75	03/97 → 10/98						
-----	--------	----	---------------	--	--	--	--	--	--

200 (RF)

211	Petrol	44	01/98 → 03/00	CHASSIS: YD471565 →					
214 i	Petrol	55	11/95 → 03/00	CHASSIS: YD471565 →					
214 i	Petrol	55	01/97 → 03/00						
214 Si	Petrol	76	11/95 → 03/00	CHASSIS: YD471565 →					
214 Si	Petrol	76	11/95 → 03/00						
214 Si	Petrol	76	01/97 → 03/00						
216 Si	Petrol	82	11/95 → 03/00	CHASSIS: YD471565 →					
216 Si	Petrol	82	11/95 → 03/00						
216 Si	Petrol	82	01/97 → 03/00						

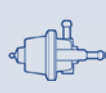

TYPE

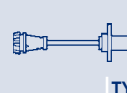

TYPE



TYPE

				SPA108	F1		SAD035	H3	BAE680E		
	APS28										
				SPA108	F1		SAD035	H3	BAE680E		
	APS46										
	APS46						SAC077	H2			
				SPA108	F1						
				SPA108	F1						
	APS23			SPA169	F1		SAG153	H1			
				SPA108	F1						
				SPA108	F1						
							SAG153	H1			
				SPA108	F1						
				SPA115	F1						
				SGA116	F3						
									BAE680BR		
									BAE680AH		
									BAE680AH		
									BAE680AH		
									BAE680AH		
							SAG091	H1		ESS0014A	J1
										ESS0014A	J1
										ESS0014A	J1
							SAG091	H1		ESS0014A	J1
				SGA113	F3						
				SGA113	F3						
										SUA421	J2
				SGA113	F3						
										ESS0092A	J1
										SUA421	J2
				SGA113	F3						
										ESS0092A	J1
										SUA421	J2

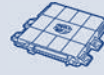
KW

TYPE

TYPE
ROVER
200 (RF)

218 K Vi	Petrol	107	11/95 → 03/00	CHASSIS: YD471565 →				
218 K Vi	Petrol	107	11/95 → 03/00					
218 K Vi	Petrol	107	01/97 → 03/00					
220 D/SD	Diesel	63	11/95 → 03/00					
220 SDi	Diesel	77	11/95 → 03/00					

2000-3500 2 volumi /Coda spiovente (SD1)

3500 Vitesse	Petrol	142	10/82 → 10/86					
--------------	--------	-----	---------------	--	--	--	--	--

25 (RF)

1.4 16V	Petrol	62	10/99 → 05/05	CHASSIS: YD471565 →				
1.4 16V	Petrol	76	10/99 → 05/05	CHASSIS: YD471565 →				
1.6 16V	Petrol	80	10/99 → 05/05	CHASSIS: YD471565 →				
1.8 16V	Petrol	107	02/00 → 05/05	CHASSIS: YD471565 →				
1.8 16V	Petrol	85	10/99 → 05/05	CHASSIS: YD471565 →				
2.0 iDT	Diesel	74	10/99 → 05/05					

400 2 volumi /Coda spiovente (RT)

414 Si	Petrol	76	05/95 → 03/00	CHASSIS: YD471064 →				
414 Si	Petrol	76	05/95 → 03/00	CHASSIS: → YD471063				
416 Si	Petrol	83	06/95 → 03/00					
416 Si	Petrol	82	05/95 → 03/00					
416 Si	Petrol	82	05/95 → 03/00	CHASSIS: → YD471063				
420 D	Diesel	63	11/95 → 03/00					
420 Di	Diesel	77	05/95 → 03/00					
420 Di	Diesel	77	10/95 → 03/00					

400 Tourer (XW)

1.6 i	Petrol	82	05/94 → 11/98					
2.0 i	Petrol	100	10/95 → 11/98					
2.0 i	Petrol	100	01/97 → 11/98					

45 (RT)

1.4	Petrol	76	02/00 → 05/05					
1.4	Petrol	76	02/00 → 05/05	CHASSIS: → YD471063				
1.6	Petrol	80	02/00 → 05/05					
1.6	Petrol	80	02/00 → 05/05	CHASSIS: → YD471063				
1.8	Petrol	86	02/00 → 05/05					
2.0 iDT	Diesel	74	02/00 → 05/05					
2.0 V6	Petrol	110	02/00 → 05/05	CHASSIS: YD476900 →				

45 Tre volumi (RT)

1.4	Petrol	76	02/00 → 05/05					
1.4	Petrol	76	02/00 → 05/05	CHASSIS: → YD471063				
1.6	Petrol	80	02/00 → 05/05					
1.6	Petrol	80	02/00 → 05/05	CHASSIS: → YD471063				
1.8	Petrol	86	02/00 → 05/05					
2.0 iDT	Diesel	74	02/00 → 05/05					
2.0 V6	Petrol	110	02/00 → 05/05	CHASSIS: YD476900 →				



TYPE

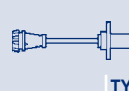

TYPE



TYPE

				SGA113	F3								
												ESS0092A	J1
												SUA421	J2
								SAG081	H1				
				SPA104	F1			SAG081	H1				
												PI024	J1
				SGA113	F3								
				SGA113	F3								
				SGA113	F3								
				SGA113	F3								
				SGA113	F3								
								SAG081	H1				
				SGA113	F3								
				SGA113	F3			SAG091	H1				
	APS73			SPA155	F1								
				SGA113	F3								
								SAG091	H1				
								SAG081	H1				
				SPA104	F1			SAG091	H1				
								SAG081	H1				
				SGA114	F3							BAE680CV	
												SUA422	J2
				SGA113	F3								
								SAG091	H1				
				SGA113	F3								
								SAG091	H1				
				SGA113	F3								
								SAG081	H1				
								SAG144	H1				
				SGA113	F3								
								SAG091	H1				
				SGA113	F3								
								SAG091	H1				
				SGA113	F3								
								SAG081	H1				
								SAG144	H1				



KW



TYPE



TYPE

ROVER

600 (RH)

620 i	Petrol	85	08/93 → 06/96						
620 Sdi	Diesel	77	12/94 → 02/99						
620 Sdi	Diesel	77	03/95 → 02/99						
620 Si	Petrol	96	08/93 → 02/99						
620 Ti Vitesse	Petrol	147	07/94 → 12/98	CHASSIS: BM246797 →					
623 Si	Petrol	116	08/93 → 02/99						

75 (RJ)

1.8	Petrol	88	02/99 → 05/05						
1.8 Turbo	Petrol	110	05/03 → 05/05						
2.0 CDT	Diesel	85	02/99 → 05/05						
2.0 CDT	Diesel	85	02/99 → 05/05						
2.0 CDTi	Diesel	96	02/03 → 05/05						
2.0 V6	Petrol	110	02/99 → 05/05						
2.5 V6	Petrol	129	02/99 → 10/01						
2.5 V6	Petrol	130	10/01 → 05/05						

75 Tourer (RJ)

1.8	Petrol	88	08/01 → 05/05						
1.8 Turbo	Petrol	110	05/03 → 05/05						
2.0 CDT	Diesel	85	08/01 → 05/05						
2.0 CDT	Diesel	85	08/01 → 05/05						
2.0 CDTi	Diesel	96	02/03 → 05/05						
2.0 V6	Petrol	110	08/01 → 05/05						
2.5 V6	Petrol	130	08/01 → 05/05						

800 (XS)

820 16 V I/SI (XS)	Petrol	103	10/86 → 10/88						
820 16V Turbo (RS)	Petrol	132	01/96 → 01/99	CHASSIS: 230967 →					
820 I/SI (RS)	Petrol	100	01/96 → 01/96	CHASSIS: 230967 →					
820 I/SI (RS)	Petrol	100	01/92 → 02/99						
820 SI (XS)	Petrol	98	10/88 → 12/91						
820 Sport	Petrol	145	01/96 → 03/96	CHASSIS: 230967 →					
820e	Petrol	88	10/86 → 10/91						
825 D/SD (XS)	Diesel	87	01/96 → 02/99						
825 SI/Sterling (XS)	Petrol	127	01/87 → 12/91						
825 SI/Sterling (XS) Cat.	Petrol	110	10/86 → 12/91						
827 SI/Sterling (XS)	Petrol	130	02/88 → 12/91						
827 SI/Sterling (XS) Cat.	Petrol	124	02/88 → 02/99						

800 2 volumi /Coda spiovente (XS)

820 16V Turbo (RS)	Petrol	132	01/96 → 01/99	CHASSIS: 230967 →					
820 I/SI (XS)	Petrol	100	01/96 → 02/99	CHASSIS: 230967 →					
820 I/SI (XS)	Petrol	100	01/93 → 02/99						
820 I/SI (XS)	Petrol	103	10/88 → 12/91						
820 SI (XS)	Petrol	98	10/88 → 12/91						
820 Sport	Petrol	145	01/96 → 03/96	CHASSIS: 230967 →					
825 D/SD (XS)	Diesel	87	01/96 → 02/99						

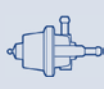

TYPE

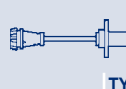

TYPE



TYPE

			SPA155	F1	SAA109				
			SPA104	F1					
						SAG081	H1		
			SPA155	F1	SAA109				
								BAE680CV	
			SPA155	F1	SAA106				
			SGA113	F3					
	APS61		SGA113	F3		SAG144	H1		
	APS30		ATS15	F2				PI025	J1
			SGA113	F3					
	APS30		SGA113	F3					
			SGA113	F3					
			SGA113	F3					
			SGA113	F3					
			SGA113	F3					
			SGA113	F3					
	APS61		SGA113	F3		SAG144	H1		
	APS30		ATS15	F2				PI025	J1
			SGA113	F3					
	APS30		SGA113	F3					
			SGA113	F3					
			SGA113	F3					
								ESS0039A	J1
								BAE680CV	
								BAE680CV	
								ESS0039A	J1
								ESS0039A	J1
								BAE680CV	
								ESS0039A	J1
			SPA164	F1					
								ESS0039A	J1
								ESS0039A	J1
								ESS0039A	J1
					SAA106			ESS0039A	J1
								BAE680CV	
								BAE680CV	
								ESS0039A	J1
								ESS0039A	J1
								ESS0039A	J1
								BAE680CV	
			SPA164	F1					



KW



TYPE



TYPE

ROVER

800 2 volumi /Coda spiovente (XS)

827 24V I/Sl (RS) Cat.	Petrol	124	01/92 → 02/99					
827 Vitesse (XS) Cat.	Petrol	124	10/88 → 12/91					
827 Vitesse/SLI	Petrol	130	10/88 → 12/91					

800 Coupé

825 SD	Diesel	87	01/96 → 02/99					
827 24V (RS)	Petrol	124	08/92 → 02/99					

COUPE

1.8 16 V	Petrol	107	03/96 → 11/99					
----------	--------	-----	---------------	--	--	--	--	--

MINI

1300	Petrol	46	01/92 → 11/00	CHASSIS: BD134455 →				
1300	Petrol	37	04/92 → 10/96	CHASSIS: BD134455 →				
1300	Petrol	37	10/92 → 09/00	CHASSIS: BD134455 →				
1300	Petrol	39	01/92 → 04/95	CHASSIS: BD134455 →				
1300	Petrol	39	05/96 → 10/96	CHASSIS: BD134455 →				
1300	Petrol	45	01/91 → 12/91	CHASSIS: BD134455 →				
1300	Petrol	46	01/92 → 09/00	CHASSIS: BD134455 →				
1300	Petrol	46	10/96 → 09/00	CHASSIS: BD134455 →				
1300 / Cooper	Petrol	45	06/91 → 02/94	CHASSIS: BD134455 →				

MINI Cabriolet (XN)

1300	Petrol	46	09/92 → 04/95	CHASSIS: BD134455 →				
1.3	Petrol	63	11/96 → 05/01	CHASSIS: BD134455 →				
1.3 S	Petrol	46	02/98 → 05/01	CHASSIS: BD134455 →				
1.3 S	Petrol	46	02/98 → 09/00	CHASSIS: BD134455 →				

STREETWISE

2.0 TD	Diesel	74	08/03 → 05/05					
--------	--------	----	---------------	--	--	--	--	--

SAAB

900 I (AC4, AM4)

2.0 i	Petrol	81	09/85 → 08/90			SVF009	B6
-------	--------	----	---------------	--	--	--------	----

900 I Cabriolet

2.0 -16	Petrol	93	01/90 → 08/93			SVF009	B6
2.0 -16	Petrol	93	01/90 → 06/94				
2.0 S Turbo-16	Petrol	104	09/91 → 08/93			SVF009	B6
2.0 Turbo-16	Petrol	118	09/90 → 08/93			SVF009	B6

900 I Combi Coupe

2.0 -16	Petrol	93	01/89 → 08/92			SVF009	B6
2.0 i	Petrol	81	09/85 → 08/90			SVF009	B6
2.0 S Turbo-16	Petrol	104	09/91 → 07/93			SVF009	B6
2.0 Turbo-16	Petrol	118	11/85 → 08/89			SVF009	B6
2.0 Turbo-16 S	Petrol	129	02/84 → 12/88			SVF009	B6
2.1 -16	Petrol	100	09/90 → 07/93			SVF015	B6

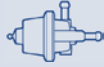

TYPE



TYPE



TYPE

SAA106

SAA106

ESS0039A

J1

ESS0039A

J1

SPA164

F1

SAA106

SAG091

H1

SGA114

F3

BAE680CV

BAE680CV

BAE680CV

BAE680CV

BAE680CV

BAE680CV

BAE680CV

BAE680CV

SGA114

F3

BAE680CV

SAG091

H1

SAG091

H1

BAE680CV

SAG081

H1

ESS0084A

J1

ESS0084A

J1

ESS0083A

J1



KW



TYPE



TYPE

SAAB

900 II

2.0 -16 Turbo	Petrol	136	07/93 → 08/96				SVF015	B6
2.0 -16 Turbo	Petrol	136	09/96 → 02/98				SVF016	B6
2.0 -16 Turbo	Petrol	136	07/93 → 02/98					
2.0 -16 Turbo	Petrol	136	09/93 → 08/95					
2.0 -16 Turbo	Petrol	136	09/95 → 02/98					
2.0 -16 Turbo	Petrol	136	07/93 → 08/95					
2.0 i	Petrol	96	08/94 → 08/96				SVF015	B6
2.0 i	Petrol	96	09/96 → 02/98				SVF016	B6
2.0 i	Petrol	98	07/93 → 07/94				SVF015	B6
2.0 i	Petrol	96	08/94 → 08/95					
2.0 i	Petrol	96	09/95 → 02/98					
2.0 i	Petrol	98	09/93 → 07/94					
2.0 i	Petrol	96	08/94 → 02/98					
2.3 -16	Petrol	110	07/93 → 08/96				SVF015	B6
2.3 -16	Petrol	110	09/96 → 02/98				SVF016	B6
2.3 -16	Petrol	110	09/93 → 08/95					
2.3 -16	Petrol	110	09/95 → 02/98					
2.3 -16	Petrol	110	07/93 → 02/98					
2.3 -16	Petrol	110	07/93 → 08/95					
2.5 -24 V6	Petrol	125	07/93 → 08/97				SVF015	B6
2.5 -24 V6	Petrol	125	07/93 → 08/94	ENGINE: 55899 →				
2.5 -24 V6	Petrol	125	07/93 → 02/98					

900 II Cabriolet

2.0 -16 Turbo	Petrol	136	12/93 → 08/96				SVF015	B6
2.0 -16 Turbo	Petrol	136	09/96 → 02/98				SVF016	B6
2.0 -16 Turbo	Petrol	136	12/93 → 02/98					
2.0 -16 Turbo	Petrol	136	03/94 → 08/95					
2.0 -16 Turbo	Petrol	136	09/95 → 02/98					
2.0 -16 Turbo	Petrol	136	12/93 → 08/95					
2.0 i	Petrol	96	12/93 → 08/96				SVF015	B6
2.0 i	Petrol	96	09/96 → 02/98				SVF016	B6
2.0 i	Petrol	96	09/94 → 08/95					
2.0 i	Petrol	96	09/95 → 02/98					
2.0 i	Petrol	96	12/93 → 02/98					
2.0 i	Petrol	96	12/93 → 08/95					
2.3 -16	Petrol	110	12/93 → 08/96				SVF015	B6
2.3 -16	Petrol	110	09/96 → 02/98				SVF016	B6
2.3 -16	Petrol	110	03/94 → 08/95					
2.3 -16	Petrol	110	09/95 → 02/98					
2.3 -16	Petrol	110	12/93 → 02/98					
2.3 -16	Petrol	110	12/93 → 08/95					
2.5 -24 V6	Petrol	125	12/93 → 08/97				SVF015	B6
2.5 -24 V6	Petrol	125	12/93 → 08/94	ENGINE: 55899 →				
2.5 -24 V6	Petrol	125	12/93 → 02/98					



TYPE

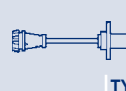

TYPE



TYPE

		APS41								ESS0084A J1
			SPA124	F1						
			SPA103	F1		SAG078	H1			
						SAG093	H1			
						SAG093	H1			
			SPA124	F1		SAG093	H1			
			SPA103	F1		SAG078	H1			
			SPA124	F1						
						SAD028	H3		ESS0084A	J1
			SPA124	F1						
			SPA103	F1		SAG078	H1			
						SAD028	H3		ESS0084A	J1
						SAG093	H1			
						SAC025	H2			
									ESS0084A	J1
		APS41								ESS0084A J1
			SPA124	F1						
			SPA103	F1		SAG078	H1			
						SAG093	H1			
			SPA124	F1						
			SPA103	F1		SAG078	H1			
						SAD028	H3		ESS0084A	J1
						SAG093	H1			
			SPA124	F1						
			SPA103	F1		SAG078	H1			
						SAD028	H3		ESS0084A	J1
						SAG093	H1			
						SAC025	H2			
									ESS0084A	J1



KW



TYPE



TYPE

SAAB

900 II Coupé

2.0 i	Petrol	98	12/93 → 07/94				SVF015	B6
2.0 i	Petrol	98	12/93 → 07/94					

9000

2.0 -16 CD	Petrol	110	09/96 → 12/98				SVF016	B6
2.0 -16 CD	Petrol	96	09/93 → 08/96				SVF015	B6
2.0 -16 CD	Petrol	96	09/96 → 12/98				SVF016	B6
2.0 -16 CD	Petrol	96	09/93 → 12/98					
2.0 -16 CD	Petrol	110	09/93 → 12/98					
2.0 -16 Turbo	Petrol	118	05/88 → 08/90				SVF009	B6
2.0 -16 Turbo	Petrol	118	05/88 → 08/93					
2.0 -16 Turbo CD	Petrol	108	09/96 → 12/98				SVF016	B6
2.0 -16 Turbo CD	Petrol	120	09/88 → 08/90				SVF009	B6
2.0 -16 Turbo CD	Petrol	136	09/89 → 08/90				SVF009	B6
2.0 -16 Turbo CD	Petrol	136	09/90 → 08/92				SVF015	B6
2.0 -16 Turbo CD	Petrol	108	09/92 → 12/98					
2.0 -16 Turbo CD	Petrol	108	09/93 → 12/98					
2.0 -16 Turbo CD	Petrol	120	09/88 → 08/93					
2.0 -16 Turbo CD	Petrol	136	09/89 → 12/98					
2.3 -16 CD	Petrol	107	09/91 → 08/93				SVF015	B6
2.3 -16 CD	Petrol	107	08/89 → 12/98					
2.3 -16 CD	Petrol	107	01/90 → 12/98					
2.3 -16 CD Turbo	Petrol	147	09/93 → 08/96				SVF015	B6
2.3 -16 CD Turbo	Petrol	147	09/96 → 12/98				SVF016	B6
2.3 -16 CD Turbo	Petrol	147	07/90 → 12/98					
2.3 -16 CD Turbo	Petrol	147	07/90 → 12/98					
2.3 -16 CD Turbo	Petrol	147	09/93 → 12/98					
2.3 -16 CDE	Petrol	108	09/93 → 08/96				SVF015	B6
2.3 -16 CDE	Petrol	108	09/96 → 12/98				SVF016	B6
2.3 -16 CDE	Petrol	108	09/93 → 12/98					
2.3 -16 CDE Eco-Power	Petrol	125	09/93 → 08/96				SVF015	B6
2.3 -16 CDE Eco-Power	Petrol	125	09/96 → 12/98				SVF016	B6
2.3 -16 CDE Eco-Power	Petrol	125	09/93 → 12/98					
2.3 -16 Turbo	Petrol	143	09/90 → 08/93				SVF015	B6
2.3 -16 Turbo	Petrol	143	09/90 → 08/93					
3.0 -24 V6 CD/CDE	Petrol	155	07/94 → 12/98					

9000 2 volumi /Coda spiovente

2.0 -16	Petrol	92	08/86 → 12/88				SVF009	B6
2.0 -16	Petrol	94	12/85 → 08/88				SVF009	B6
2.0 -16	Petrol	92	12/85 → 12/88					
2.0 -16 CS	Petrol	94	09/89 → 08/90				SVF009	B6
2.0 -16 CS	Petrol	94	09/90 → 08/93				SVF015	B6
2.0 -16 CS	Petrol	96	09/93 → 08/96				SVF015	B6
2.0 -16 CS	Petrol	96	09/96 → 12/98				SVF016	B6
2.0 -16 CS	Petrol	96	09/93 → 12/98					

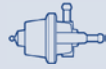

TYPE



TYPE



TYPE

			SPA124	F1		SAD028	H3	ESS0084A	J1
						SAG093	H1		
	APS41		SPA104	F1		SAG093	H1	ESS0084A	J1
			SPA104	F1		SAG093	H1	ESS0084A	J1
			SPA104	F1					
	APS41		SPA104	F1				ESS0084A	J1
			SPA124	F1		SAG093	H1		
			SPA104	F1					
			SPA104	F1					
	APS41		SPA104	F1					
			SPA104	F1					
	APS41		SPA104	F1				ESS0084A	J1
								SUA444	J2
			SPA124	F1		SAG093	H1		
	APS41		SPA104	F1		SAG093	H1	ESS0084A	J1
	APS41		SPA104	F1		SAG093	H1	ESS0084A	J1
								SUA444	J2
								ESS0084A	J1
			SPA104	F1					
			SPA104	F1					
	APS41		SPA104	F1		SAG093	H1	ESS0084A	J1



KW

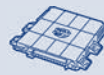

TYPE



TYPE

SAAB

9000 2 volumi /Coda spiovente

2.0 -16 CS	Petrol	94	01/89 → 12/98						
2.0 -16 ND Turbo	Petrol	110	09/96 → 12/98				SVF016	B6	
2.0 -16 ND Turbo	Petrol	110	09/93 → 12/98						
2.0 -16 Turbo	Petrol	118	01/90 → 08/90				SVF009	B6	
2.0 -16 Turbo	Petrol	118	09/90 → 08/93				SVF015	B6	
2.0 -16 Turbo	Petrol	120	05/88 → 08/90				SVF009	B6	
2.0 -16 Turbo	Petrol	129	09/84 → 08/90				SVF009	B6	
2.0 -16 Turbo	Petrol	118	09/84 → 08/93						
2.0 -16 Turbo	Petrol	120	05/88 → 08/93						
2.0 -16 Turbo	Petrol	129	09/84 → 12/91						
2.0 -16 Turbo CS	Petrol	136	09/88 → 08/90				SVF009	B6	
2.0 -16 Turbo CS	Petrol	136	09/90 → 08/92				SVF015	B6	
2.0 -16 Turbo CS	Petrol	136	09/88 → 12/98						
2.3 -16 Aero CS	Petrol	162	09/96 → 12/98				SVF016	B6	
2.3 -16 Aero CS	Petrol	165	09/96 → 12/98				SVF016	B6	
2.3 -16 Aero CS	Petrol	162	02/93 → 12/98						
2.3 -16 Aero CS	Petrol	165	02/93 → 12/98						
2.3 -16 CS	Petrol	107	09/89 → 08/90				SVF009	B6	
2.3 -16 CS	Petrol	107	09/90 → 08/93				SVF015	B6	
2.3 -16 CS	Petrol	107	09/89 → 12/98						
2.3 -16 CS	Petrol	107	01/90 → 12/98						
2.3 -16 CS	Petrol	107	07/90 → 12/98						
2.3 -16 CSE	Petrol	108	09/93 → 08/96				SVF015	B6	
2.3 -16 CSE	Petrol	108	09/96 → 12/98				SVF016	B6	
2.3 -16 CSE	Petrol	108	09/93 → 12/98						
2.3 -16 CSE Eco Power	Petrol	125	09/93 → 08/96				SVF015	B6	
2.3 -16 CSE Eco Power	Petrol	125	09/96 → 12/98				SVF016	B6	
2.3 -16 CSE Eco Power	Petrol	125	09/93 → 12/98						
2.3 -16 Turbo	Petrol	143	09/90 → 08/93				SVF015	B6	
2.3 -16 Turbo	Petrol	143	09/90 → 12/98						
2.3 -16 Turbo	Petrol	143	09/90 → 12/98						
2.3 -16 Turbo CSE	Petrol	147	09/93 → 08/96				SVF015	B6	
2.3 -16 Turbo CSE	Petrol	147	09/96 → 12/98				SVF016	B6	
2.3 -16 Turbo CSE	Petrol	147	09/93 → 12/98						
3.0 -24 V6 CS/CSE	Petrol	155	07/94 → 12/98						

9-3 (YS3D)

2.0 i	Petrol	96	02/98 → 08/00				SVF016	B6	
2.0 i	Petrol	96	02/98 → 09/02						
2.0 i	Petrol	96	02/98 → 09/02						
2.0 SE Turbo	Petrol	147	09/98 → 08/00				SVF016	B6	
2.0 SE Turbo	Petrol	147	02/98 → 09/02						
2.0 Turbo	Petrol	110	01/01 → 09/02				SVF016	B6	
2.0 Turbo	Petrol	113	10/98 → 08/00				SVF016	B6	
2.0 Turbo	Petrol	136	02/98 → 08/00				SVF016	B6	



TYPE

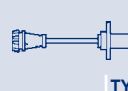

TYPE



TYPE

			SPA104	F1					
	APS41		SPA104	F1		SAG093	H1	ESS0084A	J1
			SPA104	F1					
			SPA104	F1					
			SPA104	F1					
			SPA104	F1					
	APS41		SPA104	F1				ESS0084A	J1
	APS41		SPA104	F1				ESS0084A	J1
	APS41		SPA104	F1					
								SUA444	J2
	APS41		SPA104	F1		SAG093	H1	ESS0084A	J1
	APS41		SPA104	F1		SAG093	H1	ESS0084A	J1
	APS41		SPA104	F1				ESS0084A	J1
								SUA444	J2
	APS41		SPA104	F1		SAG093	H1	ESS0084A	J1
								ESS0084A	J1
			SPA103	F1		SAD028	H3	ESS0084A	J1
						SAG078	H1	SUA446	J2
			SPA103	F1		SAG078	H1	ESS0084A	J1
			SPA103	F1		SAG078	H1		



KW



TYPE



TYPE

SAAB

9-3 (YS3D)

2.0 Turbo	Petrol	151	10/99 → 09/02				SVF016	B6
2.0 Turbo	Petrol	113	10/98 → 09/02					
2.0 Turbo	Petrol	136	02/98 → 09/02					
2.0 Turbo	Petrol	113	10/98 → 09/02					
2.0 Turbo	Petrol	136	02/98 → 09/02					
2.2 TiD	Diesel	85	02/98 → 11/00	CHASSIS: 12020001 →				
2.2 TiD	Diesel	92	11/00 → 09/02	CHASSIS: 12020001 →				
2.2 TiD	Diesel	85	02/98 → 11/00					
2.2 TiD	Diesel	85	02/98 → 11/00					
2.2 TiD	Diesel	92	11/00 → 09/02					
2.2 TiD	Diesel	92	11/00 → 09/02					
2.3	Petrol	169	09/99 → 01/02					
2.3 i	Petrol	110	02/98 → 08/00				SVF016	B6
2.3 i	Petrol	110	02/98 → 09/02					
2.3 i	Petrol	110	02/98 → 09/02					
2.3 i	Petrol	110	02/98 → 12/99					
2.3 Turbo	Petrol	165	09/99 → 08/00				SVF016	B6
2.3 Turbo	Petrol	165	10/98 → 09/02					

9-3 (YS3F)

1.9 TiD	Diesel	110	09/04 →				48CPD4	B3
1.9 TiD	Diesel	110	09/04 →					
1.9 TiD	Diesel	88	09/04 →					
2.2 TiD	Diesel	92	09/02 →					
2.2 TiD	Diesel	92	09/02 →					
2.8 Turbo V6	Petrol	184	03/05 →					
2.8 Turbo V6	Petrol	188	12/07 →					
2.8 Turbo V6	Petrol	203	04/08 → 06/12					
2.8 Turbo V6 XWD	Petrol	206	05/08 →					

9-3 Cabriolet (YS3D)

2.0 i	Petrol	96	02/98 → 08/00				SVF016	B6
2.0 i	Petrol	96	02/98 → 08/03					
2.0 i	Petrol	96	02/98 → 08/03					
2.0 i	Petrol	96	02/98 → 12/00					
2.0 SE Turbo	Petrol	147	09/98 → 08/00				SVF016	B6
2.0 SE Turbo	Petrol	147	02/98 → 08/03					
2.0 Turbo	Petrol	113	10/98 → 08/00				SVF016	B6
2.0 Turbo	Petrol	136	02/98 → 08/03				SVF016	B6
2.0 Turbo	Petrol	110	01/01 → 08/03					
2.0 Turbo	Petrol	113	10/98 → 08/03					
2.0 Turbo	Petrol	136	02/98 → 08/03					
2.0 Turbo	Petrol	151	10/99 → 08/03					
2.0 Turbo	Petrol	113	10/98 → 08/03					
2.3	Petrol	169	09/99 → 01/02					
2.3 i	Petrol	110	02/98 → 08/00				SVF016	B6

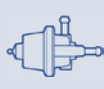

TYPE

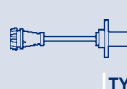

TYPE



TYPE

				SPA103	F1		SAG078	H1		ESS0084A	J1
				SPA103	F1		SAG093	H1		ESS0084A	J1
				SPA103	F1		SAG078	H1		ESS0084A	J1
										SUA446	J2
										SUA446	J2
		APS24									
		APS24									
				SPA103	F1		SAG021	H1			
							SAG021-1	H1			
							SAG021	H1			
							SAG021-1	H1			
							SAG078	H1			
				SPA103	F1		SAD028	H3		ESS0084A	J1
							SAG078	H1			
										SUA446	J2
				SPA103	F1		SAG078	H1		ESS0084A	J1
				ATS20	F2		SAC068	H2			
							SAG133	H1			
				ATS20	F2						
							SAG021	H1			
							SAG021-1	H1			
							SAD004	H3	BAE680CF		
							SAD004	H3	BAE680CF		
									BAE680CF		
									BAE680CF		
				SPA103	F1		SAD028	H3		ESS0084A	J1
							SAG078	H1			
										SUA446	J2
				SPA103	F1		SAG078	H1		ESS0084A	J1
				SPA103	F1		SAG078	H1		ESS0084A	J1
				SPA103	F1		SAG078	H1			
				SPA103	F1		SAG093	H1		ESS0084A	J1
										SUA446	J2
				SPA103	F1		SAG078	H1		ESS0084A	J1
										SUA446	J2
							SAG078	H1			



KW



TYPE



TYPE

SAAB

9-3 Cabriolet (YS3D)

2.3 i	Petrol	110	02/98 → 08/03					
2.3 i	Petrol	110	02/98 → 08/03					
2.3 i	Petrol	110	02/98 → 12/99					
2.3 Turbo	Petrol	165	10/99 → 08/03					

9-3 Cabriolet (YS3F)

1.9 TiD	Diesel	110	01/06 →					
1.9 TiD	Diesel	110	01/06 →					
2.8 Turbo V6	Petrol	184	02/06 →					
2.8 Turbo V6	Petrol	188	12/07 →					
2.8 Turbo V6	Petrol	203	02/09 → 06/12					
2.8 Turbo V6	Petrol	206	02/09 → 06/12					

9-3 Station wagon

1.8 i	Petrol	90	03/05 →					
1.9 TiD	Diesel	110	03/05 →					
1.9 TiD	Diesel	88	03/05 →					
1.9 TiD	Diesel	110	03/05 →					
2.0 T	Petrol	110	03/05 →					
2.8 Turbo V6	Petrol	184	03/05 →					
2.8 Turbo V6	Petrol	188	12/07 →					
2.8 Turbo V6	Petrol	203	05/08 → 06/12					
2.8 Turbo V6 XWD	Petrol	206	05/08 →					

9-5 (YS3E)

1.9 TiD	Diesel	110	01/06 →				48CPD4	B3
1.9 TiD	Diesel	110	01/06 →					
2.0 T	Petrol	110	09/97 →					
2.0 T	Petrol	110	09/97 →					
2.0 T	Petrol	136	07/00 →					
2.0 Turbo SE	Petrol	141	10/98 → 07/00					
2.2 TiD	Diesel	88	03/02 →					
2.2 TiD	Diesel	88	03/02 →					
2.3 t	Petrol	125	09/97 →					
2.3 t	Petrol	136	01/01 →					
2.3 Turbo	Petrol	169	10/99 → 09/01					
2.3 Turbo	Petrol	184	09/01 →					
2.3 Turbo	Petrol	162	07/03 →					
3.0 V6t	Petrol	147	01/98 →					

9-5 (YS3G)

2.0 TiD	Diesel	118	05/10 →					
---------	--------	-----	---------	--	--	--	--	--

9-5 Station wagon (YS3E)

1.9 TiD	Diesel	110	01/06 →					
1.9 TiD	Diesel	110	01/06 →					
2.0 T	Petrol	110	10/98 →					
2.0 T	Petrol	136	07/00 → 07/01					
2.0 T	Petrol	141	10/98 →					



TYPE



TYPE



TYPE

				SPA103	F1		SAD028	H3		ESS0084A	J1
							SAG078	H1			
										SUA446	J2
				SPA103	F1		SAG078	H1		ESS0084A	J1
				ATS10	F2		SAC068	H2			
							SAG133	H1			
							SAD004	H3	BAE680CF		
							SAD004	H3	BAE680CF		
									BAE680CF		
									BAE680CF		
										ESS0089A	J1
				ATS10	F2		SAC068	H2			
				ATS20	F2						
							SAG133	H1			
										ESS0089A	J1
							SAD004	H3	BAE680CF		
							SAD004	H3	BAE680CF		
									BAE680CF		
									BAE680CF		
				ATS10	F2		SAC068	H2			
							SAG133	H1			
				SPA103	F1		SAG078	H1		ESS0084A	J1
										GA2094	J2
							SAG078	H1			
							SAG078	H1			
				SPA103	F1		SAG021	H1			
							SAG021-1	H1			
				SPA103	F1		SAG078	H1		ESS0084A	J1
				SPA103	F1		SAG078	H1			
				SPA103	F1		SAG078	H1		GA2094	J2
				SPA103	F1		SAG078	H1			
							SAG078	H1			
				SPA103	F1		SAG031	H1		ESS0084A	J1
APS49											
				ATS10	F2		SAC068	H2			
							SAG133	H1			
				SPA103	F1		SAG078	H1		ESS0084A	J1
							SAG078	H1			
							SAG078	H1		ESS0084A	J1



KW

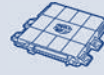

TYPE



TYPE

SAAB

9-5 Station wagon (YS3E)

2.2 TiD	Diesel	88	03/02 →						
2.2 TiD	Diesel	88	03/02 →						
2.3 t	Petrol	125	10/98 →						
2.3 t	Petrol	136	01/01 →						
2.3 Turbo	Petrol	169	10/99 → 09/01						
2.3 Turbo	Petrol	184	09/01 →						
2.3 Turbo	Petrol	162	07/03 →						
3.0 V6t	Petrol	147	10/98 →						

SEAT

131

1.5	Petrol	55	03/82 → 01/85						
1.6	Petrol	71	03/82 → 01/85						

ALHAMBRA (710)

1.4 TSI	Petrol	110	06/10 →						
1.4 TSI	Petrol	110	06/10 →						
2.0 TDi	Diesel	100	06/10 → 05/11						
2.0 TDi	Diesel	103	06/10 →						
2.0 TDi	Diesel	103	06/10 →						
2.0 TDi	Diesel	125	06/10 →						
2.0 TDi	Diesel	125	06/10 →						
2.0 TDi	Diesel	85	05/11 →						
2.0 TDi 4Drive	Diesel	103	05/11 →						

ALHAMBRA (7V8, 7V9)

1.8 T 20V	Petrol	110	06/00 → 08/01						
1.8 T 20V	Petrol	110	09/01 → 03/10						
1.8 T 20V	Petrol	110	10/97 → 03/10						
1.8 T 20V	Petrol	110	10/97 → 03/10						
1.8 T 20V	Petrol	110	05/98 → 03/10						
1.8 T 20V	Petrol	110	05/98 → 03/10						
1.9 TDI	Diesel	110	05/05 → 05/07				AMM19752		B4
1.9 TDI	Diesel	96	11/02 → 11/08				AMM19752		B4
1.9 TDI	Diesel	85	06/00 → 06/01						
1.9 TDI	Diesel	85	07/01 → 03/10						
1.9 TDI	Diesel	110	05/05 → 05/07						
1.9 TDI	Diesel	85	06/00 → 03/10						
1.9 TDI	Diesel	85	06/00 → 03/10						
1.9 TDI	Diesel	96	11/02 → 11/08						
1.9 TDI 4motion	Diesel	85	06/00 → 06/01						
1.9 TDI 4motion	Diesel	85	07/01 → 03/10						
1.9 TDI 4motion	Diesel	85	06/00 → 03/10						
1.9 TDI 4motion	Diesel	85	06/00 → 03/10						
1.9 TDI 4motion	Diesel	85	01/01 → 03/10						
1.9 Tdi 4x4	Diesel	96	06/05 → 11/08				AMM19752		B4



TYPE

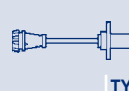

TYPE



TYPE

				SPA103	F1		SAG021	H1		
							SAG021-1	H1		
				SPA103	F1		SAG078	H1	ESS0084A	J1
				SPA103	F1		SAG078	H1		
				SPA103	F1		SAG078	H1		
				SPA103	F1		SAG078	H1		
							SAG078	H1		
				SPA103	F1		SAG031	H1	ESS0084A	J1

									BK2A	
									BK2A	

				ATS16	F2		SAC011	H2		
				SPA111	F1					
				SPA111	F1	SAA105				
				ATS16	F2	SAA105				
				SPA111	F1					
				ATS16	F2	SAA105				
				SPA111	F1					
				SPA111	F1	SAA105				
				SPA111	F1	SAA105				

		APS39								
		APS40								
				ATS23	F2		SAD031	H3	ESS0016A	J1
				SPA111	F1		SAG100	H1		
				ATS19	F2		SAC084	H2		
							SAG018	H1		
				ATS23	F2					
				ATS23	F2					

		APS39								
		APS40								
				SPA111	F1					
				ATS23	F2		SAG015	H2		
				SPA109	F1					
				SPA111	F1					
		APS39								
		APS40								
				ATS23	F2					
				SPA109	F1					
							SAG015	H2		
				SPA111	F1					



KW



TYPE



TYPE

SEAT

ALHAMBRA (7V8, 7V9)

2.0 TDi	Diesel	103	11/05 → 03/10					AMM19752	B4
2.8 V6	Petrol	150	06/00 → 03/10						
2.8 V6	Petrol	150	06/00 → 03/10						
2.8 V6	Petrol	150	06/00 → 03/10						
2.8 V6 4motion	Petrol	150	06/00 → 03/10						
2.8 V6 4motion	Petrol	150	06/00 → 03/10						
2.8 V6 4motion	Petrol	150	06/00 → 03/10						

ALTEA (5P1)

1.2 TSI	Petrol	77	04/10 →						
1.4 16V	Petrol	63	05/06 →						
1.4 16V	Petrol	63	05/06 →						
1.4 TSI	Petrol	92	11/07 →						
1.4 TSI	Petrol	92	11/07 → 06/09						
1.4 TSI	Petrol	92	11/07 →						
1.6	Petrol	75	03/04 →						
1.6	Petrol	75	03/04 →						
1.6 LPG	Petrol/LPG	75	12/09 →						
1.6 TDI	Diesel	66	11/10 →						
1.6 TDI	Diesel	77	11/09 →						
1.6 TDI	Diesel	77	10/09 →						
1.8 TFSI	Petrol	118	01/07 →						
1.9 TDI	Diesel	77	04/04 →						
1.9 TDI	Diesel	66	11/09 →						
2.0 FSI	Petrol	110	05/04 → 03/09						
2.0 FSI	Petrol	110	05/04 → 03/09						
2.0 TDi	Diesel	100	03/04 → 05/09					AMM19752	B4
2.0 TDi	Diesel	103	11/05 →					AMM19752	B4
2.0 TDi	Diesel	125	03/06 →					AMM19752	B4
2.0 TDi	Diesel	100	03/04 → 05/09						
2.0 TDi	Diesel	125	03/06 →						
2.0 TDi 16V	Diesel	103	03/04 →					AMM19752	B4
2.0 TDi 16V	Diesel	103	03/04 →						
2.0 TDi 16V	Diesel	103	03/04 → 09/11						
2.0 TFSI	Petrol	147	04/06 → 05/09						
2.0 TFSI	Petrol	147	05/06 → 03/09						

ALTEA XL (5P5, 5P8)

1.2 TSI	Petrol	77	05/10 →						
1.4 16V	Petrol	63	10/06 →						
1.4 16V	Petrol	63	10/06 →						
1.4 TSI	Petrol	92	11/07 →						
1.4 TSI	Petrol	92	11/07 → 06/09						
1.4 TSI	Petrol	92	11/07 →						
1.6	Petrol	75	10/06 →						
1.6 LPG	Petrol/LPG	75	09/09 →						



TYPE

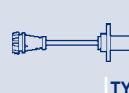

TYPE



TYPE

				SPA111	F1		SAG166	H1			
				ATS23	F2		SAC040	H2	BAE680S	ESS0016A	J1
				SPA111	F1		SAD031	H3			
							SAG065	H1			
				ATS23	F2		SAC040	H2		ESS0016A	J1
				SPA111	F1		SAD031	H3			
							SAG065	H1			
				SPA111	F1						
				SPA111	F1	SAA105	SAC014	H2			
							SAG166	H1			
				SPA111	F1		SAC011	H2			
						SAA105					
							SAG155	H1			
				SPA111	F1		SAC075	H2	BAE680AA		
							SAD031	H3			
				SPA111	F1						
				SPA111	F1	SAA105					
				SPA111	F1						
						SAA105					
				SPA111	F1				BAE680BB		
	APS40			SPA111	F1		SAG166	H1		ESS0073A	J1
				SPA111	F1						
				ATS13	F2		SAC073	H2		ESS0073A	J1
				SPA111	F1		SAG100	H1			
				SPA111	F1		SAC085	H2		ESS0073A	J1
				SPA111	F1		SAG166	H1		ESS0073A	J1
				SPA111	F1	SAA105	SAC085	H2		ESS0073A	J1
							SAG166	H1			
							SAG166	H1			
	SPS004			SPA111	F1		SAC085	H2		ESS0073A	J1
							SAG166	H1			
						SAA105					
				SPA111	F1						
									BAE680BB		
				SPA111	F1						
				SPA111	F1	SAA105	SAC014	H2			
							SAG166	H1			
				SPA111	F1		SAC011	H2			
						SAA105					
							SAG155	H1			
				SPA111	F1						
				SPA111	F1						



KW



TYPE



TYPE

SEAT

ALTEA XL (5P5, 5P8)

1.6 Multifuel	Petrol/Ethanol	75	10/06 →						
1.6 TDI	Diesel	66	11/10 →						
1.6 TDI	Diesel	77	02/10 →						
1.6 TDI	Diesel	77	10/09 →						
1.8 TFSI	Petrol	118	01/07 →						
1.9 TDI	Diesel	66	08/09 →						
1.9 TDI	Diesel	77	10/06 →						
2.0 FSI	Petrol	110	10/06 → 03/09						
2.0 TDi	Diesel	100	11/06 → 03/09					AMM19752	B4
2.0 TDi	Diesel	103	10/06 →					AMM19752	B4
2.0 TDi	Diesel	125	06/07 →					AMM19752	B4
2.0 TDi	Diesel	125	06/07 →						
2.0 TDI 16V	Diesel	103	10/06 →					AMM19752	B4
2.0 TDI 16V	Diesel	103	10/06 →						
2.0 TDI 16V	Diesel	103	09/10 → 05/11						
2.0 TDI 4x4	Diesel	103	06/07 →					AMM19752	B4
2.0 TDI 4x4	Diesel	125	06/07 →					AMM19752	B4
2.0 TDI 4x4	Diesel	125	06/07 →						
2.0 TFSI 4x4	Petrol	147	06/07 → 05/09						
2.0 TFSI 4x4	Petrol	155	05/09 →						
2.0 TFSI 4x4	Petrol	155	07/09 →						

AROSA (6H)

1.4 16V	Petrol	74	01/00 → 06/04						
1.4 16V	Petrol	74	01/00 → 06/04						
1.4 TDI	Diesel	55	01/00 → 06/04						
1.7 SDI	Diesel	44	08/97 → 06/04						
1.7 SDI	Diesel	44	08/97 → 06/04						
1.7 SDI	Diesel	44	08/97 → 10/03						

CORDOBA (6K1, 6K2)

1.0 i	Petrol	37	09/96 → 06/99						
1.0 i	Petrol	37	09/96 → 06/99						
1.4 i	Petrol	44	06/94 → 06/99					TB0010	B3
1.4 i	Petrol	44	06/94 → 06/99						
1.6 i	Petrol	55	02/93 → 06/99					TB0010	B3
1.6 i	Petrol	55	02/93 → 06/99						
1.6 i	Petrol	55	05/94 → 06/99						
1.8 i	Petrol	66	02/93 → 06/99						
1.8 i 16V	Petrol	95	10/93 → 08/96						
1.8 i 16V	Petrol	95	10/93 → 08/96						
1.9 D	Diesel	50	02/93 → 08/96						
1.9 TD	Diesel	55	02/93 → 08/96						
1.9 TDI	Diesel	81	03/97 → 06/99						
1.9 TDI	Diesel	81	03/97 → 06/99						
2.0 i	Petrol	85	02/93 → 06/99					AMM19672	B4



TYPE

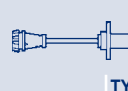

TYPE



TYPE

				SPA111	F1					
				SPA111	F1	SAA105				
				SPA111	F1					
						SAA105				
				SPA111	F1					
				SPA111	F1					
				SPA111	F1		SAG166	H1	ESS0073A	J1
				SPA111	F1					
				SPA111	F1					
				SPA111	F1		SAG166	H1	ESS0073A	J1
				SPA111	F1		SAC085	H2	ESS0073A	J1
							SAG166	H1		
		SPS004		SPA111	F1		SAC085	H2	ESS0073A	J1
							SAG166	H1		
						SAA105				
				SPA111	F1		SAG166	H1		
		SPS004		SPA111	F1		SAC085	H2	ESS0073A	J1
							SAG166	H1		
				SPA111	F1			BAE680BB		
				SPA111	F1					
								BAE680BB		
		IWP058		ATS23	F2	SAA105	SAC014	H2	ESS0016A	J1
				SPA109	F1		SAG178	H1		
		APS39		ATS23	F2		SAG134	H1	ESS0045A	J1
				ATS18	F2					
				SPA110	F1					
							SAG142	H1		
							SAD028	H3	BAE680AA	
							SAG178	H1		
				SPA106	F1		SAD028	H3	BAE680AA	ESS0042A J1
							SAG178	H1		
		IWP023		SPA106	F1		SAD028	H3	ESS0042A	J1
							SAG178	H1		
							SAG178	H1	BAE680AA	ESS0042A J1
				SPA106	F1	SAA104	SAG178	H1	ESS0019A	J1
				ATS18	F2					
				SPA106	F1					
				SPA140	F1					
				SPA140	F1					
		APS29		ATS18	F2		SAG178	H1		
				SPA140	F1					
				ATS18	F2		SAG118	H1	BAE680AA	



KW



TYPE



TYPE

SEAT

CORDOBA (6K1, 6K2)

2.0 i	Petrol	85	02/93 → 06/99					
2.0 i	Petrol	85	02/93 → 06/99	CHASSIS: → 6KX068400				

CORDOBA (6K2)

1.0	Petrol	37	06/99 → 10/02					
1.0	Petrol	37	06/99 → 10/02					
1.0	Petrol	37	06/99 → 10/02	CHASSIS: 6KX400000 →				
1.4	Petrol	44	06/99 → 10/02					
1.4	Petrol	44	06/99 → 10/02					
1.4	Petrol	44	06/99 → 10/00					
1.4	Petrol	44	06/99 → 10/02	CHASSIS: 6KX400000 →				
1.4 16V	Petrol	55	05/00 → 10/02	ENGINE: AUA,APE				
1.4 16V	Petrol	55	05/00 → 10/02					
1.4 16V	Petrol	74	02/00 → 10/02					
1.4 16V	Petrol	55	05/00 → 10/02					
1.4 16V	Petrol	74	02/00 → 10/02					
1.4 16V	Petrol	55	05/00 → 10/02					
1.6	Petrol	74	06/99 → 10/00			AMM19670	B4	
1.6	Petrol	55	06/99 → 10/02					
1.6	Petrol	55	06/99 → 10/02					
1.6	Petrol	74	06/99 → 10/02	CHASSIS: → 6KX448600				
1.6	Petrol	74	06/99 → 10/02					
1.6	Petrol	74	06/99 → 10/02					
1.6	Petrol	74	06/99 → 10/02					
1.8 T 20V Cupra	Petrol	115	07/00 → 10/02					
1.8 T 20V Cupra	Petrol	115	07/00 → 10/02					
1.9 SDI	Diesel	50	06/99 → 10/02					
1.9 SDI	Diesel	50	06/99 → 10/02	CHASSIS: → 6KX448600				
1.9 SDI	Diesel	50	06/99 → 10/99					
1.9 TDI	Diesel	66	06/99 → 10/02					
1.9 TDI	Diesel	81	06/99 → 10/02					
1.9 TDI	Diesel	66	06/99 → 10/02	CHASSIS: → 6KX448600				
1.9 TDI	Diesel	81	06/99 → 10/02	CHASSIS: → 6KX448600				
1.9 TDI	Diesel	66	06/99 → 10/99					
1.9 TDI	Diesel	81	06/99 → 10/99					

CORDOBA (6L2)

1.2	Petrol	47	10/02 → 06/06					
1.2	Petrol	47	10/02 → 06/06					
1.2 12V	Petrol	51	05/06 → 11/09					
1.4 16V	Petrol	55	09/02 → 12/07					
1.4 16V	Petrol	55	09/02 → 12/07					
1.4 16V	Petrol	63	05/06 → 11/09					
1.4 16V	Petrol	74	10/02 → 11/09					
1.4 16V	Petrol	74	10/02 → 11/09					
1.4 16V	Petrol	55	09/02 → 12/07					

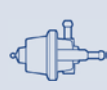

TYPE

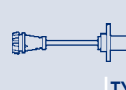

TYPE



TYPE

				SPA106	F1								
						SAA104							
						SAA105	SAD028	H3					
							SAG178	H1					
											GA2230	J2	
				SPA159	F1	SAA105	SAD028	H3					
							SAG178	H1					
							SAG145	H1					
											GA2230	J2	
IWP092													
				SPA109	F1	SAA105	SAC014	H2			GA2230	J2	
				SPA109	F1	SAA105	SAC014	H2			GA2230	J2	
							SAD028	H3					
							SAG178	H1					
							SAG178	H1					
				SPA109	F1		SAD028	H3					
				SPA110	F1		SAG178	H1					
				SPA159	F1								
							SAC015	H2			GA2230	J2	
							SAC015-1	H2					
							SAG178	H1					
				ATS19	F2		SAC084	H2	BAE680AW	ESS0018A		J1	
							SAG178	H1		GA2230		J2	
				ATS18	F2		SAG178	H1					
				SPA159	F1								
							SAG138	H1					
		APS39					SAG178	H1					
		APS39					SAG178	H1					
				SPA159	F1								
				SPA159	F1								
							SAG138	H1					
							SAG138	H1					
				ATS23	F2	SAA105	SAC011	H2	BAE680AU				
				SPA111	F1		SAD031	H3					
				SPA111	F1	SAA105	SAC011	H2					
				ATS23	F2	SAA105	SAC011	H2	BAE680AU				
				SPA111	F1		SAG132	H1					
				SPA111	F1	SAA105	SAG166	H1					
				ATS23	F2	SAA105	SAC014	H2					
				SPA111	F1		SAD031	H3					
							SAG166	H1					



KW



TYPE



TYPE

SEAT

CORDOBA (6L2)

1.4 16V	Petrol	74	10/02 → 11/09						
1.4 16V	Petrol	74	10/02 → 12/05						
1.4 TDI	Diesel	51	05/05 → 11/09						
1.4 TDI	Diesel	55	10/02 → 12/05						
1.4 TDI	Diesel	59	06/05 → 11/09						
1.4 TDI	Diesel	55	10/02 → 12/05						
1.4 TDI	Diesel	59	06/05 → 11/09						
1.6	Petrol	74	04/03 → 11/09						
1.6	Petrol	74	04/03 → 11/09						
1.6 16V	Petrol	77	11/06 → 11/09						
1.9 SDI	Diesel	47	09/02 → 11/09						
1.9 SDI	Diesel	47	09/02 → 11/09						
1.9 TDI	Diesel	96	10/02 → 11/09				AMM19752		B4
1.9 TDI	Diesel	74	09/02 → 11/09						
1.9 TDI	Diesel	74	09/02 → 11/09						
1.9 TDI	Diesel	96	10/02 → 11/09						
2.0	Petrol	85	09/02 → 11/09						
2.0	Petrol	85	09/02 → 11/09						
2.0	Petrol	85	09/02 → 11/09						

CORDOBA Vario (6K5)

1.4	Petrol	44	06/99 → 12/02						
1.4	Petrol	44	06/99 → 12/02						
1.4	Petrol	44	06/99 → 10/00						
1.4 16V	Petrol	55	06/99 → 12/02						
1.4 16V	Petrol	55	06/99 → 12/02						
1.4 16V	Petrol	55	06/99 → 12/02						
1.4 i	Petrol	44	09/96 → 06/99						
1.4 i	Petrol	44	09/96 → 06/99						
1.6	Petrol	74	06/99 → 12/02				AMM19670		B4
1.6	Petrol	55	06/99 → 12/02						
1.6	Petrol	55	06/99 → 12/02						
1.6	Petrol	74	06/99 → 12/02	CHASSIS: → 6KX448600					
1.6	Petrol	74	06/99 → 12/02						
1.6	Petrol	74	06/99 → 12/02						
1.6 i	Petrol	55	09/96 → 06/99						
1.6 i	Petrol	55	09/96 → 06/99						
1.6 i	Petrol	74	09/96 → 06/99						
1.6 i	Petrol	74	09/96 → 06/99	CHASSIS: → 6KX068400					
1.6 i	Petrol	55	05/97 → 06/99						
1.6 i	Petrol	74	09/96 → 06/99						
1.9 SDI	Diesel	47	09/96 → 06/99						
1.9 SDI	Diesel	50	06/99 → 12/02						
1.9 SDI	Diesel	50	06/99 → 12/02	CHASSIS: → 6KX448600					
1.9 SDI	Diesel	50	06/99 → 10/99						



TYPE

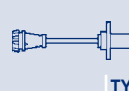

TYPE



TYPE

						SAG178	H1		
						SAC011	H2		
	APS40		SPA111	F1		SAG134	H1		
	APS40		ATS23	F2		SAG134	H1	ESS0018A	J1
	APS40		SPA111	F1		SAG134	H1		
			SPA111	F1					
						SAG166	H1		
			ATS23	F2	SAA105	SAD031	H3	ESS0018A	J1
			SPA111	F1					
			SPA111	F1	SAA105				
			ATS18	F2					
			SPA111	F1					
			ATS23	F2					
	APS40		ATS23	F2		SAG166	H1		
			SPA111	F1					
			SPA111	F1					
			ATS23	F2		SAC015	H2		
			SPA111	F1		SAC015-1	H2		
						SAD031	H3		
			SPA159	F1	SAA105	SAD028	H3	GA2230	J2
						SAG178	H1		
						SAG145	H1		
			SPA109	F1	SAA105	SAC014	H2	GA2230	J2
						SAD028	H3		
						SAG178	H1		
			SPA106	F1		SAD028	H3		
						SAG178	H1		
						SAC015	H2	GA2230	J2
			SPA109	F1		SAD028	H3		
			SPA110	F1		SAG178	H1		
			SPA159	F1					
						SAC015-1	H2		
						SAG178	H1		
IWP023			SPA106	F1		SAD028	H3		
						SAG178	H1		
			SPA106	F1		SAD021	H3		
					SAA104				
						SAG178	H1	ESS0042A	J1
						SAG118	H1		
			ATS18	F2		SAG142	H1		
			ATS18	F2		SAG178	H1		
			SPA159	F1					
						SAG138	H1		



KW



TYPE



TYPE

SEAT

CORDOBA Vario (6K5)

1.9 TDI	Diesel	66	06/99 → 08/02						
1.9 TDI	Diesel	66	06/97 → 06/99						
1.9 TDI	Diesel	81	06/99 → 08/02						
1.9 TDI	Diesel	81	07/97 → 06/99						
1.9 TDI	Diesel	66	06/99 → 12/02	CHASSIS: → 6KX448600					
1.9 TDI	Diesel	66	08/96 → 06/99						
1.9 TDI	Diesel	66	08/96 → 06/99						
1.9 TDI	Diesel	81	06/99 → 12/02	CHASSIS: → 6KX448600					
1.9 TDI	Diesel	81	07/97 → 06/99						
1.9 TDI	Diesel	66	06/99 → 12/02						
1.9 TDI	Diesel	66	06/99 → 10/99						
1.9 TDI	Diesel	81	06/99 → 12/02						
1.9 TDI	Diesel	81	06/99 → 10/99						

EXEO (3R2)

1.6	Petrol	75	03/09 → 09/10						
1.8 T	Petrol	110	12/08 → 05/10						
1.8 TSI	Petrol	118	05/10 →						
1.8 TSI	Petrol	88	09/10 →						
2.0 TDi	Diesel	88	12/08 →						
2.0 TDi	Diesel	105	12/08 →						
2.0 TDi	Diesel	125	02/09 →						
2.0 TFSI	Petrol	147	03/09 →						
2.0 TFSI	Petrol	155	05/10 →						

EXEO ST (3R5)

1.6	Petrol	75	06/09 → 09/10						
1.8 T	Petrol	110	06/09 → 05/10						
1.8 TSI	Petrol	118	05/10 →						
1.8 TSI	Petrol	88	09/10 →						
2.0 TDi	Diesel	105	05/09 →						
2.0 TDi	Diesel	125	05/09 →						
2.0 TDi	Diesel	88	09/09 →						
2.0 TFSI	Petrol	147	06/09 →						
2.0 TFSI	Petrol	155	05/10 →						

FURA (025A)

0.9	Petrol	33	01/82 → 06/86						
0.9	Petrol	29	03/84 → 12/86						

IBIZA I (021A)

0.9	Petrol	29	08/90 → 05/93						
0.9	Petrol	32	08/86 → 05/93						
1.2	Petrol	47	11/84 → 12/93						
1.2	Petrol	44	11/84 → 12/93						
1.2 i	Petrol	52	01/89 → 05/93						
1.5 i	Petrol	65	10/86 → 05/93						
1.5 i Cat.	Petrol	66	10/86 → 05/93						



TYPE



TYPE



TYPE

		APS39							
		APS29							
		APS39							
		APS29	ATS18	F2		SAG178	H1		
			SPA159	F1					
			ATS18	F2		SAG142	H1		
			SPA140	F1					
			SPA159	F1					
			SPA140	F1					
						SAG178	H1		
						SAG138	H1		
						SAG178	H1		
						SAG138	H1		
			SPA109	F1		SAG017	H1		
			SPA109	F1		SAG017	H1		
			SPA111	F1				BAE680BB	
			SPA111	F1				BAE680BB	
		SPS004	SPA111	F1					
			SPA111	F1					
			SPA111	F1					
			SPA111	F1				BAE680BB	
			SPA111	F1				BAE680BB	
			SPA109	F1		SAG017	H1		
			SPA109	F1		SAG017	H1		
			SPA111	F1				BAE680BB	
			SPA111	F1				BAE680BB	
			SPA111	F1					
			SPA111	F1					
			SPA111	F1				BAE680BB	
			SPA111	F1				BAE680BB	
			SPA101	F1	SAA107			BK2A	
								BK2A	
					SAA107				
					SAA107				
					SAA107			PI024	J1
								PI024	J1
								PI024	J1
								PI024	J1
								PI024	J1



KW

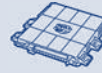

TYPE



TYPE

SEAT

IBIZA I (021A)

1.7	Petrol	72	01/91 → 05/93					
1.7	Petrol	76	01/91 → 05/93					

IBIZA II (6K1)

1.0	Petrol	33	03/93 → 09/96					
1.0 i	Petrol	37	09/96 → 08/99			TB0010	B3	
1.3 i	Petrol	40	03/93 → 08/99					
1.3 i	Petrol	40	03/93 → 12/96					
1.4 i	Petrol	44	09/93 → 08/99			TB0010	B3	
1.6 i	Petrol	55	03/93 → 08/99			TB0010	B3	
1.6 i	Petrol	55	03/93 → 08/99					
1.6 i	Petrol	55	09/94 → 06/99					
1.8 i	Petrol	66	03/93 → 08/99					
1.8 i 16V	Petrol	95	11/93 → 08/96					
1.8 i 16V	Petrol	95	11/93 → 08/96					
1.9 D	Diesel	50	10/94 → 08/96					
1.9 SDI	Diesel	47	08/96 → 08/99					
1.9 SDI	Diesel	47	08/96 → 08/99					
1.9 TD	Diesel	55	03/93 → 08/96					
2.0 i	Petrol	85	04/96 → 08/99			AMM19672	B4	
2.0 i	Petrol	85	03/93 → 08/99					
2.0 i	Petrol	85	03/93 → 08/99					

IBIZA III (6K1)

1.0	Petrol	37	08/99 → 02/02					
1.0	Petrol	37	08/99 → 02/02					
1.0	Petrol	37	08/99 → 07/00					
1.0 16V	Petrol	51	10/99 → 02/02					
1.4	Petrol	44	08/99 → 02/02					
1.4	Petrol	44	08/99 → 02/02					
1.4	Petrol	44	08/99 → 10/00					
1.4 16V	Petrol	55	05/00 → 02/02	ENGINE: AUA,APE				
1.4 16V	Petrol	55	05/00 → 02/02					
1.4 16V	Petrol	55	05/00 → 02/02					
1.4 16V	Petrol	74	08/99 → 02/02					
1.4 16V	Petrol	74	08/99 → 02/02					
1.4 16V	Petrol	55	05/00 → 02/02	CHASSIS: → 6K1158800				
1.4 16V	Petrol	74	08/99 → 02/02	CHASSIS: → 6K1158800				
1.6	Petrol	74	08/99 → 02/02			AMM19670	B4	
1.6	Petrol	55	08/99 → 02/02					
1.6	Petrol	55	08/99 → 02/02					
1.6	Petrol	74	08/99 → 02/02	CHASSIS: → 6KX448600				
1.6	Petrol	74	08/99 → 02/02					
1.6	Petrol	74	08/99 → 02/02					
1.8 T 20V Cupra	Petrol	115	07/00 → 02/02					
1.8 T 20V Cupra	Petrol	115	07/00 → 02/02					



TYPE



TYPE



TYPE

									PI024	J1
									PI024	J1
				SPA106	F1		SAG178	H1	ESS0019A	J1
				SPA106	F1		SAG178	H1	ESS0019A	J1
				SPA106	F1		SAG178	H1	ESS0042A	J1
				SPA105	F1					
				SPA106	F1		SAG178	H1	ESS0019A	J1
IWP023				SPA106	F1		SAD028	H3	ESS0019A	J1
							SAG178	H1		
							SAG178	H1	ESS0042A	J1
				SPA106	F1	SAA104	SAG178	H1	ESS0019A	J1
				ATS18	F2				ESS0018A	J1
				SPA106	F1					
				SPA140	F1					
				ATS18	F2		SAG142	H1		
				SPA106	F1					
				SPA140	F1					
				ATS18	F2	SAA104	SAG118	H1	ESS0019A	J1
				SPA106	F1					
				SPA110	F1	SAA105	SAD028	H3	BAE680AA	GA2230
							SAG178	H1		
							SAG145	H1		
				SPA110	F1					
				SPA109	F1	SAA105	SAD028	H3	GA2230	J2
				SPA110	F1		SAG178	H1		
							SAG145	H1		
IWP092				SPA109	F1	SAA105	SAD028	H3	BAE680AA	GA2230
				SPA110	F1		SAG178	H1		
				SPA109	F1	SAA105	SAD028	H3	GA2230	J2
				SPA110	F1		SAG178	H1		
							SAC014	H2		
							SAC014	H2		
						SAA105	SAC015	H2	BAE680AA	GA2230
				SPA109	F1		SAD028	H3		
				SPA110	F1		SAG178	H1		
				SPA159	F1					
							SAC015-1	H2		
							SAG178	H1		
				ATS19	F2	SAA105	SAC084	H2	BAE680AW	GA2230
							SAG178	H1		



KW



TYPE



TYPE

SEAT

IBIZA III (6K1)

1.9 SDI	Diesel	50	08/99 → 02/02					
1.9 SDI	Diesel	50	08/99 → 02/02	CHASSIS: → 6KX448600				
1.9 SDI	Diesel	50	08/99 → 10/99					
1.9 TDI	Diesel	66	08/99 → 02/02					
1.9 TDI	Diesel	81	08/99 → 02/02					
1.9 TDI	Diesel	66	08/99 → 02/02	CHASSIS: → 6KX448600				
1.9 TDI	Diesel	81	08/99 → 02/02	CHASSIS: → 6KX448600				
1.9 TDI	Diesel	66	08/99 → 10/99					
1.9 TDI	Diesel	81	08/99 → 10/99					

IBIZA IV (6L1)

1.2	Petrol	44	06/07 → 05/08					
1.2	Petrol	47	02/02 → 06/06					
1.2	Petrol	47	02/02 → 06/06					
1.2 12V	Petrol	51	05/06 → 11/09					
1.4 16V	Petrol	55	02/02 → 12/07					
1.4 16V	Petrol	55	02/02 → 12/07					
1.4 16V	Petrol	63	05/06 → 11/09					
1.4 16V	Petrol	74	02/02 → 11/09					
1.4 16V	Petrol	74	02/02 → 11/09					
1.4 16V	Petrol	55	02/02 → 12/07					
1.4 16V	Petrol	74	02/02 → 11/09					
1.4 16V	Petrol	55	02/02 → 12/07					
1.4 TDI	Diesel	51	05/05 → 11/09					
1.4 TDI	Diesel	55	05/02 → 12/05					
1.4 TDI	Diesel	59	06/05 → 11/09					
1.4 TDI	Diesel	55	05/02 → 12/05					
1.4 TDI	Diesel	59	06/05 → 11/09					
1.6	Petrol	74	02/03 → 11/09					
1.6	Petrol	74	02/03 → 11/09					
1.6 16V	Petrol	77	11/06 → 11/09					
1.8 T Cupra R	Petrol	132	01/04 → 02/08					
1.8 T Cupra R	Petrol	132	01/04 → 02/08					
1.8 T FR	Petrol	110	12/03 → 05/08					
1.8 T FR	Petrol	110	12/03 → 05/08					
1.9 SDI	Diesel	47	02/02 → 12/05					
1.9 SDI	Diesel	47	02/02 → 12/05					
1.9 TDI	Diesel	96	02/02 → 11/09			AMM19752	B4	
1.9 TDI	Diesel	74	02/02 → 11/09					
1.9 TDI	Diesel	74	02/02 → 11/09					
1.9 TDI	Diesel	96	02/02 → 11/09					
1.9 TDI Cupra R	Diesel	118	03/04 → 02/08			AMM19752	B4	
1.9 TDI Cupra R	Diesel	118	03/04 → 02/08					
2.0	Petrol	85	04/02 → 11/09					
2.0	Petrol	85	04/02 → 11/09					

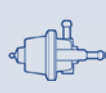

TYPE

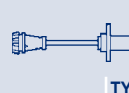

TYPE



TYPE

				ATS18	F2		SAG178	H1		
				SPA159	F1					
							SAG138	H1		
		APS39					SAG178	H1		
		APS39					SAG178	H1		
				SPA159	F1					
				SPA159	F1					
							SAG138	H1		
							SAG138	H1		
				SPA111	F1		SAC011	H2		
				ATS23	F2	SAA105	SAC011	H2		ESS0016A J1
				SPA111	F1					
				SPA111	F1	SAA105	SAC011	H2	BAE680AU	
				ATS23	F2	SAA105	SAC014	H2	BAE680AU	ESS0016A J1
				SPA111	F1		SAD031	H3		
				SPA111	F1	SAA105	SAC014	H2		GA2220 J2
				ATS23	F2	SAA105	SAC014	H2		ESS0016A J1
				SPA111	F1		SAD031	H3		GA2230 J2
							SAG132	H1		
							SAG178	H1		
							SAG166	H1		
		APS40		SPA111	F1		SAG134	H1		
		APS40		ATS23	F2		SAG134	H1		
		APS40		SPA111	F1		SAG134	H1		
				SPA111	F1					
							SAG166	H1		
				ATS23	F2	SAA105	SAC011	H2	BAE680AA	
				SPA111	F1		SAD031	H3		
				SPA111	F1		SAC011	H2		
		APS40		ATS13	F2		SAC084	H2	BAE680AW	
				SPA111	F1		SAD031	H3		
		APS40		ATS13	F2		SAC084	H2	BAE680AW	
				SPA111	F1		SAD031	H3		
				ATS18	F2					
				SPA111	F1					
				ATS23	F2					
		APS40		ATS23	F2		SAG166	H1		
				SPA111	F1					
				SPA111	F1					
				ATS23	F2		SAG015	H2		
				SPA111	F1					
				SPA111	F1		SAC015	H2		
							SAC015-1	H2		



KW

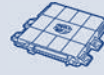

TYPE



TYPE

SEAT

IBIZA V (6J5)

1.2	Petrol	44	07/09 →						
1.2	Petrol	51	03/08 →						
1.2 TDI	Diesel	55	05/10 →						
1.2 TDI	Diesel	55	06/10 →						
1.2 TSI	Petrol	77	09/10 →						
1.4	Petrol	63	03/08 →						
1.4	Petrol	63	03/08 →						
1.4 TDI	Diesel	59	07/08 → 06/10						
1.4 TSI	Petrol	110	06/09 →						
1.4 TSI	Petrol	110	06/09 →						
1.6	Petrol	77	05/08 →						
1.6 LPG	Petrol/LPG	60	05/11 →						
1.6 TDI	Diesel	66	05/09 →						
1.6 TDI	Diesel	77	05/09 →						
1.6 TDI	Diesel	66	05/09 → 05/11						
1.6 TDI	Diesel	77	05/09 →						
1.9 TDI	Diesel	66	07/08 → 06/10						
1.9 TDI	Diesel	77	03/08 → 06/10						
2.0 TDi	Diesel	105	01/10 →						
2.0 TDi	Diesel	105	01/10 →						

IBIZA V SPORTCOUPE (6J1)

1.2	Petrol	44	07/09 →						
1.2	Petrol	51	07/08 → 05/11						
1.2	Petrol	51	07/08 →						
1.2 TSI	Petrol	77	09/10 →						
1.4	Petrol	63	07/08 →						
1.4	Petrol	63	07/08 →						
1.4 TDI	Diesel	59	07/08 → 06/10						
1.4 TSI	Petrol	110	06/09 →						
1.4 TSI	Petrol	110	06/09 →						
1.4 TSI Cupra	Petrol	132	06/09 →						
1.4 TSI Cupra	Petrol	132	06/09 →						
1.6	Petrol	77	07/08 →						
1.6 LPG	Petrol/LPG	60	05/11 →						
1.6 TDI	Diesel	66	05/09 →						
1.6 TDI	Diesel	77	05/09 →						
1.6 TDI	Diesel	66	05/09 → 05/11						
1.6 TDI	Diesel	77	05/09 →						
1.9 TDI	Diesel	66	07/08 → 06/10						
1.9 TDI	Diesel	77	07/08 → 06/10						
2.0 TDi	Diesel	105	01/10 →						
2.0 TDi	Diesel	105	01/10 →						



TYPE



TYPE



TYPE

				SPA111	F1	SAA105	SAC011	H2		
				SPA111	F1	SAA105	SAC011	H2		
		SPS004		ATS16	F2					
				SPA111	F1					
				SPA111	F1	SAA105				
				SPA111	F1	SAA105	SAC014	H2		
							SAG166	H1		
				SPA111	F1		SAG166	H1		
				ATS16	F2	SAA105	SAC011	H2		
				SPA111	F1					
				SPA111	F1	SAA105	SAC011	H2		
				SPA111	F1	SAA105	SAC011	H2		
		SPS004		ATS16	F2					
		SPS004		ATS16	F2					
				SPA111	F1					
				SPA111	F1					
				SPA111	F1					
				SPA111	F1					
		SPS004		ATS16	F2					
				SPA111	F1					
				SPA111	F1	SAA105	SAC011	H2		
				SPA111	F1					
						SAA105	SAC011	H2		
				SPA111	F1	SAA105				
				SPA111	F1	SAA105	SAC014	H2		
							SAG166	H1		
				SPA111	F1		SAG166	H1		
				ATS16	F2	SAA105	SAC011	H2		
				SPA111	F1					
				ATS16	F2	SAA105	SAC011	H2		
				SPA111	F1					
				SPA111	F1	SAA105	SAC011	H2		
				SPA111	F1	SAA105	SAC011	H2		
		SPS004		ATS16	F2					
		SPS004		ATS16	F2					
				SPA111	F1					
				SPA111	F1					
				SPA111	F1					
				SPA111	F1					
				SPA111	F1					
		SPS004		ATS16	F2					
				SPA111	F1					



KW



TYPE



TYPE

SEAT

IBIZA V ST (6J8)

1.2	Petrol	44	05/10 →						
1.2	Petrol	51	05/10 →						
1.2 TDI	Diesel	55	04/10 →						
1.2 TDI	Diesel	55	04/10 →						
1.2 TSI	Petrol	77	09/10 →						
1.4	Petrol	63	03/10 →						
1.4 TSI	Petrol	110	02/12 →						
1.6	Petrol	77	02/12 →						
1.6 TDI	Diesel	66	03/10 →						
1.6 TDI	Diesel	77	03/10 →						
1.6 TDI	Diesel	66	03/10 →						

INCA (6K9)

1.4 16V	Petrol	55	04/00 → 06/03	ENGINE: AUA					
1.4 16V	Petrol	55	09/00 → 06/03						
1.4 16V	Petrol	55	09/00 → 06/03						
1.4 16V	Petrol	55	04/00 → 06/03						
1.4 16V	Petrol	55	04/00 → 06/03						
1.4 16V	Petrol	55	04/00 → 06/03						
1.6 i	Petrol	55	06/97 → 09/00				TB0010		B3
1.6 i	Petrol	55	06/97 → 09/00	ENGINE: AEE,ALM					
1.6 i	Petrol	55	06/97 → 09/00						
1.7 D	Diesel	42	09/96 → 09/00						
1.9 TDI	Diesel	66	09/96 → 06/03						
1.9 TDI	Diesel	66	09/96 → 10/99						

LEON (1M1)

1.4 16V	Petrol	55	11/99 → 06/06						
1.4 16V	Petrol	55	11/99 → 06/06						
1.4 16V	Petrol	55	11/99 → 06/06						
1.6	Petrol	74	11/99 → 06/06				AMM19670		B4
1.6	Petrol	74	11/99 → 06/06						
1.6	Petrol	74	11/99 → 06/06						
1.6	Petrol	75	10/05 → 06/06						
1.6 16 V	Petrol	77	09/00 → 06/06						
1.6 16 V	Petrol	77	09/00 → 06/06						
1.8 20V	Petrol	92	11/99 → 06/06						
1.8 20V	Petrol	92	11/99 → 06/06						
1.8 20V	Petrol	92	11/99 → 07/04						
1.8 20V T	Petrol	132	11/99 → 02/03						
1.8 20V T	Petrol	132	03/03 → 04/04						
1.8 20V T	Petrol	132	11/99 → 06/06						
1.8 20V T	Petrol	132	11/99 → 06/06						
1.8 20V T	Petrol	132	11/99 → 04/04						
1.8 20V T 4	Petrol	132	11/99 → 02/03						
1.8 20V T 4	Petrol	132	03/03 → 04/04						

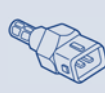

TYPE

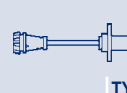

TYPE



TYPE

			SPA111	F1	SAA105	SAC011	H2			
			SPA111	F1	SAA105	SAC011	H2			
		SPS004	ATS16	F2						
			SPA111	F1						
			SPA111	F1	SAA105					
			SPA111	F1	SAA105	SAC014	H2			
					SAA105					
			SPA111	F1		SAC011	H2			
		SPS004	ATS16	F2						
		SPS004	SPA111	F1						
			SPA111	F1						
		IWP092								
			SPA109	F1						
			SPA110	F1						
					SAA105	SAC014	H2			
						SAD028	H3			
						SAG178	H1			
			SPA110	F1		SAD028	H3			
		IWP044								
						SAG178	H1			
			SPA110	F1						
						SAG178	H1			
						SAG138	H1			
		IWP092	ATS23	F2	SAA105	SAC011	H2	BAE680AA	ESS0016A	J1
			SPA109	F1		SAD031	H3			
						SAG178	H1			
			ATS23	F2		SAC015	H2		ESS0016A	J1
			SPA109	F1		SAC015-1	H2			
						SAG018	H1			
			SPA111	F1		SAC067	H2			
		IWP123	ATS23	F2	SAA105	SAC014	H2	BAE680AA	ESS0016A	J1
			SPA109	F1						
			ATS23	F2		SAG018	H1	BAE680AA	ESS0016A	J1
			SPA109	F1						
						SAC084	H2			
		APS39								
		APS40								
			ATS23	F2		SAC084	H2	BAE680AW	ESS0016A	J1
			SPA109	F1		SAG018	H1			
			ATS19	F2						
		APS39								
		APS40								



KW



TYPE



TYPE

SEAT

LEON (1M1)

1.8 20V T 4	Petrol	132	11/99 → 06/06						
1.8 20V T 4	Petrol	132	11/99 → 06/06						
1.8 20V T 4	Petrol	132	03/00 → 04/04						
1.8 20V T 4	Petrol	132	03/00 → 06/06						
1.8 T Cupra R	Petrol	154	02/02 → 06/06						
1.8 T Cupra R	Petrol	154	02/02 → 06/06						
1.8 T Cupra R	Petrol	154	05/02 → 05/03						
1.8 T Cupra R	Petrol	165	07/03 → 06/06						
1.8 T Cupra R	Petrol	165	07/03 → 06/06						
1.8 T Cupra R	Petrol	154	02/02 → 05/03						
1.8 T Cupra R	Petrol	165	07/03 → 06/06						
1.9 SDI	Diesel	50	11/99 → 06/06						
1.9 SDI	Diesel	50	11/99 → 06/06						
1.9 TDI	Diesel	110	02/01 → 06/06				AMM19752		B4
1.9 TDI	Diesel	96	05/03 → 06/06				AMM19752		B4
1.9 TDI	Diesel	66	11/99 → 02/03						
1.9 TDI	Diesel	66	03/03 → 07/04						
1.9 TDI	Diesel	74	10/05 → 06/06						
1.9 TDI	Diesel	81	11/99 → 02/03						
1.9 TDI	Diesel	81	03/03 → 07/04						
1.9 TDI	Diesel	110	02/01 → 06/06						
1.9 TDI	Diesel	66	11/99 → 06/06						
1.9 TDI	Diesel	66	11/99 → 06/06						
1.9 TDI	Diesel	81	11/99 → 06/06						
1.9 TDI	Diesel	81	11/99 → 06/06						
1.9 TDI	Diesel	96	05/03 → 06/06						
1.9 TDI Syncro	Diesel	110	05/02 → 06/06				AMM19752		B4
1.9 TDI Syncro	Diesel	110	05/02 → 06/06						
2.8	Petrol	150	05/02 → 06/04						
2.8 Cupra 4	Petrol	150	02/01 → 06/06						
2.8 Cupra 4	Petrol	150	02/01 → 06/06						
2.8 Cupra 4	Petrol	150	02/01 → 06/06						

LEON (1P1)

1.4 16V	Petrol	63	06/06 →						
1.4 16V	Petrol	63	06/06 →						
1.4 TSI	Petrol	92	11/07 →						
1.6	Petrol	75	07/05 →						
1.6	Petrol	75	07/05 →						
1.6 LPG	Petrol/LPG	75	12/09 →						
1.6 Multifuel	Petrol/Ethanol	75	11/10 →						
1.8 TSI	Petrol	118	06/07 →						
1.9 TDI	Diesel	66	06/07 →						
1.9 TDI	Diesel	77	07/05 →						
1.9 TDI	Diesel	77	07/05 →						



TYPE



TYPE



TYPE

				ATS23	F2		SAC084	H2		ESS0016A	J1
				SPA109	F1						
				ATS19	F2						
							SAG018	H1			
				ATS23	F2		SAD031	H3	BAE680AW	GA2138	J2
				SPA109	F1		SAG096	H1			
				ATS19	F2						
				ATS19	F2		SAC084	H2		GA2138	J2
				SPA109	F1		SAD031	H3			
							SAC084	H2			
							SAG096	H1			
				ATS18	F2		SAG178	H1			
				SPA109	F1						
				ATS23	F2		SAG015	H2		ESS0073A	J1
				ATS23	F2		SAG015	H2		ESS0073A	J1
		APS39									
		APS40									
		APS40		SPA109	F1		SAG015	H2		ESS0073A	J1
		APS39									
		APS40									
				SPA109	F1						
				ATS23	F2		SAG178	H1		ESS0073A	J1
				SPA109	F1						
				ATS23	F2		SAG178	H1		ESS0073A	J1
				SPA109	F1						
				SPA109	F1						
				ATS23	F2		SAG015	H2		ESS0073A	J1
				SPA109	F1						
				SPA109	F1		SAG065	H1			
				ATS23	F2		SAC040	H2	BAE680BC	ESS0016A	J1
				SPA109	F1		SAD031	H3			
							SAG065	H1			
				SPA111	F1	SAA105	SAC014	H2			
							SAG166	H1			
				SPA111	F1	SAA105	SAC011	H2			
				ATS23	F2		SAD031	H3			
				SPA111	F1						
				SPA111	F1						
				SPA111	F1				BAE680BB		
				SPA111	F1		SAG166	H1			
				ATS23	F2		SAG166	H1		ESS0073A	J1
				SPA111	F1						



KW



TYPE



TYPE

SEAT

LEON (1P1)

1.9 TDI	Diesel	81	10/05 →						
2.0 Cupra R	Petrol	195	09/09 →						
2.0 Cupra R	Petrol	195	09/09 → 12/12						
2.0 D	Diesel	100	07/05 →				AMM19752	B4	
2.0 FSI	Petrol	110	07/05 → 05/10						
2.0 FSI	Petrol	110	07/05 → 05/10						
2.0 TDi	Diesel	100	09/05 → 05/10				AMM19752	B4	
2.0 TDi	Diesel	103	10/05 →				AMM19752	B4	
2.0 TDi	Diesel	125	05/06 →				AMM19752	B4	
2.0 TDi	Diesel	125	05/06 →						
2.0 TDi	Diesel	100	07/05 → 05/10						
2.0 TDi	Diesel	100	07/05 → 05/10						
2.0 TDi 16V	Diesel	103	07/05 →				AMM19752	B4	
2.0 TDi 16V	Diesel	103	07/05 →						
2.0 TFSI	Petrol	136	09/05 → 05/06						
2.0 TFSI	Petrol	136	09/05 → 05/06						
2.0 TFSI	Petrol	147	05/05 → 03/09						
2.0 TFSI	Petrol	155	06/09 →						
2.0 TFSI	Petrol	177	11/06 →						
2.0 TFSI	Petrol	136	09/05 → 05/06	CHASSIS: → 1Pxx9xx024388					

MALAGA (023A)

1.5 i	Petrol	74	01/87 → 12/93						
1.5 i Cat.	Petrol	66	10/86 → 12/93						

MARBELLA (28)

0.8	Petrol	25	08/86 → 12/93						
0.9	Petrol	29	01/87 → 12/93						
0.9 Cat.	Petrol	29	01/90 → 11/96						
0.9 Cat.	Petrol	30	11/96 → 10/98						

MARBELLA Furgonato (028A)

0.8	Petrol	25	01/87 → 12/93						
0.9	Petrol	29	01/87 → 12/93						

Mii (KF1_)

1.0	Petrol	44	10/11 →						
1.0	Petrol	55	10/11 →						

RONDA (022A)

1.7 Diesel	Diesel	40	06/82 → 12/86						
------------	--------	----	---------------	--	--	--	--	--	--

TERRA (24)

0.9	Petrol	29	02/87 → 12/96						
-----	--------	----	---------------	--	--	--	--	--	--

TOLEDO I (1L)

1.6 i	Petrol	52	05/91 → 12/93						
1.6 i	Petrol	54	05/91 → 03/99						
1.6 i	Petrol	55	01/93 → 03/99						
1.6 i	Petrol	52	05/91 → 12/93						
1.6 i	Petrol	54	05/91 → 03/99						



TYPE

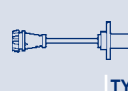

TYPE



TYPE

						SAG178	H1			
			SPA111	F1						
									BAE680BB	
			ATS23	F2		SAD031	H3			
			SPA111	F1		SAG100	H1			
			SPA111	F1		SAG166	H1		ESS0073A	J1
	SPS004		SPA111	F1		SAC085	H2		ESS0073A	J1
						SAG166	H1			
			SPA111	F1		SAC085	H2			
						SAG166	H1			
	SPS004		ATS23	F2	SAA105	SAC085	H2		ESS0073A	J1
			SPA111	F1		SAG166	H1			
			ATS23	F2						
			SPA111	F1						
			SPA111	F1					BAE680BB	
			SPA111	F1	SAA105	SAC014	H2		BAE680BB	
			SPA111	F1					BAE680BB	
									BAE680BB	
									PI024	J1
									PI024	J1
					SAA107					
					SAA107					
									BAE801EK	
						SEN8K3	H1			
					SAA107					
					SAA107					
					SAA105				BAE680CN	GA2151
					SAA105				BAE680CN	GA2151
			SPA101	F1						
					SAA107					
			SPA105	F1		SAD021	H3			
			SPA105	F1		SAD021	H3		ESS0019A	J1
			SPA106	F1		SAG178	H1		ESS0019A	J1
						SAG178	H1			
						SAG178	H1			



KW



TYPE



TYPE

SEAT

TOLEDO I (1L)

1.6 i	Petrol	54	09/96 → 03/99					
1.6 i	Petrol	55	09/96 → 03/99					
1.8 16V	Petrol	92	05/91 → 03/99					
1.8 16V	Petrol	92	05/91 → 12/94					
1.8 16V	Petrol	98	05/91 → 01/93					
1.8 16V	Petrol	98	05/91 → 12/93					
1.8 16V	Petrol	98	05/91 → 03/99					
1.8 i	Petrol	65	05/91 → 12/96					
1.8 i	Petrol	65	05/91 → 12/94					
1.8 i	Petrol	66	11/93 → 12/96					
1.8 i	Petrol	66	11/93 → 12/94					
1.8 i	Petrol	66	09/96 → 12/96					
1.9 D	Diesel	50	05/91 → 03/99					
1.9 TD	Diesel	55	05/91 → 03/99					
1.9 TDI	Diesel	66	08/95 → 03/99					
1.9 TDI	Diesel	66	08/95 → 03/99					
2.0 i	Petrol	85	09/96 → 03/99			AMM19672	B4	
2.0 i	Petrol	85	05/91 → 03/99					
2.0 i	Petrol	85	05/91 → 03/99					
2.0 i	Petrol	85	01/93 → 03/99					
2.0 i 16V	Petrol	110	11/93 → 03/99					

TOLEDO II (1M2)

1.4 16V	Petrol	55	07/99 → 05/06					
1.4 16V	Petrol	55	07/99 → 05/06					
1.4 16V	Petrol	55	07/99 → 05/06					
1.4 16V	Petrol	55	11/99 → 05/06					
1.6	Petrol	74	04/99 → 09/00			AMM19670	B4	
1.6	Petrol	74	04/99 → 09/00					
1.6	Petrol	74	04/99 → 09/00					
1.6 16V	Petrol	77	09/00 → 05/06					
1.6 16V	Petrol	77	09/00 → 05/06					
1.8 20V	Petrol	92	04/99 → 05/06					
1.8 20V	Petrol	92	04/99 → 05/06					
1.8 20V	Petrol	92	04/99 → 05/02					
1.8 20VT	Petrol	132	05/01 → 05/02					
1.8 20VT	Petrol	132	05/01 → 05/06					
1.8 20VT	Petrol	132	05/01 → 05/06					
1.9 SDI	Diesel	50	11/99 → 06/04					
1.9 SDI	Diesel	50	06/00 → 06/04					
1.9 TDI	Diesel	96	05/03 → 05/06			AMM19752	B4	
1.9 TDI	Diesel	66	04/99 → 02/03					
1.9 TDI	Diesel	66	03/03 → 07/04					
1.9 TDI	Diesel	81	04/99 → 02/03					
1.9 TDI	Diesel	81	03/03 → 12/03					

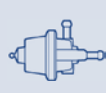

TYPE

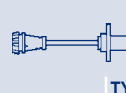

TYPE



TYPE

									ESS0042A	J1	
									ESS0042A	J1	
				SPA106	F1				ESS0019A	J1	
				SPA105	F1						
				SPA106	F1						
				SPA105	F1						
							SAD021	H3	ESS0019A	J1	
				SPA106	F1		SAD021	H3	ESS0019A	J1	
				SPA105	F1						
				SPA106	F1		SAG178	H1	ESS0019A	J1	
				SPA105	F1						
									ESS0042A	J1	
				SPA140	F1						
				SPA140	F1						
	APS29			ATS18	F2		SAG142	H1	ESS0073A	J1	
				SPA104	F1						
				ATS18	F2		SAG118	H1	ESS0019A	J1	
				SPA110	F1						
				SPA105	F1						
				ATS18	F2		SAG118	H1	ESS0019A	J1	
				ATS23	F2	SAA105	SAC014	H2	BAE680AA	ESS0016A	J1
				SPA109	F1		SAD031	H3			
							SAG178	H1			
							SAC011	H2			
				ATS23	F2		SAC015	H2	BAE680AA	ESS0016A	J1
				SPA109	F1		SAC015-1	H2			
							SAG018	H1			
				ATS23	F2	SAA105	SAC014	H2	BAE680AU	ESS0016A	J1
				SPA109	F1						
				ATS23	F2		SAG018	H1	BAE680AA	ESS0016A	J1
				SPA109	F1						
							SAC084	H2			
	APS39			ATS19	F2		SAC084	H2			
				ATS23	F2		SAG018	H1	ESS0016A	J1	
				SPA109	F1						
				ATS23	F2		SAG178	H1			
				SPA109	F1						
				ATS23	F2		SAG015	H2	ESS0073A	J1	
	APS39										
	APS40										
	APS39										
	APS40										



KW



TYPE



TYPE

SEAT

TOLEDO II (1M2)

1.9 TDI	Diesel	110	10/00 → 05/06						
1.9 TDI	Diesel	110	10/00 → 05/06						
1.9 TDI	Diesel	66	04/99 → 05/06						
1.9 TDI	Diesel	66	04/99 → 05/06						
1.9 TDI	Diesel	81	04/99 → 05/06						
1.9 TDI	Diesel	81	04/99 → 05/06						
1.9 TDI	Diesel	96	05/03 → 05/06						
2.3 V5	Petrol	110	04/99 → 05/01						
2.3 V5	Petrol	110	04/99 → 05/01						
2.3 V5	Petrol	110	04/99 → 11/00						
2.3 V5	Petrol	110	04/99 → 05/01						
2.3 V5 20V	Petrol	125	05/01 → 05/06						
2.3 V5 20V	Petrol	125	05/01 → 05/06						
2.3 V5 20V	Petrol	125	05/01 → 05/06						

TOLEDO III (5P2)

1.6	Petrol	75	10/04 → 05/09						
1.6	Petrol	75	10/04 → 05/09						
1.8 TFSI	Petrol	118	01/07 → 05/09						
1.9 TDI	Diesel	77	10/04 → 05/09						
2.0 FSI	Petrol	110	10/04 → 05/09						
2.0 FSI	Petrol	110	10/04 → 05/09						
2.0 TDi	Diesel	100	09/04 → 05/09				AMM19752	B4	
2.0 TDi	Diesel	103	12/05 → 05/09				AMM19752	B4	
2.0 TDi	Diesel	125	01/06 → 05/09				AMM19752	B4	
2.0 TDi	Diesel	100	09/04 → 05/09						
2.0 TDi	Diesel	103	11/05 → 05/09						
2.0 TDi	Diesel	125	01/06 → 05/09						
2.0 TDi 16V	Diesel	103	09/04 → 05/09				AMM19752	B4	
2.0 TDi 16V	Diesel	103	04/04 → 05/09						
2.0 TDi 16V	Diesel	103	04/04 → 05/09						
2.0 TFSI	Petrol	147	11/05 → 05/09						

SKODA

105,120 (744)

1.2 120 L	Petrol	38	10/83 → 12/90						
-----------	--------	----	---------------	--	--	--	--	--	--

CITIGO

1.0	Petrol	44	10/11 →						
1.0	Petrol	55	10/11 →						

FABIA

1.2	Petrol	44	12/06 → 03/10						
1.2	Petrol	51	01/07 → 03/10						
1.2	Petrol	44	12/06 →						
1.2	Petrol	51	01/07 →						
1.2 12V	Petrol	44	11/11 →						



KW



TYPE



TYPE

SKODA

FABIA

1.2 TDI	Diesel	55	05/10 →						
1.2 TSI	Petrol	63	03/10 →						
1.2 TSI	Petrol	77	03/10 →						
1.4	Petrol	63	01/07 →						
1.4 TDI	Diesel	59	01/07 →						
1.4 TDI	Diesel	51	02/07 → 03/10						
1.4 TSI RS	Petrol	132	05/10 →						
1.4 TSI RS	Petrol	132	05/10 →						
1.6	Petrol	77	04/07 →						
1.6 TDI	Diesel	55	04/10 →						
1.6 TDI	Diesel	66	03/10 →						
1.6 TDI	Diesel	77	03/10 →						
1.6 TDI	Diesel	66	03/10 →						
1.6 TDI	Diesel	77	03/10 →						
1.6 TDI	Diesel	66	06/10 →						
1.9 TDI	Diesel	77	04/07 →						
1.9 TDI	Diesel	77	04/07 → 03/10						

FABIA (6Y2)

1.0	Petrol	37	12/99 → 08/02						
1.0	Petrol	37	12/99 → 08/02						
1.0	Petrol	37	01/00 → 08/02	ENGINE: ARV-AQV-ATY					
1.2	Petrol	40	08/02 → 03/08						
1.2	Petrol	40	08/02 → 03/08						
1.2	Petrol	47	01/03 → 03/08						
1.2	Petrol	47	01/03 → 03/08						
1.4	Petrol	44	08/00 → 08/02						
1.4	Petrol	44	08/00 → 08/02						
1.4	Petrol	50	08/99 → 05/03						
1.4	Petrol	50	08/99 → 05/03						
1.4	Petrol	50	08/99 → 05/03	ENGINE: AME-AQW-ATZ					
1.4 16V	Petrol	55	12/99 → 03/08						
1.4 16V	Petrol	55	12/99 → 03/08						
1.4 16V	Petrol	74	12/99 → 03/08						
1.4 16V	Petrol	74	12/99 → 04/07						
1.4 16V	Petrol	55	12/99 → 03/08						
1.4 16V	Petrol	74	12/99 → 03/08						
1.4 16V	Petrol	55	12/99 → 03/08						
1.4 TDI	Diesel	55	04/03 → 03/08						
1.4 TDI	Diesel	55	04/03 → 03/08						
1.4 TDI	Diesel	59	10/05 → 03/08						
1.4 TDI	Diesel	51	10/05 → 03/08						
1.9 SDI	Diesel	47	12/99 → 03/08						
1.9 SDI	Diesel	47	12/99 → 03/08						
1.9 TDI	Diesel	74	01/00 → 04/04						

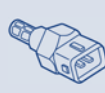

TYPE

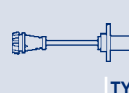

TYPE



TYPE

				SPA111	F1	SAA105					
							SAC011	H2			
							SAC011	H2			
				SPA111	F1	SAA105	SAC014	H2		GA2220	J2
		SPS004					SAG166	H1			
				SPA111	F1						
				ATS16	F2		SAC011	H2			
				SPA111	F1						
				SPA111	F1	SAA105				GA2220	J2
		SPS004		SPA111	F1	SAA105					
		SPS004		ATS16	F2						
		SPS004		ATS16	F2	SAA105					
				SPA111	F1						
				SPA111	F1						
						SAA105					
		SPS004					SAG166	H1			
				SPA111	F1						
				ATS23	F2		SAG077	H1		ESS0016A	J1
				SPA111	F1						
									BAE961AE		
				ATS23	F2	SAA105	SAC011	H2	BAE680AU	ESS0016A	J1
				SPA111	F1		SAD031	H3			
				ATS23	F2	SAA105	SAC011	H2		ESS0016A	J1
				SPA111	F1		SAD031	H3			
				ATS23	F2		SAG077	H1		ESS0016A	J1
				SPA111	F1						
				ATS23	F2		SAG077	H1		ESS0016A	J1
				SPA110	F1						
									BAE961AE		
				ATS23	F2	SAA105	SAC014	H2	BAE680AA	ESS0016A	J1
				SPA111	F1		SAD031	H3			
				ATS23	F2	SAA105	SAC014	H2		ESS0016A	J1
				SPA111	F1						
							SAG132	H1			
							SAD031	H3			
							SAG166	H1			
		APS40		ATS23	F2		SAG134	H1		GA2146	J2
				SPA111	F1						
				SPA111	F1		SAG134	H1			
							SAG134	H1			
				ATS18	F2					GA2185	J2
				SPA111	F1						
		APS39									



KW



TYPE



TYPE

SKODA

FABIA (6Y2)

1.9 TDI	Diesel	74	05/04 → 03/08						
1.9 TDI	Diesel	74	01/00 → 03/08						
1.9 TDI	Diesel	74	01/00 → 03/08						
1.9 TDI RS	Diesel	96	06/03 → 03/08				AMM19752	B4	
1.9 TDI RS	Diesel	96	06/03 → 03/08						
2.0	Petrol	85	12/99 → 03/08						
2.0	Petrol	85	12/99 → 04/07						
2.0	Petrol	85	12/99 → 03/08						
2.0	Petrol	85	12/99 → 03/08						
2.0	Petrol	85	12/99 → 03/08						
2.0	Petrol	85	12/99 → 09/01	CHASSIS: → 6Y2389395					

FABIA Combi

1.2	Petrol	44	10/07 → 03/10						
1.2	Petrol	51	10/07 → 03/10						
1.2	Petrol	44	10/07 →						
1.2	Petrol	51	10/07 →						
1.2 12V	Petrol	44	11/11 →						
1.2 TDI	Diesel	55	05/10 →						
1.2 TSI	Petrol	63	03/10 →						
1.2 TSI	Petrol	77	03/10 →						
1.4	Petrol	63	10/07 →						
1.4 TDI	Diesel	59	10/07 →						
1.4 TDI	Diesel	51	10/07 → 03/10						
1.4 TSI RS	Petrol	132	05/10 →						
1.4 TSI RS	Petrol	132	05/10 →						
1.6	Petrol	77	10/07 →						
1.6	Petrol	77	10/07 → 03/09	CHASSIS: → 5J9A509004					
1.6 TDI	Diesel	55	04/10 →						
1.6 TDI	Diesel	66	03/10 →						
1.6 TDI	Diesel	77	03/10 →						
1.6 TDI	Diesel	66	03/10 →						
1.6 TDI	Diesel	77	03/10 →						
1.6 TDI	Diesel	66	06/10 →						
1.9 TDI	Diesel	77	10/07 →						
1.9 TDI	Diesel	77	10/07 → 03/10						

FABIA Combi (6Y5)

1.2	Petrol	40	07/01 → 12/07						
1.2	Petrol	40	07/01 → 12/07						
1.2	Petrol	47	01/03 → 12/07						
1.2	Petrol	47	01/03 → 12/07						
1.4	Petrol	44	04/00 → 03/03						
1.4	Petrol	44	04/00 → 03/03						
1.4	Petrol	50	04/00 → 05/03						
1.4	Petrol	50	04/00 → 05/03						



TYPE

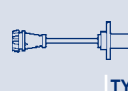

TYPE



TYPE

APPS									
APPS	TYPE	APPS	TYPE	APPS	TYPE	APPS	TYPE	APPS	TYPE
		APPS40							
				ATS23	F2			SAG015	H2
				SPA111	F1				
				ATS23	F2			SAG015	H2
				SPA111	F1				
				ATS23	F2			SAC015	H2
				SPA111	F1			BAE680AA	ESS0016A
									J1
								SAC015-1	H2
								SAD031	H3
								SAG178	H1
								SAG018	H1
				SPA111	F1				
				SPA111	F1				
						SAA105	SAC011	H2	
						SAA105	SAC011	H2	GA2220
				SPA111	F1	SAA105	SAC011	H2	
				SPA111	F1	SAA105			
							SAC011	H2	
							SAC011	H2	
				SPA111	F1	SAA105	SAC014	H2	GA2220
									J2
							SAG166	H1	
		SPS004							
				SPA111	F1				
				ATS16	F2		SAC011	H2	
				SPA111	F1				
				SPA111	F1				GA2220
									J2
						SAA105			
		SPS004		SPA111	F1	SAA105			
		SPS004		ATS16	F2				
		SPS004		ATS16	F2	SAA105			
				SPA111	F1				
				SPA111	F1				
						SAA105			
		SPS004					SAG166	H1	
				SPA111	F1				
				ATS23	F2	SAA105	SAC011	H2	
				SPA111	F1		SAD031	H3	
				ATS23	F2	SAA105	SAC011	H2	ESS0016A
				SPA111	F1		SAD031	H3	J1
				ATS23	F2		SAG077	H1	ESS0016A
				SPA111	F1				J1
				ATS23	F2		SAG077	H1	ESS0016A
				SPA110	F1				J1



KW

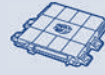

TYPE



TYPE

SKODA

FABIA Combi (6Y5)

1.4	Petrol	50	04/00 → 05/03	ENGINE: AME-AQW-ATZ					
1.4 16V	Petrol	55	05/00 → 12/07						
1.4 16V	Petrol	55	05/00 → 12/07						
1.4 16V	Petrol	59	04/06 → 12/07						
1.4 16V	Petrol	74	04/00 → 12/07						
1.4 16V	Petrol	74	04/00 → 12/07						
1.4 16V	Petrol	55	05/00 → 12/07						
1.4 16V	Petrol	55	05/00 → 12/07						
1.4 16V	Petrol	59	05/06 → 12/07						
1.4 TDI	Diesel	55	04/03 → 12/07						
1.4 TDI	Diesel	55	04/03 → 12/07						
1.4 TDI	Diesel	59	10/05 → 12/07						
1.4 TDI	Diesel	51	10/05 → 12/07						
1.9 SDI	Diesel	47	04/00 → 12/07						
1.9 SDI	Diesel	47	04/00 → 12/07						
1.9 TDI	Diesel	74	04/00 → 04/04						
1.9 TDI	Diesel	74	05/04 → 12/07						
1.9 TDI	Diesel	74	04/00 → 12/07						
1.9 TDI	Diesel	74	04/00 → 12/07						
2.0	Petrol	85	04/00 → 12/07						
2.0	Petrol	85	04/00 → 12/07						
2.0	Petrol	85	04/00 → 12/07						
2.0	Petrol	85	04/00 → 12/07						
2.0	Petrol	85	04/00 → 09/01	CHASSIS: → 6Y2389395					

FABIA Praktik

1.2	Petrol	40	07/01 → 12/07						
1.2	Petrol	47	01/03 → 12/07						
1.2	Petrol	47	01/03 → 12/07						
1.2	Petrol	40	07/01 → 12/07						
1.4	Petrol	50	07/01 → 05/03						
1.4	Petrol	50	07/01 → 05/03	ENGINE: AME-AQW-ATZ					
1.4 TDI	Diesel	51	10/05 → 12/07						
1.9 SDI	Diesel	47	07/01 → 12/07						
1.9 SDI	Diesel	47	07/01 → 12/07						

FABIA Tre volumi (6Y3)

1.2	Petrol	40	07/01 → 12/07						
1.2	Petrol	40	07/01 → 12/07						
1.2	Petrol	47	01/03 → 12/07						
1.2	Petrol	47	01/03 → 12/07						
1.4	Petrol	44	04/00 → 08/02						
1.4	Petrol	44	04/00 → 08/02						
1.4	Petrol	50	07/01 → 05/03						
1.4	Petrol	50	07/01 → 05/03						
1.4	Petrol	50	07/01 → 05/03	ENGINE: AME-AQW-ATZ					

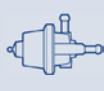

TYPE

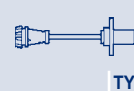

TYPE



TYPE

									BAE961AE		
			ATS23	F2	SAA105	SAC014	H2		ESS0016A	J1	
			SPA111	F1		SAD031	H3				
			SPA111	F1	SAA105	SAG166	H1				
			ATS23	F2	SAA105	SAC014	H2		ESS0016A	J1	
			SPA111	F1		SAD031	H3				
						SAG132	H1				
						SAG166	H1				
						SAC014	H2				
	APS40		ATS23	F2		SAG134	H1		GA2146	J2	
			SPA111	F1							
			SPA111	F1		SAG134	H1				
						SAG134	H1				
			ATS18	F2							
			SPA111	F1							
	APS39										
	APS40										
			ATS23	F2		SAG015	H2		GA2146	J2	
			SPA111	F1							
			ATS23	F2		SAC015	H2		ESS0016A	J1	
			SPA111	F1		SAC015-1	H2				
						SAD031	H3				
						SAG178	H1				
						SAG018	H1				
			SPA111	F1	SAA105	SAC011	H2				
			ATS23	F2	SAA105	SAC011	H2		ESS0016A	J1	
			SPA111	F1		SAD031	H3				
						SAD031	H3				
			SPA111	F1		SAG077	H1				
									BAE961AE		
						SAG134	H1				
			ATS18	F2							
			SPA111	F1							
			ATS23	F2	SAA105	SAC011	H2		ESS0016A	J1	
			SPA111	F1		SAD031	H3				
			ATS23	F2	SAA105	SAC011	H2		ESS0016A	J1	
			SPA111	F1		SAD031	H3				
			ATS23	F2		SAG077	H1		ESS0016A	J1	
			SPA111	F1							
			ATS23	F2		SAG077	H1		ESS0016A	J1	
			SPA110	F1							
									BAE961AE		



KW



TYPE



TYPE

SKODA

FABIA Tre volumi (6Y3)

1.4 16V	Petrol	55	10/99 → 12/07						
1.4 16V	Petrol	55	10/99 → 12/07						
1.4 16V	Petrol	59	04/06 → 12/07						
1.4 16V	Petrol	74	12/99 → 12/07						
1.4 16V	Petrol	74	05/02 → 12/07						
1.4 16V	Petrol	55	10/99 → 12/07						
1.4 16V	Petrol	74	12/99 → 12/07						
1.4 16V	Petrol	55	10/99 → 12/07						
1.4 16V	Petrol	59	05/06 → 12/07						
1.4 TDI	Diesel	55	04/03 → 12/07						
1.4 TDI	Diesel	55	04/03 → 12/07						
1.4 TDI	Diesel	59	10/05 → 12/07						
1.4 TDI	Diesel	51	10/05 → 12/07						
1.9 SDI	Diesel	47	11/99 → 12/07						
1.9 SDI	Diesel	47	11/99 → 12/07						
1.9 TDI	Diesel	74	01/00 → 04/04						
1.9 TDI	Diesel	74	05/04 → 12/07						
1.9 TDI	Diesel	74	01/00 → 12/07						
1.9 TDI	Diesel	74	01/00 → 12/07						
2.0	Petrol	85	12/99 → 12/07						
2.0	Petrol	85	12/99 → 04/07						
2.0	Petrol	85	12/99 → 12/07						
2.0	Petrol	85	12/99 → 12/07						
2.0	Petrol	85	12/99 → 12/07						
2.0	Petrol	85	12/99 → 09/01	CHASSIS: → 6Y2389395					

FAVORIT (781)

1.3 (781)	Petrol	50	01/94 → 09/94						
1.3 135 (781)	Petrol	42	12/91 → 09/94						
1.3 135 (781)	Petrol	43	12/91 → 09/94						
1.3 135 (781)	Petrol	44	10/90 → 09/94						
1.3 135 X,LX,GLX (781)	Petrol	40	01/90 → 09/94						
1.3 135L (781)	Petrol	43	05/89 → 09/94						
1.3 136 (781)	Petrol	45	10/90 → 09/94						

FAVORIT Forman (785)

1.3	Petrol	50	01/94 → 06/95						
1.3 (135 E)	Petrol	40	09/91 → 06/95						
1.3 (135)	Petrol	44	12/91 → 06/95						
1.3 (136)	Petrol	45	01/93 → 06/95						

FELICIA I (6U1)

1.3	Petrol	40	10/94 → 03/98						
1.3	Petrol	43	10/94 → 03/98						
1.3	Petrol	43	02/96 → 03/98						
1.3	Petrol	50	10/94 → 03/98						
1.6 LX	Petrol	55	08/95 → 03/98						

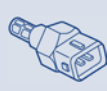
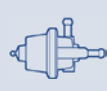

TYPE

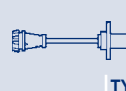

TYPE



TYPE

			ATS23	F2	SAA105	SAC014	H2		ESS0016A	J1
			SPA111	F1		SAD031	H3			
			SPA111	F1	SAA105	SAG166	H1			
			ATS23	F2	SAA105	SAC014	H2		ESS0016A	J1
			SPA111	F1						
						SAG132	H1			
						SAD031	H3			
						SAG166	H1			
						SAC014	H2			
	APS40		ATS23	F2		SAG134	H1		GA2146	J2
			SPA111	F1						
			SPA111	F1		SAG134	H1			
						SAG134	H1			
			ATS18	F2						
			SPA111	F1						
	APS39									
	APS40									
			ATS23	F2		SAG015	H2		GA2146	J2
			SPA111	F1						
			ATS23	F2		SAC015	H2		ESS0016A	J1
			SPA111	F1						
						SAC015-1	H2			
						SAD031	H3			
						SAG178	H1			
						SAG018	H1			
			SPA104	F1						
			SPA104	F1						
			SPA104	F1						
			SPA104	F1						
			SPA104	F1						
			SPA104	F1						
			SPA104	F1						
			SPA104	F1						
			SPA104	F1						
			SPA104	F1						
			SPA104	F1						
			SPA110	F1						
			SPA104	F1						
IWP023			SPA104	F1						



KW



TYPE



TYPE

SKODA

FELICIA I Fun (797)

1.3	Petrol	40	06/97 → 04/02					
1.3	Petrol	50	06/97 → 04/02					
1.6	Petrol	55	06/97 → 04/02			TB0010	B3	
1.9 D	Diesel	47	06/97 → 04/02					

FELICIA I Station wagon (6U5)

1.3	Petrol	43	08/95 → 03/98					
1.3 LX	Petrol	40	08/95 → 03/98					
1.3 LXI	Petrol	50	08/95 → 03/98					
1.6 GLX	Petrol	55	08/95 → 03/98			TB0010	B3	

FELICIA II (6U1)

1.3	Petrol	40	01/98 → 06/01					
1.3	Petrol	43	01/98 → 06/01					
1.3	Petrol	50	01/98 → 06/01					
1.3	Petrol	40	01/98 → 06/01	ENGINE: AMG-AMJ				
1.3	Petrol	43	01/98 → 06/01	ENGINE: AMG-AMJ				
1.3	Petrol	50	01/98 → 06/01	ENGINE: AMG-AMJ				
1.6	Petrol	55	01/98 → 06/01					

FELICIA II Station wagon (6U5)

1.3	Petrol	50	01/98 → 06/01					
1.3	Petrol	50	01/98 → 06/01	ENGINE: AMG-AMJ				
1.6	Petrol	55	01/98 → 06/01					
1.6	Petrol	55	01/98 → 06/01	ENGINE: AMG-AMJ				

OCTAVIA (1U2)

1.4	Petrol	44	04/99 → 03/01					
1.4	Petrol	44	04/99 → 03/01	CHASSIS: 1UX134201 →				
1.4	Petrol	44	04/99 → 03/01	ENGINE: AMD				
1.4 16V	Petrol	55	09/00 → 12/10	ENGINE: AXP,BCA				
1.4 16V	Petrol	55	09/00 → 12/10					
1.4 16V	Petrol	55	09/00 → 12/10					
1.6	Petrol	75	11/00 → 12/10					
1.6	Petrol	75	11/00 → 12/10					
1.6	Petrol	75	11/00 → 12/10	CHASSIS: → 1U38668598				
1.6	Petrol	75	11/00 → 12/10	CHASSIS: → 1U38668598				
1.8 T	Petrol	110	02/03 → 09/04					
1.8 T	Petrol	110	03/98 → 01/03					
1.8 T	Petrol	110	08/97 → 12/10	CHASSIS: 1UX134201 →				
1.8 T	Petrol	110	08/97 → 12/10	CHASSIS: F1UX228001 →				
1.8 T	Petrol	110	03/98 → 09/02					
1.8 T	Petrol	110	10/02 → 12/10					
1.8 T	Petrol	110	08/97 → 12/10					
1.8 T	Petrol	110	08/97 → 12/10					
1.8 T	Petrol	110	08/97 → 12/10					
1.8 T	Petrol	110	01/99 → 12/10					
1.8 T 4x4	Petrol	110	05/01 → 01/03					



TYPE

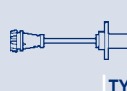

TYPE



TYPE

SPA104	F1
SPA104	F1
SPA104	F1
SPA140	F1

SPA104	F1
SPA104	F1
SPA104	F1
SPA104	F1

SPA110	F1
SPA110	F1
SPA110	F1

BAE960AE
BAE960AE
BAE960AE

SPA110	F1
--------	----

SPA110	F1
--------	----

BAE960AE

SPA110	F1
--------	----

BAE960AE

ATS23	F2	SAG077	H1	BAE680AA	ESS0016A	J1
SPA109	F1					

BAE961AE

IWP092

ATS23	F2	SAA105	SAC014	H2	ESS0016A	J1
SPA109	F1		SAD031	H3		
ATS23	F2		SAD031	H3	ESS0016A	J1
SPA109	F1					

SAC015	H2
SAC015-1	H2

 APS40
 APS39

SPA109	F1
ATS23	F2
ATS19	F2
ATS13	F2

SAC084	H2	ESS0016A	J1
SAD031	H3	GA2226	J2
SAG178	H1		
SAG018	H1		

APS39



KW



TYPE



TYPE

SKODA

OCTAVIA (1U2)

1.8 T 4x4	Petrol	110	02/03 → 09/04					
1.8 T 4x4	Petrol	110	05/01 → 05/06					
1.8 T 4x4	Petrol	110	05/01 → 05/06					
1.8 T 4x4	Petrol	110	05/01 → 09/02					
1.8 T 4x4	Petrol	110	10/02 → 05/06					
1.9 SDI	Diesel	50	06/97 → 12/03					
1.9 SDI	Diesel	50	06/97 → 12/03	CHASSIS: 1UX134201 →				
1.9 SDI	Diesel	50	06/97 → 05/99	CHASSIS: → 1UxxYxx284729				
1.9 TDI	Diesel	96	12/02 → 09/04			AMM19752	B4	
1.9 TDI	Diesel	81	08/97 → 02/03					
1.9 TDI	Diesel	81	03/03 → 09/04					
1.9 TDI	Diesel	74	10/05 → 12/10					
1.9 TDI	Diesel	81	08/97 → 01/06	CHASSIS: 1UX134201 →				
1.9 TDI	Diesel	81	08/97 → 01/06	CHASSIS: F1UX228001 →				
1.9 TDI	Diesel	96	09/02 → 09/04					
1.9 TDI	Diesel	96	09/02 → 09/04					
1.9 TDI	Diesel	81	08/97 → 01/06					
1.9 TDI	Diesel	81	08/97 → 05/99	CHASSIS: → 1UxxYxx284729				
2.0	Petrol	85	04/99 → 05/07					
2.0	Petrol	85	04/99 → 05/07	CHASSIS: 1UX134201 →				
2.0	Petrol	85	04/99 → 05/07					
2.0	Petrol	85	04/99 → 05/07					
2.0	Petrol	85	04/99 → 10/06					
RS 1.8 T	Petrol	132	05/01 → 01/03					
RS 1.8 T	Petrol	132	02/03 → 09/04					
RS 1.8 T	Petrol	132	05/01 → 01/06					
RS 1.8 T	Petrol	132	05/01 → 01/06					
RS 1.8 T	Petrol	132	05/01 → 09/02					
RS 1.8 T	Petrol	132	10/02 → 01/06					
RS 1.8 T	Petrol	132	05/01 → 09/04					

OCTAVIA (1Z3)

1.2 TSI	Petrol	77	02/10 →					
1.4	Petrol	59	06/04 →					
1.4	Petrol	55	05/04 → 05/06					
1.4	Petrol	55	05/04 → 05/06					
1.4	Petrol	55	05/04 → 05/06					
1.4	Petrol	59	05/06 →					
1.4	Petrol	55	05/04 → 05/06	ENGINE: AMD				
1.4 TSI	Petrol	90	11/08 →					
1.6	Petrol	75	06/04 →					
1.6	Petrol	75	06/04 →					
1.6 FSI	Petrol	85	02/04 → 10/08					
1.6 FSI	Petrol	85	02/04 → 10/08					
1.6 FSI	Petrol	85	02/04 → 08/04					

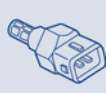
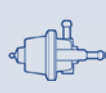

TYPE

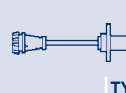

TYPE



TYPE

APS40											
				ATS23	F2		SAC084	H2	BAE680AW	ESS0016A	J1
				SPA109	F1		SAG018	H1		GA2226	J2
				ATS19	F2						
				ATS13	F2						
				ATS18	F2					ESS0073A	J1
				SPA109	F1						
							SAG138	H1			
							SAG015	H2			
APS39											
APS40											
				SPA109	F1		SAG015	H2		ESS0073A	J1
				SPA109	F1						
				ATS23	F2						
				ATS23	F2					ESS0073A	J1
				SPA109	F1						
							SAG178	H1		ESS0073A	J1
							SAG138	H1			
				ATS23	F2		SAC015	H2	BAE680AA	ESS0016A	J1
				SPA109	F1						
							SAC015-1	H2			
							SAG178	H1			
							SAG018	H1			
APS39											
APS40											
				ATS23	F2		SAD031	H3		ESS0016A	J1
				SPA109	F1						
				ATS19	F2						
				ATS13	F2						
							SAC084	H2			
							SAC011	H2			
IWP163											
				SPA111	F1				BAE680AU		
				ATS23	F2	SAA105	SAC014	H2			
				SPA111	F1		SAD031	H3			
							SAG166	H1			
						SAA105	SAC014	H2			
									BAE961AE		
				SPA111	F1	SAA105	SAC011	H2			
				ATS23	F2		SAC075	H2			
				SPA111	F1		SAD031	H3			
				ATS23	F2	SAA105	SAD031	H3	BAE680AU	ESS0045A	J1
				SPA111	F1		SAG166	H1		GA2226	J2
				ATS13	F2						



KW

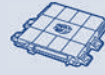

TYPE



TYPE

SKODA

OCTAVIA (1Z3)

1.6 FSI	Petrol	85	05/04 → 10/08						
1.6 LPG	Petrol/LPG	75	08/09 →						
1.6 Multifuel	Petrol/Ethanol	75	01/08 → 05/10						
1.6 TDI	Diesel	77	06/09 →						
1.8 TSI	Petrol	118	06/07 →						
1.9 TDI	Diesel	77	06/04 → 12/10						
1.9 TDI	Diesel	77	06/04 → 12/10						
2.0 FSI	Petrol	110	11/04 →						
2.0 FSI	Petrol	110	11/04 →						
2.0 FSI	Petrol	110	11/04 →						
2.0 RS	Petrol	147	10/05 →						
2.0 RS	Petrol	147	11/08 →						
2.0 TDi	Diesel	100	02/04 → 05/10					AMM19752	B4
2.0 TDi	Diesel	103	11/05 →					AMM19752	B4
2.0 TDi	Diesel	100	02/04 → 05/10						
2.0 TDi 16V	Diesel	103	02/04 →					AMM19752	B4
2.0 TDi 16V	Diesel	103	02/04 →						
2.0 TDi RS	Diesel	125	04/06 →					AMM19752	B4

OCTAVIA Combi (1U5)

1.4 16V	Petrol	55	08/00 → 12/10	ENGINE: AXP,BCA					
1.4 16V	Petrol	55	08/00 → 12/10						
1.4 16V	Petrol	55	08/00 → 12/10						
1.6	Petrol	74	07/98 → 12/07					AMM19670	B4
1.6	Petrol	55	07/98 → 09/04						
1.6	Petrol	55	07/98 → 09/04						
1.6	Petrol	74	07/98 → 12/07						
1.6	Petrol	74	08/00 → 12/07	CHASSIS: 1UX134201 →					
1.6	Petrol	75	09/00 → 12/10						
1.6	Petrol	75	09/00 → 12/10						
1.6	Petrol	74	07/98 → 12/07						
1.6	Petrol	75	09/00 → 12/10	CHASSIS: → 1U38668597					
1.6	Petrol	75	09/00 → 12/10	CHASSIS: → 1U38668597					
1.8 20V	Petrol	92	07/98 → 07/00						
1.8 20V	Petrol	92	07/98 → 07/00	CHASSIS: 1UX134201 →					
1.8 20V	Petrol	92	07/98 → 04/99						
1.8 20V	Petrol	92	07/98 → 07/00						
1.8 T	Petrol	110	07/98 → 01/03						
1.8 T	Petrol	110	02/03 → 09/04						
1.8 T	Petrol	110	07/98 → 12/10						
1.8 T	Petrol	110	07/98 → 12/10	CHASSIS: 1UX134201 →					
1.8 T	Petrol	110	07/98 → 09/02						
1.8 T	Petrol	110	10/02 → 12/10						
1.8 T	Petrol	110	07/98 → 12/10						
1.8 T	Petrol	110	07/98 → 09/04						



TYPE

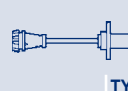

TYPE



TYPE

						SAC011	H2			
			SPA111	F1						
			SPA111	F1						
			SPA111	F1	SAA105					
			SPA111	F1				BAE680BB		
	APS40		ATS23	F2		SAC073	H2		ESS0073A	J1
			SPA111	F1		SAG166	H1			
			ATS23	F2		SAC073	H2			
			SPA111	F1		SAD031	H3			
						SAG100	H1			
			SPA111	F1						
								BAE680BB		
			SPA111	F1		SAC085	H2			
			SPA111	F1		SAG166	H1		ESS0073A	J1
						SAG166	H1			
	SPS004		ATS23	F2	SAA105	SAC073	H2		ESS0045A	J1
			SPA111	F1		SAG166	H1			
			SPA111	F1		SAG155	H1			
	IWP092									
			ATS23	F2	SAA105	SAC014	H2		ESS0016A	J1
			SPA109	F1						
			ATS23	F2		SAC015	H2		ESS0016A	J1
			ATS23	F2		SAD028	H3		ESS0016A	J1
			SPA109	F1						
						SAC015-1	H2		GA2226	J2
			SPA109	F1						
			ATS23	F2					ESS0016A	J1
			SPA109	F1						
						SAG018	H1			
						SAC015	H2			
						SAC015-1	H2			
			ATS23	F2		SAG018	H1		ESS0016A	J1
			SPA109	F1						
			ATS19	F2		SAC084	H2			
									GA2226	J2
	APS39									
	APS40									
			ATS23	F2		SAG178	H1		ESS0016A	J1
			SPA109	F1						
			ATS19	F2						
			ATS13	F2						
									GA2226	J2
						SAC084	H2			



KW



TYPE



TYPE

SKODA

OCTAVIA Combi (1U5)

1.8 T	Petrol	110	01/99 → 12/10					
1.8 T 4x4	Petrol	110	05/01 → 01/03					
1.8 T 4x4	Petrol	110	02/03 → 09/04					
1.8 T 4x4	Petrol	110	05/01 → 05/06					
1.8 T 4x4	Petrol	110	05/01 → 05/06					
1.8 T 4x4	Petrol	110	05/01 → 09/02					
1.8 T 4x4	Petrol	110	10/02 → 05/06					
1.8 T 4x4	Petrol	110	05/01 → 09/04					
1.9 SDI	Diesel	50	07/98 → 12/03					
1.9 SDI	Diesel	50	07/98 → 12/03	CHASSIS: 1UX134201 →				
1.9 SDI	Diesel	50	07/98 → 05/99	CHASSIS: → 1UxxYxx284729				
1.9 TDI	Diesel	96	12/02 → 09/04			AMM19752	B4	
1.9 TDI	Diesel	66	07/98 → 02/03					
1.9 TDI	Diesel	66	03/03 → 09/04					
1.9 TDI	Diesel	81	07/98 → 02/03					
1.9 TDI	Diesel	81	03/03 → 09/04					
1.9 TDI	Diesel	66	07/98 → 03/10					
1.9 TDI	Diesel	66	07/98 → 03/10	CHASSIS: 1UX134201 →				
1.9 TDI	Diesel	74	08/00 → 12/10					
1.9 TDI	Diesel	81	07/98 → 01/06					
1.9 TDI	Diesel	81	07/98 → 01/06	CHASSIS: 1UX134201 →				
1.9 TDI	Diesel	96	09/02 → 09/04					
1.9 TDI	Diesel	96	09/02 → 09/04					
1.9 TDI	Diesel	66	07/98 → 05/99	CHASSIS: → 1UxxYxx284729				
1.9 TDI	Diesel	81	07/98 → 05/99	CHASSIS: → 1UxxYxx284729				
1.9 Tdi 4x4	Diesel	66	11/99 → 02/06					
1.9 Tdi 4x4	Diesel	74	09/00 → 02/03					
1.9 Tdi 4x4	Diesel	74	03/03 → 09/04					
1.9 Tdi 4x4	Diesel	66	11/99 → 02/06					
1.9 Tdi 4x4	Diesel	74	09/00 → 01/06					
1.9 Tdi 4x4	Diesel	74	09/00 → 01/06					
2.0	Petrol	85	04/99 → 05/07					
2.0	Petrol	85	04/99 → 05/07	CHASSIS: 1UX134201 →				
2.0	Petrol	85	04/99 → 05/07					
2.0	Petrol	85	04/99 → 05/07					
2.0	Petrol	85	04/99 → 05/07					
2.0	Petrol	85	04/99 → 10/06					
2.0 4x4	Petrol	85	08/00 → 09/04					
2.0 4x4	Petrol	85	08/00 → 09/04					
2.0 4x4	Petrol	88	01/00 → 12/10					
2.0 4x4	Petrol	88	01/00 → 12/10					
RS 1.8 T	Petrol	132	08/02 → 01/03					
RS 1.8 T	Petrol	132	02/03 → 09/04					
RS 1.8 T	Petrol	132	08/02 → 01/06					



TYPE



TYPE



TYPE

						SAG018	H1		
	APS39								
	APS40								
			ATS23	F2		SAG018	H1	ESS0016A	J1
			SPA109	F1					
			ATS19	F2					
			ATS13	F2					
						SAC084	H2		
			ATS18	F2				ESS0073A	J1
			SPA109	F1					
						SAG138	H1		
						SAG015	H2		
	APS39								
	APS40								
	APS39								
	APS40								
			ATS23	F2				ESS0073A	J1
			SPA109	F1					
			SPA109	F1		SAG015	H2	ESS0073A	J1
			ATS23	F2		SAG178	H1	ESS0073A	J1
			SPA109	F1					
			ATS23	F2				ESS0073A	J1
			SPA109	F1					
						SAG138	H1		
						SAG138	H1		
	APS39		ATS23	F2				ESS0073A	J1
	APS39								
	APS40								
			SPA109	F1					
			ATS23	F2		SAG015	H2	ESS0073A	J1
			SPA109	F1					
			ATS23	F2		SAC015	H2	ESS0016A	J1
			SPA109	F1					
						SAC015-1	H2		
						SAD028	H3		
						SAG178	H1		
						SAG018	H1		
			ATS23	F2		SAG018	H1	ESS0016A	J1
			SPA109	F1					
			ATS23	F2		SAG018	H1	ESS0016A	J1
			SPA109	F1					
	APS39								
	APS40								
			ATS23	F2				ESS0016A	J1



KW



TYPE



TYPE

SKODA

OCTAVIA Combi (1U5)

RS 1.8 T	Petrol	132	08/02 → 01/06					
RS 1.8 T	Petrol	132	10/02 → 01/06					
RS 1.8 T	Petrol	132	08/02 → 09/04					

OCTAVIA Combi (1Z5)

1.2 TSI	Petrol	77	02/10 →					
1.4	Petrol	59	05/06 →					
1.4 TSI	Petrol	90	11/08 →					
1.6	Petrol	75	09/04 →					
1.6	Petrol	75	09/04 →					
1.6 FSI	Petrol	85	02/04 → 10/08					
1.6 FSI	Petrol	85	02/04 → 10/08					
1.6 FSI	Petrol	85	09/04 → 10/08					
1.6 LPG	Petrol/LPG	75	08/09 →					
1.6 Multifuel	Petrol/Ethanol	75	01/08 → 05/10					
1.6 TDI	Diesel	77	06/09 →					
1.6 TDI 4x4	Diesel	77	06/09 →					
1.8 TSI	Petrol	118	06/07 →					
1.8 TSI 4x4	Petrol	118	11/08 →					
1.8 TSI 4x4	Petrol	118	11/09 →					
1.9 TDI	Diesel	77	09/04 → 12/10					
1.9 TDI	Diesel	77	09/04 → 12/10					
1.9 Tdi 4x4	Diesel	77	11/04 → 12/10					
1.9 Tdi 4x4	Diesel	77	11/04 → 12/10					
2.0 FSI	Petrol	110	11/04 →					
2.0 FSI	Petrol	110	11/04 →					
2.0 FSI 4x4	Petrol	110	11/04 →					
2.0 FSI 4x4	Petrol	110	11/04 →					
2.0 RS	Petrol	147	10/05 →					
2.0 RS	Petrol	147	11/08 →					
2.0 TDi	Diesel	103	11/05 →				AMM19752	B4
2.0 TDI 16V	Diesel	100	02/04 → 05/10				AMM19752	B4
2.0 TDI 16V	Diesel	103	02/04 →				AMM19752	B4
2.0 TDI 16V	Diesel	103	02/04 →					
2.0 TDI 16V	Diesel	100	02/04 → 05/10					
2.0 TDI 4x4	Diesel	103	07/06 →				AMM19752	B4
2.0 TDI 4x4	Diesel	81	05/11 →					
2.0 TDI RS	Diesel	125	04/06 →				AMM19752	B4

ROOMSTER (5J)

1.2	Petrol	47	05/06 → 01/07					
1.2	Petrol	51	01/07 →					
1.2	Petrol	47	05/06 → 01/07					
1.2 TSI	Petrol	63	03/10 →					
1.2 TSI	Petrol	77	03/10 →					
1.4	Petrol	63	09/06 →					

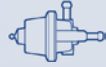

TYPE



TYPE



TYPE

			SPA109	F1							
			ATS13	F2							
						SAC084	H2				
						SAC011	H2				
			SPA111	F1	SAA105	SAC014	H2				
			SPA111	F1	SAA105	SAC011	H2				
			ATS23	F2		SAC075	H2				
			SPA111	F1							
			ATS13	F2	SAA105	SAG166	H1				
			SPA111	F1							
						SAC011	H2				
			SPA111	F1							
			SPA111	F1	SAA105						
			SPA111	F1	SAA105						
			SPA111	F1				BAE680BB			
			SPA111	F1				BAE680BB			
	APS40		ATS23	F2		SAC073	H2		ESS0073A	J1	
			SPA111	F1		SAG166	H1				
	APS40		ATS23	F2		SAC073	H2		ESS0073A	J1	
			SPA111	F1		SAG166	H1				
			ATS23	F2		SAC073	H2				
			SPA111	F1		SAG100	H1				
			ATS23	F2		SAC073	H2				
			SPA111	F1		SAG100	H1				
			SPA111	F1							
								BAE680BB			
			SPA111	F1		SAG166	H1		ESS0073A	J1	
			SPA111	F1		SAC085	H2				
	SPS004		ATS23	F2	SAA105	SAC073	H2		ESS0073A	J1	
			SPA111	F1		SAG166	H1				
						SAG166	H1				
			SPA111	F1		SAG166	H1		ESS0073A	J1	
	SPS004		SPA111	F1	SAA105						
			SPA111	F1		SAG155	H1				
			SPA111	F1	SAA105	SAC011	H2				
			SPA111	F1	SAA105	SAC011	H2				
						SAD031	H3				
						SAC011	H2				
						SAC011	H2				
			SPA111	F1	SAA105	SAC011	H2				



KW



TYPE



TYPE

SKODA

ROOMSTER (5J)

1.4	Petrol	63	09/06 →					
1.4	Petrol	63	09/06 →					
1.4 TDI	Diesel	51	07/06 → 03/10					
1.4 TDI	Diesel	59	09/06 → 03/10					
1.4 TDI	Diesel	59	09/06 → 03/10					
1.6	Petrol	77	09/06 →					
1.6	Petrol	77	09/06 →					
1.6	Petrol	77	09/06 →	CHASSIS: → 5J75011488				
1.6	Petrol	77	09/06 → 12/10					
1.6 TDI	Diesel	66	03/10 →					
1.6 TDI	Diesel	77	03/10 →					
1.9 TDI	Diesel	74	03/06 → 05/06					
1.9 TDI	Diesel	77	09/06 → 03/10					

ROOMSTER Praktik (5J)

1.2	Petrol	51	03/07 →					
1.2 TDI	Diesel	55	03/10 →					
1.2 TSI	Petrol	63	03/10 →					
1.4	Petrol	63	03/07 →					
1.4 TDI	Diesel	51	03/07 → 03/10					
1.4 TDI	Diesel	59	03/07 → 03/10					
1.6 TDI	Diesel	66	03/10 →					

SUPERB (3T4)

1.4 TSI	Petrol	92	07/08 →					
1.4 TSI	Petrol	92	07/08 → 03/09					
1.4 TSI	Petrol	92	07/08 →					
1.8 TSI	Petrol	118	03/08 →					
1.8 TSI	Petrol	118	03/08 → 05/09					
1.8 TSI 4x4	Petrol	118	11/08 →					
1.9 TDI	Diesel	77	03/08 →					
2.0 TDi	Diesel	103	06/08 →			AMM19752		B4
2.0 TDi	Diesel	125	07/08 →					
2.0 TDi	Diesel	103	03/08 → 03/10					
2.0 TDi	Diesel	125	07/08 →					
2.0 TDi	Diesel	103	03/08 →					
2.0 TDI 16V	Diesel	103	01/09 →					
2.0 TDI 16V	Diesel	103	01/09 →					
2.0 TDI 16V 4x4	Diesel	103	11/10 →					
2.0 TDI 4x4	Diesel	125	09/08 →					
2.0 TDI 4x4	Diesel	125	09/08 →					
3.6 V6 4x4	Petrol	191	11/08 →					



TYPE

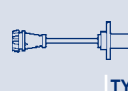

TYPE



TYPE

							SAD031	H3		
							SAG166	H1		
			SPA111	F1			SAG134	H1		
			SPA111	F1			SAG134	H1		
							SAG166	H1		
			SPA111	F1	SAA105		SAD031	H3		
							SAG132	H1		
							SAG166	H1		
							SAC011	H2		
		SPS004	SPA111	F1	SAA105					
		SPS004	SPA111	F1	SAA105					
			SPA111	F1						
			SPA111	F1			SAG166	H1	ESS0073A	J1
			SPA111	F1	SAA105		SAC011	H2		
		SPS004	SPA111	F1	SAA105					
							SAC011	H2		
			SPA111	F1	SAA105		SAC011	H2		
			SPA111	F1						
			SPA111	F1			SAG166	H1		
		SPS004	SPA111	F1	SAA105					
			SPA111	F1			SAC011	H2		
					SAA105					
							SAG155	H1		
			SPA111	F1						
									BAE680BB	
			SPA111	F1						
			SPA111	F1			SAG166	H1		
		SPS004	ATS16	F2	SAA105		SAG155	H1		
			SPA111	F1						
			SPA111	F1						
							SAG166	H1		
			ATS16	F2	SAA105					
			SPA111	F1						
			SPA111	F1	SAA105					
		SPS004	ATS16	F2	SAA105		SAG155	H1		
			SPA111	F1						
			SPA111	F1			SAC011	H2		



KW

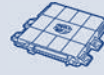

TYPE



TYPE

SKODA

SUPERB (3U4)

1.8 T	Petrol	110	12/01 → 12/02						
1.8 T	Petrol	110	12/01 → 03/08						
1.8 T	Petrol	110	12/01 → 03/08						
1.9 TDI	Diesel	77	10/05 → 05/07				AMM19752	B4	
1.9 TDI	Diesel	85	01/07 → 03/08				AMM19752	B4	
1.9 TDI	Diesel	96	01/02 → 03/08				AMM19752	B4	
1.9 TDI	Diesel	74	08/02 → 10/05						
1.9 TDI	Diesel	96	12/01 → 03/08						
2.0	Petrol	85	12/01 → 03/08						
2.0	Petrol	85	12/01 → 03/08						
2.0	Petrol	85	12/01 → 03/08						
2.0 TDi	Diesel	103	10/05 → 03/08				AMM19752	B4	
2.5 TDI	Diesel	114	12/01 → 08/03				AMM19769	B4	
2.5 TDI	Diesel	120	06/03 → 03/08				AMM19769	B4	
2.5 TDI	Diesel	114	12/01 → 07/03						
2.5 TDI	Diesel	114	12/01 → 08/03						
2.8 V6	Petrol	142	01/02 → 03/08				AMM19671	B4	
2.8 V6	Petrol	142	12/01 → 03/08						
2.8 V6	Petrol	142	12/01 → 03/08						

SUPERB Station wagon (3T5)

1.4 TSI	Petrol	92	10/09 →						
1.8 TSI	Petrol	118	10/09 →						
1.8 TSI 4x4	Petrol	118	10/09 →						
1.9 TDI	Diesel	77	10/09 → 11/10						
2.0 TDi	Diesel	125	10/09 →						
2.0 TDi	Diesel	103	10/09 → 03/10						
2.0 TDi	Diesel	125	10/09 →						
2.0 TDi 16V	Diesel	103	10/09 →						
2.0 TDi 16V	Diesel	103	10/09 →						
2.0 TDi 16V 4x4	Diesel	103	11/10 →						
2.0 TDi 4x4	Diesel	125	10/09 →						
2.0 TDi 4x4	Diesel	125	10/09 →						
3.6 V6 4x4	Petrol	191	10/09 →						

YETI (5L)

1.2 TSI	Petrol	77	09/09 →						
1.2 TSI	Petrol	77	09/09 →						
1.4 TSI	Petrol	90	06/10 →						
1.8 TSI 4x4	Petrol	112	11/09 →						
1.8 TSI 4x4	Petrol	118	05/09 →						
1.8 TSI 4x4	Petrol	112	08/11 →						
1.8 TSI 4x4	Petrol	118	08/11 →						
2.0 TDi	Diesel	103	11/11 →						
2.0 TDi	Diesel	81	11/09 →						
2.0 TDi 4x4	Diesel	103	05/09 →						

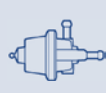

TYPE

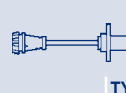

TYPE



TYPE

		APS39								
			ATS13	F2		SAC084	H2	BAE680AW	ESS0016A	J1
			SPA109	F1		SAG017	H1			
			SPA109	F1						
			SPA109	F1						
		APS40	SPA109	F1						
			SPA109	F1						
			SPA109	F1		SAC015	H2	BAE680AA	ESS0016A	J1
						SAC015-1	H2			
						SAG018	H1			
			SPA109	F1						
			SGA115	F3		SAG017	H1			
		APS40	SPA109	F1		SAG017	H1			
		APS39								
			SPA109	F1						
			ATS13	F2		SAC084	H2		ESS0016A	J1
			SPA109	F1		SAG018	H1			
			SPA111	F1		SAC011	H2			
			SPA111	F1						
			SPA111	F1						
			SPA111	F1						
		SPS004	ATS16	F2	SAA105					
			SPA111	F1	SAA105					
			SPA111	F1						
			ATS16	F2	SAA105					
			SPA111	F1						
			SPA111	F1	SAA105					
		SPS004	ATS16	F2	SAA105					
			SPA111	F1						
			SPA111	F1		SAC011	H2			
			SPA111	F1		SAC011	H2			
						SAG155	H1			
			SPA111	F1		SAC011	H2			
			SPA111	F1						
			SPA111	F1				BAE680BB		
								BAE680BB		
			SPA111	F1	SAA105					
			SPA111	F1		SAG155	H1			
			ATS16	F2	SAA105	SAG155	H1			



KW



TYPE



TYPE

SKODA

YETI (5L)

2.0 TDI 4x4	Diesel	103	05/09 →						
2.0 TDI 4x4	Diesel	125	11/09 →						
2.0 TDI 4x4	Diesel	125	11/09 →						
2.0 TDI 4x4	Diesel	81	11/09 →						
2.0 TDI 4x4	Diesel	81	11/09 →						

SMART

CABRIO (450)

0.6 (450.400, S1OLD2)	Petrol	45	01/01 → 01/04						
0.6 (450.400, S1OLD2)	Petrol	45	01/01 → 01/04						
0.6 (450.432)	Petrol	52	06/02 → 01/04						
0.6 (450.432)	Petrol	52	06/02 → 01/04						
0.6 (450.433, S1OLA1)	Petrol	40	03/00 → 01/04						
0.6 (450.433, S1OLA1)	Petrol	40	03/00 → 01/04						
0.7 (450.400)	Petrol	45	01/03 → 01/04						
0.7 (450.400)	Petrol	45	01/03 → 01/04						
0.7 (450.414)	Petrol	55	01/03 → 01/04						
0.7 (450.414)	Petrol	55	01/03 → 01/04						
0.8 CDI (450.401, 450.402, 450.403, S1OLC1)	Diesel	30	03/01 → 01/04						
0.8 CDI (450.401, 450.402, 450.403, S1OLC1)	Diesel	30	03/01 → 01/04						

CITY-COUPE (450)

0.6 (450.330, 450.332)	Petrol	52	06/02 → 01/04						
0.6 (450.330, 450.332)	Petrol	52	06/02 → 01/04						
0.6 (450.333, 450.335)	Petrol	45	01/01 → 01/04						
0.6 (450.333, 450.335)	Petrol	45	01/01 → 12/02						
0.6 (450.333, 450.335)	Petrol	45	01/01 → 01/04						
0.6 (450.341, S1CLA1)	Petrol	40	07/98 → 01/04						
0.6 (450.341, S1CLA1)	Petrol	40	07/98 → 01/04						
0.6 (450.342, S1CLB1)	Petrol	33	07/98 → 01/04						
0.6 (450.342, S1CLB1)	Petrol	33	07/98 → 01/04						
0.7 (450.314)	Petrol	55	01/03 → 01/04						
0.7 (450.314)	Petrol	55	01/03 → 01/04						
0.7 (450.336, 450.352, 450.353)	Petrol	45	01/03 → 01/04						
0.7 (450.336, 450.352, 450.353)	Petrol	45	01/03 → 01/04						
0.7 (450.347)	Petrol	37	01/03 → 01/04						
0.7 (450.347)	Petrol	37	01/03 → 01/04						
0.8 CDI (450.300, 450.301, 450.302, 450.303, 450.306...)	Diesel	30	11/99 → 01/04						
0.8 CDI (450.300, 450.301, 450.302, 450.303, 450.306...)	Diesel	30	11/99 → 01/04						



TYPE

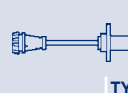

TYPE



TYPE

				SPA111	F1				
				ATS16	F2		SAG155	H1	
				SPA111	F1				
				ATS16	F2				
				SPA111	F1				

		APS23	RP01A	ATS21	F2		SAC048	H2	
				SPA163	F1				
		APS23	RP01A	ATS21	F2				
				SPA163	F1				
		APS23	RP01A	ATS21	F2		SAC048	H2	BAE680AK
				SPA163	F1				
		APS23	RP01A	ATS21	F2				
				SPA163	F1				
		APS23	RP01A	ATS21	F2				
				SPA163	F1				
				ATS21	F2		SAC048	H2	
				SPA163	F1				

		APS23	RP01A	ATS21	F2				
				SPA163	F1				
		APS23		ATS21	F2		SAC048	H2	
			RP01A						
				SPA163	F1				
		APS23	RP01A	ATS21	F2		SAC048	H2	BAE680AK
				SPA163	F1				
		APS23	RP01A	ATS21	F2		SAC048	H2	
				SPA163	F1				
		APS23	RP01A	ATS21	F2				BAE680AK
				SPA163	F1				
		APS23	RP01A	ATS21	F2				BAE680AK
				SPA163	F1				
			RP01A	ATS21	F2				BAE680AK
				SPA163	F1				
				ATS21	F2		SAC048	H2	
				SPA163	F1				



KW



TYPE



TYPE

SMART

FORFOUR (454)

1.1 (454.030)	Petrol	55	01/04 → 06/06						
1.3 (454.031)	Petrol	70	01/04 → 06/06						
1.5 (454.032)	Petrol	80	01/04 → 06/06						
1.5 CDI (454.000)	Diesel	50	09/04 → 06/06						
1.5 CDI (454.000)	Diesel	50	09/04 → 06/06						
1.5 CDI (454.001)	Diesel	70	09/04 → 06/06						
1.5 CDI (454.001)	Diesel	70	09/04 → 06/06						

FORTWO Cabrio (450)

0.7 (450.414, 450.441, 450.442, 450.443, 450.452)	Petrol	45	01/04 → 01/07						
0.7 (450.414, 450.441, 450.442, 450.443, 450.452)	Petrol	45	01/04 → 01/07						
0.7 (450.452)	Petrol	55	01/04 → 01/07						
0.7 (450.452)	Petrol	55	01/04 → 01/07						
0.8 CDI (450.401, 450.402, 450.403)	Diesel	30	01/04 → 01/07						
0.8 CDI (450.401, 450.402, 450.403)	Diesel	30	01/04 → 01/07						

FORTWO Cabrio (451)

1.0 (451.431, 451.480)	Petrol	52	01/07 →						
1.0 Brabus (451.433)	Petrol	72	01/08 →						
1.0 Turbo (451.432)	Petrol	62	01/07 →						

FORTWO Coupé (450)

0.7 (450.314)	Petrol	55	01/04 → 01/07						
0.7 (450.314)	Petrol	55	02/04 → 01/07						
0.7 (450.314)	Petrol	55	01/04 → 01/07						
0.7 (450.331)	Petrol	37	01/04 → 01/07						
0.7 (450.331)	Petrol	37	02/04 → 01/07						
0.7 (450.331)	Petrol	37	01/04 → 01/07						
0.7 (450.335, 450.336, 450.341, 450.342, 450.343...)	Petrol	45	01/04 → 01/07						
0.7 (450.335, 450.336, 450.341, 450.342, 450.343...)	Petrol	45	02/04 → 01/07						
0.7 (450.335, 450.336, 450.341, 450.342, 450.343...)	Petrol	45	01/04 → 01/07						
0.8 CDI (450.300, 450.301, 450.302, 450.303, 450.306)	Diesel	30	01/04 → 01/07						
0.8 CDI (450.300, 450.301, 450.302, 450.303, 450.306)	Diesel	30	01/04 → 01/07						

FORTWO Coupé (451)

1.0 (451.330, 451.334)	Petrol	45	01/07 →						
1.0 (451.331, 451.380)	Petrol	52	01/07 →						
1.0 Brabus (451.333)	Petrol	72	01/08 →						
1.0 Turbo (451.332)	Petrol	62	01/07 →						



KW



TYPE



TYPE

SMART

ROADSTER (452)

0.7 (452.432)	Petrol	45	04/03 → 11/05						
0.7 (452.432)	Petrol	45	08/03 → 11/05						
0.7 (452.432)	Petrol	45	04/03 → 11/05						
0.7 (452.434)	Petrol	60	04/03 → 11/05						
0.7 (452.434)	Petrol	60	04/03 → 11/05						
0.7 Brabus (452.437)	Petrol	74	12/03 → 11/05						
0.7 Brabus (452.437)	Petrol	74	12/03 → 11/05						

ROADSTER Coupé (452)

0.7 (452.334)	Petrol	60	04/03 → 11/05						
0.7 (452.334)	Petrol	60	04/03 → 11/05						
0.7 Brabus (452.337)	Petrol	74	12/03 → 11/05						
0.7 Brabus (452.337)	Petrol	74	12/03 → 11/05						

SSANGYONG

KORANDO (KJ)

2.0	Petrol	94	05/97 → 12/05						
2.0	Petrol	94	05/97 →						
2.3	Petrol	103	05/97 → 12/05						
2.3	Petrol	105	01/99 → 12/05						
2.3	Petrol	105	01/99 →						
2.3	Petrol	103	05/97 →						
3.2	Petrol	156	01/99 →						
3.2	Petrol	156	01/99 →						

KORANDO Cabrio (KJ)

2.3	Petrol	103	11/97 → 12/05						
2.3	Petrol	105	02/99 → 12/05						
2.3	Petrol	105	02/99 →						
2.3	Petrol	103	11/97 →						
3.2	Petrol	156	01/99 →						
3.2	Petrol	156	01/99 →						

MUSSO (FJ)

2.3	Petrol	110	04/03 → 12/05						
2.3	Petrol	110	04/03 →						

SUBARU

FORESTER (SF)

2.0	Petrol	90	08/97 → 09/02						
2.0	Petrol	92	06/98 → 09/02						
2.0 S Turbo	Petrol	125	06/98 → 04/01						

IMPREZA Station wagon (GD, GG)

1.6 AWD	Petrol	70	12/00 →						
---------	--------	----	---------	--	--	--	--	--	--



TYPE



TYPE



TYPE

	APS23		ATS21	F2					
		RP01A							
			SPA163	F1					
	APS23	RP01A	ATS21	F2					
			SPA163	F1					
		RP01A	ATS21	F2					
			SPA163	F1					
	APS23	RP01A	ATS21	F2				BAE680AK	
			SPA163	F1					
		RP01A	ATS21	F2					
			SPA163	F1					
		RP01A							
						SAG146	H1		
		RP01A							
		RP01A							
			ATS21	F2		SAG146	H1		
						SAG146	H1		
			ATS21	F2		SAC043	H2		
						SAD033	H3		
		RP01A							
		RP01A							
			ATS21	F2		SAG146	H1		
						SAG146	H1		
			ATS21	F2		SAC043	H2		
						SAD033	H3		
		RP01A							
						SAG146	H1		
						SAA111	SAD010	H3	
						SAA111	SAD010	H3	
						SAA111	SAD010	H3	
						SAA111			

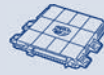
KW

TYPE

TYPE
SUBARU
IMPREZA Station wagon (GF)

2.0 i 16V AWD	Petrol	92	06/98 → 12/00						
2.0 i Turbo AWD	Petrol	155	03/94 → 12/00						
2.0 Turbo GT AWD	Petrol	160	06/98 → 12/00						

IMPREZA Tre volumi (GC)

1.8 i AWD	Petrol	76	08/92 → 12/00						
2.0 i AWD	Petrol	85	10/95 → 12/00						
2.0 Turbo GT AWD	Petrol	155	03/94 → 12/00						
2.0 Turbo GT AWD	Petrol	160	06/98 → 12/00						

IMPREZA Tre volumi (GD, GG)

1.6 AWD	Petrol	70	12/00 →						
---------	--------	----	---------	--	--	--	--	--	--

JUSTY II (JMA, MS)

1.3 GX 4x4	Petrol	50	10/95 → 09/96						
------------	--------	----	---------------	--	--	--	--	--	--

JUSTY III (G3X)

1.3	Petrol	69	09/03 →						
1.5	Petrol	73	09/03 →						

LEGACY I (BC)

1800	Petrol	76	01/89 → 12/93						
1800 4WD	Petrol	76	01/89 → 09/91						
2000 4WD	Petrol	85	08/91 → 07/94						
2000 Turbo 4WD	Petrol	147	05/92 → 07/94						
2200 4WD	Petrol	100	01/89 → 07/94						

LEGACY I Station wagon (BC, BJF)

1800	Petrol	76	01/89 → 07/94						
2000	Petrol	85	09/91 → 12/93						
1800 4WD	Petrol	76	01/89 → 07/94						
2000 4WD	Petrol	85	09/91 → 07/94						
2000 Turbo Super 4WD	Petrol	147	05/92 → 07/94						
2200 Super 4WD	Petrol	100	01/89 → 07/94						

LEGACY II (BD, BG)

2.0 i	Petrol	85	09/94 → 03/99						
2.0 i 4WD	Petrol	85	09/94 → 03/99						
2.2 i 4WD	Petrol	94	09/94 → 03/99						
2.2 i 4WD	Petrol	96	06/96 → 03/99						
2.5 i 4WD	Petrol	110	06/96 → 03/99						

LEGACY II Station wagon (BD, BG)

2.0 i	Petrol	85	09/94 → 11/98						
2.0 i 4WD	Petrol	85	09/94 → 11/98						
2.2 i 4WD	Petrol	94	02/94 → 12/98						
2.2 i 4WD	Petrol	96	06/96 → 11/98						
2.5 i 4WD	Petrol	110	06/96 → 11/98						



KW

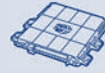

TYPE



TYPE

SUBARU

LEGACY III (BE, BH)

2.0	Petrol	92	04/99 → 08/03						
2.5	Petrol	115	10/98 → 08/03						

LEGACY III Station wagon (BE, BH)

2.0 AWD	Petrol	92	12/98 → 08/03						
2.5 AWD	Petrol	115	12/98 → 08/03						

OUTBACK (BL, BP)

3.0 Trazione integrale AWD	Petrol	180	11/03 → 08/05						
----------------------------	--------	-----	---------------	--	--	--	--	--	--

SUZUKI

ALTO III (EF)

1.0	Petrol	39	09/94 → 06/02						
-----	--------	----	---------------	--	--	--	--	--	--

ALTO IV (FF)

1.1	Petrol	46	06/02 → 12/08						
-----	--------	----	---------------	--	--	--	--	--	--

BALENO (EG)

1.3 i 16V	Petrol	63	07/95 → 05/02						
1.6 i 16V	Petrol	72	07/95 → 05/02						
1.6 i 16V 4x4	Petrol	72	07/95 → 05/02						

BALENO 2 volumi /Coda spiovente (EG)

1.3 i 16V	Petrol	63	07/95 → 05/02						
1.6 i 16V	Petrol	72	07/95 → 05/02						
1.6 i 16V 4x4	Petrol	72	07/95 → 05/02						

BALENO Station wagon (EG)

1.3 16V	Petrol	63	03/97 → 05/02						
---------	--------	----	---------------	--	--	--	--	--	--

CAPPUCINO (EA)

0.7 (EA11)	Petrol	47	02/92 → 08/95						
------------	--------	----	---------------	--	--	--	--	--	--

CARRY Furgonato (FD)

1.3	Petrol	58	03/99 →						
1.3 16 V	Petrol	58	03/00 →						

GRAND VITARA I (FT, GT)

1.6	Petrol	69	03/01 → 09/02						
2.0 HDi 110 16V	Diesel	80	07/01 → 09/05						
2.0 TD	Diesel	64	03/98 → 07/03						

GRAND VITARA II (JT)

1.9 DDiS	Diesel	95	10/05 →						
----------	--------	----	---------	--	--	--	--	--	--

IGNIS (FH)

1.3	Petrol	61	10/00 → 09/03						
1.3 4WD	Petrol	61	10/00 → 09/03						

IGNIS II

1.3	Petrol	69	09/03 →						
1.3 4x4	Petrol	69	09/03 →						
1.3 DDiS	Diesel	51	09/03 →						
1.3 DDiS	Diesel	51	09/03 →						
1.5	Petrol	73	09/03 →						
1.5 4x4	Petrol	73	09/03 →						



KW

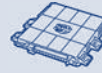

TYPE



TYPE

SUZUKI

IGNIS II

1.5 Sport	Petrol	80	12/03 →						
-----------	--------	----	---------	--	--	--	--	--	--

JIMNY (FJ)

1.3 16V	Petrol	60	02/01 →						
---------	--------	----	---------	--	--	--	--	--	--

1.3 16V 4WD	Petrol	60	02/01 →						
-------------	--------	----	---------	--	--	--	--	--	--

1.3 16V 4x4	Petrol	63	08/05 →						
-------------	--------	----	---------	--	--	--	--	--	--

1.5 DDiS 4WD	Diesel	48	12/03 →						
--------------	--------	----	---------	--	--	--	--	--	--

1.5 DDiS 4x4	Diesel	63	08/05 →						
--------------	--------	----	---------	--	--	--	--	--	--

1.5 DDiS 4x4	Diesel	63	08/05 →						
--------------	--------	----	---------	--	--	--	--	--	--

LIANA (ER)

1.3	Petrol	66	03/02 →						
-----	--------	----	---------	--	--	--	--	--	--

1.4 DDiS	Diesel	66	04/04 →						
----------	--------	----	---------	--	--	--	--	--	--

1.6	Petrol	76	03/02 →						
-----	--------	----	---------	--	--	--	--	--	--

1.6 4WD	Petrol	76	03/02 →						
---------	--------	----	---------	--	--	--	--	--	--

1.6 4WD	Petrol	78	04/02 →						
---------	--------	----	---------	--	--	--	--	--	--

1.6 i	Petrol	78	04/02 →						
-------	--------	----	---------	--	--	--	--	--	--

LIANA Station wagon (ER)

1.3	Petrol	66	07/01 → 12/07						
-----	--------	----	---------------	--	--	--	--	--	--

1.4 DDiS	Diesel	66	04/04 → 12/07						
----------	--------	----	---------------	--	--	--	--	--	--

1.6	Petrol	76	07/01 → 12/07						
-----	--------	----	---------------	--	--	--	--	--	--

1.6 4WD	Petrol	76	07/01 → 12/07						
---------	--------	----	---------------	--	--	--	--	--	--

1.6 4WD	Petrol	78	04/02 → 12/07						
---------	--------	----	---------------	--	--	--	--	--	--

1.6 i	Petrol	78	04/02 → 12/07						
-------	--------	----	---------------	--	--	--	--	--	--

SAMURAI (SJ)

1.3 (SJ 413)	Petrol	47	01/90 → 12/04						
--------------	--------	----	---------------	--	--	--	--	--	--

1.3 Trazione integrale (SJ 413)	Petrol	51	01/90 → 12/04						
---------------------------------	--------	----	---------------	--	--	--	--	--	--

1.9 D	Diesel	46	09/00 → 12/04						
-------	--------	----	---------------	--	--	--	--	--	--

1.9 TD	Diesel	47	11/98 → 12/04						
--------	--------	----	---------------	--	--	--	--	--	--

SPLASH

1.3 CDTI	Diesel	55	01/08 →						
----------	--------	----	---------	--	--	--	--	--	--

SWIFT Cabriolet (SF413)

1.3 i (SF413, AK35)	Petrol	50	01/92 → 09/95						
---------------------	--------	----	---------------	--	--	--	--	--	--

SWIFT II 2 volumi /Coda spiovente (EA, MA)

1.0 i (SF310, AA44)	Petrol	39	01/95 → 12/05						
---------------------	--------	----	---------------	--	--	--	--	--	--

1.0 i (SF310, AA44)	Petrol	40	03/89 → 12/91						
---------------------	--------	----	---------------	--	--	--	--	--	--

1.3	Petrol	63	06/01 → 12/03						
-----	--------	----	---------------	--	--	--	--	--	--

1.3 (SF413, AB35)	Petrol	50	06/96 → 05/01						
-------------------	--------	----	---------------	--	--	--	--	--	--

1.3 (SF413, AB35)	Petrol	50	01/92 → 05/01	CHASSIS: → x00250000					
-------------------	--------	----	---------------	----------------------	--	--	--	--	--

1.3 4WD (SF413, AA35)	Petrol	50	01/92 → 05/01	CHASSIS: → x00250000					
-----------------------	--------	----	---------------	----------------------	--	--	--	--	--

1.3 GTi (SF413, AA34)	Petrol	74	03/89 → 05/01						
-----------------------	--------	----	---------------	--	--	--	--	--	--

SWIFT II Tre volumi (AH, AJ)

1.3 (SF413, AH35, MA)	Petrol	50	06/96 → 05/01						
-----------------------	--------	----	---------------	--	--	--	--	--	--

1.3 (SF413, AH35, MA)	Petrol	50	01/92 → 05/01	CHASSIS: → x00250000					
-----------------------	--------	----	---------------	----------------------	--	--	--	--	--

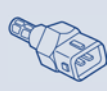
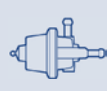

TYPE

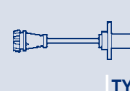

TYPE



TYPE

BAE680BY

BAE680BY

SPA145

F1

SPA145

F1

SPA145

F1

SPA169

F1

SAC010

H1

SPA169

F1

SAC010

H1

SAD035

H3

APS38

SPA145

F1

SPA172

F1

SAA118

SPA145

F1

SPA145

F1

SPA145

F1

SPA145

F1

SPA145

F1

APS38

SPA145

F1

SPA172

F1

SAA118

SPA145

F1

SPA145

F1

SPA145

F1

SPA145

F1

SPA168

F1

SPA168

F1

SAG161

H1

SAG161

H1

SPS001

SPA168

F1

SPA168

F1

SPA168

F1

RP07A

RP07A

SPA168

F1

SPA168

F1

SPA122

F1

RP07A

SPA168

F1

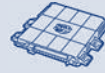
KW

TYPE

TYPE
SUZUKI
SWIFT III (MZ, EZ)

1.3	Petrol	68	02/05 →						
1.3 4x4	Petrol	66	01/06 →						
1.3 DDiS	Diesel	51	08/05 →						
1.3 DDiS	Diesel	55	08/05 →						
1.3 DDiS	Diesel	51	08/05 →						
1.3 DDiS	Diesel	55	08/05 →						
1.5	Petrol	75	02/05 →						
1.6	Petrol	92	05/06 →						

SX4 (GY)

1.5	Petrol	73	06/06 →						
1.9 DDiS	Diesel	88	06/06 →						
1.9 DDiS 4x4	Diesel	88	06/06 →						

VITARA (ET, TA)

1.6 i 16V Trazione integrale (ET, TA02)	Petrol	71	07/90 → 03/98						
1.6 Trazione integrale (ET)	Petrol	60	07/88 → 12/91						
1.6 Trazione integrale (TA, TA01)	Petrol	59	07/88 → 03/98						

VITARA Cabrio (ET, TA)

1.6 i 16V	Petrol	71	07/90 → 03/99						
-----------	--------	----	---------------	--	--	--	--	--	--

WAGON R+ (MM)

1.3	Petrol	69	09/03 →						
1.3 4WD	Petrol	69	09/03 →						
1.3 DDiS	Diesel	51	09/03 →						
1.3 DDiS	Diesel	51	09/03 →						

X-90 (EL)

1.6 i 16V 4x4	Petrol	71	09/95 → 12/97						
---------------	--------	----	---------------	--	--	--	--	--	--

TOYOTA
4 RUNNER (RN10_, VZN13_, VZN10_, RN13_)

2.7 i	Petrol	112	11/95 → 03/96						
3.0 V6 (VZN 130)	Petrol	105	07/90 → 11/95						
3.4 i	Petrol	136	11/95 → 03/96						

AURIS (NRE15_, ZZE15_, ADE15_, ZRE15_, NDE15_)

1.33 Dual-VVTi	Petrol	74	05/09 →						
1.4 D-4D	Diesel	66	03/07 →						
1.4 VVTi	Petrol	71	03/07 →						
1.6	Petrol	97	05/09 →						
1.6 VVTi	Petrol	91	03/07 →						
1.8	Petrol	108	02/09 →						
2.0 D-4D	Diesel	93	03/07 →						
2.2 D	Diesel	130	03/07 →						

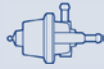

TYPE



TYPE



TYPE

				SPA145	F1				BAE680BY		
				SPA145	F1						
			SPS001	SPA145	F1		SAC093	H2			
			SPS001	SPA145	F1		SAC093	H2			
							SAG025	H1			
							SAG025	H1			
									BAE680BY	GA2145	J2
				SPA145	F1						
									BAE680BY		
							SAC088	H2			
							SAC088	H2			
				SPA168	F1						
				SPA168	F1						
				SPA168	F1						
				SPA168	F1						
				SPA145	F1		SAG053	H1	BAE680BY		
							SAG053	H1			
				SPA145	F1		SAC093	H2			
							SAG025	H1			
				SPA117	F1						
									ESS0026A		J1
				SPA168	F1						
									BAE680DR	ESS0026A	J1
									BAE680CT		
							SAC078	H2			
										GA2141	J2
									BAE680CT	GA2141	J2
									BAE680CT		
									BAE680CT		
							SAC078	H2			
							SAC078	H2			



KW



TYPE



TYPE

TOYOTA

AVENSIS (_T22_)

1.6 (AT220_)	Petrol	74	09/97 → 10/00						
1.6 (AT220_)	Petrol	81	09/97 → 10/00						
1.6 VVT-i	Petrol	81	10/00 → 02/03						
1.8 (AT221_)	Petrol	81	09/97 → 10/00						
1.8 VVT-i	Petrol	95	10/00 → 02/03						
2.0 (ST220_)	Petrol	94	09/97 → 10/00						
2.0 D-4D (CDT220_)	Diesel	81	10/99 → 02/03						
2.0 TD (CT220_)	Diesel	66	09/97 → 02/03						
2.0 VVT-i	Petrol	110	10/00 → 02/03						

AVENSIS (T25_)

1.6 VVT-i	Petrol	81	04/03 → 11/08						
1.8	Petrol	95	04/03 → 11/08						
2.0	Petrol	108	04/03 → 11/08						
2.0 D-4D	Diesel	85	04/03 → 11/08						
2.0 D-4D	Diesel	93	03/06 → 11/08						
2.2 D-4D	Diesel	110	10/05 → 11/08						
2.2 D-CAT	Diesel	130	07/05 → 11/08						
2.4	Petrol	120	10/03 → 11/08						
2.4	Petrol	125	09/03 → 11/08						

AVENSIS Liftback (_T22_)

1.6 (AT220_)	Petrol	74	09/97 → 10/00						
1.6 (AT220_)	Petrol	81	09/97 → 10/00						
1.6 VVT-i	Petrol	81	10/00 → 02/03						
1.8 (AT221_)	Petrol	81	09/97 → 10/00						
1.8 VVT-i	Petrol	95	10/00 → 02/03						
2.0 (ST220_)	Petrol	94	09/97 → 10/00						
2.0 D-4D (CDT220_)	Diesel	81	10/99 → 02/03						
2.0 TD (CT220_)	Diesel	66	09/97 → 02/03						
2.0 VVT-i	Petrol	110	10/00 → 02/03						

AVENSIS Station Wagon (_T22_)

1.6 (AT220_)	Petrol	74	09/97 → 10/00						
1.6 (AT220_)	Petrol	81	09/97 → 10/00						
1.6 VVT-i	Petrol	81	10/00 → 02/03						
1.8 (AT221_)	Petrol	81	09/97 → 10/00						
1.8 VVT-i	Petrol	95	10/00 → 02/03						
2.0 (ST220_)	Petrol	94	09/97 → 10/00						
2.0 D-4D (CDT220_)	Diesel	81	10/99 → 02/03						
2.0 TD (CT220_)	Diesel	66	09/97 → 02/03						
2.0 VVT-i	Petrol	110	10/00 → 02/03						

AVENSIS Station wagon (T25)

1.6 VVT-i	Petrol	81	04/03 → 11/08						
1.8	Petrol	95	04/03 → 11/08						
2.0	Petrol	108	04/03 → 11/08						
2.0 D-4D	Diesel	85	04/03 → 11/08						

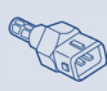
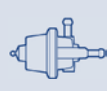

TYPE

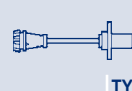

TYPE



TYPE

				SPA168	F1		SAC086	H2			
				SPA168	F1		SAC086	H2			
				SPA168	F1				BAE680CB		
				SPA168	F1		SAC086	H2			
				SPA168	F1		SAC060	H2	BAE680CB		
				SPA168	F1		SAC053	H2			
				SPA168	F1		SAC066	H2			
				SPA168	F1						
				SPA168	F1						

									BAE680CB		
							SAC060	H2	BAE680CB		
							SAG123	H1			
							SAC066	H2			
							SAC078	H2			
							SAC078	H2			
							SAC078	H2			
							SAG123	H1			
							SAG123	H1			

				SPA168	F1		SAC086	H2			
				SPA168	F1		SAC086	H2			
				SPA168	F1				BAE680CB		
				SPA168	F1		SAC086	H2			
				SPA168	F1		SAC060	H2	BAE680CB		
				SPA168	F1		SAC053	H2			
				SPA168	F1		SAC066	H2			
				SPA168	F1						
				SPA168	F1						

				SPA168	F1		SAC086	H2			
				SPA168	F1		SAC086	H2			
				SPA168	F1				BAE680CB		
				SPA168	F1		SAC086	H2			
				SPA168	F1		SAC060	H2	BAE680CB		
				SPA168	F1		SAC053	H2			
				SPA168	F1		SAC066	H2			
				SPA168	F1						
				SPA168	F1						

									BAE680CB		
							SAC060	H2	BAE680CB		
							SAG123	H1			
							SAC066	H2			



KW



TYPE



TYPE

TOYOTA

AVENSIS Station wagon (T25)

2.0 D-4D	Diesel	93	03/06 → 11/08						
2.2 D-4D	Diesel	110	10/05 → 11/08						
2.2 D-CAT	Diesel	130	07/05 → 11/08						
2.4	Petrol	120	10/03 → 11/08						
2.4	Petrol	125	09/03 → 11/08						

AVENSIS Station wagon (ZRT27, ADT27)

1.6	Petrol	97	02/09 →						
1.8	Petrol	108	02/09 →						
2.0	Petrol	112	02/09 →						
2.0 D-4D	Diesel	93	02/09 →						
2.2 D-4D	Diesel	110	02/09 →						
2.2 D-4D	Diesel	130	02/09 →						

AVENSIS Tre volumi (T25)

1.6 VVT-i	Petrol	81	04/03 → 11/08						
1.8	Petrol	95	04/03 → 11/08						
2.0 D-4D	Diesel	85	04/03 → 11/08						
2.0 D-4D	Diesel	93	03/06 → 11/08						
2.2 D-4D	Diesel	110	10/05 → 11/08						
2.2 D-CAT	Diesel	130	07/05 → 11/08						

AVENSIS Tre volumi (ZRT27, ADT27)

1.6	Petrol	97	02/09 →						
1.8	Petrol	108	02/09 →						
2.0	Petrol	112	02/09 →						
2.0 D-4D	Diesel	93	02/09 →						
2.2 D-4D	Diesel	110	02/09 →						
2.2 D-4D	Diesel	130	02/09 →						

AVENSIS VERSO (_CLM2_, _ACM2_)

2.0 D-4D	Diesel	85	08/01 → 08/05						
2.0 VVT-i	Petrol	110	08/01 → 11/09						

AYGO (WNB1_, KGB1_)

1.0 (KGB10)	Petrol	50	07/05 →						
1.0 (KGB10)	Petrol	50	07/05 →						
1.0 (KGB10)	Petrol	50	07/05 →						
1.4 HDi (WNB10)	Diesel	40	07/05 → 08/10						
1.4 HDi (WNB10)	Diesel	40	07/05 → 08/10						

CAMRY (_CV1_, _XV1_, _V1_)

2.2 (SXV10)	Petrol	100	06/91 → 08/96						
3.0 (VCV10)	Petrol	138	06/91 → 08/96						

CAMRY (_CV2_, _XV2_)

2.2	Petrol	93	11/00 → 11/01						
3.0 V6	Petrol	135	08/96 → 11/01						



TYPE

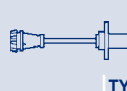

TYPE



TYPE

						SAC078	H2			
						SAC078	H2			
						SAC078	H2			
						SAG123	H1			
						SAG123	H1			
								BAE680CT		
								BAE680CT		
								BAE680CT		
						SAC078	H2			
						SAC078	H2			
						SAC078	H2			
								BAE680CB		
						SAC060	H2	BAE680CB		
						SAC066	H2			
						SAC078	H2			
						SAC078	H2			
						SAC078	H2			
								BAE680CT		
								BAE680CT		
								BAE680CT		
						SAC078	H2			
						SAC078	H2			
						SAC078	H2			
								BAE680CC		
						SAC066	H2			
	APS75		SPA162	F1		SAC091	H2	BAE680CB	GA2225	J2
						SAD025	H3			
						SAG152	H1			
			ATS22	F2	SAA118					
			SPA172	F1						
						SAA111			ESS0026A	J1
						SAA111			ESS0026A	J1
									ESS0026A	J1
			SPA127	F1						

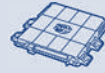
KW

TYPE

TYPE
TOYOTA
CAMRY (_V2_)

2.0 (SV21_, SV25_)	Petrol	94	11/86 → 05/91					
2.0 Gli 16V (SV21_, SV25_)	Petrol	89	11/86 → 05/91					
2.0 Turbo-D (CV20_)	Diesel	62	08/88 → 05/91					
2.0 Turbo-D (CV20_)	Diesel	63	11/88 → 05/91					
2.5 V6 GXI (VZV21_)	Petrol	118	02/88 → 05/91					

CAMRY (MCV3_, ACV3_, _XV3_)

2.4 VVT-i	Petrol	112	11/01 → 11/06					
3.0 V6	Petrol	137	11/01 → 11/06					

CAMRY Station Wagon (_V2_)

2.0 (SV21_)	Petrol	94	11/86 → 05/91					
2.0 GLi 16V (SV21_)	Petrol	89	11/86 → 05/91					
2.0 Turbo-D (CV20_)	Diesel	62	08/88 → 05/91					
2.0 Turbo-D (CV20_)	Diesel	63	11/88 → 05/91					

CAMRY Station Wagon (_XV1_, _CV1_, _V10)

2.2 (SXV10)	Petrol	100	03/92 → 07/96					
3.0 (VCV10)	Petrol	138	03/92 → 07/96					

CARINA E (_T19_)

1.6 (AT190)	Petrol	73	02/94 → 01/96					
1.6 16V	Petrol	78	10/95 → 09/97					
1.6 GLI (AT190)	Petrol	79	12/93 → 09/97					
1.6 GLI (AT190)	Petrol	79	04/92 → 09/97					
2.0 GLI (ST191)	Petrol	98	04/92 → 09/97					
2.0 GTi 16V (ST191_)	Petrol	129	03/94 → 09/97					

CARINA E Sportswagon (_T19_)

1.6 GLI (AT190_)	Petrol	79	01/93 → 09/97					
1.6 i (AT190_)	Petrol	73	02/95 → 01/96					

CARINA E Tre volumi (_T19_)

1.6 (AT190)	Petrol	73	01/95 → 01/96					
1.6 (AT190)	Petrol	79	01/93 → 09/97					
1.6 16V (AT190_)	Petrol	85	12/94 → 09/97					
2.0 GTi 16V (ST191_)	Petrol	129	03/94 → 09/97					
2.0 TD (CT190_)	Diesel	61	01/96 → 09/97					

CARINA II (_T17_)

1.6 (AT171)	Petrol	66	08/88 → 11/89					
1.6 (AT171)	Petrol	75	12/87 → 03/92					
1.6 (AT171)	Petrol	66	12/87 → 11/89					
1.6 (AT171)	Petrol	72	12/87 → 03/92					
2.0 GLI (ST171)	Petrol	89	12/87 → 03/92					

CARINA II Station Wagon (_T17_)

1.6 (AT171)	Petrol	66	08/88 → 12/89					
1.6 (AT171)	Petrol	75	12/87 → 03/92					
1.6 (AT171)	Petrol	66	12/87 → 12/89					

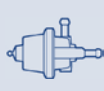

TYPE

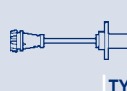

TYPE



TYPE

				SAA111			BAE680DS		
				SAA111			BAE680DS		
			SPA168	F1					
			SPA168	F1					
			SPA168	F1	SAA111				
						SAG123	H1	BAE680CC	
			SPA127	F1		SAC066	H2		ESS0026A J1
								BAE680DS	
					SAA111			BAE680DS	
			SPA168	F1					
			SPA168	F1					
					SAA111				ESS0026A J1
					SAA111				
									ESS0026A J1
			SPA168	F1					
			SPA168	F1					
			SPA168	F1					
			SPA168	F1					
			SPA168	F1					
			SPA168	F1	SAA110				
					SAA110				
					SAA110				
			SPA168	F1	SAA111			BAE680DS	
			SPA168	F1					
			SPA168	F1	SAA110				
					SAA110				



KW

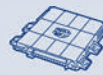

TYPE



TYPE

TOYOTA

CARINA II Tre volumi (_T17_)

1.6 (AT171)	Petrol	66	08/88 → 08/90						
1.6 (AT171)	Petrol	75	12/87 → 03/92						
2.0 GLI (ST171)	Petrol	89	12/87 → 03/92						

CELICA (AT16_, ST16_)

1.6 GT 16V	Petrol	91	08/88 → 08/89						
------------	--------	----	---------------	--	--	--	--	--	--

CELICA (ST20_, AT20_)

1.8 i 16V (AT200/ST)	Petrol	85	11/93 → 11/99						
2.0 i 16V	Petrol	125	04/96 → 11/99						
2.0 i 16V (ST202/GT)	Petrol	129	11/93 → 11/99						
2.0 i Turbo 4WD (ST205)	Petrol	178	02/94 → 11/99						

CELICA (ZZT23_)

1.8 16V TS (ZZT231_)	Petrol	141	08/99 → 09/05						
1.8 16V VT-i (ZZT230_)	Petrol	105	08/99 → 07/05						

CELICA 2 volumi /Coda spiovente (ST16_, AT16_)

1.6 GT	Petrol	85	08/88 → 08/89						
2.0 GT	Petrol	103	08/88 → 08/89						
2.0 GT	Petrol	110	08/88 → 08/89						
2.0 GT	Petrol	103	09/85 → 08/89						
2.0 GT	Petrol	110	08/85 → 08/89						

CELICA Cabriolet (AT18_, ST18_)

2.0 GTi (ST182)	Petrol	115	10/89 → 11/93						
-----------------	--------	-----	---------------	--	--	--	--	--	--

CELICA Cabriolet (AT20_, ST20_)

2.0 i 16V	Petrol	125	11/93 → 08/99						
-----------	--------	-----	---------------	--	--	--	--	--	--

CELICA Cabriolet (ST16_, AT16_)

2.0 GT (ST162)	Petrol	103	08/88 → 08/89						
2.0 GT (ST162)	Petrol	110	08/88 → 08/89						
2.0 GT (ST162)	Petrol	103	08/85 → 08/89						
2.0 GT (ST162)	Petrol	110	10/86 → 08/89						

CELICA Coupé (AT18_, ST18_)

1.6 STI (AT180)	Petrol	77	10/89 → 11/93						
2.0 GTi (ST182)	Petrol	115	10/89 → 11/93						
2.0 Turbo 4WD (ST185)	Petrol	150	10/89 → 11/93						
2.0 Turbo 4WD (ST185)	Petrol	153	10/89 → 11/93						

CELICA Coupé (ST16_, AT16_)

2.0 Turbo 4WD	Petrol	136	08/88 → 08/89						
---------------	--------	-----	---------------	--	--	--	--	--	--

COROLLA (_E10_)

1.3 XLI (EE101_)	Petrol	55	09/95 → 04/97						
1.3 XLI 16V (EE101)	Petrol	65	07/92 → 09/95						
1.6 Si (AE101_)	Petrol	84	09/95 → 04/97						
2.0 D (CE100_)	Diesel	53	07/92 → 04/97						



TYPE

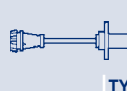

TYPE



TYPE

				SPA168	F1					
				SPA168	F1					
				SPA168	F1			BAE680DS		
				SPA168	F1					
				SPA168	F1				ESS0026A	J1
									ESS0026A	J1
				SPA168	F1				ESS0026A	J1
				SPA168	F1					
							SAC060	H2	BAE680CG	
							SAC060	H2	BAE680CG	
				SPA168	F1					
				SPA168	F1					
				SPA168	F1					
							SAA111			
							SAA111			
				SPA168	F1	SAA111				
				SPA168	F1					
				SPA168	F1					
				SPA168	F1				SAA111	
									SAA111	
				SPA168	F1	SAA110				
				SPA168	F1	SAA111				
				SPA168	F1	SAA111				
				SPA168	F1	SAA111				
				SPA168	F1					
				SPA168	F1					
				SPA168	F1				ESS0026A	J1
				SPA168	F1	SAA110			ESS0026A	J1
				SPA168	F1					



KW

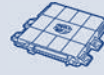

TYPE



TYPE

TOYOTA

COROLLA (_E11_)

1.4 16V (ZZE111_)	Petrol	71	02/00 → 09/01					SVF015	B6
1.6 (AE111_)	Petrol	81	04/97 → 02/00						
1.6 16V (ZZE112_)	Petrol	81	02/00 → 11/01						
1.6 Aut. (AE111_)	Petrol	79	04/97 → 02/00						
1.9 D (WZE110_)	Diesel	51	02/00 → 09/01						
1.9 D (WZE110_)	Diesel	51	02/00 → 11/01						
2.0 D (CE110_)	Diesel	53	04/97 → 02/00						
2.0 D-4D	Diesel	66	09/00 → 11/01						

COROLLA (_E8_)

1.6 (AE82)	Petrol	53	08/85 → 08/87						
------------	--------	----	---------------	--	--	--	--	--	--

COROLLA (_E9_)

1.3 i (EE90)	Petrol	55	08/87 → 12/92						
1.6 (AE92)	Petrol	66	08/87 → 12/89						
1.6 i 4WD	Petrol	77	10/87 → 08/90						

COROLLA (ZZE12_, NDE12_, ZDE12_)

1.4 D	Diesel	66	07/04 → 02/07						
1.4 VVT-i	Petrol	71	01/02 → 12/06						
1.6 VVT-i	Petrol	81	01/02 → 12/06						
1.8 VVTL-i TS	Petrol	141	01/02 → 02/07						
1.8 VVTL-i TS	Petrol	165	02/05 → 02/07						
2.0 D-4D	Diesel	66	01/02 → 12/06						
2.0 D-4D	Diesel	81	01/02 → 12/06						
2.0 D-4D	Diesel	85	05/03 → 02/07						

COROLLA Compact (_E10_)

1.3 XLI (EE101_)	Petrol	55	09/95 → 04/97						
1.3 XLI 16V (EE101)	Petrol	65	07/92 → 09/95						
1.6 Si (AE101_)	Petrol	84	07/92 → 04/97						
1.8 GT (AE102_)	Petrol	86	11/92 → 05/95						
2.0 D (CE100_)	Diesel	53	07/92 → 04/97						

COROLLA Compact (_E11_)

1.4 (ZZE111_)	Petrol	71	02/00 → 07/01					SVF015	B6
1.6 (AE111_)	Petrol	81	04/97 → 02/00						
1.6 (ZZE112_)	Petrol	81	02/00 → 01/02						
1.6 Aut. (AE111_)	Petrol	79	04/97 → 02/00						
1.9 D (WZE110_)	Diesel	51	02/00 → 09/01						
1.9 D (WZE110_)	Diesel	51	02/00 → 01/02						
2.0 D (CE110_)	Diesel	53	04/97 → 02/00						
2.0 D-4D	Diesel	66	09/00 → 01/02						

COROLLA Compact (_E9_)

1.3 (EE90)	Petrol	55	08/87 → 12/89						
1.6 (AE92)	Petrol	66	08/87 → 04/92						
1.6 GTi (AE92, AE93)	Petrol	85	08/87 → 04/92						
1.6 i (AE92)	Petrol	77	08/89 → 04/92						
1.8 D (CE90)	Diesel	47	08/87 → 04/92						

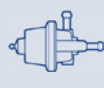

TYPE

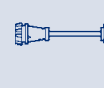

TYPE



TYPE

PART NUMBER		TYPE	REMARKS	REMARKS	REMARKS	REMARKS	REMARKS	REMARKS
								BAE680AO
SPA168	F1							BAE680CB
SPA168	F1							
SPA107	F1							
			SAA118					
SPA168	F1							
					SAC066	H2		
			SAA111					BAE680DS
SPA168	F1	SAA111						
			SAA110					
SPA168	F1							
					SAC078	H2		
							BAE680CB	GA2218 J2
							BAE680CB	GA2218 J2
							BAE680CG	
							BAE680CG	
					SAC066	H2		
					SAC066	H2		
					SAC066	H2		
SPA168	F1							
SPA168	F1							
SPA168	F1	SAA110						
SPA168	F1						ESS0026A	J1
SPA168	F1							
								BAE680AO
SPA168	F1							
								BAE680CB
SPA168	F1							
SPA107	F1							
			SAA118					
SPA168	F1							
					SAC066	H2		
			SAA111					
			SAA110					
SPA168	F1	SAA110						
SPA168	F1	SAA110						
			SAA110					

KW

TYPE

TYPE
TOYOTA
COROLLA Compact (_E9_)

1.8 D (CE90) Diesel 49 08/89 → 04/92

COROLLA Liftback (_E10_)

1.3 XLI (EE101_) Petrol 65 07/92 → 04/97

1.6 GLI (AE101_) Petrol 84 07/92 → 04/97

1.8 GT (AE102_) Petrol 86 11/92 → 05/95

2.0 D (CE100_) Diesel 53 07/92 → 04/97

COROLLA Liftback (_E11_)

1.4 (ZZE111_) Petrol 71 02/00 → 09/01

SVF015
B6

1.4 (ZZE111_) Petrol 71 02/00 → 11/01

1.6 (AE111_) Petrol 81 04/97 → 02/00

1.6 (ZZE112_) Petrol 81 02/00 → 01/02

1.6 Aut. (AE111_) Petrol 79 04/97 → 02/00

1.9 D (WZE110_) Diesel 51 02/00 → 09/01

1.9 D (WZE110_) Diesel 51 02/00 → 01/02

2.0 D (CE110) Diesel 53 04/97 → 02/00

2.0 D-4D Diesel 66 09/00 → 01/02

COROLLA Liftback (_E8_)

1.6 (AE82) Petrol 54 08/85 → 08/87

COROLLA Liftback (_E9_)

1.3 i (EE90) Petrol 55 08/87 → 04/92

1.6 (AE92) Petrol 77 08/89 → 04/92

1.6 (AE92) Petrol 66 08/87 → 04/92

1.8 D (CE90) Diesel 47 08/87 → 04/92

1.8 D (CE90) Diesel 49 08/89 → 04/92

COROLLA Station wagon (_E12J_, _E12T_)

1.4 D4-D Diesel 66 07/04 → 02/07

1.4 VVT-i Petrol 71 01/02 → 02/07

1.6 VVT-i Petrol 81 01/02 → 02/07

2.0 D-4D Diesel 66 01/02 → 02/07

2.0 D-4D Diesel 85 04/04 → 02/07

COROLLA Station Wagon (_E7_)

1.8 D (CE70) Diesel 44 05/83 → 08/87

COROLLA Station Wagon (_E9_)

1.3 (EE90) Petrol 55 12/87 → 06/92

1.6 (AE92) Petrol 66 02/88 → 05/92

1.6 XLI 4WD (AE95) Petrol 77 08/88 → 06/92

1.8 D (CE90) Diesel 47 12/87 → 06/92

1.8 D (CE90) Diesel 49 08/89 → 06/92

COROLLA Tre volumi (_E12J_, _E12T_)

1.4 D-4D Diesel 66 07/04 → 07/07

1.4 VVT-i Petrol 71 08/02 → 07/07

1.6 VVT-i Petrol 81 08/02 → 07/07

2.0 D-4D Diesel 66 08/02 → 07/07

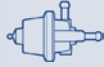

TYPE



TYPE



TYPE

SAA110						
		SPA168	F1			
		SPA168	F1	SAA110		
		SPA168	F1			
		SPA168	F1			
BAE680AO						
		SPA168	F1			
BAE680CB						
		SPA168	F1			
		SPA107	F1			
SAA118						
		SPA168	F1			
				SAC066	H2	
SAA111						
BAE680DS						
		SPA168	F1	SAA111		
		SPA168	F1	SAA110		
				SAA110		
				SAA110		
				SAA110		
				SAC078	H2	
						BAE680CB GA2218 J2
						BAE680CB GA2218 J2
				SAC066	H2	
				SAC066	H2	
SAA110						
SAA111						
				SAA110		
		SPA168	F1			
				SAA110		
				SAA110		
SAC078						
				SAC078	H2	
						BAE680CB GA2218 J2
						BAE680CB GA2218 J2
				SAC066	H2	



KW

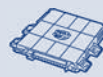

TYPE



TYPE

TOYOTA

COROLLA Verso (ZDE12_, CDE12_)

1.6 VVT-i	Petrol	81	01/02 → 05/04					
1.8 VVT-i	Petrol	99	01/02 → 05/04					
2.0 D-4D	Diesel	66	01/02 → 05/04					

COROLLA Verso (ZER_, ZZE12_, R1_)

1.6	Petrol	81	04/04 → 03/09					
1.8	Petrol	95	04/04 → 03/09					
2.0 D-4D	Diesel	85	04/04 → 03/09					
2.2 D-4D	Diesel	100	10/05 → 03/09					
2.2 D-4D	Diesel	130	10/05 → 03/09					

COROLLA Wagon (_E11_)

1.4 16V (ZZE111_)	Petrol	71	02/00 → 09/01				SVF015	B6
1.6 (AE111_)	Petrol	81	04/97 → 02/00					
1.6 16V (ZZE112_)	Petrol	81	02/00 → 10/01					
1.6 Aut. (AE111_)	Petrol	79	04/97 → 02/00					
1.8 4WD (AE115_)	Petrol	81	04/97 → 10/01					
1.9 D (WZE110_)	Diesel	51	02/00 → 09/01					
1.9 D (WZE110_)	Diesel	51	02/00 → 10/01					
2.0 D (CE110_)	Diesel	53	04/97 → 02/00					
2.0 D-4D	Diesel	66	09/00 → 10/01					

COROLLA Wagon (_E10_)

1.3 XLI (EE101_)	Petrol	55	09/95 → 04/97					
1.3 XLI 16V (EE101_)	Petrol	65	07/92 → 09/95					
1.6 Si (AE101_)	Petrol	84	07/92 → 04/97					
1.8 16V 4WD (AE103_)	Petrol	81	09/95 → 04/97					
2.0 D (CE100_)	Diesel	53	07/92 → 04/97					

DYNA Pianale piatto/Telaio (KD_, LY_, TRY2_, KDY2_, XZU4_, X

2.5 D4d	Diesel	65	08/01 →					
2.5 D4d	Diesel	75	08/01 →					

HIACE II Wagon (LH7_, LH5_, LH6_, YH7_, YH6_, YH5_)

2.4 D (H5G)	Diesel	55	08/84 → 08/89					
-------------	--------	----	---------------	--	--	--	--	--

HIACE III Furgonato (YH7_, LH6_, LH7_, LH5_, YH5_, YH6_)

2.4	Petrol	88	08/89 → 08/95					
2.4 4WD	Petrol	88	08/89 → 08/95					
2.4 D 4WD	Diesel	55	08/89 → 08/95					

HIACE III Wagon (LH1_, RZH1_)

2.0 (RZH102)	Petrol	74	08/89 → 04/98					
2.4 (RZH103)	Petrol	88	08/89 → 08/95					
2.4 4WD	Petrol	88	08/89 → 08/95					
2.4 D	Diesel	57	08/89 → 08/95					
2.4 D (LH102)	Diesel	55	08/89 → 08/95					
2.4 D 4WD	Diesel	55	08/89 → 08/95					
2.5 D-4D 4WD	Diesel	75	08/01 → 08/04					



KW



TYPE



TYPE

TOYOTA

HIACE IV Autobus (LH1_)

2.4 (RCH12_, RCH22_)	Petrol	85	08/95 → 04/98
2.4 4WD (RCH18_)	Petrol	85	08/95 → 04/98
2.4 D	Diesel	58	08/95 → 08/06
2.4 TD (LXH12_, LXH22_)	Diesel	66	08/95 → 08/06
2.4 TD 4WD (H18/28)	Diesel	66	08/95 → 08/06
2.5 D-4D	Diesel	65	11/01 → 08/06
2.5 D-4D	Diesel	75	11/01 → 08/06
2.7 (RCH13_, RCH23_)	Petrol	105	04/98 → 11/01
2.7 4WD (RCH19_)	Petrol	105	04/98 → 08/06

HIACE IV Furgonato (LXH1_, RZH1_, LH1_)

2.4 (RCH12_, RCH22_)	Petrol	85	08/95 → 02/05
2.4 4WD (RCH18_, RCH28_)	Petrol	85	08/95 → 04/98
2.4 D (LXH12_, LXH22_)	Diesel	58	08/95 → 08/06
2.4 TD (LXH12_, LXH22_)	Diesel	66	08/95 → 08/06
2.4 TD 4WD (LXH18_, LXH28_)	Diesel	66	08/95 → 08/06
2.5 D-4D	Diesel	65	11/01 → 08/06
2.5 D-4D	Diesel	75	11/01 → 08/06
2.5 D-4D 4WD	Diesel	75	11/01 → 08/06
2.7 (RCH13_, RCH23_)	Petrol	105	04/98 → 08/06
2.7 4WD (RCH19_, RCH29_)	Petrol	106	04/98 →

HILUX II Pick-up (RN6_, RN5_, LN6_, YN6_, YN5_, LN5_)

2.4 D	Diesel	58	03/95 → 07/05
2.4 D	Diesel	61	08/88 → 07/05
2.4 D	Diesel	59	01/92 → 07/05
2.4 D (LN150, LN145)	Diesel	55	07/98 → 01/02
2.4 D 4WD	Diesel	58	01/94 → 07/05
2.4 D 4WD	Diesel	61	08/88 → 07/05
2.4 i 4WD	Petrol	84	06/89 → 07/05
2.4 i 4WD	Petrol	84	06/89 → 07/05
2.4 TD 4WD	Diesel	66	08/98 → 01/02

HILUX III Pick-up (TGN1_, GGN2_, GGN1_, KUN2_, KUN1_)

2.5 D 4WD	Diesel	75	08/05 →
2.5 D 4WD	Diesel	75	08/05 →
2.5 D-4D	Diesel	75	06/06 →
3.0 (KUN16)	Diesel	120	08/05 → 09/06
3.0 D-4D 4WD	Diesel	126	12/07 →

IQ (KPJ1_, NGJ1_, KGJ1_, NUJ1_)

1.0	Petrol	50	01/09 →
1.4 D-4D	Diesel	66	01/09 →

LAND CRUISER (_J6_)

4.0 (FJ62_G)	Petrol	115	08/87 → 12/89
--------------	--------	-----	---------------

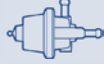

TYPE



TYPE



TYPE

SPA168

F1

SPA168

F1

SPA168

F1

SAA110

SPA168

F1

SAA110

SPA168

F1

SAA110

SAG092

H1

SAG092

H1

SPA168

F1

SPA168

F1

SPA168

F1

SPA168

F1

SPA168

F1

SAA110

SPA168

F1

SAA110

SPA168

F1

SAA110

SAG092

H1

SAG092

H1

SAG092

H1

SPA168

F1

SPA168

F1

SPA168

F1

SPA168

F1

SAA110

SAA110

SAA110

SPA168

F1

SAA110

SPA168

F1

SAA110

SPA168

F1

SPA168

F1

SPA168

F1

SAA110

SAC055

H2

SAG046

H1

SAG046

H1

SAG046

H1

SAC055

H2

SAG152

H1

SAC078

H2

SPA168

F1



KW



TYPE



TYPE

TOYOTA

LAND CRUISER (KDJ12_, GRJ12_)

3.0 D-4D (KDJ120, KDJ125)	Diesel	122	08/04 → 02/10						
3.0 D-4D (KDJ120, KDJ150, KDJ125)	Diesel	120	01/03 → 02/10						
3.0 D-4D (KDJ120, KDJ150, KDJ125)	Diesel	120	01/03 → 02/10						
4.0 (GRJ12, GRJ125)	Petrol	183	01/03 →						

LAND CRUISER (PZJ7_, KZJ7_, HZJ7_, BJ7_, LJ7_, RJ7_)

2.4 (RJ70_V, RJ73_V)	Petrol	84	12/88 → 12/96						
2.4 D (LJ70_)	Diesel	53	11/84 → 10/85						
2.4 TD (LJ70)	Diesel	66	01/90 → 05/93						
2.4 TD (LJ70_, LJ73_)	Diesel	63	10/85 → 05/90						
3.0 TD (KZJ70_, KZJ73_, KZJ77_)	Diesel	92	05/93 → 05/96						
3.4 TD (BJ71_V)	Diesel	91	10/85 → 08/86						
4.2 TD (HZJ7_V)	Diesel	96	01/90 →						

LAND CRUISER (VDJ20_, UZJ20_)

4.5 D V8 (VDJ200)	Diesel	210	01/08 →						
-------------------	--------	-----	---------	--	--	--	--	--	--

LAND CRUISER 150 (KDJ15_, GRJ15_)

3.0 D-4D	Diesel	127	03/10 →						
----------	--------	-----	---------	--	--	--	--	--	--

LAND CRUISER 80 (_J8_)

4.2 D (HZJ80_)	Diesel	99	01/90 → 12/97						
4.2 TD (HDJ80)	Diesel	118	10/92 → 12/97						
4.2 TD (HDJ80)	Diesel	123	01/90 → 12/97						
4.5 24V (FZJ80_)	Petrol	151	08/92 → 12/97						

LAND CRUISER 90 (_J9_)

3.0 D-4D (KDJ90, KDJ95, KDJ 125)	Diesel	120	10/00 →						
3.0 D-4D (KDJ90, KDJ95, KDJ 125)	Diesel	120	10/00 →						

LAND CRUISER Hardtop (_J7_)

2.4 TD (LJ77)	Diesel	66	07/90 → 05/96						
3.0 TD	Diesel	92	05/93 → 05/96						

LITEACE Autobus (_R2_LG)

1.5 (KR21LG)	Petrol	52	01/92 → 01/95						
2.0 D (CR21LG)	Diesel	53	01/92 → 05/94						
2.2 (YR22LG)	Petrol	72	01/92 → 01/95						

LITEACE Autobus (CM30_G, KM30_G)

1.5 (KM30LG)	Petrol	51	10/85 → 08/89						
2.0 D (CM30LG)	Diesel	53	08/88 → 01/92						

LITEACE Furgonato (_R2_V)

1.5 (KR27_V)	Petrol	52	01/92 → 01/95						
2.0 D (CR27_V)	Diesel	51	01/92 → 05/94						
2.2 (YR29LV)	Petrol	72	01/92 → 01/95						



TYPE

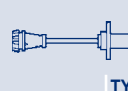

TYPE



TYPE

							SAG092	H1		
							SAC055	H2		
							SAG092	H1		
							SAC055	H2		
				SPA168	F1					
							SAA110			
				SPA168	F1					
							SAA110			
				SPA168	F1					
							SAA110			
				SPA168	F1	SAA110				
							SAC078	H2		
							SAG092	H1		
				SPA168	F1	SAA110				
				SPA168	F1					
				SPA168	F1					
							SAC055	H2		
							SAC055	H2		
							SAG092	H1		
				SPA168	F1					
				SPA168	F1					
							SAA111			
				SPA168	F1	SAA110				
				SPA168	F1				BAE680DS	
							SAA111			
				SPA168	F1	SAA110				
							SAA111			
				SPA168	F1	SAA110				
				SPA168	F1				BAE680DS	
				SPA168	F1					

KW

TYPE

TYPE
TOYOTA
LITEACE Furgonato (CM3_V, KM3_V)

1.8 D (CM35_V)	Diesel	46	10/85 → 08/88					
2.0 D (CM36_V)	Diesel	53	08/88 → 01/92					

MODELL F Autobus (_R2_, 31)

2.2 (YR22LG, YR31LG)	Petrol	72	08/87 → 01/90					
----------------------	--------	----	---------------	--	--	--	--	--

MR 2 II (SW2_)

2.0 16V	Petrol	125	12/89 → 05/00					
2.0 16V	Petrol	129	12/89 → 05/00					
2.0 16V (SW20)	Petrol	115	12/89 → 05/00					

MR 2 III (ZZW3_)

1.8 16V VT-i (ZZW30)	Petrol	103	10/99 → 06/07					
----------------------	--------	-----	---------------	--	--	--	--	--

PASEO Cabriolet (EL54)

1.5	Petrol	66	10/96 → 05/97					
-----	--------	----	---------------	--	--	--	--	--

PASEO Coupé (EL54)

1.5 16V	Petrol	66	08/95 → 05/97					
1.5 16V	Petrol	66	08/95 → 07/99					

PICNIC (_XM10)

2.0	Petrol	90	01/01 → 12/01					
2.2 D (CMX10_)	Diesel	66	08/97 → 12/01					

PREVIA (MCR3_, ACR3_, CLR3_)

2.0 D-4D	Diesel	85	03/01 → 01/06					
2.4	Petrol	115	08/00 → 01/06					

PREVIA (TCR2_, TCR1_)

2.4	Petrol	97	05/90 → 08/00					
-----	--------	----	---------------	--	--	--	--	--

PRIUS 2 volumi /Coda spiovente (NHW20_)

1.5	Petrol	57	08/03 → 03/09					
1.5	Petrol	57	08/03 → 03/09					

PRIUS Tre volumi (NHW11_)

1.5	Petrol	53	05/00 → 01/04					
1.5	Petrol	53	05/00 → 01/04					

RAV 4 I (SXA1_)

2.0 4WD	Petrol	95	06/94 → 06/00					
---------	--------	----	---------------	--	--	--	--	--

RAV 4 I Cabrio (SXA1_)

2.0 16V 4WD	Petrol	94	12/97 → 06/00					
-------------	--------	----	---------------	--	--	--	--	--

RAV 4 II (CLA2_, XA2_, ZCA2_, ACA2_)

1.8 VVTi	Petrol	92	08/00 → 11/05					
2.0 D-4D 4WD	Diesel	85	09/01 → 11/05					
2.0 D-4D 4WD	Diesel	85	09/01 → 11/05					
2.0 VVTi 4WD	Petrol	110	06/00 → 11/05					

RAV 4 III (ACA3_, ACE_, ALA3_, GSA3_, ZSA3_)

2.0	Petrol	116	12/08 →					
2.0 4WD	Petrol	116	12/08 →					
2.0 VVT-i 4WD	Petrol	112	03/06 →					
2.2 D-4D 4WD	Diesel	100	03/06 →					
2.2 D-CAT 4WD	Diesel	130	03/06 →					



KW



TYPE



TYPE

TOYOTA

STARLET (_P8_)

1.0 (EP80_)	Petrol	40	12/89 → 12/92						
1.3 12V (EP81) Cat.	Petrol	55	12/89 → 03/96						
1.3 12V (EP81_)	Petrol	55	12/89 → 12/92						
1.5 D (NP80_)	Diesel	40	12/89 → 03/96						

STARLET (EP91)

1.3	Petrol	55	04/96 → 12/97						
1.3	Petrol	55	04/96 → 03/99						

SUPRA (JZA70_, GA70_, MA70)

3.0 TURBO	Petrol	173	08/88 → 04/93						
3.0 TURBO	Petrol	175	08/88 → 05/93						

SUPRA (JZA80)

3.0 i Bi-Turbo	Petrol	243	05/93 → 08/02						
----------------	--------	-----	---------------	--	--	--	--	--	--

TERCEL (AL2_)

1.5 4WD (AL25)	Petrol	50	05/86 → 01/88						
----------------	--------	----	---------------	--	--	--	--	--	--

URBAN CRUISER (NSP1_, NLP1_, ZSP1_, NCP11_)

1.4 D-4D	Diesel	66	04/09 →						
1.4 D-4D 4WD	Diesel	66	04/09 →						

VERSO (_AUR2_, _ZGR2_)

1.6	Petrol	97	04/09 →						
1.8	Petrol	108	04/09 →						

YARIS (SCP1_, NLP1_, NCP1_)

1.0 16V	Petrol	48	03/03 → 09/05						
1.0 16V	Petrol	50	04/99 → 09/05						
1.3	Petrol	64	04/02 → 09/05						
1.3 16V	Petrol	63	11/99 → 09/05						
1.3 16V	Petrol	63	11/99 → 09/05						
1.4 D-4D	Diesel	55	12/01 → 09/05						
1.5 TS	Petrol	77	01/03 → 09/05						
1.5 TS	Petrol	77	01/03 → 09/05						
1.5 VVT-i TS	Petrol	78	04/01 → 09/05						
1.5 VVT-i TS	Petrol	78	04/01 → 09/05						

YARIS (SCP9_, NSP9_, KSP9_, NCP9_, ZSP9_)

1.0 VVT-i	Petrol	51	08/05 →						
1.0 VVT-i	Petrol	51	08/05 →						
1.0 VVT-i	Petrol	51	08/05 →						
1.3 VVT-i	Petrol	64	08/05 →						
1.4 D-4D	Diesel	66	08/05 →						
1.8 VVTi	Petrol	98	01/07 →						

YARIS VERSO (_NLP2_, _NCP2_)

1.3 (NCP22)	Petrol	62	08/99 → 09/05						
1.3 (NCP22)	Petrol	62	08/99 → 09/05						
1.3 (NCP22)	Petrol	63	08/99 → 09/05						
1.3 (NCP22)	Petrol	63	08/99 → 09/05						
1.4 D-4D (NLP22)	Diesel	55	12/01 → 09/05						

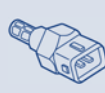

TYPE

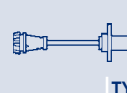

TYPE



TYPE

						SAA111				
			SPA168	F1		SAA111				
						SAA111				
			SPA168	F1						
			SPA168	F1						
									ESS0026A	J1
			SPA168	F1						
			SPA168	F1						
			SPA168	F1		SAC055	H2			
						SAA111			BAE680DS	
						SAC078	H2			
						SAC078	H2			
									BAE680CT	
									BAE680CT	
						SAC065	H2	BAE680BH		
						SAC086	H2		ESS0032A	J1
						SAC065	H2			
						SAC086	H2	BAE680BH	ESS0032A	J1
						SAG136	H1			
						SAC094	H2			
						SAC086	H2			
						SAG136	H1			
						SAC086	H2	BAE680BH	ESS0032A	J1
						SAG136	H1			
	APS75		SPA162	F1		SAC091	H2	BAE680CB	ESS0027A	J1
						SAD025	H3			
						SAG152	H1			
			SPA162	F1		SAC065	H2		ESS0027A	J1
			SPA162	F1		SAC078	H2			
								BAE680CT	ESS0027A	J1
						SAC086	H2			
						SAG136	H1			
						SAC086	H2	BAE680BH	ESS0032A	J1
						SAG136	H1			
						SAC094	H2			



KW



TYPE



TYPE

TOYOTA

YARIS VERSO (_NLP2_, _NCP2_)

1.5 (NCP21)	Petrol	77	05/03 → 09/05					
1.5 (NCP21)	Petrol	77	05/03 → 09/05					
1.5 (NCP21)	Petrol	78	03/00 → 09/05					
1.5 (NCP21)	Petrol	78	03/00 → 09/05					

VAUXHALL

AGILA Mk I (A)

1.0 12V	Petrol	43	09/00 → 08/03					
1.0 12V	Petrol	43	09/00 → 08/05					
1.0 12V	Petrol	44	02/00 → 11/06					
1.0 12V	Petrol	44	02/00 → 11/06					
1.0 12V	Petrol	44	02/00 → 11/06					
1.0 12V	Petrol	44	08/03 → 11/06					
1.2 16V	Petrol	55	09/00 → 06/04					
1.2 16V	Petrol	55	09/00 → 03/08					
1.2 16V Twinport	Petrol	59	07/04 → 11/06					
1.2 16V Twinport	Petrol	59	07/04 → 11/06					
1.2 16V Twinport	Petrol	59	07/04 → 11/06					

AGILA Mk II (B)

1.3 CDTI	Diesel	55	01/08 →					
1.3 CDTI	Diesel	55	01/08 →					

AMPERA

EV 150 (D1JOI)		111	03/12 →					
----------------	--	-----	---------	--	--	--	--	--

ARENA Combi

1.9 D	Diesel	44	03/98 → 08/01					
-------	--------	----	---------------	--	--	--	--	--

ARENA Van

1.9 D	Diesel	44	03/98 → 08/01					
-------	--------	----	---------------	--	--	--	--	--

ASTRA GTC Mk VI (J)

1.4	Petrol	103	10/11 →					
1.4	Petrol	74	10/11 →					
1.4	Petrol	88	10/11 →					
1.6	Petrol	132	10/11 →					

ASTRA Mk II 2 volumi /Coda spiovente

1.2	Petrol	44	09/84 → 08/91	CHASSIS: J2791968 →				
1.3	Petrol	55	09/84 → 08/91	CHASSIS: J2791968 →				
1.4 i	Petrol	44	01/90 → 08/91	CHASSIS: J2791968 →				
1.4 S	Petrol	55	01/90 → 08/91	CHASSIS: J2791968 →				
1.6	Petrol	60	09/84 → 08/91	CHASSIS: J2791968 →				
1.6 S	Petrol	66	09/84 → 08/86	CHASSIS: J2791968 →				
1.8 GTE	Petrol	82	09/86 → 08/91			SVF012		B6
1.8 GTE	Petrol	82	09/84 → 08/91	CHASSIS: J2791968 →				
1.8 GTE	Petrol	82	09/84 → 08/91					
2.0 GTE	Petrol	95	09/86 → 08/91			SVF012		B6



KW



TYPE



TYPE

VAUXHALL

ASTRA Mk II Belmont

1.3	Petrol	55	09/85 → 08/91	CHASSIS: J2791968 →				
1.4 i	Petrol	44	01/90 → 12/91					
1.4 i	Petrol	44	01/90 → 12/91	CHASSIS: J2791968 →				
1.6	Petrol	66	09/85 → 08/91	CHASSIS: J2791968 →				
1.6 S	Petrol	60	01/89 → 12/91					
1.6 S	Petrol	60	01/89 → 12/91	CHASSIS: J2791968 →				
1.8	Petrol	82	01/86 → 12/90				SVF012	B6
1.8	Petrol	82	01/86 → 12/90	CHASSIS: J2791968 →				
1.8 i	Petrol	85	09/86 → 08/91				SVF012	B6
1.8 i	Petrol	85	09/85 → 08/91	CHASSIS: J2791968 →				

ASTRA Mk II Cabriolet

1.6 i	Petrol	55	01/91 → 08/93	CHASSIS: J2791968 →				
1.6 i	Petrol	60	01/87 → 12/91	CHASSIS: J2791968 →				
1.6 i Cat.	Petrol	55	10/87 → 02/93	CHASSIS: J2791968 →				

ASTRA Mk II Station wagon

1.2	Petrol	44	09/84 → 12/88	CHASSIS: J2791968 →				
1.3	Petrol	55	09/84 → 08/91	CHASSIS: J2791968 →				
1.4 S	Petrol	55	01/89 → 08/91	CHASSIS: J2791968 →				
1.6	Petrol	60	09/84 → 08/91	CHASSIS: J2791968 →				
1.6 S	Petrol	66	09/84 → 08/86	CHASSIS: J2791968 →				
1.8 i	Petrol	83	01/90 → 08/91	CHASSIS: J2791968 →				

ASTRA Mk III (F)

1.4 i	Petrol	44	04/92 → 09/98				SVF014	B6
1.4 i	Petrol	60	04/92 → 09/98				B3215	B1
1.4 i	Petrol	60	04/92 → 09/98				SVF013	B6
1.4 i	Petrol	44	04/92 → 09/98					
1.4 i	Petrol	44	04/92 → 09/98	ENGINE: C14NZ				
1.4 i	Petrol	60	04/92 → 09/98	ENGINE: 14SE-C14SE-X14NZ				
1.4 i	Petrol	44	04/92 → 02/98					
1.4 i	Petrol	60	04/92 → 02/98					
1.4 i 16V	Petrol	66	02/96 → 09/98				B3215	B1
1.4 i 16V	Petrol	66	02/96 → 09/98				SVF013	B6
1.4 i 16V	Petrol	66	02/96 → 09/98	ENGINE: 02DF5762 →				
1.4 i 16V	Petrol	66	02/96 → 09/98	ENGINE: X14XE				
1.6 i	Petrol	52	08/94 → 07/96				SVF014	B6
1.6 i	Petrol	55	03/92 → 09/98				SVF014	B6
1.6 i	Petrol	74	05/92 → 12/94				B3215	B1
1.6 i	Petrol	74	05/92 → 12/94				SVF013	B6
1.6 i	Petrol	55	03/92 → 09/98					
1.6 i	Petrol	52	08/94 → 07/96	ENGINE: X16SZ				
1.6 i	Petrol	55	03/92 → 09/98	ENGINE: 16NZR-C16NZ				
1.6 i	Petrol	74	05/92 → 12/94	ENGINE: C16SE				
1.6 i 16V	Petrol	74	08/94 → 09/98				B3215	B1
1.6 i 16V	Petrol	74	08/94 → 09/98				SVF013	B6

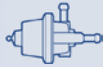

TYPE



TYPE



TYPE

			SSA042	F2					
			SPA104	F1					
			SSA042	F2					
			SSA042	F2					
			SPA104	F1					
			SSA042	F2					
			SPA104	F1					
			SSA042	F2					
			SSA042	F2					
			SSA042	F2					
			SSA042	F2					
			SSA042	F2					
			SSA042	F2					
			SSA042	F2					
			SSA042	F2					
			SSA042	F2					
			SSA042	F2					
			SPA104	F1					
			SPA104	F1		SAG141	H1		
			SSA042	F2					
			SSA042	F2					
								BAE608I	
								BAE608I	
									ESS525 J1
									ESS530 J1
			SSA042	F2		SAC082	H2		
						SAG124	H1		
								BAE608I	
			SSA042	F2		SAG141	H1		
			SPA104	F1		SAG141	H1		
			SPA104	F1		SAG141	H1		ESS530 J1
			SSA042	F2					
			SSA042	F2					
								BAE608I	
								BAE608I	
								BAE608I	
			SSA042	F2		SAC082	H2		



KW



TYPE



TYPE

VAUXHALL

ASTRA Mk III (F)

1.6 i 16V	Petrol	74	08/94 → 09/98	ENGINE: 02DF5762 →				
1.6 i 16V	Petrol	74	08/94 → 09/98	ENGINE: X16XEL				
1.8 i	Petrol	66	03/92 → 09/98				SVF014	B6
1.8 i	Petrol	66	03/92 → 09/98					
1.8 i 16V	Petrol	85	01/94 → 12/96				B3397	B1
1.8 i 16V	Petrol	92	06/93 → 10/94				B3397	B1
2.0 i	Petrol	85	03/92 → 02/98				SVF015	B6
2.0 i	Petrol	85	03/92 → 09/98					
2.0 i	Petrol	85	03/92 → 09/98	CHASSIS: S2000001 →				
2.0 i	Petrol	85	03/92 → 02/98					
2.0 i 16V	Petrol	100	02/95 → 09/98				B3397	B1
2.0 i 16V	Petrol	100	02/95 → 09/98	ENGINE: 14142429 →				

ASTRA Mk III (F) 2 volumi /Coda spiovente

1.4 i	Petrol	44	09/91 → 02/98				SVF014	B6
1.4 i	Petrol	60	03/92 → 02/98				B3215	B1
1.4 i	Petrol	60	03/92 → 02/98				SVF013	B6
1.4 i	Petrol	44	09/91 → 02/98					
1.4 i	Petrol	44	09/91 → 02/98	ENGINE: C14NZ				
1.4 i 16V	Petrol	66	02/96 → 02/98				B3215	B1
1.4 i 16V	Petrol	66	02/96 → 02/98				SVF013	B6
1.4 i 16V	Petrol	66	02/96 → 02/98	ENGINE: 02DF5762 →				
1.4 i 16V	Petrol	66	02/96 → 02/98	ENGINE: X14XE				
1.4 S	Petrol	55	09/91 → 02/98					
1.4 S	Petrol	55	09/91 → 02/98	ENGINE: 14NV				
1.6 i	Petrol	52	07/94 → 02/98				SVF014	B6
1.6 i	Petrol	55	09/91 → 02/98				SVF014	B6
1.6 i	Petrol	74	03/92 → 02/98				B3215	B1
1.6 i	Petrol	74	03/92 → 02/98				SVF013	B6
1.6 i	Petrol	55	09/91 → 02/98					
1.6 i	Petrol	52	07/94 → 02/98	ENGINE: X16SZ				
1.6 i	Petrol	55	09/91 → 02/98	ENGINE: C16SE				
1.6 i	Petrol	74	03/92 → 02/98	ENGINE: C16SE				
1.8 i	Petrol	66	09/91 → 02/98				SVF014	B6
1.8 i	Petrol	66	09/91 → 02/98					
1.8 i 16V	Petrol	85	09/94 → 02/98				B3397	B1
1.8 i 16V	Petrol	92	09/94 → 02/98				B3397	B1
2.0 i	Petrol	85	09/91 → 02/98				SVF015	B6
2.0 i	Petrol	85	09/91 → 02/98					
2.0 i	Petrol	85	09/91 → 02/98	CHASSIS: S2000001 →				
2.0 i 16V	Petrol	100	01/94 → 02/98				B3397	B1
2.0 i 16V	Petrol	110	09/91 → 02/98					
2.0 i 16V	Petrol	110	09/91 → 02/98					
2.0 i 16V	Petrol	100	01/94 → 02/98	ENGINE: 14142429 →				

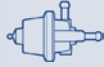

TYPE



TYPE



TYPE

							SAG124	H1			
										BAE608I	
						SPA104	F1				
						SSA042	F2				
						SSA042	F2		SAC046	H2	
						SSA042	F2		SAC046	H2	
						SPA104	F1				
						SSA042	F2				
									SAG093	H1	
											ESS530
						SSA042	F2		SAC046	H2	
									SAG107	H1	
						SPA104	F1				ESS525
						SPA104	F1		SAG141	H1	ESS530
						SSA042	F2				
						SSA042	F2				
											BAE608I
						SSA042	F2		SAC082	H2	
									SAG124	H1	
											BAE608I
						SSA042	F2				
											BAE608I
						SSA042	F2		SAG141	H1	
						SPA104	F1				ESS525
						SPA104	F1		SAG141	H1	ESS530
						SSA042	F2				
						SSA042	F2				
											BAE608I
											BAE608I
											BAE608I
						SPA104	F1				
						SSA042	F2				
						SSA042	F2		SAC046	H2	
						SSA042	F2		SAC046	H2	
						SPA104	F1				ESS530
						SSA042	F2				J1
									SAG093	H1	
						SSA042	F2		SAC046	H2	
						SPA104	F1				
						SSA042	F2				
									SAG107	H1	



KW



TYPE



TYPE

VAUXHALL

ASTRA Mk III (F) 2 volumi /Coda spiovente

2.0 i 16V Petrol 110 09/91 → 02/98 ENGINE: C20XE

ASTRA Mk III (F) Cabriolet

1.4 i	Petrol	60	05/93 → 03/01					B3215	B1
1.4 i	Petrol	60	05/93 → 03/01					SVF013	B6
1.4 i	Petrol	60	05/93 → 02/98						
1.4 i 16V	Petrol	66	01/96 → 03/01					B3215	B1
1.4 i 16V	Petrol	66	01/96 → 03/01					SVF013	B6
1.4 i 16V	Petrol	66	01/96 → 03/01	ENGINE: 02DF5762 →					
1.6 i	Petrol	52	03/93 → 08/96					SVF014	B6
1.6 i	Petrol	55	01/96 → 03/01					SVF014	B6
1.8	Petrol	92	09/94 → 08/96					B3397	B1
1.8 16V	Petrol	85	11/94 → 03/01					B3397	B1
1.8 16V	Petrol	85	11/94 → 03/01						
1.8 16V	Petrol	85	11/94 → 03/01	ENGINE: 14142429 →					
2.0 i	Petrol	85	03/93 → 10/94					SVF015	B6
2.0 i	Petrol	85	03/93 → 10/94						
2.0 i	Petrol	85	03/93 → 10/94	CHASSIS: S2000001 →					

ASTRA Mk III (F) Station wagon

1.4 i	Petrol	44	09/91 → 02/98					SVF014	B6
1.4 i	Petrol	60	03/91 → 02/98					B3215	B1
1.4 i	Petrol	60	03/91 → 02/98					SVF013	B6
1.4 i	Petrol	44	09/91 → 02/98						
1.4 i	Petrol	44	09/91 → 02/98	ENGINE: C14NZ					
1.4 i	Petrol	60	03/91 → 02/98	ENGINE: 14SE-C14SE-X14NZ					
1.4 i	Petrol	60	02/92 → 02/98						
1.4 i 16V	Petrol	66	02/96 → 01/98					B3215	B1
1.4 i 16V	Petrol	66	02/96 → 01/98					SVF013	B6
1.4 i 16V	Petrol	66	02/96 → 01/98	ENGINE: 02DF5762 →					
1.4 i 16V	Petrol	66	02/96 → 01/98	ENGINE: X14XE					
1.4 S	Petrol	55	09/91 → 02/98						
1.4 S	Petrol	55	09/91 → 02/98	ENGINE: 14NV					
1.6 i	Petrol	52	07/94 → 02/98					SVF014	B6
1.6 i	Petrol	55	09/91 → 02/98					SVF014	B6
1.6 i	Petrol	55	09/91 → 02/98						
1.6 i	Petrol	52	07/94 → 02/98	ENGINE: X16SZ					
1.6 i	Petrol	55	09/91 → 02/98	ENGINE: C16SE					
1.6 i 16V	Petrol	74	01/94 → 02/98					B3215	B1
1.6 i 16V	Petrol	74	01/94 → 02/98					SVF013	B6
1.6 i 16V	Petrol	74	01/94 → 02/98	ENGINE: 02DF5762 →					
1.6 i 16V	Petrol	74	01/94 → 02/98	ENGINE: X16XEL					
1.6 Si	Petrol	74	03/91 → 12/94					B3215	B1
1.6 Si	Petrol	74	03/91 → 12/94					SVF013	B6
1.6 Si	Petrol	74	03/91 → 12/94	ENGINE: C16SE					
1.6 Si	Petrol	74	02/92 → 12/94						

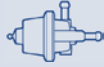

TYPE



TYPE



TYPE

ESS530

J1

SPA104

F1

SAG141

H1

SSA042

F2

ESS530

J1

SSA042

F2

SAC082

H2

SAG124

H1

SSA042

F2

SAG141

H1

SSA042

F2

SAG141

H1

SSA042

F2

SAC046

H2

SAD012

H3

SAG107

H1

SPA104

F1

ESS530

J1

SSA042

F2

SAG093

H1

SPA104

F1

ESS525

J1

SPA104

F1

SAG141

H1

SSA042

F2

SSA042

F2

BAE608I

BAE608I

ESS530

J1

SSA042

F2

SAC082

H2

SAG124

H1

BAE608I

SSA042

F2

BAE608I

SSA042

F2

SAG141

H1

SPA104

F1

ESS525

J1

SSA042

F2

BAE608I

BAE608I

SSA042

F2

SAC082

H2

SAG124

H1

BAE608I

SPA104

F1

SAG141

H1

SSA042

F2

BAE608I

ESS530

J1

KW

TYPE

TYPE
VAUXHALL
ASTRA Mk III (F) Station wagon

1.8 i	Petrol	66	09/91 → 02/98				SVF014	B6
1.8 i	Petrol	66	09/91 → 02/98					
1.8 i 16V	Petrol	85	09/94 → 02/98				B3397	B1
1.8 i 16V	Petrol	92	09/94 → 02/98				B3397	B1
2.0 i	Petrol	85	09/91 → 02/98				SVF015	B6
2.0 i	Petrol	85	09/91 → 02/98	CHASSIS: S2000001 →				
2.0 i 16V	Petrol	100	01/94 → 02/98				B3397	B1
2.0 i 16V	Petrol	100	01/94 → 02/98	ENGINE: 14142429 →				

ASTRA Mk IV (G) 2 volumi /Coda spiovente

1.2 16V	Petrol	48	02/98 → 09/00				SVF016	B6
1.2 16V	Petrol	55	09/00 → 05/05				PAS001	B5
1.2 16V	Petrol	48	02/98 → 08/00					
1.2 16V	Petrol	48	02/98 → 08/00					
1.4 16V	Petrol	66	02/98 → 05/05				B3215	B1
1.4 16V	Petrol	66	02/98 → 05/05				PAS001	B5
1.4 16V	Petrol	66	02/98 → 05/05				SVF013	B6
1.4 16V	Petrol	66	02/98 → 08/00					
1.4 16V	Petrol	66	02/98 → 05/05	ENGINE: X14XE-Z14XE				
1.4 16V	Petrol	66	02/98 → 08/00	ENGINE: X14XE				
1.6	Petrol	55	02/98 → 09/00				SVF014	B6
1.6	Petrol	62	09/00 → 05/05				PAS001	B5
1.6	Petrol	62	09/00 → 05/05					
1.6	Petrol	55	02/98 → 09/00	ENGINE: X16SZR				
1.6	Petrol	62	09/00 → 05/05	ENGINE: Z16SE				
1.6 16V	Petrol	74	02/98 → 05/05				B3215	B1
1.6 16V	Petrol	74	02/98 → 05/05				PAS001	B5
1.6 16V	Petrol	74	02/98 → 05/05				SVF013	B6
1.6 16V	Petrol	74	02/98 → 05/05	ENGINE: C16SEL-X16XEL-Z16XE				
1.6 16V	Petrol	74	03/00 → 05/05	ENGINE: Z16XEP				
1.6 16V	Petrol	74	02/98 → 08/00					
1.6 16V	Petrol	74	02/98 → 08/00	ENGINE: X16XEL				
1.6 Dualfuel	Petrol/LPG	63	09/02 → 05/05					
1.7 CDTI 16V	Diesel	59	04/03 → 05/05				PAS001	B5
1.7 CDTI 16V	Diesel	59	04/03 → 05/05	ENGINE: Z17DTL				
1.7 DTI 16V	Diesel	55	02/00 → 05/05					
1.7 TD	Diesel	50	02/98 → 08/00				PAS006	B5
1.8 16V	Petrol	92	09/00 → 05/05				PAS001	B5
1.8 16V	Petrol	85	02/98 → 09/00					
1.8 16V	Petrol	85	02/98 → 09/00					
1.8 16V	Petrol	92	09/00 → 05/05					
1.8 16V	Petrol	85	02/98 → 08/00					
2.0	Petrol	118	10/99 → 08/00				B3397	B1

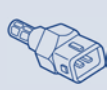
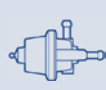

TYPE

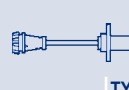

TYPE



TYPE

				SPA104	F1				
				SSA042	F2				
				SSA042	F2		SAC046	H2	
				SSA042	F2		SAC046	H2	
				SPA104	F1				ESS530
				SSA042	F2				J1
							SAG093	H1	
				SSA042	F2		SAC046	H2	
							SAG107	H1	
				SPA103	F1	SAA103	SAG019	H1	
				SPA103	F1	SAA103	SAG019	H1	BAE680AJ
									ESS532
									J1
						SAA103	SAC082	H2	BAE608H
							SAG020	H1	ESS532
									J1
				SPA103	F1				BAE608F
									ESS530
									J1
				SPA103	F1		SAG137	H1	ESS525
							SAC063	H2	ESS532
							SAG020	H1	J1
									BAE608I
									BAE608G
				SPA103	F1		SAC082	H2	BAE608H
							SAG020	H1	
									BAE608F
									BAE608L
									ESS532
									J1
									ESS530
									J1
							SAG020	H1	
							SAC094	H2	
			APS53						
							SAG117	H1	
				SPA128	F1		SAG060	H1	
							SAC071	H2	ESS532
							SAC071	H2	J1
							SAG116	H1	
							SAG120	H1	
									ESS532
									J1

KW

TYPE

TYPE
VAUXHALL
ASTRA Mk IV (G) 2 volumi /Coda spiovente

2.0 16V	Petrol	100	02/98 → 05/05				B3397	B1
2.0 16V	Petrol	100	02/98 → 05/05				SVF016	B6
2.0 DI	Diesel	60	02/98 → 05/05				PAS006	B5
2.0 DI	Diesel	60	02/98 → 08/00					
2.0 DI	Diesel	60	02/98 → 05/05	CHASSIS: → 38999999				
2.0 DI	Diesel	60	02/98 → 05/05	CHASSIS: → 38999999				
2.0 DTI 16V	Diesel	74	08/99 → 05/05				PAS001	B5
2.0 DTI 16V	Diesel	74	09/00 → 05/05					
2.0 DTI 16V	Diesel	74	08/99 → 05/05	CHASSIS: → 38999999				
2.0 DTI 16V	Diesel	74	08/99 → 05/05	CHASSIS: → 38999999				
2.0 SRI Turbo	Petrol	141	07/02 → 05/05					
2.0 SRI Turbo	Petrol	141	07/02 → 05/05					
2.2 16V	Petrol	108	03/01 → 05/05				PAS001	B5
2.2 16V	Petrol	108	03/01 → 05/05	ENGINE: Z22SE				

ASTRA Mk IV (G) Cabriolet

1.6 16V	Petrol	74	03/01 → 10/05				PAS001	B5
1.6 16V	Petrol	76	04/04 → 10/05	CHASSIS: 20EL9416 →				
1.6 16V	Petrol	74	03/01 → 10/05	ENGINE: Z16XEP				
1.6 16V	Petrol	74	03/01 → 08/05					
1.8 16V	Petrol	92	03/01 → 10/05				PAS001	B5
1.8 16V	Petrol	92	03/01 → 10/05					
1.8 16V	Petrol	92	03/01 → 08/05					
2.0	Petrol	147	09/02 → 07/06				PAS001	B5
2.0	Petrol	147	09/02 → 08/05					
2.0 Turbo	Petrol	141	03/02 → 10/05				PAS001	B5
2.0 Turbo	Petrol	141	03/02 → 10/05					
2.0 Turbo	Petrol	141	03/02 → 08/05					
2.2 16V	Petrol	108	03/01 → 10/05				PAS001	B5

ASTRA Mk IV (G) Coupé (F67)

1.8 16V	Petrol	92	09/00 → 08/05				PAS001	B5
1.8 16V	Petrol	85	03/00 → 08/05					
1.8 16V	Petrol	85	03/00 → 08/05					
1.8 16V	Petrol	92	09/00 → 08/05					
1.8 16V	Petrol	85	03/00 → 08/00					
1.8 16V Dualfuel	Petrol/LPG	87	09/02 → 08/05				PAS001	B5
2.0	Petrol	147	08/02 → 05/05				PAS001	B5
2.0 16V Turbo	Petrol	140	09/00 → 08/05				PAS001	B5
2.0 16V Turbo	Petrol	140	09/00 → 08/05					
2.2 16V	Petrol	108	03/00 → 08/05				PAS001	B5
2.2 16V	Petrol	108	03/00 → 08/05	ENGINE: Z22SE				

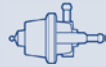

TYPE



TYPE



TYPE

						SAC032	H2		ESS532	J1
					SPA103	F1				
							SAG021	H1		
							SAG021-1	H1		
					SPA103	F1				
							SAG021	H1		
							SAG021-1	H1		
					ATS10	F2	SAC035	H2	BAE680BL	
					SPA103	F1	SAG057	H1		
							SAG083	H1		
									BAE608N	
							SAG020	H1		
						SAA103				
									BAE608L	
										ESS532
							SAC071	H2		J1
							SAG120	H1		
										ESS532
										J1
									BAE680BL	
					ATS10	F2	SAC035	H2		
							SAG057	H1		
					SPA103	F1			BAE680BL	
							SAG083	H1		
							SAC071	H2		ESS532
							SAC071	H2		J1
							SAG116	H1		
							SAG120	H1		
										ESS532
										J1
							SAC071	H2		
									BAE680BL	
					ATS10	F2	SAC035	H2	BAE680BL	
					SPA103	F1	SAG057	H1		
							SAG083	H1		
										BAE608N



KW



TYPE



TYPE

VAUXHALL

ASTRA Mk IV (G) Station wagon

1.2 16V	Petrol	48	02/98 → 09/00				SVF016	B6
1.2 16V	Petrol	55	09/00 → 05/05				PAS001	B5
1.2 16V	Petrol	48	02/98 → 08/00					
1.2 16V	Petrol	48	02/98 → 08/00					
1.4 16V	Petrol	66	02/98 → 05/05				B3215	B1
1.4 16V	Petrol	66	02/98 → 05/05				PAS001	B5
1.4 16V	Petrol	66	02/98 → 05/05				SVF013	B6
1.4 16V	Petrol	66	02/98 → 08/00					
1.4 16V	Petrol	66	02/98 → 05/05	ENGINE: X14XE-Z14XE				
1.4 16V	Petrol	66	02/98 → 08/00					
1.6	Petrol	55	03/98 → 04/04				SVF014	B6
1.6	Petrol	62	03/98 → 04/04				PAS001	B5
1.6	Petrol	76	09/04 → 05/05	CHASSIS: 20EL5306 →				
1.6	Petrol	62	03/98 → 04/04					
1.6	Petrol	55	03/98 → 09/00	ENGINE: X16SZR				
1.6	Petrol	62	08/00 → 04/04	ENGINE: Z16SE				
1.6	Petrol	55	03/98 → 09/00					
1.6 16V	Petrol	74	03/98 → 04/04				B3215	B1
1.6 16V	Petrol	74	03/98 → 04/04				PAS001	B5
1.6 16V	Petrol	74	03/98 → 04/04				SVF013	B6
1.6 16V	Petrol	74	03/98 → 08/00					
1.6 16V	Petrol	74	03/98 → 04/04	ENGINE: C16SEL-X16XEL-Z16XE				
1.6 16V	Petrol	74	03/00 → 04/04	ENGINE: Z16XEP				
1.6 16V	Petrol	74	03/98 → 08/00					
1.6 Dualfuel	Petrol/LPG	63	03/98 → 04/04				PAS001	B5
1.6 Dualfuel	Petrol/LPG	63	08/02 → 04/04	ENGINE: Z16YNG				
1.7 CDTI 16V	Diesel	59	04/03 → 05/05				PAS001	B5
1.7 CDTI 16V	Diesel	59	04/03 → 05/05	ENGINE: Z17DTL				
1.7 DTI 16V	Diesel	55	02/00 → 05/05					
1.7 TD	Diesel	50	02/98 → 08/00				PAS006	B5
1.8 16V	Petrol	92	09/00 → 05/05				PAS001	B5
1.8 16V	Petrol	85	02/98 → 08/00					
1.8 16V	Petrol	85	02/98 → 08/00					
1.8 16V	Petrol	92	09/00 → 05/05					
1.8 16V Dualfuel	Petrol/LPG	87	09/02 → 05/05				PAS001	B5
2.0 16V	Petrol	100	02/98 → 05/05				B3397	B1
2.0 16V	Petrol	100	02/98 → 05/05				SVF016	B6
2.0 DI	Diesel	60	03/98 → 04/04				PAS006	B5
2.0 DI	Diesel	60	03/98 → 08/00					
2.0 DI	Diesel	60	03/98 → 04/04	CHASSIS: → 38999999				
2.0 DI	Diesel	60	03/98 → 04/04	CHASSIS: → 38999999				
2.0 DTI 16V	Diesel	74	03/98 → 04/04				PAS001	B5
2.0 DTI 16V	Diesel	74	09/00 → 04/04					



TYPE



TYPE



TYPE

				SPA103	F1	SAA103	SAG019	H1			
				SPA103	F1	SAA103	SAG019	H1	BAE680AJ	ESS532	J1
									BAE680AJ		
										ESS532	J1
						SAA103	SAG020	H1	BAE608H		
				SPA103	F1				BAE608F		
										ESS532	J1
				SPA103	F1		SAG137	H1			
							SAC063	H2		ESS532	J1
						SAA103					
							SAG020	H1			
									BAE608I		
									BAE608G		
										ESS525	J1
							SAG020	H1	BAE608H		
				SPA103	F1						
									BAE608F		
									BAE608L		
										ESS532	J1
							SAG020	H1			
									BAE608F		
							SAC094	H2			
		APS53									
							SAG117	H1			
				SPA128	F1		SAG060	H1			
							SAC071	H2		ESS532	J1
							SAC071	H2		ESS532	J1
							SAG116	H1			
							SAG120	H1			
							SAC071	H2			
							SAC032	H2		ESS532	J1
				SPA103	F1						
							SAG021	H1			
							SAG021-1	H1			
				SPA103	F1						



KW

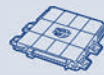

TYPE



TYPE

VAUXHALL

ASTRA Mk IV (G) Station wagon

2.0 DTI 16V	Diesel	74	03/98 → 04/04	CHASSIS: → 38999999				
2.0 DTI 16V	Diesel	74	03/98 → 04/04	CHASSIS: → 38999999				
2.2 16V	Petrol	108	03/01 → 05/05				PAS001	B5
2.2 16V	Petrol	108	03/01 → 05/05	ENGINE: Z22SE				

ASTRA Mk IV (G) Tre volumi

1.2 16V	Petrol	48	09/98 → 09/00				SVF016	B6
1.2 16V	Petrol	55	09/00 → 05/05				PAS001	B5
1.2 16V	Petrol	48	09/98 → 08/00					
1.2 16V	Petrol	48	09/98 → 08/00					
1.4 16V	Petrol	66	09/98 → 05/05				B3215	B1
1.4 16V	Petrol	66	09/98 → 05/05				PAS001	B5
1.4 16V	Petrol	66	09/98 → 05/05				SVF013	B6
1.4 16V	Petrol	66	09/98 → 08/00					
1.4 16V	Petrol	66	09/98 → 05/05	ENGINE: X14XE-Z14XE				
1.4 16V	Petrol	66	09/98 → 08/00					
1.4 16V	Petrol	66	09/98 → 08/00	ENGINE: X14XE				
1.6	Petrol	55	09/98 → 09/00				SVF014	B6
1.6	Petrol	62	09/00 → 05/05				PAS001	B5
1.6	Petrol	62	09/00 → 05/05					
1.6	Petrol	55	09/98 → 09/00	ENGINE: X16SZR				
1.6	Petrol	62	09/00 → 05/05	ENGINE: Z16SE				
1.6 16V	Petrol	74	09/98 → 05/05				B3215	B1
1.6 16V	Petrol	74	09/98 → 05/05				PAS001	B5
1.6 16V	Petrol	74	09/98 → 05/05				SVF013	B6
1.6 16V	Petrol	74	09/98 → 05/05	ENGINE: C16SEL-X16XEL-Z16XE				
1.6 16V	Petrol	74	03/00 → 05/05	ENGINE: Z16XEP				
1.6 16V	Petrol	74	09/98 → 08/00					
1.6 16V	Petrol	74	09/98 → 08/00	ENGINE: X16XEL				
1.6 Dualfuel	Petrol/LPG	63	09/02 → 05/05				PAS001	B5
1.7 CDTI 16V	Diesel	59	04/03 → 05/05				PAS001	B5
1.7 CDTI 16V	Diesel	59	04/03 → 05/05	ENGINE: Z17DTL				
1.7 DTI 16V	Diesel	55	02/00 → 05/05					
1.7 TD	Diesel	50	09/98 → 08/00				PAS006	B5
1.8 16V	Petrol	92	02/98 → 07/04				PAS001	B5
1.8 16V	Petrol	85	02/98 → 07/04					
1.8 16V	Petrol	85	02/98 → 07/04					
1.8 16V	Petrol	92	02/98 → 07/04					
1.8 16V	Petrol	85	02/98 → 08/00					
1.8 16V Dualfuel	Petrol/LPG	87	02/98 → 07/04				PAS001	B5
2.0 16V	Petrol	100	09/98 → 05/05				B3397	B1
2.0 16V	Petrol	100	09/98 → 05/05				SVF016	B6
2.0 DI	Diesel	60	02/98 → 07/04				PAS006	B5
2.0 DI	Diesel	60	02/98 → 07/04	CHASSIS: → 38999999				



TYPE



TYPE



TYPE

						SAG021	H1			
						SAG021-1	H1			
						SAG083	H1			
								BAE608N		
					SPA103	F1	SAA103	SAG019	H1	
					SPA103	F1	SAA103	SAG019	H1	BAE680AJ
										ESS532
										J1
										BAE680AJ
										ESS532
										J1
							SAA103	SAC082	H2	BAE608H
								SAG020	H1	
					SPA103	F1				BAE608F
										ESS532
										J1
										ESS530
										J1
					SPA103	F1		SAG137	H1	ESS525
								SAC063	H2	ESS532
								SAG020	H1	J1
										BAE608I
										BAE608G
					SPA103	F1		SAC082	H2	BAE608H
								SAG020	H1	
										BAE608F
										BAE608L
										ESS532
										J1
										ESS530
										J1
								SAG020	H1	
								SAC094	H2	
										APS53
										SAG117
										H1
										SAG060
										H1
										SAC071
										H2
										ESS532
										J1
										SAC071
										H2
										SAG116
										H1
										SAG120
										H1
										ESS532
										J1
										SAC071
										H2
										SAC032
										H2
										ESS532
										J1
					SPA103	F1				
										SAG021
										H1



KW

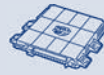

TYPE



TYPE

VAUXHALL

ASTRA Mk IV (G) Tre volumi

2.0 DI	Diesel	60	02/98 → 07/04	CHASSIS: → 38999999				
2.0 DTI 16V	Diesel	74	02/98 → 07/04				PAS001	B5
2.0 DTI 16V	Diesel	74	09/00 → 07/04					
2.0 DTI 16V	Diesel	74	02/98 → 07/04	CHASSIS: → 38999999				
2.0 DTI 16V	Diesel	74	02/98 → 07/04	CHASSIS: → 38999999				
2.2 16V	Petrol	108	03/01 → 05/05				PAS001	B5
2.2 16V	Petrol	108	03/01 → 05/05	ENGINE: Z22SE				

ASTRA Mk V (H) 2 volumi /Coda spiovente

1.2	Petrol	59	08/05 → 05/09					
1.2	Petrol	59	03/07 → 03/09					
1.3 CDTI	Diesel	66	01/04 → 05/09				PAS001	B5
1.3 CDTI	Diesel	66	01/04 → 05/09	ENGINE: Z13DTH			40CDSF1	B3
1.3 CDTI	Diesel	66	01/04 → 05/09					
1.4	Petrol	66	01/04 → 05/09				PAS001	B5
1.4	Petrol	66	01/04 → 05/09					
1.4	Petrol	55	04/04 → 12/05					
1.4	Petrol	66	01/04 → 05/09					
1.4	Petrol	55	09/04 → 12/05					
1.4	Petrol	66	03/04 → 05/09					
1.6	Petrol	77	01/04 → 05/09				PAS001	B5
1.6	Petrol	85	01/04 → 05/09				PAS001	B5
1.6	Petrol	77	01/04 → 05/09	ENGINE: 20EL5306 →				
1.6	Petrol	77	02/04 → 05/09	ENGINE: Z16XEP				
1.6	Petrol	77	01/04 → 03/07					
1.6	Petrol	85	02/07 → 05/09	CHASSIS: → 65125614				
1.7 CDTI	Diesel	59	01/04 → 05/09				PAS001	B5
1.7 CDTI	Diesel	74	01/04 → 05/09				PAS001	B5
1.7 CDTI	Diesel	81	01/04 → 05/09				PAS001	B5
1.7 CDTI	Diesel	59	03/04 → 03/07	ENGINE: Z17DTL				
1.7 CDTI	Diesel	74	03/04 → 03/07	ENGINE: Z17DTH				
1.7 TD	Diesel	79	01/04 → 05/09				PAS001	B5
1.8	Petrol	103	01/04 → 05/09				PAS001	B5
1.8	Petrol	92	01/04 → 05/09				PAS001	B5
1.8	Petrol	92	01/04 → 05/09					
1.8	Petrol	92	01/04 → 02/09					
1.9 CDTI	Diesel	110	01/04 → 05/09				PAS001	B5
1.9 CDTI	Diesel	88	01/04 → 05/09				PAS001	B5
1.9 CDTI	Diesel	110	01/04 → 05/09					
1.9 CDTI 16V	Diesel	88	01/04 → 05/09				PAS001	B5
1.9 CDTI 16V	Diesel	88	01/04 → 05/09					
2.0 Turbo	Petrol	125	01/04 → 05/09				PAS001	B5
2.0 Turbo	Petrol	147	01/04 → 05/09				PAS001	B5
2.0 Turbo	Petrol	177	01/04 → 05/09				PAS001	B5
2.0 Turbo	Petrol	125	01/04 → 05/09					



TYPE

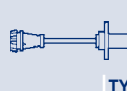

TYPE



TYPE

						SAG021-1	H1			
					SPA103	F1				
							SAG021	H1		
							SAG021-1	H1		
							SAG083	H1		
									BAE608N	
						SAA103	SAC092	H2		
									BAE680AL	
					ATS20	F2		SAC093	H2	GA2180
										J2
								SAG025	H1	
					SPA103	F1	SAA103	SAC092	H2	SUA548
								SAD026	H3	J2
							SAA103			
								SAG019	H1	
									BAE680AL	
									BAE680AL	
								SAG020	H1	
							SAA103			
							SAA103			
									BAE608L	
										SUA548
										J2
										SUA548
										J2
							SAC094	H2		
							SAC094	H2		
					APS53					
					APS53					
							SAA103			SUA548
										J2
								SAC071	H2	
								SAG120	H1	
										SUA548
										J2
					ATS20	F2		SAC068	H2	GA2195
					ATS20	F2		SAC088	H2	GA2195
										J2
								SAG133	H1	
					ATS20	F2		SAC068	H2	
										J2
								SAG133	H1	
					ATS10	F2		SAC035	H2	GA2092
					ATS10	F2		SAC035	H2	GA2092
										J2
					ATS10	F2		SAC035	H2	
										J2
								SAG057	H1	



KW

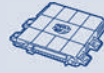

TYPE



TYPE

VAUXHALL

ASTRA Mk V (H) 2 volumi /Coda spiovente

2.0 Turbo	Petrol	147	01/04 → 05/09						
2.0 Turbo	Petrol	177	01/04 → 05/09						
2.0 Turbo	Petrol	177	01/04 → 09/05						
2.0 Turbo	Petrol	125	03/04 → 02/09						
2.0 Turbo	Petrol	147	03/04 → 05/09						
2.0 Turbo	Petrol	177	03/05 → 05/09						
2.0 Turbo	Petrol	125	01/04 → 02/09						

ASTRA Mk V (H) Sport Hatch

1.3 CDTI	Diesel	66	04/05 → 11/10				PAS001	B5	
1.3 CDTI	Diesel	66	04/05 → 11/10	ENGINE: Z13DTH			40CDSF1	B3	
1.4	Petrol	55	02/05 → 11/10						
1.4	Petrol	55	09/05 → 02/09						
1.4 i 16V	Petrol	66	03/05 → 11/10				PAS001	B5	
1.4 i 16V	Petrol	66	06/05 → 03/09						
1.6	Petrol	132	10/06 → 11/10				PAS001	B5	
1.6	Petrol	77	02/05 → 11/10				PAS001	B5	
1.6	Petrol	77	02/05 → 11/10	ENGINE: 20EL5306 →					
1.6	Petrol	77	02/05 → 11/10	ENGINE: Z16XEP					
1.6	Petrol	77	08/05 → 03/08	CHASSIS: → 65125614					
1.6 i 16V	Petrol	85	12/06 → 11/10				PAS001	B5	
1.7 CDTI	Diesel	74	02/05 → 11/10				PAS001	B5	
1.7 CDTI	Diesel	81	02/07 → 11/10				PAS001	B5	
1.7 CDTI	Diesel	74	06/05 → 03/07	ENGINE: Z17DTH					
1.8	Petrol	92	02/05 → 11/10				PAS001	B5	
1.8	Petrol	92	05/05 → 02/09						
1.8 i 16V	Petrol	103	03/07 → 11/10				PAS001	B5	
1.9 CDTI	Diesel	110	02/05 → 11/10				PAS001	B5	
1.9 CDTI	Diesel	74	08/05 → 11/10				PAS001	B5	
1.9 CDTI	Diesel	88	02/05 → 11/10				PAS001	B5	
1.9 CDTI	Diesel	110	02/05 → 11/10						
1.9 CDTI	Diesel	88	02/05 → 11/10						
2.0 Turbo	Petrol	125	02/05 → 11/10				PAS001	B5	
2.0 Turbo	Petrol	125	02/05 → 11/10						
2.0 Turbo	Petrol	125	06/05 → 02/09						
2.0 Turbo	Petrol	125	05/05 → 02/09						
2.0 VXR	Petrol	176	02/09 → 11/10				PAS001	B5	
2.0 VXR	Petrol	176	02/09 → 03/09						

ASTRA Mk V (H) Station wagon

1.2	Petrol	59	08/05 → 10/10						
1.2	Petrol	59	03/07 → 03/09						
1.3 CDTI	Diesel	66	08/04 → 03/09				PAS001	B5	
1.3 CDTI	Diesel	66	08/04 → 03/09	ENGINE: Z13DTH			40CDSF1	B3	
1.3 CDTI	Diesel	66	08/04 → 03/09						
1.4	Petrol	66	08/04 → 03/09				PAS001	B5	

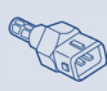
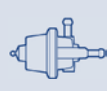

TYPE

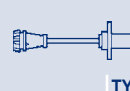

TYPE



TYPE

				SPA103	F1		SAG057	H1			
							SAG057	H1			
				SPA103	F1						
										BAE680BL	
										BAE680BL	
										BAE680BL	
											SUA549 J2
							SAA103				
										BAE680AL	
							SAA103	SAC092	H2		
										BAE680AL	
							SAA103	SAC092	H2		
								SAG020	H1		
							SAA103				
										BAE608L	
											SUA548 J2
							SAA103				
								SAC094	H2		
				APS53							
								SAG120	H1		
											SUA548 J2
							SAA103				
				ATS10	F2		SAC068	H2			GA2195 J2
				ATS20	F2		SAC068	H2			GA2195 J2
							SAG133	H1			
							SAG133	H1			
				ATS10	F2		SAC035	H2			GA2092 J2
							SAG057	H1			
										BAE680BL	
											SUA549 J2
										BAE680BL	
							SAA103	SAC092	H2		
										BAE680AL	
				ATS20	F2		SAC093	H2			GA2180 J2
							SAG025	H1			
				SPA103	F1	SAA103	SAC092	H2	BAE680AL	SUA548	J2



KW



TYPE



TYPE

VAUXHALL

ASTRA Mk V (H) Station wagon

1.4	Petrol	66	08/04 → 03/09						
1.4	Petrol	55	08/04 → 03/06						
1.4	Petrol	66	08/04 → 03/09						
1.4	Petrol	55	09/04 → 12/05						
1.6	Petrol	132	08/04 → 03/09				PAS001	B5	
1.6	Petrol	77	08/04 → 03/09				PAS001	B5	
1.6	Petrol	85	08/04 → 03/09				PAS001	B5	
1.6	Petrol	77	08/04 → 03/09	ENGINE: 20EL5306 →					
1.6	Petrol	77	08/04 → 03/09	ENGINE: Z16XEP					
1.6	Petrol	77	08/04 → 03/07						
1.6	Petrol	85	08/07 → 03/09						
1.7 CDTI	Diesel	74	08/04 → 03/09				PAS001	B5	
1.7 CDTI	Diesel	81	08/04 → 03/09				PAS001	B5	
1.7 CDTI	Diesel	74	08/04 → 03/07	ENGINE: Z17DTH					
1.7 TD	Diesel	79	08/04 → 03/09				PAS001	B5	
1.8	Petrol	103	10/04 → 03/09				PAS001	B5	
1.8	Petrol	92	10/04 → 03/09				PAS001	B5	
1.8	Petrol	92	10/04 → 03/09						
1.8	Petrol	92	10/04 → 02/09						
1.9 CDTI	Diesel	110	08/04 → 03/09				PAS001	B5	
1.9 CDTI	Diesel	74	08/04 → 03/09				PAS001	B5	
1.9 CDTI	Diesel	88	08/04 → 03/09				PAS001	B5	
1.9 CDTI	Diesel	88	08/04 → 03/09				PAS001	B5	
1.9 CDTI	Diesel	110	08/04 → 03/09						
1.9 CDTI	Diesel	88	08/04 → 03/09						
2.0 Turbo	Petrol	125	08/04 → 10/10				PAS001	B5	
2.0 Turbo	Petrol	147	08/04 → 10/10				PAS001	B5	
2.0 Turbo	Petrol	125	08/04 → 10/10						
2.0 Turbo	Petrol	147	08/04 → 10/10						
2.0 Turbo	Petrol	125	08/04 → 02/09						
2.0 Turbo	Petrol	147	08/04 → 03/10						
2.0 Turbo	Petrol	125	08/04 → 02/09						

ASTRA Mk VI (J)

1.4	Petrol	64	12/09 →						
1.4	Petrol	74	12/09 →						
1.4 Turbo	Petrol	103	12/09 →						
1.6	Petrol	85	12/09 →						
1.6 Turbo	Petrol	132	12/09 →						

ASTRA Mk VI (J) Sports Tourer

1.4	Petrol	64	12/09 →						
1.4	Petrol	74	10/10 →						
1.4 Turbo	Petrol	103	10/10 →						
1.6	Petrol	85	10/10 →						
1.6 Turbo	Petrol	132	10/10 →						



TYPE



TYPE



TYPE

						SAD026	H3			
					SAA103					
						SAG019	H1			
								BAE680AL		
					SAA103	SAC092	H2			
						SAG020	H1			
					SAA103					
					SAA103					
								BAE608L		
									SUA548	J2
									SUA548	J2
						SAC094	H2			
				APS53						
					SAA103					
						SAC071	H2			
						SAG120	H1			
									SUA548	J2
				ATS20	F2	SAC068	H2		GA2195	J2
				ATS20	F2	SAC068	H2			
				ATS20	F2	SAC088	H2		GA2195	J2
						SAG133	H1			
						SAG133	H1			
				ATS10	F2	SAC035	H2		GA2092	J2
				ATS10	F2	SAC035	H2		GA2092	J2
				SPA103	F1	SAG057	H1			
				SPA103	F1	SAG057	H1			
								BAE680BL		
								BAE680BL		
									SUA549	J2
					SAA103					
					SAA103					
					SAA103					
					SAA103			BAE680CS		
					SAA103			BAE680CS		
					SAA103					
					SAA103					
					SAA103			BAE680CS		
					SAA103			BAE680CS		



KW

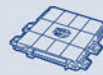

TYPE



TYPE

VAUXHALL

ASTRA Mk VI (J) Tre volumi

1.6	Petrol	85	06/12 →						
1.6 Turbo	Petrol	132	06/12 →						

ASTRA TwinTop Mk V (H)

1.6	Petrol	132	10/06 → 11/10				PAS001	B5
1.6	Petrol	77	09/05 → 11/10				PAS001	B5
1.6	Petrol	77	09/05 → 11/10	ENGINE: 20EL5306 →				
1.6	Petrol	77	02/06 → 11/10					
1.6	Petrol	77	09/05 → 03/08	CHASSIS: → 65125614				
1.6 i 16V	Petrol	85	10/06 → 11/10				PAS001	B5
1.6 i 16V	Petrol	85	02/07 → 11/10	CHASSIS: → 65125614				
1.8	Petrol	103	05/08 → 11/10				PAS001	B5
1.8	Petrol	103	05/08 → 11/10	CHASSIS: 20EL5306 →				
1.9 CDTI	Diesel	110	01/06 → 11/10				PAS001	B5
2.0	Petrol	125	02/06 → 11/10				PAS001	B5
2.0	Petrol	125	02/06 → 11/10					
2.0	Petrol	125	02/06 → 02/09					
2.0 Turbo	Petrol	147	01/06 → 11/10				PAS001	B5
2.0 Turbo	Petrol	147	01/06 → 12/09					

ASTRAVAN Mk III (F)

1.4 i	Petrol	44	01/91 → 10/94				SVF014	B6
1.4 i	Petrol	44	09/91 → 10/94					
1.6 i	Petrol	52	02/94 → 10/96				SVF014	B6
1.6 i	Petrol	55	01/91 → 08/98				SVF014	B6
1.6 i	Petrol	55	01/91 → 08/98	ENGINE: C16SE				
1.6 i	Petrol	55	09/91 → 02/98					

ASTRAVAN Mk IV (G)

1.6 i	Petrol	55	08/98 → 09/00				SVF014	B6
1.6 i	Petrol	62	09/00 → 08/06				PAS001	B5
1.6 i	Petrol	62	09/00 → 08/06					
1.6 i	Petrol	55	08/98 → 09/00	ENGINE: X16SZR				
1.6 i	Petrol	62	09/00 → 08/05					
1.7 CDTI	Diesel	59	04/04 → 08/06				PAS001	B5
1.7 CDTI	Diesel	59	04/04 → 08/05	ENGINE: Z17DTL				
1.7 TD	Diesel	50	08/98 → 08/06				PAS006	B5
1.7 TD	Diesel	50	08/98 → 08/00					
2.0 DI	Diesel	60	08/98 → 08/06				PAS006	B5
2.0 DI	Diesel	60	08/98 → 08/00					
2.0 DTI	Diesel	74	04/04 → 08/06				PAS001	B5
2.0 DTI	Diesel	74	04/04 → 08/05					

ASTRAVAN Mk V (H)

1.3 CDTI	Diesel	66	08/05 →				PAS001	B5
1.3 CDTI	Diesel	66	08/05 →	ENGINE: Z13DTH			40CDSF1	B3
1.4 i	Petrol	66	03/05 →				PAS001	B5
1.4 i	Petrol	66	03/05 → 03/10					



KW



TYPE



TYPE

VAUXHALL

ASTRAVAN Mk V (H)

1.6	Petrol	76	03/05 →				PAS001	B5
1.6	Petrol	76	03/05 →	CHASSIS: 20EL5306 →				
1.7 CDTI	Diesel	59	03/05 → 07/06				PAS001	B5
1.7 CDTI	Diesel	74	03/05 → 11/11				PAS001	B5
1.7 CDTI	Diesel	59	03/05 → 07/06	ENGINE: Z17DTL				
1.7 CDTI	Diesel	74	03/05 → 03/07	ENGINE: Z17DTH				
1.9 CDTI	Diesel	110	03/05 → 11/11				PAS001	B5
1.9 CDTI	Diesel	88	03/05 → 11/11				PAS001	B5

CARLTON Mk II

1.8 S	Petrol	65	12/82 → 08/86					
-------	--------	----	---------------	--	--	--	--	--

CARLTON Mk III

1.8	Petrol	65	09/87 → 03/94					
1.8	Petrol	65	09/87 → 03/94	CHASSIS: P1132204 →				
1.8 i	Petrol	85	09/86 → 03/94				SVF012	B6
1.8 i	Petrol	85	09/86 → 03/94	CHASSIS: P1132204 →				
1.8 i	Petrol	85	01/87 → 03/94					
1.8 i	Petrol	85	09/86 → 03/94	CHASSIS: K1000099 →				
2.0 i	Petrol	90	09/86 → 03/94				SVF012	B6
2.0 i	Petrol	90	09/86 → 03/94	CHASSIS: P1132204 →				
2.0 i	Petrol	90	01/87 → 03/94					
2.0 i	Petrol	90	09/86 → 03/94	CHASSIS: K1000099 →				
3.0 3000	Petrol	130	03/87 → 09/90					
3.0 3000	Petrol	130	01/88 → 09/90	CHASSIS: 0109242 →				
3.0 3000	Petrol	130	03/87 → 09/90	CHASSIS: K1000099 →				
3.0 3000 24V	Petrol	150	09/89 → 03/94					
3.0 3000 24V	Petrol	150	09/89 → 03/94	CHASSIS: K1000099 →				

CARLTON Mk III Station wagon

1.8	Petrol	65	09/87 → 03/94					
1.8	Petrol	65	09/87 → 03/94	CHASSIS: P1132204 →				
1.8 i	Petrol	85	09/86 → 03/94				SVF012	B6
1.8 i	Petrol	85	09/86 → 03/94	CHASSIS: P1132204 →				
1.8 i	Petrol	85	01/87 → 03/94					
1.8 i	Petrol	85	09/86 → 03/94	CHASSIS: K1000099 →				
2.0 i	Petrol	90	09/86 → 03/94				SVF012	B6
2.0 i	Petrol	90	09/86 → 03/94	CHASSIS: P1132204 →				
2.0 i	Petrol	90	01/87 → 03/94					
2.0 i	Petrol	90	09/86 → 03/94	CHASSIS: K1000099 →				

CAVALIER Mk II

2.0 i	Petrol	85	09/86 → 08/88					
-------	--------	----	---------------	--	--	--	--	--

CAVALIER Mk III (87)

1.6 i	Petrol	52	09/93 → 11/95				SVF014	B6
1.6 i	Petrol	55	09/88 → 11/95				SVF014	B6
1.6 i	Petrol	52	09/93 → 11/95	ENGINE: X16SZ				
1.6 i	Petrol	52	09/94 → 11/95					



KW

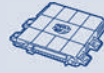

TYPE



TYPE

VAUXHALL

CAVALIER Mk III (87)

1.8	Petrol	66	09/88 → 08/95	CHASSIS: → P7999999				
1.8	Petrol	66	09/88 → 10/92					
1.8 i Cat.	Petrol	66	03/90 → 11/95			SVF014	B6	
1.8 i Cat.	Petrol	66	03/90 → 11/95	CHASSIS: → P7999999				
2.0 i	Petrol	85	09/88 → 10/90	CHASSIS: → P7999999				
2.0 i	Petrol	85	09/88 → 10/90					
2.0 i 16V	Petrol	110	09/88 → 11/95					
2.0 i 16V 4x4	Petrol	110	09/88 → 11/95					
2.0 i 16V 4x4	Petrol	110	09/88 → 11/95	CHASSIS: S1008893 →				
2.0 i 4x4	Petrol	85	01/91 → 10/92	CHASSIS: → P7999999				
2.0 i 4x4	Petrol	95	09/88 → 09/92					
2.0 i 4x4	Petrol	85	01/91 → 10/92					
2.0 i 4x4	Petrol	95	09/88 → 09/92	CHASSIS: S1008893 →				
2.0 i Cat.	Petrol	85	09/90 → 11/95	CHASSIS: → P7999999				
2.0 i Cat.	Petrol	85	09/90 → 11/95					
2.0 i Turbo 4x4	Petrol	150	06/92 → 11/94					
2.0 i Turbo 4x4	Petrol	150	08/92 → 11/94	CHASSIS: S1008893 →				
2.0 SRi	Petrol	95	09/88 → 09/92					
2.0 SRi 16V	Petrol	100	09/93 → 11/95					
2.5 V6	Petrol	125	08/88 → 06/94	CHASSIS: S1035179 →				
2.5 V6	Petrol	125	08/88 → 06/94					

CAVALIER Mk III 2 volumi /Coda spiovente

1.6 i	Petrol	52	09/93 → 11/95			SVF014	B6	
1.6 i	Petrol	55	09/88 → 11/95			SVF014	B6	
1.6 i	Petrol	52	09/93 → 11/95	ENGINE: X16SZ				
1.6 i	Petrol	52	09/94 → 11/95					
1.8	Petrol	66	09/88 → 10/90	CHASSIS: → P7999999				
1.8	Petrol	66	09/88 → 10/90					
1.8 i Cat.	Petrol	66	03/90 → 11/95			SVF014	B6	
1.8 i Cat.	Petrol	66	03/90 → 11/95	CHASSIS: → P7999999				
2.0 i	Petrol	85	09/88 → 10/92	CHASSIS: → P7999999				
2.0 i	Petrol	85	09/88 → 10/92					
2.0 i 16V	Petrol	100	09/93 → 11/95					
2.0 i 16V	Petrol	110	09/88 → 11/95					
2.0 i 16V 4x4	Petrol	110	01/92 → 11/93					
2.0 i 4x4	Petrol	85	01/91 → 10/92	CHASSIS: → P7999999				
2.0 i 4x4	Petrol	95	09/88 → 09/92					
2.0 i 4x4	Petrol	85	01/91 → 10/92					
2.0 i Cat.	Petrol	85	09/90 → 11/95	CHASSIS: → P7999999				
2.0 i Cat.	Petrol	85	09/90 → 11/95					
2.0 SRi	Petrol	95	09/88 → 09/92					
2.5 V6	Petrol	125	09/88 → 06/94	CHASSIS: S1035179 →				
2.5 V6	Petrol	125	09/88 → 06/94					

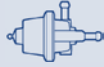

TYPE

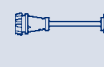

TYPE



TYPE

							SAG093	H1				
										ESS525	J1	
										ESS525	J1	
							SAG093	H1				
							SAG093	H1				
										ESS530	J1	
							SAG093	H1		ESS530	J1	
							SAG093	H1				
										ESS530	J1	
							SAG093	H1		ESS530	J1	
							SAG093	H1				
							SAG093	H1		ESS530	J1	
							SAG093	H1		ESS530	J1	
							SAG093	H1				
							SAG093	H1		ESS530	J1	
							SAG093	H1		ESS530	J1	
							SAC061	H2		ESS530	J1	
							SAC025	H2				
										ESS530	J1	
							SAG141	H1				
										ESS525	J1	
									BAE608I			
										ESS525	J1	
							SAG093	H1				
										ESS525	J1	
										ESS525	J1	
							SAG093	H1				
							SAG093	H1				
										ESS530	J1	
							SAC061	H2		ESS530	J1	
							SAG093	H1		ESS530	J1	
							SAG093	H1		ESS530	J1	
							SAG093	H1				
							SAG093	H1		ESS530	J1	
										ESS530	J1	
							SAG093	H1				
							SAG093	H1		ESS530	J1	
							SAG093	H1		ESS530	J1	
							SAC025	H2				
										ESS530	J1	



KW



TYPE



TYPE

VAUXHALL

COMBO Mk I (B)

1.2	Petrol	33	07/94 → 10/01				SVF014	B6
1.4	Petrol	44	07/94 → 10/01				SVF014	B6
1.4	Petrol	60	07/94 → 10/01				SVF013	B6
1.4	Petrol	60	08/94 → 10/01					
1.7 D	Diesel	44	07/94 → 10/01					

COMBO Mk II (C) Cassone / Furgonato / Promiscuo (F25)

1.3 CDTI 16V	Diesel	55	10/05 → 11/11					
1.3 CDTI 16V	Diesel	55	10/05 → 11/11					
1.4 16V	Petrol	66	01/04 → 05/07					
1.4 i 16V	Petrol	66	01/04 → 11/11				B3215	B1
1.4 i 16V	Petrol	66	01/04 → 11/11				SVF013	B6
1.4 i 16V	Petrol	66	09/04 → 11/11					
1.4 i 16V	Petrol	66	10/04 → 11/11					
1.6	Petrol	62	08/01 → 10/04					
1.6	Petrol	64	10/01 → 11/11					
1.6	Petrol	64	10/01 → 11/11					
1.6	Petrol	64	10/01 → 11/11	ENGINE: Z16SE				
1.6	Petrol	62	09/01 → 08/04					
1.6	Petrol	64	10/01 → 08/04					
1.7 CDTI 16V	Diesel	74	12/04 → 11/11	ENGINE: Z17DTH				
1.7 DI 16V	Diesel	48	09/01 → 11/11					
1.7 DTI 16V	Diesel	55	10/01 → 11/11					

COMBO TOUR Mk II (C) (F25)

1.4	Petrol	66	10/04 → 09/10					
1.7 CDTI 16V	Diesel	74	12/04 → 09/10	ENGINE: Z17DTH				

CORSA Cabriolet

1.4 i 16V	Petrol	66	01/98 → 01/99				B3215	B1
-----------	--------	----	---------------	--	--	--	-------	----

CORSA Mk I (B)

1.2 i 16V	Petrol	48	03/98 → 09/00				SVF016	B6
1.2 i 16V	Petrol	48	03/98 → 09/00					
1.2 i 16V	Petrol	48	03/98 → 08/00					
1.2 i 16V	Petrol	48	03/98 → 08/00					

CORSA Mk II (C) (W5L, F08)

1.0 12V	Petrol	43	09/00 → 08/03					
1.0 12V	Petrol	43	09/00 → 10/03					
1.0 12V	Petrol	44	11/03 → 10/06					
1.0 12V	Petrol	44	11/03 → 08/05					
1.2 16V	Petrol	55	09/00 → 06/04					
1.2 16V	Petrol	55	09/00 → 10/06					
1.2 16V	Petrol	55	09/00 → 10/06	ENGINE: Z14XE				
1.2 16V	Petrol	55	09/00 → 08/04					
1.2 16V Dualfuel	Petrol/LPG	55	08/01 → 06/04					
1.2 16V Dualfuel	Petrol/LPG	55	08/01 → 10/06					
1.2 16V Dualfuel	Petrol/LPG	55	08/01 → 08/04					



TYPE

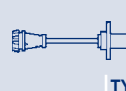

TYPE



TYPE

				SSA042	F2		SAG141	H1			
				SSA042	F2		SAG141	H1			
				SSA042	F2		SAG141	H1			
										ESS532	J1
				SSA042	F2						
							SAC093	H2			
							SAG025	H1			
										BAE680AL	
							SAC092	H2		BAE680AL	
							SAD026	H3			
				SPA103	F1		SAG019	H1			
						SAA103					
							SAG020	H1			
							SAC063	H2			
							SAG020	H1			
										BAE608G	
										ESS532	J1
										ESS532	J1
	APS53										
							SAG117	H1			
							SAG117	H1			
							SAC092	H2		BAE680AL	
	APS53										
										ESS532	J1
				SPA103	F1	SAA103	SAG019	H1			
				SSA042	F2					BAE680AJ	
										ESS532	J1
				SPA103	F1		SAG019	H1		BAE680AI	
						SAA103					
						SAA103	SAC092	H2			
										BAE680BN	
				SPA103	F1		SAG019	H1			
						SAA103					
										BAE608F	
										BAE680AJ	
				SPA103	F1		SAG019	H1			
						SAA103					
										BAE680AJ	



KW



TYPE



TYPE

VAUXHALL

CORSA Mk II (C) (W5L, F08)

1.2 Twinport	Petrol	59	07/04 → 10/06					
1.2 Twinport	Petrol	59	09/04 → 09/06					
1.3 CDTI 16V	Diesel	52	08/00 → 09/06					
1.3 CDTI 16V	Diesel	52	08/00 → 09/06					
1.4 16V	Petrol	66	09/00 → 10/06					
1.7 CDTI 16V	Diesel	74	09/03 → 08/05	ENGINE: Z17DTH				
1.7 DI 16V	Diesel	48	08/00 → 09/06					
1.7 DTI 16V	Diesel	55	08/00 → 09/06					
1.8 16V	Petrol	92	08/00 → 09/06					
1.8 16V	Petrol	92	08/00 → 09/06					

CORSA Mk III (D) (L_8)

1.0	Petrol	44	11/06 →					
1.0	Petrol	44	11/06 → 10/09					
1.0 i 12V	Petrol	48	06/10 →					
1.2	Petrol	59	11/06 →					
1.2 i 16V	Petrol	63	11/06 →					
1.2 LPG	Petrol/LPG	59	09/09 →					
1.2 LPG	Petrol/LPG	59	12/09 →					
1.3 CDTI	Diesel	55	11/06 →					
1.3 CDTI	Diesel	55	11/06 →					
1.3 CDTI	Diesel	66	11/06 →					
1.3 CDTI	Diesel	66	11/06 →					
1.4	Petrol	64	01/10 →					
1.4	Petrol	66	07/06 →					
1.4	Petrol	74	07/10 →					
1.4	Petrol	66	07/06 → 11/10					
1.4 LPG	Petrol/LPG	64	09/09 →					
1.4 LPG	Petrol/LPG	66	07/06 →					
1.4 LPG	Petrol/LPG	66	12/09 → 11/10					
1.6 SRi	Petrol	110	05/07 →					
1.6 VXR	Petrol	141	02/07 →					
1.6 VXR	Petrol	150	06/11 → 12/11					

CORSAVAN Mk I (B)

1.4 i	Petrol	44	01/94 → 09/00			SVF014	B6
1.4 i	Petrol	44	01/94 → 09/00	ENGINE: X14SZ			
1.4 i	Petrol	44	09/94 → 08/00				

CORSAVAN Mk II (C)

1.2 16V	Petrol	55	09/00 → 08/04				
1.2 16V	Petrol	55	09/00 → 06/06				
1.2 16V Dualfuel	Petrol/LPG	55	08/01 → 08/04				
1.2 16V Dualfuel	Petrol/LPG	55	08/01 → 06/06				
1.3 CDTI 16V	Diesel	52	04/04 → 06/06				
1.3 CDTI 16V	Diesel	52	04/04 → 06/06				
1.4	Petrol	66	11/03 → 06/06				

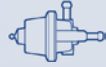

TYPE



TYPE



TYPE

					SAA103	SAC092	H2			
								BAE680AL		
	APS23					SAC093	H2		ESS0070A	J1
						SAG025	H1			
						SAG020	H1			
	APS53									
						SAG117	H1			
						SAG117	H1			
						SAC071	H2			
						SAG120	H1			
					SAA103					
								BAE680BN		
					SAA103					
					SAA103	SAC092	H2	BAE680AL		
					SAA103					
						SAC092	H2			
								BAE680AL		
						SAC093	H2			
						SAG025	H1			
						SAC093	H2			
						SAG025	H1			
					SAA103					
					SAA103	SAC092	H2			
					SAA103					
								BAE680AL		
					SAA103					
						SAC092	H2			
								BAE680AL		
					SAA103					
					SAA103	SAC092	H2			
					SAA103					
								BAE680I		
									ESS525	J1
					SPA103	F1		SAG019	H1	BAE680AJ
					SAA103					
					SPA103	F1		SAG019	H1	BAE680AJ
					SAA103					
	APS23							SAC093	H2	ESS0070A
								SAG025	H1	
					SAA103	SAC092	H2			



KW

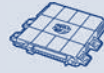

TYPE



TYPE

VAUXHALL

CORSAVAN Mk II (C)

1.7 DI 16V	Diesel	48	09/00 → 06/06					
1.7 DTI 16V	Diesel	55	09/00 → 06/06					

CORSAVAN Mk III (D)

1.2	Petrol	51	01/10 →					
1.2	Petrol	59	07/09 →					

FRONTERA Mk I (A)

2.2 i	Petrol	100	03/95 → 10/98				SVF015	B6
2.2 i	Petrol	100	03/95 → 10/98	CHASSIS: → TV899999				
2.4 i	Petrol	92	03/92 → 08/95				SVF015	B6
2.4 i	Petrol	92	03/92 → 10/98					
2.5 TDS	Diesel	85	11/91 → 06/98					

FRONTERA Mk I (A) Sport

2.0 i	Petrol	85	03/92 → 10/98				SVF015	B6
2.5 TDS	Diesel	85	09/96 → 10/98					

FRONTERA Mk II (B)

2.2 DTI	Diesel	85	10/98 → 09/04	ENGINE: 3V500001 →				
2.2 DTI	Diesel	85	10/98 → 09/04					
2.2 DTI	Diesel	85	10/98 → 09/04					
2.2 i	Petrol	100	10/98 → 10/04	CHASSIS: → YV5999999			SVF013	B6
2.2 i	Petrol	100	10/98 → 10/04	ENGINE: X22SE-Y22SE				

INSIGNIA

1.4	Petrol	103	04/11 →					
1.6	Petrol	85	07/08 →					
1.6 Turbo	Petrol	132	01/09 →					
1.8	Petrol	103	07/08 → 09/13					

INSIGNIA Sports Tourer

1.4	Petrol	103	04/11 →					
1.6	Petrol	85	07/08 →					
1.6 Turbo	Petrol	132	01/09 →					
1.8	Petrol	103	07/08 → 09/13					

INSIGNIA Tre volumi

1.4	Petrol	103	04/11 →					
1.6	Petrol	85	07/08 →					
1.6 Turbo	Petrol	132	01/09 →					
1.8	Petrol	103	07/08 → 09/13					

MERIVA Mk I (A)

1.3 CDTI	Diesel	55	01/03 → 10/09					
1.3 CDTI	Diesel	55	01/03 → 10/09					
1.4 16V Twinport	Petrol	66	01/03 → 10/09					
1.4 16V Twinport	Petrol	66	01/03 → 10/09					
1.4 16V Twinport	Petrol	66	07/04 → 10/09					
1.6 i	Petrol	64	01/03 → 06/10					
1.6 i	Petrol	64	01/03 → 06/10					
1.6 i	Petrol	64	04/03 → 06/10	ENGINE: Z16SE				



KW



TYPE



TYPE

VAUXHALL

MERIVA Mk I (A)

1.6 i 16V	Petrol	74	01/03 → 09/05						
1.6 i 16V	Petrol	74	01/03 → 09/05						
1.6 i 16V	Petrol	74	04/03 → 09/05	ENGINE: Z16XE					
1.6 i 16V Twinport	Petrol	77	05/03 → 06/10						
1.6 i 16V Twinport	Petrol	77	04/06 → 06/10						
1.6 Turbo	Petrol	132	05/06 → 06/10						
1.6 Turbo	Petrol	132	05/06 → 06/10						
1.7 CDTI 16V	Diesel	74	09/03 → 08/05	ENGINE: Z17DTH					
1.8 i 16V	Petrol	92	05/03 → 08/05						
1.8 i 16V	Petrol	92	05/03 → 08/05						

MERIVA Mk II (B)

1.4	Petrol	103	06/10 →						
1.4	Petrol	74	06/10 →						
1.4	Petrol	88	06/10 →						

MOKKA

1.4 4x4	Petrol	103	06/12 →						
1.6	Petrol	85	06/12 →						

NOVA

1.4 S	Petrol	55	01/90 → 02/93	CHASSIS: K4000001 →					
1.5 TD	Diesel	49	01/90 → 02/93	CHASSIS: K4000001 →					

NOVA 2 volumi /Coda spiovente

1.0	Petrol	33	05/83 → 03/93	CHASSIS: K4000001 →					
1.2 S	Petrol	40	05/83 → 02/90	CHASSIS: K4000001 →					
1.2 S	Petrol	43	01/88 → 02/90	CHASSIS: K4000001 →					
1.3 S	Petrol	51	05/83 → 10/89	CHASSIS: K4000001 →					
1.4 S	Petrol	55	01/90 → 03/93	CHASSIS: K4000001 →					
1.5 TD	Diesel	49	01/90 → 03/93	CHASSIS: K4000001 →					
1.6 GSI	Petrol	74	05/88 → 03/92				B3215		B1
1.6 GSI	Petrol	74	05/88 → 03/92				SVF013		B6
1.6 GSI	Petrol	74	05/88 → 03/92	CHASSIS: K4000001 →					
1.6 GSI	Petrol	74	05/88 → 03/92	ENGINE: E16SE					

NOVAVAN

1.2	Petrol	38	01/90 → 10/94	CHASSIS: K4000001 →					
-----	--------	----	---------------	---------------------	--	--	--	--	--

OMEGA (B)

2.0	Petrol	85	09/95 → 09/96				SVF015		B6
2.0	Petrol	85	09/95 → 09/96	CHASSIS: X1093314 →					
2.0 DTI 16V	Diesel	74	01/98 → 08/00						
2.0 DTI 16V	Diesel	74	01/98 → 09/00						
2.0 DTI 16V	Diesel	74	01/98 → 09/00						
2.2 16V	Petrol	106	01/94 → 06/03						
2.2 16V	Petrol	106	09/99 → 06/03						
2.2 DTI 16V	Diesel	88	08/00 → 07/03						
2.2 DTI 16V	Diesel	88	08/00 → 07/03						
2.6 V6	Petrol	132	08/00 → 07/03	ENGINE: → 08149313					



TYPE

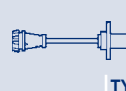

TYPE



TYPE

							SAC080	H2		GA2213	J2
							SAG020	H1			
										BAE608F	
						SAA103					
							SAG020	H1			
						SAA103	SAC092	H2			
							SAD026	H3			
		APS53									
							SAC071	H2		GA2213	J2
							SAG120	H1			
						SAA103					
						SAA103					
						SAA103					
						SAA103					
						SAA103					
						SAA103					
						SSA042	F2				
						SSA042	F2				
						SSA042	F2				
						SSA042	F2				
						SSA042	F2				
						SSA042	F2				
						SSA042	F2				
						SSA042	F2				
						SSA042	F2				
						SSA042	F2			BAE608I	
						SSA042	F2				
						SSA042	F2				
										ESS532	J1
						SPA103	F1				
							SAG021	H1			
							SAG021-1	H1			
							SAC032	H2		ESS532	J1
										BAE680BK	
							SAG021	H1			
							SAG021-1	H1			
							SAG055	H1			



KW



TYPE



TYPE

VAUXHALL

OMEGA (B)

2.6 V6	Petrol	132	09/00 → 07/03						
2.6 V6	Petrol	132	08/00 → 07/03						
3.2 V6	Petrol	160	02/01 → 07/03	ENGINE: → 08149313					
3.2 V6	Petrol	160	02/01 → 07/03						

OMEGA (B) Station wagon

2.0 DTI 16V	Diesel	74	01/98 → 08/00						
2.0 DTI 16V	Diesel	74	01/98 → 09/00						
2.0 DTI 16V	Diesel	74	01/98 → 09/00						
2.2 16V	Petrol	106	02/94 → 06/03						
2.2 16V	Petrol	106	09/99 → 06/03						
2.2 16V	Petrol	106	02/94 → 06/03	ENGINE: Y22XE					
2.2 16V	Petrol	106	08/00 → 06/03	ENGINE: Z22XE					
2.2 DTI 16V	Diesel	88	08/00 → 06/03						
2.2 DTI 16V	Diesel	88	08/00 → 06/03						
2.6 V6	Petrol	132	08/00 → 06/03	ENGINE: → 08149313					
2.6 V6	Petrol	132	09/00 → 06/03						
2.6 V6	Petrol	132	08/00 → 06/03						
3.2 V6	Petrol	160	02/01 → 06/03	ENGINE: → 08149313					
3.2 V6	Petrol	160	02/01 → 06/03						

ROYALE

3.0	Petrol	132	10/79 → 10/82						
-----	--------	-----	---------------	--	--	--	--	--	--

SENATOR Mk II (B)

2.5 i	Petrol	103	09/87 → 10/90						
2.5 i	Petrol	103	09/87 → 10/90	CHASSIS: 0053436 →					
2.6 i	Petrol	110	09/90 → 09/93						
3.0	Petrol	115	09/87 → 09/93						
3.0	Petrol	130	01/88 → 09/90						
3.0	Petrol	130	01/88 → 09/90	CHASSIS: 0109242 →					
3.0 24V	Petrol	150	09/89 → 09/93						
3.0 24V	Petrol	150	09/89 → 09/93						
3.0 i Cat.	Petrol	130	01/88 → 09/93						
3.0 i Cat.	Petrol	130	01/88 → 09/93	CHASSIS: 0011335 →					

SIGNUM

1.8	Petrol	103	08/05 → 05/08						
1.8	Petrol	90	06/03 → 07/05						
1.9 CDTI	Diesel	88	04/04 → 03/08						
1.9 CDTI 16V	Diesel	110	04/04 → 03/08						
1.9 CDTI 16V	Diesel	110	04/04 → 03/08						
2.0 DTI	Diesel	74	05/03 → 05/08	ENGINE: → 17G23740					
2.0 DTI	Diesel	74	05/03 → 05/08	ENGINE: → 17G23740					
2.0 DTI	Diesel	74	05/03 → 09/05	ENGINE: 17G23741 →					
2.2 DTI	Diesel	92	05/03 → 05/08						
2.2 DTI	Diesel	92	05/03 → 05/08	ENGINE: → 17G23740					
2.2 DTI	Diesel	92	05/03 → 05/08	ENGINE: → 17G23740					



KW

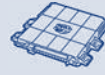

TYPE



TYPE

VAUXHALL

SIGNUM

2.2 i	Petrol	114	05/03 → 05/08					TB0014	B3
2.2 i	Petrol	114	05/03 → 05/08						
2.8 V6 Turbo	Petrol	169	04/02 → 05/08						
2.8 V6 Turbo	Petrol	169	08/05 → 09/07						
3.2 V6	Petrol	155	05/03 → 09/05						

SINTRA

2.2 DTI	Diesel	85	07/97 → 04/99						
2.2 DTI	Diesel	85	07/97 → 04/99						
2.2 i 16 V	Petrol	104	11/96 → 04/99					SVF015	B6
2.2 i 16 V	Petrol	104	11/96 → 04/99						
3.0 i 24V	Petrol	148	11/96 → 04/99					SVF015	B6
3.0 i 24V	Petrol	148	11/96 → 04/99						

TIGRA Mk I (F07)

1.4 16V	Petrol	66	07/94 → 12/00					B3215	B1
1.4 16V	Petrol	66	07/94 → 12/00					SVF013	B6
1.4 16V	Petrol	66	07/94 → 12/00	CHASSIS: → V6999999					
1.4 16V	Petrol	66	07/94 → 12/00	CHASSIS: S3000001 →					
1.4 16V	Petrol	66	07/94 → 12/00	ENGINE: X14XE					
1.4 16V	Petrol	66	08/94 → 08/99						
1.6 16V	Petrol	78	07/94 → 12/00					B3215	B1
1.6 16V	Petrol	78	07/94 → 12/00					SVF013	B6
1.6 16V	Petrol	78	07/94 → 12/00	CHASSIS: → V6999999					
1.6 16V	Petrol	78	07/94 → 12/00	CHASSIS: S3000001 →					
1.6 16V	Petrol	78	07/94 → 12/00	ENGINE: X16XE					
1.6 16V	Petrol	78	08/94 → 08/99						

TIGRA TwinTop

1.3 CDTI	Diesel	51	06/04 → 08/09						
1.3 CDTI	Diesel	51	06/04 → 08/09						
1.4	Petrol	66	06/04 → 08/09						
1.4	Petrol	66	06/04 → 08/09						
1.4	Petrol	66	09/04 → 08/09						
1.8	Petrol	92	06/04 → 08/09						
1.8	Petrol	92	06/04 → 08/09						

VECTRA (B)

1.6 i	Petrol	55	08/95 → 10/01					SVF014	B6
1.6 i	Petrol	55	09/95 → 10/01	ENGINE: X16SZR-X16XEL					
1.6 i	Petrol	55	09/95 → 10/01	ENGINE: X16XEL-Y16XE-Z16XE					
1.6 i 16V	Petrol	74	08/95 → 10/01					SVF013	B6
1.6 i 16V	Petrol	74	09/95 → 10/01					B3215	B1
1.6 i 16V	Petrol	74	08/95 → 10/01						
1.6 i 16V	Petrol	74	11/95 → 10/01	CHASSIS: W1285447 →, W7154259 →					
1.6 i 16V	Petrol	74	08/95 → 08/00	ENGINE: X16XEL-Y16XE					



TYPE



TYPE



TYPE

						SAD015	H3	BAE680BM		
						SAG083	H1			
			ATS10	F2						
								BAE680CF		
								BAE680CH		
			SSA042	F2		SAG021	H1			
						SAG021-1	H1			
			SPA103	F1		SAC035	H2			
			SSA042	F2						
			SPA103	F1						
			SSA042	F2						
						SAC082	H2			
			SPA104	F1						
						SAG124	H1			
								BAE608I		
									ESS532	J1
						SAC082	H2			
			SPA104	F1						
						SAG124	H1			
								BAE608I		
									ESS532	J1
	APS23					SAC093	H2		ESS0070A	J1
						SAG025	H1			
			SPA103	F1	SAA103	SAC092	H2	BAE680AL		
						SAD026	H3			
						SAG019	H1			
						SAC071	H2			
						SAG120	H1			
			SSA042	F2		SAG141	H1			
								BAE608I		
								BAE608F		
			SSA042	F2		SAC080	H2			
								BAE608H		
						SAG020	H1			
						SAG116	H1			
									ESS532	J1



KW



TYPE



TYPE

VAUXHALL

VECTRA (B)

1.8 i 16V	Petrol	85	10/95 → 09/00					B3397	B1
1.8 i 16V	Petrol	85	10/95 → 08/99					SVF015	B6
1.8 i 16V	Petrol	85	10/95 → 09/00	ENGINE: → 25037067					
1.8 i 16V	Petrol	92	09/00 → 03/02						
1.8 i 16V	Petrol	92	09/00 → 03/02						
1.8 i 16V	Petrol	85	10/95 → 08/99	ENGINE: X18XE					
2.0 DI 16V	Diesel	60	08/95 → 07/00						
2.0 DI 16V	Diesel	60	08/95 → 10/01						
2.0 DI 16V	Diesel	60	08/95 → 10/01						
2.0 DTI 16V	Diesel	74	08/95 → 10/01						
2.0 DTI 16V	Diesel	74	09/97 → 08/01						
2.0 DTI 16V	Diesel	74	08/95 → 10/01						
2.0 i 16V	Petrol	100	10/95 → 01/01					B3397	B1
2.0 i 16V	Petrol	100	10/95 → 01/01					SVF015	B6
2.2 DTI 16V	Diesel	92	08/95 → 10/01						
2.2 DTI 16V	Diesel	92	08/95 → 08/01						
2.2 DTI 16V	Diesel	92	08/95 → 10/01						
2.2 i 16V	Petrol	108	08/95 → 10/01					B3397	B1
2.2 i 16V	Petrol	108	08/95 → 10/01	ENGINE: → 25037067					
2.2 i 16V	Petrol	108	08/00 → 10/01	ENGINE: Z22SE					
2.5 i GSi	Petrol	143	03/98 → 07/00	CHASSIS: → V7999999				SVF015	B6
2.5 i GSi	Petrol	143	03/98 → 07/00						
2.5 i V6	Petrol	125	09/95 → 08/00	CHASSIS: → V7999999				SVF015	B6
2.5 i V6	Petrol	125	09/95 → 08/00						
2.6 i V6	Petrol	125	09/00 → 08/01						

VECTRA (B) 2 volumi /Coda spiovente

1.6 i	Petrol	55	08/95 → 10/01					SVF014	B6
1.6 i	Petrol	55	09/95 → 10/01	ENGINE: X16SZR-X16XEL					
1.6 i	Petrol	55	09/95 → 10/01	ENGINE: X16XEL-Y16XE-Z16XE					
1.6 i 16V	Petrol	74	08/95 → 10/01					SVF013	B6
1.6 i 16V	Petrol	74	09/95 → 10/01					B3215	B1
1.6 i 16V	Petrol	74	08/95 → 10/01						
1.6 i 16V	Petrol	74	11/95 → 10/01	CHASSIS: W1285447 →, W7154259 →					
1.6 i 16V	Petrol	74	08/95 → 08/00	ENGINE: X16XEL-Y16XE					
1.8 i 16V	Petrol	85	10/95 → 09/00					B3397	B1
1.8 i 16V	Petrol	85	10/95 → 08/99					SVF015	B6
1.8 i 16V	Petrol	85	10/95 → 09/00	ENGINE: → 25037067					
1.8 i 16V	Petrol	92	09/00 → 07/03						
1.8 i 16V	Petrol	92	09/00 → 07/03						
1.8 i 16V	Petrol	85	10/95 → 08/99	ENGINE: X18XE					
2.0 DI 16V	Diesel	60	08/95 → 07/00						
2.0 DI 16V	Diesel	60	08/95 → 10/01						

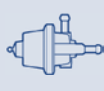

TYPE

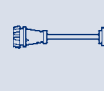

TYPE



TYPE

			SSA042	F2		SAG107	H1		
						SAC061	H2		
						SAC071	H2		
						SAG120	H1		
								ESS532	J1
			SPA103	F1		SAG021	H1		
						SAG021-1	H1		
	APS26					SAG021	H1		
			SPA103	F1					
						SAG021-1	H1		
						SAC046	H2	ESS532	J1
						SAG107	H1		
	APS26					SAG021	H1		
			SPA103	F1					
						SAG021-1	H1		
						SAG083	H1		
						SAC061	H2		
								BAE608N	
						SAC025	H2	ESS532	J1
						SAC025	H2	ESS532	J1
			SPA103	F1				BAE680BJ	
			SSA042	F2		SAG141	H1		
								BAE608I	
								BAE608F	
			SSA042	F2		SAC080	H2		
								BAE608H	
						SAG020	H1		
						SAG116	H1		
								ESS532	J1
						SAG107	H1		
						SAC061	H2		
						SAC071	H2		
						SAG120	H1		
								ESS532	J1
			SPA103	F1					
						SAG021	H1		



KW

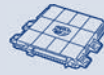

TYPE



TYPE

VAUXHALL

VECTRA (B) 2 volumi /Coda spiovente

2.0 DI 16V	Diesel	60	08/95 → 10/01					
2.0 DTI 16V	Diesel	74	06/97 → 10/01					
2.0 DTI 16V	Diesel	74	09/97 → 08/01					
2.0 DTI 16V	Diesel	74	06/97 → 10/01					
2.0 i 16V	Petrol	100	10/95 → 01/01			B3397	B1	
2.0 i 16V	Petrol	100	10/95 → 01/01			SVF015	B6	
2.2 DTI 16V	Diesel	92	08/95 → 10/01					
2.2 DTI 16V	Diesel	92	08/95 → 08/01					
2.2 DTI 16V	Diesel	92	08/95 → 10/01					
2.2 i 16V	Petrol	108	09/00 → 07/03					
2.2 i 16V	Petrol	108	09/00 → 07/03	ENGINE: → 25037067				
2.2 i 16V	Petrol	108	09/00 → 07/03	ENGINE: Z22SE				
2.5 i GSi	Petrol	143	03/98 → 07/00	CHASSIS: → V7999999		SVF015	B6	
2.5 i GSi	Petrol	143	03/98 → 07/00					
2.5 i V6	Petrol	125	09/95 → 08/00	CHASSIS: → V7999999		SVF015	B6	
2.5 i V6	Petrol	125	09/95 → 08/00	CHASSIS: S1035179 →				
2.5 i V6	Petrol	125	09/95 → 08/00					
2.6 i V6	Petrol	125	09/00 → 08/01					

VECTRA (B) Station wagon

1.6 i	Petrol	55	11/96 → 03/02			SVF014	B6	
1.6 i	Petrol	55	11/96 → 03/02	ENGINE: X16SZR-X16XEL				
1.6 i	Petrol	55	11/96 → 03/02	ENGINE: X16XEL-Y16XE				
1.6 i 16V	Petrol	74	11/96 → 03/02			B3215	B1	
1.6 i 16V	Petrol	74	11/96 → 03/02			SVF013	B6	
1.6 i 16V	Petrol	74	11/96 → 08/00	ENGINE: X16XEL-Y16XE				
1.8 i 16V	Petrol	85	11/96 → 09/00			B3397	B1	
1.8 i 16V	Petrol	85	11/96 → 08/99			SVF015	B6	
1.8 i 16V	Petrol	85	11/96 → 09/00	ENGINE: → 25037067				
1.8 i 16V	Petrol	92	09/00 → 03/02					
1.8 i 16V	Petrol	92	09/00 → 03/02					
1.8 i 16V	Petrol	85	11/96 → 08/99	ENGINE: X18XE				
2.0 DI 16V	Diesel	60	08/95 → 07/00					
2.0 DI 16V	Diesel	60	08/95 → 10/01					
2.0 DI 16V	Diesel	60	08/95 → 10/01					
2.0 DTI 16V	Diesel	74	08/95 → 10/01					
2.0 DTI 16V	Diesel	74	09/97 → 08/00					
2.0 DTI 16V	Diesel	74	08/95 → 10/01					
2.0 i 16V	Petrol	100	10/95 → 01/01			B3397	B1	
2.0 i 16V	Petrol	100	10/95 → 01/01			SVF015	B6	
2.2 DTI 16V	Diesel	92	08/95 → 10/01					
2.2 DTI 16V	Diesel	92	08/95 → 08/01					
2.2 DTI 16V	Diesel	92	08/95 → 10/01					
2.2 i 16V	Petrol	108	08/95 → 10/01					
2.2 i 16V	Petrol	108	08/00 → 10/01	ENGINE: Z22SE				

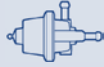

TYPE



TYPE



TYPE

						SAG021-1	H1			
	APS26					SAG021	H1			
			SPA103	F1						
						SAG021-1	H1			
						SAC046	H2		ESS532	J1
						SAG107	H1			
	APS26					SAG021	H1			
			SPA103	F1						
						SAG021-1	H1			
						SAG083	H1			
						SAC061	H2			
								BAE608N		
						SAC025	H2		ESS532	J1
						SAC025	H2			
									ESS532	J1
			SPA103	F1				BAE680BJ		
			SSA042	F2		SAG141	H1			
								BAE608I		
								BAE608F		
			SSA042	F2		SAC080	H2	BAE608H		
						SAG020	H1			
									ESS532	J1
						SAG107	H1			
						SAC061	H2			
						SAC071	H2			
						SAG120	H1			
									ESS532	J1
			SPA103	F1						
						SAG021	H1			
						SAG021-1	H1			
	APS26					SAG021	H1			
			SPA103	F1						
						SAG021-1	H1			
						SAC046	H2		ESS532	J1
						SAG107	H1			
	APS26					SAG021	H1			
			SPA103	F1						
						SAG021-1	H1			
						SAG083	H1			
								BAE608N		



KW



TYPE



TYPE

VAUXHALL

VECTRA (B) Station wagon

2.5 i GSi	Petrol	143	05/98 → 09/99	CHASSIS: → V7999999			SVF015	B6
2.5 i GSi	Petrol	143	05/98 → 09/99					
2.5 i V6	Petrol	125	11/96 → 08/00	CHASSIS: → V7999999			SVF015	B6
2.5 i V6	Petrol	125	11/96 → 08/00					
2.6 i V6	Petrol	125	09/00 → 08/01					

VECTRA Mk II (C)

1.6	Petrol	77	01/06 → 07/08					
1.6 16V	Petrol	74	06/04 → 07/08					
1.6 16V	Petrol	74	06/04 → 07/08					
1.8	Petrol	103	01/06 → 07/08					
1.8	Petrol	81	04/02 → 07/08					
1.8 16V	Petrol	90	04/02 → 07/08					
1.8 16V	Petrol	90	04/02 → 07/08					
1.8 16V Dualfuel	Petrol/LPG	90	04/02 → 07/08					
1.9 CDTI	Diesel	88	04/02 → 09/08					
1.9 CDTI 16V	Diesel	110	04/04 → 08/08					
1.9 CDTI 16V	Diesel	110	04/04 → 08/08					
2.0 DTI 16V	Diesel	74	04/02 → 10/08	ENGINE: → 17G23740				
2.0 DTI 16V	Diesel	74	04/02 → 10/08	ENGINE: → 17G23740				
2.0 DTI 16V	Diesel	74	04/02 → 09/05	ENGINE: 17G23741 →				
2.2 16V	Petrol	108	01/02 → 10/08					
2.2 16V	Petrol	108	03/02 → 10/08	ENGINE: Z22SE				
2.2 direct	Petrol	114	01/02 → 10/08					
2.2 direct	Petrol	114	01/02 → 10/08					
2.2 direct	Petrol	114	09/03 → 10/08					
2.2 direct	Petrol	114	09/03 → 10/08	ENGINE: Z22SE				
2.2 DTI 16V	Diesel	92	04/02 → 10/08					
2.2 DTI 16V	Diesel	92	04/02 → 10/08	ENGINE: → 17G23740				
2.2 DTI 16V	Diesel	92	04/02 → 10/08	ENGINE: → 17G23740				
2.2 DTI 16V	Diesel	92	04/02 → 09/05	ENGINE: 17G23741 →				
2.8 V6 Turbo	Petrol	169	09/05 → 09/07					
2.8 V6 Turbo	Petrol	184	08/06 → 07/08					
2.8 V6 Turbo	Petrol	188	09/05 → 07/08					
2.8 V6 Turbo	Petrol	206	10/06 → 08/08					
3.2 V6	Petrol	155	06/03 → 09/05					

VECTRA Mk II (C) GTS

1.6	Petrol	77	01/06 → 07/08					
1.6 16V	Petrol	74	06/04 → 07/08					
1.6 16V	Petrol	74	08/05 → 07/08					
1.8	Petrol	103	01/06 → 07/08					
1.8 16V	Petrol	90	08/02 → 07/08					
1.8 16V	Petrol	90	08/02 → 07/08					
1.8 16V Dualfuel	BiFuel	90	08/02 → 07/08					
1.9 CDTI	Diesel	88	08/02 → 07/08					



TYPE



TYPE



TYPE

							SAC025	H2		ESS532	J1
							SAC025	H2		ESS532	J1
				SPA103	F1					BAE680BJ	
						SAA103	SAG020	H1			
							SAC080	H2			
							SAG020	H1			
						SAA103					
							SAG120	H1			
							SAC071	H2			
							SAG120	H1			
							SAC071	H2			
				ATS20	F2		SAC088	H2			
				ATS20	F2		SAC068	H2			
							SAG133	H1			
							SAG021	H1			
							SAG021-1	H1			
							SAG069	H1			
							SAG083	H1			
										BAE608N	
							SAD015	H3			
							SAG083	H1			
										BAE680BM	
										BAE608N	
				ATS20	F2						
							SAG021	H1			
							SAG021-1	H1			
							SAG069	H1			
										BAE680CF	
										BAE680CF	
										BAE680CF	
										BAE680CF	
										BAE680CH	
						SAA103	SAG020	H1			
							SAC080	H2			
							SAG020	H1			
						SAA103					
							SAC071	H2			
							SAG120	H1			
							SAC071	H2			
				ATS20	F2		SAC088	H2			



KW

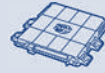

TYPE



TYPE

VAUXHALL

VECTRA Mk II (C) GTS

1.9 CDTI 16V	Diesel	110	04/04 → 07/08						
1.9 CDTI 16V	Diesel	110	04/04 → 07/08						
2.0 DTI 16V	Diesel	74	08/02 → 07/08	ENGINE: → 17G23740					
2.0 DTI 16V	Diesel	74	08/02 → 07/08	ENGINE: → 17G23740					
2.0 DTI 16V	Diesel	74	08/02 → 09/05	ENGINE: 17G23741 →					
2.2 16V	Petrol	108	08/02 → 07/08						
2.2 16V	Petrol	108	08/02 → 07/08	ENGINE: Z22SE					
2.2 direct	Petrol	114	10/03 → 08/05						
2.2 direct	Petrol	114	10/03 → 08/05						
2.2 direct	Petrol	114	10/03 → 08/05	ENGINE: Z22SE					
2.2 DTI 16V	Diesel	92	08/02 → 07/08						
2.2 DTI 16V	Diesel	92	08/02 → 07/08	ENGINE: → 17G23740					
2.2 DTI 16V	Diesel	92	08/02 → 07/08	ENGINE: → 17G23740					
2.2 DTI 16V	Diesel	92	08/02 → 09/05	ENGINE: 17G23741 →					
2.8 V6 Turbo	Petrol	169	09/05 → 09/07						
2.8 V6 Turbo	Petrol	184	08/06 → 07/08						
2.8 V6 Turbo	Petrol	188	09/05 → 07/08						
3.2 V6	Petrol	155	08/02 → 09/05						

VECTRA Mk II (C) Station wagon

1.6 16V	Petrol	74	06/04 → 07/08						
1.6 16V	Petrol	74	06/04 → 07/08						
1.8	Petrol	103	01/06 → 07/08						
1.8 16V	Petrol	90	10/03 → 08/05						
1.8 16V	Petrol	90	10/03 → 08/05						
1.9 CDTI	Diesel	88	04/04 → 07/08						
1.9 CDTI 16V	Diesel	110	04/04 → 07/08						
1.9 CDTI 16V	Diesel	110	04/04 → 07/08						
2.0 DTI 16V	Diesel	74	10/03 → 07/08	ENGINE: → 17G23740					
2.0 DTI 16V	Diesel	74	10/03 → 07/08	ENGINE: → 17G23740					
2.0 DTI 16V	Diesel	74	10/03 → 09/05	ENGINE: 17G23741 →					
2.2 direct	Petrol	114	10/03 → 07/08						
2.2 direct	Petrol	114	10/03 → 07/08						
2.2 direct	Petrol	114	10/03 → 07/08	ENGINE: Z22SE					
2.2 DTI 16V	Diesel	92	10/03 → 07/08						
2.2 DTI 16V	Diesel	92	10/03 → 07/08	ENGINE: → 17G23740					
2.2 DTI 16V	Diesel	92	10/03 → 07/08	ENGINE: → 17G23740					
2.2 DTI 16V	Diesel	92	10/03 → 09/05	ENGINE: 17G23741 →					
2.8 V6 Turbo	Petrol	169	09/05 → 09/07						
2.8 V6 Turbo	Petrol	188	08/06 → 07/08						
2.8 V6 Turbo	Petrol	206	01/07 → 07/08						
3.2 V6	Petrol	155	10/03 → 08/05						



TYPE



TYPE



TYPE

				ATS20	F2		SAC068	H2		
							SAG133	H1		
							SAG021	H1		
							SAG021-1	H1		
							SAG069	H1		
							SAG083	H1		
									BAE608N	
							SAD015	H3	BAE680BM	
							SAG083	H1		
									BAE608N	
				ATS20	F2					
							SAG021	H1		
							SAG021-1	H1		
							SAG069	H1		
									BAE680CF	
									BAE680CF	
									BAE680CF	
									BAE680CH	
							SAC080	H2		
							SAG020	H1		
						SAA103				
							SAC071	H2		
							SAG120	H1		
				ATS20	F2		SAC088	H2		
				ATS20	F2		SAC068	H2		
							SAG133	H1		
							SAG021	H1		
							SAG021-1	H1		
							SAG069	H1		
							SAD015	H3	BAE680BM	
							SAG083	H1		
									BAE608N	
				ATS20	F2					
							SAG021	H1		
							SAG021-1	H1		
							SAG069	H1		
									BAE680CF	
									BAE680CF	
									BAE680CF	
				SPA103	F1				BAE680CH	



KW



TYPE



TYPE

VAUXHALL

VIVARO Combi (J7)

2.0 16V	Petrol	88	08/01 → 12/06					
2.0 ECOTEC	Petrol	86	08/06 → 07/14					

VIVARO Furgonato (F7)

2.0 16V	Petrol	88	03/02 → 12/06					
2.0 16V	Petrol	88	08/01 → 12/06					
2.0 ECOTEC	Petrol	86	08/06 → 07/14					

VIVARO Pianale piatto/Telaio (E7)

2.0 16V	Petrol	88	04/03 → 07/06					
2.0 ECOTEC	Petrol	86	08/06 → 07/14					

VX220

2.0 i Turbo	Petrol	147	03/01 → 07/05					
2.0 i Turbo	Petrol	147	03/01 → 07/05					
2.0 i Turbo	Petrol	147	04/03 → 07/05					
2.2 i	Petrol	108	09/00 → 07/05					

ZAFIRA Mk I (A) (F75)

1.6 16V	Petrol	74	04/99 → 08/05					B3215	B1
1.6 16V	Petrol	74	04/99 → 08/05					SVF013	B6
1.6 16V	Petrol	74	04/99 → 08/99						
1.6 16V	Petrol	74	04/99 → 08/05	ENGINE: X16XEL-Z16XE					
1.6 16V	Petrol	74	04/99 → 08/99						
1.6 CNG	Petrol/CNG	71	09/01 → 06/05						
1.8 16V	Petrol	85	05/99 → 08/00						
1.8 16V	Petrol	85	05/99 → 08/00						
1.8 16V	Petrol	92	09/00 → 08/05						
1.8 16V	Petrol	92	09/00 → 08/05						
1.8 16V	Petrol	92	09/00 → 06/05						
2.0	Petrol	147	06/02 → 06/05						
2.0 DI 16V	Diesel	60	10/99 → 08/05					PAS004	B5
2.0 DI 16V	Diesel	60	10/99 → 08/00						
2.0 DI 16V	Diesel	60	10/99 → 08/05	CHASSIS: → 38999999					
2.0 DI 16V	Diesel	60	10/99 → 08/05	CHASSIS: → 38999999					
2.0 DTI 16V	Diesel	74	04/99 → 08/05					PAS004	B5
2.0 DTI 16V	Diesel	74	04/99 → 06/05						
2.0 DTI 16V	Diesel	74	04/99 → 08/05	CHASSIS: → 38999999					
2.0 DTI 16V	Diesel	74	04/99 → 08/05	CHASSIS: → 38999999					
2.0 GSI Turbo	Petrol	141	09/01 → 06/05						
2.0 GSI Turbo	Petrol	141	09/01 → 05/05						
2.0 GSI Turbo	Petrol	141	09/01 → 06/05						
2.2 16V	Petrol	108	11/98 → 08/04						
2.2 16V	Petrol	108	08/00 → 08/04	ENGINE: Z22SE					



TYPE

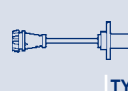

TYPE



TYPE

				SPA108	F1					BAE680E		
				SPA108	F1							
				SPA108	F1							
				SPA108	F1					BAE680E		
				SPA108	F1							
				SPA108	F1							
				ATS10	F2		SAC035	H2				
				SPA103	F1		SAG057	H1				
										BAE680BL		
							SAG083	H1				
							SAC080	H2		BAE608H		
							SAG020	H1				
				SPA103	F1							
										BAE608F		
											ESS532	J1
							SAG020	H1				
							SAC071	H2			ESS532	J1
							SAG116	H1				
							SAC071	H2				
							SAG120	H1				
											ESS532	J1
										BAE680BL		
				SPA103	F1							
							SAG021	H1				
							SAG021-1	H1				
				SPA103	F1							
							SAG021	H1				
							SAG021-1	H1				
				ATS10	F2		SAC035	H2		BAE680BL		
				SPA103	F1							
							SAG057	H1				
							SAG083	H1				
										BAE608N		



KW



TYPE



TYPE

VAUXHALL

ZAFIRA Mk II (B) (M75)

1.6	Petrol	77	07/05 →						
1.6	Petrol	85	12/07 →						
1.6	Petrol	77	07/05 →	ENGINE: Z16XEP					
1.6 CNG Turbo	Petrol/CNG	110	02/09 → 06/10						
1.8	Petrol	103	04/05 →						
1.8	Petrol	103	04/05 →	ENGINE: Z18XER					
1.9 CDTI	Diesel	88	07/05 →						
1.9 CDTI	Diesel	110	07/05 →						
1.9 CDTI	Diesel	110	07/05 →						
2.0	Petrol	147	07/05 →						
2.0	Petrol	147	07/05 →						
2.0	Petrol	176	01/06 →						
2.0	Petrol	176	01/06 →						
2.2	Petrol	110	07/05 →				TB0014		B3
2.2	Petrol	110	07/05 →						

ZAFIRA Mk III (P12)

1.4	Petrol	103	10/11 →						
1.4	Petrol	88	10/11 →						
1.6 CNG	Petrol/CNG	110	10/11 →						
1.8	Petrol	103	10/11 →						
1.8	Petrol	85	10/11 →						
1.8	Petrol	88	10/11 →						

VOLKSWAGEN

AMAROK (2H_, S1B)

2.0 BitDI	Diesel	120	09/10 →						
2.0 BitDI 4motion	Diesel	120	09/10 →						
2.0 TDi	Diesel	90	09/10 →						
2.0 TDI 4motion	Diesel	132	11/11 →						
2.0 TDI 4motion	Diesel	90	09/10 →						
2.0 TSI	Petrol	118	12/10 →						

BEETLE (5C1)

1.2 TSI	Petrol	77	07/11 →						
1.4 TSI	Petrol	118	04/11 →						
1.4 TSI	Petrol	118	10/11 →						
1.6 TDI	Diesel	77	10/11 →						
2.0 TDi	Diesel	103	04/11 →						
2.0 TSI	Petrol	147	04/11 →						

BORA (1J2)

1.4 16V	Petrol	55	03/00 → 05/05	ENGINE: APE,AHW,AKQ,AXP,BCA					
1.4 16V	Petrol	55	03/00 → 05/05						
1.4 16V	Petrol	55	03/00 → 05/05						
1.4 16V	Petrol	55	03/00 → 05/05						

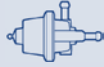

TYPE



TYPE



TYPE

					SAA103	SAG020	H1			
					SAA103					
									BAE608L	
					SAA103					
					SAA103					
									BAE608L	
			ATS20	F2		SAC088	H2		GA2188	J2
						SAC068	H2		GA2188	J2
						SAG133	H1			
						SAC035	H2	BAE680BL		
						SAG057	H1			
						SAC035	H2	BAE680BL		
						SAG057	H1			
						SAD015	H3	BAE680BM		
						SAG083	H1			
					SAA103					
					SAA103					
					SAA103					
					SAA103			BAE680CS		
					SAA103			BAE680CS		
					SAA103			BAE680CS		
			SPA111	F1	SAA105					
			SPA111	F1	SAA105					
			SPA111	F1	SAA105					
			SPA111	F1	SAA105					
			SPA111	F1	SAA105					
			SPA111	F1					BAE680BB	
						SAC011	H2			
			SPA111	F1						
						SAC011	H2			
			SPA111	F1	SAA105					
			SPA111	F1						
			SPA111	F1					BAE680BB	
IWP092										
			ATS23	F2	SAA105	SAC014	H2	BAE680AA	ESS0045A	J1
			SPA109	F1		SAD028	H3		GA2226	J2
						SAG178	H1			



KW



TYPE



TYPE

VOLKSWAGEN

BORA (1J2)

1.6	Petrol	74	10/98 → 05/00				AMM19670	B4
1.6	Petrol	75	08/00 → 05/05				AMM19670	B4
1.6	Petrol	74	10/98 → 05/05					
1.6	Petrol	74	10/98 → 05/05					
1.6	Petrol	75	08/00 → 05/05					
1.6	Petrol	75	08/00 → 05/05					
1.6	Petrol	74	10/98 → 05/05					
1.6 16V	Petrol	77	05/00 → 05/05					
1.6 16V	Petrol	77	05/00 → 05/05					
1.6 FSI	Petrol	81	01/02 → 05/05					
1.6 FSI	Petrol	81	01/02 → 05/05					
1.8	Petrol	92	10/98 → 05/05					
1.8	Petrol	92	10/98 → 05/05					
1.8	Petrol	92	02/99 → 05/05					
1.8 4motion	Petrol	92	02/99 → 05/05					
1.8 4motion	Petrol	92	02/99 → 05/05					
1.8 T	Petrol	110	05/00 → 03/03					
1.8 T	Petrol	110	04/03 → 05/05					
1.8 T	Petrol	132	03/02 → 03/03					
1.8 T	Petrol	132	04/03 → 05/03					
1.8 T	Petrol	110	05/00 → 05/05					
1.8 T	Petrol	110	05/00 → 05/05					
1.8 T	Petrol	110	05/00 → 09/02					
1.8 T	Petrol	132	03/02 → 05/05					
1.8 T	Petrol	132	03/02 → 05/05					
1.8 T	Petrol	132	05/02 → 09/02					
1.8 T	Petrol	132	03/02 → 05/03					
1.9 SDI	Diesel	50	10/98 → 05/05					
1.9 SDI	Diesel	50	05/99 → 05/05	CHASSIS: 1JY000001 →				
1.9 SDI	Diesel	50	11/98 → 05/05					
1.9 TDI	Diesel	110	05/00 → 05/05				AMM19752	B4
1.9 TDI	Diesel	96	11/00 → 05/05				AMM19752	B4
1.9 TDI	Diesel	66	10/98 → 06/01					
1.9 TDI	Diesel	74	09/00 → 03/03					
1.9 TDI	Diesel	74	04/03 → 05/05					
1.9 TDI	Diesel	81	10/98 → 06/01					
1.9 TDI	Diesel	85	12/98 → 01/02					
1.9 TDI	Diesel	96	11/00 → 05/05					
1.9 TDI	Diesel	110	09/00 → 05/05					
1.9 TDI	Diesel	66	10/98 → 06/01					
1.9 TDI	Diesel	66	05/99 → 06/01	CHASSIS: 1JY000001 →				
1.9 TDI	Diesel	74	09/00 → 05/05					
1.9 TDI	Diesel	74	09/00 → 05/05					
1.9 TDI	Diesel	81	10/98 → 06/01					



KW



TYPE



TYPE

VOLKSWAGEN

BORA (1J2)

1.9 TDI	Diesel	85	12/98 → 01/02						
1.9 TDI	Diesel	96	04/01 → 05/05						
1.9 TDI 4motion	Diesel	110	05/00 → 05/05				AMM19752	B4	
1.9 TDI 4motion	Diesel	96	11/00 → 05/05				AMM19752	B4	
1.9 TDI 4motion	Diesel	66	02/99 → 06/01						
1.9 TDI 4motion	Diesel	74	09/00 → 03/03						
1.9 TDI 4motion	Diesel	74	04/03 → 05/05						
1.9 TDI 4motion	Diesel	85	02/99 → 06/01						
1.9 TDI 4motion	Diesel	96	11/00 → 05/05						
1.9 TDI 4motion	Diesel	110	09/00 → 05/05						
1.9 TDI 4motion	Diesel	66	02/99 → 06/01						
1.9 TDI 4motion	Diesel	66	05/99 → 06/01	CHASSIS: 1JY000001 →					
1.9 TDI 4motion	Diesel	74	09/00 → 05/05						
1.9 TDI 4motion	Diesel	74	09/00 → 05/05						
1.9 TDI 4motion	Diesel	74	05/01 → 05/05						
1.9 TDI 4motion	Diesel	85	02/99 → 06/01						
1.9 TDI 4motion	Diesel	96	04/01 → 05/05						
2.0	Petrol	85	10/98 → 05/05						
2.0	Petrol	85	10/98 → 05/05						
2.0	Petrol	85	10/98 → 05/05						
2.0	Petrol	85	10/98 → 05/05						
2.0	Petrol	85	10/98 → 05/05						
2.0 4motion	Petrol	85	04/00 → 05/05						
2.0 4motion	Petrol	85	04/00 → 05/05						
2.0 4motion	Petrol	85	04/00 → 12/02						
2.3 V5	Petrol	110	10/98 → 10/00						
2.3 V5	Petrol	110	10/98 → 10/00	CHASSIS: 1JY000001 →					
2.3 V5	Petrol	125	10/00 → 05/05						
2.3 V5	Petrol	125	10/00 → 05/05	CHASSIS: 1JY000001 →					
2.3 V5	Petrol	110	10/98 → 10/00						
2.3 V5	Petrol	125	10/00 → 05/05						
2.3 V5	Petrol	125	10/00 → 05/05						
2.3 V5 4motion	Petrol	110	12/98 → 10/00						
2.3 V5 4motion	Petrol	110	12/98 → 10/00	CHASSIS: 1JY000001 →					
2.3 V5 4motion	Petrol	125	10/00 → 05/05						
2.3 V5 4motion	Petrol	125	10/00 → 05/05	CHASSIS: 1JY000001 →					
2.3 V5 4motion	Petrol	110	12/98 → 10/00						
2.3 V5 4motion	Petrol	125	10/00 → 05/05						
2.3 V5 4motion	Petrol	125	10/00 → 05/05						
2.8 V6 4motion	Petrol	150	03/99 → 05/05						
2.8 V6 4motion	Petrol	150	03/99 → 05/05	CHASSIS: 1JY000001 →					
2.8 V6 4motion	Petrol	150	05/99 → 05/05						
2.8 V6 4motion	Petrol	150	03/99 → 05/05						
2.8 V6 4motion	Petrol	150	03/99 → 05/05						

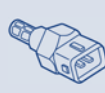

TYPE

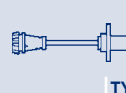

TYPE



TYPE

				SPA109	F1						
				SPA111	F1						
				ATS23	F2		SAG015	H2		ESS0073A	J1
		APS39		ATS23	F2		SAG015	H2		ESS0073A	J1
		APS39		ATS23	F2		SAG178	H1		ESS0073A	J1
		APS39									
		APS40									
		APS39		ATS23	F2		SAG015	H2		ESS0073A	J1
				SPA109	F1						
				SPA109	F1						
				SPA111	F1						
				SPA109	F1						
				ATS23	F2		SAG015	H2		ESS0073A	J1
				SPA109	F1		SAG178	H1			
				SPA111	F1						
				SPA109	F1						
				SPA111	F1						
				ATS23	F2		SAC015	H2	BAE680AX	ESS0016A	J1
				SPA109	F1		SAC015-1	H2		GA2226	J2
							SAD028	H3			
							SAF001	H4			
							SAG018	H1			
				ATS23	F2		SAD028	H3			
				SPA109	F1		SAG178	H1			
							SAG018	H1			
				ATS19	F2		SAC040	H2	BAE680S	ESS0016A	J1
				SPA109	F1						
				ATS23	F2		SAC015	H2			
				SPA109	F1						
							SAG049	H1		GA2226	J2
							SAC015-1	H2			
							SAG065	H1			
				ATS19	F2		SAC040	H2		ESS0016A	J1
				SPA109	F1						
				ATS23	F2		SAC015	H2			
				SPA109	F1						
							SAG049	H1		GA2226	J2
							SAC015-1	H2			
							SAG065	H1			
				ATS23	F2		SAC015	H2	BAE680S	ESS0016A	J1
				SPA109	F1						
				SPA111	F1						
							SAC015-1	H2		GA2226	J2
							SAG065	H1			



KW



TYPE



TYPE

VOLKSWAGEN

BORA Station wagon (1J6)

1.4 16V	Petrol	55	09/01 → 05/05	ENGINE: AHW,AXP,BCA				
1.4 16V	Petrol	55	09/01 → 05/05					
1.4 16V	Petrol	55	09/01 → 05/05					
1.4 16V	Petrol	55	09/01 → 05/05					
1.6	Petrol	74	05/99 → 05/00				AMM19670	B4
1.6	Petrol	75	08/00 → 05/05				AMM19670	B4
1.6	Petrol	74	05/99 → 05/05					
1.6	Petrol	74	05/99 → 05/05					
1.6	Petrol	75	08/00 → 05/05					
1.6	Petrol	75	08/00 → 05/05					
1.6	Petrol	75	09/00 → 05/05					
1.6	Petrol	74	05/99 → 05/05					
1.6 16V	Petrol	77	02/00 → 05/05					
1.6 16V	Petrol	77	02/00 → 05/05					
1.6 FSI	Petrol	81	01/02 → 05/05					
1.6 FSI	Petrol	81	01/02 → 05/05					
1.8 4motion	Petrol	92	05/99 → 05/05					
1.8 4motion	Petrol	92	05/99 → 05/05					
1.8 4motion	Petrol	92	05/99 → 10/00					
1.8 T	Petrol	110	05/00 → 03/03					
1.8 T	Petrol	110	04/03 → 05/05					
1.8 T	Petrol	132	05/02 → 03/03					
1.8 T	Petrol	132	04/03 → 05/03					
1.8 T	Petrol	110	05/00 → 05/05					
1.8 T	Petrol	110	05/00 → 05/05					
1.8 T	Petrol	110	05/00 → 09/02					
1.8 T	Petrol	132	05/02 → 05/05					
1.8 T	Petrol	132	05/02 → 05/05					
1.8 T	Petrol	132	05/02 → 09/02					
1.8 T	Petrol	132	05/02 → 05/03					
1.9 TDI	Diesel	110	05/01 → 05/05				AMM19752	B4
1.9 TDI	Diesel	96	11/00 → 05/05				AMM19752	B4
1.9 TDI	Diesel	66	07/04 → 05/05					
1.9 TDI	Diesel	74	09/00 → 03/03					
1.9 TDI	Diesel	74	04/03 → 05/05					
1.9 TDI	Diesel	81	05/99 → 06/01					
1.9 TDI	Diesel	85	05/99 → 06/01					
1.9 TDI	Diesel	96	11/00 → 05/05					
1.9 TDI	Diesel	110	05/01 → 05/05					
1.9 TDI	Diesel	66	07/04 → 05/05					
1.9 TDI	Diesel	74	09/00 → 05/05					
1.9 TDI	Diesel	74	09/00 → 05/05					
1.9 TDI	Diesel	81	05/99 → 06/01					
1.9 TDI	Diesel	85	05/99 → 06/01					



TYPE

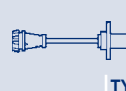

TYPE



TYPE

IWP092									
			ATS23	F2	SAA105	SAC014	H2		
			SPA109	F1		SAD028	H3		
						SAG178	H1		
			ATS23	F2		SAC015	H2		
			ATS23	F2		SAC015	H2	ESS0016A	J1
			SPA109	F1		SAC015-1	H2	GA2226	J2
			SPA109	F1		SAC015-1	H2		
						SAG178	H1		
			SPA111	F1					
						SAG018	H1		
			ATS23	F2	SAA105	SAC014	H2		
			SPA109	F1		SAD028	H3		
			ATS23	F2	SAA105	SAC011	H2		
			SPA109	F1					
			ATS23	F2		SAG018	H1		
			SPA109	F1					
						SAC084	H2		
	APS39								
	APS40								
	APS39								
	APS40								
			ATS23	F2		SAC084	H2		
			SPA109	F1		SAG178	H1		
			ATS19	F2					
			ATS23	F2					
			SPA109	F1					
			ATS19	F2					
						SAC084	H2		
			ATS23	F2		SAG015	H2	ESS0073A	J1
	APS39		ATS23	F2		SAG015	H2	ESS0073A	J1
	APS39		ATS23	F2		SAG178	H1		
	APS39								
	APS40								
	APS39		ATS23	F2		SAG178	H1		
	APS39		ATS23	F2		SAG015	H2		
			SPA109	F1					
			SPA109	F1					
			SPA109	F1					
			ATS23	F2		SAG015	H2	ESS0073A	J1
			SPA109	F1		SAG178	H1		
			SPA109	F1					
			SPA109	F1		SAG178	H1		



KW



TYPE



TYPE

VOLKSWAGEN

BORA Station wagon (1J6)

1.9 TDI 4motion	Diesel	110	05/01 → 05/05				AMM19752	B4
1.9 TDI 4motion	Diesel	96	11/00 → 05/05				AMM19752	B4
1.9 TDI 4motion	Diesel	74	09/00 → 03/03					
1.9 TDI 4motion	Diesel	74	04/03 → 05/05					
1.9 TDI 4motion	Diesel	85	05/99 → 06/01					
1.9 TDI 4motion	Diesel	96	11/00 → 05/05					
1.9 TDI 4motion	Diesel	110	05/01 → 05/05					
1.9 TDI 4motion	Diesel	74	09/00 → 05/05					
1.9 TDI 4motion	Diesel	74	09/00 → 05/05					
1.9 TDI 4motion	Diesel	85	05/99 → 06/01					
1.9 TDI 4motion	Diesel	96	04/01 → 05/05					
2.0	Petrol	85	05/99 → 05/05					
2.0	Petrol	85	05/99 → 05/05					
2.0	Petrol	85	05/99 → 05/05					
2.0	Petrol	85	05/99 → 05/05					
2.0 4motion	Petrol	85	04/00 → 05/05					
2.0 4motion	Petrol	85	04/00 → 05/05					
2.0 4motion	Petrol	85	04/00 → 12/02					
2.3 V5	Petrol	110	05/99 → 10/00					
2.3 V5	Petrol	110	05/99 → 10/00	CHASSIS: 1JY000001 →				
2.3 V5	Petrol	125	10/00 → 05/05					
2.3 V5	Petrol	125	10/00 → 05/05	CHASSIS: 1JY000001 →				
2.3 V5	Petrol	110	05/99 → 10/00					
2.3 V5	Petrol	125	10/00 → 05/05					
2.3 V5	Petrol	125	10/00 → 05/05					
2.3 V5 4motion	Petrol	110	05/99 → 10/00					
2.3 V5 4motion	Petrol	110	05/99 → 10/00	CHASSIS: 1JY000001 →				
2.3 V5 4motion	Petrol	110	05/00 → 10/00					
2.3 V5 4motion	Petrol	125	10/00 → 05/05					
2.3 V5 4motion	Petrol	125	10/00 → 05/05	CHASSIS: 1JY000001 →				
2.3 V5 4motion	Petrol	110	05/99 → 10/00					
2.3 V5 4motion	Petrol	125	10/00 → 05/05					
2.3 V5 4motion	Petrol	125	10/00 → 05/05					
2.8 V6 4motion	Petrol	150	05/99 → 05/05					
2.8 V6 4motion	Petrol	150	05/99 → 05/05	CHASSIS: 1JY000001 →				
2.8 V6 4motion	Petrol	150	05/99 → 05/05					
2.8 V6 4motion	Petrol	150	05/99 → 05/05					
2.8 VR6	Petrol	150	03/00 → 05/00					

CADDY I (14)

1.5	Petrol	51	08/82 → 07/83					
1.5	Petrol	51	08/82 → 07/83					
1.6	Petrol	55	01/83 → 07/92					
1.6	Petrol	55	10/82 → 10/83					
1.6	Petrol	55	01/83 → 07/92					



TYPE

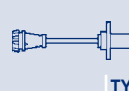

TYPE



TYPE

			ATS23	F2		SAG015	H2		
	APS39		ATS23	F2		SAG015	H2		
	APS39								
	APS40								
	APS39		ATS23	F2		SAG015	H2	ESS0073A	J1
			SPA109	F1					
			SPA109	F1					
			ATS23	F2		SAG015	H2		
			SPA109	F1		SAG178	H1		
			SPA109	F1		SAG178	H1		
			SPA111	F1					
			ATS23	F2		SAC015	H2	ESS0016A	J1
			SPA109	F1		SAC015-1	H2	GA2226	J2
						SAD028	H3		
						SAG018	H1		
			ATS23	F2		SAD028	H3		
			SPA109	F1		SAG178	H1		
						SAG018	H1		
			ATS19	F2		SAC040	H2	ESS0016A	J1
			SPA109	F1					
			ATS23	F2		SAC015	H2		
			SPA109	F1					
						SAG049	H1	GA2226	J2
						SAC015-1	H2		
						SAG065	H1		
			ATS23	F2		SAC040	H2	ESS0016A	J1
			SPA109	F1					
			ATS19	F2					
			ATS23	F2		SAC015	H2		
			SPA109	F1					
						SAG049	H1	GA2226	J2
						SAC015-1	H2		
						SAG065	H1		
			ATS23	F2		SAC015	H2		
			SPA109	F1					
						SAC015-1	H2		
						SAG065	H1		
						SAG065	H1		
			SPA105	F1	SAA102				
					SAA104				
			SPA105	F1	SAA102	SAG178	H1		
			SPA105	F1					
					SAA104				



KW

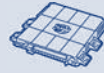

TYPE



TYPE

VOLKSWAGEN

CADDY I (14)

1.6 D	Diesel	40	08/82 → 07/92
1.6 D	Diesel	40	08/82 → 07/92
1.8	Petrol	70	08/85 → 07/92
1.8	Petrol	70	08/85 → 07/92

CADDY II Furgonato (9K9A)

1.4	Petrol	55	08/00 → 01/04
1.4	Petrol	55	08/00 → 01/04
1.4	Petrol	55	08/00 → 01/04
1.9 D	Diesel	47	11/95 → 01/04
1.9 SDI	Diesel	47	11/95 → 01/04
1.9 SDI	Diesel	47	09/00 → 01/04
60 1.4	Petrol	44	11/95 → 01/04
60 1.4	Petrol	44	11/95 → 01/04
60 1.4	Petrol	44	11/95 → 01/04
60 1.4	Petrol	44	09/00 → 06/03
75 1.6	Petrol	55	11/95 → 09/00
75 1.6	Petrol	55	11/95 → 05/97
75 1.6	Petrol	55	11/95 → 09/00

CADDY II Pick-up (9U7)

1.6	Petrol	55	06/96 → 12/00
-----	--------	----	---------------

CADDY II Station wagon (9K9B)

1.4	Petrol	44	11/95 → 01/04
1.4	Petrol	44	11/95 → 01/04
1.4	Petrol	44	11/95 → 01/04
1.4 16V	Petrol	55	08/00 → 01/04
1.4 16V	Petrol	55	08/00 → 01/04
1.4 16V	Petrol	55	08/00 → 01/04
1.6	Petrol	55	06/97 → 09/00
1.6	Petrol	55	11/95 → 05/97
1.9 D	Diesel	47	11/95 → 01/04
1.9 SDI	Diesel	47	11/95 → 01/04
1.9 SDI	Diesel	47	09/00 → 01/04
1.9 TDI	Diesel	66	10/96 → 01/04
1.9 TDI	Diesel	66	09/00 → 06/03
1.9 TDI	Diesel	66	10/96 → 01/04

CADDY III Furgonato (2KA, 2KH, 2CA, 2CH)

1.2 TSI	Petrol	63	09/10 →
1.2 TSI	Petrol	77	09/10 →
1.4	Petrol	55	03/04 → 05/06
1.4	Petrol	55	03/04 → 05/06
1.4 16V	Petrol	59	05/06 → 08/10
1.4 16V	Petrol	59	05/06 → 08/10
1.6	Petrol	75	04/04 →
1.6	Petrol	75	04/04 →



TYPE



TYPE



TYPE

				SPA105	F1	SAA102						
						SAA104						
				SPA105	F1	SAA102				ESS0171A	J1	
						SAA104						
				SPA109	F1	SAA105	SAC014	H2				
				SPA110	F1		SAD028	H3				
							SAG178	H1				
				SPA109	F1		SAG178	H1				
				SPA109	F1		SAG142	H1				
				ATS18	F2							
				SPA109	F1	SAA105	SAC011	H2	BAE680AA			
							SAD028	H3				
							SAG178	H1				
							SAG145	H1				
				SPA110	F1		SAD028	H3		ESS0019A	J1	
				SPA110	F1		SAG178	H1		ESS0019A	J1	
							SAG178	H1				
				SPA110	F1		SAG178	H1				
				SPA109	F1	SAA105	SAC011	H2				
				SPA110	F1		SAD028	H3				
							SAG145	H1				
				SPA109	F1	SAA105	SAC014	H2				
							SAD028	H3				
							SAG178	H1				
				SPA110	F1		SAG178	H1				
				SPA110	F1		SAG178	H1	BAE680AA	ESS0042A	J1	
				SPA109	F1		SAG178	H1				
				SPA109	F1		SAG142	H1				
				ATS18	F2							
	APS29			ATS18	F2		SAG142	H1				
	APS39											
				SPA109	F1							
				SPA111	F1		SAC011	H2				
				SPA111	F1		SAC011	H2				
				ATS23	F2	SAA105	SAC014	H2	BAE680AU			
				SPA111	F1		SAG166	H1				
				SPA111	F1	SAA105	SAC014	H2				
							SAG166	H1				
				ATS23	F2		SAC075	H2				
				SPA111	F1							



KW



TYPE



TYPE

VOLKSWAGEN

CADDY III Furgonato (2KA, 2KH, 2CA, 2CH)

1.6 Bifuel	Petrol/LPG	75	05/11 →						
1.6 TDI	Diesel	55	08/10 →						
1.6 TDI	Diesel	75	08/10 →						
1.9 TDI	Diesel	77	04/04 → 08/10						
1.9 TDI	Diesel	55	09/05 → 08/10						
1.9 TDI	Diesel	77	04/04 → 08/10						
1.9 TDI 4motion	Diesel	77	11/08 → 08/10						
2.0 EcoFuel	Petrol/CNG	80	04/06 →						
2.0 EcoFuel	Petrol/CNG	80	04/06 →						
2.0 SDI	Diesel	51	03/04 → 08/10						
2.0 SDI	Diesel	51	03/04 → 08/10						
2.0 TDi	Diesel	103	09/07 → 08/10				AMM19752		B4
2.0 TDi	Diesel	62	11/10 →						
2.0 TDi	Diesel	125	05/12 →						
2.0 TDi	Diesel	81	08/10 →						
2.0 TDi 16V	Diesel	103	11/10 →						
2.0 TDi 16V 4motion	Diesel	103	11/10 →						
2.0 TDi 4motion	Diesel	62	12/10 →						
2.0 TDi 4motion	Diesel	81	08/10 →						

CADDY III Station wagon (2KB, 2KJ, 2CB, 2CJ)

1.2 TSI	Petrol	63	09/10 →						
1.2 TSI	Petrol	77	09/10 →						
1.4	Petrol	55	03/04 → 05/06						
1.4	Petrol	55	03/04 → 05/06						
1.4 16V	Petrol	59	05/06 → 08/10						
1.4 16V	Petrol	59	05/06 → 08/10						
1.6	Petrol	75	04/04 →						
1.6 Bifuel	Petrol/LPG	75	05/11 →						
1.6 TDI	Diesel	55	08/10 →						
1.6 TDI	Diesel	75	08/10 →						
1.9 TDI	Diesel	55	09/05 → 08/10						
1.9 TDI	Diesel	77	04/04 → 08/10						
1.9 TDI 4motion	Diesel	77	05/08 → 08/10						
2.0 EcoFuel	Petrol/CNG	80	04/06 →						
2.0 EcoFuel	Petrol/CNG	80	04/06 →						
2.0 SDI	Diesel	51	03/04 → 08/10						
2.0 TDi	Diesel	103	09/07 → 08/10				AMM19752		B4
2.0 TDi	Diesel	125	05/12 →						
2.0 TDi	Diesel	81	08/10 →						
2.0 TDi 16V	Diesel	103	11/10 →						
2.0 TDi 16V 4motion	Diesel	103	11/10 →						
2.0 TDi 4motion	Diesel	81	08/10 →						



TYPE

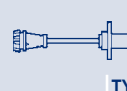

TYPE



TYPE

				SPA111	F1						
				SPA111	F1	SAA105					
				SPA111	F1	SAA105					
		APS40		ATS23	F2		SAG166	H1			
				SPA111	F1		SAG166	H1			
				SPA111	F1						
				SPA111	F1					GA2066	J2
				SPA111	F1		SAC015	H2			
							SAC015-1	H2			
		APS40		ATS23	F2		SAG166	H1			
				SPA111	F1						
				SPA111	F1		SAG166	H1			
		SPS004		SPA111	F1	SAA105					
				SPA111	F1	SAA105					
				SPA111	F1	SAA105					
		SPS004		SPA111	F1	SAA105					
		SPS004		SPA111	F1	SAA105					
		SPS004		SPA111	F1	SAA105					
		SPS004		SPA111	F1	SAA105					
				SPA111	F1		SAC011	H2			
				SPA111	F1		SAC011	H2			
				SPA111	F1	SAA105	SAC014	H2			
							SAG166	H1			
				SPA111	F1	SAA105	SAC014	H2			
							SAG166	H1			
				SPA111	F1		SAC075	H2			
				SPA111	F1						
				SPA111	F1	SAA105					
				SPA111	F1	SAA105					
		APS40		SPA111	F1		SAG166	H1			
		APS40		SPA111	F1		SAG166	H1			
				SPA111	F1		SAG166	H1		GA2066	J2
				SPA111	F1		SAC015	H2			
							SAC015-1	H2			
		APS40		SPA111	F1		SAG166	H1			
				SPA111	F1		SAG166	H1			
				SPA111	F1	SAA105					
				SPA111	F1	SAA105					
		SPS004		SPA111	F1	SAA105					
		SPS004		SPA111	F1	SAA105					
		SPS004		SPA111	F1	SAA105					



KW

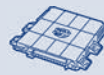

TYPE



TYPE

VOLKSWAGEN

CC (358)

1.8 TSI	Petrol	118	11/11 →						
2.0 TDi	Diesel	103	11/11 →						
2.0 TDi	Diesel	125	11/11 →						
2.0 TSI	Petrol	155	11/11 →						
3.6 FSI 4motion	Petrol	220	11/11 →						

CORRADO (531)

1.8 G60	Petrol	118	09/88 → 09/93						
1.8 G60	Petrol	118	09/88 → 09/93						
2.0 i	Petrol	85	07/94 → 07/95				AMM19672	B4	
2.0 i	Petrol	85	04/93 → 12/95						
2.0 i	Petrol	85	04/93 → 12/95						
2.0 i	Petrol	85	10/94 → 07/95	ENGINE: 2E,ADY					
2.0 i 16V	Petrol	100	08/91 → 12/95						
2.0 i 16V	Petrol	100	08/91 → 12/95						
2.0 i 16V	Petrol	100	10/94 → 07/95	ENGINE: 9A					
2.9 VR6	Petrol	140	08/91 → 07/95						
2.9 VR6	Petrol	140	08/91 → 12/95						
2.9 VR6	Petrol	140	10/94 → 07/95	ENGINE: ABV					

CRAFTER 30-35 Autobus (2E_)

2.0 TDi	Diesel	100	05/11 →						
2.0 TDi	Diesel	120	07/11 →						
2.0 TDi	Diesel	80	05/11 →						
2.0 TDi 4motion	Diesel	120	11/11 →						
2.5 TDI	Diesel	100	04/06 → 07/11						
2.5 TDI	Diesel	120	04/06 → 07/11						
2.5 TDI	Diesel	65	04/06 → 07/11						
2.5 TDI	Diesel	80	04/06 → 07/11						
2.5 TDI	Diesel	100	04/06 →						
2.5 TDI	Diesel	80	04/06 →						

CRAFTER 30-50 Furgonato (2E_)

2.0 TDi	Diesel	100	05/11 →						
2.0 TDi	Diesel	105	10/11 →						
2.0 TDi	Diesel	120	07/11 →						
2.0 TDi	Diesel	80	05/11 →						
2.0 TDi 4motion	Diesel	120	11/11 →						
2.5 TDI	Diesel	100	04/06 → 07/11						
2.5 TDI	Diesel	120	04/06 → 07/11						
2.5 TDI	Diesel	65	04/06 → 07/11						
2.5 TDI	Diesel	80	04/06 → 07/11						
2.5 TDI	Diesel	100	04/06 →						
2.5 TDI	Diesel	80	04/06 →						



TYPE



TYPE



TYPE

				SPA111	F1				BAE680BB		
				SPA111	F1	SAA105					
				SPA111	F1	SAA105					
				SPA111	F1				BAE680BB		
				SPA111	F1		SAC011	H2			
				SPA105	F1	SAA102	SAD019	H3			
						SAA104	SAG026	H1			
				ATS18	F2	SAA102	SAG026	H1			
				SPA110	F1	SAA104					
										GA2032	J2
						SAA102	SAD019	H3			
						SAA104	SAG178	H1			
										GA2032	J2
IWP022											
				SPA106	F1	SAA102					
										GA2032	J2
				SPA111	F1	SAA105					
				SPA111	F1	SAA105					
				SPA111	F1	SAA105					
				SPA111	F1						
				SPA111	F1						
				SPA111	F1		SAG166	H1			
				SPA111	F1		SAG166	H1			
				SPA111	F1						
							SAG166	H1			
							SAG166	H1			
				SPA111	F1	SAA105					
				SPA111	F1	SAA105					
				SPA111	F1	SAA105					
				SPA111	F1	SAA105					
				SPA111	F1						
				SPA111	F1						
				SPA111	F1		SAG166	H1			
				SPA111	F1		SAG166	H1			
				SPA111	F1						
							SAG166	H1			
							SAG166	H1			



KW



TYPE



TYPE

VOLKSWAGEN

CRAFTER 30-50 Pianale piatto/Telaio (2F_)

2.0 TDi	Diesel	100	05/11 →						
2.0 TDi	Diesel	105	10/11 →						
2.0 TDi	Diesel	120	07/11 →						
2.0 TDi	Diesel	80	05/11 →						
2.0 TDi 4motion	Diesel	120	11/11 →						
2.5 TDi	Diesel	100	04/06 → 07/11						
2.5 TDi	Diesel	120	04/06 → 07/11						
2.5 TDi	Diesel	65	04/06 → 07/11						
2.5 TDi	Diesel	80	04/06 → 07/11						
2.5 TDi	Diesel	100	04/06 →						
2.5 TDi	Diesel	80	04/06 →						

DERBY (86)

0.9	Petrol	29	02/77 → 09/81						
1.1	Petrol	37	02/77 → 09/81						
1.3	Petrol	44	02/77 → 09/81						

DERBY (86C, 80)

1.0	Petrol	29	10/81 → 12/84						
1.0	Petrol	29	10/81 → 12/84						
1.1	Petrol	37	10/81 → 07/83						
1.1	Petrol	37	10/81 → 07/83						
1.3	Petrol	40	08/83 → 12/84						
1.3	Petrol	40	08/83 → 12/84						
1.3	Petrol	44	08/81 → 07/83						
1.3	Petrol	44	08/81 → 07/83						

EOS (1F7, 1F8)

1.4 TSI	Petrol	118	05/08 →						
1.4 TSI	Petrol	118	05/08 → 11/10						
1.4 TSI	Petrol	90	11/07 → 11/10						
1.4 TSI	Petrol	118	05/08 → 10/10						
1.4 TSI	Petrol	90	11/07 → 10/10						
1.4 TSI	Petrol	90	11/07 →						
1.6 FSI	Petrol	85	06/06 → 05/08						
1.6 FSI	Petrol	85	06/06 → 05/08						
1.6 FSI	Petrol	85	06/06 → 05/08						
2.0 FSI	Petrol	110	03/06 → 05/08						
2.0 FSI	Petrol	110	03/06 → 05/08						
2.0 FSI	Petrol	110	05/06 → 05/08						
2.0 TDi	Diesel	103	06/06 → 05/08				AMM19752	B4	
2.0 TDi	Diesel	100	11/10 →						
2.0 TDi 16V	Diesel	103	05/08 →						
2.0 TDi 16V	Diesel	103	05/08 → 11/10						
2.0 TFSI	Petrol	147	05/06 → 11/10						
2.0 TFSI	Petrol	147	03/06 →						
2.0 TSI	Petrol	155	11/09 → 11/10						

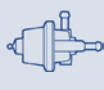

TYPE

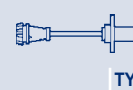

TYPE



TYPE

			SPA111	F1	SAA105					
			SPA111	F1	SAA105					
			SPA111	F1	SAA105					
			SPA111	F1	SAA105					
			SPA111	F1						
			SPA111	F1						
			SPA111	F1		SAG166		H1		
			SPA111	F1		SAG166		H1		
			SPA111	F1						
						SAG166		H1		
						SAG166		H1		
						SAA102				
						SAA102				
						SAA102				
						SAA102				
						SAA104				
						SAA102				
						SAA104				
						SAA102				
						SAA104				
						SAA102				
						SAA104				
						SAA102				
						SAA104				
			ATS16	F2		SAG155		H1		
			SPA111	F1		SAC011		H2		
			SPA111	F1		SAC011		H2		
						SAA105				
						SAA105				
						SAG155		H1		
			SPA111	F1	SAA105	SAC011		H2		
						SAD031		H3		
						SAG166		H1		
			SPA111	F1		SAD031		H3		
						SAG100		H1		
									BAE680BB	
			SPA111	F1		SAG166		H1		ESS0073A
	SPS004		SPA111	F1	SAA105					J1
	SPS004									
			SPA111	F1						
			SPA111	F1						
									BAE680BB	
			SPA111	F1						



KW



TYPE



TYPE

VOLKSWAGEN

EOS (1F7, 1F8)

2.0 TSI	Petrol	155	11/09 →						
3.2 V6	Petrol	184	06/06 → 05/09						
3.2 V6	Petrol	184	06/06 → 05/09						
3.2 V6	Petrol	184	06/06 → 05/09						
3.2 V6	Petrol	184	06/08 → 05/09						
3.6 V6	Petrol	191	05/09 → 11/10						

FOX (5Z1, 5Z3)

1.2	Petrol	40	04/05 →						
1.2	Petrol	40	04/05 →						
1.2	Petrol	44	09/10 →						
1.2	Petrol	44	09/10 → 12/11						
1.4	Petrol	55	04/05 →						
1.4	Petrol	55	04/05 →						
1.4	Petrol	55	04/05 →						
1.4 TDI	Diesel	51	04/05 →						
1.4 TDI	Diesel	51	04/05 →						

GOL

1.6	Petrol	68	12/98 → 05/02						
1.6	Petrol	73	12/98 → 05/08	ENGINE: BWX					
1.8	Petrol	77	04/98 → 05/02						
2.0	Petrol	85	10/96 → 05/02						

GOLF I (17)

1.1	Petrol	37	04/74 → 07/83						
1.1	Petrol	38	08/76 → 07/80						
1.1	Petrol	38	08/76 → 07/80						
1.1	Petrol	44	01/81 → 07/83						
1.1	Petrol	44	01/81 → 07/83						
1.3	Petrol	44	08/79 → 07/83						
1.3	Petrol	44	01/81 → 07/83						
1.5	Petrol	51	04/74 → 12/75						
1.5	Petrol	51	08/77 → 07/83						
1.5	Petrol	51	01/81 → 07/83						
1.5 D	Diesel	37	08/76 → 07/80						
1.6	Petrol	55	08/75 → 02/84						
1.6	Petrol	55	01/83 → 02/84						
1.6 D	Diesel	40	08/80 → 07/83						
1.6 D	Diesel	40	01/81 → 07/83						
1.6 GTI	Petrol	81	08/76 → 07/82						
1.6 GTI	Petrol	81	01/81 → 07/82						
1.6 TD	Diesel	51	03/82 → 07/83						
1.6 TD	Diesel	51	03/82 → 07/83						
1.8 GTI	Petrol	82	08/82 → 12/83						
1.8 GTI	Petrol	82	08/82 → 12/83						

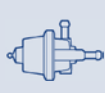

TYPE

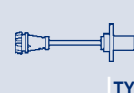

TYPE



TYPE

SPA111

F1

SAC040

H2

BAE680BB

BAE680BC

SAD031

H3

SAG065

H1

SAC011

H2

SPA111

F1

SAC011

H2

ATS23

F2

SAA105

SAC011

H2

BAE680Y

SPA111

F1

SAD031

H3

SPA111

F1

SAA105

SAC011

H2

ATS23

F2

SAA105

SAC011

H2

SPA111

F1

SAD031

H3

SAG166

H1

APS39

ATS23

F2

SAG134

H1

ESS0075A

J1

SPA111

F1

IWP044

IWP044

IWP044

IWP024

SAA102

SAA102

SAA104

SAA102

SAA104

SAA102

SAA104

SAA102

SAA102

SAA104

SAA102

SAA102

SAG178

H1

SAA102

SAA104

SAA102

ESS0171A

J1

SAA104

SAA102

SAA104

SAA102

ESS0171A

J1

SAA104



KW



TYPE



TYPE

VOLKSWAGEN

GOLF I Cabriolet (155)

1.5	Petrol	51	01/79 → 11/83						
1.5	Petrol	51	08/82 → 11/83						
1.6	Petrol	53	04/86 → 02/90						
1.6	Petrol	53	04/86 → 02/90						
1.6	Petrol	55	08/83 → 04/92						
1.6	Petrol	55	08/83 → 04/92						
1.6	Petrol	81	08/79 → 07/82						
1.8	Petrol	66	08/83 → 09/92						
1.8	Petrol	66	08/83 → 09/92						
1.8	Petrol	70	08/83 → 04/93						
1.8	Petrol	70	08/83 → 04/93						
1.8	Petrol	72	08/89 → 03/93						
1.8	Petrol	72	08/89 → 03/93						
1.8	Petrol	82	08/82 → 12/89						
1.8	Petrol	82	08/82 → 12/89						

GOLF II (19E, 1G1)

1.0	Petrol	37	08/85 → 10/91						
1.0	Petrol	37	01/89 → 10/91						
1.0	Petrol	33	11/83 → 08/85						
1.3	Petrol	37	08/85 → 12/87						
1.3	Petrol	40	08/83 → 06/87						
1.3	Petrol	43	08/83 → 10/86						
1.6	Petrol	51	10/86 → 07/92						
1.6	Petrol	51	01/89 → 12/92						
1.6	Petrol	53	01/89 → 10/91						
1.6	Petrol	55	01/89 → 07/92						
1.6	Petrol	51	10/86 → 12/92						
1.6	Petrol	53	02/86 → 10/91						
1.6	Petrol	55	08/83 → 07/92						
1.6 D	Diesel	37	01/89 → 10/91						
1.6 D	Diesel	40	01/89 → 10/91						
1.6 D	Diesel	37	08/83 → 10/91						
1.6 D	Diesel	40	08/83 → 10/91						
1.6 TD	Diesel	51	01/89 → 10/91						
1.6 TD	Diesel	59	04/89 → 10/91						
1.6 TD	Diesel	44	08/89 → 10/91						
1.6 TD	Diesel	51	08/83 → 10/91						
1.8	Petrol	62	01/89 → 01/90						
1.8	Petrol	62	08/86 → 01/90						
1.8 GTI	Petrol	82	08/83 → 10/91						
1.8 GTI 16V	Petrol	95	01/89 → 10/91						
1.8 GTI 16V	Petrol	102	02/86 → 06/90						
1.8 GTI 16V	Petrol	95	02/86 → 10/91						
1.8 GTI Cat.	Petrol	79	01/89 → 10/91						

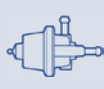

TYPE

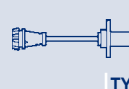

TYPE



TYPE

					SAA102					
					SAA104					
					SAA102					
					SAA104					
					SAA102	SAG178	H1			
					SAA104					
					SAA102				ESS0171A	J1
					SAA102					
					SAA104					
					SAA102				ESS0171A	J1
					SAA104					
					SAA102	SAD019	H3			
					SAA104					
					SAA102				ESS0171A	J1
					SAA104					

				SPA106	F1	SAA104				
				SPA105	F1					
						SAA104				
						SAA104				
						SAA104				
						SAA104				
				SPA143	F1					
				SPA105	F1					
				SPA105	F1					
				SPA105	F1					
						SAA104				
						SAA104				
						SAA104	SAG178	H1		
				SPA105	F1					
				SPA105	F1					
						SAA104				
						SAA104				
				SPA105	F1					
				SPA106	F1	SAA104				
						SAA104				
						SAA104				
				SPA105	F1					
						SAA104				
						SAA104	SAD021	H3		
				SPA105	F1					
						SAA104				
						SAA104	SAD021	H3		
				SPA105	F1					



KW



TYPE



TYPE

VOLKSWAGEN

GOLF II (19E, 1G1)

1.8 GTI Cat.	Petrol	79	01/87 → 10/91					
1.8 GTI G60	Petrol	118	04/90 → 07/91					
1.8 GTI G60 Syncro	Petrol	118	01/89 → 12/91					
1.8 GTI G60 Syncro	Petrol	118	08/88 → 12/91					
1.8 i Cat.	Petrol	66	08/87 → 10/91					
1.8 Syncro	Petrol	66	01/89 → 07/91					
1.8 Syncro	Petrol	66	02/86 → 07/91					
1.8 Syncro	Petrol	72	08/88 → 07/91					

GOLF III (1H1)

1.4	Petrol	44	10/91 → 08/97				TB0010	B3
1.4	Petrol	40	11/91 → 08/97					
1.4	Petrol	44	10/91 → 08/97					
1.4	Petrol	40	11/91 → 08/97					
1.6	Petrol	55	09/92 → 08/97				TB0010	B3
1.6	Petrol	74	01/96 → 08/97				AMM19672	B4
1.6	Petrol	55	09/92 → 08/97					
1.6	Petrol	74	07/95 → 08/97					
1.6	Petrol	74	07/95 → 08/97					
1.6	Petrol	74	01/96 → 08/97	ENGINE: AFT				
1.8	Petrol	55	11/91 → 08/97					
1.8	Petrol	66	11/91 → 08/97					
1.8	Petrol	55	11/91 → 08/97					
1.8	Petrol	66	11/91 → 08/97					
1.8 Syncro (1HX1)	Petrol	66	01/93 → 08/97					
1.8 Syncro (1HX1)	Petrol	66	01/93 → 09/94					
1.8 Syncro (1HX1)	Petrol	66	01/94 → 08/97					
1.8 Syncro (1HX1)	Petrol	66	01/93 → 08/97					
1.9 D	Diesel	48	11/91 → 08/97					
1.9 SDI	Diesel	47	07/95 → 08/97					
1.9 TD,GTD	Diesel	55	11/91 → 08/97					
1.9 TDI	Diesel	66	09/93 → 09/94					
1.9 TDI	Diesel	66	09/93 → 08/97					
1.9 TDI	Diesel	66	09/93 → 08/97					
1.9 TDI Syncro (1HX1)	Diesel	66	08/95 → 08/97					
1.9 TDI Syncro (1HX1)	Diesel	66	08/95 → 08/97					
2.0	Petrol	85	10/94 → 08/97				AMM19672	B4
2.0	Petrol	85	11/91 → 08/97					
2.0	Petrol	85	11/91 → 08/97					
2.0	Petrol	85	07/94 → 08/97					
2.0 GTI 16V	Petrol	110	08/92 → 08/97					
2.0 GTI 16V	Petrol	110	08/92 → 08/97					
2.0 Syncro (1HX1)	Petrol	85	08/95 → 08/97				AMM19672	B4
2.0 Syncro (1HX1)	Petrol	85	08/95 → 08/97					
2.8 VR6	Petrol	128	01/92 → 08/97					



TYPE



TYPE



TYPE

						SAA104	SAD021	H3		
				SPA105	F1	SAA104	SAD021	H3		
				SPA105	F1					
						SAA104	SAD021	H3		
				SPA106	F1	SAA104	SAG178	H1		
				SPA105	F1					
						SAA104	SAG178	H1		
						SAA104	SAD019	H3		
				SPA110	F1	SAA104	SAD028	H3	ESS0018A	J1
				SPA110	F1		SAD028	H3	ESS0019A	J1
							SAG026	H1	GA2222	J2
							SAG026	H1	GA2222	J2
				SPA110	F1	SAA104	SAD028	H3	ESS0018A	J1
							SAG026	H1	GA2222	J2
				SPA110	F1	SAA104	SAD021	H3	ESS0018A	J1
							SAG064	H1	GA2222	J2
									GA2032	J2
				SPA110	F1	SAA104	SAG026	H1	ESS0019A	J1
				SPA110	F1	SAA104	SAG178	H1	ESS0019A	J1
									GA2222	J2
									GA2222	J2
				SPA110	F1	SAA104	SAG178	H1	ESS0042A	J1
				SPA143	F1					
				SPA105	F1					
									GA2222	J2
				SPA140	F1		SAG178	H1		
				SPA110	F1		SAG142	H1		
				SPA105	F1		SAG178	H1		
		APS29								
				ATS18	F2		SAG142	H1		
				SPA104	F1					
				ATS18	F2		SAG142	H1		
				SPA110	F1					
				ATS18	F2	SAA104	SAG026	H1	ESS0018A	J1
				SPA110	F1				GA2032	J2
				SPA105	F1					
				ATS18	F2	SAA104	SAG118	H1	ESS0018A	J1
									GA2222	J2
				ATS18	F2		SAG118	H1	GA2222	J2
				SPA110	F1					
IWP022				SPA106	F1		SAD002	H3	ESS0018A	J1



KW



TYPE



TYPE

VOLKSWAGEN

GOLF III (1H1)

2.8 VR6	Petrol	128	01/92 → 08/97					
2.8 VR6	Petrol	128	01/92 → 08/97	ENGINE: AAA				
2.9 VR6 Syncro (1HX1)	Petrol	140	10/94 → 08/97					
2.9 VR6 Syncro (1HX1)	Petrol	140	10/94 → 08/97					
2.9 VR6 Syncro (1HX1)	Petrol	140	10/94 → 08/97	ENGINE: ABV				

GOLF III Cabriolet (1E7)

1.6	Petrol	74	12/95 → 05/98				AMM19672	B4
1.6	Petrol	74	10/94 → 05/98					
1.6	Petrol	74	10/94 → 05/98					
1.6	Petrol	74	10/94 → 12/95	ENGINE: AEK				
1.8	Petrol	55	07/93 → 05/98					
1.8	Petrol	66	07/93 → 05/98					
1.8	Petrol	55	07/93 → 05/98					
1.8	Petrol	66	07/93 → 05/98					
1.9 TDI	Diesel	66	08/95 → 05/98					
1.9 TDI	Diesel	66	08/95 → 05/98					
2.0	Petrol	85	07/93 → 05/98				AMM19672	B4
2.0	Petrol	85	07/93 → 05/98					
2.0	Petrol	85	07/94 → 05/98					
2.0	Petrol	85	07/93 → 05/98	ENGINE: ADY,AGG,AKR				

GOLF III Variant (1H5)

1.4	Petrol	44	07/93 → 04/99				TB0010	B3
1.4	Petrol	40	07/93 → 04/99					
1.4	Petrol	44	07/93 → 04/99					
1.4	Petrol	40	07/93 → 04/99					
1.6	Petrol	74	01/96 → 04/99				AMM19672	B4
1.6	Petrol	55	07/93 → 12/97					
1.6	Petrol	74	07/94 → 04/99					
1.6	Petrol	74	07/94 → 04/99					
1.6	Petrol	74	04/97 → 04/99	ENGINE: AKS				
1.8	Petrol	55	07/93 → 04/99					
1.8	Petrol	66	07/93 → 04/99					
1.8	Petrol	66	01/94 → 04/99					
1.8	Petrol	55	07/93 → 04/99					
1.8	Petrol	66	07/93 → 04/99					
1.9 D	Diesel	48	07/93 → 04/99					
1.9 SDI	Diesel	47	07/95 → 04/99					
1.9 TD	Diesel	55	07/93 → 04/99					
1.9 TDI	Diesel	66	03/94 → 09/94					
1.9 TDI	Diesel	66	03/94 → 04/99					
1.9 TDI	Diesel	66	03/94 → 04/99					
1.9 TDI Syncro	Diesel	66	07/95 → 04/99					
1.9 TDI Syncro	Diesel	66	07/95 → 04/99					
2.0	Petrol	85	10/94 → 04/99				AMM19672	B4

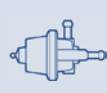

TYPE

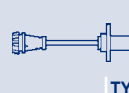

TYPE



TYPE

						SAG178	H1	GA2222	J2
								GA2032	J2
IWP022			SPA106	F1		SAC040	H2	GA2222	J2
						SAD002	H3		
								GA2032	J2
			SPA110	F1	SAA104	SAG064	H1	ESS0018A	J1
								GA2222	J2
								GA2032	J2
			SPA110	F1	SAA104	SAG026	H1	ESS0019A	J1
			SPA110	F1	SAA104	SAG178	H1	ESS0019A	J1
								GA2222	J2
								GA2222	J2
			ATS18	F2		SAG142	H1		
			SPA105	F1					
			ATS18	F2	SAA104	SAG026	H1	ESS0018A	J1
			SPA110	F1				GA2222	J2
			SPA105	F1					
								GA2032	J2
			SPA110	F1	SAA104	SAD028	H3	ESS0018A	J1
			SPA110	F1		SAG026	H1	ESS0019A	J1
						SAG026	H1	GA2222	J2
								GA2222	J2
			SPA110	F1	SAA104				
			SPA110	F1	SAA104	SAD021	H3	ESS0018A	J1
						SAG064	H1	GA2222	J2
								GA2032	J2
			SPA110	F1	SAA104	SAG026	H1	ESS0019A	J1
			SPA110	F1	SAA104	SAG178	H1	ESS0019A	J1
			SPA105	F1					
								GA2222	J2
								GA2222	J2
			SPA140	F1		SAG178	H1		
			SPA106	F1		SAG142	H1		
			SPA105	F1		SAG178	H1		
APS29									
			ATS18	F2		SAG142	H1		
			SPA105	F1					
			ATS18	F2		SAG142	H1		
			SPA110	F1					



KW



TYPE



TYPE

VOLKSWAGEN

GOLF III Variant (1H5)

2.0	Petrol	85	07/93 → 04/99					
2.0	Petrol	85	07/93 → 04/99					
2.0	Petrol	85	07/94 → 04/99					
2.0	Petrol	85	07/93 → 04/99	ENGINE: ADY,AGG,AKR				
2.0 Syncro	Petrol	85	08/95 → 04/99			AMM19672	B4	
2.0 Syncro	Petrol	85	08/95 → 04/99					
2.9 VR6	Petrol	140	10/94 → 04/99					
2.9 VR6	Petrol	140	10/94 → 04/99					
2.9 VR6	Petrol	140	10/94 → 12/97	ENGINE: ABV				

GOLF IV (1J1)

1.4 16V	Petrol	55	08/97 → 06/05					
1.4 16V	Petrol	55	08/97 → 06/05					
1.4 16V	Petrol	55	08/97 → 06/05	CHASSIS: 1JX250001 →				
1.6	Petrol	74	08/97 → 02/00			AMM19670	B4	
1.6	Petrol	75	08/00 → 06/05			AMM19670	B4	
1.6	Petrol	74	08/97 → 05/04					
1.6	Petrol	74	08/97 → 05/04	CHASSIS: 1JX250001 →				
1.6	Petrol	75	08/00 → 06/05					
1.6	Petrol	75	08/00 → 06/05	CHASSIS: 1JX250001 →				
1.6	Petrol	74	08/97 → 05/04					
1.6	Petrol	74	08/97 → 05/04					
1.6	Petrol	74	10/97 → 05/04					
1.6	Petrol	75	08/00 → 06/05					
1.6	Petrol	75	08/00 → 06/05					
1.6 16V	Petrol	77	02/00 → 06/05					
1.6 16V	Petrol	77	02/00 → 06/05	CHASSIS: 1JX250001 →				
1.6 16V	Petrol	77	02/00 → 11/01					
1.6 FSI	Petrol	81	01/02 → 06/05					
1.6 FSI	Petrol	81	01/02 → 06/05					
1.8	Petrol	92	08/97 → 06/05					
1.8	Petrol	92	08/97 → 06/05					
1.8	Petrol	92	10/97 → 10/00					
1.8	Petrol	92	10/97 → 06/05					
1.8 4motion	Petrol	92	05/98 → 06/05					
1.8 4motion	Petrol	92	05/98 → 06/05					
1.8 4motion	Petrol	92	07/98 → 10/00					
1.8 4motion	Petrol	92	05/00 → 06/05					
1.8 T	Petrol	110	08/97 → 05/03					
1.8 T	Petrol	110	08/97 → 06/05					
1.8 T	Petrol	110	08/97 → 06/05	CHASSIS: 1JX250001 →				
1.8 T	Petrol	110	10/97 → 09/02					
1.8 T	Petrol	110	08/97 → 06/05					
1.8 T	Petrol	110	08/97 → 06/05					
1.8 T GTI	Petrol	132	08/01 → 05/04					

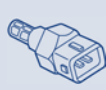
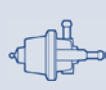

TYPE

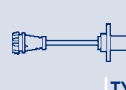

TYPE



TYPE

				ATS18	F2	SAA104	SAG026	H1	ESS0018A	J1	
				SPA110	F1				GA2222	J2	
				SPA105	F1						
									GA2032	J2	
				ATS18	F2		SAD019	H3	GA2222	J2	
				SPA110	F1		SAG118	H1			
							SAC040	H2	GA2222	J2	
							SAD002	H3			
									GA2032	J2	
	IWP058			ATS23	F2		SAC014	H2	BAE680AA	ESS0045A	J1
							SAG178	H1		GA2226	J2
				SPA109	F1	SAA105					
				ATS23	F2		SAC015	H2			
				ATS23	F2		SAC015	H2	ESS0045A	J1	
				SPA109	F1						
							SAC015-1	H2			
				SPA109	F1						
							SAC015-1	H2	GA2226	J2	
							SAG178	H1			
							SAG018	H1			
							SAD031	H3			
							SAG178	H1			
				ATS23	F2		SAC014	H2	BAE680AA		
				SPA109	F1	SAA105					
				ATS19	F2						
				ATS23	F2	SAA105	SAC011	H2			
				SPA109	F1		SAD031	H3			
				ATS23	F2		SAC084	H2	BAE680AA	ESS0045A	J1
				SPA109	F1		SAG178	H1		GA2226	J2
				ATS19	F2						
							SAG018	H1			
				ATS23	F2		SAC084	H2			
				SPA109	F1		SAG178	H1			
				ATS19	F2						
							SAG018	H1			
	APS39			ATS23	F2		SAC084	H2		ESS0045A	J1
				SPA109	F1						
				ATS19	F2						
							SAD031	H3	GA2226	J2	
							SAG018	H1			
	APS39										



KW



TYPE



TYPE

VOLKSWAGEN

GOLF IV (1J1)

1.8 T GTI	Petrol	132	08/01 → 06/05					
1.8 T GTI	Petrol	132	08/01 → 06/05					
1.8 T GTI	Petrol	132	08/01 → 09/02					
1.9 SDI	Diesel	50	08/97 → 06/05					
1.9 SDI	Diesel	50	08/97 → 06/05	CHASSIS: 1JX250001 →				
1.9 SDI	Diesel	50	08/97 → 04/99					
1.9 TDI	Diesel	110	05/00 → 06/05			AMM19752		B4
1.9 TDI	Diesel	96	11/00 → 06/05			AMM19752		B4
1.9 TDI	Diesel	110	09/00 → 05/04					
1.9 TDI	Diesel	66	10/97 → 05/04					
1.9 TDI	Diesel	74	09/00 → 11/02					
1.9 TDI	Diesel	74	05/01 → 05/04					
1.9 TDI	Diesel	81	08/97 → 11/02					
1.9 TDI	Diesel	81	12/02 → 05/04					
1.9 TDI	Diesel	85	05/99 → 06/01					
1.9 TDI	Diesel	96	04/01 → 05/04					
1.9 TDI	Diesel	110	05/00 → 06/05	CHASSIS: 1JX250001 →				
1.9 TDI	Diesel	66	10/97 → 05/04	CHASSIS: 1JX250001 →				
1.9 TDI	Diesel	74	09/00 → 06/05					
1.9 TDI	Diesel	74	09/00 → 06/05					
1.9 TDI	Diesel	81	08/97 → 05/04					
1.9 TDI	Diesel	81	08/97 → 05/04	CHASSIS: 1JX250001 →				
1.9 TDI	Diesel	85	12/98 → 06/01					
1.9 TDI	Diesel	85	12/98 → 06/01	CHASSIS: 1JX250001 →				
1.9 TDI	Diesel	96	11/00 → 06/05	CHASSIS: 1JX250001 →				
1.9 TDI	Diesel	74	09/00 → 12/01					
1.9 TDI	Diesel	66	10/97 → 04/99					
1.9 TDI	Diesel	81	08/97 → 04/99					
1.9 TDI 4motion	Diesel	110	02/00 → 06/05			AMM19752		B4
1.9 TDI 4motion	Diesel	96	11/00 → 06/05			AMM19752		B4
1.9 TDI 4motion	Diesel	110	09/00 → 06/05					
1.9 TDI 4motion	Diesel	66	07/98 → 04/02					
1.9 TDI 4motion	Diesel	74	09/00 → 11/02					
1.9 TDI 4motion	Diesel	74	12/02 → 06/05					
1.9 TDI 4motion	Diesel	85	09/99 → 06/01					
1.9 TDI 4motion	Diesel	96	04/01 → 05/04					
1.9 TDI 4motion	Diesel	110	02/00 → 06/05	CHASSIS: 1JX250001 →				
1.9 TDI 4motion	Diesel	66	07/98 → 04/02	CHASSIS: 1JX250001 →				
1.9 TDI 4motion	Diesel	74	09/00 → 06/05					
1.9 TDI 4motion	Diesel	74	09/00 → 06/05					
1.9 TDI 4motion	Diesel	85	09/99 → 06/01					
1.9 TDI 4motion	Diesel	85	09/99 → 06/01	CHASSIS: 1JX250001 →				
1.9 TDI 4motion	Diesel	96	11/00 → 06/05	CHASSIS: 1JX250001 →				
1.9 TDI 4motion	Diesel	66	07/98 → 04/99					



TYPE



TYPE



TYPE

			ATS23	F2		SAC084	H2			
			SPA109	F1		SAD031	H3			
			ATS19	F2						
			ATS18	F2		SAG178	H1		GA2124	J2
			SPA109	F1						
						SAG138	H1			
			ATS23	F2		SAG015	H2		ESS0073A	J1
			ATS23	F2		SAG015	H2		ESS0073A	J1
	APS39									
	APS39		ATS23	F2		SAG178	H1		ESS0073A	J1
	APS39									
	APS40									
	APS39									
	APS40									
	APS39									
	APS39									
	APS39									
			SPA109	F1						
			SPA109	F1						
			ATS23	F2		SAG015	H2		ESS0073A	J1
			SPA109	F1		SAG178	H1			
			ATS23	F2		SAG178	H1		ESS0073A	J1
			SPA109	F1						
			ATS23	F2		SAG015	H2		ESS0073A	J1
			SPA109	F1						
			SPA109	F1						
					SAA105					
						SAG138	H1			
						SAG138	H1			
			ATS23	F2		SAG015	H2		ESS0073A	J1
			ATS23	F2		SAG015	H2		ESS0073A	J1
	APS39									
	APS39		ATS23	F2		SAG178	H1		ESS0073A	J1
	APS39									
	APS40									
	APS39		ATS23	F2		SAG015	H2		ESS0073A	J1
	APS39									
			SPA109	F1						
			SPA109	F1						
			ATS23	F2		SAG015	H2		ESS0073A	J1
			SPA109	F1		SAG178	H1			
						SAG178	H1			
			SPA109	F1						
			SPA109	F1						
						SAG138	H1			



KW

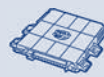

TYPE



TYPE

VOLKSWAGEN

GOLF IV (1J1)

2.0	Petrol	85	07/98 → 05/04						
2.0	Petrol	85	07/98 → 05/04	CHASSIS: 1JX250001 →					
2.0	Petrol	85	07/98 → 05/04						
2.0	Petrol	85	07/98 → 05/04						
2.0 4motion	Petrol	85	10/00 → 06/05						
2.0 4motion	Petrol	85	10/00 → 06/05	CHASSIS: 1JX250001 →					
2.0 4motion	Petrol	85	10/00 → 06/05						
2.0 4motion	Petrol	85	10/00 → 06/05						
2.3 V5	Petrol	110	08/97 → 10/00						
2.3 V5	Petrol	110	08/97 → 10/00	CHASSIS: 1JY000001 →					
2.3 V5	Petrol	110	10/97 → 10/00						
2.3 V5	Petrol	125	10/00 → 06/05						
2.3 V5	Petrol	125	10/00 → 06/05	CHASSIS: 1JY000001 →					
2.3 V5	Petrol	110	08/97 → 10/00						
2.3 V5	Petrol	125	10/00 → 06/05						
2.3 V5 4motion	Petrol	110	12/98 → 10/00						
2.3 V5 4motion	Petrol	110	12/98 → 10/00	CHASSIS: 1JY000001 →					
2.3 V5 4motion	Petrol	125	10/00 → 06/05						
2.3 V5 4motion	Petrol	125	10/00 → 06/05	CHASSIS: 1JY000001 →					
2.3 V5 4motion	Petrol	125	10/00 → 06/05						
2.8 V6 4motion	Petrol	150	03/99 → 06/05						
2.8 V6 4motion	Petrol	150	03/99 → 06/05	CHASSIS: 1JX250001 →					
2.8 V6 4motion	Petrol	150	03/99 → 06/05						
3.2 R32 4motion	Petrol	177	09/02 → 06/05						
3.2 R32 4motion	Petrol	177	09/02 → 06/05						

GOLF IV Cabriolet (1E7)

1.6	Petrol	74	06/98 → 06/02				AMM19672	B4	
1.6	Petrol	74	06/98 → 06/02						
1.6	Petrol	74	06/98 → 06/02	CHASSIS: 1EX000001 → 1EX015001					
1.8	Petrol	55	06/98 → 06/02						
1.8	Petrol	55	06/98 → 06/02	CHASSIS: 1EX000001 →					
1.8	Petrol	66	06/98 → 06/02	CHASSIS: 1EX000001 →					
1.8	Petrol	66	06/98 → 06/02						
1.9 TDI	Diesel	66	06/98 → 06/02						
1.9 TDI	Diesel	66	06/98 → 06/02						
1.9 TDI	Diesel	66	06/98 → 06/02	CHASSIS: → 1JX250000					
1.9 TDI	Diesel	81	06/98 → 06/02						
1.9 TDI	Diesel	81	06/98 → 06/02	CHASSIS: → 1JX250000					
2.0	Petrol	85	06/98 → 06/02				AMM19672	B4	
2.0	Petrol	85	06/98 → 06/02						
2.0	Petrol	85	06/98 → 06/02	CHASSIS: 1EX000001 → 1EX005000					



TYPE

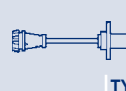

TYPE



TYPE

				ATS23	F2		SAC015	H2	BAE680AX	ESS0045A	J1
				SPA109	F1						
							SAC015-1	H2		GA2226	J2
							SAG018	H1			
				ATS23	F2		SAC015	H2			
				SPA109	F1						
							SAC015-1	H2			
							SAG018	H1			
				ATS23	F2		SAC040	H2		ESS0045A	J1
				SPA109	F1						
				ATS19	F2						
				ATS23	F2		SAC040	H2	BAE680S		
				SPA109	F1						
							SAG049	H1		GA2226	J2
							SAG065	H1			
				ATS19	F2		SAG049	H1			
				SPA109	F1						
				ATS23	F2		SAC040	H2			
				SPA109	F1						
							SAG065	H1			
				ATS23	F2		SAC040	H2	BAE680S		
				SPA109	F1						
							SAG065	H1			
				ATS23	F2		SAC040	H2			
				SPA109	F1						
				SPA110	F1		SAD021	H3		ESS0018A	J1
							SAG118	H1		GA2223	J2
						SAA104					
				SPA110	F1		SAG178	H1			
						SAA104					
						SAA104					
							SAG178	H1			
				ATS18	F2		SAG142	H1			
				SPA110	F1						
				SPA165	F1						
				ATS18	F2		SAG142	H1			
				SPA165	F1						
				ATS18	F2		SAD021	H3		ESS0018A	J1
							SAG118	H1		GA2223	J2
						SAA104					



KW



TYPE



TYPE

VOLKSWAGEN

GOLF IV Variant (1J5)

1.4 16V	Petrol	55	05/99 → 06/06					
1.4 16V	Petrol	55	05/99 → 06/06					
1.4 16V	Petrol	55	05/99 → 06/06	CHASSIS: 1JX250001 →				
1.4 16V	Petrol	55	05/99 → 06/06					
1.6	Petrol	74	05/99 → 02/00				AMM19670	B4
1.6	Petrol	75	08/00 → 06/06				AMM19670	B4
1.6	Petrol	74	05/99 → 04/02					
1.6	Petrol	74	05/99 → 04/02	CHASSIS: 1JX250001 →				
1.6	Petrol	75	08/00 → 06/06					
1.6	Petrol	75	08/00 → 06/06	CHASSIS: 1JX250001 →				
1.6	Petrol	74	05/99 → 04/02					
1.6	Petrol	74	05/99 → 04/02					
1.6	Petrol	75	08/00 → 06/06					
1.6 16V	Petrol	77	02/00 → 06/06					
1.6 16V	Petrol	77	02/00 → 06/06	CHASSIS: 1JX250001 →				
1.6 16V	Petrol	77	02/00 → 11/01					
1.6 16V	Petrol	77	02/00 → 06/06					
1.6 FSI	Petrol	81	01/02 → 06/06					
1.6 FSI	Petrol	81	01/02 → 06/06					
1.8 4motion	Petrol	92	05/99 → 06/06					
1.8 4motion	Petrol	92	05/99 → 06/06					
1.8 4motion	Petrol	92	05/99 → 10/00					
1.8 T	Petrol	110	05/00 → 05/03					
1.8 T	Petrol	110	05/00 → 06/06					
1.8 T	Petrol	110	05/00 → 06/06	CHASSIS: 1JX250001 →				
1.8 T	Petrol	110	05/00 → 09/02					
1.9 SDI	Diesel	50	05/99 → 06/06					
1.9 SDI	Diesel	50	05/99 → 06/06	CHASSIS: 1JX250001 →				
1.9 TDI	Diesel	96	11/00 → 06/06				AMM19752	B4
1.9 TDI	Diesel	66	05/99 → 05/06					
1.9 TDI	Diesel	74	09/00 → 11/02					
1.9 TDI	Diesel	74	05/01 → 06/06					
1.9 TDI	Diesel	81	05/99 → 06/01					
1.9 TDI	Diesel	85	08/99 → 06/01					
1.9 TDI	Diesel	96	04/01 → 06/06					
1.9 TDI	Diesel	66	05/99 → 05/06	CHASSIS: 1JX250001 →				
1.9 TDI	Diesel	74	09/00 → 06/06					
1.9 TDI	Diesel	74	09/00 → 06/06					
1.9 TDI	Diesel	81	05/99 → 06/01	CHASSIS: 1JX250001 →				
1.9 TDI	Diesel	85	08/99 → 06/01					
1.9 TDI	Diesel	85	08/99 → 06/01	CHASSIS: 1JX250001 →				
1.9 TDI	Diesel	96	11/00 → 06/06	CHASSIS: 1JX250001 →				
1.9 TDI 4motion	Diesel	96	11/00 → 06/06				AMM19752	B4
1.9 TDI 4motion	Diesel	66	05/99 → 04/02					



TYPE

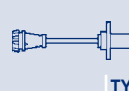

TYPE



TYPE

IWP058			ATS23	F2		SAC014	H2			
						SAD028	H3			
			SPA109	F1	SAA105					
						SAG178	H1			
			ATS23	F2		SAC015	H2			
			ATS23	F2		SAC015	H2			
			SPA109	F1						
						SAC015-1	H2			
			SPA109	F1						
						SAC015-1	H2			
						SAG018	H1			
						SAG178	H1			
			ATS23	F2		SAC014	H2			
			SPA109	F1	SAA105					
			ATS19	F2						
						SAD028	H3			
			ATS23	F2	SAA105	SAC011	H2			
			SPA109	F1						
			ATS23	F2		SAG018	H1			
			SPA109	F1						
			ATS19	F2		SAC084	H2			
	APS39					SAC084	H2			
			ATS23	F2		SAG018	H1			
			SPA109	F1						
			ATS19	F2						
			ATS18	F2		SAG178	H1			
			SPA109	F1						
			ATS23	F2		SAG015	H2		ESS0073A	J1
	APS39		ATS23	F2		SAG178	H1		ESS0073A	J1
	APS39									
	APS40									
	APS39		ATS23	F2		SAG178	H1		ESS0073A	J1
	APS39		ATS23	F2		SAG015	H2		ESS0073A	J1
	APS39									
			SPA109	F1						
			ATS23	F2		SAG015	H2		ESS0073A	J1
			SPA109	F1		SAG178	H1			
			SPA109	F1						
						SAG178	H1			
			SPA109	F1						
			SPA109	F1						
			ATS23	F2		SAG015	H2		ESS0073A	J1
	APS39		ATS23	F2		SAG178	H1		ESS0073A	J1



KW



TYPE



TYPE

VOLKSWAGEN

GOLF IV Variant (1J5)

1.9 TDI 4motion	Diesel	74	09/00 → 11/02						
1.9 TDI 4motion	Diesel	74	12/02 → 06/06						
1.9 TDI 4motion	Diesel	85	05/99 → 06/01						
1.9 TDI 4motion	Diesel	96	04/01 → 06/06						
1.9 TDI 4motion	Diesel	66	05/99 → 04/02	CHASSIS: 1JX250001 →					
1.9 TDI 4motion	Diesel	74	09/00 → 06/06						
1.9 TDI 4motion	Diesel	74	09/00 → 06/06						
1.9 TDI 4motion	Diesel	85	05/99 → 06/01						
1.9 TDI 4motion	Diesel	85	05/99 → 06/01	CHASSIS: 1JX250001 →					
1.9 TDI 4motion	Diesel	96	11/00 → 06/06	CHASSIS: 1JX250001 →					
2.0	Petrol	85	05/99 → 06/06						
2.0	Petrol	85	05/99 → 06/06	CHASSIS: 1JX250001 →					
2.0	Petrol	85	05/99 → 06/06						
2.0	Petrol	85	05/99 → 06/06						
2.0	Petrol	85	05/99 → 06/06						
2.0 4motion	Petrol	85	10/00 → 06/06						
2.0 4motion	Petrol	85	10/00 → 06/06	CHASSIS: 1JX250001 →					
2.0 4motion	Petrol	85	10/00 → 06/06						
2.0 4motion	Petrol	85	10/00 → 06/06						
2.0 4motion	Petrol	85	10/00 → 06/06						
2.0 Bi-Fuel	BiFuel	85	02/02 → 06/06						
2.0 Bi-Fuel	BiFuel	85	02/02 → 06/06						
2.3 V5	Petrol	110	05/99 → 06/06						
2.3 V5	Petrol	110	05/99 → 06/06	CHASSIS: 1JY000001 →					
2.3 V5	Petrol	110	05/99 → 02/01						
2.3 V5	Petrol	125	10/00 → 06/06						
2.3 V5	Petrol	125	10/00 → 06/06	CHASSIS: 1JY000001 →					
2.3 V5	Petrol	110	05/99 → 06/06						
2.3 V5	Petrol	125	10/00 → 06/06						
2.3 V5 4motion	Petrol	110	05/99 → 06/06						
2.3 V5 4motion	Petrol	110	05/99 → 06/06	CHASSIS: 1JY000001 →					
2.3 V5 4motion	Petrol	110	05/99 → 02/01						
2.3 V5 4motion	Petrol	125	10/00 → 06/06						
2.3 V5 4motion	Petrol	125	10/00 → 06/06	CHASSIS: 1JY000001 →					
2.3 V5 4motion	Petrol	125	10/00 → 06/06						
2.8 V6 4motion	Petrol	150	05/99 → 06/06						
2.8 V6 4motion	Petrol	150	05/99 → 06/06	CHASSIS: 1JY000001 →					
2.8 V6 4motion	Petrol	150	05/99 → 06/06						

GOLF PLUS (5M1, 521)

1.4 16V	Petrol	55	01/05 →						
1.4 16V	Petrol	55	01/05 →						
1.4 16V	Petrol	59	05/06 →						
1.4 16V	Petrol	55	01/05 →						
1.4 16V	Petrol	59	05/06 →						

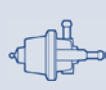

TYPE

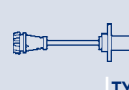

TYPE



TYPE

APS39

APS40

APS39

APS39

ATS23

F2

SAG015

H2

ESS0073A

J1

SPA109

F1

ATS23

F2

SAG015

H2

ESS0073A

J1

SPA109

F1

SAG178

H1

SAG178

H1

SPA109

F1

SPA109

F1

ATS23

F2

SAC015

H2

SPA109

F1

SAC015-1

H2

SAD028

H3

SAG018

H1

ATS23

F2

SAC015

H2

SPA109

F1

SAC015-1

H2

SAD028

H3

SAG018

H1

ATS23

F2

SAC015

H2

SPA109

F1

SAC015-1

H2

ATS23

F2

SAC040

H2

SPA109

F1

ATS19

F2

ATS23

F2

SAC040

H2

SPA109

F1

SAG049

H1

SAG065

H1

ATS23

F2

SAG049

H1

SPA109

F1

ATS19

F2

ATS23

F2

SAC040

H2

SPA109

F1

SAG065

H1

ATS23

F2

SAC040

H2

SPA109

F1

SAG065

H1

IWP163

SPA111

F1

SAA105

SAC014

H2

SAD031

H3

SPA111

F1

SAA105

SAC014

H2

SAG166

H1

SAD031

H3



KW

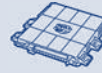

TYPE



TYPE

VOLKSWAGEN

GOLF PLUS (5M1, 521)

1.4 FSI	Petrol	66	07/05 →						
1.4 FSI	Petrol	66	07/05 →						
1.4 FSI	Petrol	66	07/05 →						
1.4 TSI	Petrol	103	05/06 → 06/08						
1.4 TSI	Petrol	118	06/08 →						
1.4 TSI	Petrol	125	05/06 → 06/08						
1.4 TSI	Petrol	90	06/07 →						
1.4 TSI	Petrol	103	05/06 → 06/08						
1.4 TSI	Petrol	118	06/08 →						
1.4 TSI	Petrol	125	05/06 → 06/08						
1.4 TSI	Petrol	90	06/07 →						
1.4 TSI	Petrol	90	06/07 →	CHASSIS: 1K8575001 →					
1.6	Petrol	75	05/05 →						
1.6	Petrol	75	05/05 →						
1.6 Bifuel	Petrol/LPG	75	05/09 →						
1.6 FSI	Petrol	85	01/05 → 05/08						
1.6 FSI	Petrol	85	01/05 → 05/08						
1.6 Multifuel	Petrol/Ethanol	75	11/07 →						
1.6 TDI	Diesel	66	02/09 →						
1.6 TDI	Diesel	66	02/09 →						
1.6 TDI	Diesel	77	03/09 →						
1.6 TDI	Diesel	77	03/09 →						
1.9 TDI	Diesel	66	05/05 → 12/08						
1.9 TDI	Diesel	77	01/05 → 05/05						
1.9 TDI	Diesel	77	01/05 → 01/09						
2.0 FSI	Petrol	110	05/05 → 06/08						
2.0 FSI	Petrol	110	05/05 → 06/08						
2.0 TDi	Diesel	100	05/05 →				AMM19752	B4	
2.0 TDi	Diesel	100	05/05 →						
2.0 TDi	Diesel	103	12/05 → 05/09						
2.0 TDi	Diesel	81	01/09 →						
2.0 TDi	Diesel	96	05/05 → 05/07						
2.0 TDi 16V	Diesel	103	01/05 →				AMM19752	B4	
2.0 TDi 16V	Diesel	103	01/05 →						

GOLF V (1K1)

1.4 16V	Petrol	55	10/03 → 05/06						
1.4 16V	Petrol	55	10/03 → 05/06						
1.4 16V	Petrol	59	05/06 → 11/08						
1.4 16V	Petrol	59	05/06 → 11/08						
1.4 FSI	Petrol	66	10/03 → 07/06						
1.4 FSI	Petrol	66	11/04 → 05/05						
1.4 FSI	Petrol	66	10/03 → 07/06						
1.4 FSI	Petrol	66	10/03 → 07/06						
1.4 TSI	Petrol	103	05/06 → 11/08						



TYPE



TYPE



TYPE

			SPA111	F1	SAA105	SAC011	H2	BAE680AU		
						SAD031	H3			
						SAG166	H1			
			SPA111	F1	SAA105	SAC011	H2			
			SPA111	F1	SAA105	SAC011	H2			
			SPA111	F1	SAA105	SAC011	H2			
			SPA111	F1	SAA105	SAC011	H2			
						SAG155	H1			
						SAG155	H1			
						SAG155	H1			
						SAG166	H1			
						SAG155	H1			
			SPA111	F1		SAC075	H2			
						SAD031	H3			
			SPA111	F1						
			SPA111	F1	SAA105	SAC011	H2	BAE680AU	GA2178	J2
						SAG166	H1			
			SPA111	F1						
			ATS16	F2	SAA105					
			SPA111	F1						
			ATS16	F2	SAA105					
			SPA111	F1						
	APS40		SPA111	F1		SAG166	H1		ESS0073A	J1
	APS40									
			SPA111	F1		SAG166	H1		ESS0073A	J1
			SPA111	F1		SAC073	H2	BAE680BB		
						SAD031	H3			
		SPS004	SPA111	F1		SAC085	H2		ESS0073A	J1
						SAG166	H1			
			SPA111	F1		SAG166	H1		ESS0073A	J1
			SPA111	F1					ESS0170A	J1
			SPA111	F1						
		SPS004	SPA111	F1		SAC085	H2		ESS0073A	J1
						SAG166	H1			
	IWP163		ATS13	F2	SAA105	SAC014	H2	BAE680AU		
			SPA111	F1		SAG166	H1			
			SPA111	F1	SAA105	SAC014	H2			
						SAD031	H3			
			SPA109	F1	SAA105	SAC011	H2			
			ATS13	F2						
						SAD031	H3			
						SAG166	H1			
			SPA111	F1	SAA105	SAC011	H2			



KW



TYPE



TYPE

VOLKSWAGEN

GOLF V (1K1)

1.4 TSI	Petrol	90	05/07 → 11/08					
1.4 TSI	Petrol	103	05/06 → 11/08					
1.4 TSI	Petrol	125	11/05 → 11/08					
1.4 TSI	Petrol	90	08/07 → 11/08					
1.4 TSI	Petrol	103	05/06 → 11/08					
1.4 TSI	Petrol	125	11/05 → 11/08					
1.4 TSI	Petrol	125	11/05 → 11/08					
1.6	Petrol	75	01/04 → 11/08					
1.6	Petrol	75	01/04 → 11/08					
1.6 FSI	Petrol	85	10/03 → 07/08					
1.6 FSI	Petrol	85	10/03 → 07/08					
1.6 FSI	Petrol	85	10/03 → 07/08					
1.6 Multifuel	Petrol/Ethanol	75	10/07 → 11/08					
1.9 TDI	Diesel	66	05/04 → 11/08					
1.9 TDI	Diesel	77	10/03 → 11/08					
1.9 TDI	Diesel	77	10/03 → 11/08					
1.9 TDI 4motion	Diesel	77	08/04 → 11/08					
2.0 FSI	Petrol	110	01/04 → 11/08					
2.0 FSI	Petrol	110	01/04 → 11/08					
2.0 FSI	Petrol	110	01/04 → 11/08					
2.0 FSI 4motion	Petrol	110	08/04 → 11/08					
2.0 FSI 4motion	Petrol	110	08/04 → 11/08					
2.0 FSI 4motion	Petrol	110	08/04 → 10/08					
2.0 GTI	Petrol	147	10/04 → 02/09					
2.0 GTI	Petrol	169	09/06 → 12/08					
2.0 GTI	Petrol	169	09/06 → 11/08					
2.0 SDI	Diesel	55	01/04 → 11/08					
2.0 TDi	Diesel	100	10/03 → 11/08				AMM19752	B4
2.0 TDi	Diesel	103	12/04 → 11/08				AMM19752	B4
2.0 TDi	Diesel	125	11/05 → 11/08				AMM19752	B4
2.0 TDi	Diesel	100	10/03 → 11/08					
2.0 TDi	Diesel	125	11/05 → 11/08					
2.0 TDI 16V	Diesel	103	10/03 → 11/08				AMM19752	B4
2.0 TDI 16V	Diesel	103	10/03 → 11/08					
2.0 TDI 16V 4motion	Diesel	103	08/04 → 11/08				AMM19752	B4
2.0 TDI 16V 4motion	Diesel	103	08/04 → 11/08					
2.0 TDI 4motion	Diesel	103	08/04 → 11/08				AMM19752	B4
3.2	Petrol	184	09/05 → 11/08					
3.2	Petrol	184	09/05 → 11/08					
3.2 R32 4motion	Petrol	184	11/05 → 11/08					
3.2 R32 4motion	Petrol	184	11/05 → 11/08					
3.2 R32 4motion	Petrol	184	11/05 → 11/08					

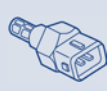
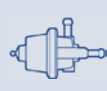

TYPE



TYPE



TYPE

				SPA111	F1		SAG155	H1			
							SAD031	H3			
						SAA105	SAC011	H2			
						SAA105	SAC011	H2			
							SAG155	H1			
							SAD031	H3			
							SAG155	H1			
				SPA109	F1		SAC075	H2			
							SAD031	H3			
				ATS13	F2	SAA105	SAC011	H2	BAE680AU	GA2178	J2
				SPA111	F1		SAD031	H3			
							SAG166	H1			
				SPA111	F1						
	APS40			SPA111	F1		SAG166	H1		ESS0073A	J1
	APS40			SPA111	F1		SAG166	H1		ESS0073A	J1
										GA2211	J2
	APS40			SPA111	F1		SAG166	H1		ESS0073A	J1
				ATS13	F2		SAC073	H2	BAE680BB		
				SPA111	F1		SAD031	H3			
							SAG100	H1			
				ATS13	F2		SAD031	H3			
				SPA111	F1		SAG100	H1			
									BAE680BB		
				SPA111	F1		SAC073	H2	BAE680BB		
				SPA111	F1						
									BAE680BB		
	APS40			SPA111	F1		SAG166	H1		ESS0073A	J1
				SPA111	F1		SAC085	H2		ESS0073A	J1
				SPA111	F1		SAG166	H1		ESS0073A	J1
				SPA111	F1		SAC085	H2		ESS0073A	J1
							SAG166	H1			
							SAG166	H1			
				SPA111	F1		SAC085	H2		ESS0073A	J1
							SAG166	H1			
				SPA111	F1		SAC085	H2		ESS0073A	J1
							SAG166	H1			
				SPA111	F1		SAG166	H1		ESS0073A	J1
				SPA111	F1		SAC011	H2			
							SAG065	H1			
				SPA111	F1		SAC011	H2	BAE680BC		
							SAD031	H3			
							SAG065	H1			



KW

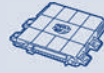

TYPE



TYPE

VOLKSWAGEN

GOLF V Variant (1K5)

1.4	Petrol	59	08/07 → 07/09						
1.4 TSI	Petrol	103	06/07 → 07/09						
1.4 TSI	Petrol	125	06/07 → 07/09						
1.4 TSI	Petrol	103	06/07 → 07/09						
1.4 TSI	Petrol	118	07/08 → 07/09						
1.4 TSI	Petrol	125	06/07 → 07/09						
1.4 TSI	Petrol	103	06/07 → 07/09	CHASSIS: 1K8326332 →					
1.4 TSI	Petrol	118	07/08 → 07/09						
1.4 TSI	Petrol	125	06/07 → 07/09	CHASSIS: 1K8326323 →					
1.4 TSI	Petrol	90	06/07 → 07/09						
1.9 TDI	Diesel	77	06/07 → 07/09						
1.9 TDI 4motion	Diesel	77	01/08 → 07/09						
2.0	Petrol	147	06/07 → 07/09						
2.0 TDi	Diesel	100	06/07 → 07/09				AMM19752		B4
2.0 TDi	Diesel	103	06/07 → 07/09				AMM19752		B4
2.0 TDi	Diesel	100	06/07 → 07/09						
2.0 TDi 16V	Diesel	103	06/07 → 07/09				AMM19752		B4
2.0 TDi 16V	Diesel	103	06/07 → 07/09						
2.0 TDi 4motion	Diesel	100	06/07 → 07/09						
2.0 TDi 4motion	Diesel	100	06/07 → 07/09						

GOLF VI (5K1)

1.2 TSI	Petrol	63	05/10 → 11/12						
1.2 TSI	Petrol	77	05/09 → 11/12						
1.4	Petrol	59	10/08 → 11/12						
1.4 TSI	Petrol	118	10/08 → 11/12						
1.4 TSI	Petrol	118	10/08 → 11/12						
1.4 TSI	Petrol	90	10/08 → 11/12						
1.6	Petrol	75	10/08 → 11/12						
1.6 Bifuel	Petrol/LPG	75	03/09 → 11/12						
1.6 Multifuel	Petrol/Ethanol	75	05/10 → 11/12						
1.6 TDI	Diesel	66	02/09 → 11/12						
1.6 TDI	Diesel	77	02/09 → 11/12						
1.8 TSI	Petrol	118	06/09 → 01/11						
2.0 GTI	Petrol	155	04/09 → 11/12						
2.0 GTI	Petrol	173	05/11 → 11/12						
2.0 R 4motion	Petrol	188	11/09 → 11/13						
2.0 R 4motion	Petrol	195	11/09 → 05/11						
2.0 R 4motion	Petrol	199	11/09 → 11/12						
2.0 R 4motion	Petrol	188	11/09 → 11/12						
2.0 TDi	Diesel	100	10/08 → 11/12						
2.0 TDi	Diesel	103	10/08 → 05/13						
2.0 TDi	Diesel	125	04/09 → 11/12						
2.0 TDi	Diesel	81	10/08 → 11/12						
2.0 TDi 4motion	Diesel	103	05/09 → 11/12						



TYPE

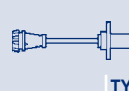

TYPE



TYPE

					SAA105	SAC014	H2			
				SPA111	F1	SAA105	SAC011	H2		
				SPA111	F1	SAA105	SAC011	H2		
							SAG166	H1		
					SAA105	SAC011	H2			
							SAG166	H1		
							SAG155	H1		
							SAG155	H1		
							SAG155	H1		
							SAC011	H2		
							SAG166	H1	ESS0073A	J1
							SAG166	H1		
									BAE680BB	
							SAC085	H2		
				SPA111	F1		SAG166	H1	ESS0073A	J1
							SAG166	H1		
							SAC085	H2	ESS0073A	J1
							SAG166	H1		
							SAC085	H2		
							SAG166	H1		
				SPA111	F1		SAC011	H2		
				SPA111	F1		SAC011	H2		
				SPA111	F1	SAA105	SAC011	H2		
				ATS16	F2	SAA105	SAC011	H2		
				SPA111	F1					
				SPA111	F1	SAA105	SAC011	H2		
				SPA111	F1					
				SPA111	F1					
				SPA111	F1	SAA105				
				SPA111	F1	SAA105				
				SPA111	F1				BAE680BB	
				SPA111	F1		SAG050	H1	BAE680BB	
									BAE680BB	
				SPA111	F1					
				SPA111	F1					
				SPA111	F1				BAE680BB	
									BAE680BB	
	SPS004			SPA111	F1	SAA105				
	SPS004			SPA111	F1		SAG155	H1		
	SPS004			SPA111	F1					
				SPA111	F1					
	SPS004			SPA111	F1					



KW



TYPE



TYPE

VOLKSWAGEN

GOLF VI Cabriolet (517)

1.2 TSI	Petrol	77	03/11 → 11/13
1.4 TSI	Petrol	118	03/11 →
1.4 TSI	Petrol	90	11/11 →
1.6 TDI	Diesel	77	03/11 →
2.0 GTI	Petrol	155	11/11 →
2.0 GTI	Petrol	155	05/12 →
2.0 TDi	Diesel	103	11/11 →

GOLF VI Variant (AJ5)

1.2 TSI	Petrol	77	08/09 → 07/13
1.4	Petrol	59	07/09 → 07/13
1.4 TSI	Petrol	90	07/09 → 07/13
1.4 TSI	Petrol	118	07/09 → 07/13
1.4 TSI	Petrol	118	07/09 → 12/11
2.0 TDI 16V	Diesel	103	07/09 → 07/13

JETTA I (16)

1.1	Petrol	37	08/78 → 07/82
1.1	Petrol	37	08/82 → 02/84
1.3	Petrol	44	08/79 → 07/82
1.3	Petrol	44	08/82 → 02/84
1.5	Petrol	51	08/78 → 07/82
1.5	Petrol	51	08/82 → 02/84
1.6	Petrol	63	08/78 → 07/82
1.6	Petrol	63	08/82 → 02/84
1.6	Petrol	55	08/82 → 07/83
1.6 D	Diesel	40	08/80 → 07/82
1.6 D	Diesel	40	08/82 → 02/84
1.6 GLI	Petrol	81	08/78 → 07/82
1.6 TD	Diesel	51	03/82 → 07/82
1.6 TD	Diesel	51	08/82 → 02/84

JETTA II (19E, 1G2, 165)

1.3	Petrol	40	01/84 → 06/87
1.3	Petrol	43	01/84 → 10/86
1.6	Petrol	51	01/89 → 10/91
1.6	Petrol	53	01/89 → 10/91
1.6	Petrol	55	01/89 → 07/92
1.6	Petrol	51	10/86 → 10/91
1.6	Petrol	53	03/86 → 10/91
1.6	Petrol	55	01/84 → 07/92
1.6 D	Diesel	40	01/89 → 10/91
1.6 D	Diesel	40	01/84 → 10/91
1.6 TD	Diesel	51	01/84 → 10/91
1.6 TD	Diesel	51	01/89 → 10/91
1.6 TD	Diesel	59	04/89 → 10/91
1.6 TD	Diesel	44	01/90 → 10/91



KW



TYPE



TYPE

VOLKSWAGEN

JETTA II (19E, 1G2, 165)

1.8	Petrol	62	01/89 → 01/90						
1.8	Petrol	62	08/86 → 01/90						
1.8	Petrol	79	08/85 → 10/87						
1.8	Petrol	82	01/84 → 10/91						
1.8 16V	Petrol	95	01/89 → 10/91						
1.8 16V	Petrol	102	06/87 → 12/89						
1.8 16V	Petrol	95	08/86 → 10/91						
1.8 Cat.	Petrol	79	01/89 → 10/91						
1.8 Cat.	Petrol	66	08/87 → 10/91						
1.8 Cat.	Petrol	79	01/87 → 10/91						
1.8 Syncro	Petrol	72	08/88 → 07/91						

JETTA III (1K2)

1.4 TSI	Petrol	103	07/06 → 10/10						
1.4 TSI	Petrol	118	07/08 → 10/10						
1.4 TSI	Petrol	125	07/06 → 10/10						
1.4 TSI	Petrol	90	05/07 → 10/10						
1.4 TSI	Petrol	118	07/08 → 10/10						
1.4 TSI	Petrol	90	07/07 → 10/10						
1.4 TSI	Petrol	103	07/06 → 06/08						
1.4 TSI	Petrol	90	05/07 → 12/07						
1.6	Petrol	75	10/05 → 10/10						
1.6 FSI	Petrol	85	09/05 → 10/10						
1.6 FSI	Petrol	85	09/05 → 10/10						
1.6 Multifuel	Petrol/Ethanol	75	01/08 → 10/10						
1.6 TDI	Diesel	66	12/09 → 10/10						
1.6 TDI	Diesel	77	06/09 → 10/10						
1.9 TDI	Diesel	77	08/05 → 10/10						
2.0 FSI	Petrol	110	08/05 → 10/10						
2.0 FSI	Petrol	110	08/05 → 10/10						
2.0 FSI	Petrol	110	08/05 → 06/08						
2.0 TDi	Diesel	100	09/05 → 10/10				AMM19752	B4	
2.0 TDi	Diesel	103	10/05 → 10/10				AMM19752	B4	
2.0 TDi	Diesel	125	10/06 → 10/10				AMM19752	B4	
2.0 TDi	Diesel	100	09/05 → 10/10						
2.0 TDi 16V	Diesel	103	08/05 → 10/10				AMM19752	B4	
2.0 TFSI	Petrol	147	10/05 → 10/10						
2.5 FSI	Petrol	110	01/06 → 10/10						
2.5 FSI	Petrol	125	07/08 → 10/10						
2.5 FSI	Petrol	110	01/06 → 06/08						

JETTA IV (162, 163)

1.4 TSI	Petrol	118	04/11 →						
1.4 TSI	Petrol	90	07/11 →						
1.4 TSI	Petrol	90	05/11 →						
2.0 TSI	Petrol	147	12/10 →						



TYPE

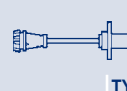

TYPE



TYPE

			SPA105	F1							
					SAA104						
									ESS0105A	J1	
					SAA104	SAD021	H3				
			SPA105	F1							
					SAA104						
					SAA104	SAD021	H3				
			SPA105	F1							
					SAA104	SAG178	H1				
					SAA104	SAD021	H3				
					SAA104						
			SPA111	F1	SAA105				BAE680AU		
			SPA111	F1	SAA105	SAC011	H2				
			SPA111	F1	SAA105	SAC011	H2		BAE680AU		
			SPA111	F1		SAG166	H1				
						SAG155	H1				
					SAA105						
						SAC011	H2				
						SAC011	H2				
			SPA111	F1		SAC075	H2				
			SPA111	F1	SAA105	SAC011	H2		BAE680AU		
						SAG166	H1				
			SPA111	F1							
			SPA111	F1							
			SPA111	F1							
	APS40		SPA111	F1		SAG166	H1			ESS0073A	J1
	APS70		SPA111	F1		SAC073	H2				
						SAG100	H1				
									BAE680BB		
			SPA111	F1		SAC085	H2			ESS0073A	J1
			SPA111	F1						ESS0073A	J1
			SPA111	F1						ESS0073A	J1
						SAG166	H1				
			SPA111	F1						ESS0073A	J1
			SPA111	F1		SAC073	H2		BAE680BB		
			SPA111	F1		SAG050	H1				
			SPA111	F1					BAE680BB		
									BAE680BB		
			SPA111	F1		SAC011	H2				
			SPA111	F1							
						SAC011	H2				
			SPA111	F1					BAE680BB		



KW



TYPE



TYPE

VOLKSWAGEN

KAEFER

1600 i (Mexico) Petrol 34 06/95 → 07/03

LT 28-35 I Furgonato (281-363)

2.4 i Petrol 69 03/94 → 06/96 CHASSIS: 21P000001 →

LT 28-35 I Pianale piatto/Telaio (281-363)

2.4 i Petrol 69 03/94 → 06/96 CHASSIS: 21P000001 →

LT 28-35 II Autobus (2DB, 2DE, 2DK)

2.3 Petrol 105 05/96 → 07/06

2.5 SDI Diesel 55 07/96 → 07/06

2.5 TDI Diesel 61 05/01 → 04/06

2.5 TDI Diesel 70 05/01 → 04/06

2.5 TDI Diesel 80 05/99 → 04/01

2.5 TDI Diesel 80 05/01 → 04/06

2.8 TDI Diesel 116 05/01 → 06/06 AMM19752 B4

2.8 TDI Diesel 92 02/97 → 12/98 AMM19752 B4

2.8 TDI Diesel 96 01/99 → 01/02 AMM19752 B4

LT 28-46 II Furgonato (2DA, 2DD, 2DH)

2.3 Petrol 105 05/96 → 07/06

2.5 SDI Diesel 55 09/96 → 07/06

2.5 TDI Diesel 61 05/01 → 04/06

2.5 TDI Diesel 70 05/01 → 04/06

2.5 TDI Diesel 80 05/99 → 04/01

2.5 TDI Diesel 80 05/01 → 04/06

2.8 TDI Diesel 116 04/02 → 07/06 AMM19752 B4

2.8 TDI Diesel 116 05/03 → 06/06 AMM19752 B4

2.8 TDI Diesel 92 06/97 → 12/98 AMM19752 B4

2.8 TDI Diesel 96 01/99 → 07/06 AMM19752 B4

2.8 TDI Diesel 116 06/03 → 04/06

LT 28-46 II Pianale piatto/Telaio (2DC, 2DF, 2DG, 2DL, 2DM)

2.3 Petrol 105 06/96 → 07/06

2.5 SDI Diesel 55 09/96 → 07/06

2.5 TDI Diesel 61 05/01 → 04/06

2.5 TDI Diesel 70 05/01 → 04/06

2.5 TDI Diesel 80 05/99 → 04/01

2.5 TDI Diesel 80 05/01 → 04/06

2.8 TDI Diesel 116 04/02 → 07/06 AMM19752 B4

2.8 TDI Diesel 92 06/97 → 12/98 AMM19752 B4

2.8 TDI Diesel 96 01/99 → 07/06 AMM19752 B4

2.8 TDI Diesel 116 06/03 → 04/06

LT 40-55 I Furgonato (291-512)

2.4 i Petrol 69 01/93 → 06/96 CHASSIS: 21P000001 →

LT 40-55 I Pianale piatto/Telaio (293-909)

2.4 i Petrol 69 03/94 → 06/96 CHASSIS: 21P000001 →

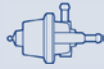

TYPE



TYPE



TYPE

SPA119 F1

SPA105 F1

SPA105 F1

ATS21 F2

ATS18 F2

APS40

APS40

APS39

APS40

ATS21 F2

ATS18 F2

APS40

APS40

APS39

APS40

APS39

ATS21 F2

ATS18 F2

APS40

APS40

APS39

APS40

APS39

SPA105 F1

SPA105 F1



KW



TYPE



TYPE

VOLKSWAGEN

LUPO (6X1, 6E1)

1.0	Petrol	37	09/98 → 07/05						
1.0	Petrol	37	09/98 → 07/05	CHASSIS: 6XY000001 →					
1.0	Petrol	37	10/98 → 05/00						
1.0	Petrol	37	09/98 → 07/05						
1.0	Petrol	37	09/98 → 07/05						
1.0	Petrol	37	09/98 → 07/00						
1.0	Petrol	37	01/99 → 07/05	ENGINE: AER-AHT-ALD-ALL-ANV-AUC					
1.2 TDI 3L	Diesel	45	07/99 → 10/02						
1.2 TDI 3L	Diesel	45	11/02 → 07/05						
1.2 TDI 3L	Diesel	45	07/99 → 07/05						
1.2 TDI 3L	Diesel	45	07/99 → 07/05						
1.4	Petrol	44	10/00 → 07/05						
1.4	Petrol	44	10/00 → 07/05						
1.4	Petrol	44	10/00 → 07/05						
1.4 16V	Petrol	55	09/98 → 07/05						
1.4 16V	Petrol	55	09/98 → 07/05						
1.4 16V	Petrol	55	09/98 → 07/05	CHASSIS: 6XY000001 →					
1.4 16V	Petrol	74	08/99 → 07/05						
1.4 16V	Petrol	74	08/99 → 07/05						
1.4 16V	Petrol	55	09/98 → 07/05						
1.4 16V	Petrol	74	08/99 → 07/05						
1.4 FSI	Petrol	77	02/01 → 07/05						
1.4 FSI	Petrol	77	02/01 → 07/05						
1.4 FSI	Petrol	77	02/01 → 07/05						
1.4 TDI	Diesel	55	01/99 → 10/02						
1.4 TDI	Diesel	55	11/02 → 07/05						
1.4 TDI	Diesel	55	01/99 → 07/05						
1.4 TDI	Diesel	55	01/99 → 07/05						
1.6 GTI	Petrol	92	09/00 → 07/05	ENGINE: AVY					
1.6 GTI	Petrol	92	09/00 → 07/05						
1.6 GTI	Petrol	92	09/00 → 07/05						
1.7 SDI	Diesel	44	09/98 → 07/05						
1.7 SDI	Diesel	44	09/98 → 07/05						

MULTIVAN V (7HM, 7HN, 7HF, 7EF, 7EM, 7EN)

1.9 TDI	Diesel	77	04/03 → 11/09						
1.9 TDI	Diesel	62	01/06 → 11/09						
1.9 TDI	Diesel	63	06/05 → 11/09						
1.9 TDI	Diesel	75	06/06 → 11/09						
2.0	Petrol	85	11/03 →						
2.0	Petrol	85	11/03 →						
2.0	Petrol	85	11/03 →						
2.0	Petrol	85	11/03 →						
2.0 BiTDI	Diesel	132	09/09 →						

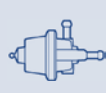

TYPE

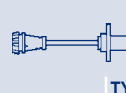

TYPE



TYPE

				ATS23	F2	SAA105	SAC011	H2	BAE680AA	ESS0045A	J1
				SPA109	F1						
				SPA110	F1		SAG178	H1			
							SAD028	H3		GA2226	J2
							SAG178	H1			
							SAG145	H1			
									BAE961AE		
		APS39									
		APS40									
				ATS23	F2		SAG134	H1			
				SPA109	F1						
				ATS23	F2	SAA105	SAC011	H2			
				SPA109	F1		SAD028	H3			
							SAG178	H1			
		IWP092		ATS23	F2	SAA105	SAC014	H2	BAE680AA	ESS0045A	J1
							SAD028	H3		GA2226	J2
				SPA109	F1						
				ATS23	F2	SAA105	SAC014	H2	BAE680AU	ESS0045A	J1
				SPA109	F1		SAD028	H3			
							SAG178	H1			
							SAG178	H1			
				ATS23	F2	SAA105	SAC011	H2			
				SPA109	F1		SAD031	H3			
							SAG178	H1			
		APS39									
		APS40									
				ATS23	F2		SAG134	H1			
				SPA109	F1						
		IWP091									
				ATS23	F2	SAA105	SAD028	H3	BAE680AA		
				SPA109	F1		SAG178	H1			
				ATS18	F2		SAG142	H1			
				SPA110	F1						
		APS40		SPA111	F1		SAG015	H2			
				SPA111	F1		SAG166	H1			
				SPA111	F1						
				SPA111	F1		SAG166	H1			
				SPA111	F1		SAC015	H2			
							SAC015-1	H2			
							SAD031	H3			
							SAG100	H1			
		APS70		SPA111	F1	SAA105				ESS0170A	J1



KW



TYPE



TYPE

VOLKSWAGEN

MULTIVAN V (7HM, 7HN, 7HF, 7EF, 7EM, 7EN)

2.0 BITDI 4motion	Diesel	132	09/09 →						
2.0 TDi	Diesel	103	09/09 →						
2.0 TDi	Diesel	62	09/09 →						
2.0 TDi	Diesel	75	09/09 →						
2.0 TDi	Diesel	100	05/10 →						
2.0 TDi	Diesel	103	09/09 →						
2.0 TDi	Diesel	62	09/09 →						
2.0 TDi	Diesel	75	09/09 →						
2.0 TDi	Diesel	84	05/11 →						
2.0 TDi	Diesel	103	09/09 → 05/11						
2.0 TDi	Diesel	62	09/09 → 05/11						
2.0 TDi	Diesel	75	09/09 → 05/11						
2.0 TDI 4motion	Diesel	103	09/09 →						
2.0 TDI 4motion	Diesel	100	05/10 →						
2.0 TDI 4motion	Diesel	103	09/09 →						
2.0 TDI 4motion	Diesel	103	09/09 → 05/11						
2.0 TSI	Petrol	150	05/11 →						
2.0 TSI	Petrol	110	07/12 →						
2.0 TSI 4motion	Petrol	150	07/11 →						
2.5 TDI	Diesel	120	11/03 → 11/09				AMM19752	B4	
2.5 TDI	Diesel	128	04/03 → 11/09				AMM19752	B4	
2.5 TDI	Diesel	96	04/03 → 11/09				AMM19752	B4	
2.5 TDI 4motion	Diesel	128	07/04 → 11/09				AMM19752	B4	
2.5 TDI 4motion	Diesel	96	07/04 → 11/09				AMM19752	B4	
3.2 V6	Petrol	170	02/04 → 06/04						
3.2 V6	Petrol	173	02/04 → 11/09						
3.2 V6	Petrol	170	02/04 → 06/04						
3.2 V6	Petrol	173	02/04 → 11/09						
3.2 V6 4motion	Petrol	173	07/04 → 11/09						
3.2 V6 4motion	Petrol	173	07/04 → 11/09						

NEW BEETLE (9C1, 1C1)

1.4	Petrol	55	11/01 → 09/10						
1.4	Petrol	55	11/01 → 09/10						
1.4	Petrol	55	11/01 → 09/10						
1.6	Petrol	75	06/00 → 09/10				AMM19670	B4	
1.6	Petrol	74	10/99 → 09/00						
1.6	Petrol	74	10/99 → 09/00	CHASSIS: 9CX919700 →					
1.6	Petrol	75	06/00 → 09/10						
1.6	Petrol	74	10/99 → 09/00						
1.8 T	Petrol	110	10/99 → 09/10						
1.8 T	Petrol	110	10/99 → 09/10						
1.8 T	Petrol	110	10/99 → 09/10	CHASSIS: 9CX919700 →					
1.8 T	Petrol	110	10/99 → 09/02						
1.8 T	Petrol	110	10/02 → 11/04						



TYPE



TYPE



TYPE

	APS70		SPA111	F1	SAA105				ESS0170A	J1
	APS70		ATS16	F2					ESS0170A	J1
	APS70		ATS16	F2					ESS0170A	J1
	APS70		ATS16	F2					ESS0170A	J1
			SPA111	F1	SAA105					
			SPA111	F1						
			SPA111	F1						
			SPA111	F1						
			SPA111	F1	SAA105				ESS0170A	J1
					SAA105					
					SAA105					
					SAA105					
	APS70		ATS16	F2					ESS0170A	J1
			SPA111	F1	SAA105					
			SPA111	F1						
					SAA105					
			SPA111	F1				BAE680BB		
								BAE680BB		
			SPA111	F1				BAE680BB		
			SPA111	F1						
			SPA111	F1		SAC040	H2			
			SPA111	F1		SAC040	H2			
						SAD031	H3			
						SAD031	H3			
			SPA111	F1		SAC040	H2			
						SAD031	H3			
			ATS23	F2	SAA105	SAC014	H2	BAE680AU		
			SPA109	F1		SAD031	H3			
						SAG178	H1			
			ATS23	F2		SAC075	H2		ESS0045A	J1
			ATS23	F2	SAA105	SAC015	H2	BAE680AA	ESS0016A	J1
			SPA109	F1						
			SPA109	F1		SAD031	H3		GA2226	J2
						SAC015-1	H2		GA2226	J2
	APS39		ATS23	F2		SAC084	H2	BAE680AW	ESS0016A	J1
						SAG018	H1		GA2226	J2
			SPA109	F1						
			ATS19	F2						
			ATS13	F2						



KW



TYPE



TYPE

VOLKSWAGEN

NEW BEETLE (9C1, 1C1)

1.8 T	Petrol	132	11/01 → 06/05						
1.8 T	Petrol	132	11/01 → 12/01						
1.8 T	Petrol	132	11/01 → 06/05						
1.9 TDI	Diesel	66	01/98 → 06/04						
1.9 TDI	Diesel	74	02/01 → 06/05						
1.9 TDI	Diesel	77	07/05 → 09/10						
1.9 TDI	Diesel	66	01/98 → 06/04	CHASSIS: 9CX919700 →					
1.9 TDI	Diesel	74	02/01 → 09/10						
1.9 TDI	Diesel	74	02/01 → 09/10						
1.9 TDI	Diesel	74	07/01 → 12/01						
1.9 TDI	Diesel	66	01/98 → 05/99						
1.9 TDI	Diesel	74	06/03 → 09/10						
2.0	Petrol	85	01/98 → 09/10						
2.0	Petrol	85	01/98 → 09/10	CHASSIS: 9CX919700 →					
2.0	Petrol	85	01/06 → 09/10						
2.0	Petrol	85	01/98 → 09/10						
2.0	Petrol	85	01/98 → 09/10						
2.0	Petrol	85	01/98 → 09/10	CHASSIS: → 9CX999000					
2.3 V5	Petrol	125	10/00 → 09/10						
2.3 V5	Petrol	125	10/00 → 09/10						
2.3 V5	Petrol	125	10/00 → 12/01						
2.5	Petrol	110	07/05 → 09/10						
2.5	Petrol	110	07/05 → 12/05						
2.5	Petrol	110	01/06 → 09/10						
RSI 3.2 4motion (1C9)	Petrol	165	04/00 → 05/01						
RSI 3.2 4motion (1C9)	Petrol	165	07/00 → 05/01						
RSI 3.2 4motion (1C9)	Petrol	165	04/00 → 05/01						

NEW BEETLE Cabriolet (1Y7)

1.4	Petrol	55	01/03 → 09/10						
1.4	Petrol	55	01/03 → 09/10						
1.6	Petrol	75	01/03 → 09/10						
1.6	Petrol	75	01/03 → 09/10						
1.8 T	Petrol	110	01/03 → 09/10						
1.8 T	Petrol	110	01/03 → 09/10						
1.9 TDI	Diesel	74	06/03 → 12/04						
1.9 TDI	Diesel	74	01/05 → 06/05						
1.9 TDI	Diesel	77	07/05 → 09/10						
1.9 TDI	Diesel	74	06/03 → 09/10						
1.9 TDI	Diesel	74	06/03 → 09/10						
1.9 TDI	Diesel	74	12/04 → 09/10						
2.0	Petrol	85	09/02 → 10/10						
2.0	Petrol	85	09/02 → 10/10						
2.0	Petrol	85	09/02 → 10/10						
2.5	Petrol	110	07/05 → 09/10						



TYPE

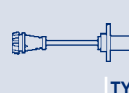

TYPE



TYPE

				SPA109	F1		SAC084	H2		
						SAA105				
							SAD031	H3		
		APS39		ATS23	F2		SAG178	H1	ESS0073A	J1
		APS40								
		APS39		SPA109	F1		SAG015	H2	ESS0073A	J1
				SPA109	F1					
				ATS23	F2		SAG178	H1	ESS0073A	J1
				SPA109	F1					
						SAA105				
							SAG138	H1		
							SAG015	H2		
				ATS23	F2		SAC015	H2	BAE680AX	ESS0016A
				SPA109	F1					
				SPA111	F1					
							SAC015-1	H2	GA2226	J2
							SAD031	H3		
							SAG018	H1		
				ATS23	F2		SAC040	H2	BAE680S	ESS0045A
				SPA109	F1		SAG065	H1	GA2226	J2
						SAA105				
		APS70					SAG050	H1	BAE680BB	
				SPA109	F1	SAA105				
				SPA111	F1					
				ATS23	F2		SAC040	H2		
				SPA109	F1	SAA105				
							SAD028	H3		
				ATS23	F2	SAA105	SAC014	H2	BAE680AU	
				SPA109	F1		SAG178	H1		
				ATS23	F2		SAC075	H2		
				SPA109	F1					
		APS39		ATS23	F2		SAC084	H2	BAE680AW	
				SPA109	F1		SAG018	H1		
		APS39								
		APS40								
		APS39		SPA109	F1		SAG015	H2	ESS0073A	J1
				ATS23	F2		SAG178	H1	ESS0073A	J1
				SPA109	F1					
							SAG015	H2		
		APS39		ATS23	F2		SAC015	H2	BAE680AX	
				SPA109	F1		SAC015-1	H2		
							SAG178	H1		
		APS70					SAG050	H1	BAE680BB	



KW



TYPE



TYPE

VOLKSWAGEN

NEW BEETLE Cabriolet (1Y7)

2.5	Petrol	110	07/05 → 12/05					
2.5	Petrol	110	01/06 → 09/10					

PARATI

1.6	Petrol	65	01/97 → 07/99					
1.6	Petrol	73	01/97 → 07/99					
1.8	Petrol	72	05/96 → 07/02					
2.0	Petrol	85	01/97 → 07/99					

PASSAT (32)

1.3	Petrol	40	08/78 → 07/80					
1.5 D	Diesel	37	08/78 → 07/80					
1.6	Petrol	63	08/78 → 07/80					

PASSAT (32B)

1.3	Petrol	40	08/80 → 07/82					
1.3	Petrol	40	08/82 → 07/83					
1.3	Petrol	44	08/80 → 07/82					
1.3	Petrol	44	08/80 → 07/82					
1.3	Petrol	44	08/82 → 07/86					
1.3	Petrol	44	08/82 → 07/86					
1.6	Petrol	51	08/87 → 03/88	CHASSIS: 32J000001 →				
1.6	Petrol	53	01/88 → 03/88	CHASSIS: 32J000001 →				
1.6	Petrol	55	01/86 → 03/88	CHASSIS: 32J000001 →				
1.6	Petrol	51	08/87 → 03/88					
1.6	Petrol	53	02/86 → 03/88					
1.6	Petrol	55	08/80 → 07/82					
1.6	Petrol	55	08/82 → 03/88					
1.6	Petrol	63	01/81 → 07/82					
1.6	Petrol	63	08/82 → 02/83					
1.6 D	Diesel	40	01/86 → 03/88	CHASSIS: 32J000001 →				
1.6 TD	Diesel	51	01/86 → 03/88	CHASSIS: 32J000001 →				
1.8	Petrol	66	01/86 → 03/88	CHASSIS: 32J000001 →				
1.8	Petrol	64	05/86 → 03/88					
1.8	Petrol	66	01/83 → 03/88					
1.8	Petrol	82	12/83 → 03/88					
1.9	Petrol	85	01/81 → 07/82					
1.9	Petrol	85	08/82 → 07/83					
2.0	Petrol	85	08/83 → 03/88					
2.2	Petrol	100	01/85 → 03/88					
2.2	Petrol	85	08/85 → 03/88					

PASSAT (362)

1.4 TSI	Petrol	90	08/10 →					
1.4 TSI EcoFuel	Petrol/CNG	110	09/10 →					
1.4 TSI EcoFuel	Petrol/CNG	110	08/10 →					
1.4 TSI MultiFuel	Petrol/Ethanol	118	11/10 →					
1.6 TDI	Diesel	77	08/10 →					



KW



TYPE



TYPE

VOLKSWAGEN

PASSAT (362)

1.8 TSI	Petrol	112	02/11 →					
1.8 TSI	Petrol	118	08/10 →					
2.0 TDi	Diesel	100	08/10 →					
2.0 TDi	Diesel	103	08/10 →					
2.0 TDi	Diesel	125	08/10 →					
2.0 TDi 4motion	Diesel	103	08/10 →					
2.0 TDi 4motion	Diesel	125	08/10 →					
2.0 TSI	Petrol	155	11/10 →					

PASSAT (3A2, 35I)

1.6	Petrol	74	12/95 → 08/96				AMM19672	B4
1.6	Petrol	53	02/88 → 09/91					
1.6	Petrol	53	08/88 → 07/90					
1.6	Petrol	55	02/88 → 12/88					
1.6	Petrol	74	10/94 → 08/96					
1.6	Petrol	53	02/88 → 09/91					
1.6	Petrol	55	02/88 → 12/88					
1.6	Petrol	74	10/94 → 08/96					
1.6	Petrol	74	07/95 → 08/96					
1.6 TD	Diesel	59	08/88 → 09/93					
1.6 TD	Diesel	59	08/92 → 09/93					
1.6 TD	Diesel	59	08/88 → 09/93					
1.8	Petrol	55	08/90 → 08/96					
1.8	Petrol	55	08/90 → 12/91					
1.8	Petrol	55	08/92 → 08/96					
1.8	Petrol	66	02/88 → 08/96					
1.8	Petrol	66	02/88 → 12/93					
1.8	Petrol	66	04/88 → 09/94					
1.8	Petrol	79	04/88 → 07/93					
1.8	Petrol	82	04/88 → 07/92					
1.8	Petrol	55	08/90 → 08/96					
1.8	Petrol	66	02/88 → 08/96					
1.8	Petrol	79	04/88 → 07/93					
1.8	Petrol	82	04/88 → 07/92					
1.8	Petrol	55	09/91 → 08/96					
1.8	Petrol	55	02/92 → 08/96					
1.8	Petrol	66	02/92 → 08/96					
1.8 G60 Syncro	Petrol	118	08/88 → 08/96					
1.8 G60 Syncro	Petrol	118	08/88 → 08/96					
1.8 GL	Petrol	102	08/91 → 09/93					
1.9 D	Diesel	50	05/89 → 10/93					
1.9 D	Diesel	50	08/92 → 10/93					
1.9 TD	Diesel	55	03/91 → 08/96					
1.9 TD	Diesel	55	08/92 → 09/93					
1.9 TD	Diesel	55	03/91 → 10/93					



KW

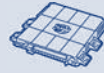

TYPE



TYPE

VOLKSWAGEN

PASSAT (3A2, 35I)

1.9 TDI	Diesel	66	10/93 → 09/94						
1.9 TDI	Diesel	66	10/93 → 08/96						
1.9 TDI	Diesel	81	03/96 → 08/96						
2.0	Petrol	79	03/95 → 08/96				AMM19672	B4	
2.0	Petrol	85	10/94 → 08/96				AMM19672	B4	
2.0	Petrol	79	03/95 → 08/96						
2.0	Petrol	85	02/90 → 08/96						
2.0	Petrol	85	02/90 → 08/96						
2.0	Petrol	85	02/90 → 12/93						
2.0	Petrol	79	07/95 → 08/96						
2.0	Petrol	85	07/95 → 08/96						
2.0	Petrol	85	09/91 → 08/96						
2.0 16V	Petrol	100	08/88 → 09/93						
2.0 16V	Petrol	100	08/88 → 12/91						
2.0 16V	Petrol	100	08/92 → 09/93						
2.0 16V	Petrol	110	01/94 → 08/96						
2.0 16V	Petrol	110	01/94 → 08/96						
2.0 16V	Petrol	100	08/88 → 09/93						
2.0 16V	Petrol	110	07/95 → 08/96						
2.8 VR6	Petrol	128	10/91 → 08/96						
2.8 VR6	Petrol	128	06/91 → 08/96						

PASSAT (3B2)

1.8	Petrol	85	01/97 → 11/00						
1.8	Petrol	85	01/97 → 11/00	CHASSIS: 3BY000001 →					
1.8 Syncro/4motion	Petrol	92	10/96 → 01/99				AMM19666	B4	
1.8 Syncro/4motion	Petrol	92	10/96 → 11/00	CHASSIS: 3BY000001 →					
1.8 Syncro/4motion	Petrol	92	06/97 → 11/00						
1.8 Syncro/4motion	Petrol	92	10/96 → 11/00						
1.8 Syncro/4motion	Petrol	92	10/96 → 11/00						
1.8 Syncro/4motion	Petrol	92	10/96 → 11/00						
1.8 T Syncro	Petrol	110	11/96 → 08/00	CHASSIS: 3BY000001 →					
1.9 TDI	Diesel	85	08/98 → 11/00						
1.9 TDI	Diesel	74	02/00 → 11/00						
1.9 TDI	Diesel	85	08/98 → 11/00	CHASSIS: → 3BX600000					
1.9 TDI	Diesel	85	05/99 → 11/00	CHASSIS: 3BY000001 →					
1.9 TDI 4motion	Diesel	85	08/99 → 11/00						
1.9 TDI Syncro/4motion	Diesel	81	10/96 → 11/00						
1.9 TDI Syncro/4motion	Diesel	81	10/96 → 11/00	CHASSIS: → 3BX600000					
2.0	Petrol	88	04/00 → 11/00	CHASSIS: 3BY000001 →					
2.0	Petrol	88	04/00 → 11/00						
2.0 4motion	Petrol	88	04/00 → 11/00	CHASSIS: 3BY000001 →					
2.3 VR5 Syncro/4motion	Petrol	110	10/97 → 11/00	CHASSIS: → 3BX600000					
2.3 VR5 Syncro/4motion	Petrol	110	05/99 → 11/00	CHASSIS: 3BY000001 →					
2.3 VR5 Syncro/4motion	Petrol	110	09/98 → 11/00						



TYPE

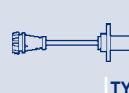

TYPE



TYPE

APPS										
APPS	Model	Type	Part Number	Part Number	Type	Part Number	Part Number	Type	Part Number	
APPS29	SPA105	F1		SAG142	H1					
	SPA105	F1		SAG142	H1					
	ATS18	F2	SAA104							
	SPA105	F1								
	ATS18	F2	SAA102	SAG178	H1		ESS0018A	J1		
	SPA105	F1	SAA104				GA2223	J2		
	SPA106	F1								
					SAG118	H1				
					SAG118	H1				
					SAG026	H1				
	SPA143	F1	SAA102	SAD019	H3		GA2032	J2		
	SPA106	F1								
	SPA110	F1								
	ATS18	F2	SAA104				ESS0018A	J1		
	SPA105	F1					GA2223	J2		
			SAA104	SAG178	H1					
				SAG118	H1					
IWP022	SPA105	F1		SAG026	H1					
	ATS19	F2		SAG127	H1	BAE680AQ				
	SPA109	F1								
	SPA109	F1								
	ATS19	F2				BAE680AQ				
					SAC084	H2		ESS0072A	J1	
					SAD019	H3				
					SAG127	H1				
	SPA109	F1								
	APPS39				SAG178	H1				
		SPA109	F1							
		SPA165	F1							
		SPA109	F1							
		APPS39	SPA109	F1		SAG178	H1			
		APPS39				SAG142	H1			
		SPA165	F1							
		SPA109	F1							
							BAE680AA			
		SPA109	F1							
		SPA165	F1							
		SPA109	F1							
		ATS19	F2							



KW

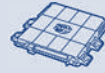

TYPE



TYPE

VOLKSWAGEN

PASSAT (3B2)

2.3 VR5 Syncro/4motion	Petrol	110	10/97 → 11/00						
2.3 VR5 Syncro/4motion	Petrol	110	10/97 → 11/00						
2.5 TDI	Diesel	110	07/98 → 11/00						
2.5 TDI	Diesel	110	07/98 → 11/00	CHASSIS: 3BY000001 →					
2.5 TDI Syncro/4motion	Diesel	110	12/98 → 11/00						
2.5 TDI Syncro/4motion	Diesel	110	12/98 → 11/00	CHASSIS: 3BY000001 →					
2.5 TDI Syncro/4motion	Diesel	110	12/98 → 04/99						
2.5 TDI Syncro/4motion	Diesel	110	08/99 → 11/00						
2.8 V6	Petrol	132	05/97 → 09/99						
2.8 V6	Petrol	132	05/97 → 09/99	CHASSIS: → 3BX600000					
2.8 V6	Petrol	132	05/99 → 09/99						
2.8 V6	Petrol	140	09/99 → 11/00						
2.8 V6	Petrol	132	05/97 → 09/99						
2.8 V6	Petrol	140	09/99 → 11/00						

PASSAT (3B3)

1.6	Petrol	75	11/00 → 05/05				AMM19670	B4	
1.6	Petrol	75	11/00 → 05/05						
1.6	Petrol	75	11/00 → 05/05	CHASSIS: → 3B2240126					
1.6	Petrol	75	11/00 → 05/05	CHASSIS: → 3B2240126					
1.8	Petrol	92	03/03 → 03/05						
1.8 T	Petrol	125	02/01 → 02/03						
1.8 T	Petrol	125	02/01 → 05/05						
1.8 T	Petrol	125	02/01 → 05/05						
1.8 T 20V	Petrol	110	11/00 → 02/03						
1.8 T 20V	Petrol	110	11/00 → 05/05						
1.8 T 20V	Petrol	110	11/00 → 05/05						
1.8 T 20V	Petrol	110	11/00 → 05/03						
1.9 TDI	Diesel	96	11/00 → 05/05				AMM19752	B4	
1.9 TDI	Diesel	74	11/00 → 10/01						
1.9 TDI	Diesel	74	11/01 → 05/05						
1.9 TDI	Diesel	74	11/00 → 05/05						
1.9 TDI 4motion	Diesel	96	11/00 → 05/05				AMM19752	B4	
2.0	Petrol	85	11/00 → 05/05				AMM19670	B4	
2.0	Petrol	85	11/00 → 05/05						
2.0	Petrol	96	11/01 → 05/05						
2.0	Petrol	96	11/01 → 05/05						
2.0	Petrol	85	11/00 → 03/05						
2.0 4motion	Petrol	85	11/00 → 05/05				AMM19670	B4	
2.0 4motion	Petrol	85	11/00 → 05/05						
2.0 4motion	Petrol	85	11/00 → 05/05						
2.0 TDi	Diesel	100	12/03 → 05/05				AMM19752	B4	
2.3 V5	Petrol	125	11/00 → 05/05						
2.3 V5	Petrol	125	11/00 → 03/05						
2.3 V5	Petrol	125	11/00 → 05/05						



TYPE

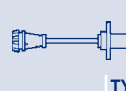

TYPE



TYPE

						SAC040	H2		ESS0072A	J1
						SAG038	H1			
	APS39		SGA115	F3		SAG017	H1			
			SPA109	F1						
	APS39		SGA115	F3						
			SPA109	F1						
						SAG096	H1			
						SAG017	H1			
			ATS19	F2		SAC084	H2			
			SPA165	F1						
			SPA109	F1						
			SPA109	F1		SAC084	H2			
						SAG018	H1			
						SAG018	H1			
			SPA109	F1		SAG017	H1		ESS0016A	J1
									GA2171	J2
						SAC015	H2			
						SAC015-1	H2			
			SPA109	F1						
	APS39		ATS19	F2						
			SPA109	F1						
	APS39		ATS19	F2		SAC084	H2	BAE680AW	ESS0016A	J1
			SPA109	F1					GA2171	J2
						SAG017	H1			
			SPA109	F1						
	APS39									
	APS40									
			SPA109	F1					ESS0020A	J1
			SPA109	F1						
			SPA109	F1					ESS0016A	J1
									GA2171	J2
			ATS13	F2		SAC084	H2	BAE680AW	ESS0016A	J1
			SPA109	F1		SAG017	H1		GA2171	J2
						SAG018	H1			
			SPA109	F1		SAC015	H2		ESS0072A	J1
						SAC015-1	H2		GA2171	J2
						SAG018	H1			
			SPA109	F1						
			SPA109	F1		SAC040	H2		ESS0016A	J1
			SPA111	F1						
						SAG049	H1		GA2171	J2



KW

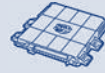

TYPE



TYPE

VOLKSWAGEN

PASSAT (3B3)

2.3 V5 4motion	Petrol	125	11/00 → 05/05					
2.3 V5 4motion	Petrol	125	01/01 → 05/05					
2.3 V5 4motion	Petrol	125	11/00 → 05/05					
2.5 TDI	Diesel	110	11/00 → 05/05				AMM19769	B4
2.5 TDI	Diesel	120	05/03 → 05/05				AMM19769	B4
2.5 TDI	Diesel	110	11/00 → 05/03					
2.5 TDI	Diesel	110	11/00 → 05/05	CHASSIS: 3BY000001 →				
2.5 TDI 4motion	Diesel	110	11/00 → 05/05				AMM19769	B4
2.5 TDI 4motion	Diesel	132	01/03 → 05/05				AMM19769	B4
2.5 TDI 4motion	Diesel	110	11/00 → 01/03					
2.5 TDI 4motion	Diesel	110	11/00 → 05/05	CHASSIS: 3BY000001 →				
2.5 TDI 4motion	Diesel	110	11/00 → 05/03					
2.8 4motion	Petrol	142	11/00 → 05/05				AMM19671	B4
2.8 4motion	Petrol	142	11/00 → 05/05					
4.0 W8 4motion	Petrol	202	09/01 → 09/04					

PASSAT (3C2)

1.4 TSI	Petrol	90	05/07 → 07/10					
1.4 TSI	Petrol	90	05/07 → 07/10					
1.4 TSI EcoFuel	BiFuel	110	01/09 → 07/10					
1.4 TSI EcoFuel	BiFuel	110	01/09 → 07/10					
1.6	Petrol	75	05/05 → 07/10					
1.6	Petrol	75	05/05 → 07/10					
1.6 FSI	Petrol	85	03/05 → 06/08					
1.6 FSI	Petrol	85	03/05 → 06/08					
1.6 FSI	Petrol	85	03/05 → 06/08					
1.6 TDI	Diesel	77	08/09 → 07/10					
1.8 TSI	Petrol	112	11/09 → 07/10					
1.8 TSI	Petrol	118	05/07 → 07/10					
1.8 TSI	Petrol	112	11/09 → 05/10					
1.8 TSI	Petrol	118	05/08 → 07/10					
1.9 TDI	Diesel	77	03/05 → 11/08					
1.9 TDI	Diesel	77	03/05 → 11/08					
2.0 BlueTDI	Diesel	105	01/09 → 11/10					
2.0 FSI	Petrol	110	03/05 → 07/10					
2.0 FSI	Petrol	125	08/07 → 07/10					
2.0 FSI	Petrol	147	07/05 → 07/10					
2.0 FSI	Petrol	110	03/05 → 07/10					
2.0 FSI	Petrol	110	03/05 → 07/10					
2.0 FSI 4motion	Petrol	110	09/05 → 07/10					
2.0 FSI 4motion	Petrol	110	09/05 → 07/10					
2.0 TDi	Diesel	100	03/05 → 11/10				AMM19752	B4
2.0 TDi	Diesel	103	03/05 → 05/09				AMM19752	B4
2.0 TDi	Diesel	120	08/05 → 05/09				AMM19752	B4
2.0 TDi	Diesel	125	08/05 → 07/10				AMM19752	B4

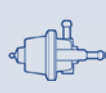

TYPE

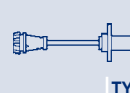

TYPE



TYPE

				SPA109	F1		SAC040	H2		ESS0072A	J1
				SPA111	F1						
							SAG049	H1		GA2171	J2
				SGA115	F3						
	APS40			SPA109	F1		SAG017	H1			
	APS39						SAG017	H1			
				SPA109	F1						
				SGA115	F3						
	APS40			SPA109	F1		SAG017	H1			
	APS39										
				SPA109	F1						
							SAG017	H1			
				ATS19	F2		SAC084	H2		ESS0072A	J1
				SPA109	F1		SAG018	H1		GA2171	J2
				SPA111	F1		SAC040	H2		GA2171	J2
				SPA111	F1	SAA105	SAC011	H2			
							SAG155	H1			
				SPA111	F1	SAA105	SAC011	H2			
							SAG155	H1			
				SPA111	F1		SAC075	H2			
							SAD031	H3			
				SPA111	F1	SAA105	SAC011	H2	BAE680AU		
							SAD031	H3			
							SAG166	H1			
				SPA111	F1	SAA105					
				SPA111	F1						
				SPA111	F1						
									BAE680BB		
									BAE680BB		
	APS40			SPA111	F1		SAG166	H1		ESS0073A	J1
										GA2156	J2
				SPA111	F1		SAG155	H1		ESS0075A	J1
				SPA111	F1		SAC073	H2	BAE680BB		
				SPA111	F1				BAE680BB		
				SPA111	F1				BAE680BB		
							SAD031	H3			
							SAG100	H1			
	APS70			SPA111	F1		SAD031	H3	BAE680BB		
							SAG100	H1			
				SPA111	F1		SAC085	H2		ESS0075A	J1
				SPA111	F1		SAG166	H1		ESS0073A	J1
				SPA111	F1						
				SPA111	F1		SAC085	H2		ESS0073A	J1



KW



TYPE



TYPE

VOLKSWAGEN

PASSAT (3C2)

2.0 TDi	Diesel	88	11/05 → 05/06					AMM19752	B4
2.0 TDi	Diesel	90	08/05 → 07/06					AMM19752	B4
2.0 TDi	Diesel	100	03/05 → 11/10						
2.0 TDi	Diesel	103	03/05 → 05/09						
2.0 TDi	Diesel	125	08/05 → 07/10						
2.0 TDi	Diesel	81	11/08 → 07/10						
2.0 TDi	Diesel	88	11/05 → 05/07						
2.0 TDi	Diesel	100	03/05 → 11/10						
2.0 TDI 16V	Diesel	103	03/05 → 07/10					AMM19752	B4
2.0 TDI 16V	Diesel	103	03/05 → 07/10						
2.0 TDI 16V 4motion	Diesel	103	03/05 → 08/10					AMM19752	B4
2.0 TDI 16V 4motion	Diesel	103	03/05 → 08/10						
2.0 TDI 4motion	Diesel	103	03/05 → 05/09					AMM19752	B4
2.0 TDI 4motion	Diesel	103	03/05 → 05/09						
2.0 TDI 4motion	Diesel	125	05/09 → 11/10						
2.0 TDI 4motion	Diesel	125	05/09 → 07/10						
3.2 FSI 4motion	Petrol	184	11/05 → 07/10						
3.2 FSI 4motion	Petrol	184	11/05 → 07/10						
3.2 FSI 4motion	Petrol	184	11/05 → 07/10						
3.6 R36 4motion	Petrol	220	04/07 → 07/10						
3.6 R36 4motion	Petrol	220	04/07 → 07/10						

PASSAT ALLTRACK (365)

2.0 TSI 4motion	Petrol	155	01/12 →						
-----------------	--------	-----	---------	--	--	--	--	--	--

PASSAT CC (357)

1.4 TSI MultiFuel	Petrol/Ethanol	118	01/11 → 01/12						
1.8 TSI	Petrol	112	11/08 → 05/10						
1.8 TSI	Petrol	118	06/08 → 11/10						
1.8 TSI	Petrol	112	11/09 → 05/10						
2.0 BlueTDI	Diesel	105	05/09 → 11/10						
2.0 TDi	Diesel	100	06/08 → 05/11						
2.0 TDi	Diesel	103	06/08 → 01/12						
2.0 TDi	Diesel	125	06/08 → 01/12						
2.0 TDi	Diesel	125	08/08 → 01/12						
2.0 TDI 4motion	Diesel	103	08/09 → 01/12						
2.0 TDI 4motion	Diesel	125	11/09 → 01/12						
2.0 TSI	Petrol	147	06/08 → 01/12						
2.0 TSI	Petrol	155	11/10 → 01/12						
2.0 TSI	Petrol	155	11/10 → 05/12						
3.6 FSI 4motion	Petrol	220	06/08 → 05/10						
3.6 FSI 4motion	Petrol	220	06/08 → 05/10						

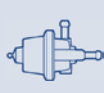

TYPE

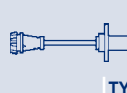

TYPE



TYPE

				SPA111	F1						
							SAG155	H1			
										GA2156	J2
							SAG166	H1			
				SPA111	F1		SAG155	H1		ESS0075A	J1
				SPA111	F1					ESS0075A	J1
							SAG166	H1			
				SPA111	F1		SAC085	H2		ESS0075A	J1
							SAG166	H1		GA2186	J2
	APS70			SPA111	F1		SAC085	H2		ESS0075A	J1
							SAG166	H1		GA2186	J2
	APS70			SPA111	F1		SAG166	H1		ESS0073A	J1
										GA2048	J2
				SPA111	F1						
										ESS0075A	J1
	APS70			SPA111	F1		SAC011	H2			
							SAD031	H3			
							SAG065	H1			
	APS70			SPA111	F1		SAC011	H2			
							SAG065	H1			
				SPA111	F1					BAE680BB	
				SPA111	F1		SAC011	H2			
				SPA111	F1					BAE680BB	
				SPA111	F1					BAE680BB	
				SPA111	F1					ESS0075A	J1
				SPA111	F1	SAA105	SAG155	H1		ESS0075A	J1
				SPA111	F1	SAA105	SAG155	H1		ESS0075A	J1
				SPA111	F1		SAG155	H1		ESS0075A	J1
						SAA105					
				SPA111	F1	SAA105				ESS0075A	J1
				SPA111	F1	SAA105				ESS0075A	J1
				SPA111	F1					BAE680BB	
				SPA111	F1						
										BAE680BB	
				SPA111	F1		SAC011	H2			
							SAG065	H1			



KW

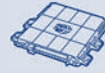

TYPE



TYPE

VOLKSWAGEN

PASSAT Tre volumi (32B)

1.6	Petrol	53	01/88 → 03/88	CHASSIS: 32J000001 →					
1.6	Petrol	55	01/86 → 03/88	CHASSIS: 32J000001 →					
1.6	Petrol	53	01/85 → 03/88						
1.6	Petrol	55	01/85 → 03/88						
1.6 TD	Diesel	51	01/86 → 03/88	CHASSIS: 32J000001 →					
1.6 TD	Diesel	51	01/85 → 03/88						
1.8	Petrol	66	01/86 → 03/88	CHASSIS: 32J000001 →					
1.8	Petrol	66	01/85 → 03/88						
2.2	Petrol	85	01/85 → 03/88						

PASSAT Variant (32B)

1.3	Petrol	40	08/80 → 07/82						
1.3	Petrol	40	08/82 → 07/83						
1.3	Petrol	44	08/80 → 07/82						
1.3	Petrol	44	08/80 → 07/82						
1.3	Petrol	44	08/82 → 07/86						
1.3	Petrol	44	08/82 → 07/86						
1.6	Petrol	51	08/87 → 03/88	CHASSIS: 32J000001 →					
1.6	Petrol	53	02/86 → 03/88	CHASSIS: 32J000001 →					
1.6	Petrol	55	08/80 → 03/88	CHASSIS: 32J000001 →					
1.6	Petrol	51	08/87 → 03/88						
1.6	Petrol	53	02/86 → 03/88						
1.6	Petrol	55	08/80 → 07/82						
1.6	Petrol	55	08/82 → 03/88						
1.6	Petrol	63	01/81 → 07/82						
1.6	Petrol	63	08/82 → 02/83						
1.6 D	Diesel	40	01/86 → 03/88	CHASSIS: 32J000001 →					
1.6 TD	Diesel	51	01/86 → 03/88	CHASSIS: 32J000001 →					
1.8	Petrol	66	01/86 → 03/88	CHASSIS: 32J000001 →					
1.8	Petrol	64	05/86 → 03/88						
1.8	Petrol	66	01/83 → 03/88						
1.8 Syncro	Petrol	66	01/86 → 03/88	CHASSIS: 32J000001 →					
1.8 Syncro	Petrol	66	01/86 → 03/88						
1.9	Petrol	85	01/81 → 07/82						
1.9	Petrol	85	08/82 → 07/83						
2.0	Petrol	85	08/83 → 03/88						
2.2	Petrol	100	01/85 → 03/88						
2.2	Petrol	85	08/85 → 03/88						
2.2 Syncro	Petrol	88	08/85 → 03/88						

PASSAT Variant (33)

1.3	Petrol	40	08/78 → 07/80						
1.5 D	Diesel	37	08/78 → 07/80						
1.6	Petrol	55	08/78 → 07/80						
1.6	Petrol	63	08/78 → 07/80						
1.6 D	Diesel	40	02/79 → 07/80						

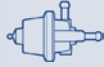

TYPE



TYPE



TYPE

SPA105

F1

SPA105

F1

SAA104

SAA104

SPA105

F1

SAA104

SPA105

F1

SAA104

SAA104

SAA102

SAA104

SAA102

SAA102

SAA104

SAA104

SPA105

F1

SPA105

F1

SPA105

F1

SAA104

SAA104

SAA102

SAA104

SAA102

SAA104

SPA105

F1

SPA105

F1

SPA105

F1

SAA104

SAA104

SPA105

F1

SAA104

SAA102

SAA104

SAA104

SAA104

SAA104

SAA104

SAA104

SAA102

SAA102

SAA102

SAA102

SAA102

SAA102



KW



TYPE



TYPE

VOLKSWAGEN

PASSAT Variant (33)

1.6 i	Petrol	81	08/78 → 07/80						
1.6 i	Petrol	81	06/78 → 07/80						

PASSAT Variant (365)

1.4 TSI	Petrol	90	08/10 →						
1.4 TSI EcoFuel	BiFuel	110	09/10 →						
1.4 TSI EcoFuel	BiFuel	110	08/10 →						
1.4 TSI MultiFuel	Petrol/Ethanol	118	11/10 →						
1.6 TDI	Diesel	77	08/10 →						
1.8 TSI	Petrol	112	02/11 →						
1.8 TSI	Petrol	118	08/10 →						
2.0 TDi	Diesel	100	08/10 →						
2.0 TDi	Diesel	103	08/10 →						
2.0 TDi	Diesel	125	08/10 →						
2.0 TDi 4motion	Diesel	103	08/10 →						
2.0 TDi 4motion	Diesel	125	08/10 →						
2.0 TSI	Petrol	155	11/10 →						

PASSAT Variant (3A5, 35I)

1.6	Petrol	74	07/94 → 12/95				AMM19672	B4	
1.6	Petrol	53	04/88 → 09/91						
1.6	Petrol	53	08/88 → 07/90						
1.6	Petrol	55	04/88 → 12/88						
1.6	Petrol	74	07/94 → 12/95						
1.6	Petrol	53	04/88 → 09/91						
1.6	Petrol	55	04/88 → 12/88						
1.6	Petrol	74	07/95 → 12/95						
1.6 TD	Diesel	59	08/88 → 09/93						
1.6 TD	Diesel	59	08/92 → 09/93						
1.6 TD	Diesel	59	08/88 → 09/93						
1.8	Petrol	55	08/90 → 05/97						
1.8	Petrol	55	08/90 → 03/97						
1.8	Petrol	55	08/90 → 12/93						
1.8	Petrol	55	08/92 → 05/97						
1.8	Petrol	66	02/88 → 05/97						
1.8	Petrol	66	02/88 → 12/93						
1.8	Petrol	66	04/88 → 09/94						
1.8	Petrol	79	04/88 → 07/90						
1.8	Petrol	82	04/88 → 07/92						
1.8	Petrol	102	08/91 → 09/93						
1.8	Petrol	55	08/90 → 05/97						
1.8	Petrol	66	02/88 → 05/97						
1.8	Petrol	79	04/88 → 07/90						
1.8	Petrol	82	04/88 → 07/92						
1.8	Petrol	55	09/91 → 05/97						
1.8	Petrol	55	02/92 → 05/97						



TYPE



TYPE



TYPE

					SAA102								
												ESS0171A	J1
				SPA111	F1		SAC011	H2					
				SPA111	F1								
							SAC011	H2					
				SPA111	F1								
				SPA111	F1	SAA105							
				SPA111	F1					BAE680BB			
				SPA111	F1					BAE680BB			
				SPA111	F1	SAA105							
				SPA111	F1	SAA105							
				SPA111	F1	SAA105						ESS0075A	J1
				SPA111	F1	SAA105							
				SPA111	F1	SAA105						ESS0075A	J1
				SPA111	F1					BAE680BB			
				SPA105	F1	SAA104	SAD021	H3				ESS0018A	J1
				SPA105	F1	SAA102	SAG178	H1					
				SPA143	F1								
				SPA105	F1	SAA102	SAG178	H1					
							SAG064	H1				GA2032	J2
						SAA104							
						SAA104							
							SAG118	H1					
				SPA105	F1	SAA102							
				SPA110	F1								
						SAA104							
				SPA105	F1	SAA102	SAG178	H1				ESS0019A	J1
				SPA143	F1								
				SPA106	F1								
				SPA110	F1								
				SPA105	F1	SAA102	SAG178	H1				ESS0019A	J1
				SPA106	F1								
				SPA143	F1								
				SPA105	F1	SAA102	SAD019	H3					
				SPA105	F1	SAA102	SAD019	H3					
						SAA104							
						SAA104							
						SAA104							
						SAA104							
						SAA104							
							SAG026	H1					
												ESS0042A	J1



KW



TYPE



TYPE

VOLKSWAGEN

PASSAT Variant (3A5, 35I)

1.8	Petrol	66	02/92 → 05/97					
1.8 G60 Syncro	Petrol	118	08/88 → 05/97					
1.8 G60 Syncro	Petrol	118	08/88 → 05/97					
1.9 D	Diesel	50	05/89 → 10/93					
1.9 D	Diesel	50	08/92 → 10/93					
1.9 TD	Diesel	55	03/91 → 05/97					
1.9 TD	Diesel	55	08/92 → 09/93					
1.9 TD	Diesel	55	03/91 → 10/93					
1.9 TDI	Diesel	66	10/93 → 09/94					
1.9 TDI	Diesel	66	10/93 → 05/97					
1.9 TDI	Diesel	81	03/96 → 05/97					
2.0	Petrol	79	03/95 → 08/96			AMM19672	B4	
2.0	Petrol	85	10/94 → 05/97			AMM19672	B4	
2.0	Petrol	79	03/95 → 08/96					
2.0	Petrol	85	02/90 → 05/97					
2.0	Petrol	85	02/90 → 05/97					
2.0	Petrol	85	02/90 → 12/93					
2.0	Petrol	79	07/95 → 08/96					
2.0	Petrol	85	07/95 → 05/97					
2.0	Petrol	85	09/91 → 05/97					
2.0	Petrol	85	10/93 → 10/96					
2.0 16V	Petrol	100	08/88 → 09/93					
2.0 16V	Petrol	100	08/88 → 12/91					
2.0 16V	Petrol	100	08/92 → 09/93					
2.0 16V	Petrol	110	01/94 → 05/97					
2.0 16V	Petrol	110	01/94 → 05/97					
2.0 16V	Petrol	100	08/88 → 09/93					
2.0 16V	Petrol	110	07/95 → 05/97					
2.8 VR6	Petrol	128	10/91 → 03/97					
2.8 VR6	Petrol	128	06/91 → 05/97					
2.9 VR6 Syncro	Petrol	135	01/94 → 05/97					

PASSAT Variant (3B5)

1.8	Petrol	85	06/97 → 11/00					
1.8	Petrol	85	06/97 → 11/00	CHASSIS: 3BY000001 →				
1.8 Syncro/4motion	Petrol	92	06/97 → 01/99			AMM19666	B4	
1.8 Syncro/4motion	Petrol	92	06/97 → 11/00	CHASSIS: 3BY000001 →				
1.8 Syncro/4motion	Petrol	92	08/97 → 11/00					
1.8 Syncro/4motion	Petrol	92	06/97 → 11/00					
1.8 Syncro/4motion	Petrol	92	06/97 → 11/00					
1.8 Syncro/4motion	Petrol	92	08/97 → 08/00					
1.9 TDI	Diesel	85	03/99 → 11/00					
1.9 TDI	Diesel	74	02/00 → 11/00					
1.9 TDI	Diesel	85	08/98 → 11/00	CHASSIS: → 3BX600000				
1.9 TDI	Diesel	85	01/99 → 11/00					



TYPE



TYPE



TYPE

										ESS0042A	J1
						SAA102				GA2032	J2
						SAA104					
				SPA105	F1	SAA104	SAG178	H1			
				SPA110	F1						
				SPA105	F1		SAG178	H1			
				SPA110	F1						
						SAA104					
	APS29										
				SPA105	F1		SAG142	H1			
				SPA105	F1		SAG142	H1			
				ATS18	F2	SAA104					
				SPA105	F1						
				ATS18	F2	SAA102	SAD021	H3		ESS0018A	J1
				SPA105	F1	SAA104	SAG178	H1		GA2223	J2
				SPA106	F1						
							SAG118	H1			
							SAG118	H1			
							SAG026	H1			
							SAG178	H1			
				SPA143	F1	SAA102	SAD019	H3		GA2032	J2
				SPA106	F1						
				SPA110	F1						
				ATS18	F2	SAA104				ESS0018A	J1
				SPA105	F1					GA2223	J2
						SAA104	SAG178	H1			
							SAG118	H1			
	IWP022										
				SPA105	F1		SAG026	H1			
	IWP022										
				ATS19	F2		SAG127	H1	BAE680AQ		
				SPA109	F1						
				SPA109	F1						
				ATS19	F2						
							SAC084	H2		ESS0072A	J1
							SAG127	H1			
									BAE680AQ		
	APS39										
				SPA109	F1						
				SPA165	F1						
				SPA109	F1						



KW

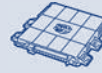

TYPE



TYPE

VOLKSWAGEN

PASSAT Variant (3B5)

1.9 TDI	Diesel	85	08/98 → 11/00						
1.9 TDI 4motion	Diesel	85	08/99 → 11/00						
1.9 TDI 4motion	Diesel	85	08/99 → 11/00	CHASSIS: → 3BX600000					
1.9 TDI 4motion	Diesel	85	08/99 → 08/00						
1.9 TDI Syncro/4motion	Diesel	81	06/97 → 11/00						
1.9 TDI Syncro/4motion	Diesel	81	06/97 → 11/00	CHASSIS: → 3BX600000					
1.9 TDI Syncro/4motion	Diesel	81	05/99 → 11/00	CHASSIS: 3BY000001 →					
2.0	Petrol	88	04/00 → 11/00	CHASSIS: 3BY000001 →					
2.0 4motion	Petrol	88	04/00 → 11/00	CHASSIS: 3BY000001 →					
2.3 VR5 Syncro/4motion	Petrol	110	10/97 → 11/00	CHASSIS: → 3BX600000					
2.3 VR5 Syncro/4motion	Petrol	110	05/99 → 11/00	CHASSIS: 3BY000001 →					
2.3 VR5 Syncro/4motion	Petrol	110	09/98 → 11/00						
2.3 VR5 Syncro/4motion	Petrol	110	10/97 → 11/00						
2.3 VR5 Syncro/4motion	Petrol	110	10/97 → 11/00						
2.5 TDI	Diesel	110	07/98 → 11/00						
2.5 TDI	Diesel	110	07/98 → 11/00	CHASSIS: 3BY000001 →					
2.5 TDI Syncro/4motion	Diesel	110	12/98 → 11/00						
2.5 TDI Syncro/4motion	Diesel	110	12/98 → 11/00	CHASSIS: 3BY000001 →					
2.5 TDI Syncro/4motion	Diesel	110	12/98 → 04/99						
2.8 V6	Petrol	132	09/97 → 09/99	CHASSIS: → 3BX600000					
2.8 V6	Petrol	132	05/99 → 09/99						
2.8 V6	Petrol	140	09/99 → 11/00	CHASSIS: → 3BX600000					
2.8 V6	Petrol	140	09/99 → 08/00						
2.8 V6	Petrol	132	09/97 → 09/99						
2.8 V6	Petrol	132	09/97 → 09/99						
2.8 V6 Syncro/4motion	Petrol	142	01/99 → 11/00				AMM19671	B4	
2.8 V6 Syncro/4motion	Petrol	142	06/97 → 11/00						
2.8 V6 Syncro/4motion	Petrol	142	06/97 → 11/00	CHASSIS: → 3BX600000					
2.8 V6 Syncro/4motion	Petrol	142	05/99 → 11/00	CHASSIS: 3BY000001 →					
2.8 V6 Syncro/4motion	Petrol	142	06/97 → 11/00						
2.8 V6 Syncro/4motion	Petrol	142	06/97 → 11/00						
2.8 V6 Syncro/4motion	Petrol	142	07/98 → 11/00						

PASSAT Variant (3B6)

1.6	Petrol	75	11/00 → 05/05				AMM19670	B4	
1.6	Petrol	75	11/00 → 05/05						
1.6	Petrol	75	11/00 → 05/05	CHASSIS: → 3B2240126					
1.6	Petrol	75	11/00 → 05/05	CHASSIS: → 3B2240126					
1.8 T	Petrol	125	05/02 → 08/05						
1.8 T 20V	Petrol	110	11/00 → 02/03						
1.8 T 20V	Petrol	110	11/00 → 05/05						
1.8 T 20V	Petrol	110	11/00 → 05/05						
1.8 T 20V	Petrol	110	11/00 → 05/03						
1.9 TDI	Diesel	96	11/00 → 05/05				AMM19752	B4	
1.9 TDI	Diesel	74	11/00 → 10/01						

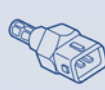
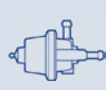

TYPE

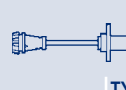

TYPE



TYPE

						SAG178	H1		
	APS39					SAG178	H1		
			SPA165	F1					
			SPA109	F1					
	APS39					SAG142	H1		
			SPA165	F1					
			SPA109	F1					
			SPA109	F1					
			SPA109	F1					
			SPA165	F1					
			SPA109	F1					
			ATS19	F2					
						SAC040	H2	ESS0072A	J1
						SAG038	H1		
	APS39		SGA115	F3		SAG017	H1		
			SPA109	F1					
	APS39		SGA115	F3		SAG017	H1		
			SPA109	F1					
						SAG096	H1		
			SPA165	F1					
			SPA109	F1					
			SPA165	F1					
			SPA109	F1					
						SAC084	H2		
						SAG018	H1		
			ATS19	F2		SAC084	H2	ESS0072A	J1
			SPA165	F1					
			SPA109	F1					
						SAD021	H3		
						SAG018	H1		
						SAG096	H1		
			SPA109	F1		SAG017	H1	ESS0016A	J1
								GA2171	J2
						SAC015	H2		
						SAC015-1	H2		
			SPA109	F1					
	APS39								
			ATS19	F2		SAC084	H2	ESS0016A	J1
			SPA109	F1				GA2171	J2
						SAG017	H1		
			SPA109	F1				ESS0020A	J1
	APS39								



KW



TYPE



TYPE

VOLKSWAGEN

PASSAT Variant (3B6)

1.9 TDI	Diesel	74	11/01 → 05/05						
1.9 TDI	Diesel	74	11/00 → 05/05						
1.9 TDI 4motion	Diesel	96	11/00 → 05/05				AMM19752	B4	
2.0	Petrol	85	11/00 → 05/05				AMM19670	B4	
2.0	Petrol	85	11/00 → 05/05						
2.0	Petrol	96	11/01 → 05/05						
2.0	Petrol	96	11/01 → 05/05						
2.0	Petrol	85	11/00 → 05/05						
2.0 4motion	Petrol	85	11/00 → 05/05				AMM19670	B4	
2.0 4motion	Petrol	85	11/00 → 05/05						
2.0 4motion	Petrol	85	11/00 → 05/05						
2.0 TDi	Diesel	100	12/03 → 05/05				AMM19752	B4	
2.3 VR5	Petrol	125	11/00 → 05/05						
2.3 VR5	Petrol	125	11/00 → 05/05						
2.3 VR5 4motion	Petrol	125	11/00 → 05/05						
2.3 VR5 4motion	Petrol	125	01/01 → 05/05						
2.3 VR5 4motion	Petrol	125	11/00 → 05/05						
2.5 TDI	Diesel	110	11/00 → 05/05				AMM19769	B4	
2.5 TDI	Diesel	120	05/03 → 05/05				AMM19769	B4	
2.5 TDI	Diesel	110	11/00 → 05/03						
2.5 TDI	Diesel	110	11/00 → 05/05	CHASSIS: 3BY000001 →					
2.5 TDI 4motion	Diesel	110	11/00 → 05/05				AMM19769	B4	
2.5 TDI 4motion	Diesel	132	01/03 → 05/05				AMM19769	B4	
2.5 TDI 4motion	Diesel	110	11/00 → 01/03						
2.5 TDI 4motion	Diesel	110	11/00 → 05/05	CHASSIS: 3BY000001 →					
2.5 TDI 4motion	Diesel	110	11/00 → 05/03						
2.8 4motion	Petrol	142	11/00 → 05/05				AMM19671	B4	
2.8 4motion	Petrol	142	11/00 → 05/05						
4.0 W8 4motion	Petrol	202	09/01 → 09/04						

PASSAT Variant (3C5)

1.4 TSI	Petrol	90	05/07 → 11/10						
1.4 TSI	Petrol	90	05/08 → 11/10						
1.4 TSI	Petrol	90	05/07 → 11/10						
1.4 TSI EcoFuel	Petrol/CNG	110	01/09 → 11/10						
1.6	Petrol	75	08/05 → 11/10						
1.6 FSI	Petrol	85	08/05 → 06/08						
1.6 FSI	Petrol	85	08/05 → 06/08						
1.6 TDI	Diesel	77	08/09 → 11/10						
1.8 TSI	Petrol	112	11/09 → 11/10						
1.8 TSI	Petrol	118	05/07 → 10/11						
1.8 TSI	Petrol	118	05/07 → 11/10						
1.9 TDI	Diesel	77	08/05 → 11/08						
2.0 BlueTDI	Diesel	105	01/09 → 11/10						
2.0 FSI	Petrol	110	08/05 → 11/10						



TYPE

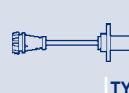

TYPE



TYPE

APPS									
APPS	APPS	APPS	APPS	APPS	APPS	APPS	APPS	APPS	APPS
	APPS40								
			SPA109	F1				ESS0020A	J1
			SPA109	F1					
			SPA109	F1		SAC015	H2	ESS0016A	J1
						SAC015-1	H2	GA2171	J2
			ATS13	F2		SAC084	H2	ESS0016A	J1
			SPA109	F1		SAG017	H1	GA2171	J2
						SAG018	H1		
			SPA109	F1		SAC015	H2	ESS0072A	J1
						SAC015-1	H2	GA2171	J2
						SAG018	H1		
			SPA109	F1					
			SPA109	F1		SAC040	H2	ESS0016A	J1
						SAG049	H1	GA2171	J2
			SPA109	F1		SAC040	H2	ESS0072A	J1
			SPA111	F1					
						SAG049	H1	GA2171	J2
			SGA115	F3					
	APPS40		SPA109	F1		SAG017	H1		
	APPS39					SAG017	H1		
			SPA109	F1					
			SGA115	F3					
	APPS40		SPA109	F1		SAG017	H1		
	APPS39								
			SPA109	F1					
						SAG017	H1		
			ATS19	F2		SAC084	H2	ESS0072A	J1
			SPA109	F1		SAG018	H1	GA2171	J2
			SPA111	F1		SAC040	H2	BAE680AZ	GA2171
			SPA111	F1		SAC011	H2		
						SAA105			
						SAG155	H1		
			SPA111	F1	SAA105	SAC011	H2		
			SPA111	F1		SAC075	H2		
			SPA111	F1	SAA105	SAC011	H2		
						SAG166	H1		
			SPA111	F1	SAA105				
			SPA111	F1				BAE680BB	
			SPA111	F1				BAE680BB	
	APPS40		SPA111	F1		SAG166	H1	ESS0075A	J1
			SPA111	F1		SAG155	H1	ESS0075A	J1
			SPA111	F1		SAC073	H2	BAE680BB	



KW



TYPE



TYPE

VOLKSWAGEN

PASSAT Variant (3C5)

2.0 FSI	Petrol	147	08/05 → 11/10						
2.0 FSI	Petrol	110	08/05 → 11/10						
2.0 FSI	Petrol	125	08/07 → 11/10						
2.0 FSI 4motion	Petrol	110	09/05 → 11/10						
2.0 TDi	Diesel	100	08/05 → 11/10				AMM19752	B4	
2.0 TDi	Diesel	103	08/05 → 05/09				AMM19752	B4	
2.0 TDi	Diesel	120	08/05 → 05/09				AMM19752	B4	
2.0 TDi	Diesel	125	08/05 → 11/10				AMM19752	B4	
2.0 TDi	Diesel	90	08/05 → 02/06				AMM19752	B4	
2.0 TDi	Diesel	100	08/05 → 11/10						
2.0 TDi	Diesel	125	08/05 → 11/10						
2.0 TDi	Diesel	81	11/08 → 11/10						
2.0 TDi	Diesel	90	08/05 → 02/06						
2.0 TDi	Diesel	100	08/05 → 11/10						
2.0 TDI 16V	Diesel	103	08/05 → 11/10				AMM19752	B4	
2.0 TDI 16V	Diesel	103	08/05 → 11/10						
2.0 TDI 16V 4motion	Diesel	103	08/05 → 11/10				AMM19752	B4	
2.0 TDI 16V 4motion	Diesel	103	08/05 → 11/10						
2.0 TDI 4motion	Diesel	103	08/05 → 05/09				AMM19752	B4	
2.0 TDI 4motion	Diesel	103	08/05 → 05/09						
2.0 TDI 4motion	Diesel	125	11/09 → 11/10						
2.0 TDI 4motion	Diesel	125	05/09 → 11/10						
3.2 FSI 4motion	Petrol	184	11/05 → 11/10						
3.2 FSI 4motion	Petrol	184	11/05 → 11/10						
3.6 R36 4motion	Petrol	220	04/07 → 11/10						
3.6 R36 4motion	Petrol	220	04/07 → 11/10						

PHAETON (3D_)

3.0 V6 TDI 4motion	Diesel	165	09/04 →						
3.0 V6 TDI 4motion	Diesel	165	09/04 →						
3.0 V6 TDI 4motion	Diesel	171	06/07 →						
3.0 V6 TDI 4motion	Diesel	176	11/08 →						
3.2 V6	Petrol	177	04/02 →						
3.2 V6	Petrol	177	04/02 →						
3.2 V6 4motion	Petrol	177	02/04 →						
3.2 V6 4motion	Petrol	177	02/04 →						
3.6 V6 4motion	Petrol	206	11/08 →						
4.2 V8 4motion	Petrol	246	05/03 →						
4.2 V8 4motion	Petrol	246	05/03 →						
5.0 V10 TDI 4motion	Diesel	230	11/02 →				AMM19752	B4	
5.0 V10 TDI 4motion	Diesel	230	11/02 →						
6.0 W12 4motion	Petrol	309	04/02 →						
6.0 W12 4motion	Petrol	309	04/02 →						
6.0 W12 4motion	Petrol	331	05/05 →						



TYPE

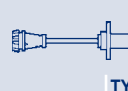

TYPE



TYPE

			SPA111	F1			BAE680BB		
						SAG100	H1		
								BAE680BB	
	APS70		SPA111	F1		SAG100	H1	BAE680BB	
			SPA111	F1		SAC085	H2		ESS0075A J1
			SPA111	F1		SAG166	H1		ESS0075A J1
			SPA111	F1					
			SPA111	F1		SAC085	H2		ESS0075A J1
			SPA111	F1		SAC085	H2		ESS0075A J1
						SAG155	H1		
						SAG166	H1		
			SPA111	F1		SAG155	H1		ESS0075A J1
						SAG166	H1		
						SAG166	H1		
			SPA111	F1		SAC085	H2		ESS0075A J1
						SAG166	H1		
	APS70		SPA111	F1		SAC085	H2		
						SAG166	H1		
	APS70		SPA111	F1		SAG166	H1		ESS0075A J1
									GA2065 J2
			SPA111	F1					
									ESS0075A J1
	APS70		SPA111	F1		SAC011	H2		
						SAG065	H1		
	APS70		SPA111	F1		SAC011	H2		
						SAG065	H1		
			ATS23	F2		SAG090	H1		
			SPA111	F1					
			SPA111	F1					
			SPA111	F1					
			ATS23	F2		SAC040	H2	BAE680BC	
			SPA111	F1		SAD031	H3		
			ATS23	F2					
			SPA111	F1					
			SPA111	F1					
			ATS23	F2		SAC084	H2		
			SPA111	F1					
			ATS23	F2					
			SPA111	F1					
			ATS23	F2		SAC040	H2	BAE680AZ	
			SPA111	F1					
			SPA111	F1		SAC011	H2		



KW



TYPE



TYPE

VOLKSWAGEN

POLO (6N1)

1.7 SDI	Diesel	42	04/97 → 10/99					
100 1.4 16V	Petrol	74	04/96 → 10/99					
100 1.4 16V	Petrol	74	04/96 → 10/99					
100 1.4 16V	Petrol	74	04/96 → 10/99					
120 1.6 16V GTI	Petrol	88	09/98 → 10/99					
120 1.6 16V GTI	Petrol	88	09/98 → 10/99					
120 1.6 16V GTI	Petrol	88	09/98 → 10/99					
45 1.0	Petrol	33	10/94 → 09/96					
45 1.0	Petrol	33	01/95 → 09/96					
45 1.0	Petrol	33	10/94 → 09/96					
55 1.3	Petrol	40	10/94 → 07/95					
55 1.3	Petrol	40	10/94 → 07/95					
55 1.4	Petrol	40	08/95 → 10/99			TB0010		B3
55 1.4	Petrol	40	08/95 → 10/99					
55 1.4	Petrol	40	01/98 → 10/99					
60 1.4	Petrol	44	07/95 → 10/99					
60 1.4	Petrol	44	07/95 → 10/99					
60 1.7 SDI	Diesel	44	08/97 → 10/99					
64 1.9 D	Diesel	47	10/94 → 10/99					
64 1.9 SDI	Diesel	47	07/96 → 10/99					
75 1.6	Petrol	55	10/94 → 10/99			TB0010		B3
75 1.6	Petrol	55	10/94 → 10/99					

POLO (6N2)

1.0	Petrol	37	10/99 → 09/01					
1.0	Petrol	37	10/99 → 09/01					
1.0	Petrol	37	10/99 → 09/01					
1.4	Petrol	40	10/99 → 09/01					
1.4	Petrol	40	10/99 → 09/01					
1.4	Petrol	44	10/99 → 09/01					
1.4	Petrol	44	10/99 → 09/01					
1.4	Petrol	40	10/99 → 09/01					
1.4	Petrol	44	10/99 → 09/01					
1.4 16V	Petrol	55	10/99 → 09/01	ENGINE: APE,AUA				
1.4 16V	Petrol	55	10/99 → 09/01					
1.4 16V	Petrol	74	10/99 → 09/01					
1.4 16V	Petrol	55	10/99 → 09/01					
1.4 16V	Petrol	55	10/99 → 09/01					
1.4 16V	Petrol	74	10/99 → 09/01					
1.4 16V	Petrol	74	10/99 → 09/01					
1.4 TDI	Diesel	55	10/99 → 09/01					
1.4 TDI	Diesel	55	10/99 → 09/01					
1.6 16V GTI	Petrol	92	10/99 → 09/01	ENGINE: AVY				
1.6 16V GTI	Petrol	92	10/99 → 09/01					
1.6 16V GTI	Petrol	92	10/99 → 09/01					

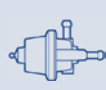

TYPE

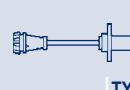

TYPE



TYPE

				SPA110	F1		SAG142	H1		
				SPA109	F1	SAA105	SAC014	H2	ESS0018A	J1
				SPA110	F1		SAD028	H3	GA2223	J2
							SAG178	H1		
				SPA159	F1	SAA105	SAC014	H2	GA2230	J2
							SAD028	H3		
							SAG145	H1		
				SPA106	F1		SAG178	H1	ESS0019A	J1
				SPA105	F1					
									GA2230	J2
				SPA110	F1		SAD028	H3	ESS0042A	J1
							SAG178	H1	GA2230	J2
				SPA110	F1		SAD028	H3	ESS0019A	J1
							SAG178	H1		
				SPA109	F1	SAA105	SAC011	H2		
				SPA109	F1	SAA105	SAC011	H2	ESS0019A	J1
							SAG178	H1		
				SPA110	F1		SAG142	H1		
				SPA110	F1		SAG142	H1		
				SPA110	F1		SAG142	H1		
IWP023				SPA110	F1		SAD028	H3	ESS0018A	J1
							SAG178	H1	GA2223	J2
				ATS23	F2	SAA105	SAC011	H2	BAE680AA	GA2230
				SPA109	F1		SAD028	H3		
							SAG145	H1		
				ATS23	F2	SAA105	SAC011	H2	GA2230	J2
				SPA109	F1		SAD028	H3		
				ATS23	F2	SAA105	SAC011	H2	BAE680AA	GA2230
				SPA109	F1		SAD028	H3		
							SAG145	H1		
							SAG145	H1		
IWP092										
IWP058				ATS23	F2	SAA105	SAC014	H2	GA2230	J2
IWP058				ATS23	F2	SAA105	SAC014	H2	GA2230	J2
				SPA109	F1		SAD028	H3		
							SAG178	H1		
				SPA109	F1		SAD028	H3		
							SAG178	H1		
	APS39			ATS23	F2		SAG134	H1		
				SPA109	F1					
IWP091										
				ATS23	F2	SAA105	SAD028	H3	BAE680AA	GA2230
				SPA109	F1		SAG178	H1		



KW



TYPE



TYPE

VOLKSWAGEN

POLO (6N2)

1.7 SDI	Diesel	44	10/99 → 09/01					
1.7 SDI	Diesel	44	10/99 → 09/01					
1.9 D	Diesel	47	10/99 → 09/01					
1.9 D	Diesel	47	10/99 → 09/01					
1.9 SDI	Diesel	47	10/99 → 09/01					
1.9 SDI	Diesel	47	10/99 → 09/01					

POLO (6R, 6C)

1.2	Petrol	44	06/09 →					
1.2	Petrol	51	06/09 →					
1.2 TDI	Diesel	55	10/09 →					
1.2 TDI	Diesel	55	10/09 →					
1.2 TSI	Petrol	77	11/09 →					
1.2 TSI	Petrol	77	11/09 →					
1.2 TSI	Petrol	66	05/11 → 05/14					
1.4	Petrol	63	06/09 →					
1.4 BiFuel	Petrol/LPG	60	03/10 → 01/11					
1.4 GTI	Petrol	132	05/10 →					
1.6 Bifuel	Petrol/LPG	60	01/11 →					
1.6 TDI	Diesel	55	06/09 →					
1.6 TDI	Diesel	66	06/09 →					
1.6 TDI	Diesel	77	06/09 →					

POLO (86)

0.9	Petrol	29	09/75 → 09/81					
1.1	Petrol	37	03/75 → 09/81					
1.1	Petrol	44	03/75 → 09/81					
1.3	Petrol	44	12/76 → 09/81					

POLO (86C, 80)

1.0	Petrol	29	10/81 → 10/86					
1.0	Petrol	29	10/81 → 10/86					
1.0 Cat.	Petrol	33	08/89 → 09/94					
1.0 Cat.	Petrol	33	08/89 → 09/94					
1.1	Petrol	37	10/81 → 09/89	CHASSIS: K000001 →				
1.1	Petrol	37	10/81 → 09/89					
1.1	Petrol	37	10/81 → 09/89					
1.3	Petrol	44	10/81 → 07/83					
1.3	Petrol	44	10/81 → 07/83					
1.3 Cat.	Petrol	40	07/87 → 09/94	CHASSIS: K000001 →				
1.3 Cat.	Petrol	55	10/89 → 03/91					
1.3 Cat.	Petrol	55	10/89 → 08/90					
1.3 Cat.	Petrol	40	07/87 → 09/94					
1.3 Cat.	Petrol	40	07/87 → 09/94					
1.3 Cat.	Petrol	55	10/89 → 03/91					
1.3 D	Diesel	33	08/86 → 07/90	CHASSIS: K000001 →				
1.3 D	Diesel	33	08/86 → 07/90					



TYPE

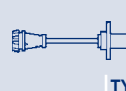

TYPE



TYPE

				ATS18	F2		SAG142	H1		
				SPA110	F1					
				ATS23	F2					
				SPA110	F1					
				ATS18	F2		SAG142	H1		
				SPA110	F1					
				SPA111	F1	SAA105	SAC011	H2		
				SPA111	F1	SAA105	SAC011	H2		
		SPS004		ATS16	F2	SAA105				
				SPA111	F1					
				ATS16	F2	SAA105	SAC011	H2		
				SPA111	F1					
						SAA105				
				SPA111	F1	SAA105	SAC014	H2		
				SPA111	F1	SAA105	SAC011	H2		
				SPA111	F1	SAA105	SAC011	H2		
				SPA111	F1		SAC011	H2		
		SPS004		SPA111	F1	SAA105				
		SPS004		SPA111	F1	SAA105				
		SPS004		SPA111	F1	SAA105				
						SAA102				
						SAA102				
						SAA102				
						SAA102				
						SAA102				
						SAA102				
						SAA102				
						SAA104				
				SPA105	F1	SAA102			GA2230	J2
						SAA104				
				SPA105	F1					
						SAA102				
						SAA104				
						SAA102				
						SAA104				
				SPA105	F1					
				SPA105	F1	SAA102			GA2230	J2
				SPA121	F1					
						SAA102				
						SAA104				
						SAA104				
				SPA105	F1					
						SAA102				



KW



TYPE



TYPE

VOLKSWAGEN

POLO (86C, 80)

1.3 D	Diesel	33	08/86 → 07/90
1.4 D	Diesel	35	01/91 → 09/94
1.4 D	Diesel	35	10/90 → 09/94
1.4 D	Diesel	35	10/90 → 09/94

POLO (9N_)

1.2	Petrol	40	01/02 → 05/07	
1.2	Petrol	40	01/02 → 05/07	
1.2	Petrol	44	05/07 → 11/09	
1.2	Petrol	40	01/02 → 05/07	ENGINE: AWY, ENGINE: BMD
1.2 12V	Petrol	47	10/01 → 07/07	
1.2 12V	Petrol	47	10/01 → 07/07	
1.2 12V	Petrol	51	05/07 → 11/09	
1.2 12V	Petrol	47	10/01 → 07/07	CHASSIS: → 6N2010000
1.4 16V	Petrol	55	10/01 → 05/08	
1.4 16V	Petrol	55	10/01 → 05/08	
1.4 16V	Petrol	59	05/06 → 11/09	
1.4 16V	Petrol	74	10/01 → 05/08	
1.4 16V	Petrol	74	10/01 → 05/08	
1.4 16V	Petrol	55	10/01 → 05/08	
1.4 16V	Petrol	59	05/06 → 11/09	
1.4 16V	Petrol	74	10/01 → 05/08	
1.4 16V	Petrol	55	10/01 → 05/08	
1.4 16V	Petrol	59	05/06 → 11/09	
1.4 16V	Petrol	55	10/01 → 05/08	ENGINE: AJA, ENGINE: BBY
1.4 FSI	Petrol	63	02/02 → 07/06	
1.4 FSI	Petrol	63	02/02 → 07/06	
1.4 FSI	Petrol	63	02/02 → 07/06	
1.4 TDI	Diesel	51	04/05 → 11/09	
1.4 TDI	Diesel	55	10/01 → 04/02	
1.4 TDI	Diesel	55	05/02 → 05/05	
1.4 TDI	Diesel	59	04/05 → 11/09	
1.4 TDI	Diesel	51	04/05 → 11/09	
1.4 TDI	Diesel	55	10/01 → 06/05	
1.4 TDI	Diesel	55	10/01 → 06/05	
1.4 TDI	Diesel	59	04/05 → 11/09	
1.6 16V	Petrol	77	05/06 → 11/09	
1.6 16V	Petrol	77	05/06 → 11/09	
1.6 16V	Petrol	77	05/06 → 11/09	
1.8 GTI	Petrol	110	09/05 → 11/09	
1.8 GTI	Petrol	110	09/05 → 11/09	
1.8 GTI	Petrol	110	09/05 → 11/09	
1.8 GTi Cup Edition	Petrol	132	05/06 → 11/09	
1.8 GTi Cup Edition	Petrol	132	05/06 → 11/09	
1.8 GTi Cup Edition	Petrol	132	05/06 → 11/09	



TYPE



TYPE



TYPE

					SAA104					
			SPA105	F1						
					SAA102					
					SAA104					
			ATS23	F2	SAA105	SAC011	H2	BAE680AU		
			SPA111	F1		SAD031	H3			
					SAA105	SAC011	H2	BAE680Y	GA2220	J2
									GA2230	J2
			ATS23	F2	SAA105	SAC011	H2			
			SPA111	F1						
			SPA111	F1	SAA105	SAC011	H2		GA2220	J2
									GA2230	J2
			ATS23	F2	SAA105	SAC011	H2	BAE680AU		
			SPA111	F1		SAD031	H3			
			SPA111	F1	SAA105	SAC014	H2		GA2220	J2
			ATS23	F2	SAA105	SAC014	H2		GA2230	J2
			SPA111	F1		SAD031	H3			
						SAG132	H1			
						SAD031	H3			
						SAG178	H1			
						SAG166	H1			
						SAG166	H1			
									GA2230	J2
			ATS13	F2	SAA105	SAC011	H2			
			SPA111	F1		SAD031	H3			
						SAG166	H1			
	APS40		ATS23	F2		SAG134	H1			
	APS39									
	APS40									
	APS40		ATS23	F2		SAG134	H1			
			SPA111	F1		SAG166	H1			
			ATS23	F2		SAG134	H1		GA2185	J2
			SPA111	F1						
			SPA111	F1		SAG166	H1			
			SPA111	F1	SAA105	SAC011	H2			
						SAD031	H3			
						SAG132	H1			
	APS40		ATS23	F2		SAC015	H2		GA2220	J2
						SAC015-1	H2			
						SAD031	H3			
						SAC015	H2			
						SAC015-1	H2			
						SAD031	H3			



KW



TYPE



TYPE

VOLKSWAGEN

POLO (9N_)

1.9 SDI	Diesel	47	10/01 → 11/09					
1.9 SDI	Diesel	47	10/01 → 11/09					
1.9 TDI	Diesel	96	11/03 → 11/09				AMM19752	B4
1.9 TDI	Diesel	74	10/01 → 04/02					
1.9 TDI	Diesel	74	05/02 → 11/09					
1.9 TDI	Diesel	74	10/01 → 11/09					
1.9 TDI	Diesel	74	10/01 → 11/09					

POLO CLASSIC (6KV2)

1.8	Petrol	73	05/96 → 09/01					
1.9 SDI	Diesel	48	06/96 → 09/01					
100 1.6	Petrol	74	12/95 → 05/98				AMM19672	B4
100 1.6	Petrol	74	10/99 → 09/01				AMM19670	B4
100 1.6	Petrol	74	12/95 → 09/01	CHASSIS: 6KY503401 →				
100 1.6	Petrol	74	12/95 → 06/98	CHASSIS: → 6KX520000				
100 1.6	Petrol	74	12/95 → 09/01					
100 1.6	Petrol	74	12/95 → 09/01					
100 1.6	Petrol	74	12/95 → 09/01					
100 1.6	Petrol	74	05/96 → 09/01					
110 1.9 TDI	Diesel	81	10/99 → 01/02					
110 1.9 TDI	Diesel	81	06/98 → 01/02					
110 1.9 TDI	Diesel	81	06/98 → 01/02	CHASSIS: 6KY503401 →				
110 1.9 TDI	Diesel	81	09/99 → 01/02					
110 1.9 TDI	Diesel	81	06/98 → 10/99					
54 1.4	Petrol	40	01/98 → 08/99					
57 1.7 SDI	Diesel	42	07/97 → 09/01					
57 1.7 SDI	Diesel	42	07/97 → 09/01					
60 1.4	Petrol	44	12/95 → 09/01				TB0010	B3
60 1.4	Petrol	44	12/95 → 09/01					
60 1.4	Petrol	44	12/95 → 09/01					
60 1.4	Petrol	44	10/99 → 10/00					
64 1.9 SDI	Diesel	47	12/95 → 08/99					
64 1.9 SDI	Diesel	47	12/95 → 08/99					
68 1.9 SDI	Diesel	50	08/99 → 01/02					
68 1.9 SDI	Diesel	50	08/99 → 01/02	CHASSIS: 6KY503401 →				
68 1.9 SDI	Diesel	50	10/99 → 01/02					
68 1.9 SDI	Diesel	50	08/99 → 10/99					
75 1.4 16V	Petrol	55	10/99 → 09/01					
75 1.4 16V	Petrol	55	10/99 → 09/01					
75 1.4 16V	Petrol	55	10/99 → 09/01					
75 1.6	Petrol	55	11/95 → 09/01				TB0010	B3
75 1.6	Petrol	55	11/95 → 09/97					
75 1.6	Petrol	55	11/95 → 09/01					
90 1.8	Petrol	66	01/97 → 09/01					



TYPE



TYPE



TYPE

				ATS18	F2						
				SPA111	F1						
				SPA111	F1		SAG178	H1			
		APS39									
		APS40									
				ATS23	F2		SAG166	H1		GA2185	J2
				SPA111	F1						
		IWP044									
							SAG178	H1			
				SPA109	F1						
						SAA104					
							SAC015	H2		ESS0018A	J1
							SAC015-1	H2		GA2223	J2
							SAD021	H3			
							SAG118	H1			
							SAG018	H1			
		APS39									
				ATS18	F2		SAG178	H1			
				SPA109	F1						
				SPA110	F1						
							SAG138	H1			
				SPA110	F1		SAG178	H1			
				ATS18	F2						
				SPA110	F1						
				SPA110	F1	SAA105	SAC011	H2		ESS0018A	J1
							SAD028	H3		GA2223	J2
							SAG178	H1			
							SAG145	H1			
				ATS18	F2		SAG142	H1			
				SPA110	F1						
				ATS18	F2		SAG178	H1			
				SPA109	F1						
				SPA110	F1						
							SAG138	H1			
				SPA109	F1	SAA105	SAC014	H2		GA2230	J2
							SAD028	H3			
							SAG178	H1			
				SPA109	F1		SAD028	H3		ESS0019A	J1
				SPA110	F1	SAA104	SAG178	H1		ESS0042A	J1
							SAG178	H1			
				SPA110	F1	SAA104	SAG178	H1		ESS0042A	J1



KW



TYPE



TYPE

VOLKSWAGEN

POLO CLASSIC (86C, 80)

1.0	Petrol	29	01/85 → 10/86	CHASSIS: K000001 →				
1.0	Petrol	33	01/85 → 09/94	CHASSIS: K000001 →				
1.0	Petrol	29	01/85 → 10/86					
1.0	Petrol	29	01/85 → 10/86					
1.0	Petrol	33	01/85 → 09/94					
1.0	Petrol	33	01/85 → 09/94					
1.3 Cat.	Petrol	40	07/87 → 09/94	CHASSIS: K000001 →				
1.3 Cat.	Petrol	40	07/87 → 09/94					
1.3 Cat.	Petrol	40	07/87 → 09/94					
1.3 D	Diesel	33	08/86 → 12/88	CHASSIS: K000001 →				
1.3 D	Diesel	33	08/86 → 12/88					
1.3 D	Diesel	33	08/86 → 12/88					

POLO Coupé (86C, 80)

1.0	Petrol	29	05/82 → 10/86					
1.0	Petrol	29	05/82 → 10/86					
1.0 Cat.	Petrol	33	08/89 → 09/94	CHASSIS: K000001 →				
1.0 Cat.	Petrol	33	08/89 → 09/94					
1.0 Cat.	Petrol	33	08/89 → 09/94					
1.1	Petrol	37	10/81 → 07/83					
1.1	Petrol	37	10/81 → 07/83					
1.3	Petrol	57	03/91 → 09/94					
1.3	Petrol	44	10/81 → 07/83					
1.3	Petrol	44	10/81 → 07/83					
1.3 Cat.	Petrol	40	07/87 → 08/94	CHASSIS: K000001 →				
1.3 Cat.	Petrol	55	10/89 → 09/94					
1.3 Cat.	Petrol	55	10/89 → 08/90					
1.3 Cat.	Petrol	55	01/90 → 12/90	CHASSIS: K000001 →				
1.3 Cat.	Petrol	40	07/87 → 08/94					
1.3 Cat.	Petrol	40	07/87 → 08/94					
1.3 Cat.	Petrol	55	10/89 → 09/94					
1.3 D	Diesel	33	08/86 → 08/90	CHASSIS: K000001 →				
1.3 D	Diesel	33	08/86 → 08/90					
1.3 D	Diesel	33	08/86 → 08/90					
1.3 G40	Petrol	83	08/90 → 09/94					
1.3 G40	Petrol	85	01/87 → 08/90	CHASSIS: K000001 →				
1.3 G40	Petrol	83	08/90 → 09/94					
1.3 G40	Petrol	85	01/87 → 08/90					
1.3 G40	Petrol	85	01/87 → 08/90					
1.3 G40	Petrol	83	12/90 → 09/94					
1.4 D	Diesel	35	01/91 → 09/94					
1.4 D	Diesel	35	08/90 → 09/94					
1.4 D	Diesel	35	08/90 → 09/94					



KW



TYPE



TYPE

VOLKSWAGEN

POLO Furgonato (6NF)

1.0	Petrol	33	10/94 → 12/99
1.0	Petrol	33	10/94 → 12/99
1.4	Petrol	44	05/98 → 12/99
1.4	Petrol	44	05/98 → 12/99
1.7 SDI	Diesel	44	08/97 → 12/99
1.7 SDI	Diesel	44	10/99 → 12/99
1.9 D	Diesel	47	10/94 → 12/99
1.9 SDI	Diesel	47	07/96 → 12/99
1.9 SDI	Diesel	47	10/99 → 12/99

POLO Furgonato (86CF)

1.0	Petrol	33	08/92 → 07/94
1.3	Petrol	40	08/92 → 07/94
1.4 D	Diesel	35	08/92 → 07/94

POLO Tre volumi

1.6	Petrol	63	11/10 →
1.6	Petrol	77	09/10 →
1.6	Petrol	63	11/10 → 04/12
1.6	Petrol	77	05/10 →

POLO Tre volumi (9A4)

1.4	Petrol	55	07/03 →
1.4	Petrol	55	07/03 →
1.4	Petrol	74	11/03 →
1.4	Petrol	74	11/03 →
1.4	Petrol	55	07/03 →
1.4	Petrol	74	11/03 →
1.4 TDI	Diesel	55	07/03 →
1.4 TDI	Diesel	55	07/03 →
1.6	Petrol	74	09/02 →
1.6	Petrol	74	09/02 → 06/05
1.6	Petrol	74	09/02 → 05/05
1.9 SDI	Diesel	47	09/02 →
1.9 SDI	Diesel	47	09/02 →
1.9 TDI	Diesel	74	09/02 →

POLO Variant (6KV5)

1.4	Petrol	40	12/98 → 09/01
1.4	Petrol	44	05/97 → 09/01
1.4	Petrol	40	12/98 → 09/01
1.4	Petrol	44	05/97 → 09/01
1.4	Petrol	44	05/97 → 09/01
1.4	Petrol	44	10/99 → 10/00
1.4 16V	Petrol	55	10/99 → 09/01
1.4 16V	Petrol	55	10/99 → 09/01
1.4 16V	Petrol	55	10/99 → 09/01
1.4 16V	Petrol	55	10/99 → 09/01

ENGINE: APE,AUA



TYPE

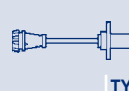

TYPE



TYPE

				SPA106	F1					ESS0042A	J1
										GA2230	J2
				SPA110	F1		SAD028	H3			
							SAG178	H1			
				SPA110	F1		SAG142	H1			
				ATS18	F2						
				SPA110	F1						
				SPA110	F1		SAG142	H1			
				ATS18	F2						
				SPA105	F1					GA2230	J2
				SPA105	F1						
				SPA105	F1						
				SPA111	F1						
				SPA111	F1						
							SAC011	H2			
							SAC011	H2			
				ATS23	F2	SAA105	SAC011	H2			
				SPA111	F1		SAD031	H3			
				ATS23	F2	SAA105	SAC014	H2			
				SPA111	F1		SAD031	H3			
							SAG132	H1			
							SAG166	H1			
	APS40			ATS23	F2		SAG134	H1			
				SPA111	F1						
				SPA111	F1						
						SAA105					
							SAC011	H2			
				ATS18	F2						
				SPA111	F1						
				SPA111	F1		SAG178	H1			
				SPA109	F1	SAA105	SAC011	H2		GA2230	J2
				SPA110	F1	SAA105	SAC011	H2		ESS0019A	J1
							SAG145	H1			
							SAD028	H3		GA2230	J2
							SAG178	H1			
							SAG145	H1			
IWP092											
IWP058				SPA109	F1	SAA105	SAC014	H2		GA2230	J2
							SAD028	H3			
							SAG178	H1			



KW



TYPE



TYPE

VOLKSWAGEN

POLO Variant (6KV5)

1.6	Petrol	74	05/97 → 05/98				AMM19672	B4
1.6	Petrol	74	10/99 → 09/01				AMM19670	B4
1.6	Petrol	55	05/97 → 09/01					
1.6	Petrol	74	05/97 → 09/01	CHASSIS: 6KY503401 →				
1.6	Petrol	74	05/97 → 06/98	CHASSIS: → 6KX520000				
1.6	Petrol	55	05/97 → 09/01					
1.6	Petrol	74	05/97 → 09/01					
1.6	Petrol	74	05/97 → 09/01					
1.6	Petrol	74	05/97 → 09/01					
1.6	Petrol	74	05/97 → 09/01					
1.6	Petrol	74	05/97 → 09/01					
1.7 SDI	Diesel	42	08/97 → 09/01					
1.7 SDI	Diesel	42	08/97 → 09/01					
1.8	Petrol	66	05/97 → 09/01					
1.9 SDI	Diesel	47	06/97 → 09/01					
1.9 SDI	Diesel	47	06/97 → 09/01					
1.9 SDI	Diesel	50	08/99 → 09/01					
1.9 SDI	Diesel	50	08/99 → 09/01	CHASSIS: 6KY503401 →				
1.9 SDI	Diesel	50	08/99 → 10/99					
1.9 TDI	Diesel	66	05/97 → 09/01					
1.9 TDI	Diesel	66	10/99 → 09/01					
1.9 TDI	Diesel	81	10/99 → 09/01					
1.9 TDI	Diesel	66	05/97 → 09/01					
1.9 TDI	Diesel	66	05/97 → 09/01	CHASSIS: 6KY503401 →				
1.9 TDI	Diesel	81	06/98 → 09/01					
1.9 TDI	Diesel	81	06/98 → 09/01	CHASSIS: 6KY503401 →				
1.9 TDI	Diesel	66	05/97 → 10/99					
1.9 TDI	Diesel	81	06/98 → 10/99					

QUANTUM

1.8	Petrol	76	01/97 → 12/01					
2.0	Petrol	91	01/97 → 08/98					

SANTANA (32B)

1.3	Petrol	44	08/81 → 07/82					
1.3	Petrol	44	08/82 → 07/83					
1.6	Petrol	55	08/81 → 07/82					
1.6	Petrol	55	08/82 → 12/84					
1.6	Petrol	63	08/81 → 07/82					
1.6	Petrol	63	08/82 → 12/82					
1.8	Petrol	66	01/83 → 12/84					
1.9	Petrol	85	08/81 → 07/82					
1.9	Petrol	85	08/82 → 07/83					
2.0	Petrol	85	08/83 → 12/84					

KW

TYPE

TYPE
VOLKSWAGEN
SAVEIRO Pianale piatto/Telaio

1.6	Petrol	73	07/97 → 01/00						
1.8	Petrol	72	12/97 → 07/01						

SCIROCCO (137, 138)

1.4 TSI	Petrol	118	05/08 →						
1.4 TSI	Petrol	118	05/08 →						
1.4 TSI	Petrol	90	11/08 →						
1.4 TSI	Petrol	90	08/08 →						
1.4 TSI	Petrol	90	08/08 →						
2.0 R	Petrol	195	11/09 →						
2.0 R	Petrol	188	11/09 →						
2.0 TDi	Diesel	100	11/10 →						
2.0 TDi	Diesel	103	08/08 →						
2.0 TDi	Diesel	103	08/08 →						
2.0 TDi	Diesel	125	05/09 →						
2.0 TDi	Diesel	125	05/09 →						
2.0 TSI	Petrol	147	05/08 → 11/09						
2.0 TSI	Petrol	155	11/09 → 05/11						
2.0 TSI	Petrol	147	08/08 → 11/09						

SCIROCCO (53)

1.1	Petrol	37	04/74 → 07/79						
1.3	Petrol	44	08/79 → 07/80						
1.5	Petrol	51	02/74 → 12/75						
1.5	Petrol	51	08/77 → 07/80						
1.6	Petrol	55	08/75 → 07/79						
1.6	Petrol	63	08/75 → 07/80						
1.6	Petrol	81	06/76 → 07/80						

SCIROCCO (53B)

1.3	Petrol	44	08/80 → 07/82						
1.3	Petrol	44	08/82 → 12/83						
1.5	Petrol	51	08/80 → 07/82						
1.5	Petrol	51	08/82 → 12/83						
1.6	Petrol	53	04/86 → 07/90						
1.6	Petrol	55	01/83 → 12/89						
1.6	Petrol	63	08/80 → 04/84						
1.6	Petrol	81	08/80 → 07/82						
1.6	Petrol	63	08/80 → 07/82						
1.6	Petrol	63	08/82 → 04/84						
1.8	Petrol	66	08/83 → 07/92						
1.8	Petrol	70	11/85 → 07/92						
1.8	Petrol	82	08/82 → 12/89						
1.8	Petrol	82	08/82 → 01/83						
1.8 16V	Petrol	102	10/85 → 07/89						
1.8 16V	Petrol	95	03/86 → 07/92						

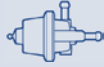

TYPE



TYPE



TYPE

IWP044

IWP044

APS70

ATS16

F2

SAA105

SAC011

H2

SPA111

F1

SAG155

H1

SPA111

F1

SAA105

SAC011

H2

SAG155

H1

APS70

SPA111

F1

BAE680BB

SPA111

F1

BAE680BB

SPS004

SPA111

F1

SAA105

ESS0170A

J1

APS70

SPA111

F1

SAA105

SAG155

H1

ESS0170A

J1

SPS004

APS70

SPA111

F1

SAA105

ESS0170A

J1

APS70

SPA111

F1

SAA105

ESS0170A

J1

SPS004

APS70

SPA111

F1

BAE680BB

APS70

SPA111

F1

BAE680BB

SAA102

SAA102

SAA102

SAA102

SAA102

SAA102

SAA102

SAA102

SAA102

SAA104

SAA102

SAA104

SPA105

F1

SAA104

SPA105

F1

SAA104

SAG178

H1

SPA106

F1

SPA106

F1

SAA102

ESS0171A

J1

SAA102

SAA104

SPA105

F1

SAA104

ESS0171A

J1

SPA105

F1

SAA104

ESS0171A

J1

SPA106

F1

SAA104

ESS0171A

J1

SPA105

F1

SPA105

F1

SAA104

ESS0171A

J1

SPA105

F1

SAA104

ESS0171A

J1



KW

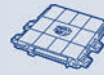

TYPE



TYPE

VOLKSWAGEN

SHARAN (7M8, 7M9, 7M6)

1.8 T 20V	Petrol	110	05/00 → 06/01					
1.8 T 20V	Petrol	110	07/01 → 03/10					
1.8 T 20V	Petrol	110	09/97 → 03/10					
1.8 T 20V	Petrol	110	09/97 → 05/00					
1.8 T 20V	Petrol	110	01/01 → 03/10					
1.8 T 20V	Petrol	110	05/99 → 03/10	CHASSIS: 7MY000001 →				
1.8 T 20V	Petrol	110	09/97 → 03/10					
1.8 T 20V	Petrol	110	05/00 → 03/10					
1.8 T 20V	Petrol	110	11/97 → 03/10					
1.9 TDI	Diesel	110	06/05 → 03/10			AMM19752	B4	
1.9 TDI	Diesel	96	11/02 → 03/10			AMM19752	B4	
1.9 TDI	Diesel	66	03/99 → 06/01					
1.9 TDI	Diesel	66	07/01 → 03/10					
1.9 TDI	Diesel	85	04/00 → 06/01					
1.9 TDI	Diesel	85	07/01 → 03/10					
1.9 TDI	Diesel	110	06/05 → 03/10					
1.9 TDI	Diesel	66	09/95 → 03/10					
1.9 TDI	Diesel	66	09/95 → 02/00					
1.9 TDI	Diesel	66	01/01 → 03/10					
1.9 TDI	Diesel	85	04/00 → 03/10					
1.9 TDI	Diesel	85	01/01 → 03/10					
1.9 TDI	Diesel	96	11/02 → 03/10					
1.9 TDI	Diesel	66	06/05 → 03/10					
1.9 TDI	Diesel	85	06/05 → 03/10					
1.9 TDI	Diesel	96	06/05 → 03/10					
1.9 TDI 4motion	Diesel	85	04/00 → 06/01					
1.9 TDI 4motion	Diesel	85	07/01 → 03/10					
1.9 TDI 4motion	Diesel	85	04/00 → 03/10					
1.9 TDI 4motion	Diesel	85	01/01 → 03/10					
1.9 TDI 4motion	Diesel	85	06/05 → 03/10					
2.0	Petrol	85	09/95 → 02/00			AMM19672	B4	
2.0	Petrol	85	09/95 → 03/10					
2.0	Petrol	85	01/01 → 03/10					
2.0	Petrol	85	09/95 → 03/10	CHASSIS: → 7MX020014				
2.0	Petrol	85	09/95 → 03/10					
2.0	Petrol	85	09/95 → 03/10					
2.0	Petrol	85	05/00 → 03/10					
2.0 LPG	Petrol/LPG	85	05/08 → 03/10					
2.0 LPG	Petrol/LPG	85	04/06 → 03/10					
2.0 TDi	Diesel	103	11/05 → 03/10			AMM19752	B4	
2.0 TDi	Diesel	100	11/05 → 03/10					
2.8 V6 24V	Petrol	150	04/00 → 03/10					
2.8 V6 24V	Petrol	150	01/01 → 03/10					
2.8 V6 24V	Petrol	150	04/00 → 03/10					



TYPE

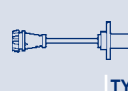

TYPE



TYPE

		APS39							
		APS40							
			SPA105	F1		SAC084	H2		ESS0016A
			ATS19	F2					
			ATS23	F2					
			SPA109	F1					
						SAG178	H1		GA2223
						SAG100	H1		
						SAG018	H1		
			ATS23	F2		SAG015	H2		
			ATS23	F2		SAG178	H1		
		APS39							
		APS40							
		APS39							
		APS40							
			SPA105	F1					
			SPA105	F1		SAG142	H1		
			ATS18	F2					
			ATS23	F2					
			SPA105	F1		SAG178	H1		
			ATS23	F2					
			SPA105	F1					
						SAG015	H2		
						SAG015	H2		
						SAG015	H2		
		APS39							
		APS40							
			SPA105	F1		SAG178	H1		
			ATS23	F2					
						SAG015	H2		
			SPA105	F1		SAC015	H2	BAE680AA	ESS0016A
			ATS23	F2					J1
					SAA104				
						SAC015-1	H2		GA2223
						SAG118	H1		J2
						SAG100	H1		
			SPA110	F1					
						SAG178	H1		
			SPA105	F1		SAG166	H1		
			SPA111	F1					
			SPA105	F1		SAC040	H2	BAE680S	ESS0016A
			ATS23	F2					J1
						SAG065	H1		



KW



TYPE



TYPE

VOLKSWAGEN

SHARAN (7M8, 7M9, 7M6)

2.8 V6 24V 4motion	Petrol	150	04/00 → 03/10						
2.8 V6 24V 4motion	Petrol	150	01/01 → 03/10						
2.8 V6 24V 4motion	Petrol	150	04/00 → 03/10						
2.8 VR6	Petrol	128	09/95 → 02/00						
2.8 VR6	Petrol	128	09/95 → 05/97						
2.8 VR6	Petrol	128	09/95 → 04/00						
2.8 VR6	Petrol	128	09/95 → 04/00						

SHARAN (7N)

1.4 TSI	Petrol	110	05/10 →						
2.0 TDi	Diesel	100	05/10 →						
2.0 TDi	Diesel	103	05/10 →						
2.0 TDi	Diesel	125	08/10 →						
2.0 TDi	Diesel	85	05/11 →						
2.0 TDi 4motion	Diesel	100	05/11 → 05/12						
2.0 TDi 4motion	Diesel	103	05/11 →						

TARO

2.4 D	Diesel	61	06/89 → 03/97						
2.4 D 4x4	Diesel	61	04/89 → 03/97						

TIGUAN (5N_)

1.4 TSI	Petrol	110	05/08 →						
1.4 TSI	Petrol	110	05/08 →						
1.4 TSI	Petrol	118	05/11 →						
1.4 TSI	Petrol	90	08/10 →						
1.4 TSI 4motion	Petrol	110	09/07 →						
1.4 TSI 4motion	Petrol	110	11/07 →						
1.4 TSI 4motion	Petrol	118	05/11 →						
1.4 TSI 4motion	Petrol	110	09/07 →						
2.0 TDi	Diesel	103	03/08 →						
2.0 TDi	Diesel	81	05/10 →						
2.0 TDi	Diesel	103	03/08 →						
2.0 TDi	Diesel	103	03/08 →	ENGINE: CBAB,CFFB					
2.0 TDi	Diesel	81	05/10 →	ENGINE: CFFD					
2.0 TDi 4motion	Diesel	100	11/07 →						
2.0 TDi 4motion	Diesel	103	11/07 →						
2.0 TDi 4motion	Diesel	120	02/08 → 08/09						
2.0 TDi 4motion	Diesel	125	02/08 →						
2.0 TDi 4motion	Diesel	103	09/07 →						
2.0 TDi 4motion	Diesel	125	09/07 →						
2.0 TDi 4motion	Diesel	100	11/07 →	ENGINE: CBAA,CFFA					
2.0 TDi 4motion	Diesel	103	09/07 →						
2.0 TDi 4motion	Diesel	103	09/07 →						
2.0 TDi 4motion	Diesel	103	09/07 →	ENGINE: CBAB,CFFB,CLJA					
2.0 TDi 4motion	Diesel	120	02/08 → 08/09	ENGINE: CBBA					
2.0 TDi 4motion	Diesel	125	09/07 →						



TYPE

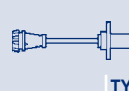

TYPE



TYPE

				SPA105	F1		SAC040	H2		ESS0016A	J1
				ATS23	F2						
							SAG065	H1			
			IWP022								
				SPA105	F1						
							SAC040	H2		ESS0016A	J1
							SAG178	H1		GA2223	J2
				SPA111	F1		SAC011	H2			
				SPA111	F1	SAA105					
				SPA111	F1	SAA105					
				SPA111	F1	SAA105					
				SPA111	F1	SAA105					
				SPA111	F1	SAA105					
				SPA111	F1	SAA105					
						SAA110					
						SAA110					
				SPA111	F1	SAA105	SAC011	H2			
				ATS16	F2		SAG155	H1			
				SPA111	F1		SAC011	H2			
				SPA111	F1		SAC011	H2			
				ATS16	F2		SAC011	H2		GA2116	J2
				SPA111	F1	SAA105					
				SPA111	F1		SAC011	H2			
							SAG155	H1			
				SPA111	F1	SAA105	SAC047	H2		ESS0075A	J1
				SPA111	F1	SAA105					
							SAG155	H1			
										SUA592	J3
										SUA592	J3
				SPA111	F1	SAA105				ESS0075A	J1
				SPA111	F1	SAA105					
				SPA111	F1						
				SPA111	F1	SAA105					
							SAC047	H2		ESS0075A	J1
							SAG155	H1		ESS0075A	J1
										SUA592	J3
										GA2183	J2
										SUA576	J3
										SUA592	J3
										SUA592	J3
										SUA592	J3
										GA2183	J2



KW

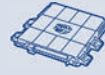

TYPE



TYPE

VOLKSWAGEN

TIGUAN (5N_)

2.0 TDI 4motion	Diesel	125	09/07 →						
2.0 TDI 4motion	Diesel	125	09/07 →	ENGINE: CBBB,CFGB					
2.0 TFSI 4motion	Petrol	125	01/08 →						
2.0 TFSI 4motion	Petrol	147	11/07 →						
2.0 TFSI 4motion	Petrol	125	09/07 →						
2.0 TFSI 4motion	Petrol	147	09/07 →						
2.0 TSI 4motion	Petrol	132	05/11 →						
2.0 TSI 4motion	Petrol	155	05/11 →						

TOUAREG (7LA, 7L6, 7L7)

2.5 R5 TDI	Diesel	120	08/03 → 05/10					AMM19752	B4
2.5 R5 TDI	Diesel	128	01/03 → 05/10					AMM19752	B4
3.0 TDI	Diesel	155	04/06 → 05/10						
3.0 V6 TDI	Diesel	165	11/04 → 05/10						
3.0 V6 TDI	Diesel	165	11/04 → 05/10						
3.0 V6 TDI	Diesel	176	11/07 → 05/10						
3.2 V6	Petrol	162	10/02 → 11/06						
3.2 V6	Petrol	162	10/02 → 11/06						
3.2 V6	Petrol	177	11/04 → 11/06						
3.2 V6	Petrol	177	11/04 → 11/06						
3.6 V6 FSI	Petrol	206	10/05 → 05/10						
3.6 V6 FSI	Petrol	206	10/05 → 05/10						
4.2 V8	Petrol	228	12/02 → 11/06						
4.2 V8	Petrol	228	12/02 → 11/06						
4.2 V8	Petrol	228	12/02 → 05/05						
4.2 V8 FSI	Petrol	257	06/06 → 05/10						
5.0 R50 TDI	Diesel	257	10/07 → 05/10					AMM19752	B4
5.0 R50 TDI	Diesel	257	08/07 → 05/10						
5.0 V10 TDI	Diesel	230	10/02 → 05/10					AMM19752	B4
5.0 V10 TDI	Diesel	230	10/02 → 05/10						
6.0 W12	Petrol	331	08/04 → 05/10						
6.0 W12	Petrol	331	08/04 → 05/10						

TOUAREG (7P5)

3.0 V6 TDI	Diesel	150	01/10 →						
3.0 V6 TDI	Diesel	176	01/10 → 05/11						
3.0 V6 TSI Hybrid	Petrol	245	04/10 →						
3.6 V6 FSI	Petrol	183	08/10 →						
3.6 V6 FSI	Petrol	206	04/10 →						
4.2 V8 FSI	Petrol	265	01/11 →						
4.2 V8 TDI	Diesel	250	01/10 →						

TOURAN (1T1, 1T2)

1.4 FSI	Petrol	125	11/06 → 05/10						
1.4 FSI	Petrol	125	11/06 → 05/10						
1.4 TSI	Petrol	103	02/06 → 05/10						
1.4 TSI	Petrol	103	02/06 → 05/10						

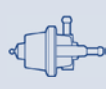

TYPE

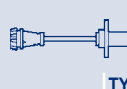

TYPE



TYPE

									SUA576	J3
									SUA592	J3
				SPA111	F1					
				SPA111	F1					
									BAE680BB	
									BAE680BB	
				SPA111	F1				BAE680BB	
				SPA111	F1				BAE680BB	
				ATS23	F2					
				SPA111	F1					
				ATS23	F2				ESS0003A	J1
				SPA109	F1					
				SPA111	F1					
				ATS23	F2		SAC040	H2	BAE680AZ	
				SPA111	F1		SAD031	H3		
				ATS23	F2		SAC040	H2		
				SPA111	F1					
				SPA111	F1		SAC011	H2	BAE680BC	
							SAD031	H3		
				ATS23	F2		SAC084	H2		
				SPA111	F1		SAD019	H3		
							SAG056	H1		
				SPA111	F1		SAG056	H1	BAE680BB	
				SPA111	F1					
				ATS23	F2					
				SPA111	F1					
				ATS23	F2					
				SPA111	F1					
				SPA111	F1					
				SPA111	F1		SAC011	H2		
				SPA111	F1		SAC011	H2		
				SPA111	F1					
				SPA111	F1					
				ATS16	F2	SAA105	SAC011	H2	BAE680AU	
				SPA111	F1		SAG155	H1		
				ATS16	F2	SAA105	SAC011	H2		
				SPA111	F1		SAD031	H3		



KW



TYPE



TYPE

VOLKSWAGEN

TOURAN (1T1, 1T2)

1.4 TSI	Petrol	103	02/06 → 05/10						
1.4 TSI EcoFuel	Petrol/CNG	110	05/09 → 05/10						
1.4 TSI EcoFuel	Petrol/CNG	110	05/09 → 05/10						
1.6	Petrol	75	07/03 → 05/10						
1.6	Petrol	75	07/03 → 05/10						
1.6 FSI	Petrol	85	02/03 → 01/07						
1.6 FSI	Petrol	85	02/03 → 01/07						
1.6 FSI	Petrol	85	02/03 → 01/07						
1.6 TDI	Diesel	77	04/10 → 05/10						
1.9 TDI	Diesel	66	06/05 → 05/10						
1.9 TDI	Diesel	74	02/03 → 05/04						
1.9 TDI	Diesel	77	08/03 → 05/10						
1.9 TDI	Diesel	66	11/04 → 05/10						
1.9 TDI	Diesel	66	11/04 → 05/10						
1.9 TDI	Diesel	74	02/03 → 05/04						
1.9 TDI	Diesel	77	08/03 → 05/10						
2.0 EcoFuel	Petrol/CNG	80	02/06 → 05/09						
2.0 EcoFuel	Petrol/CNG	80	02/06 → 05/09						
2.0 EcoFuel	Petrol/CNG	80	02/06 → 05/09						
2.0 FSI	Petrol	110	10/03 → 11/05						
2.0 FSI	Petrol	110	10/03 → 11/05						
2.0 FSI	Petrol	110	10/03 → 05/05						
2.0 FSI	Petrol	110	10/03 → 11/05						
2.0 FSI	Petrol	110	10/03 → 11/05						
2.0 TDi	Diesel	100	02/03 → 05/10					AMM19752	B4
2.0 TDi	Diesel	103	12/05 → 05/10					AMM19752	B4
2.0 TDi	Diesel	125	12/05 → 05/10					AMM19752	B4
2.0 TDi	Diesel	100	02/03 → 05/10						
2.0 TDi	Diesel	125	12/05 → 05/10						
2.0 TDi 16V	Diesel	103	08/03 → 05/10					AMM19752	B4
2.0 TDi 16V	Diesel	103	08/03 → 05/10						

TOURAN (1T3)

1.2 TSI	Petrol	77	05/10 →						
1.6 TDI	Diesel	66	05/10 →						
2.0 TDi	Diesel	81	11/10 →						

TRANSPORTER III Autobus

1.6 D	Diesel	37	01/81 → 07/87						
1.6 TD	Diesel	51	08/84 → 07/92						
1.6 TD Syncro	Diesel	51	03/86 → 07/92						
1.7 D	Diesel	42	10/86 → 07/92						
1.9	Petrol	44	08/82 → 07/92						
1.9	Petrol	57	08/82 → 07/92						
1.9	Petrol	61	01/83 → 07/85						
1.9	Petrol	66	08/83 → 07/85						



TYPE

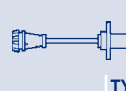

TYPE



TYPE

						SAG155	H1			
				ATS16	F2	SAC011	H2			
				SPA111	F1					
				ATS23	F2	SAC075	H2	BAE680AA		
				SPA111	F1	SAD031	H3			
				ATS13	F2	SAA105	SAC011	H2	BAE680AU	
				SPA111	F1		SAD031	H3		
							SAG166	H1		
				SPA111	F1	SAA105				
	APS40									
	APS40			ATS23	F2	SAG166	H1			
	APS40			ATS23	F2	SAG166	H1			
				ATS23	F2	SAG166	H1			
				SPA111	F1					
				SPA111	F1					
				SPA111	F1					
				SPA111	F1		SAC015	H2		
							SAC015-1	H2		
							SAD031	H3		
				ATS23	F2		SAC073	H2	BAE680BB	
				SPA111	F1		SAD031	H3		
				ATS13	F2					
							SAG100	H1		
							SAG166	H1		
				ATS23	F2		SAC085	H2		
				SPA111	F1		SAG166	H1		
				SPA111	F1		SAC085	H2		
				SPA111	F1		SAG166	H1		
							SAG166	H1		
				ATS23	F2		SAC085	H2		
				SPA111	F1		SAG166	H1		
							SAC011	H2		
				SPA111	F1	SAA105				
				SPA111	F1	SAA105				
						SAA102				
						SAA102				
						SAA102				
						SAA102				
				SPA105	F1	SAA102			PI024	J1
				SPA105	F1	SAA102				
						SAA102				
						SAA102				



KW



TYPE



TYPE

VOLKSWAGEN

TRANSPORTER III Autobus

1.9 Syncro	Petrol	57	02/85 → 07/92
2.1	Petrol	64	10/86 → 07/92
2.1	Petrol	70	08/85 → 07/92
2.1	Petrol	82	08/84 → 07/92
2.1 Cat.	Petrol	70	06/89 → 07/92
2.1 i	Petrol	68	07/89 → 07/92
2.1 Syncro	Petrol	64	10/86 → 07/92
2.1 Syncro	Petrol	70	08/85 → 07/92
2.1 Syncro	Petrol	82	01/86 → 07/92

TRANSPORTER III Furgonato

1.9	Petrol	44	10/82 → 07/92
2.1	Petrol	70	08/85 → 07/92
2.1	Petrol	82	03/86 → 07/92
2.1	Petrol	70	02/86 → 07/92
2.1 i	Petrol	68	07/89 → 07/92
2.1 Syncro	Petrol	70	08/85 → 07/92

TRANSPORTER III Pianale piatto/Telaio

1.6 D	Diesel	37	01/81 → 07/87
1.6 TD	Diesel	51	10/84 → 07/92
1.7 D	Diesel	42	07/89 → 07/92
1.9	Petrol	44	09/82 → 07/92
1.9	Petrol	57	08/82 → 07/92
2.1	Petrol	82	03/86 → 07/92
2.1 i	Petrol	68	07/89 → 07/92

TRANSPORTER IV Autobus (70XB, 70XC, 7DB, 7DW)

1.8	Petrol	49	12/90 → 07/92
1.9 D	Diesel	44	09/90 → 12/95
1.9 TD	Diesel	50	10/92 → 04/03
1.9 TD	Diesel	50	10/92 → 04/03
2.0	Petrol	62	09/90 → 04/03
2.0	Petrol	62	09/90 → 04/03
2.0	Petrol	62	09/90 → 04/03
2.4 D	Diesel	55	08/97 → 04/03
2.4 D	Diesel	57	09/90 → 04/98
2.4 D Syncro	Diesel	57	10/92 → 09/98
2.5	Petrol	81	11/90 → 04/03
2.5	Petrol	81	11/90 → 04/03
2.5	Petrol	81	11/90 → 04/03
2.5	Petrol	81	11/90 → 04/03
2.5	Petrol	81	01/94 → 10/96
2.5 Syncro	Petrol	81	11/92 → 04/03
2.5 Syncro	Petrol	81	11/92 → 04/03
2.5 Syncro	Petrol	81	11/92 → 04/03
2.5 Syncro	Petrol	81	11/92 → 04/03



KW



TYPE



TYPE

VOLKSWAGEN

TRANSPORTER IV Autobus (70XB, 70XC, 7DB, 7DW)

2.5 Syncro	Petrol	81	01/94 → 10/96					
2.5 TDI	Diesel	111	05/98 → 04/03				AMM19752	B4
2.5 TDI	Diesel	111	05/98 → 04/01					
2.5 TDI	Diesel	111	05/01 → 04/03					
2.5 TDI	Diesel	65	05/98 → 04/01					
2.5 TDI	Diesel	65	05/01 → 04/03					
2.5 TDI	Diesel	75	09/95 → 04/01					
2.5 TDI	Diesel	75	05/01 → 04/03					
2.5 TDI	Diesel	111	05/98 → 04/03					
2.5 TDI	Diesel	65	05/98 → 04/03					
2.5 TDI	Diesel	75	09/95 → 04/03					
2.5 TDI	Diesel	75	05/99 → 04/03					
2.8 VR 6	Petrol	103	11/95 → 04/00					
2.8 VR 6	Petrol	103	11/95 → 04/00					
2.8 VR6	Petrol	150	04/00 → 04/03					
2.8 VR6 Syncro	Petrol	103	01/96 → 04/96					

TRANSPORTER IV Furgonato (70XA)

2.4 D	Diesel	55	08/97 → 04/03					
2.5	Petrol	85	08/96 → 04/03					
2.5	Petrol	85	08/96 → 04/03	CHASSIS: → 70X053924				
2.5	Petrol	85	08/96 → 04/03					
2.5 Syncro	Petrol	85	05/99 → 04/03				AMM19670	B4
2.5 Syncro	Petrol	85	08/96 → 04/03	CHASSIS: 70X053925 →				
2.5 Syncro	Petrol	85	08/96 → 04/03	CHASSIS: → 70X053924				
2.5 Syncro	Petrol	85	08/96 → 04/03					
2.5 Syncro	Petrol	85	08/96 → 04/03					
2.5 TDI	Diesel	111	09/00 → 04/03				AMM19752	B4
2.5 TDI	Diesel	111	09/00 → 04/01					
2.5 TDI	Diesel	111	05/01 → 04/03					
2.5 TDI	Diesel	65	12/98 → 04/01					
2.5 TDI	Diesel	65	05/01 → 04/03					
2.5 TDI	Diesel	75	09/95 → 04/01					
2.5 TDI	Diesel	75	05/01 → 04/03					
2.5 TDI	Diesel	111	09/00 → 04/03	CHASSIS: 70X053925 →				
2.5 TDI	Diesel	65	12/98 → 04/03					
2.5 TDI	Diesel	65	12/98 → 04/03	CHASSIS: 70X053925 →				
2.5 TDI	Diesel	75	09/95 → 04/03	CHASSIS: 70X053925 →				
2.5 TDI	Diesel	75	05/99 → 04/03					
2.5 TDI	Diesel	75	09/95 → 04/03					
2.5 TDI Syncro	Diesel	75	03/98 → 04/01					
2.5 TDI Syncro	Diesel	75	05/01 → 04/03					
2.5 TDI Syncro	Diesel	75	09/95 → 04/03					
2.5 TDI Syncro	Diesel	75	09/95 → 04/03					
2.5 TDI Syncro	Diesel	75	03/98 → 04/03					



TYPE

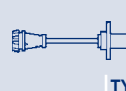

TYPE



TYPE

						SAD005	H3			
				ATS18	F2					
		APS39								
		APS40								
		APS39								
		APS40								
		APS39								
		APS40								
				SPA105	F1					
				SPA105	F1	SAG178	H1			
				SPA105	F1	SAG178	H1			
				ATS18	F2					
				SPA105	F1	SAG178	H1	ESS0018A	J1	
								GA2223	J2	
				SPA105	F1	SAG096	H1			
				SPA105	F1					
						SAG178	H1			
				SPA106	F1	SAD005	H3	ESS0018A	J1	
						SAA104				
						SAG178	H1	GA2223	J2	
				SPA109	F1					
						SAA104				
						SAD005	H3	ESS0018A	J1	
						SAG178	H1	GA2223	J2	
		APS39								
		APS40								
		APS39								
		APS40								
		APS39								
		APS40								
				SPA109	F1					
				SPA110	F1	SAG178	H1			
				SPA109	F1					
				SPA109	F1					
				ATS18	F2					
						SAG178	H1			
		APS39								
		APS40								
				SPA109	F1	SAG178	H1			
				SPA110	F1					
				ATS18	F2					



KW



TYPE



TYPE

VOLKSWAGEN

TRANSPORTER IV Furgonato (70XA)

2.8 VR6	Petrol	103	05/96 → 05/00	CHASSIS: 70X053925 →				
2.8 VR6	Petrol	150	06/00 → 04/03	CHASSIS: 70X053925 →				
2.8 VR6	Petrol	103	05/96 → 05/00					
2.8 VR6	Petrol	150	06/00 → 04/03					

TRANSPORTER IV Pianale piatto/Telaio (70XD)

2.0	Petrol	62	07/90 → 04/03					
2.0	Petrol	62	07/90 → 04/03	CHASSIS: 70T200001 →				
2.0	Petrol	62	07/90 → 04/03	CHASSIS: → 70X033612				
2.0	Petrol	62	07/90 → 04/03					
2.4 D	Diesel	55	08/97 → 04/03					
2.4 D Syncro	Diesel	57	10/92 → 09/98					
2.5	Petrol	85	05/99 → 04/03			AMM19670	B4	
2.5	Petrol	81	11/90 → 04/03					
2.5	Petrol	81	11/90 → 04/03	CHASSIS: 70T200001 →				
2.5	Petrol	85	08/96 → 04/03					
2.5	Petrol	81	11/90 → 04/03	CHASSIS: → 70X053924				
2.5	Petrol	85	08/96 → 04/03	CHASSIS: → 70X053924				
2.5	Petrol	81	11/90 → 04/03					
2.5	Petrol	81	01/94 → 10/96					
2.5	Petrol	85	08/96 → 04/03					
2.5 Syncro	Petrol	85	05/99 → 04/03			AMM19670	B4	
2.5 Syncro	Petrol	81	10/92 → 04/03	CHASSIS: 70T200001 →				
2.5 Syncro	Petrol	81	10/92 → 04/03	CHASSIS: 70X053925 →				
2.5 Syncro	Petrol	85	08/96 → 04/03	CHASSIS: 70X053925 →				
2.5 Syncro	Petrol	81	10/92 → 04/03	CHASSIS: → 70X053924				
2.5 Syncro	Petrol	85	08/96 → 04/03	CHASSIS: → 70X053924				
2.5 Syncro	Petrol	81	10/92 → 04/03					
2.5 Syncro	Petrol	81	01/94 → 10/96					
2.5 Syncro	Petrol	85	08/96 → 04/03					
2.5 Syncro	Petrol	85	08/96 → 04/03					
2.5 Syncro	Petrol	81	10/92 → 04/03					
2.5 Syncro	Petrol	81	10/92 → 04/03					
2.5 TDI	Diesel	65	05/98 → 04/01					
2.5 TDI	Diesel	65	05/01 → 04/03					
2.5 TDI	Diesel	75	09/95 → 04/01					
2.5 TDI	Diesel	75	05/01 → 04/03					
2.5 TDI	Diesel	65	05/98 → 04/03					
2.5 TDI	Diesel	65	05/98 → 04/03	CHASSIS: 70X053925 →				
2.5 TDI	Diesel	75	09/95 → 04/03	CHASSIS: 70X053925 →				
2.5 TDI	Diesel	75	05/99 → 04/03					
2.5 TDI	Diesel	75	09/95 → 04/03					
2.5 TDI Syncro	Diesel	75	05/98 → 04/01					
2.5 TDI Syncro	Diesel	75	05/01 → 04/03					
2.5 TDI Syncro	Diesel	75	05/98 → 04/03					
2.5 TDI Syncro	Diesel	75	05/98 → 04/03	CHASSIS: 70X053925 →				

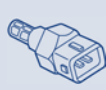
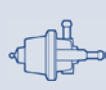

TYPE

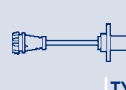

TYPE



TYPE

				SPA109	F1						
				SPA109	F1						
								SAG178	H1		
								SAG096	H1		
				SPA106	F1			SAG178	H1	ESS0018A	J1
				ATS18	F2						
						SAA104					
										GA2223	J2
								SAG178	H1		
				SPA105	F1			SAG178	H1		
				SPA106	F1			SAG178	H1	ESS0018A	J1
				ATS18	F2						
				SPA106	F1			SAD005	H3	ESS0018A	J1
						SAA104					
						SAA104					
										GA2223	J2
								SAD005	H3		
								SAG178	H1	GA2223	J2
				ATS18	F2						
				SPA109	F1						
				SPA109	F1						
						SAA104					
						SAA104					
								SAG178	H1	ESS0018A	J1
								SAD005	H3		
								SAD005	H3	ESS0018A	J1
								SAG178	H1	GA2223	J2
										GA2223	J2
		APS39									
		APS40									
		APS39									
		APS40									
				SPA110	F1			SAG178	H1		
				SPA109	F1						
				SPA109	F1						
				ATS18	F2						
								SAG178	H1		
		APS39									
		APS40									
				ATS18	F2			SAG178	H1		
				SPA109	F1						



KW



TYPE



TYPE

VOLKSWAGEN

TRANSPORTER IV Pianale piatto/Telaio (70XD)

2.8	Petrol	103	05/96 → 05/00					
2.8 VR6	Petrol	150	06/00 → 04/03	CHASSIS: 70X053925 →				

TRANSPORTER V Autobus (7HB, 7HJ, 7EB, 7EJ, 7EF)

1.9 TDI	Diesel	63	04/03 → 11/09					
1.9 TDI	Diesel	77	04/03 → 11/09					
1.9 TDI	Diesel	62	01/06 → 11/09					
1.9 TDI	Diesel	63	04/03 → 11/09					
1.9 TDI	Diesel	75	06/06 → 11/09					
1.9 TDI	Diesel	77	04/03 → 11/09					
2.0	Petrol	85	11/03 →					
2.0	Petrol	85	11/03 →					
2.0	Petrol	85	11/03 →					
2.0	Petrol	85	11/03 →					
2.0 BitDI	Diesel	132	09/09 →					
2.0 BitDI 4motion	Diesel	132	09/09 →					
2.0 TDi	Diesel	103	09/09 →					
2.0 TDi	Diesel	62	09/09 →					
2.0 TDi	Diesel	75	09/09 →					
2.0 TDi	Diesel	100	05/10 →					
2.0 TDi	Diesel	103	09/09 →					
2.0 TDi	Diesel	62	09/09 →					
2.0 TDi	Diesel	75	09/09 →					
2.0 TDi	Diesel	84	05/11 →					
2.0 TDI 4motion	Diesel	103	09/09 →					
2.0 TDI 4motion	Diesel	100	05/10 →					
2.0 TDI 4motion	Diesel	103	09/09 →					
2.0 TDI 4motion	Diesel	103	05/10 →					
2.0 TSI	Petrol	150	05/11 →					
2.0 TSI	Petrol	110	07/12 →					
2.0 TSI 4motion	Petrol	150	07/11 →					
2.5 TDI	Diesel	120	11/03 → 11/09			AMM19752	B4	
2.5 TDI	Diesel	128	04/03 → 11/09			AMM19752	B4	
2.5 TDI	Diesel	96	04/03 → 11/09			AMM19752	B4	
2.5 TDI 4motion	Diesel	128	07/04 → 11/09			AMM19752	B4	
2.5 TDI 4motion	Diesel	96	07/04 → 11/09			AMM19752	B4	
2.5 TDI 4motion	Diesel	96	05/06 →			AMM19752	B4	
3.2 V6	Petrol	170	02/04 → 06/04					
3.2 V6	Petrol	170	02/04 → 06/04					
3.2 V6	Petrol	173	02/04 → 11/09					
3.2 V6	Petrol	173	02/04 → 11/09					
3.2 V6 4motion	Petrol	173	11/03 → 11/09					



KW

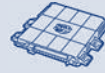

TYPE



TYPE

VOLKSWAGEN

TRANSPORTER V Furgonato (7HA, 7HH, 7EA, 7EH)

1.9 TDI	Diesel	63	04/03 → 11/09						
1.9 TDI	Diesel	77	04/03 → 11/09						
1.9 TDI	Diesel	62	01/06 → 11/09						
1.9 TDI	Diesel	63	04/03 → 11/09						
1.9 TDI	Diesel	75	06/06 → 11/09						
1.9 TDI	Diesel	77	04/03 → 11/09						
2.0	Petrol	85	11/03 →						
2.0	Petrol	85	11/03 →						
2.0	Petrol	85	11/03 →						
2.0	Petrol	85	11/03 →						
2.0 BiTDI	Diesel	132	09/09 →						
2.0 BiTDI 4motion	Diesel	132	09/09 →						
2.0 TDi	Diesel	103	09/09 →						
2.0 TDi	Diesel	62	09/09 →						
2.0 TDi	Diesel	75	09/09 →						
2.0 TDi	Diesel	100	05/10 →						
2.0 TDi	Diesel	103	09/09 →						
2.0 TDi	Diesel	62	09/09 →						
2.0 TDi	Diesel	75	09/09 →						
2.0 TDi	Diesel	84	05/11 →						
2.0 TDi 4motion	Diesel	103	09/09 →						
2.0 TDi 4motion	Diesel	100	05/10 →						
2.0 TDi 4motion	Diesel	103	09/09 →						
2.0 TSI	Petrol	150	05/11 →						
2.0 TSI	Petrol	110	07/12 →						
2.0 TSI 4motion	Petrol	150	07/11 →						
2.5 TDI	Diesel	128	04/03 → 11/09				AMM19752	B4	
2.5 TDI	Diesel	96	04/03 → 11/09				AMM19752	B4	
2.5 TDI 4motion	Diesel	128	07/04 → 11/09				AMM19752	B4	
2.5 TDI 4motion	Diesel	128	05/06 →				AMM19752	B4	
2.5 TDI 4motion	Diesel	96	07/04 → 11/09				AMM19752	B4	
2.5 TDI 4motion	Diesel	96	05/06 →				AMM19752	B4	
3.2 4motion	Petrol	173	11/03 → 11/09						
3.2 V6	Petrol	170	04/03 → 06/04						
3.2 V6	Petrol	170	04/03 → 06/04						
3.2 V6	Petrol	173	02/04 → 11/09						
3.2 V6	Petrol	173	02/04 → 11/09						

TRANSPORTER V Pianale piatto/Telaio (7JD, 7JE, 7JL, 7JY, 7JZ)

1.9 TDI	Diesel	63	04/03 → 11/09						
1.9 TDI	Diesel	77	04/03 → 11/09						
1.9 TDI	Diesel	62	01/06 → 11/09						
1.9 TDI	Diesel	63	04/03 → 11/09						
1.9 TDI	Diesel	75	06/06 → 11/09						
1.9 TDI	Diesel	77	04/03 → 11/09						

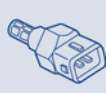
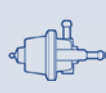

TYPE

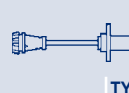

TYPE



TYPE

	APS40		ATS23	F2		SAG015	H2		
	APS40		ATS23	F2		SAG015	H2		
			SPA111	F1		SAG166	H1		
			SPA111	F1					
			SPA111	F1		SAG166	H1		
			SPA111	F1					
			ATS23	F2		SAC015	H2		
			SPA111	F1		SAC015-1	H2		
						SAD031	H3		
						SAG100	H1		
	APS70		SPA111	F1	SAA105			ESS0170A	J1
	APS70		SPA111	F1	SAA105			ESS0170A	J1
	APS70		ATS16	F2	SAA105			ESS0170A	J1
	APS70		ATS16	F2	SAA105			ESS0170A	J1
	APS70		ATS16	F2	SAA105			ESS0170A	J1
			SPA111	F1	SAA105			ESS0170A	J1
			SPA111	F1					
			SPA111	F1					
			SPA111	F1					
			SPA111	F1	SAA105			ESS0170A	J1
	APS70		ATS16	F2	SAA105			ESS0170A	J1
			SPA111	F1	SAA105			ESS0170A	J1
			SPA111	F1					
			SPA111	F1			BAE680BB		
							BAE680BB		
			SPA111	F1			BAE680BB		
			ATS23	F2					
			ATS23	F2					
			ATS23	F2					
			ATS23	F2					
			SPA111	F1					
			ATS23	F2		SAD031	H3		
			SPA111	F1					
			ATS23	F2		SAD031	H3		
			SPA111	F1					
	APS40		ATS23	F2		SAG015	H2		
	APS40		ATS23	F2		SAG015	H2		
			SPA111	F1		SAG166	H1		
			SPA111	F1					
			SPA111	F1		SAG166	H1		
			SPA111	F1					



KW

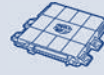

TYPE



TYPE

VOLKSWAGEN

TRANSPORTER V Pianale piatto/Telaio (7JD, 7JE, 7JL, 7JY, 7JZ)

2.0	Petrol	85	11/03 →					
2.0	Petrol	85	09/09 →					
2.0	Petrol	85	11/03 →					
2.0	Petrol	85	11/03 →					
2.0	Petrol	85	11/03 →					
2.0 BitDI	Diesel	132	09/09 →					
2.0 BitDI 4motion	Diesel	132	09/09 →					
2.0 BitDI 4motion	Diesel	132	01/10 →					
2.0 TDi	Diesel	103	09/09 →					
2.0 TDi	Diesel	62	09/09 →					
2.0 TDi	Diesel	75	09/09 →					
2.0 TDi	Diesel	100	05/10 →					
2.0 TDi	Diesel	103	09/09 →					
2.0 TDi	Diesel	62	09/09 →					
2.0 TDi	Diesel	75	09/09 →					
2.0 TDi	Diesel	84	05/11 →					
2.0 TDi 4motion	Diesel	103	09/09 →					
2.0 TDi 4motion	Diesel	100	05/10 →					
2.0 TDi 4motion	Diesel	103	09/09 →					
2.0 TSI	Petrol	110	07/12 →					
2.5 TDI	Diesel	128	04/03 → 11/09				AMM19752	B4
2.5 TDI	Diesel	96	04/03 → 11/09				AMM19752	B4
2.5 TDI 4motion	Diesel	128	04/04 → 11/09				AMM19752	B4
2.5 TDI 4motion	Diesel	96	07/04 → 11/09				AMM19752	B4
3.2 V6	Petrol	170	02/04 → 11/09					
3.2 V6	Petrol	170	02/04 → 11/09					
3.2 V6	Petrol	173	08/03 → 05/06					

UP

1.0	Petrol	44	08/11 →					
1.0	Petrol	55	08/11 →					

VENTO (1H2)

1.4	Petrol	44	11/91 → 09/98				TB0010	B3
1.4	Petrol	44	11/91 → 09/98					
1.4	Petrol	40	11/91 → 09/98					
1.4	Petrol	40	11/91 → 09/98					
1.6	Petrol	55	09/92 → 09/98				TB0010	B3
1.6	Petrol	55	09/92 → 09/98					
1.6	Petrol	74	10/94 → 09/98					
1.6	Petrol	74	10/94 → 09/98	CHASSIS: → 1HX015000				
1.6	Petrol	74	10/94 → 09/98					
1.6	Petrol	55	09/92 → 12/97	ENGINE: AEA				
1.6	Petrol	74	10/94 → 12/97	ENGINE: AEK-AFT				
1.8	Petrol	55	11/91 → 09/98					
1.8	Petrol	55	11/91 → 12/97					



TYPE

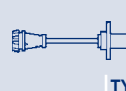

TYPE



TYPE

				ATS23	F2		SAC015	H2		
				SPA111	F1					
							SAC015-1	H2		
							SAD031	H3		
							SAG100	H1		
	APS70			SPA111	F1	SAA105				ESS0170A J1
	APS70					SAA105				ESS0170A J1
				SPA111	F1					
	APS70			ATS16	F2	SAA105				ESS0170A J1
	APS70			ATS16	F2	SAA105				ESS0170A J1
	APS70			ATS16	F2	SAA105				ESS0170A J1
				SPA111	F1	SAA105				ESS0170A J1
				SPA111	F1					
				SPA111	F1					
				SPA111	F1	SAA105				
	APS70			ATS16	F2	SAA105				ESS0170A J1
				SPA111	F1	SAA105				ESS0170A J1
				SPA111	F1					
										BAE680BB
				ATS23	F2					
				ATS23	F2					
				ATS23	F2					
				ATS23	F2		SAD031	H3		
				SPA111	F1					
				ATS23	F2		SAD031	H3		
						SAA105				BAE680CN GA2151 J2
						SAA105				BAE680CN GA2151 J2
				SPA110	F1	SAA104	SAG026	H1		ESS0018A J1
										GA2222 J2
						SAA102	SAG026	H1		ESS0018A J1
						SAA104				GA2222 J2
	IWP023			SPA110	F1	SAA104	SAG026	H1		ESS0018A J1
										GA2222 J2
				SPA110	F1		SAD021	H3		ESS0018A J1
						SAA104				
							SAG064	H1		GA2222 J2
										GA2032 J2
										GA2032 J2
				SPA110	F1	SAA104	SAG026	H1		ESS0019A J1
				SPA143	F1					



KW

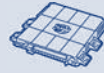

TYPE



TYPE

VOLKSWAGEN

VENTO (1H2)

1.8	Petrol	66	11/91 → 09/98						
1.8	Petrol	66	11/91 → 09/94						
1.8	Petrol	66	01/94 → 09/98						
1.8	Petrol	55	11/91 → 09/98						
1.8	Petrol	66	11/91 → 09/98						
1.9 D	Diesel	48	11/91 → 09/98						
1.9 SDI	Diesel	47	04/97 → 09/98						
1.9 TD	Diesel	55	11/91 → 09/98						
1.9 TDI	Diesel	66	09/93 → 07/94						
1.9 TDI	Diesel	66	09/93 → 09/98						
2.0	Petrol	85	10/94 → 07/95				AMM19672	B4	
2.0	Petrol	85	11/91 → 09/98						
2.0	Petrol	85	07/94 → 09/98						
2.0	Petrol	85	11/91 → 09/98						
2.0	Petrol	85	01/92 → 12/97	ENGINE: ADY-AGG-AKR					
2.8 VR6	Petrol	128	01/92 → 12/97						
2.8 VR6	Petrol	128	01/92 → 09/98						
2.8 VR6	Petrol	128	01/92 → 09/98						
2.8 VR6	Petrol	128	01/92 → 12/97	ENGINE: AAA					

VOLVO

240 (P242, P244)

2.3	Petrol	83	08/86 → 07/87	ENGINE: B230F					
2.3 i Cat.	Petrol	85	08/88 → 07/92						
2.3 i Cat.	Petrol	85	01/88 → 07/93						
2.4 Diesel	Diesel	58	08/87 → 08/93						
2.4 Diesel	Diesel	60	01/79 → 07/85						

240 Kombi (P245)

2.3 Cat.	Petrol	100	08/91 → 07/92	ENGINE: B230F					
2.3 i Cat.	Petrol	85	08/88 → 07/92						
2.3 i Cat.	Petrol	85	01/88 → 07/93						
2.4 Diesel	Diesel	58	08/88 → 08/93						
2.4 Diesel	Diesel	60	04/79 → 08/93						

440 K (445)

1.7	Petrol	75	08/89 → 07/91				SVF015	B6	
1.7	Petrol	75	08/89 → 12/96						
1.7	Petrol	78	09/88 → 12/96						
1.7 Turbo	Petrol	88	08/88 → 07/96						
1.8	Petrol	66	08/91 → 07/96						
1.9 Turbo-Diesel	Diesel	66	01/95 → 12/96						
2.0	Petrol	80	08/93 → 07/96				SVF015	B6	
2.0	Petrol	81	08/92 → 07/95				SVF015	B6	



TYPE

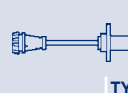

TYPE



TYPE

			SPA110	F1	SAA104	SAG178	H1		ESS0019A	J1
			SPA143	F1						
			SPA105	F1						
									GA2222	J2
									GA2222	J2
			SPA140	F1		SAG178	H1			
			SPA106	F1		SAG142	H1			
			SPA105	F1		SAG178	H1			
	APS29									
			SPA105	F1		SAG142	H1			
			SPA110	F1	SAA104	SAG118	H1		ESS0018A	J1
			SPA105	F1						
									GA2222	J2
									GA2032	J2
IWP022										
			SPA106	F1		SAG178	H1		ESS0018A	J1
									GA2222	J2
									GA2032	J2
									ESS0162A	J1
			SPA129	F1						
						SAG059	H1			
						SAA102	SAG059	H1		
						SAA102				
									ESS0162A	J1
			SPA129	F1						
						SAG059	H1			
						SAA102	SAG059	H1		
						SAA102				
	APS45									
	APS45		SPA160	F1						
			SPA129	F1						
	APS45		SPA160	F1					ESS0090A	J1
			SPA160	F1						
	APS45									
	APS45									



KW



TYPE



TYPE

VOLVO

460 L (464)

1.7	Petrol	75	03/90 → 07/92					SVF015	B6
1.7	Petrol	75	08/89 → 07/92						
1.7 Turbo	Petrol	88	03/90 → 07/96						
1.8	Petrol	66	08/91 → 07/96						
1.9 Turbo-Diesel	Diesel	66	01/95 → 07/96						
2.0	Petrol	80	08/93 → 07/96					SVF015	B6
2.0	Petrol	81	08/92 → 07/95					SVF015	B6

480 E

1.7	Petrol	75	08/89 → 12/93					SVF015	B6
1.7	Petrol	75	08/89 → 07/96						
1.7	Petrol	78	04/86 → 07/89						
1.7	Petrol	80	08/86 → 07/88						
1.7 Turbo	Petrol	88	08/88 → 07/95						
1.7 Turbo	Petrol	90	01/91 → 07/95						
2.0	Petrol	81	08/92 → 09/95					SVF015	B6

740 (744)

2.0	Petrol	118	01/86 → 07/89						
2.0	Petrol	82	09/90 → 08/92	ENGINE: B200F					
2.3	Petrol	83	09/85 → 12/89						
2.3	Petrol	84	08/84 → 07/90						
2.3	Petrol	85	08/87 → 12/90						
2.3	Petrol	85	08/87 → 07/92						
2.4 Diesel	Diesel	60	08/84 → 07/92						
2.4 TD	Diesel	83	08/84 → 07/90						

740 Kombi (745)

2.0	Petrol	82	08/89 → 07/91	ENGINE: B200F					
2.3	Petrol	83	08/85 → 12/89						
2.3	Petrol	85	08/87 → 12/90						
2.3	Petrol	85	08/87 → 07/92						
2.3	Petrol	114	08/88 → 07/90	ENGINE: B234F					
2.3	Petrol	87	01/88 → 10/90	ENGINE: B230F					
2.3 Turbo	Petrol	115	08/86 → 07/89						
2.3 Turbo	Petrol	121	08/89 → 07/90						
2.4 Diesel	Diesel	60	08/85 → 07/88						
2.4 TD Interc.	Diesel	90	08/86 → 07/88						
2.4 Turbo-Diesel	Diesel	80	09/85 → 07/92						

760 (704, 764)

2.4 D	Diesel	60	01/82 → 07/92						
2.4 TD Interc. (704)	Diesel	85	08/87 → 07/92						
2.4 Turbo Diesel (704)	Diesel	80	04/87 → 07/92						
2.4 Turbo Diesel (704)	Diesel	82	08/82 → 07/87						
2.8 (704)	Petrol	105	05/86 → 08/91						
2.8 (704)	Petrol	105	05/86 → 08/91						
2.8 (704, 764)	Petrol	115	08/81 → 07/88						



TYPE

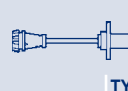

TYPE



TYPE

			SPA129	F1					
	APS45		SPA160	F1					
			SPA129	F1					
	APS45		SPA160	F1				ESS0090A	J1
			SPA160	F1					
	APS45								
	APS45								
	APS45								
	APS45								
	APS45								
			SPA129	F1					
			SPA129	F1					
	APS45								
						SAG047	H1		
								ESS0162A	J1
			SPA104	F1					
			SPA104	F1					
			SPA104	F1					
						SAG059	H1		
					SAA102	SAG059	H1		
					SAA102	SAG059	H1		
								ESS0162A	J1
			SPA104	F1					
			SPA104	F1					
						SAG059	H1		
								ESS0162A	J1
								ESS0162A	J1
			SPA104	F1					
			SPA104	F1		SAG059	H1		
					SAA102				
					SAA102				
					SAA102	SAG059	H1		
						SAG059	H1		
					SAA102	SAG059	H1		
					SAA102	SAG059	H1		
					SAA102				
						SAD013	H3		
						SAG066	H1		
						SAD013	H3		



KW

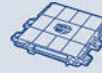

TYPE



TYPE

VOLVO

760 Kombi (704, 765)

2.3 Turbo	Petrol	134	08/84 → 07/89						
2.4 D	Diesel	60	01/82 → 07/92						
2.8 (765)	Petrol	105	05/86 → 08/91						
2.8 (765)	Petrol	105	05/86 → 08/91						

850 (LS)

2.0	Petrol	105	09/91 → 12/96					SVF015	B6
2.0	Petrol	93	08/94 → 12/96					SVF015	B6
2.0	Petrol	105	06/91 → 12/96						
2.5	Petrol	103	09/92 → 07/94					SVF015	B6
2.5	Petrol	106	08/94 → 12/96					SVF015	B6
2.5	Petrol	125	08/91 → 12/96					SVF015	B6
2.5	Petrol	103	06/91 → 07/94						
2.5 TDI	Diesel	103	08/95 → 12/96						

850 Station wagon (LW)

2.0	Petrol	93	08/94 → 12/96					SVF015	B6
2.5	Petrol	103	08/92 → 07/94					SVF015	B6
2.5	Petrol	125	09/92 → 12/96					SVF015	B6
2.5 TDI	Diesel	103	08/95 → 12/96						

940 (944)

2.0	Petrol	82	01/92 → 07/94						
2.0	Petrol	82	01/92 → 07/94	ENGINE: B200F					
2.0 Turbo	Petrol	114	08/90 → 12/94						
2.3	Petrol	114	08/90 → 07/91						
2.3	Petrol	85	08/92 → 07/94						
2.3	Petrol	96	06/91 → 12/94						
2.3	Petrol	96	08/90 → 12/94						
2.3 Turbo	Petrol	121	08/90 → 07/94						
2.4 D	Diesel	60	08/90 → 12/94						

940 II (944)

2.0 Turbo	Petrol	114	04/96 → 07/97						
2.3	Petrol	85	08/94 → 07/95						
2.3	Petrol	96	08/94 → 07/95						
2.3	Petrol	96	08/94 → 10/98						
2.3 ti	Petrol	99	01/95 → 07/97						
2.3 ti	Petrol	99	01/95 → 10/98						
2.3 Turbo	Petrol	121	08/94 → 07/97						
2.4 TD Interc.	Diesel	90	08/94 → 10/98						

940 II Station wagon (945)

2.0 Turbo	Petrol	114	04/96 → 07/97						
2.3	Petrol	85	08/94 → 07/95						
2.3	Petrol	96	08/94 → 07/95						
2.3	Petrol	96	08/94 → 10/98						
2.3 ti	Petrol	99	01/95 → 07/97						
2.3 ti	Petrol	99	01/95 → 10/98						



KW



TYPE



TYPE

VOLVO

940 II Station wagon (945)

2.3 Turbo	Petrol	121	08/94 → 07/97
2.4 TD Interc.	Diesel	90	08/94 → 10/98

940 Kombi (945)

2.0	Petrol	82	01/92 → 07/94	
2.0	Petrol	82	01/92 → 07/94	ENGINE: B200F
2.0 Turbo	Petrol	114	09/91 → 07/95	
2.0 Turbo	Petrol	114	01/91 → 07/95	
2.3	Petrol	85	08/92 → 07/94	
2.3	Petrol	96	06/91 → 12/94	
2.3	Petrol	96	08/90 → 12/94	
2.3 Turbo	Petrol	121	08/90 → 07/94	
2.4 D	Diesel	60	08/90 → 07/95	
2.4 TD Intercooler	Diesel	90	08/90 → 08/94	

960 (964)

2.0	Petrol	103	09/91 → 08/93	
2.0	Petrol	140	09/91 → 09/93	
2.4 TD Interc.	Diesel	85	09/91 → 07/94	
2.9	Petrol	150	08/90 → 07/94	SVF015 B6

960 II (964)

2.5	Petrol	125	07/94 → 12/96	SVF015 B6
2.9	Petrol	150	07/94 → 12/96	SVF015 B6

960 II Station wagon (965)

2.5	Petrol	125	08/94 → 12/96	SVF015 B6
2.9	Petrol	150	09/94 → 12/96	SVF015 B6

960 Kombi (965)

2.0	Petrol	103	09/91 → 08/93	
2.0	Petrol	140	09/91 → 09/93	
2.4 TD Interc.	Diesel	85	09/91 → 07/94	
2.9	Petrol	150	08/90 → 07/94	SVF015 B6

C30

1.6	Petrol	74	10/06 → 12/12	
1.6 D	Diesel	80	10/06 → 12/12	
1.6 D	Diesel	80	10/06 → 12/12	
1.8	Petrol	92	10/06 → 07/10	
1.8	Petrol	92	10/06 → 12/12	
1.8	Petrol	92	10/06 → 12/12	
1.8 FlexFuel	BiFuel	92	01/07 → 07/10	
1.8 FlexFuel	BiFuel	92	01/07 → 12/12	
1.8 FlexFuel	BiFuel	92	01/07 → 12/12	
2.0	Petrol	107	10/06 → 12/12	
2.0	Petrol	107	10/06 → 12/12	
2.0 D	Diesel	100	10/06 → 12/12	
2.0 D	Diesel	100	10/06 → 12/12	
2.0 FlexFuel	BiFuel	107	01/10 → 12/12	

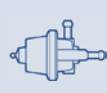

TYPE

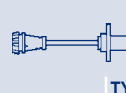

TYPE



TYPE

				SPA129	F1					
						SAA102				
				SPA129	F1		SAG059	H1		
									ESS0162A	J1
				SPA129	F1					
							SAG059	H1		
				SPA129	F1		SAG059	H1		
				SPA129	F1					
							SAG059	H1		
				SPA129	F1		SAG059	H1		
							SAG059	H1		
							SAG059	H1		
				SPA129	F1					
				SPA129	F1					
						SAA102	SAG059	H1		
							SAG059	H1		
							SAG084	H1		
							SAG084	H1		
							SAG084	H1		
							SAG084	H1		
				SPA129	F1					
				SPA129	F1					
						SAA102	SAG059	H1		
							SAG059	H1		
	APS13					SAA115	SAD037	H3	BAE680DX	GA2113
				ATS22	F2	SAA118	SAC096	H2		
				SPA172	F1		SAG167	H1		
FEI0014						SAA115	SAC092	H2		
							SAD036	H3		
FEI0009						SAA115	SAC092	H2		
							SAD036	H3		
FEI0014						SAA115	SAC092	H2		
							SAD036	H3		
				ATS22	F2	SAA118	SAC096	H2		
				SPA172	F1		SAG169	H1		
							SAC092	H2		



KW



TYPE



TYPE

VOLVO

C30

2.4 i	Petrol	125	10/06 → 12/10						
2.4 i	Petrol	125	10/06 → 07/10						
2.4 i	Petrol	125	10/06 → 12/12						
D5	Diesel	120	10/06 → 12/12						
D5	Diesel	132	10/06 → 12/12						
D5	Diesel	120	10/06 → 12/10						
D5	Diesel	132	10/06 → 12/10						
T5	Petrol	162	10/06 → 12/12						
T5	Petrol	162	10/06 → 05/07						
T5	Petrol	169	06/07 → 12/12						
T5	Petrol	162	10/06 → 07/07						
T5	Petrol	169	03/07 → 12/12						

C70 I Cabriolet

2.0	Petrol	132	03/98 → 07/98				SVF015	B6	
2.0	Petrol	132	03/98 → 10/05						
2.0 T	Petrol	120	03/00 → 10/05						
2.0 T	Petrol	166	03/98 → 10/05						
2.0 T	Petrol	120	01/02 → 10/05						
2.0 T	Petrol	166	03/98 → 07/98						
2.0 T	Petrol	166	08/98 → 07/00						
2.3 T5	Petrol	176	08/98 → 07/02				SVF015	B6	
2.3 T5	Petrol	180	07/02 → 10/05				SVF015	B6	
2.3 T5	Petrol	176	03/98 → 10/05						
2.3 T5	Petrol	176	03/98 → 07/98						
2.3 T5	Petrol	176	01/02 → 10/05						
2.4 T	Petrol	147	07/02 → 10/05				SVF015	B6	
2.5	Petrol	125	03/99 → 07/00				SVF015	B6	
2.5	Petrol	125	06/98 → 10/05						
2.5 T	Petrol	142	08/98 → 07/99				SVF015	B6	
2.5 T	Petrol	142	01/99 → 10/05						
2.5 T	Petrol	142	03/98 → 10/05						
2.5 T	Petrol	142	03/98 → 07/98						
2.5 T	Petrol	142	05/01 → 10/05						

C70 I Coupé

2.0	Petrol	132	03/97 → 07/98				SVF015	B6	
2.0	Petrol	132	03/97 → 09/02						
2.0 T	Petrol	166	03/97 → 07/00				SVF015	B6	
2.0 T	Petrol	120	03/00 → 09/02						
2.0 T	Petrol	166	03/97 → 09/02						
2.0 T	Petrol	120	01/02 → 09/02						
2.0 T	Petrol	166	03/97 → 07/98						
2.0 T	Petrol	120	03/00 → 07/02						
2.0 T	Petrol	166	08/98 → 07/00						
2.3 T-5	Petrol	176	09/97 → 09/02				SVF015	B6	



TYPE

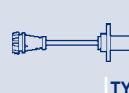

TYPE



TYPE

							SAC090	H2		
									BAE680BV	
									GA2080	J2
						SAA118				
						SAA118			GA2072	J2
							SAC090	H2		
							SAC090	H2		
		APS22							GA2085	J2
							SAC090	H2		
							SAC090	H2		
									BAE680BV	
									GA2060	J2
							SAG084	H1		
									BAE680BF	ESS0138A
		APS31	SPA139	F1					BAE680AR	ESS0138A
		APS31	SPA139	F1						ESS0138A
							SAC090	H2		
							SAG084	H1		
									BAE680AR	
									BAE680AR	
							SAC090	H2	BAE680AR	ESS0138A
			SPA139	F1						ESS0138A
							SAG084	H1		
							SAC090	H2		
							SAC090	H2	BAE680AR	ESS0138A
									BAE680AR	
										ESS0138A
		APS31								
			SPA139	F1					BAE680AR	
							SAG084	H1		
							SAC090	H2		
							SAG084	H1	BAE680BF	ESS0138A
		APS31	SPA139	F1						ESS0138A
			SPA139	F1					BAE680BF	
							SAC090	H2		
							SAG084	H1		
									BAE680AR	
									BAE680AR	



KW

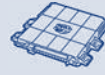

TYPE



TYPE

VOLVO

C70 I Coupé

2.3 T-5	Petrol	176	03/97 → 09/02					
2.3 T-5	Petrol	176	03/97 → 07/98					
2.3 T-5	Petrol	176	01/02 → 09/02					
2.5	Petrol	121	03/99 → 07/00				SVF015	B6
2.5	Petrol	125	05/99 → 07/00				SVF015	B6
2.5	Petrol	121	03/99 → 09/02					
2.5	Petrol	125	05/99 → 09/02					
2.5 T	Petrol	142	01/98 → 07/99				SVF015	B6
2.5 T	Petrol	142	01/99 → 09/02					
2.5 T	Petrol	142	03/97 → 09/02					
2.5 T	Petrol	142	03/97 → 07/98					
2.5 T	Petrol	142	01/02 → 09/02					

C70 II Cabriolet

2.0 D	Diesel	100	01/08 →					
2.0 D	Diesel	100	01/08 →					
2.4	Petrol	103	03/06 →					
2.4	Petrol	103	03/06 → 07/10					
2.4 i	Petrol	125	03/06 → 12/10					
2.4 i	Petrol	125	03/06 → 07/10					
D5	Diesel	132	03/06 →					
D5	Diesel	132	03/06 → 12/10					
T5	Petrol	162	03/06 → 07/07					
T5	Petrol	162	03/06 → 02/07					
T5	Petrol	169	03/07 →					
T5	Petrol	162	03/06 →					

S40 I (VS)

1.6	Petrol	80	03/99 → 12/03	ENGINE: B4164S2				
1.6	Petrol	80	03/99 → 12/03					
1.8	Petrol	85	07/95 → 08/99					
1.8	Petrol	90	03/99 → 12/03	ENGINE: B4184S2				
1.8	Petrol/CNG	85	06/01 → 08/03	ENGINE: B4184S2				
1.8	Petrol	90	03/99 → 12/03					
1.8 i	Petrol	90	06/01 → 12/03					
1.8 i	Petrol	92	03/98 → 12/03					
1.9 DI	Diesel	75	07/00 → 12/03					
1.9 DI	Diesel	85	07/00 → 12/03					
1.9 DI	Diesel	70	03/99 → 07/00					
1.9 T4	Petrol	147	05/97 → 07/00					
1.9 T4	Petrol	147	05/97 → 07/00	ENGINE: B4194T,B4194T2				
2.0	Petrol	100	07/95 → 12/03					
2.0 T	Petrol	118	10/97 → 12/03					
2.0 T	Petrol	120	06/01 → 12/03					
2.0 T	Petrol	121	07/00 → 06/01					
2.0 T	Petrol	118	10/97 → 12/03	ENGINE: B4204T				



TYPE

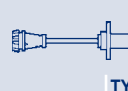

TYPE



TYPE

			SPA139	F1				BAE680AR	ESS0138A	J1
						SAG084	H1			
						SAC090	H2			
								BAE680AR		
								BAE680AR		
			SPA139	F1					ESS0138A	J1
			SPA139	F1					ESS0138A	J1
		APS31								
			SPA139	F1				BAE680AR	ESS0138A	J1
						SAG084	H1			
						SAC090	H2			
		APS38	ATS22	F2	SAA118	SAC096	H2			
			SPA172	F1		SAG169	H1			
						SAC090	H2			
								BAE680BV		
						SAC090	H2			
								BAE680BV		
					SAA118				GA2072	J2
						SAC090	H2			
		APS22								
						SAC090	H2			
						SAC090	H2	BAE680BV	GA2078	J2
								BAE680BV	GA2078	J2
			DPR04							
			SPA135	F1		SAG085	H1			
		APS45	SPA135	F1		SAG085	H1			
			DPR04							
			DPR04							
			SPA135	F1		SAG085	H1			
			SPA142	F1		SAC030	H2			
			SPA142	F1		SAC030	H2			
		APS28	SPA169	F1		SAG153	H1			
		APS28	SPA169	F1		SAG153	H1			
						SAG052	H1			
		APS31	SPA135	F1		SAG086	H1			
			DPR04							
			SPA135	F1		SAG085	H1			
		APS31	SPA135	F1		SAG086	H1			
		APS31	SPA135	F1		SAG086	H1			
		APS31				SAG086	H1			
			DPR04							



KW



TYPE



TYPE

VOLVO

S40 I (VS)

2.0 T4	Petrol	147	07/00 → 12/03						
--------	--------	-----	---------------	--	--	--	--	--	--

S40 II (MS)

1.6	Petrol	74	01/05 →						
1.6	Petrol	74	01/05 →	CHASSIS: 106167 →					
1.6 D	Diesel	81	01/05 →						
1.6 D	Diesel	81	01/05 →						
1.8	Petrol	92	04/04 → 07/10						
1.8	Petrol	92	04/04 →						
1.8	Petrol	92	04/04 →						
1.8 FlexFuel	BiFuel	92	04/06 → 07/10						
1.8 FlexFuel	BiFuel	92	01/06 →						
1.8 FlexFuel	BiFuel	92	01/06 →						
2.0	Petrol	107	10/06 → 08/12						
2.0	Petrol	107	10/06 →						
2.0	Petrol	107	10/06 →						
2.0 D	Diesel	100	01/04 →						
2.0 D	Diesel	100	01/04 →						
2.0 F	BiFuel	107	10/06 →						
2.4	Petrol	103	01/04 →						
2.4	Petrol	125	01/04 →						
2.4	Petrol	103	01/04 → 07/10						
2.4 AWD	Petrol	125	08/06 →						
2.4 D5	Diesel	132	03/06 →						
T5	Petrol	162	01/04 → 07/07						
T5	Petrol	169	08/07 →						
T5	Petrol	162	01/04 →						
T5	Petrol	169	03/07 →						
T5 AWD	Petrol	162	04/04 → 07/07						
T5 AWD	Petrol	169	08/07 →						
T5 AWD	Petrol	162	04/04 →						
T5 AWD	Petrol	169	03/07 →						

S60 I

2.0 T	Petrol	132	08/02 → 07/09						
2.0 T	Petrol	132	07/00 → 04/10						
2.0 T	Petrol	132	01/02 → 04/10						
2.0 T	Petrol	132	07/00 → 07/04						
2.0 T	Petrol	132	08/04 → 07/09						
2.0 T	Petrol	132	07/00 → 04/10						
2.3 T5	Petrol	195	08/02 → 09/02						
2.3 T5	Petrol	195	01/02 → 09/02						
2.3 T5	Petrol	195	07/00 → 09/02						
2.4	Petrol	103	11/00 → 04/10						
2.4	Petrol	103	01/03 → 04/10						
2.4	Petrol	125	11/00 → 04/10						

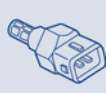
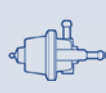

TYPE

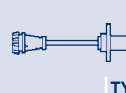

TYPE



TYPE

	APS31		SPA135	F1		SAG086	H1			
	APS13				SAA115	SAD037	H3	GA2113	J2	
								BAE680DX		
			ATS22	F2	SAA118	SAC096	H2			
			SPA172	F1		SAG167	H1			
FEI0014										
	APS19				SAA115	SAC092	H2			
						SAD036	H3			
FEI0009										
	APS19				SAA115	SAC092	H2			
						SAD036	H3			
FEI0014										
	APS19				SAA115	SAC092	H2			
						SAD036	H3			
			ATS22	F2	SAA118	SAC096	H2			
			SPA172	F1		SAG169	H1			
						SAC092	H2			
						SAC090	H2	GA2088	J2	
						SAC090	H2	BAE680BV	GA2088	J2
								BAE680BV		
						SAC090	H2			
					SAA118	SAC090	H2			
	APS22									
	APS22									
						SAC090	H2	BAE680BV	GA2050	J2
						SAC090	H2	BAE680BV	GA2060	J2
	APS22									
	APS22									
						SAC090	H2	BAE680BV		
						SAC090	H2	BAE680BV	GA2060	J2
	APS22									
			SPA139	F1					ESS0133A	J1
						SAC090	H2			
								BAE680AR		
								BAE680BV		
									GA2134	J2
	APS22									
						SAC090	H2			
								BAE680AR		
			SPA139	F1					ESS0133A	J1
			SPA168	F1						
			SPA139	F1				BAE680AR		



KW



TYPE



TYPE

VOLVO

S60 I

2.4	Petrol	125	01/03 → 04/10					
2.4	Petrol	103	01/02 → 04/10					
2.4	Petrol	125	01/02 → 04/10					
2.4	Petrol	103	11/00 → 07/09					
2.4	Petrol	125	09/04 → 08/05					
2.4 AWD	Petrol	191	02/04 → 04/10					
2.4 Bifuel (CNG)	Petrol/CNG	103	06/02 → 04/10					
2.4 Bifuel (CNG)	Petrol/CNG	103	01/03 → 04/10					
2.4 Bifuel (CNG)	Petrol/CNG	103	06/02 → 07/08					
2.4 D	Diesel	96	12/01 → 04/10					
2.4 D	Diesel	120	09/05 → 01/09					
2.4 D	Diesel	93	09/05 → 04/10					
2.4 D5	Diesel	120	07/01 → 04/10					
2.4 D5	Diesel	136	09/05 → 04/10					
2.4 T	Petrol	147	11/00 → 12/02					
2.4 T	Petrol	147	08/02 → 07/03					
2.4 T	Petrol	147	11/00 → 04/10					
2.4 T	Petrol	147	01/02 → 04/10					
2.4 T AWD	Petrol	147	11/01 → 12/02					
2.4 T AWD	Petrol	147	08/02 → 07/03					
2.4 T AWD	Petrol	147	11/01 → 04/10					
2.4 T AWD	Petrol	147	01/02 → 04/10					
2.4 T5	Petrol	191	04/04 → 04/10					
2.4 T5	Petrol	191	04/04 → 04/10					
2.5 T	Petrol	154	02/04 → 04/10					
2.5 T	Petrol	154	04/04 → 07/09					
2.5 T	Petrol	154	09/04 → 07/09					
2.5 T AWD	Petrol	154	04/04 → 04/10					
2.5 T AWD	Petrol	154	04/04 → 07/09					
2.5 T AWD	Petrol	154	04/04 → 04/10					
2.5 T AWD	Petrol	154	09/04 → 07/09					
R 2,5 T AWD	Petrol	221	03/03 → 04/10					
R 2,5 T AWD	Petrol	221	09/03 → 08/04					
T5	Petrol	184	11/00 → 12/02					
T5	Petrol	184	08/02 → 03/04					
T5	Petrol	184	11/00 → 04/10					
T5	Petrol	184	01/02 → 04/10					

S60 II

2.0 T	Petrol	149	08/10 → 07/11					
D3	Diesel	120	04/10 → 04/12					
D5	Diesel	151	04/10 → 05/11					
D5 AWD	Diesel	151	04/10 → 05/11					
DRIVE / D2	Diesel	84	01/11 →	ENGINE: D4162T			AMM19770	B4
T5	Petrol	177	11/10 → 07/11					

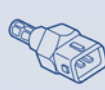
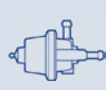

TYPE

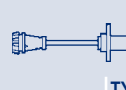

TYPE



TYPE

				SPA168	F1									
								SAC090	H2					
								SAC090	H2					
												BAE680AR		
												BAE680BV		
												BAE680BV		
				SPA139	F1			SAC090	H2					
				SPA168	F1									
												BAE680AR		
				SPA168	F1			SAC094	H2			GA2182	J2	
								SAC090	H2					
								SAC090	H2					
				SPA168	F1			SAC094	H2			GA2182	J2	
								SAC090	H2					
		APS31												
		APS22												
				SPA139	F1							BAE680AR	GA2134	J2
				SPA168	F1			SAC090	H2					
		APS31												
		APS22												
				SPA139	F1			SAC090	H2			BAE680AR	GA2134	J2
				SPA168	F1									
								SAC090	H2			BAE680BV	ESS0133A	J1
												GA2134	J2	
		APS31		SPA168	F1			SAC090	H2			BAE680AR	GA2134	J2
		APS22												
												BAE680BV		
		APS31		SPA168	F1			SAC090	H2			BAE680AR	ESS0133A	J1
		APS22												
													GA2134	J2
												BAE680BV		
				SPA168	F1			SAC090	H2			BAE680BV	GA2134	J2
												BAE680AR		
		APS31												
		APS22												
				SPA139	F1							BAE680AR	GA2134	J2
				SPA168	F1			SAC090	H2					
												BAE680DY		
								SAC090	H2					
								SAC090	H2					
								SAC090	H2					
												BAE680DY		



KW

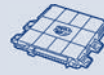

TYPE



TYPE

VOLVO

S70 (LS)

2.0	Petrol	120	08/98 → 07/00					SVF015	B6
2.0	Petrol	120	01/97 → 11/00						
2.0	Petrol	120	01/97 → 07/98						
2.3	Petrol	195	04/99 → 07/00						
2.3 T5 AWD	Petrol	177	11/96 → 09/98						
2.4	Petrol	103	08/99 → 07/00					SVF015	B6
2.4	Petrol	103	08/99 → 11/00						
2.4 AWD	Petrol	103	04/99 → 09/00						
2.4 AWD	Petrol	106	11/96 → 05/99						
2.4 AWD	Petrol	125	04/99 → 09/00						
2.4 AWD	Petrol	125	08/99 → 07/00						
2.4 T5 AWD	Petrol	142	11/96 → 04/99						
2.5	Petrol	121	06/98 → 07/99					SVF015	B6
2.5	Petrol	121	06/98 → 11/00						
2.5 Bifuel	Petrol/CNG	106	10/98 → 07/99					SVF015	B6
2.5 Bifuel	Petrol/CNG	106	10/98 → 11/00						
2.5 Bifuel	Petrol/CNG	103	07/99 → 11/00						
2.5 Bifuel	Petrol/CNG	103	08/99 → 07/00						

S80 I (TS, XY)

2.0	Petrol	120	06/98 → 12/02						
2.0	Petrol	120	06/98 → 07/06						
2.0	Petrol	120	08/98 → 07/00						
2.0 T	Petrol	132	12/99 → 07/06						
2.0 T	Petrol	132	12/99 → 07/02						
2.0 T	Petrol	166	06/98 → 07/06						
2.0 T	Petrol	166	06/98 → 12/02						
2.0 T	Petrol	132	01/02 → 07/06						
2.0 T	Petrol	132	12/99 → 07/04						
2.0 T	Petrol	132	08/04 → 07/06						
2.0 T	Petrol	166	08/98 → 07/00						
2.3 R	Petrol	195	04/00 → 07/05						
2.4	Petrol	103	01/99 → 07/06						
2.4	Petrol	125	01/99 → 07/06						
2.4	Petrol	103	01/02 → 07/06						
2.4	Petrol	125	01/02 → 07/06						
2.4 Bifuel (CNG)	Petrol/CNG	103	09/01 → 07/06						
2.4 Bifuel (CNG)	Petrol/CNG	103	01/02 → 07/06						
2.4 D	Diesel	96	10/01 → 07/06						
2.4 D5	Diesel	120	08/01 → 07/06						
2.4 LTP	Petrol	132	06/04 → 07/06						
2.4 T	Petrol	147	06/00 → 07/06						
2.4 T	Petrol	147	06/00 → 07/02						
2.4 T	Petrol	147	01/02 → 07/06						
2.4 T	Petrol	147	08/00 → 07/03						

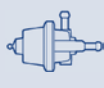

TYPE

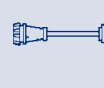

TYPE



TYPE

								BAE680AR		
			SPA139	F1					ESS0138A	J1
						SAG084	H1			
								BAE680AR		
								BAE680AR		
								BAE680AR		
			SPA139	F1						
			SPA139	F1						
			SPA139	F1						
			SPA139	F1						
								BAE680AR		
			SPA139	F1				BAE680AR		
								BAE680AR	ESS0138A	J1
		APS45	SPA139	F1					ESS0138A	J1
			SPA139	F1						
								BAE680AR		
		APS31								
			SPA139	F1						
								BAE680AR		
		APS22	SPA139	F1						
		APS31								
		APS22	SPA139	F1						
		APS31								
						SAC090	H2			
								BAE680AR		
								BAE680BV		
								BAE680AR		
								BAE680AR		
			SPA139	F1				BAE680AR		
			SPA139	F1				BAE680AR		
						SAC090	H2			
						SAC090	H2			
			SPA139	F1				BAE680AR		
						SAC090	H2			
		APS22	SPA168	F1		SAC094	H2		GA2182	J2
		APS22	SPA168	F1		SAC094	H2		GA2182	J2
								BAE680BV		
		APS22	SPA139	F1						
		APS31								
						SAC090	H2			
								BAE680AR		



KW



TYPE



TYPE

VOLVO

S80 I (TS, XY)

2.4 T5 AWD	Petrol	147	04/00 → 09/03						
2.4 T5 AWD	Petrol	147	01/02 → 09/03						
2.4 T5 AWD	Petrol	147	08/00 → 07/03						
2.5 T	Petrol	154	03/03 → 07/06						
2.5 T AWD	Petrol	154	07/03 → 07/06						
2.5 TDI	Diesel	103	01/99 → 07/06						
2.8 T6	Petrol	200	05/98 → 07/06						
2.8 T6	Petrol	200	05/98 → 12/02						
2.8 T6	Petrol	200	05/98 → 07/01						
2.9	Petrol	147	03/99 → 07/06						
2.9	Petrol	150	06/98 → 07/99						
3.0	Petrol	144	10/01 → 07/06						
3.0	Petrol	144	06/01 → 07/06						
3.0 T6	Petrol	200	06/01 → 07/06						
3.0 T6	Petrol	200	06/01 → 12/02						
3.0 T6	Petrol	200	01/02 → 07/06						

S80 II (AS)

1.6 D DRIVE	Diesel	80	01/10 →						
1.6 DRIVE	Diesel	84	06/11 →	ENGINE: D4162T			AMM19770	B4	
2.0	Petrol	107	01/08 → 07/12						
2.0	Petrol	107	01/08 →						
2.0 FlexFuel	BiFuel	107	01/08 →						
2.0 FlexFuel	BiFuel	107	01/08 →						
2.0 TDi	Diesel	100	02/08 →				AMM19656	B4	
2.4 D	Diesel	120	03/06 →						
2.4 D	Diesel	120	08/06 → 03/11						
2.4 D	Diesel	129	01/10 → 03/11						
2.5 T	Petrol	147	08/06 → 12/09						
2.5 T	Petrol	170	01/10 → 12/12						
2.5 T	Petrol	147	03/06 → 07/09						
2.5 T	Petrol	170	01/10 → 07/12						
2.5 T FlexFuel	BiFuel	147	05/08 → 03/12						
2.5 T FlexFuel	BiFuel	170	01/10 → 12/11						
2.5 T FlexFuel	BiFuel	147	05/08 → 07/10						
2.5 T FlexFuel	BiFuel	170	01/10 → 07/12						
4.4 V8 AWD	Petrol	232	08/06 → 03/12						
D3 / D4	Diesel	120	09/10 → 12/11						
D5	Diesel	136	03/06 →						
D5	Diesel	136	08/06 → 05/09						
D5	Diesel	151	01/10 → 12/11						
D5 AWD	Diesel	136	01/07 →						
D5 AWD	Diesel	136	03/08 → 05/09						
D5 AWD	Diesel	151	01/10 → 12/11						

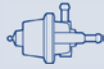

TYPE



TYPE



TYPE

		SPA139	F1				
					SAC090	H2	
							BAE680AR
	APS22				SAC090	H2	BAE680AR
	APS22				SAC090	H2	BAE680AR
	APS42						
	APS22						
	APS31						
							BAE680AR
							BAE680AR
							BAE680AR
					SAC090	H2	
							BAE680AR
	APS22						BAE680AR
	APS31						
					SAC090	H2	
Separator							
					SAG167	H1	
FEI0014							
					SAC092	H2	
			SAA115		SAC092	H2	
					SAD036	H3	
			SAA118				
					SAC090	H2	
					SAC090	H2	
					SAC090	H2	
					SAC090	H2	
							BAE680BV
							BAE680BV
					SAC090	H2	
					SAC090	H2	
							BAE680BV
							BAE680BV
					SAC090	H2	
					SAC090	H2	
			SAA118				
					SAC090	H2	
					SAC090	H2	
			SAA118				
					SAC090	H2	
					SAC090	H2	



KW



TYPE



TYPE

VOLVO

V40 2 volumi /Coda spiovente

T4	Petrol	132	07/13 →						
T4 AWD	Petrol	132	09/13 →						
T5 AWD	Petrol	157	03/13 →						

V40 Station wagon (VW)

1.6	Petrol	80	03/99 → 06/04						
1.6	Petrol	80	03/99 → 06/04	ENGINE: B4164S2					
1.8	Petrol	85	07/95 → 08/99						
1.8	Petrol	90	03/99 → 06/04						
1.8	Petrol	90	03/99 → 06/04	ENGINE: B4184S2					
1.8 i	Petrol	90	06/01 → 06/04						
1.8 i	Petrol	92	03/98 → 06/04						
1.9 DI	Diesel	75	07/00 → 06/04						
1.9 DI	Diesel	85	07/00 → 06/04						
1.9 DI	Diesel	70	03/99 → 07/00						
1.9 T4	Petrol	147	05/97 → 07/00						
1.9 T4	Petrol	147	05/97 → 07/00	ENGINE: B4194T					
2.0	Petrol	100	07/95 → 07/99						
2.0	Petrol	100	08/99 → 06/04						
2.0 T	Petrol	118	10/97 → 07/00						
2.0 T	Petrol	120	06/01 → 04/04						
2.0 T	Petrol	121	07/99 → 06/04						
2.0 T	Petrol	118	10/97 → 07/00	ENGINE: B4204T					
2.0 T	Petrol	120	06/01 → 06/04						
2.0 T4	Petrol	147	07/00 → 04/04						
2.0 T4	Petrol	147	07/00 → 06/04	ENGINE: B4204T5					
2.0 T4	Petrol	147	07/00 → 06/04						

V50 (MW)

1.6	Petrol	74	01/05 →						
1.6	Petrol	74	01/05 →	CHASSIS: 105440 →					
1.6 D	Diesel	81	01/05 →						
1.6 D	Diesel	81	01/05 →						
1.6 D2	Diesel	84	01/10 →	ENGINE: D4162T			AMM19770	B4	
1.8	Petrol	92	04/04 → 07/10						
1.8	Petrol	92	04/04 →						
1.8	Petrol	92	04/04 →						
1.8 FlexFuel	BiFuel	92	04/06 → 07/10						
1.8 FlexFuel	BiFuel	92	01/05 →						
1.8 FlexFuel	BiFuel	92	01/05 →						
2.0	Petrol	107	10/06 → 12/12						
2.0	Petrol	107	10/06 →						
2.0	Petrol	107	10/06 →						
2.0 D	Diesel	100	04/04 →						
2.0 D	Diesel	100	04/04 →						
2.0 FlexFuel	BiFuel	107	01/10 →						

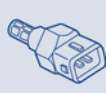
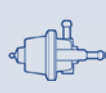

TYPE

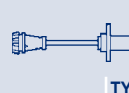

TYPE



TYPE

								BAE680BV		
								BAE680BV		
								BAE680BV		
		APS45		SPA135	F1		SAG085	H1		
			DPR04							
		APS45		SPA135	F1		SAG085	H1		
		APS45		SPA135	F1		SAG085	H1		
			DPR04							
				SPA142	F1		SAC030	H2		
				SPA142	F1		SAC030	H2		
		APS28		SPA169	F1		SAG153	H1		
		APS28		SPA169	F1		SAG153	H1		
							SAG052	H1		
		APS31		SPA135	F1		SAG086	H1		
			DPR04							
							SAG085	H1		
							SAG086	H1		
		APS31		SPA135	F1		SAG086	H1		
		APS31								
		APS31		SPA135	F1		SAG086	H1		
			DPR04							
				SPA139	F1		SAG086	H1		
		APS31								
			DPR04							
				SPA135	F1		SAG086	H1		
		APS13				SAA115	SAD037	H3	GA2113	J2
									BAE680DX	
				ATS22	F2	SAA118	SAC096	H2		
				SPA172	F1		SAG167	H1		
FEI0014										
		APS19				SAA115	SAC092	H2		
							SAD036	H3		
FEI0009										
		APS19				SAA115	SAC092	H2		
							SAD036	H3		
FEI0014										
		APS19				SAA115	SAC092	H2		
							SAD036	H3		
				ATS22	F2	SAA118	SAC096	H2		
				SPA172	F1		SAG169	H1		
		APS19					SAC092	H2		



KW



TYPE



TYPE

VOLVO

V50 (MW)

2.4	Petrol	103	04/04 →						
2.4	Petrol	125	04/04 →						
2.4	Petrol	103	04/04 → 07/10						
2.4 AWD	Petrol	125	08/06 →						
2.4 D5	Diesel	132	03/06 →						
2.4 Tdi	Diesel	120	05/07 →						
T5	Petrol	162	04/04 → 07/07						
T5	Petrol	169	08/07 →						
T5	Petrol	162	04/04 →						
T5	Petrol	169	03/07 →						
T5 AWD	Petrol	162	04/04 → 07/07						
T5 AWD	Petrol	169	08/07 →						
T5 AWD	Petrol	162	04/04 →						
T5 AWD	Petrol	169	03/07 →						

V60

1.6 DRiVe	Diesel	84	06/11 →	ENGINE: D4162T				AMM19770	B4
-----------	--------	----	---------	----------------	--	--	--	----------	----

V70 I (LV)

2.0	Petrol	120	08/98 → 03/00					SVF015	B6
2.0	Petrol	120	01/97 → 03/00						
2.0	Petrol	120	01/97 → 07/98						
2.3 AWD	Petrol	177	08/98 → 09/98						
2.3 AWD	Petrol	195	12/98 → 02/00						
2.3 T AWD	Petrol	184	08/97 → 07/98					SVF015	B6
2.3 T AWD	Petrol	184	04/97 → 07/98						
2.3 T-5 AWD	Petrol	176	01/97 → 03/00					SVF015	B6
2.3 T-5 AWD	Petrol	176	01/97 → 07/98						
2.3 T-5 AWD	Petrol	176	08/98 → 03/00						
2.4	Petrol	103	08/99 → 05/00						
2.4	Petrol	103	08/99 → 03/00						
2.4 Bifuel	BiFuel	103	08/99 → 03/00						
2.4 Turbo AWD	Petrol	195	05/99 → 02/00						
2.5	Petrol	121	06/98 → 07/98					SVF015	B6
2.5	Petrol	121	06/98 → 03/00						
2.5 AWD	Petrol	195	03/99 → 03/00					SVF015	B6
2.5 Bifuel	BiFuel	106	10/98 → 08/99						

V70 II (SW)

2.0 T	Petrol	132	08/02 → 07/07						
2.0 T	Petrol	132	07/01 → 08/07						
2.0 T	Petrol	132	01/02 → 08/07						
2.0 T	Petrol	132	07/01 → 07/04						
2.0 T	Petrol	132	08/04 → 07/07						
2.3	Petrol	195	08/02 → 07/04						
2.3	Petrol	195	01/02 → 09/04						
2.3	Petrol	195	10/00 → 07/04						



KW



TYPE



TYPE

VOLVO

V70 II (SW)

2.3 T5	Petrol	184	08/02 → 07/04						
2.3 T5	Petrol	184	03/00 → 08/07						
2.3 T5	Petrol	184	01/02 → 08/07						
2.4	Petrol	103	03/00 → 08/07						
2.4	Petrol	103	01/03 → 08/07						
2.4	Petrol	125	03/00 → 08/07						
2.4	Petrol	125	01/03 → 08/07						
2.4	Petrol	103	01/02 → 08/07						
2.4	Petrol	125	01/02 → 08/07						
2.4	Petrol	103	03/00 → 07/07						
2.4	Petrol	121	03/00 → 09/03						
2.4 Bifuel (CNG)	Petrol/CNG	103	09/01 → 08/07						
2.4 Bifuel (CNG)	Petrol/CNG	103	01/03 → 08/07						
2.4 Bifuel (CNG)	Petrol/CNG	103	01/02 → 08/07						
2.4 Bifuel (CNG)	Petrol/CNG	103	09/01 → 07/06						
2.4 D	Diesel	96	12/01 → 08/07						
2.4 D	Diesel	93	08/05 → 08/07						
2.4 D5	Diesel	120	08/01 → 08/07						
2.4 D5	Diesel	120	01/02 → 08/07						
2.4 D5	Diesel	136	12/05 → 08/07						
2.4 D5 AWD	Diesel	120	03/03 → 08/07						
2.4 D5 AWD	Diesel	136	12/05 → 08/07						
2.4 T	Petrol	147	03/00 → 07/02						
2.4 T	Petrol	147	03/00 → 07/03						
2.4 T	Petrol	147	03/00 → 08/07						
2.4 T	Petrol	147	01/02 → 08/07						
2.4 T AWD	Petrol	147	09/01 → 07/02						
2.4 T AWD	Petrol	147	09/01 → 07/03						
2.4 T AWD	Petrol	147	09/01 → 08/07						
2.4 T AWD	Petrol	147	01/02 → 08/07						
2.4 T5	Petrol	191	04/04 → 07/07						
2.4 T5	Petrol	191	04/04 → 08/07						
2.5 T	Petrol	154	04/04 → 07/07						
2.5 T	Petrol	154	04/04 → 08/07						
2.5 T	Petrol	154	09/06 → 07/07						
2.5 T AWD	Petrol	154	09/02 → 07/07						
2.5 T AWD	Petrol	154	09/02 → 08/07						
2.5 TDI	Diesel	103	03/00 → 08/07						
2.5 TDI	Diesel	103	01/02 → 08/07						
R 2,5 T AWD	Petrol	221	03/03 → 08/07						



TYPE



TYPE



TYPE

	APS22									
			SPA139	F1				BAE680AR	GA2134	J2
			SPA168	F1		SAC090	H2			
			SPA139	F1					ESS0133A	J1
			SPA168	F1						
			SPA139	F1				BAE680AR		
			SPA168	F1						
						SAC090	H2			
						SAC090	H2			
								BAE680AR		
								BAE680AR		
			SPA139	F1						
			SPA168	F1						
						SAC090	H2			
								BAE680AR		
			SPA168	F1		SAC090	H2		GA2182	J2
						SAC090	H2			
			SPA168	F1		SAC094	H2		GA2182	J2
						SAC090	H2			
						SAC090	H2			
						SAC090	H2		GA2182	J2
						SAC090	H2			
	APS31									
	APS22									
			SPA139	F1				BAE680AR	GA2134	J2
			SPA168	F1		SAC090	H2			
	APS31									
	APS22									
			SPA139	F1				BAE680AR	GA2134	J2
			SPA168	F1		SAC090	H2			
	APS22									
						SAC090	H2	BAE680BV	GA2134	J2
	APS22									
			SPA168	F1		SAC090	H2	BAE680AR	GA2134	J2
								BAE680BV		
	APS22									
			SPA168	F1		SAC090	H2	BAE680AR	GA2134	J2
	APS42									
						SAC090	H2			
			SPA168	F1		SAC090	H2	BAE680BV		



KW



TYPE



TYPE

VOLVO

V70 III (BW)

1.6 D	Diesel	80	01/10 →					
1.6 DRIVe / D2	Diesel	84	06/11 →	ENGINE: D4162T			AMM19770	B4
2.0	Petrol	107	10/07 → 07/11					
2.0	Petrol	107	10/07 →					
2.0	Petrol	107	10/07 →					
2.0 D	Diesel	100	10/07 →				AMM19656	B4
2.0 D	Diesel	100	10/07 →					
2.0 Flexifuel	BiFuel	107	01/08 →					
2.0 Flexifuel	BiFuel	107	01/08 →					
2.0 T	Petrol	149	08/10 → 07/11					
2.4 D	Diesel	120	08/07 →					
2.4 D	Diesel	120	08/07 → 12/10					
2.4 D	Diesel	129	10/09 → 12/10					
2.5 T	Petrol	147	08/07 → 12/09					
2.5 T	Petrol	170	01/10 → 12/12					
2.5 T	Petrol	147	08/07 → 07/10					
2.5 T	Petrol	170	01/10 → 07/12					
2.5 T FlexiFuel	BiFuel	147	05/08 → 05/09					
2.5 T FlexiFuel	BiFuel	170	10/09 → 11/12					
2.5 T FlexiFuel	BiFuel	147	05/08 → 07/09					
2.5 T FlexiFuel	BiFuel	170	10/09 → 12/11					
D3 / D4	Diesel	120	03/10 → 12/11					
D5	Diesel	136	08/07 →					
D5	Diesel	136	08/07 → 12/09					
D5	Diesel	151	12/09 → 11/12					
D5 AWD	Diesel	136	10/07 →					
D5 AWD	Diesel	136	10/07 → 03/10					
D5 AWD	Diesel	151	12/09 → 11/12					

XC60

2.0 T	Petrol	149	08/10 → 07/11					
2.4 D	Diesel	129	07/09 →					
2.4 D / D3 / D4 AWD	Diesel	120	05/08 →					
D3 / D4	Diesel	120	03/10 → 12/11					
D5 AWD	Diesel	136	05/08 → 12/09					
D5 AWD	Diesel	151	07/09 →					

XC70 CROSS COUNTRY

2.4 D5 AWD	Diesel	136	12/05 → 08/07					
2.4 D5 XC AWD	Diesel	120	09/02 → 08/07					
2.4 T XC AWD	Petrol	147	03/00 → 09/02					
2.4 T XC AWD	Petrol	147	01/02 → 09/02					
2.4 T XC AWD	Petrol	142	05/01 → 09/02					
2.4 T XC AWD	Petrol	142	11/97 → 09/02					
2.5 T XC AWD	Petrol	154	09/02 → 12/02					
2.5 T XC AWD	Petrol	154	09/02 → 08/07					



TYPE

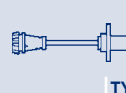

TYPE



TYPE

							SAG167	H1			
							SAA115	SAC092	H2		
								SAD036	H3		
						ATS22	F2	SAA118	SAC096	H2	
						SPA172	F1		SAG169	H1	
								SAA115	SAC092	H2	
									SAD036	H3	
											BAE680DY
								SAA118			
									SAC090	H2	
									SAC090	H2	
									SAC090	H2	
									SAC090	H2	
											BAE680BV
											BAE680BV
									SAC090	H2	
									SAC090	H2	
											BAE680BV
											BAE680BV
									SAC090	H2	
								SAA118			
									SAC090	H2	
									SAC090	H2	
								SAA118			
									SAC090	H2	
									SAC090	H2	
											BAE680DY
									SAC090	H2	
									SAC090	H2	
									SAC090	H2	
									SAC090	H2	
									SAC090	H2	
											GA2182
								SAC090	H2		J2
								SPA168	F1		GA2182
									SAC094	H2	J2
						APS31		SPA139	F1		BAE680AR
								SPA168	F1		GA2134
									SAC090	H2	J2
									SAC090	H2	
											BAE680AR
						APS31					
								SPA168	F1		
									SAC090	H2	BAE680AR



KW



TYPE



TYPE

VOLVO

XC70 CROSS COUNTRY

2.5 T XC AWD	Petrol	154	09/04 → 07/07
--------------	--------	-----	---------------

XC70 II

2.4 D	Diesel	129	01/10 → 12/10
-------	--------	-----	---------------

2.4 D / D4 AWD	Diesel	120	08/07 →
----------------	--------	-----	---------

2.4 D / D4 AWD	Diesel	120	08/07 → 12/11
----------------	--------	-----	---------------

D3	Diesel	120	08/11 → 12/11
----	--------	-----	---------------

D3 AWD	Diesel	120	08/11 → 12/11
--------	--------	-----	---------------

D5 AWD	Diesel	136	08/07 →
--------	--------	-----	---------

D5 AWD	Diesel	136	08/07 → 04/09
--------	--------	-----	---------------

D5 AWD	Diesel	151	12/09 → 12/12
--------	--------	-----	---------------

XC90 I

2.5 T	Petrol	154	10/02 →
-------	--------	-----	---------

D5	Diesel	120	10/02 →
----	--------	-----	---------

D5	Diesel	120	01/03 →
----	--------	-----	---------

D5	Diesel	136	05/06 →
----	--------	-----	---------

D5	Diesel	147	01/11 →
----	--------	-----	---------

T6	Petrol	200	10/02 →
----	--------	-----	---------

V8	Petrol	232	01/05 →
----	--------	-----	---------

ZASTAVA

101 (1100)

1.1	Petrol	40	06/73 → 01/90
-----	--------	----	---------------

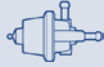

TYPE



TYPE



TYPE

BAE680BV

SAC090 H2

SAA118

SAC090 H2

SAC090 H2

SAC090 H2

SAA118

SAC090 H2

SAC090 H2

APS22

SPA168

F1

SAC090 H2

BAE680AR

APS22

SPA168

F1

GA2182

J2

SAC094 H2

SAC090 H2

SAC090 H2

APS22

SAC090 H2

BAE680AR

SAC090 H2

SPA101

F1

Applicazione per codice
Buyers guide
Zuordnung nach Bestellnummer
Affectations par références
Aplicación por referencia
Aplicação por código
Εφαρμογές ανά κωδικό
Zastosowanie dla kodu
Применение по коду
Koda göre uygulama

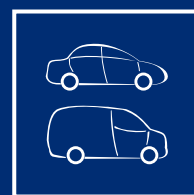

GRUPPO A - GROUP A

CFC328F.02

A3 **CENTRALINA CONTROLLO CAMBIO**
TRANSMISSION CONTROL UNIT

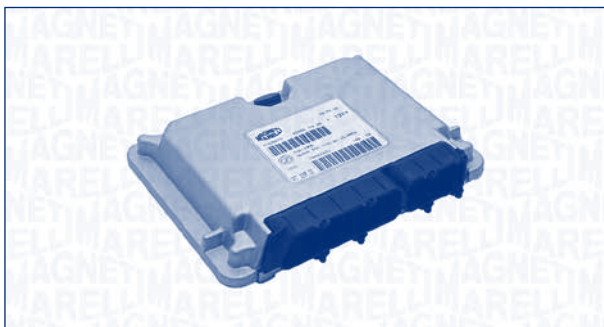

FIAT

500 (312)

1.2 Petrol 51 10/07 →

IAW1AP.10

A1 **CENTRALINA CONTROLLO MOTORE**
ENGINE CONTROL UNIT



CITROËN

XSARA Coupé (N0)

2.0 i 16V Petrol 120 02/98 → 10/00 ENGINE: XU10J4RS

ZX (N2)

2.0 i 16V Petrol 110 05/96 → 06/97 ENGINE: XU10J4RS

PEUGEOT

306 (7B, N3, N5)

2.0 S16 Petrol 110 05/96 → 10/00 ENGINE: XU10J4RS

2.0 S16 Petrol 112 05/96 → 10/00 ENGINE: XU10J4RS

306 2 volumi /Coda spiovente (7A, 7C, N3, N5)

2.0 16V Petrol 97 03/97 → 10/00 ENGINE: XU10J4RS

2.0 S16 Petrol 110 05/96 → 10/00 ENGINE: XU10J4RS

2.0 S16 Petrol 112 05/96 → 10/00 ENGINE: XU10J4RS

306 Cabriolet (7D, N3, N5)

2.0 16V Petrol 97 03/97 → 10/00 ENGINE: XU10J4RS

IAW1AP.20/2

A1 **CENTRALINA CONTROLLO MOTORE**
ENGINE CONTROL UNIT

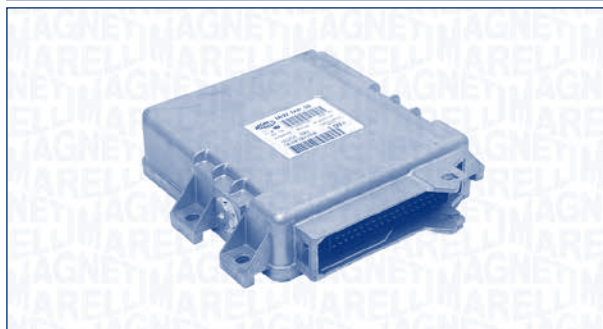

CITROËN

XANTIA (X1)

1.8 i Petrol 66 07/97 → 01/98 ENGINE: XU7JB

1.8 i Petrol 74 07/97 → 01/98 ENGINE: XU7JB

XANTIA Break (X1)

1.8 i Petrol 66 07/97 → 01/98 ENGINE: XU7JB

XANTIA Break (X1)

1.8 i Petrol 74 07/97 → 01/98 ENGINE: XU7JB

PEUGEOT

406 (8B)

1.8 Petrol 66 07/97 → 10/00 ENGINE: XU7JB

406 Break (8E/F)

1.8 Petrol 66 07/97 → 10/00 ENGINE: XU7JB

IAW1AP.40

A1 **CENTRALINA CONTROLLO MOTORE**
ENGINE CONTROL UNIT

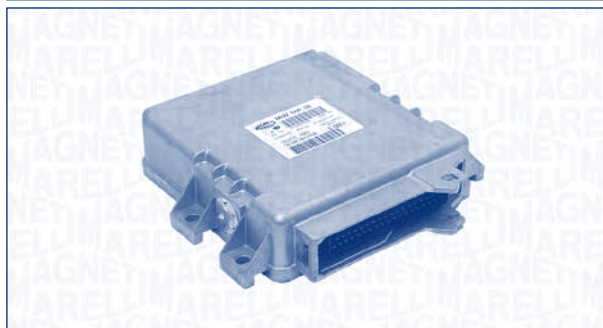

PEUGEOT

RANCH MPV / Space wagon (5F)

1.4 Petrol 55 06/96 → 06/97 ENGINE: TU3JP

IAW1AP.40/3
A1 CENTRALINA CONTROLLO MOTORE
ENGINE CONTROL UNIT

CITROËN
SAXO (S0, S1)

1.4 VTS Petrol 55 06/97 → 11/98

PEUGEOT
106 II (1)

1.4 i Petrol 55 06/97 → 11/98

IAW1AP.81
A1 CENTRALINA CONTROLLO MOTORE
ENGINE CONTROL UNIT

CITROËN
SAXO (S0, S1)

1.4 VTS Petrol 55 12/97 → 04/00

PEUGEOT
106 II (1)

1.4 i Petrol 55 12/97 → 04/00 ENGINE: TU3JP+

IAW1AP.81/1
A1 CENTRALINA CONTROLLO MOTORE
ENGINE CONTROL UNIT

PEUGEOT
206 2 volumi /Coda spiovente (2A/C)

1.4 i Petrol 55 09/98 → 09/00 ENGINE: TU3JP+

IAW1AP.82/1
A1 CENTRALINA CONTROLLO MOTORE
ENGINE CONTROL UNIT

PEUGEOT
206 2 volumi /Coda spiovente (2A/C)

1.4 i Petrol 55 09/98 → 02/00 ENGINE: TU3JP

IAW1AP.84/1

A1 CENTRALINA CONTROLLO MOTORE
ENGINE CONTROL UNIT



PEUGEOT

206 2 volumi /Coda spiovente (2A/C)

1.4 i Petrol 55 09/98 → 01/01 ENGINE: TU3JP,K

IAW48P2.316

A1 CENTRALINA CONTROLLO MOTORE
ENGINE CONTROL UNIT

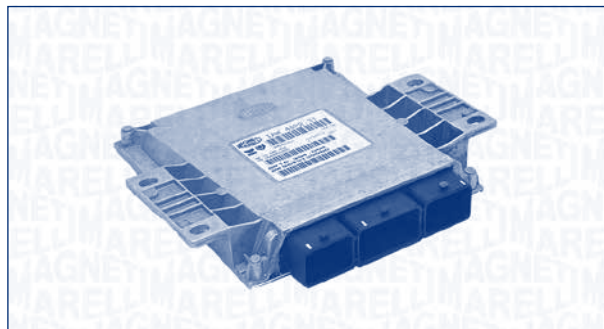

PEUGEOT

206 2 volumi /Coda spiovente (2A/C)

2.0 S16 Petrol 99 04/99 → 10/00 ENGINE: EW10J4,D3

IAW48P2.31/1

A1 CENTRALINA CONTROLLO MOTORE
ENGINE CONTROL UNIT

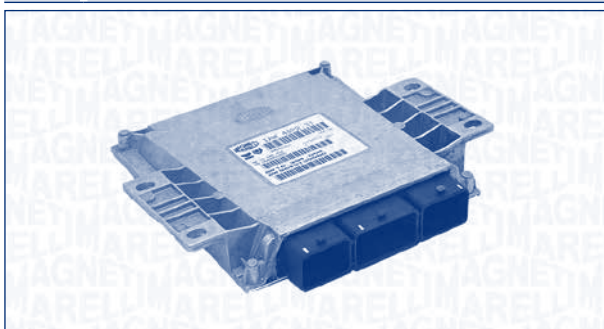

CITROËN

C5 I (DC_)

2.0 16V
(DCRFNC,
DCRFNF) Petrol 100 03/01 → 08/04 ENGINE: EW10J4,L5

C5 I Break (DE_)

2.0 16V
(DERFNF,
DERFNC,
RERFNC) Petrol 100 06/01 → 08/04 ENGINE: EW10J4,L5

IAW48P2.317

A1 CENTRALINA CONTROLLO MOTORE
ENGINE CONTROL UNIT

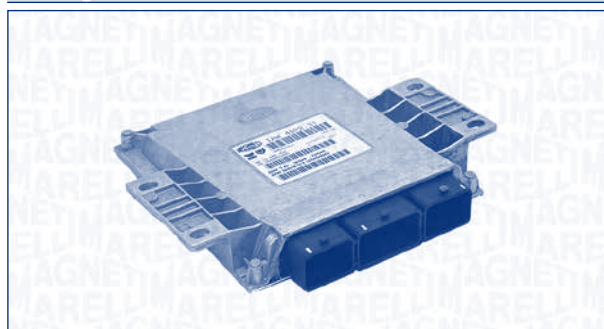

PEUGEOT

406 (8B)

2.0 16V Petrol 99 05/99 → 08/00 ENGINE: EW10J4,L3

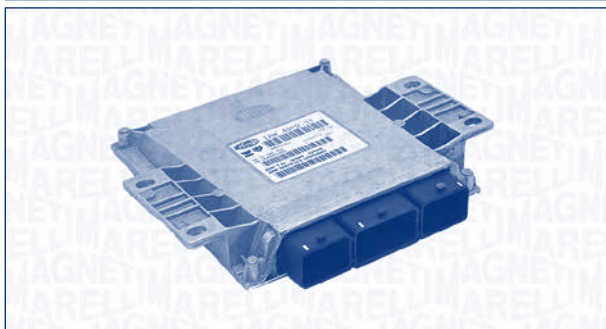
IAW48P2.34/2
A1 CENTRALINA CONTROLLO MOTORE
ENGINE CONTROL UNIT

KW

CITROËN
C8 (EA_, EB_)

2.0 Petrol 100 07/02 → ENGINE: EW10J4

FIAT
SCUDO Combinato (220P)

2.0 16V Petrol 100 06/00 → 12/06 ENGINE: EW10J4

SCUDO Furgonato (220L)

2.0 Petrol 100 08/02 → 12/06 ENGINE: EW10J4

ULYSSE (179AX)

2.0 Petrol 100 08/02 → 06/11 ENGINE: EW10J4

PEUGEOT
807 (E)

2.0 Petrol 100 06/02 → ENGINE: EW10J4

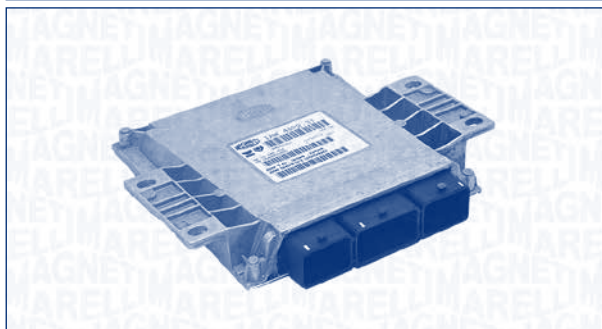
IAW48P2.39/1
A1 CENTRALINA CONTROLLO MOTORE
ENGINE CONTROL UNIT

KW

PEUGEOT
406 (8B)

2.0 16V Petrol 100 08/00 → 06/01 ENGINE: EW10J4

406 Break (8E/F)

2.0 16V Petrol 100 10/00 → 06/01 ENGINE: EW10J4

406 Coupé (8C)

2.0 16V Petrol 100 10/00 → 06/01 ENGINE: EW10J4

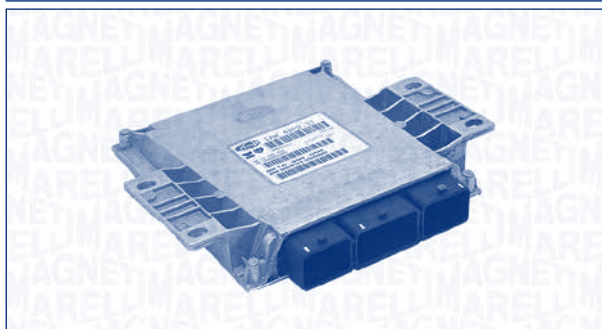
IAW48P2.70
A1 CENTRALINA CONTROLLO MOTORE
ENGINE CONTROL UNIT

KW

PEUGEOT
206 2 volumi /Coda spiovente (2A/C)

1.1 i Petrol 44 07/00 → 09/01 ENGINE: TU1JP,L4

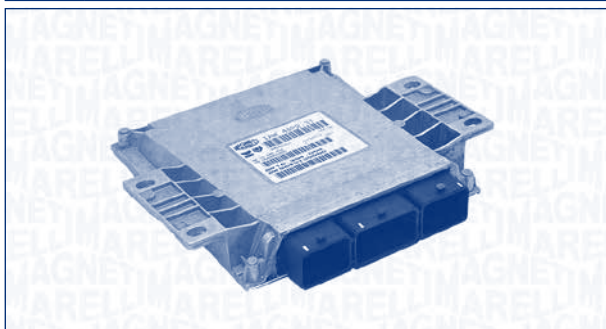
IAW48P2.36/1
A1 CENTRALINA CONTROLLO MOTORE
ENGINE CONTROL UNIT

KW

PEUGEOT
307 (3A/C)

2.0 16V Petrol 100 08/00 →

307 Break (3E)

2.0 Petrol 100 03/02 →

307 SW (3H)

2.0 16V Petrol 100 03/02 →

IAW48P2.76

A1 CENTRALINA CONTROLLO MOTORE
ENGINE CONTROL UNIT

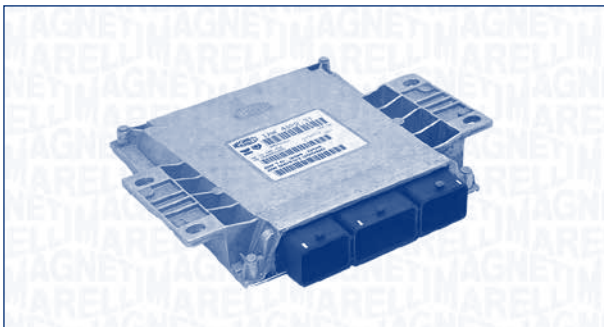

PEUGEOT

206 2 volumi /Coda spiovente (2A/C)

1.1 i Petrol 44 08/01 → 10/05 ENGINE: TU1JP,L

206 SW (2E/K)

1.1 Petrol 44 07/02 → 10/05 ENGINE: TU1JP,L

IAW48P2.80/1

A1 CENTRALINA CONTROLLO MOTORE
ENGINE CONTROL UNIT

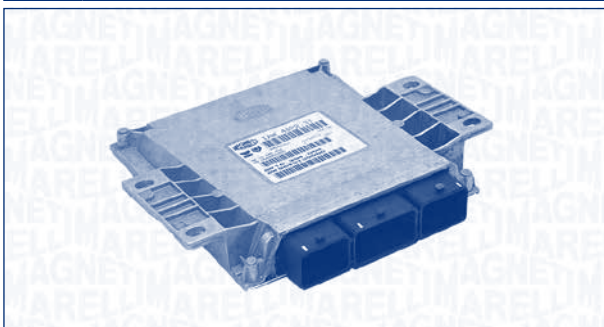

CITROËN

SAXO (S0, S1)

1.6 VTS Petrol 87 09/00 → 07/03

PEUGEOT

106 II (1)

1.6 S16 Petrol 87 09/00 → 07/03

IAW48P3.3J

A1 CENTRALINA CONTROLLO MOTORE
ENGINE CONTROL UNIT

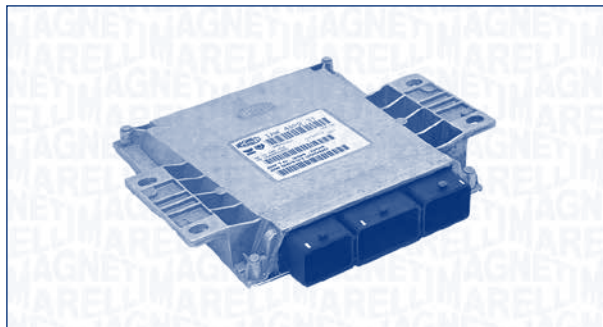

PEUGEOT

406 (8B)

2.0 16V Petrol 100 08/00 → 06/04 ENGINE: EW10J4

2.0 16V Petrol 97 11/95 → 05/04 ENGINE: EW10J4

2.0 16V Petrol 99 01/99 → 08/00 ENGINE: EW10J4

406 Break (8E/F)

2.0 16V Petrol 100 10/00 → 10/04 ENGINE: EW10J4

2.0 16V Petrol 99 01/99 → 10/00 ENGINE: EW10J4

2.0 16V HPi Petrol 103 05/01 → 10/04 ENGINE: EW10J4

406 Coupé (8C)

2.0 16V Petrol 100 10/00 → 12/04 ENGINE: EW10J4

2.0 16V Petrol 97 03/97 → 12/04 ENGINE: EW10J4

2.0 16V Petrol 99 01/99 → 10/00 ENGINE: EW10J4

IAW49F.B1

A1 CENTRALINA CONTROLLO MOTORE
ENGINE CONTROL UNIT

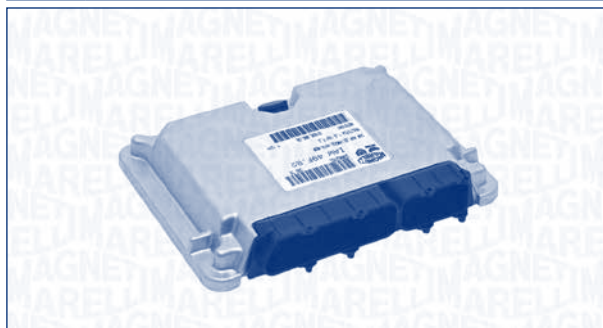

LANCIA

LYBRA (839AX)

1.6 16V (839AXA1A) Petrol 76 07/99 → 12/00

LYBRA SW (839BX)

1.6 16V (839BXA1A) Petrol 76 07/99 → 12/00

IAW49F.B2

A1 CENTRALINA CONTROLLO MOTORE
ENGINE CONTROL UNIT



FIAT

MULTIPLA (186)

1.6 100 16V (186AXA1A)	Petrol	76	04/99 → 12/00	ENGINE: 182A4000-
---------------------------	--------	----	---------------	-------------------

IAW4AF.G2

A1 CENTRALINA CONTROLLO MOTORE
ENGINE CONTROL UNIT



FIAT

DOBLO (119)

1.6 16V (223AXD1A)	Petrol	76	02/04 →	ENGINE: 182B6000
-----------------------	--------	----	---------	------------------

DOBLO Cargo (223)

1.6 16V (223ZXD1A)	Petrol	76	02/04 →	ENGINE: 182B6000-
-----------------------	--------	----	---------	-------------------

IAW4AF.G1/1

A1 CENTRALINA CONTROLLO MOTORE
ENGINE CONTROL UNIT

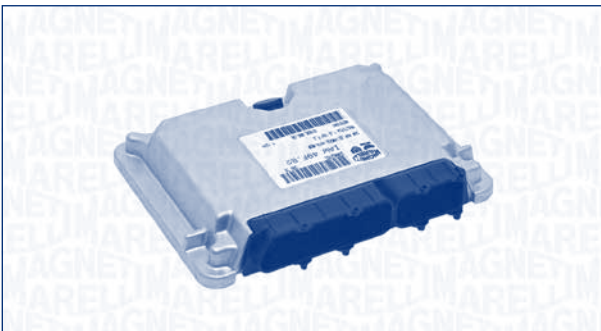

FIAT

DOBLO (119)

1.6 16V (223AXD1A)	Petrol	76	02/03 →	ENGINE: 182B6000
-----------------------	--------	----	---------	------------------

DOBLO Cargo (223)

1.6 16V (223ZXD1A)	Petrol	76	02/03 →	ENGINE: 182B6000
-----------------------	--------	----	---------	------------------

IAW4AF.G3/1

A1 CENTRALINA CONTROLLO MOTORE
ENGINE CONTROL UNIT

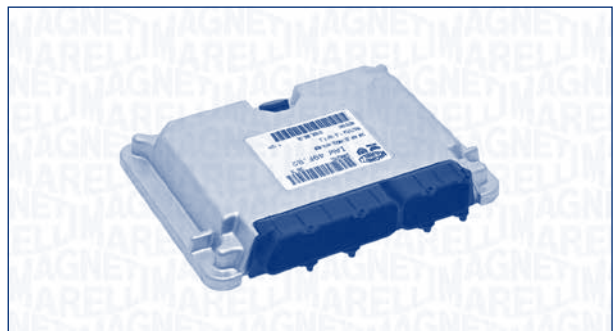

FIAT

DOBLO (119)

1.6 Natural Power	BiFuel	76	01/06 →	
-------------------	--------	----	---------	--

DOBLO Cargo (223)

1.6 Natural Power	BiFuel	76	01/06 →	
-------------------	--------	----	---------	--

IAW4AF.M8/1

A1 CENTRALINA CONTROLLO MOTORE
ENGINE CONTROL UNIT

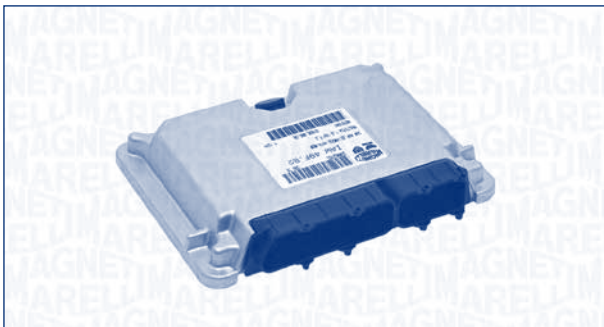

FIAT

SEICENTO (187)

1.1 (187AXB, 187AXB1A)	Petrol	40	01/01 → 01/10	ENGINE: 176B2000, ENGINE: 1236150 →
------------------------	--------	----	---------------	-------------------------------------

IAW4AF.M9/2

A1 CENTRALINA CONTROLLO MOTORE
ENGINE CONTROL UNIT

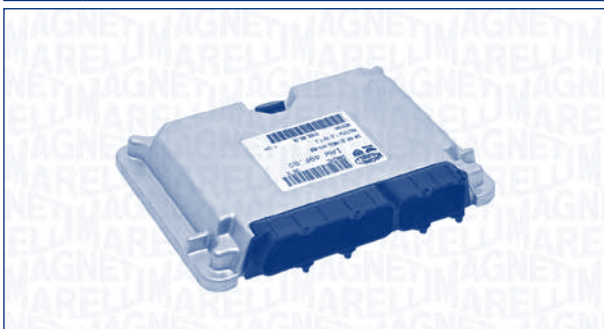

FIAT

SEICENTO (187)

1.1 (187AXB, 187AXB1A)	Petrol	40	09/08 → 01/10	ENGINE: 176B2000
------------------------	--------	----	---------------	------------------

SEICENTO Van (187)

1.1 (187CXB/C)	Petrol	40	09/09 → 01/10	ENGINE: 176B2000
----------------	--------	----	---------------	------------------

IAW4AF.PP

A1 CENTRALINA CONTROLLO MOTORE
ENGINE CONTROL UNIT

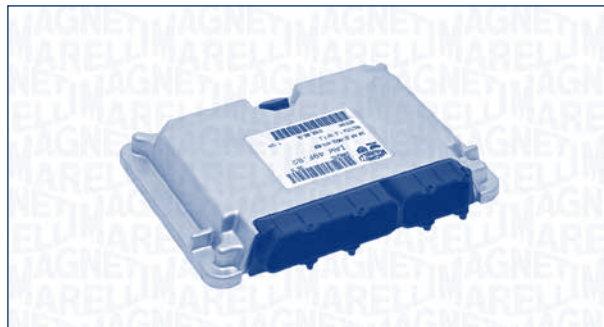

FIAT

PANDA (141A_)

1100	Petrol	40	09/02 → 09/03
------	--------	----	---------------

IAW4AF.S2/3

A1 CENTRALINA CONTROLLO MOTORE
ENGINE CONTROL UNIT



FIAT

PANDA (169)

1.2	Petrol	44	02/04 →
-----	--------	----	---------

IAW4AF.S3/2

A1 CENTRALINA CONTROLLO MOTORE
ENGINE CONTROL UNIT



FIAT

PANDA (169)

1.1 Petrol 40 01/05 →

IAW4EF.B3

A1 CENTRALINA CONTROLLO MOTORE
ENGINE CONTROL UNIT



FIAT

MAREA (185)

1.6 100 16V Petrol 76 01/01 → 05/02

MAREA Weekend (185)

1.6 100 16V Petrol 76 01/01 → 05/02

IAW4AF.SS/2

A1 CENTRALINA CONTROLLO MOTORE
ENGINE CONTROL UNIT

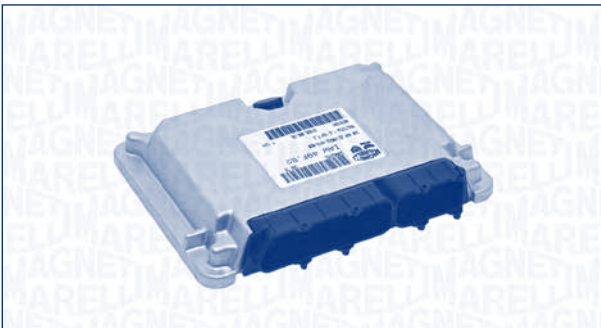

FIAT

PANDA (169)

1.1 Petrol 40 10/06 →

IAW4EF.B5

A1 CENTRALINA CONTROLLO MOTORE
ENGINE CONTROL UNIT

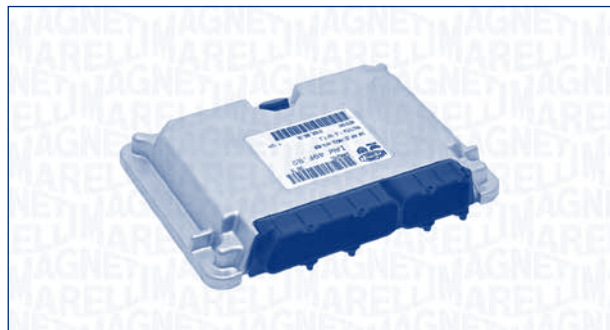

LANCIA

LYBRA (839AX)

1.6 16V (839AXA1A) Petrol 76 01/01 → 10/05

LYBRA SW (839BX)

1.6 16V (839BXA1A) Petrol 76 01/01 → 10/05

IAW4EF.G4/1

A1 CENTRALINA CONTROLLO MOTORE
ENGINE CONTROL UNIT

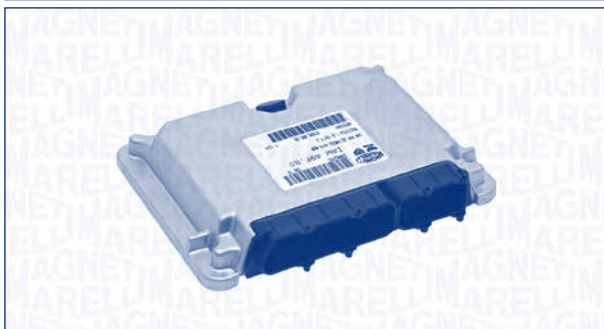

FIAT

MULTIPLA (186)

1.6 16V Bipower (186AXC1A)	Petrol/ CNG	76	01/06 → 06/10
-------------------------------	----------------	----	---------------

IAW59F.M1/2

A1 CENTRALINA CONTROLLO MOTORE
ENGINE CONTROL UNIT



FIAT

SEICENTO (187)

1.1 (187AXB, 187AXB1A)	Petrol	40	01/98 → 01/10
---------------------------	--------	----	---------------

IAW59F.E4/1

A1 CENTRALINA CONTROLLO MOTORE
ENGINE CONTROL UNIT



FIAT

PUNTO (188)

1.2 60 (188.030, .050, .130, .150, .230, .250)	Petrol	44	01/01 → 05/03
--	--------	----	---------------

PUNTO Van (188AX)

1.2 60	Petrol	44	01/01 → 05/03
--------	--------	----	---------------

IAW59F.M2/1

A1 CENTRALINA CONTROLLO MOTORE
ENGINE CONTROL UNIT



FIAT

PUNTO (188)

1.2 60 (188.030, .050, .130, .150, .230, .250)	Petrol	44	09/99 → 12/00
--	--------	----	---------------

PUNTO Van (188AX)

1.2 60	Petrol	44	02/00 → 12/00
--------	--------	----	---------------

IAW59F.M3/7
A1 CENTRALINA CONTROLLO MOTORE
ENGINE CONTROL UNIT

FIAT
PUNTO (188)

1.2 60 (188.030, .050, .130, .150, .230, .250)	Petrol	44	01/01 → 05/03	ENGINE: 188A4000-
--	--------	----	---------------	-------------------

PUNTO Van (188AX)

1.2 60	Petrol	44	01/01 → 05/03	ENGINE: 188A4000-
--------	--------	----	---------------	-------------------

IAW59F.M7/6
A1 CENTRALINA CONTROLLO MOTORE
ENGINE CONTROL UNIT

FIAT
SEICENTO (187)

1.1 (187AXB, 187AXB1A)	Petrol	40	01/01 → 06/01	ENGINE: 176B2000
------------------------	--------	----	---------------	------------------

SEICENTO Van (187)

1.1 (187CXB/C)	Petrol	40	01/01 → 06/01	ENGINE: 176B2000
----------------	--------	----	---------------	------------------

IAW59F.M5/1
A1 CENTRALINA CONTROLLO MOTORE
ENGINE CONTROL UNIT

LANCIA
Y (840A)

1.2 (840AA, 840AF1A)	Petrol	44	01/01 → 09/03	
----------------------	--------	----	---------------	--

IAW59F.SC/1
A1 CENTRALINA CONTROLLO MOTORE
ENGINE CONTROL UNIT

FIAT
DOBLO (119)

1.2 (223AXA1A)	Petrol	48	03/01 → 12/03	
----------------	--------	----	---------------	--

DOBLO Cargo (223)

1.2 (223ZX1A)	Petrol	48	03/01 → 12/03	
---------------	--------	----	---------------	--

IAW59F.VG

A1 CENTRALINA CONTROLLO MOTORE
ENGINE CONTROL UNIT



FIAT

PUNTO (188)

1.2 60 (188.030, .050, .130, .150, .230, .250)	Petrol	44	09/99 → 12/00
--	--------	----	---------------

PUNTO Van (188AX)

1.2 60	Petrol	44	02/00 → 12/00
--------	--------	----	---------------

IAW5AF.P3/3

A1 CENTRALINA CONTROLLO MOTORE
ENGINE CONTROL UNIT



FIAT

PUNTO (188)

1.2 60 (188.030, .050, .130, .150, .230, .250)	Petrol	44	06/03 → 08/05
--	--------	----	---------------

PUNTO Van (188AX)

1.2 60	Petrol	44	06/03 → 08/05
--------	--------	----	---------------

IAW5AF.N8/4

A1 CENTRALINA CONTROLLO MOTORE
ENGINE CONTROL UNIT



LANCIA

YPSILON (843)

1.2	Petrol	44	10/03 → 12/11
-----	--------	----	---------------

IAW5AF.P4/4

A1 CENTRALINA CONTROLLO MOTORE
ENGINE CONTROL UNIT



FIAT

PUNTO (188)

1.2 60 (188.030, .050, .130, .150, .230, .250)	Petrol	44	06/03 →
--	--------	----	---------

PUNTO Van (188AX)

1.2 60	Petrol	44	06/03 → 10/09
--------	--------	----	---------------

IAW5AF.PE/2

A1 CENTRALINA CONTROLLO MOTORE
ENGINE CONTROL UNIT

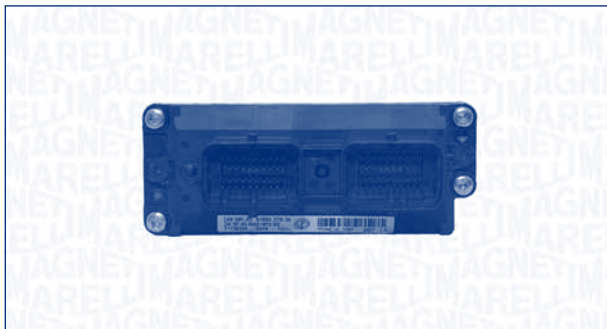

FIAT

PUNTO (188)

1.2 Natural Power	BiFuel	44	01/04 →
-------------------	--------	----	---------

IAW5AF.S2

A1 CENTRALINA CONTROLLO MOTORE
ENGINE CONTROL UNIT



FIAT

PANDA (169)

1.2	Petrol	44	09/03 → 01/04
-----	--------	----	---------------

IAW5AF.S1/1

A1 CENTRALINA CONTROLLO MOTORE
ENGINE CONTROL UNIT



FIAT

PANDA (169)

1.1	Petrol	40	09/03 → 01/04	CHASSIS: → 191792
-----	--------	----	---------------	-------------------

IAW5AF.SK

A1 CENTRALINA CONTROLLO MOTORE
ENGINE CONTROL UNIT



FIAT

PANDA (169)

1.2	Petrol	44	01/07 →
-----	--------	----	---------

IAW5AF.SM/1

A1 CENTRALINA CONTROLLO MOTORE
ENGINE CONTROL UNIT

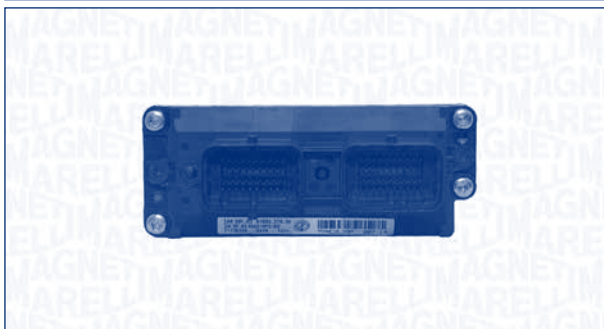

FIAT

PANDA (169)

1.1 Petrol 40 09/03 → 01/04

IAW5NF.S5/1

A1 CENTRALINA CONTROLLO MOTORE
ENGINE CONTROL UNIT

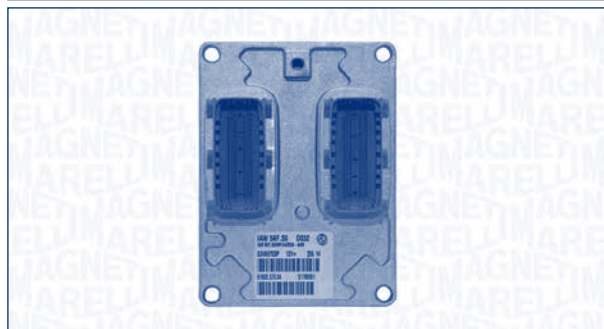

FIAT

PANDA (169)

1.2 Petrol 44 01/04 →

IAW5AF.SP

A1 CENTRALINA CONTROLLO MOTORE
ENGINE CONTROL UNIT



FIAT

PANDA (169)

1.2 Petrol 44 09/03 → 01/04

IAW5NF.S8/2

A1 CENTRALINA CONTROLLO MOTORE
ENGINE CONTROL UNIT

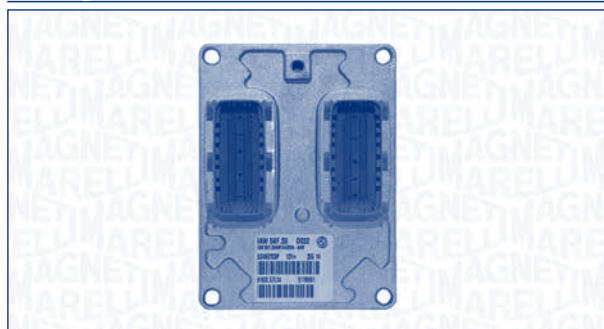

FIAT

PANDA (169)

1.2 4x4 Petrol 44 10/04 →

IAW5NF.T1/1

A1 CENTRALINA CONTROLLO MOTORE
ENGINE CONTROL UNIT



FIAT

STILO (192)

1.6 16V (192_XB1A)	Petrol	76	10/01 → 11/06
-----------------------	--------	----	---------------

STILO Multi Wagon (192)

1.6 16V	Petrol	76	01/03 → 08/08
---------	--------	----	---------------

IAW5SF.MB

A1 CENTRALINA CONTROLLO MOTORE
ENGINE CONTROL UNIT

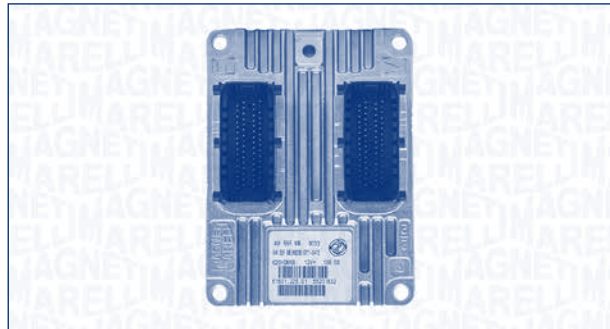

FIAT

DOBLO (119)

1.4	Petrol	57	10/05 →
-----	--------	----	---------

DOBLO Cargo (223)

1.4	Petrol	57	10/05 →
-----	--------	----	---------

IAW5NF.T9/1

A1 CENTRALINA CONTROLLO MOTORE
ENGINE CONTROL UNIT

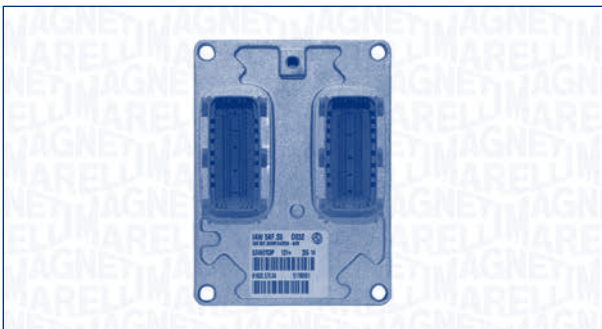

FIAT

STILO (192)

1.6 16V (192_XB1A)	Petrol	76	01/03 → 11/06
-----------------------	--------	----	---------------

STILO Multi Wagon (192)

1.6 16V	Petrol	76	01/03 → 08/08
---------	--------	----	---------------

IAW5SF.MD

A1 CENTRALINA CONTROLLO MOTORE
ENGINE CONTROL UNIT

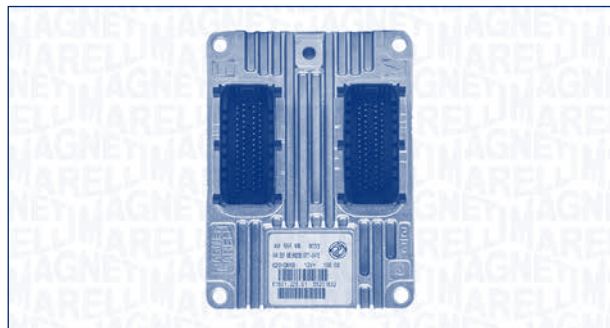

FIAT

LINEA (323)

1.4	Petrol	57	06/07 →
-----	--------	----	---------

IAW5SF3.M1/4

A1 CENTRALINA CONTROLLO MOTORE
ENGINE CONTROL UNIT

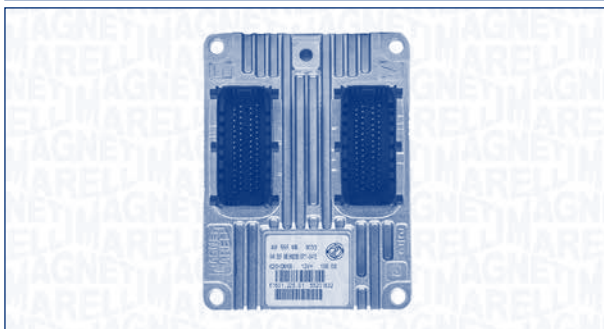

FIAT

PUNTO / GRANDE PUNTO (199)

1.2 Petrol 48 10/05 →

IAW5SF3.M9

A1 CENTRALINA CONTROLLO MOTORE
ENGINE CONTROL UNIT

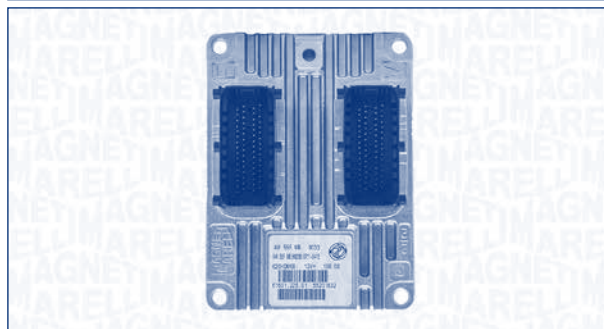

LANCIA

YPSILON (843)

1.4 Petrol 57 02/06 → 12/11

IAW5SF3.M2/3

A1 CENTRALINA CONTROLLO MOTORE
ENGINE CONTROL UNIT

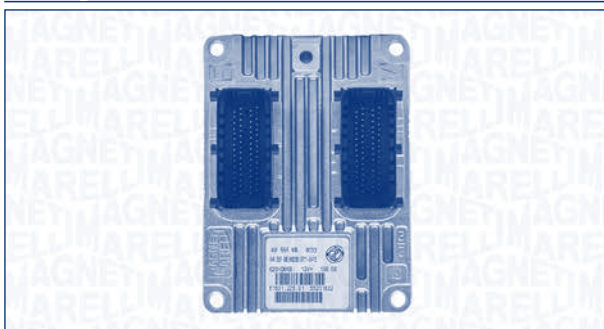

FIAT

PUNTO / GRANDE PUNTO (199)

1.4 Petrol 57 10/05 →

IAW5SF8.M4/1

A1 CENTRALINA CONTROLLO MOTORE
ENGINE CONTROL UNIT

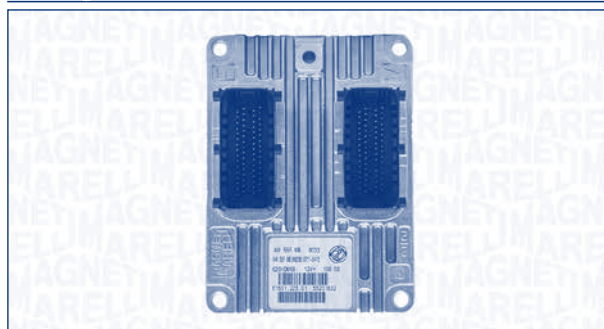

FIAT

PANDA (169)

1.2 Petrol 44 09/03 → ENGINE: 188A4000

PANDA Van (169)

1.2 Petrol 44 09/04 → ENGINE: 188A4000

IAW5SF8.MR

A1 CENTRALINA CONTROLLO MOTORE
ENGINE CONTROL UNIT

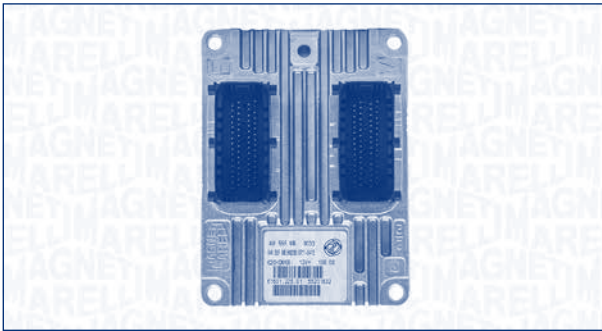

FIAT

500 (312)

1.2 Petrol 51 10/07 →

IAW5SF9.MS1

A1 CENTRALINA CONTROLLO MOTORE
ENGINE CONTROL UNIT

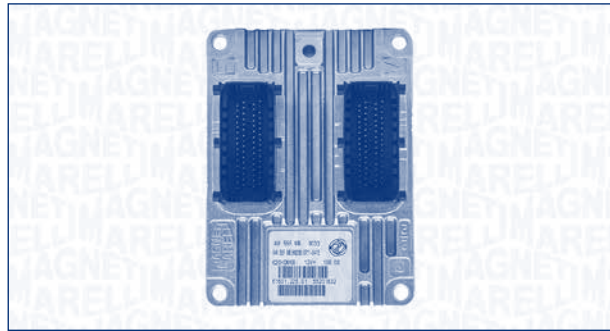

FIAT

500 (312)

1.2 Petrol 51 12/09 →

IAW5SF9.MS

A1 CENTRALINA CONTROLLO MOTORE
ENGINE CONTROL UNIT

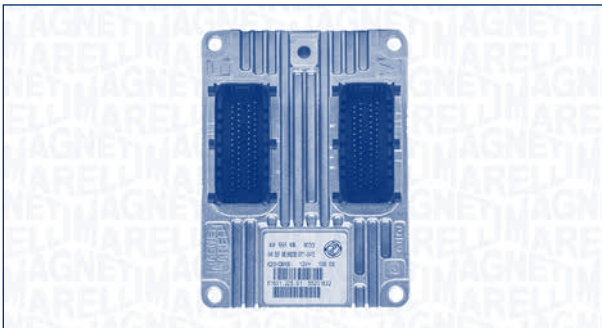

FIAT

500 (312)

1.2 Petrol 51 10/08 →

IAW6LPA.02

A1 CENTRALINA CONTROLLO MOTORE
ENGINE CONTROL UNIT

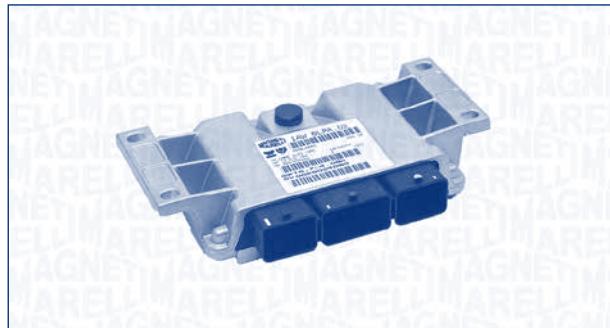

CITROËN

C4 Coupé (LA_)

2.0 16V Petrol 130 11/04 → ENGINE: EW10J4S

C4 I (LC_)

2.0 16V Petrol 130 11/04 → ENGINE: EW10J4S

PEUGEOT

307 CC (3B)

2.0 16V Petrol 130 10/03 → ENGINE: EW10J4S

IAW8P.10/2

A1 CENTRALINA CONTROLLO MOTORE
ENGINE CONTROL UNIT

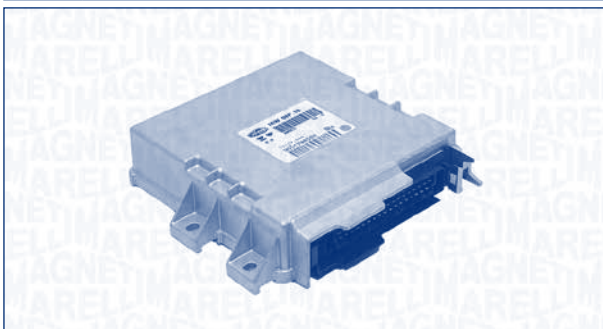

KW



CITROËN

XANTIA (X1)

1.8 i	Petrol	66	04/97 → 01/98	ENGINE: XU7JPZ
1.8 i	Petrol	74	03/93 → 01/98	ENGINE: XU7JPZ

XANTIA Break (X1)

1.8 i	Petrol	74	06/95 → 01/98	ENGINE: XU7JPZ
-------	--------	----	---------------	----------------

ZX (N2)

1.8 i	Petrol	74	10/92 → 06/97	ENGINE: XU7JPZ
-------	--------	----	---------------	----------------

ZX Break (N2)

1.8 i	Petrol	74	10/93 → 10/97	ENGINE: XU7JPZ
-------	--------	----	---------------	----------------

PEUGEOT

306 (7B, N3, N5)

1.8 ST	Petrol	74	06/94 → 04/01	ENGINE: XU7JPZ
--------	--------	----	---------------	----------------

306 2 volumi /Coda spiovente (7A, 7C, N3, N5)

1.8	Petrol	74	05/93 → 04/01	ENGINE: XU7JPZ
-----	--------	----	---------------	----------------

306 Break (7E, N3, N5)

1.8	Petrol	74	03/97 → 04/01	ENGINE: XU7JPZ
-----	--------	----	---------------	----------------

306 Cabriolet (7D, N3, N5)

1.8	Petrol	74	03/94 → 04/01	ENGINE: XU7JPZ
-----	--------	----	---------------	----------------

405 II (4B)

1.8	Petrol	74	10/92 → 10/95	ENGINE: XU7JPZ
-----	--------	----	---------------	----------------

405 II Break (4E)

1.8	Petrol	74	10/92 → 10/96	ENGINE: XU7JPZ
-----	--------	----	---------------	----------------

IAW8P.10/3

A1 CENTRALINA CONTROLLO MOTORE
ENGINE CONTROL UNIT

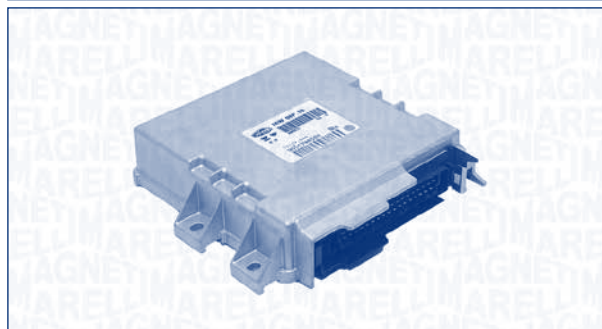

KW



CITROËN

XANTIA (X1)

1.8 i	Petrol	66	04/97 → 01/98	ENGINE: XU7JP
1.8 i	Petrol	74	05/93 → 01/98	ENGINE: XU7JP

XANTIA Break (X1)

1.8 i	Petrol	66	04/97 → 01/98	ENGINE: XU7JP
-------	--------	----	---------------	---------------

ZX (N2)

1.8 i	Petrol	74	06/95 → 01/98	ENGINE: XU7JP
-------	--------	----	---------------	---------------

ZX Break (N2)

1.8 i	Petrol	74	05/93 → 06/97	ENGINE: XU7JP
-------	--------	----	---------------	---------------

PEUGEOT

306 (7B, N3, N5)

1.8 ST	Petrol	74	06/94 → 02/98	ENGINE: XU7JP
--------	--------	----	---------------	---------------

306 2 volumi /Coda spiovente (7A, 7C, N3, N5)

1.8	Petrol	74	05/93 → 02/98	ENGINE: XU7JP
-----	--------	----	---------------	---------------

306 Break (7E, N3, N5)

1.8	Petrol	74	03/97 → 02/98	ENGINE: XU7JP
-----	--------	----	---------------	---------------

306 Cabriolet (7D, N3, N5)

1.8	Petrol	74	03/94 → 02/98	ENGINE: XU7JP
-----	--------	----	---------------	---------------

405 II (4B)

1.8	Petrol	74	03/94 → 02/98	ENGINE: XU7JP
-----	--------	----	---------------	---------------

405 II Break (4E)

1.8	Petrol	74	05/93 → 10/96	ENGINE: XU7JP
-----	--------	----	---------------	---------------

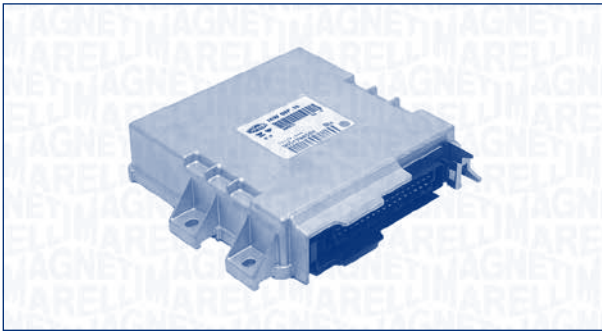
IAW8P.14/1
A1 CENTRALINA CONTROLLO MOTORE
ENGINE CONTROL UNIT

PEUGEOT
406 (8B)

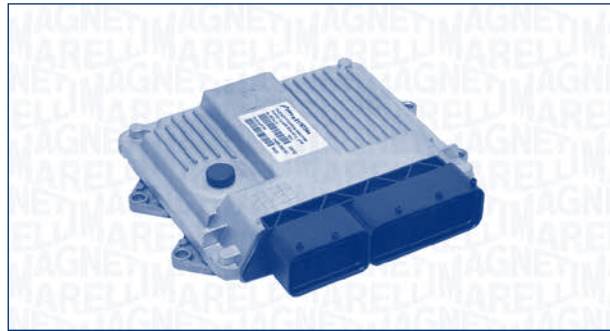
1.6 Petrol 65 06/97 → 02/01 ENGINE: XU5JPZ

MJD6F3A5
A1 CENTRALINA CONTROLLO MOTORE
ENGINE CONTROL UNIT

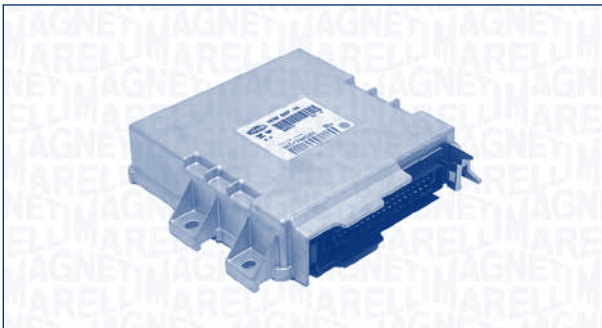
FIAT
PANDA (169)

1.3 D Multijet Diesel 55 06/06 → ENGINE: 169A1000

IAW8P1.A/2
A1 CENTRALINA CONTROLLO MOTORE
ENGINE CONTROL UNIT

CITROËN
XSARA (N1)

1.8 i Petrol 66 09/97 → 04/99 ENGINE: XU7JPK

XSARA Break (N2)

1.8 i Petrol 66 10/97 → 04/99 ENGINE: XU7JPK

PEUGEOT
306 2 volumi /Coda spiovente (7A, 7C, N3, N5)

1.8 Petrol 74 09/97 → 04/99 ENGINE: XU7JPK

306 Break (7E, N3, N5)

1.8 Petrol 74 09/97 → 04/99 ENGINE: XU7JPK

306 Cabriolet (7D, N3, N5)

1.8 Petrol 74 09/97 → 04/99 ENGINE: XU7JPK

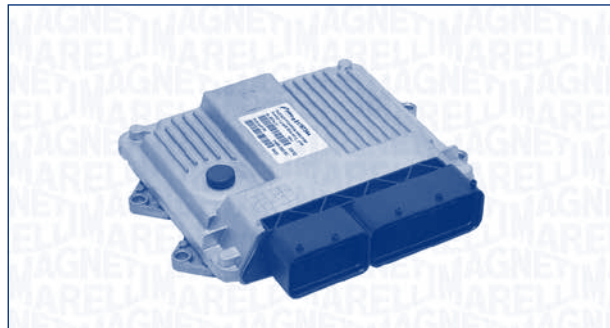
MJD6F3B1
A1 CENTRALINA CONTROLLO MOTORE
ENGINE CONTROL UNIT

FIAT
500 (312)

1.3 D Multijet Diesel 55 10/07 →

MJD6F3B2

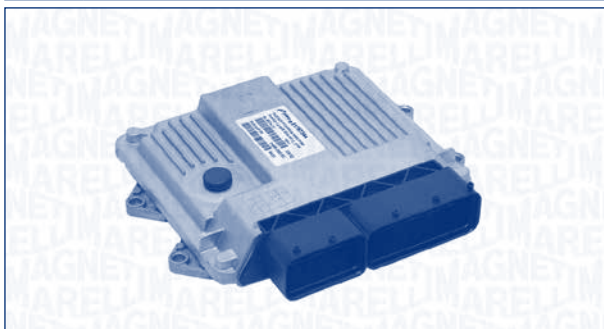
A1 CENTRALINA CONTROLLO MOTORE
ENGINE CONTROL UNIT



FIAT

500 (312)

1.3 D Multijet Diesel 55 10/07 →

MJD6F3D2

A1 CENTRALINA CONTROLLO MOTORE
ENGINE CONTROL UNIT

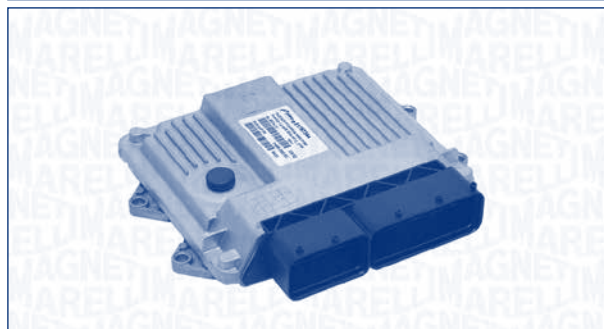

FIAT

DOBLO Cargo (223)

1.3 D Multijet Diesel 55 10/05 → 01/10

MJD6F3D1

A1 CENTRALINA CONTROLLO MOTORE
ENGINE CONTROL UNIT

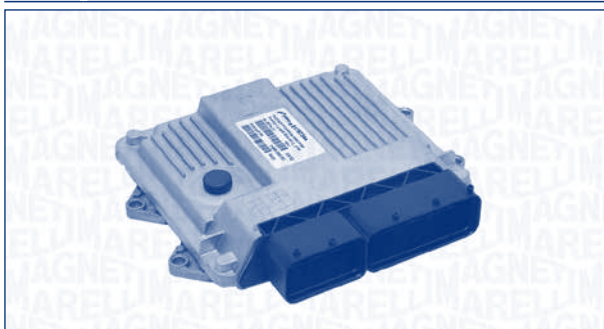

FIAT

DOBLO (119)

1.3 D Multijet Diesel 62 05/08 →

MJD6F3D4

A1 CENTRALINA CONTROLLO MOTORE
ENGINE CONTROL UNIT

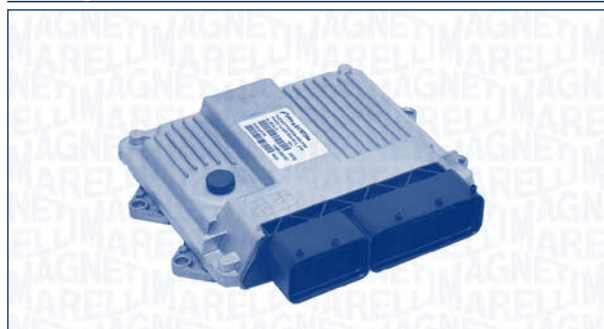

FIAT

DOBLO Cargo (223)

1.3 D Multijet Diesel 55 10/05 → 04/07

MJD6F3D4/1

A1 CENTRALINA CONTROLLO MOTORE
ENGINE CONTROL UNIT

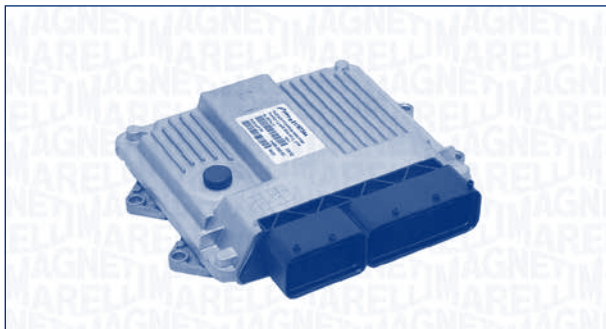

FIAT

DOBLO Cargo (223)

1.3 D Multijet Diesel 55 05/07 → 01/10

MJD6F3H1

A1 CENTRALINA CONTROLLO MOTORE
ENGINE CONTROL UNIT

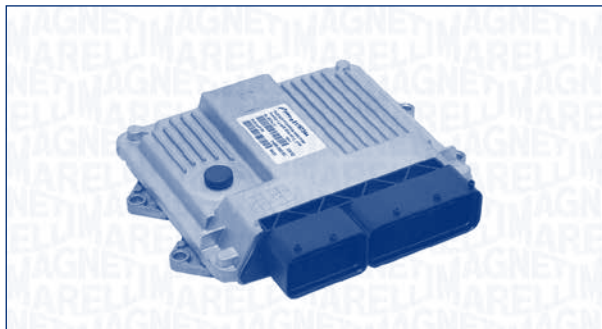

FIAT

QUBO

1.3 D Multijet Diesel 55 12/08 →

MJD6F3D5

A1 CENTRALINA CONTROLLO MOTORE
ENGINE CONTROL UNIT

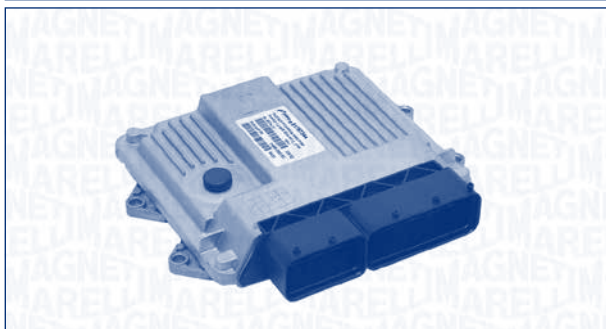

FIAT

DOBLO (119)

1.3 D Multijet Diesel 62 10/06 →

MJD6F3M3

A1 CENTRALINA CONTROLLO MOTORE
ENGINE CONTROL UNIT

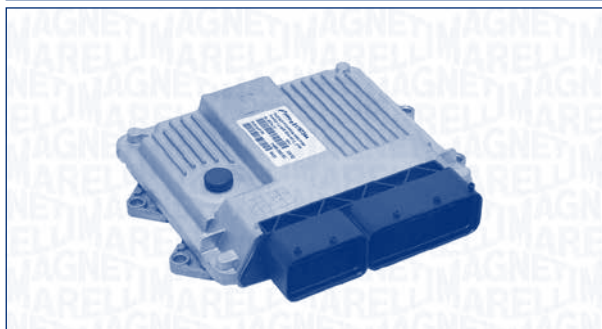

FIAT

IDEA

1.3 D Multijet Diesel 66 10/05 → ENGINE: → 1866163

LANCIA

MUSA (350)

1.3 D Multijet Diesel 66 09/06 → ENGINE: → 1866163

MJD6F3M3/3

A1 CENTRALINA CONTROLLO MOTORE
ENGINE CONTROL UNIT

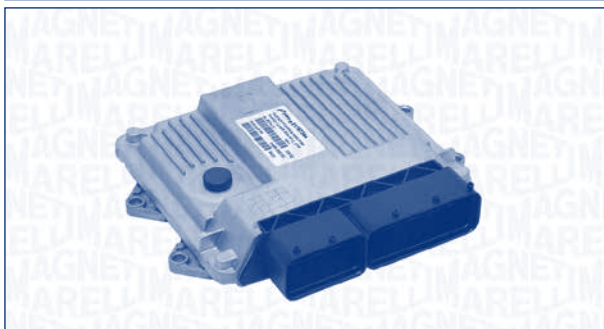

FIAT

IDEA

1.3 D Multijet Diesel 66 05/09 →

LANCIA

MUSA (350)

1.3 D Multijet Diesel 66 05/09 →

MJD6F3M5

A1 CENTRALINA CONTROLLO MOTORE
ENGINE CONTROL UNIT

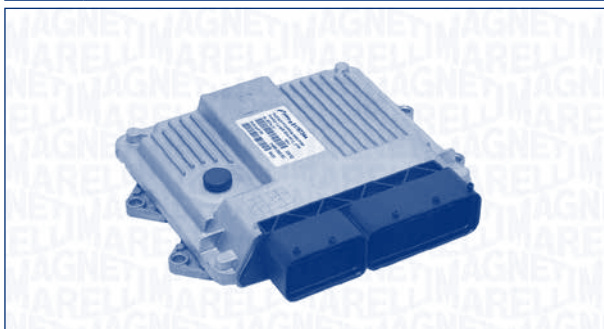

FIAT

IDEA

1.3 D Multijet Diesel 66 07/08 →

LANCIA

MUSA (350)

1.3 D Multijet Diesel 66 07/08 →

MJD6F3P5

A1 CENTRALINA CONTROLLO MOTORE
ENGINE CONTROL UNIT

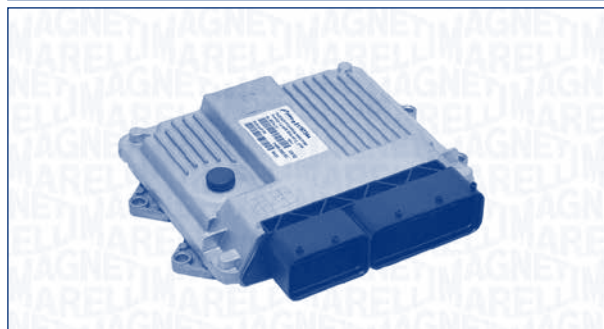

FIAT

PUNTO / GRANDE PUNTO (199)

1.3 D Multijet Diesel 66 10/05 →

MJD6F3P5/1

A1 CENTRALINA CONTROLLO MOTORE
ENGINE CONTROL UNIT

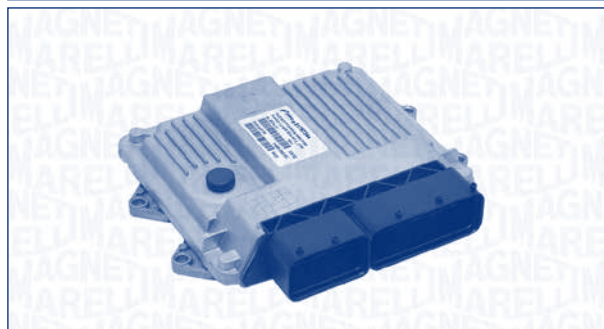

FIAT

PUNTO / GRANDE PUNTO (199)

1.3 D Multijet Diesel 66 07/08 →

MJD6F3P6

A1 CENTRALINA CONTROLLO MOTORE
ENGINE CONTROL UNIT

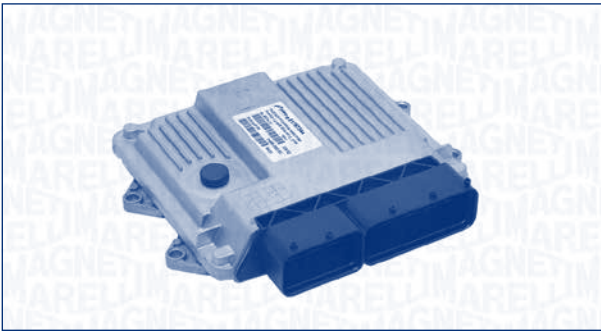

FIAT

PUNTO / GRANDE PUNTO (199)

1.3 D Multijet Diesel 55 10/05 → 06/08

MJD6F3P7/1

A1 CENTRALINA CONTROLLO MOTORE
ENGINE CONTROL UNIT

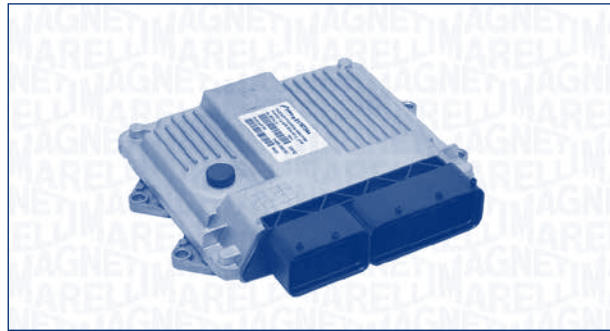

FIAT

PUNTO / GRANDE PUNTO (199)

1.3 D Multijet Diesel 55 04/08 → 07/08

MJD6F3P7

A1 CENTRALINA CONTROLLO MOTORE
ENGINE CONTROL UNIT

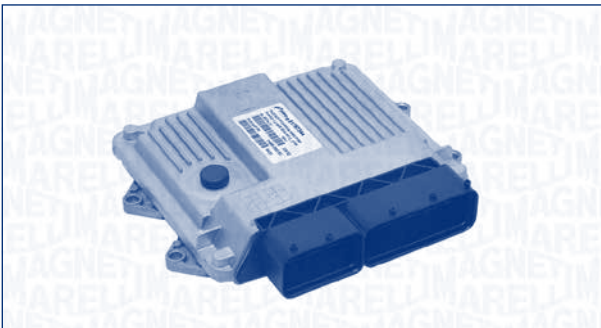

FIAT

PUNTO / GRANDE PUNTO (199)

1.3 D Multijet Diesel 55 04/07 → 03/08

MJD6F3P8

A1 CENTRALINA CONTROLLO MOTORE
ENGINE CONTROL UNIT

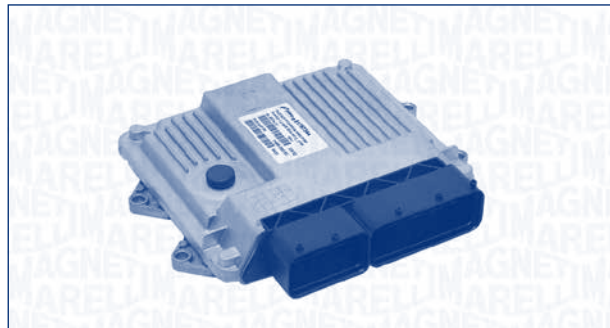

FIAT

PUNTO / GRANDE PUNTO (199)

1.3 D Multijet Diesel 66 10/05 →

MJD6F3PB

A1 CENTRALINA CONTROLLO MOTORE
ENGINE CONTROL UNIT

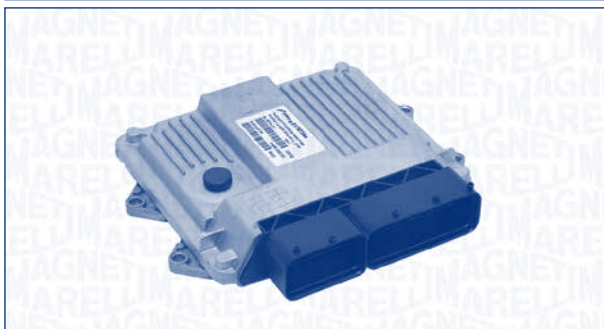

FIAT

PUNTO / GRANDE PUNTO (199)

1.3 D Multijet Diesel 66 10/05 →

MJD6F3Y2

A1 CENTRALINA CONTROLLO MOTORE
ENGINE CONTROL UNIT

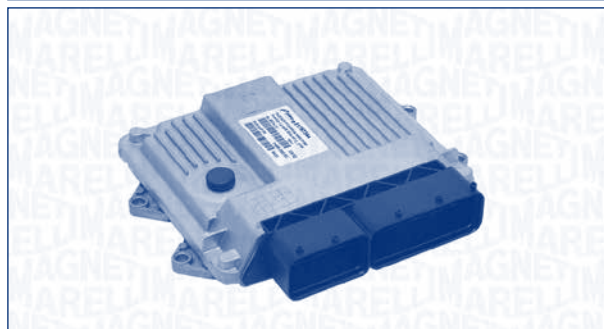

LANCIA

YPSILON (843)

1.3 D Multijet Diesel 55 09/06 → 12/11

MJD6F3PB/1

A1 CENTRALINA CONTROLLO MOTORE
ENGINE CONTROL UNIT

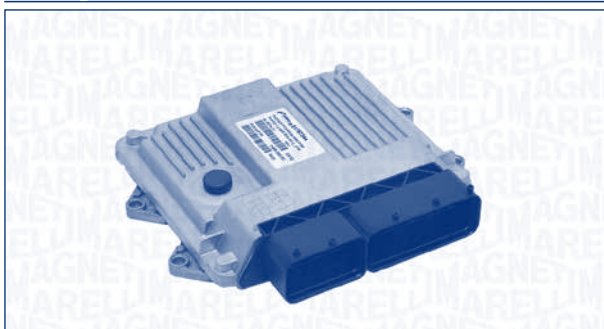

FIAT

PUNTO / GRANDE PUNTO (199)

1.3 D Multijet Diesel 66 07/08 →

MJD6F3Y5

A1 CENTRALINA CONTROLLO MOTORE
ENGINE CONTROL UNIT

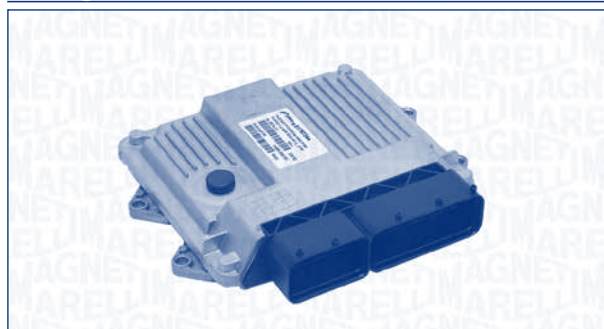

LANCIA

YPSILON (843)

1.3 D Multijet Diesel 55 09/06 → 12/11

MJD6JFM5

A1 CENTRALINA CONTROLLO MOTORE
ENGINE CONTROL UNIT

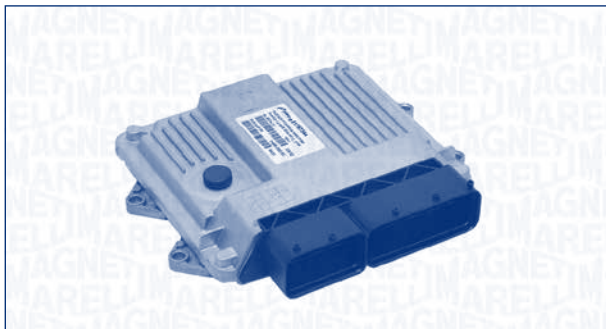

FIAT

IDEA

1.3 D Multijet Diesel 66 10/05 → ENGINE: → 1866163

LANCIA

MUSA (350)

1.3 D Multijet Diesel 66 09/06 → ENGINE: → 1866163

MJD6JFP1

A1 CENTRALINA CONTROLLO MOTORE
ENGINE CONTROL UNIT

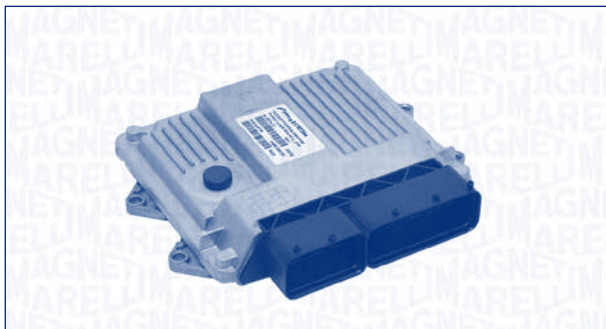

FIAT

PUNTO (188)

1.3 JTD 16V Diesel 51 06/03 →

MJD6JFP3

A1 CENTRALINA CONTROLLO MOTORE
ENGINE CONTROL UNIT

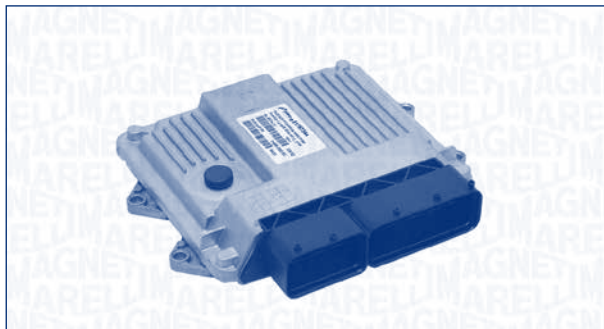

FIAT

PUNTO (188)

1.3 JTD 16V Diesel 51 06/03 →

MJD6JFS1

A1 CENTRALINA CONTROLLO MOTORE
ENGINE CONTROL UNIT

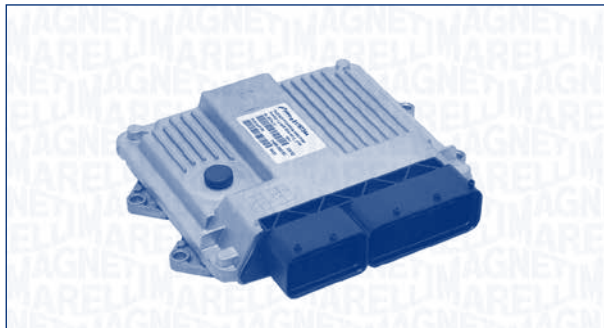

FIAT

PANDA (169)

1.3 D Multijet Diesel 51 09/03 →

MJD6JFS3

A1 CENTRALINA CONTROLLO MOTORE
ENGINE CONTROL UNIT

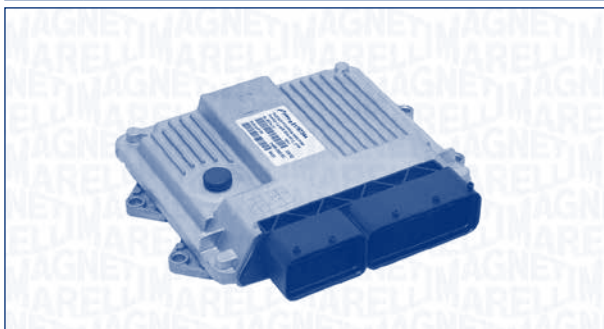

FIAT

PANDA (169)

1.3 D Multijet Diesel 51 09/03 →

MJD6JFS4

A1 CENTRALINA CONTROLLO MOTORE
ENGINE CONTROL UNIT

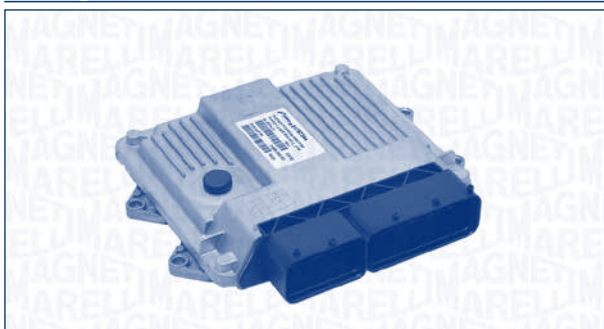

FIAT

PANDA (169)

1.3 D Multijet 4x4 Diesel 51 10/04 →

IAW59F.SCR

A2 CENTRALINA CONTROLLO MOTORE RIGENERATA
ENGINE CONTROL UNIT REMANUFACTURED

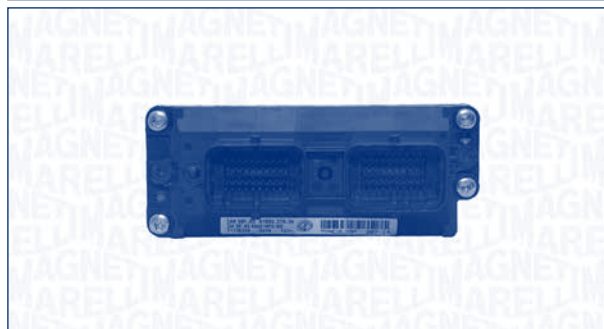

FIAT

DOBLO (119)

1.2 (223AXA1A) Petrol 48 03/01 → 12/03

DOBLO Cargo (223)

1.2 (223ZX1A) Petrol 48 03/01 → 12/03

IAW59FM2R/1

A2 CENTRALINA CONTROLLO MOTORE RIGENERATA
ENGINE CONTROL UNIT REMANUFACTURED



FIAT

PUNTO (188)

1.2 60 (188.030, .050, .130, .150, .230, .250) Petrol 44 09/99 → 12/00

FIAT

PUNTO Van (188AX)

1.2 60 Petrol 44 02/00 → 12/00

IAW59FM3R/1
A2 CENTRALINA CONTROLLO MOTORE RIGENERATA
ENGINE CONTROL UNIT REMANUFACTURED

FIAT
PUNTO (188)

1.2 60 (188.030, .050, .130, .150, .230, .250)	Petrol	44	01/01 → 05/03	ENGINE: 188A4000-230, .250)
--	--------	----	---------------	-----------------------------

PUNTO Van (188AX)

1.2 60	Petrol	44	01/01 → 05/03	ENGINE: 188A4000-
--------	--------	----	---------------	-------------------

IAW59FM5R/1
A2 CENTRALINA CONTROLLO MOTORE RIGENERATA
ENGINE CONTROL UNIT REMANUFACTURED

LANCIA
Y (840A)

1.2 (840AA, 840AF1A)	Petrol	44	01/01 → 09/03	
----------------------	--------	----	---------------	--

IAW59FM7R
A2 CENTRALINA CONTROLLO MOTORE RIGENERATA
ENGINE CONTROL UNIT REMANUFACTURED

FIAT
SEICENTO (187)

1.1 (187AXB, 187AXB1A)	Petrol	40	01/01 → 06/01	ENGINE: 176B2000
------------------------	--------	----	---------------	------------------

SEICENTO Van (187)

1.1 (187CXB/C)	Petrol	40	01/01 → 06/01	ENGINE: 176B2000
----------------	--------	----	---------------	------------------

GRUPPO B - GROUP B
B01
B1 ATTUATORE CONTROLLO MINIMO
IDLE SPEED CONTROL ACTUATOR KIT

FIAT
CINQUECENTO (170)

0.9 i.e. S (170AF, 170CF)	Petrol	29	01/92 → 01/98	
---------------------------	--------	----	---------------	--

PANDA (141A_)

900	Petrol	29	04/92 → 12/96	
-----	--------	----	---------------	--

SEICENTO (187)

0.9 (187AXA, 187AXA1A)	Petrol	29	01/98 → 12/00	
------------------------	--------	----	---------------	--

B02

B1 ATTUATORE CONTROLLO MINIMO
IDLE SPEED CONTROL ACTUATOR KIT



ALFA ROMEO

145 (930)

1.4 i.e. Petrol 66 07/94 → 12/96

146 (930)

1.4 i.e. Petrol 66 12/94 → 12/96

FIAT

BRAVA (182)

1.6 16V (182.BH) Petrol 66 10/95 → 03/98

BRAVO I (182)

1.6 16V (182.AH) Petrol 66 10/95 → 03/98

PALIO (178BX)

1.6 16V Petrol 74 04/96 → 12/98

PALIO Weekend (178DX)

1.6 16V (178DX. D1A) Petrol 74 04/96 → 12/98

TEMPRA (159)

1.8 i.e. (159.AN) Petrol 77 01/93 → 08/96

1.8 i.e. (159.AN) Petrol 81 01/93 → 08/96

1.8 i.e. (159.AV) Petrol 76 09/93 → 08/96

1.8 i.e. (159.AZ) Petrol 66 09/93 → 08/96

1.8 i.e. (159.BY) Petrol 74 10/94 → 08/96

TEMPRA S.W. (159)

1.8 i.e. (159.AN) Petrol 77 01/93 → 12/93

1.8 i.e. (159.AN) Petrol 81 01/93 → 08/96

1.8 i.e. (159.AV) Petrol 76 09/93 → 08/96

1.8 i.e. (159.AZ) Petrol 66 09/93 → 08/96

1.8 i.e. (159.BY) Petrol 74 10/94 → 08/96

TIPO (160)

1.8 i.e. Petrol 71 03/93 → 04/95

1.8 i.e. Petrol 66 09/93 → 04/95

1.8 i.e. Petrol 81 10/90 → 06/93

1.8 i.e. (160.ED) Petrol 76 04/93 → 04/95

1.8 i.e. (160.EQ, 160.AM) Petrol 74 10/94 → 04/95

B02



LANCIA

DEDRA (835)

1.8 i.e. (835AT) Petrol 66 01/94 → 12/96

1.8 i.e. (835BD, 835AD) Petrol 77 01/94 → 12/96

1.8 i.e. (835FA) Petrol 74 07/94 → 12/96

DELTA II (836)

1.8 i.e. (836AE) Petrol 76 06/93 → 12/96

B03

B1 ATTUATORE CONTROLLO MINIMO
IDLE SPEED CONTROL ACTUATOR



CITROËN

AX (ZA-)

11 Petrol 44 01/91 → 12/97

PEUGEOT

106 II (1)

1.1 i Petrol 40 01/97 →

205 II (20A/C)

1.1 Petrol 44 07/89 → 09/98

306 (7B, N3, N5)

1.1 Petrol 44 06/94 → 05/01

306 2 volumi /Coda spiovente (7A, 7C, N3, N5)

1.1 Petrol 44 05/93 → 05/01

RENAULT

CLIO I (B/C57_, 5/357_)

1.2 (5/357Y, 5/357K) Petrol 40 01/96 → 09/98

1.2 (B/C/S577) Petrol 40 01/96 → 12/96

1.2 (B/C57R) Petrol 40 01/91 → 01/96

CLIO I Furgonato (S57_)

1.2 Petrol 40 01/91 → 09/98

TWINGO I (C06_)

1.2 (C063, C064) Petrol 40 03/93 → 10/96

B03

KW

RENAULT
TWINGO I Furgonato (S06_)

1.2 (S063, S064) Petrol 40 03/93 → 05/96

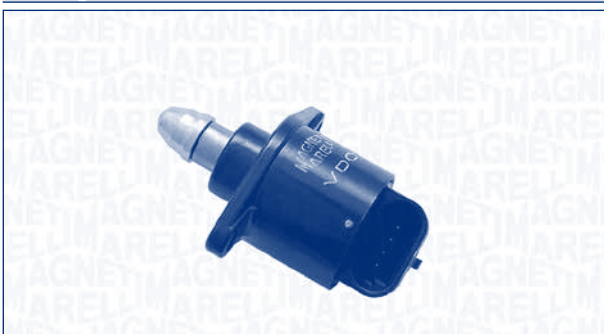
B04
B1
**ATTUATORE CONTROLLO MINIMO
IDLE SPEED CONTROL ACTUATOR**

KW

CITROËN
BX (XB-)

15	Petrol	59	01/91 → 05/92
16	Petrol	53	01/91 → 02/93
16	Petrol	55	01/91 → 02/93
16	Petrol	58	01/91 → 02/93
16	Petrol	64	01/91 → 02/93
16	Petrol	76	01/91 → 02/93
16 E	Petrol	65	01/91 → 02/93

BX Break (XB-)

16	Petrol	53	01/91 → 12/94
16	Petrol	55	01/91 → 12/94
16	Petrol	64	01/91 → 12/94
16	Petrol	65	01/91 → 12/94
16	Petrol	76	01/91 → 12/94

EVASION (22, U6)

1.8 Petrol 73 05/97 → 07/02

EVASION (22, U6)

2.0 Petrol 89 06/94 → 07/02

JUMPER Autobus (230P)

2.0 Petrol 80 02/94 → 04/94

JUMPER Furgonato (230L)

2.0 Petrol 80 03/94 → 04/94

JUMPER Pianale piatto/Telaio (230)

2.0 Petrol 80 03/94 → 04/94

B04

KW

CITROËN
XANTIA (X1)

1.6 i	Petrol	65	03/93 → 01/98
1.8 i	Petrol	66	04/97 → 01/98
1.8 i	Petrol	74	03/93 → 01/98
2.0 i	Petrol	89	03/93 → 01/98

XANTIA Break (X1)

1.8 i	Petrol	66	04/97 → 01/98
1.8 i	Petrol	74	06/95 → 01/98
1.8 i 16V	Petrol	81	06/95 → 01/98
2.0 i	Petrol	89	06/95 → 01/98

XSARA (N1)

1.8 i	Petrol	66	04/97 → 09/00
1.8 i Aut.	Petrol	74	04/97 → 12/99

XSARA Break (N2)

1.8 i	Petrol	66	10/97 → 09/00
1.8 i Aut.	Petrol	74	10/97 → 09/00

XSARA Coupé (N0)

1.8 i	Petrol	66	02/98 → 09/00
1.8 i	Petrol	74	02/98 → 09/00

ZX (N2)

1.6 i	Petrol	65	03/91 → 06/97
1.8 i	Petrol	74	07/92 → 06/97
2.0 i	Petrol	89	07/92 → 06/97

ZX Break (N2)

1.6 i	Petrol	65	10/93 → 10/97
1.8 i	Petrol	74	10/93 → 10/97

DODGE
RAM 4000 Pianale piatto/Telaio (DH, DR, D1, DC, DM)

2.0 4x4 Petrol 282 06/98 →

FIAT
DUCATO Autobus (230)

 2.0 Panorama/
Combinato Petrol 80 03/94 → 04/94

DUCATO Furgonato (230L)

2.0 Petrol 80 03/94 → 04/94

DUCATO Pianale piatto/Telaio (230)

2.0 Petrol 80 06/98 → 04/02

ULYSSE (220)

1.8 (220.BB5)	Petrol	73	05/97 → 08/02
2.0 (220.AC5)	Petrol	89	06/94 → 08/02

PEUGEOT
205 I Cabriolet (741B, 20D)

1.6 CJ Petrol 65 08/92 → 12/92

B04



PEUGEOT

205 II (20A/C)

1.6 Aut.	Petrol	58	01/91 → 12/92
1.6 Aut.	Petrol	65	01/91 → 12/92

306 (7B, N3, N5)

1.8 ST	Petrol	74	06/94 → 05/01
2.0	Petrol	97	03/97 → 05/01
2.0 ST	Petrol	89	07/94 → 05/01

306 2 volumi /Coda spiovente (7A, 7C, N3, N5)

1.8	Petrol	74	05/93 → 05/01
2.0 XSi	Petrol	89	05/93 → 05/01

306 Break (7E, N3, N5)

1.8	Petrol	74	03/97 → 04/02
2.0	Petrol	97	03/97 → 04/02

306 Cabriolet (7D, N3, N5)

1.8	Petrol	74	03/94 → 04/02
2.0	Petrol	89	03/94 → 04/02

405 I (15B)

1.6	Petrol	53	01/91 → 12/92
1.6	Petrol	65	01/91 → 12/92
1.6	Petrol	66	01/91 → 12/92
1.6	Petrol	69	01/91 → 12/92

405 I Break (15E)

1.6	Petrol	53	01/91 → 08/92
1.6	Petrol	55	01/91 → 08/92
1.6	Petrol	65	01/91 → 08/92
1.6	Petrol	66	01/91 → 08/92
1.6	Petrol	69	01/91 → 08/92

405 II (4B)

1.6	Petrol	65	08/92 → 10/95
1.8	Petrol	74	08/92 → 10/95
2.0 T 16 X4	Petrol	144	08/92 → 10/95

405 II Break (4E)

1.6	Petrol	65	08/92 → 10/96
1.8	Petrol	74	08/92 → 10/96

406 (8B)

1.6	Petrol	65	11/95 → 05/04
1.8	Petrol	66	05/97 → 05/04

406 Break (8E/F)

1.8	Petrol	66	05/97 → 10/04
-----	--------	----	---------------

806 (221)

2.0	Petrol	89	06/94 → 08/02
-----	--------	----	---------------

BOXER Autobus (230P)

2.0 i	Petrol	80	03/94 → 04/02
-------	--------	----	---------------

BOXER Furgonato (230L)

2.0 i	Petrol	80	06/94 → 04/02
-------	--------	----	---------------

B04



PEUGEOT

BOXER Pianale piatto/Telaio (ZCT_)

2.0 i	Petrol	80	06/94 → 04/02
-------	--------	----	---------------

B06

**B1 ATTUATORE CONTROLLO MINIMO
IDLE SPEED CONTROL ACTUATOR**



ALFA ROMEO

33 (905)

1.3 i.e.	Petrol	66	01/86 → 12/89
----------	--------	----	---------------

B12

**B1 ATTUATORE CONTROLLO MINIMO
IDLE SPEED CONTROL ACTUATOR KIT**



FIAT

CINQUECENTO (170)

1.1 Sporting (170AH)	Petrol	40	10/94 → 01/98
----------------------	--------	----	---------------

PANDA (141A_)

1100	Petrol	37	05/91 → 12/99
1100	Petrol	40	02/95 → 12/00
1000 i.e. Cat.	Petrol	33	10/87 → 08/98
1100 4x4	Petrol	40	02/95 → 12/00

B12

FIAT
PANDA (141A_)

1100 Trekking 4x4	Petrol	37	10/91 → 12/00
----------------------	--------	----	---------------

PUNTO (176)

55 1.1	Petrol	40	09/93 → 09/99
60 1.2	Petrol	43	01/94 → 09/99
60 1.2	Petrol	44	03/94 → 09/99

SEICENTO (187)

1.1 (187AXB, 187AXB1A)	Petrol	40	01/98 → 12/00
---------------------------	--------	----	---------------

SEICENTO Van (187)

1.1 (187CXB/C)	Petrol	40	01/98 → 12/00
----------------	--------	----	---------------

LANCIA
Y (840A)

1.1 (840AE)	Petrol	40	11/95 → 12/00
1.2 (840AA, 840AF1A)	Petrol	44	03/96 → 12/00

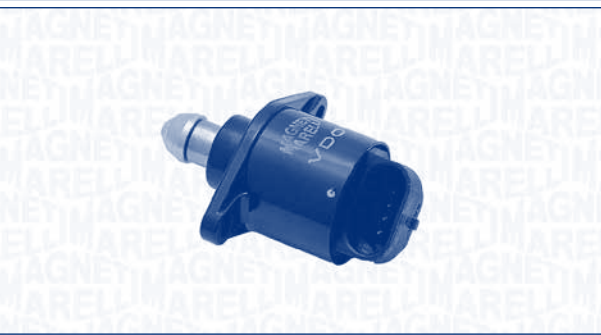
B13
B1 **ATTUATORE CONTROLLO MINIMO
IDLE SPEED CONTROL ACTUATOR**

CITROËN
XSARA Coupé (N0)

2.0 i 16V	Petrol	120	02/98 → 12/00	ENGINE: XU10J4RS
-----------	--------	-----	---------------	------------------

PEUGEOT
106 I (1A, 1C)

1.3	Petrol	72	10/93 → 04/96	ENGINE: TU2J2
1.6	Petrol	76	01/94 → 04/96	ENGINE: TU5J2

B14
B1 **ATTUATORE CONTROLLO MINIMO
IDLE SPEED CONTROL ACTUATOR**

CITROËN
ZX (N2)

1.4 i	Petrol	55	01/94 → 06/97
-------	--------	----	---------------

ZX Break (N2)

1.4 i	Petrol	55	01/94 → 10/97
-------	--------	----	---------------

PEUGEOT
306 (7B, N3, N5)

1.4 SL	Petrol	55	06/94 → 05/01
--------	--------	----	---------------

306 2 volumi /Coda spiovente (7A, 7C, N3, N5)

1.4	Petrol	55	01/94 → 05/01
-----	--------	----	---------------

306 Break (7E, N3, N5)

1.4	Petrol	55	03/97 → 04/02
-----	--------	----	---------------

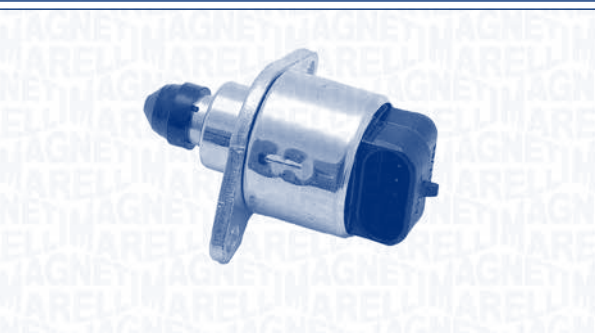
B17
B1 **ATTUATORE CONTROLLO MINIMO
IDLE SPEED CONTROL ACTUATOR**

CITROËN
SAXO (S0, S1)

1.6 VTS	Petrol	87	06/96 → 12/00	ENGINE: TU5J4-L3
---------	--------	----	---------------	------------------

PEUGEOT
106 II (1)

1.6 S16	Petrol	87	05/96 → 12/00	ENGINE: TU5J4-L3
---------	--------	----	---------------	------------------

B18

B1 ATTUATORE CONTROLLO MINIMO
IDLE SPEED CONTROL ACTUATOR KIT



FIAT

PALIO (178BX)

1.2 Petrol 54 06/98 → 12/01

PALIO Weekend (178DX)

1.2 (178DX.G1A) Petrol 54 01/97 → 02/01

1.2 (178DYA1A) Petrol 44 02/01 → 12/01

PUNTO (176)

75 1.2 Petrol 54 12/93 → 05/98

SIENA (178_)

1.2 Petrol 54 09/98 → 12/00

STRADA Pick-up (178E)

1.2 Petrol 54 06/99 → 12/00

B22/1

B1 ATTUATORE CONTROLLO MINIMO
IDLE SPEED CONTROL ACTUATOR



PEUGEOT

306 (7B, N3, N5)

1.8 16V Petrol 81 03/97 → 05/01

406 (8B)

1.8 Petrol 66 01/98 → 05/04

1.8 16V Petrol 81 11/95 → 10/00

406 Break (8E/F)

1.8 Petrol 66 01/98 → 10/04

B22/1



PEUGEOT

RANCH MPV / Space wagon (5F)

1.8 Petrol 66 01/98 →

B23/00

B1 ATTUATORE CONTROLLO MINIMO
IDLE SPEED CONTROL ACTUATOR



RENAULT

CLIO I (B/C57_, 5/357_)

1.2 (B/C/S57A, B/C57S, 5/357F, 5/357J, 5/357L, 5/357R) Petrol 43 05/90 → 09/98 ENGINE: D7F

CLIO I Furgonato (S57_)

1.2 Petrol 44 01/91 → 09/98 ENGINE: D7F

CLIO II (BB0/1/2_, CB0/1/2_)

1.2 (BB0A, BB0F, BB10, BB1K, BB28, BB2D, BB2H, CB0A...) Petrol 43 09/98 → ENGINE: D7F

CLIO II Furgonato (SB0/1/2_)

1.1 (SB0A, SB0F, SB1K, SB2D) Petrol 43 09/98 → ENGINE: D7F

KANGOO (KC0/1_)

1.2 (KC0A, KC0K, KC0F, KC01) Petrol 43 02/98 →

KANGOO Express (FC0/1_)

1.2 (FC01, FC0A, FC0F) Petrol 43 02/98 →

TWINGO I Furgonato (S06_)

1.2 (S066, S068) Petrol 43 05/96 →

B24/00
B1 ATTUATORE CONTROLLO MINIMO
IDLE SPEED CONTROL ACTUATOR

KW

CITROËN
XSARA (N1)

1.4 i Petrol 55 04/97 → 12/00 ENGINE: TU3JP,L3

XSARA Break (N2)

1.4 i Petrol 55 10/97 → 12/00 ENGINE: TU3JP,L3

XSARA Coupé (N0)

1.4 i Petrol 55 03/98 → 03/05 ENGINE: TU3JP,L3

ZX (N2)

1.4 i Petrol 55 03/91 → 06/97 ENGINE: TU3JP,L3

ZX Break (N2)

1.4 i Petrol 55 10/93 → 10/97 ENGINE: TU3JP,L3

PEUGEOT
306 (7B, N3, N5)

1.4 SL Petrol 55 01/96 → 12/98 ENGINE: TU3JP,L3

306 2 volumi /Coda spiovente (7A, 7C, N3, N5)

1.4 Petrol 55 05/93 → 05/01 ENGINE: TU3JP,L3

306 Break (7E, N3, N5)

1.4 Petrol 55 03/97 → 04/02 ENGINE: TU3JP,L3

RANCH MPV / Space wagon (5F)

1.4 Petrol 55 06/96 → ENGINE: TU3JP,L3

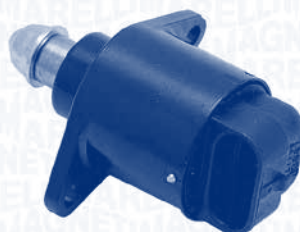
B27
B1 ATTUATORE CONTROLLO MINIMO
IDLE SPEED CONTROL ACTUATOR

KW

PEUGEOT
206 2 volumi /Coda spiovente (2A/C)

1.4 i Petrol 55 09/98 → 12/00 ENGINE: TU3JP(Z,L,L3)

B28/00
B1 ATTUATORE CONTROLLO MINIMO
IDLE SPEED CONTROL ACTUATOR

KW

RENAULT
MEGANE I (BA0/1_)

1.6 e (BA0F, BA0S) Petrol 66 01/96 → 03/99 ENGINE: K7M

1.6 i (BA0L) Petrol 55 01/96 → 03/99 ENGINE: K7M

MEGANE I Coach (DA0/1_)

1.6 e (DA0F) Petrol 66 03/96 → 03/99 ENGINE: K7M

B30/01

B1 ATTUATORE CONTROLLO MINIMO
IDLE SPEED CONTROL ACTUATOR

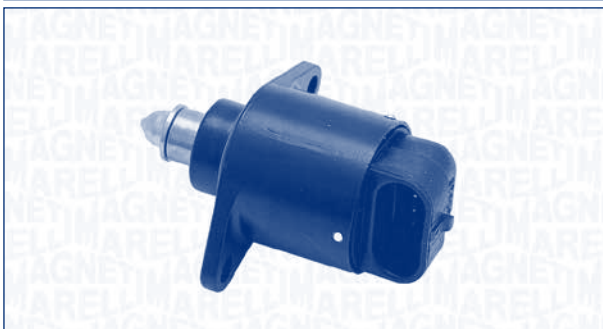

PEUGEOT

206 2 volumi /Coda spiovente (2A/C)

1.1 i Petrol 44 09/98 → ENGINE: TU1JP+

206 SW (2E/K)

1.1 Petrol 44 07/02 → ENGINE: TU1JP+

B31/2

B1 ATTUATORE CONTROLLO MINIMO
IDLE SPEED CONTROL ACTUATOR

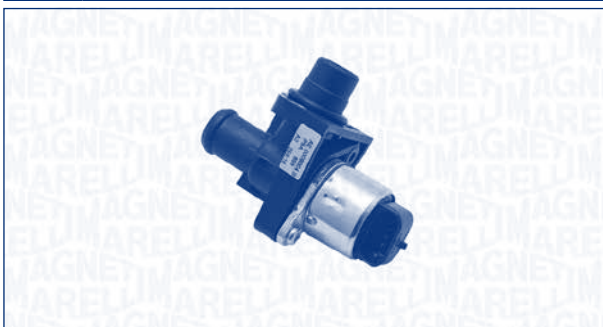

PEUGEOT

306 (7B, N3, N5)

1.6 SR Petrol 65 06/94 → 10/00 ENGINE: TU5JP

306 2 volumi /Coda spiovente (7A, 7C, N3, N5)

1.6 Petrol 65 05/93 → 10/00 ENGINE: TU5JP

306 Break (7E, N3, N5)

1.6 Petrol 65 03/97 → 10/00 ENGINE: TU5JP

B32/00

B1 ATTUATORE CONTROLLO MINIMO
IDLE SPEED CONTROL ACTUATOR



CITROËN

BERLINGO (MF)

1.8 i (MFLFX) Petrol 66 05/97 → ENGINE: XU7JB

BERLINGO Furgonato (M_)

1.8 i Petrol 66 08/99 → 10/02 ENGINE: XU7JB

XANTIA (X2)

1.8 i Petrol 66 01/98 → 04/03 ENGINE: XU7JB

XANTIA Break (X2)

1.8 i Petrol 66 01/98 → 04/03 ENGINE: XU7JB

XSARA (N1)

1.8 i Petrol 66 04/97 → 09/00 ENGINE: XU7JB

XSARA Break (N2)

1.8 i Petrol 66 10/97 → 09/00 ENGINE: XU7JB

PEUGEOT

406 (8B)

1.8 Petrol 66 04/98 → 05/04 ENGINE: XU7JB

RANCH MPV / Space wagon (5F)

1.8 Petrol 66 05/97 → ENGINE: XU7JB

B32/01
B1 ATTUATORE CONTROLLO MINIMO
IDLE SPEED CONTROL ACTUATOR

PEUGEOT
206 2 volumi /Coda spiovente (2A/C)

1.4 i Petrol 55 01/00 → 11/00 ENGINE: TU3JP,L3

306 (7B, N3, N5)

1.4 SL Petrol 55 01/00 → 11/00 ENGINE: TU3JP,L3

306 2 volumi /Coda spiovente (7A, 7C, N3, N5)

1.4 Petrol 55 01/00 → 11/00 ENGINE: TU3JP,L3

306 Break (7E, N3, N5)

1.4 Petrol 55 01/00 → 11/00 ENGINE: TU3JP,L3

RANCH MPV / Space wagon (5F)

1.4 Petrol 55 01/00 → 11/00 ENGINE: TU3JP,L3

B3215
B1 ATTUATORE CONTROLLO MINIMO
IDLE SPEED CONTROL ACTUATOR

OPEL
ASTRA F (56_, 57_)

1.4 i 16V Petrol 66 02/96 → 09/98

1.4 Si Petrol 60 03/92 → 09/98

1.6 i 16V Petrol 74 08/94 → 09/98

1.6 Si Petrol 74 05/92 → 12/94

B3215

OPEL
ASTRA F 2 volumi /Coda spiovente (53_, 54_, 58_, 59_)

1.4 Petrol 60 09/92 → 01/98

1.4 i 16V Petrol 66 01/96 → 01/98

1.4 Si Petrol 60 03/92 → 01/98

1.6 i 16V Petrol 74 08/94 → 01/98

1.6 Si Petrol 74 03/92 → 12/94

ASTRA F Cabriolet (53_B)

1.4 i 16V Petrol 66 01/96 → 03/01

1.4 Si Petrol 60 05/93 → 03/01

ASTRA F CLASSIC 2 volumi /Coda spiovente

1.6 i 16V Petrol 74 01/98 → 08/02

ASTRA F CLASSIC Station wagon

1.6 i 16V Petrol 74 01/98 → 01/05

ASTRA F CLASSIC Tre volumi

1.6 i 16V Petrol 74 01/98 → 08/02

ASTRA F Station wagon (51_, 52_)

1.4 Petrol 60 09/92 → 01/98

1.4 i 16V Petrol 66 02/96 → 01/98

1.4 Si Petrol 60 03/92 → 01/98

1.6 i 16V Petrol 74 08/94 → 01/98

1.6 Si Petrol 74 03/92 → 12/94

ASTRA G 2 volumi /Coda spiovente (F48_, F08_)

1.4 16V Petrol 66 02/98 → 01/05

1.6 16V Petrol 74 02/98 → 01/05

ASTRA G Cabriolet (F67)

1.6 16V Petrol 74 03/01 → 10/05

ASTRA G Station wagon (F35_)

1.4 16V Petrol 66 06/98 → 07/04

1.6 16V Petrol 74 02/98 → 07/04

ASTRA G Tre volumi (F69_)

1.4 16V Petrol 66 09/98 → 01/05

1.6 16V Petrol 74 09/98 → 01/05

COMBO (71_)

1.4 Petrol 60 07/94 → 10/01

CORSA A 2 volumi /Coda spiovente (93_, 94_, 98_, 99_)

1.4 Si Petrol 60 09/91 → 03/93

1.6 GSI Petrol 74 05/88 → 03/92

CORSA B (73_, 78_, 79_)

1.4 i 16V Petrol 63 08/97 → 09/00

1.4 i 16V Petrol 66 09/94 → 09/00

1.4 Si Petrol 60 03/93 → 09/00

1.6 GSI 16V Petrol 80 03/93 → 09/00

1.6 i 16V Petrol 74 08/97 → 09/00

1.6 i 16V Petrol 78 09/94 → 09/00

B3215



KW



OPEL

TIGRA (95_)

1.4 16V	Petrol	66	07/94 → 12/00
1.6 16V	Petrol	74	08/97 → 08/98
1.6 16V	Petrol	78	07/94 → 08/98

VECTRA B (36_)

1.6 i 16V	Petrol	74	10/95 → 04/02
-----------	--------	----	---------------

ZAFIRA A (F75_)

1.6 16V	Petrol	74	04/99 → 06/05
---------	--------	----	---------------

VAUXHALL

ASTRA Mk III (F)

1.4 i	Petrol	60	04/92 → 09/98
1.4 i 16V	Petrol	66	02/96 → 09/98
1.6 i	Petrol	74	05/92 → 12/94
1.6 i 16V	Petrol	74	08/94 → 09/98

ASTRA Mk III (F) 2 volumi /Coda spiovente

1.4 i	Petrol	60	03/92 → 02/98
1.4 i 16V	Petrol	66	02/96 → 02/98
1.6 i	Petrol	74	03/92 → 02/98

ASTRA Mk III (F) Cabriolet

1.4 i	Petrol	60	05/93 → 03/01
1.4 i 16V	Petrol	66	01/96 → 03/01

ASTRA Mk III (F) Station wagon

1.4 i	Petrol	60	03/91 → 02/98
1.4 i 16V	Petrol	66	02/96 → 01/98
1.6 i 16V	Petrol	74	01/94 → 02/98
1.6 Si	Petrol	74	03/91 → 12/94

ASTRA Mk IV (G) 2 volumi /Coda spiovente

1.4 16V	Petrol	66	02/98 → 05/05
1.6 16V	Petrol	74	02/98 → 05/05

ASTRA Mk IV (G) Station wagon

1.4 16V	Petrol	66	02/98 → 05/05
1.6 16V	Petrol	74	03/98 → 04/04

ASTRA Mk IV (G) Tre volumi

1.4 16V	Petrol	66	09/98 → 05/05
1.6 16V	Petrol	74	09/98 → 05/05

COMBO Mk II (C) Cassone / Furgonato / Promiscuo (F25)

1.4 i 16V	Petrol	66	01/04 → 11/11
-----------	--------	----	---------------

CORSA Cabriolet

1.4 i 16V	Petrol	66	01/98 → 01/99
-----------	--------	----	---------------

NOVA 2 volumi /Coda spiovente

1.6 GSI	Petrol	74	05/88 → 03/92
---------	--------	----	---------------

TIGRA Mk I (F07)

1.4 16V	Petrol	66	07/94 → 12/00
1.6 16V	Petrol	78	07/94 → 12/00

B3215



KW



OPEL

VECTRA (B)

1.6 i 16V	Petrol	74	09/95 → 10/01
-----------	--------	----	---------------

VECTRA (B) 2 volumi /Coda spiovente

1.6 i 16V	Petrol	74	09/95 → 10/01
-----------	--------	----	---------------

VECTRA (B) Station wagon

1.6 i 16V	Petrol	74	11/96 → 03/02
-----------	--------	----	---------------

ZAFIRA Mk I (A) (F75)

1.6 16V	Petrol	74	04/99 → 08/05
---------	--------	----	---------------

B3253

**B1 ATTUATORE CONTROLLO MINIMO
IDLE SPEED CONTROL ACTUATOR**



KW



OPEL

ASTRA F (56_, 57_)

1.6	Petrol	55	09/95 → 09/98
1.6 i	Petrol	52	05/93 → 07/96
1.6 i	Petrol	55	03/92 → 08/94
1.6 i	Petrol	55	08/96 → 09/98
1.8 i	Petrol	66	03/92 → 09/98

ASTRA F 2 volumi /Coda spiovente (53_, 54_, 58_, 59_)

1.6	Petrol	55	09/95 → 01/98
1.6 i	Petrol	52	05/93 → 07/96
1.6 i	Petrol	55	09/91 → 01/98
1.8 i	Petrol	66	09/91 → 01/98

ASTRA F Cabriolet (53_B)

1.6 i	Petrol	52	03/93 → 08/96
1.6 i	Petrol	55	01/96 → 03/01

ASTRA F CLASSIC 2 volumi /Coda spiovente

1.6 i	Petrol	55	01/98 → 08/02
-------	--------	----	---------------

ASTRA F CLASSIC Tre volumi

1.6 i	Petrol	55	01/98 → 08/02
-------	--------	----	---------------

ASTRA F Station wagon (51_, 52_)

1.6	Petrol	55	09/95 → 01/98
1.6 i	Petrol	52	05/93 → 07/96

B3253

OPEL
ASTRA F Station wagon (51_, 52_)

1.6 i	Petrol	55	09/91 → 01/98
1.8 i	Petrol	66	09/91 → 01/98

ASTRA F Van (55_)

1.6 i	Petrol	52	02/93 → 07/96
1.6 i	Petrol	55	10/91 → 04/93

COMBO (71_)

1.4	Petrol	44	07/94 → 10/01
-----	--------	----	---------------

CORSA A 2 volumi /Coda spiovente (93_, 94_, 98_, 99_)

1.6 GSI	Petrol	55	08/88 → 09/92
---------	--------	----	---------------

CORSA B (73_, 78_, 79_)

1.4 i	Petrol	44	03/93 → 09/00
-------	--------	----	---------------

CORSA B Furgonato (73_)

1.4 i	Petrol	44	08/99 → 09/00
-------	--------	----	---------------

KADETT E Combo (38_, 48_)

1.6 i	Petrol	55	08/91 → 07/94
-------	--------	----	---------------

KADETT E Furgonato (37_, 47_)

1.6 i	Petrol	55	08/89 → 09/93
-------	--------	----	---------------

VECTRA A (86_, 87_)

1.6 i	Petrol	52	09/93 → 11/95
1.6 i	Petrol	55	09/88 → 10/90
1.6 i	Petrol	55	09/93 → 11/95
1.8 i Cat.	Petrol	66	03/90 → 11/95

VECTRA A 2 volumi /Coda spiovente (88_, 89_)

1.6 i	Petrol	55	09/93 → 11/95
1.6 i Cat.	Petrol	55	09/88 → 11/95

B33
**B1 ATTUATORE CONTROLLO MINIMO
IDLE SPEED CONTROL ACTUATOR**

CITROËN
C5 II (RC_)

2.0 16V (RCRFJB, RCRFJC)	Petrol	103	09/04 → ENGINE: EW10J4
--------------------------	--------	-----	------------------------

B33

CITROËN
C5 II Break (RE_)

2.0 16V (RERFJB, RERFJC)	Petrol	103	09/04 → ENGINE: EW10J4
--------------------------	--------	-----	------------------------

EVASION (22, U6)

2.0 16V	Petrol	100	05/00 → 07/02 ENGINE: EW10J4
2.0 16V	Petrol	97	05/98 → 04/00 ENGINE: EW10J4

JUMPY (U6U)

2.0 i 16V	Petrol	102	03/00 → 12/03 ENGINE: EW10J4
-----------	--------	-----	------------------------------

JUMPY Furgonato (BS_, BT_, BY_, BZ_)

2.0 i 16V	Petrol	102	03/00 → 12/03 ENGINE: EW10J4
-----------	--------	-----	------------------------------

XSARA (N1)

2.0 16V	Petrol	97	07/98 → 09/00 ENGINE: EW10J4
---------	--------	----	------------------------------

XSARA Break (N2)

2.0 16V	Petrol	97	07/98 → 09/00 ENGINE: EW10J4
---------	--------	----	------------------------------

XSARA PICASSO (N68)

1.8 16V	Petrol	85	02/00 →
2.0 16V	Petrol	100	01/03 → ENGINE: EW10J4

PEUGEOT
206 2 volumi /Coda spiovente (2A/C)

2.0 S16	Petrol	100	06/99 → ENGINE: EW10J4
2.0 S16	Petrol	99	04/99 → 10/00 ENGINE: EW10J4

206 CC (2D)

2.0 S16	Petrol	100	09/00 → ENGINE: EW10J4
---------	--------	-----	------------------------

206 SW (2E/K)

2.0 16V	Petrol	100	07/02 → ENGINE: EW10J4
---------	--------	-----	------------------------

307 Break (3E)

2.0 16V	Petrol	103	03/05 → ENGINE: EW10J4
---------	--------	-----	------------------------

307 CC (3B)

2.0 16V	Petrol	103	03/05 → ENGINE: EW10J4
---------	--------	-----	------------------------

307 SW (3H)

2.0 16V	Petrol	103	03/05 → ENGINE: EW10J4
---------	--------	-----	------------------------

406 (8B)

2.0 16V	Petrol	97	11/95 → 04/98 ENGINE: EW10J4
---------	--------	----	------------------------------

806 (221)

2.0 16V	Petrol	100	09/00 → 08/02 ENGINE: EW10J4
2.0 16V	Petrol	97	05/98 → 09/00 ENGINE: EW10J4

EXPERT (224)

2.0	Petrol	100	12/03 → ENGINE: EW10J4
-----	--------	-----	------------------------

EXPERT Furgonato (222)

2.0	Petrol	100	12/03 → ENGINE: EW10J4
-----	--------	-----	------------------------

B3354

B1 ATTUATORE CONTROLLO MINIMO
IDLE SPEED CONTROL ACTUATOR



RENAULT

19 II (B/C53_)

1.4 (B/C535) Petrol 55 01/92 → 12/95

19 II Chamade (L53_)

1.4 (L535) Petrol 55 11/93 → 12/95

CLIO I (B/C57_, 5/357_)

1.4 (B/C57T, B/C57Y) Petrol 58 01/91 → 09/98

MEGANE I (BA0/1_)

1.4e(BA0E, BA0V) Petrol 55 01/96 → 08/03

MEGANE I Grandtour (KA0/1_)

1.4 e (KA0V) Petrol 55 03/99 → 08/03

RAPID Furgonato (F40_, G40_)

1.4 (F40D) Petrol 58 01/94 → 03/98

1.4 (F40U, F40V) Petrol 55 09/91 → 03/98

B3355

B1 ATTUATORE CONTROLLO MINIMO
IDLE SPEED CONTROL ACTUATOR



RENAULT

CLIO II (BB0/1/2_, CB0/1/2_)

1.6 (B/CB0D) Petrol 66 09/98 → 05/05

MEGANE I (BA0/1_)

1.6e(BA0F, BA0S) Petrol 66 01/96 → 03/99

B3355



RENAULT

MEGANE I Coach (DA0/1_)

1.6 e (DA0F) Petrol 66 03/96 → 03/99

MEGANE I Grandtour (KA0/1_)

1.6 e (KA0F) Petrol 66 03/99 → 08/03

B3368

B1 ATTUATORE CONTROLLO MINIMO
IDLE SPEED CONTROL ACTUATOR



DAEWOO

MATIZ (KLYA)

0.8 Petrol 38 09/98 →

B3385

B1 ATTUATORE CONTROLLO MINIMO
IDLE SPEED CONTROL ACTUATOR



PEUGEOT

306 Cabriolet (7D, N3, N5)

2.0 16V Petrol 97 03/97 → 04/02

405 II (4B)

1.8 Petrol 74 08/92 → 10/95

405 II Break (4E)

1.8 Petrol 74 08/92 → 10/96

B3385

PEUGEOT
406 (8B)

2.0 16V Petrol 97 11/95 → 05/04

406 Coupé (8C)

2.0 16V Petrol 97 03/97 → 12/04

605 (6B)

2.0 16V Petrol 97 07/94 → 09/99

806 (221)

2.0 16V Petrol 97 05/98 → 09/00

BOXER Autobus (230P)

2.0 i Petrol 80 03/94 → 04/02

B3387
**B1 ATTUATORE CONTROLLO MINIMO
IDLE SPEED CONTROL ACTUATOR**

PEUGEOT
306 (7B, N3, N5)

1.4 SL	Petrol	55	06/94 → 05/01	ENGINE: KDX(TU3MC) KFX(TU3JP) KFW(TU3JP)
--------	--------	----	---------------	---

306 Break (7E, N3, N5)

1.4	Petrol	55	03/97 → 04/02	ENGINE: KFX(TU3JP) KFW(TU3JP)
-----	--------	----	---------------	----------------------------------

RANCH MPV / Space wagon (5F)

1.4	Petrol	55	06/96 →	ENGINE: KFX(TU3JP) KFW(TU3JP)
-----	--------	----	---------	----------------------------------

B3388
**B1 ATTUATORE CONTROLLO MINIMO
IDLE SPEED CONTROL ACTUATOR**

PEUGEOT
306 (7B, N3, N5)

1.6	Petrol	72	10/00 → 05/01	ENGINE: NFT
-----	--------	----	---------------	-------------

306 Break (7E, N3, N5)

1.6	Petrol	72	10/00 → 04/02	ENGINE: NFT
-----	--------	----	---------------	-------------

PEUGEOT
306 Cabriolet (7D, N3, N5)

1.6	Petrol	72	10/00 → 04/02	ENGINE: NFT
-----	--------	----	---------------	-------------

B3389
**B1 ATTUATORE CONTROLLO MINIMO
IDLE SPEED CONTROL ACTUATOR**

PEUGEOT
406 (8B)

1.8 16V	Petrol	85	10/00 → 05/04	ENGINE: 6FZ(EW7J4)
---------	--------	----	---------------	--------------------

406 Break (8E/F)

1.8 16V	Petrol	85	10/00 → 10/04	ENGINE: 6FZ(EW7J4)
---------	--------	----	---------------	--------------------

B3390

B1 ATTUATORE CONTROLLO MINIMO
IDLE SPEED CONTROL ACTUATOR

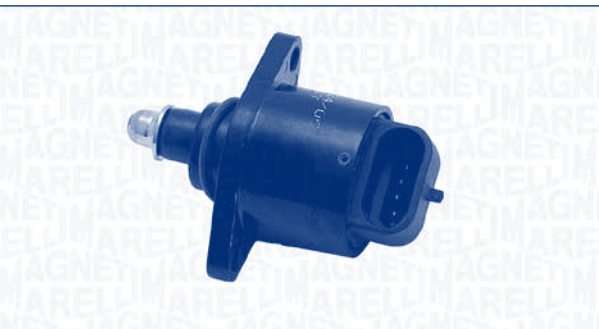

RENAULT

MEGANE I (BA0/1_)

1.8 16V (BA06, BA12, BA1A, BA1M, BA1R)	Petrol	85	01/01 → 08/03
--	--------	----	---------------

MEGANE I Classic (LA0/1_)

1.8 16V (LA06, LA12, LA1A, LA1M, LA1R)	Petrol	85	01/01 → 08/03
--	--------	----	---------------

MEGANE I Grandtour (KA0/1_)

1.8 16V (KA0S, KA12, KA1A, KA1M, KA1R)	Petrol	85	01/01 → 08/03
--	--------	----	---------------

SCÉNIC I (JA0/1_)

1.8 16V (JA12, JA1R, JA1M, JA1A)	Petrol	85	01/01 → 08/03
----------------------------------	--------	----	---------------

B3391

B1 ATTUATORE CONTROLLO MINIMO
IDLE SPEED CONTROL ACTUATOR



AUDI

100 (4A, C4)

2.6	Petrol	110	03/92 → 06/94	CHASSIS: 4AM000001 →
-----	--------	-----	---------------	-------------------------

B3391



AUDI

100 (4A, C4)

2.6 quattro	Petrol	110	04/92 → 06/94	CHASSIS: 4AM000001 →
-------------	--------	-----	---------------	-------------------------

100 Avant (4A, C4)

2.6	Petrol	110	03/92 → 06/94	CHASSIS: 4AM000001 →
-----	--------	-----	---------------	-------------------------

2.6 quattro	Petrol	110	07/92 → 06/94	CHASSIS: 4AM000001 →
-------------	--------	-----	---------------	-------------------------

80 (8C, B4)

2.6	Petrol	110	07/92 → 12/94	CHASSIS: 8CN000001 →, → 8CS025820
-----	--------	-----	---------------	---

2.6 quattro	Petrol	110	06/92 → 12/94	CHASSIS: 8CN000001 →, → 8CS025820
-------------	--------	-----	---------------	---

80 Avant (8C, B4)

2.6	Petrol	110	07/92 → 01/96	CHASSIS: 8CN000001 →, → 8CS025820
-----	--------	-----	---------------	---

2.6 quattro	Petrol	110	07/92 → 07/95	CHASSIS: 8CN000001 →, → 8CS025820
-------------	--------	-----	---------------	---

A4 (8D2, B5)

2.6	Petrol	110	01/95 → 12/97
-----	--------	-----	---------------

2.6 quattro	Petrol	110	01/95 → 12/97
-------------	--------	-----	---------------

A4 Avant (8D5, B5)

2.6	Petrol	110	02/96 → 12/97
-----	--------	-----	---------------

2.6 quattro	Petrol	110	01/96 → 12/97
-------------	--------	-----	---------------

A6 (4A, C4)

2.6	Petrol	110	06/94 → 10/97	CHASSIS: → 4AS026714
-----	--------	-----	---------------	-------------------------

2.6 quattro	Petrol	110	06/94 → 10/97	CHASSIS: → 4AS026714
-------------	--------	-----	---------------	-------------------------

A6 Avant (4A, C4)

2.6	Petrol	110	06/94 → 12/97	CHASSIS: → 4AS026714
-----	--------	-----	---------------	-------------------------

CABRIOLET (8G7, B4)

2.6	Petrol	110	06/93 → 08/00	CHASSIS: → 8GS001302
-----	--------	-----	---------------	-------------------------

COUPE (89, 8B)

2.6	Petrol	110	08/92 → 12/96
-----	--------	-----	---------------

2.6 quattro	Petrol	110	08/92 → 12/96	CHASSIS: → 8BS000544
-------------	--------	-----	---------------	-------------------------

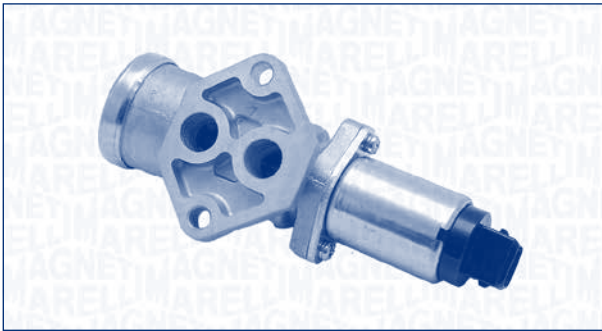
B3392
B1 ATTUATORE CONTROLLO MINIMO
IDLE SPEED CONTROL ACTUATOR

FIAT
BARCETTA (183)

1.8 16V Petrol 96 04/95 → 05/98

BRAVA (182)

1.8 GT 16V (182.BC) Petrol 83 10/96 → 07/99

BRAVO I (182)

1.8 GT (182.AC) Petrol 83 10/96 → 07/99

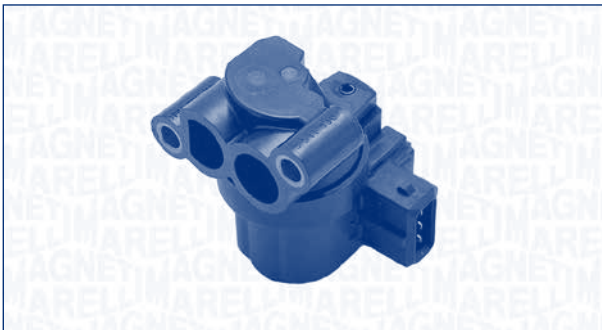
B3393
B1 ATTUATORE CONTROLLO MINIMO
IDLE SPEED CONTROL ACTUATOR

ALFA ROMEO
145 (930)

2.0 16V T.S. Petrol 110 10/95 → 01/01

146 (930)

2.0 16V T.S. Petrol 110 10/95 → 01/01

155 (167)

2.0 T.S. 16V (167.A2G) Petrol 110 03/95 → 12/97

156 (932)

1.6 16V T.SPARK (932A4) Petrol 88 09/97 → 09/05

B3393

ALFA ROMEO
156 Sportwagon (932)

1.6 16V T.SPARK (932A4) Petrol 88 05/00 → 05/06

GTV (916C_)

2.0 T.SPARK 16V (916.C2_., 916C2C00) Petrol 110 06/95 → 10/05

2.0 T.SPARK 16V (916C2C) Petrol 114 05/98 → 08/00

SPIDER (916S_)

2.0 T.SPARK 16V (916S2B) Petrol 114 05/98 → 08/00

2.0 T.SPARK 16V (916S2C00) Petrol 110 06/95 → 04/05

FIAT
BRAVO I (182)

2.0 HGT 20V (182.AD) Petrol 108 10/95 → 07/98

LANCIA
KAPPA (838A)

2.0 20V (838AA1AA) Petrol 107 10/94 → 10/01

2.0 20V Turbo (838AM1AA) Petrol 162 06/98 → 10/01

2.4 20V (838AC1AA, 838AC11A) Petrol 129 08/94 → 10/01

KAPPA Coupé (838)

2.0 20V Petrol 114 07/96 → 03/01

2.0 20V Turbo (838CM) Petrol 162 06/98 → 03/01

KAPPA SW (838B)

2.0 20V Turbo (838BM1AA) Petrol 162 06/98 → 10/01

B3394

B1 ATTUATORE CONTROLLO MINIMO
IDLE SPEED CONTROL ACTUATOR



KW



HYUNDAI

ACCENT I (X-3)

1.5 i 16V Petrol 73 12/95 → 01/00

ACCENT Tre volumi (X-3)

1.5 i 16V Petrol 73 10/95 → 01/00

COUPE (GK)

1.6 16V Petrol 77 03/02 → 08/09

1.6 16V Petrol 79 03/02 → 08/09

H-1 / STAREX

2.5 TD 4WD Diesel 73 03/01 → 04/04

2.5 TD 4WD Diesel 74 11/01 → 04/04

MATRIX (FC)

1.6 Petrol 76 06/01 → 08/10

TRAJET (FO)

2.0 Petrol 100 03/00 → 07/08

TUCSON (JM)

2.0 Petrol 104 08/04 → 03/10

XG (XG)

30 Petrol 138 12/98 → 12/05

250 Petrol 120 12/98 → 12/05

B3395

B1 ATTUATORE CONTROLLO MINIMO
IDLE SPEED CONTROL ACTUATOR



KW



RENAULT

CLIO II (BB0/1/2_, CB0/1/2_)

1.4 (B/CB0C) Petrol 55 09/98 → 05/05

KANGOO (KC0/1_)

1.4 (KC0C, KC0H, KC0B, KC0M) Petrol 55 08/97 →

KANGOO Express (FC0/1_)

1.4 (FC0C, FC0B, FC0H, FC0M) Petrol 55 08/97 →

B3396

B1 ATTUATORE CONTROLLO MINIMO
IDLE SPEED CONTROL ACTUATOR



KW



CHEVROLET

AVEO Tre volumi (T250, T255)

1.2 Petrol 53 03/06 → 12/07

1.4 Petrol 69 03/06 → 12/07

DAEWOO

KALOS (KLAS)

1.2 Petrol 53 04/03 →

1.4 16V Petrol 69 04/03 →

B3396

DAEWOO
LANOS (KLAT)

1.4	Petrol	55	05/97 →
1.5	Petrol	63	05/97 →
1.6 16V	Petrol	78	05/97 →

LANOS Tre volumi (KLAT)

1.4	Petrol	55	05/97 →
1.5	Petrol	63	05/97 →
1.6 16V	Petrol	78	05/97 →

NUBIRA (KLAJ)

1.6 16V	Petrol	78	05/97 →
2.0 16V	Petrol	98	05/97 →

NUBIRA Tre volumi (KLAJ)

1.6 16V	Petrol	78	05/97 →
2.0 16V	Petrol	98	05/97 →

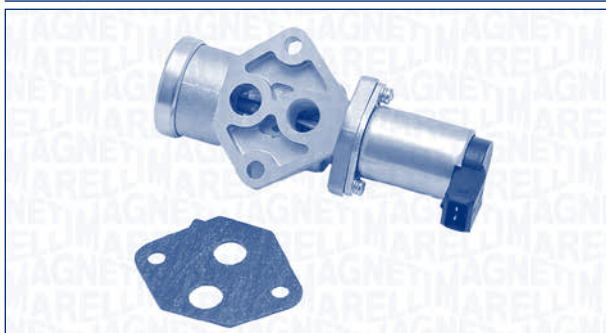
B3397
**B1 ATTUATORE CONTROLLO MINIMO
IDLE SPEED CONTROL ACTUATOR**

OPEL
ASTRA F (56_, 57_)

1.8 i 16V	Petrol	85	11/94 → 09/98
1.8 i 16V	Petrol	92	06/93 → 10/94
2.0 i 16V	Petrol	100	02/95 → 09/98

ASTRA F 2 volumi /Coda spiovente (53_, 54_, 58_, 59_)

1.8 i 16V	Petrol	85	09/94 → 01/98
1.8 i 16V	Petrol	92	06/93 → 08/94
2.0 i 16V	Petrol	100	02/95 → 01/98

ASTRA F Cabriolet (53_B)

1.8 i 16V	Petrol	85	11/94 → 03/01
-----------	--------	----	---------------

ASTRA F Station wagon (51_, 52_)

1.8 i 16V	Petrol	85	07/94 → 01/98
1.8 i 16V	Petrol	92	06/93 → 01/98
2.0 i 16V	Petrol	100	02/95 → 01/98

B3397

OPEL
ASTRA G 2 volumi /Coda spiovente (F48_, F08_)

2.0 16V	Petrol	100	02/98 → 01/05
2.0 16V OPC	Petrol	118	11/99 → 09/02

ASTRA G Station wagon (F35_)

2.0 16V	Petrol	100	02/98 → 07/04
---------	--------	-----	---------------

ASTRA G Tre volumi (F69_)

2.0 16V	Petrol	100	09/98 → 01/05
---------	--------	-----	---------------

CALIBRA A (85_)

2.0 i 16V	Petrol	100	09/96 → 07/97
2.0 i 16V 4x4	Petrol	100	09/96 → 07/97

OMEGA B (25_, 26_, 27_)

2.0 16V	Petrol	100	03/94 → 09/99
---------	--------	-----	---------------

OMEGA B Station wagon (21_, 22_, 23_)

2.0 16V	Petrol	100	03/94 → 09/99
---------	--------	-----	---------------

VECTRA A (86_, 87_)

2.0 i 16V	Petrol	100	06/94 → 11/95
2.0 i 16V 4x4	Petrol	100	06/94 → 11/95

VECTRA A 2 volumi /Coda spiovente (88_, 89_)

2.0 i 16V	Petrol	100	06/94 → 11/95
-----------	--------	-----	---------------

VECTRA B (36_)

1.8 i 16V	Petrol	85	10/95 → 09/00
2.0 i 16V	Petrol	100	10/95 → 09/00
2.2 i 16V	Petrol	108	09/00 → 04/02

VECTRA B 2 volumi /Coda spiovente (38_)

1.8 i 16V	Petrol	85	10/95 → 09/00
2.0 i 16V	Petrol	100	10/95 → 09/00

VAUXHALL
ASTRA Mk III (F)

1.8 i 16V	Petrol	85	01/94 → 12/96
1.8 i 16V	Petrol	92	06/93 → 10/94
2.0 i 16V	Petrol	100	02/95 → 09/98

ASTRA Mk III (F) 2 volumi /Coda spiovente

1.8 i 16V	Petrol	85	09/94 → 02/98
1.8 i 16V	Petrol	92	09/94 → 02/98
2.0 i 16V	Petrol	100	01/94 → 02/98

ASTRA Mk III (F) Cabriolet

1.8	Petrol	92	09/94 → 08/96
1.8 16V	Petrol	85	11/94 → 03/01

ASTRA Mk III (F) Station wagon

1.8 i 16V	Petrol	85	09/94 → 02/98
1.8 i 16V	Petrol	92	09/94 → 02/98
2.0 i 16V	Petrol	100	01/94 → 02/98

ASTRA Mk IV (G) 2 volumi /Coda spiovente

2.0	Petrol	118	10/99 → 08/00
2.0 16V	Petrol	100	02/98 → 05/05

B3397



VAUXHALL

ASTRA Mk IV (G) Station wagon

2.0 16V Petrol 100 02/98 → 05/05

ASTRA Mk IV (G) Tre volumi

2.0 16V Petrol 100 09/98 → 05/05

VECTRA (B)

1.8 i 16V Petrol 85 10/95 → 09/00

2.0 i 16V Petrol 100 10/95 → 01/01

2.2 i 16V Petrol 108 08/95 → 10/01

VECTRA (B) 2 volumi /Coda spiovente

1.8 i 16V Petrol 85 10/95 → 09/00

2.0 i 16V Petrol 100 10/95 → 01/01

VECTRA (B) Station wagon

1.8 i 16V Petrol 85 11/96 → 09/00

2.0 i 16V Petrol 100 10/95 → 01/01

B3398

**B1 ATTUATORE CONTROLLO MINIMO
IDLE SPEED CONTROL ACTUATOR**

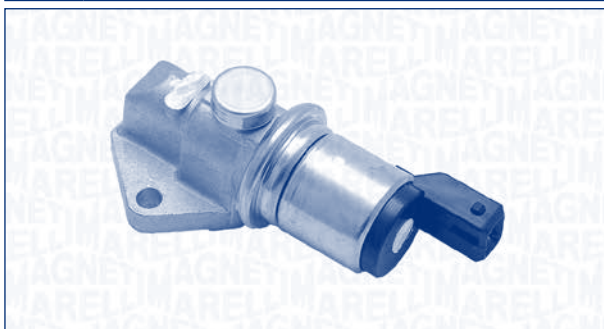

FORD

COURIER Furgonato (J5_, J3_)

1.3 Petrol 44 02/96 → 08/98

ESCORT CLASSIC (AAL, ABL)

1.6 16V Petrol 66 10/98 → 07/00

ESCORT CLASSIC Turnier (ANL)

1.6 16V Petrol 66 02/99 → 07/00

ESCORT VII (GAL, AAL, ABL)

1.3 Petrol 44 01/95 → 08/98

1.6 16V 4x4 Petrol 66 01/95 → 10/98

1.6 16V Petrol 66 01/95 → 10/98

1.6 i 16V Petrol 65 01/95 → 08/95

1.8 16V Petrol 85 01/95 → 10/98

ESCORT VII Cabriolet (ALL)

1.6 16V XR3i Petrol 65 02/95 → 12/96

1.6 16V XR3i Petrol 66 02/95 → 09/99

B3398



FORD

ESCORT VII Cabriolet (ALL)

1.8 16V XR3i Petrol 85 10/95 → 08/98

ESCORT VII Station wagon (GAL, ANL)

1.3 Petrol 44 10/95 → 08/98

1.6 16V Petrol 66 01/95 → 02/99

1.6 i 16V Petrol 65 01/95 → 08/95

1.8 16V Petrol 85 09/95 → 02/99

ESCORT VII Tre volumi (GAL, AFL)

1.3 Petrol 44 10/95 → 08/98

1.6 i 16V Petrol 65 01/95 → 08/95

1.6 i 16V Petrol 66 01/95 → 02/99

1.8 16V Petrol 85 09/95 → 02/99

FIESTA III (GFJ)

1.8 16V Petrol 77 09/95 → 12/95

1.8 XR2i 16V Petrol 96 08/95 → 12/95

FIESTA IV (JA_, JB_)

1.0 i Petrol 38 02/97 → 08/98

1.3 i Petrol 37 08/95 → 08/98

1.3 i Petrol 44 08/95 → 08/98

KA (RB_)

1.0 i Petrol 38 07/97 → 08/98

1.3 i Petrol 36 06/98 → 08/98

SCORPIO II (GFR, GGR)

2.0 i 16V Petrol 100 10/94 → 04/96

SCORPIO II Station wagon (GNR, GGR)

2.0 i 16V Petrol 100 10/94 → 04/96

B35/00

**B1 ATTUATORE CONTROLLO MINIMO
IDLE SPEED CONTROL ACTUATOR**



CITROËN

C2 (JM_)

1.1 Petrol 44 09/03 → ENGINE: TU1JP

B35/00

CITROËN
C3 I (FC_)

1.1 i Petrol 44 02/02 → ENGINE: TU1JP

SAXO (S0, S1)

1.1 X,SX Petrol 44 05/96 → 12/99 ENGINE: TU1JP

XSARA (N1)

1.4 i Petrol 55 04/97 → 09/00 ENGINE: TU3JP

XSARA Break (N2)

1.4 i Petrol 55 10/97 → 09/00 ENGINE: TU3JP

PEUGEOT
106 I (1A, 1C)

1.1 Petrol 44 09/91 → 04/96 ENGINE: TU1JP

206 SW (2E/K)

1.1 Petrol 44 07/02 → ENGINE: TU1JP

307 (3A/C)

1.4 Petrol 55 05/05 → ENGINE: TU3JP

RANCH MPV / Space wagon (5F)

1.1 Petrol 44 01/02 → ENGINE: TU1JP

B36
**B1 ATTUATORE CONTROLLO MINIMO
IDLE SPEED CONTROL ACTUATOR**

PEUGEOT
206 2 volumi /Coda spiovente (2A/C)

1.4 i Petrol 55 09/98 → ENGINE: TU3JP

206 SW (2E/K)

1.4 Petrol 55 07/02 → ENGINE: TU3JP

KBLCF01
**B2 CABLAGGIO PER 54DTS3
CABLE FOR THROTTLE BODY 54DTS3**

FIAT
DUCATO Autobus (250)

120 Multijet 2,3 D Diesel 88 07/06 → ENGINE: F1AE0481D

DUCATO Furgonato (250)

120 Multijet 2,3 D Diesel 88 07/06 → ENGINE: F1AE0481D

130 Multijet 2,3 D Diesel 96 01/07 → ENGINE: F1AE3481D, F1AE0481N

DUCATO Pianale piatto/Telaio (250)

120 Multijet 2,3 D Diesel 88 07/06 → ENGINE: F1AE0481D

130 Multijet 2,3 D Diesel 96 01/07 → ENGINE: F1AE3481D, F1AE0481N

IVECO
DAILY IV Autobus

35S14 G Petrol/CNG 100 07/09 → ENGINE: F1CE0441A

35S14, 35S14 /P Diesel 100 05/06 → ENGINE: F1AE0481HA

DAILY IV Cassone / Furgonato / Promiscuo

29L10 V Diesel 70 05/06 → ENGINE: F1AE0481FA

29L12 V, 29L12 V/P Diesel 85 05/06 → ENGINE: F1AE0481GA

29L14 C, 29L14 C/P, 29L14 V, 29L14 V/P Diesel 100 05/06 → ENGINE: F1AE0481HA

35C10, 35S10 Diesel 70 05/06 → ENGINE: F1AE0481FA

35C11 V, 35S11 V Diesel 78 07/07 → ENGINE: F1AE0481FA

35C12 V, 35C12 V/P, 35S12 V, 35S12 V/P Diesel 85 05/06 → ENGINE: F1AE0481GA

35C13 V, 35C13 V/P, 35S13 V, 035S13 V/P Diesel 93 07/07 → ENGINE: F1AE0481GA

KBLCF01



IVECO

DAILY IV Cassone / Furgonato / Promiscuo

35S14 C, 35S14 C/P, 35S14 V, 35S14 V/P, 35C14 V, 35C14 V/P	Diesel	100	05/06 →	ENGINE: F1AE0481HA
40C10 V	Diesel	70	05/06 →	ENGINE: F1AE0481FA
40C11 V	Diesel	78	07/07 →	ENGINE: F1AE0481FA
40C12 V, 40C14 V/P	Diesel	85	05/06 →	ENGINE: F1AE0481GA
40C13 V, 40C13 V/P	Diesel	93	07/07 →	ENGINE: F1AE0481GA

DAILY IV Pianale piatto/Telaio

29L10	Diesel	70	05/06 →	ENGINE: F1AE0481FA
29L12	Diesel	85	05/06 →	ENGINE: F1AE0481GA
29L14	Diesel	100	05/06 →	ENGINE: F1AE0481HA
35C10, 35S10	Diesel	70	05/06 →	ENGINE: F1AE0481FA
35C11, 35S11, 35S11 D, 35S11 /P	Diesel	78	07/07 →	ENGINE: F1AE0481FA
35C12, 35S12	Diesel	85	05/06 →	ENGINE: F1AE0481GA
35C13, 35C13 /P, 35S13 D, 35S13, 35S13 /P	Diesel	93	07/07 →	ENGINE: F1AE0481GA
35C14, 35S14, 35S14 /P	Diesel	100	05/06 →	ENGINE: F1AE0481HA
40C10	Diesel	70	05/06 →	ENGINE: F1AE0481FA
40C11, 40C11 D	Diesel	78	07/07 →	ENGINE: F1AE0481FA
40C12	Diesel	85	05/06 →	ENGINE: F1AE0481GA
40C13, 40C13 /P	Diesel	93	07/07 →	ENGINE: F1AE0481GA

DAILY IV Ribaltabile

35C10 K	Diesel	70	05/06 →	ENGINE: F1AE0481FA
35C11 K, 35C11 DK, 35S11 K, 35S11 DK	Diesel	78	07/07 →	ENGINE: F1AE0481FA
35C12	Diesel	85	05/06 →	ENGINE: F1AE0481GA
35S14 K, 35S14 DK	Diesel	100	07/07 →	ENGINE: F1AE0481HA

CAD191

**B2 COLLETTORE CONTROLLO MOTORE
ENGINE COLLECTOR BODY**



ALFA ROMEO

159 (939)

1.9 JTDM 16V	Diesel	100	09/05 → 11/11	ENGINE: 937A8000, 939A8000
1.9 JTDM 16V	Diesel	110	09/05 → 11/11	ENGINE: 939A2000

159 Sportwagon (939)

1.9 JTDM 16V	Diesel	100	03/06 → 11/11	ENGINE: 937A8000
1.9 JTDM 16V	Diesel	110	03/06 → 11/11	ENGINE: 939A2000

FIAT

CROMA (194)

1.9 D Multijet	Diesel	100	12/05 →	ENGINE: 939A8000
1.9 D Multijet	Diesel	110	06/05 →	ENGINE: 939A2000

STILO (192)

1.9 D Multijet	Diesel	110	09/05 → 11/06	ENGINE: 937A5000
----------------	--------	-----	---------------	------------------

STILO Multi Wagon (192)

1.9 D Multijet	Diesel	110	09/05 → 08/08	ENGINE: 937A5000
----------------	--------	-----	---------------	------------------

OPEL

ASTRA H (L48)

1.9 CDTI	Diesel	110	09/04 →	ENGINE: Z19DTH
----------	--------	-----	---------	----------------

ASTRA H Station wagon (L35)

1.9 CDTI	Diesel	110	09/04 →	ENGINE: Z19DTH
----------	--------	-----	---------	----------------

ASTRA H TwinTop (L67)

1.9 CDTI	Diesel	110	09/05 →	ENGINE: Z19DTH
----------	--------	-----	---------	----------------

ASTRA H Van (L70)

1.9 CDTI	Diesel	110	09/04 →	ENGINE: Z19DTH
----------	--------	-----	---------	----------------

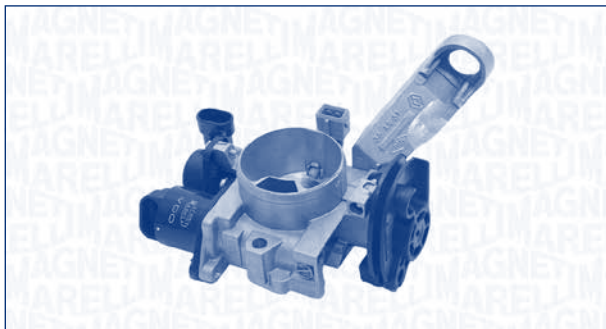
18385
B3 CORPO FARFALLATO
THROTTLE BODY

RENAULT
CLIO I (B/C/S57_, 5/357_)

1.2 (B/C/S572) Petrol 44 05/90 → 03/96 ENGINE: E5F710

1.2 (B/C57R) Petrol 40 01/91 → 06/96 ENGINE: E7F706

CLIO II (BB0/1/2_, CB0/1/2_)

1.2 (BB0A, BB0F, BB10, BB1K, BB28, BB2D, BB2H, CB0A...) Petrol 43 09/98 → ENGINE: D7F720, D7F726, D7F746, D7F766, D7F764

1.2 (BB0A, CB0A) Petrol 44 03/99 → 05/01 ENGINE: D7F722

CLIO II Furgonato (SB0/1/2_)

1.2 (SB0A, SB0F, SB10) Petrol 44 03/99 → 10/03 ENGINE: D7F722, D7F726, D7F746

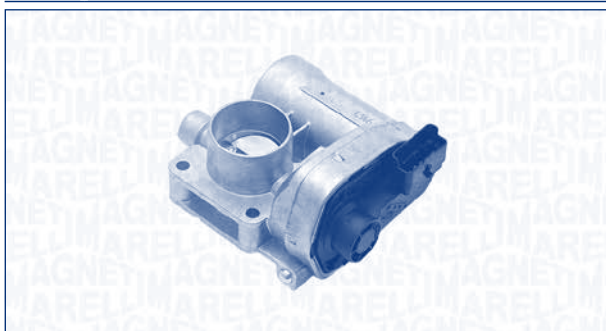
36SMF6
B3 CORPO FARFALLATO
THROTTLE BODY

FIAT
PANDA (169)

1.2 Petrol 44 09/03 →

1.2 4x4 Petrol 44 03/06 → 05/09

36SMF6

FIAT
PUNTO (188)

1.2 60 (188.030, .050, .130, .150, .230, .250) Petrol 44 06/03 →

PUNTO Van (188AX)

1.2 60 Petrol 44 06/03 → 10/09

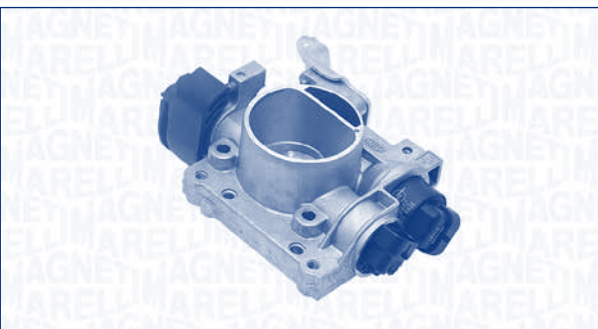
36SXF1/4
B3 CORPO FARFALLATO
THROTTLE BODY

FIAT
DOBLO (119)

1.2 (223AXA1A) Petrol 48 03/01 → ENGINE: 223A5000

DOBLO Cargo (223)

1.2 (223ZXA1A) Petrol 48 03/01 → ENGINE: 223A5000

PUNTO (188)

1.2 60 (188.030, .050, .130, .150, .230, .250) Petrol 44 09/99 → 09/05 ENGINE: 188A4000-230, .250)

PUNTO Van (188AX)

1.2 60 Petrol 44 02/00 → 10/09 ENGINE: 188A4000-

SEICENTO (187)

1.1 (187AXB, 187AXB1A) Petrol 40 01/01 → 01/10 ENGINE: 176B2000

SEICENTO Van (187)

1.1 (187CXB/C) Petrol 40 01/01 → 01/10 ENGINE: 176B2000

36SXF5/1

B3 CORPO FARFALLATO
THROTTLE BODY

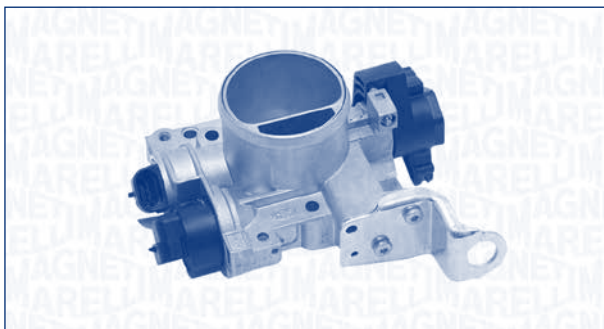

FIAT

PALIO (178BX)

1.2 Petrol 54 02/01 →

PALIO Weekend (178DX)

1.2 (178DYA1A) Petrol 44 02/01 →

SIENA (178_)

1.2 Petrol 54 02/01 →

STRADA Pick-up (178E)

1.2 Petrol 44 04/03 →

1.2 Petrol 54 02/01 →

36SXR31

B3 CORPO FARFALLATO
THROTTLE BODY

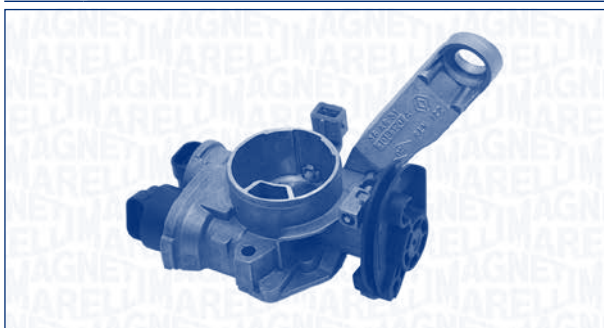

RENAULT

CLIO II (BB0/1/2_, CB0/1/2_)

1.2 (BB0A, BB0F, BB10, BB1K, BB28, BB2D, BB2H, CB0A...) Petrol 43 12/03 → 05/04 ENGINE: D7F720, D7F746, D7F726, D7F766, D7F764

CLIO III (BR0/1, CR0/1)

1.2 16V (BR0R, BR1D, BR1L, CR0R) Petrol 48 09/06 → 06/09 ENGINE: D4F740

36SXR31



RENAULT

KANGOO (KC0/1_)

1.2 (KC0A, KC0K, KC0F, KC01) Petrol 43 07/03 → 06/04 ENGINE: D7F710, D7F720, D7F722, D7F726, D7F744, D7F746

TWINGO I (C06_)

1.2 16V (C060) Petrol 44 12/05 → 05/07 ENGINE: D4F708

1.2 16V (C06C, C06D, C06K) Petrol 55 02/04 → ENGINE: D4F702

40CDSF1

B3 CORPO FARFALLATO
THROTTLE BODY



ALFA ROMEO

MITO (955)

1.3 JTDM Diesel 66 09/08 → ENGINE: 199A3000

FIAT

DOBLO Cassone / Furgonato / Promiscuo (263)

1.3 D Multijet Diesel 66 02/10 → ENGINE: 199A3000

DOBLO Combi (152, 263)

1.3 D Multijet Diesel 66 02/10 → ENGINE: 199A3000

DOBLO Pianale piatto/Telaio (263)

1.3 D Multijet Diesel 66 02/10 → ENGINE: 199A3000

PUNTO / GRANDE PUNTO (199)

1.3 D Multijet Diesel 66 10/05 → ENGINE: 199A3000

PUNTO EVO (199)

1.3 D Multijet Diesel 66 10/09 → 02/12 ENGINE: 199A3000

OPEL

ASTRA H (L48)

1.3 CDTI Diesel 66 08/05 → ENGINE: Z13DTH

ASTRA H GTC (L08)

1.3 CDTI Diesel 66 04/05 → ENGINE: Z13DTH

ASTRA H Station wagon (L35)

1.3 CDTI Diesel 66 08/05 → ENGINE: Z13DTH

40CDSF1

OPEL
ASTRA H Tre volumi (L69)

1.3 CDTI Diesel 66 02/07 → ENGINE: Z13DTH

ASTRA H Van (L70)

1.3 CDTI Diesel 66 08/05 → ENGINE: Z13DTH

VAUXHALL
ASTRA Mk V (H) 2 volumi /Coda spiovente

1.3 CDTI Diesel 66 01/04 → 05/09 ENGINE: Z13DTH

ASTRA Mk V (H) Sport Hatch

1.3 CDTI Diesel 66 04/05 → 11/10 ENGINE: Z13DTH

ASTRA Mk V (H) Station wagon

1.3 CDTI Diesel 66 08/04 → 03/09 ENGINE: Z13DTH

ASTRAVAN Mk V (H)

1.3 CDTI Diesel 66 08/05 → ENGINE: Z13DTH

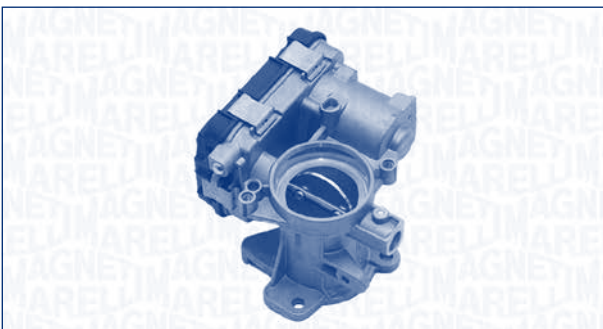
40DFP1
**B3 CORPO FARFALLATO
THROTTLE BODY**

FIAT
500 (312)

1.3 D Multijet Diesel 55 10/07 → ENGINE: 169A1000

DOBLO Cassone / Furgonato / Promiscuo (263)

1.3 D Multijet Diesel 66 02/10 → ENGINE: 263A2000

DOBLO Combi (152, 263)

1.3 D Multijet Diesel 66 02/10 → ENGINE: 263A2000

DOBLO Pianale piatto/Telaio (263)

1.3 D Multijet Diesel 66 02/10 → ENGINE: 263A2000

PANDA (312)

1.3 D Multijet Diesel 55 02/12 → ENGINE: 199A9000

PUNTO / GRANDE PUNTO (199)

1.3 D Multijet Diesel 56 06/09 → ENGINE: 199A2000

PUNTO EVO (199)

1.3 D Multijet Diesel 55 10/09 → 02/12 ENGINE: 199A2000, 199A9000

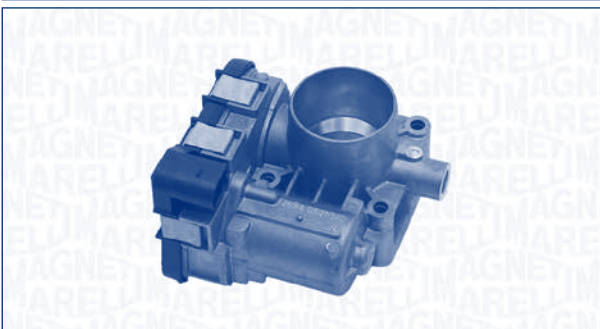
40GTE3F
**B3 CORPO FARFALLATO
THROTTLE BODY**

FIAT
500 (312)

1.2 Petrol 51 10/07 → ENGINE: 169A4000

1.2 LPG Petrol/LPG 51 12/10 → ENGINE: 169A4000

1.2 Petrol 51 09/09 → ENGINE: 169A4000

PANDA (312)

1.2 Petrol 51 02/12 → ENGINE: 169A4000

1.2 LPG Petrol/LPG 51 06/12 → ENGINE: 169A4000

PUNTO (199)

1.2 Petrol 51 03/12 → ENGINE: 169A4000

LANCIA
YPSILON (843)

1.2 Petrol 51 08/10 → 12/11 ENGINE: 169A4000

YPSILON (846)

1.2 Petrol 51 05/11 → ENGINE: 169A4000

1.2 Bifuel BiFuel 49 05/11 → ENGINE: 169A4000

40SMF10/1

B3 CORPO FARFALLATO
THROTTLE BODY

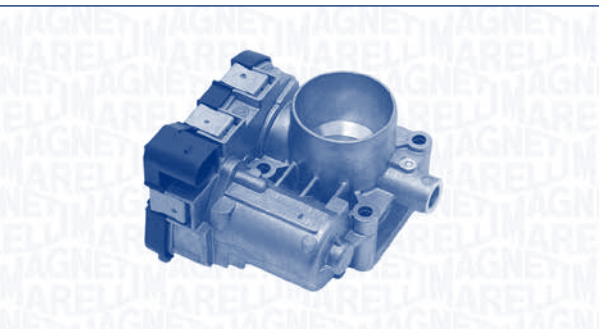

FIAT

500 (312)

1.2 Petrol 51 10/07 →

PANDA (169)

1.2 Petrol 51 03/10 → ENGINE: 169A4000

1.2 4x4 Petrol 51 11/09 → ENGINE: 169A4000

PANDA Van (169)

1.2 Petrol 51 09/10 → ENGINE: 169A4000

1.2 4x4 Petrol 51 09/10 → ENGINE: 169A4000

PUNTO / GRANDE PUNTO (199)

1.2 Petrol 48 10/05 →

PUNTO EVO (199)

1.2 Petrol 51 10/09 → 02/12 ENGINE: 169A4000

FORD

KA (RU8)

1.2 Petrol 51 10/08 → 09/13 ENGINE: FP4

40SXF1

B3 CORPO FARFALLATO
THROTTLE BODY

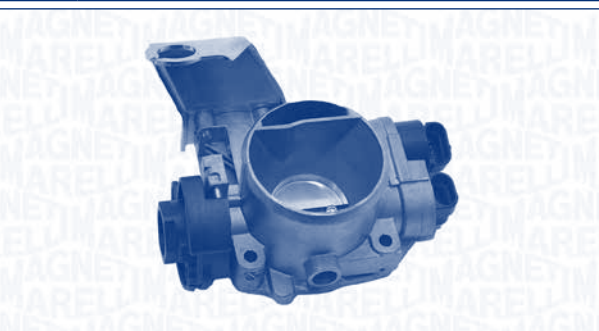

FIAT

PUNTO (176)

1.2 16V Petrol 63 04/97 → 09/99

40SXF1



FIAT

PUNTO Cabriolet (176C)

85 16V 1.2 Petrol 63 04/97 → 06/00

LANCIA

Y (840A)

1.2 16V (840AD) Petrol 63 04/97 → 09/03

42SXPP31

B3 CORPO FARFALLATO
THROTTLE BODY

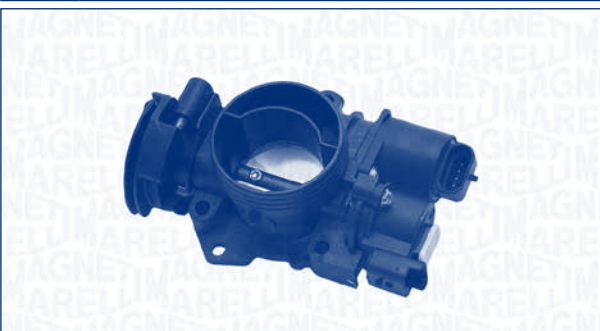

CITROËN

C2 (JM_)

1.1 Petrol 44 09/03 → 01/10 ENGINE: HFX(TU1JP)

C3 I (FC_)

1.1 i Petrol 44 02/02 → 05/05 ENGINE: HFX(TU1JP)

SAXO (S0, S1)

1.1 X,SX Petrol 44 07/00 → 09/03 ENGINE: HFX(TU1JP)

PEUGEOT

307 (3A/C)

1.4 Petrol 55 04/02 → 09/03 ENGINE: KFW(TU3JP)

307 Break (3E)

1.4 Petrol 55 04/02 → 09/03 ENGINE: TU3JP, KFW(TU3JP)

307 SW (3H)

1.4 Petrol 55 04/02 → 09/03 ENGINE: KFW(TU3JP)

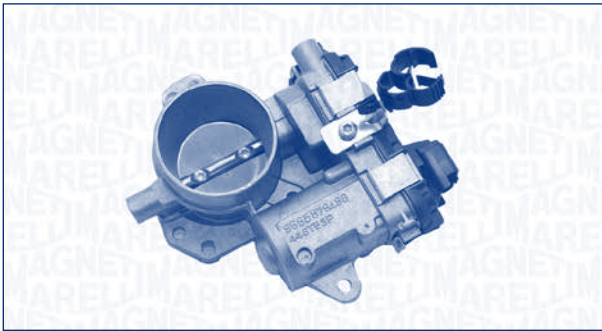
44GTE3P
B3 CORPO FARFALLATO
THROTTLE BODY

CITROËN
C3 II

1.4 VTi 95 Petrol 70 11/09 → ENGINE: KFTTU3AE5

PEUGEOT
207 (WA_, WC_)

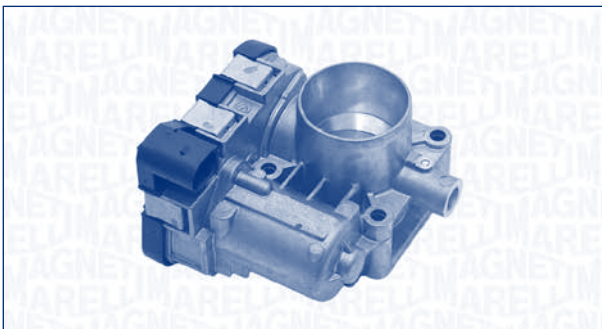
1.4 16V Petrol 70 06/07 → ENGINE: KFTTU3AE5

44SMF9/1
B3 CORPO FARFALLATO
THROTTLE BODY

FIAT
DOBLO (119)

1.4 Petrol 57 10/05 →

DOBLO Cargo (223)

1.4 Petrol 57 10/05 →

DOBLO Combi (152, 263)

1.4 Natural Power BiFuel 88 02/10 → ENGINE: 198A4000

IDEA

1.4 Petrol 57 10/05 →

1.4 LPG Petrol/LPG 57 03/09 → ENGINE: 350A1000

44SMF9/1

FIAT
LINEA (323)

1.4 Petrol 57 06/07 →

PALIO (178BX)

1.4 Petrol 51 04/96 →

1.4 Petrol 70 06/03 →

PANDA (169)

1.4 Bi-Power / Natural Power BiFuel 57 09/10 → ENGINE: 350A1000

PUNTO / GRANDE PUNTO (199)

1.4 Petrol 57 10/05 →

1.4 LPG Petrol/LPG 57 12/08 → ENGINE: 350A1000

PUNTO EVO (199)

1.4 LPG Petrol/LPG 57 06/09 → 02/12 ENGINE: 350A1000

SIENA (178_)

1.4 Petrol 51 04/96 →

LANCIA
MUSA (350)

1.4 Petrol 57 09/05 →

1.4 LPG Petrol/LPG 57 11/10 → ENGINE: 350A1000

YPSILON (843)

1.4 Petrol 57 02/06 → 12/11

1.4 LPG Petrol/LPG 57 11/10 → 12/11 ENGINE: 350A1000

46SXF11

B3 CORPO FARFALLATO
THROTTLE BODY



LANCIA

LYBRA (839AX)

1.6 16V (839AXA1A)	Petrol	76	01/01 → 10/05
-----------------------	--------	----	---------------

LYBRA SW (839BX)

1.6 16V (839BXA1A)	Petrol	76	01/01 → 10/05
-----------------------	--------	----	---------------

46SXF7

B3 CORPO FARFALLATO
THROTTLE BODY



FIAT

PALIO (178BX)

1.6 16V	Petrol	74	01/02 →
---------	--------	----	---------

PALIO Weekend (178DX)

1.6 16V (178DYC1A06)	Petrol	76	01/02 →
-------------------------	--------	----	---------

SIENA (178_)

1.6 16V	Petrol	78	01/02 →
---------	--------	----	---------

46SXF8

B3 CORPO FARFALLATO
THROTTLE BODY

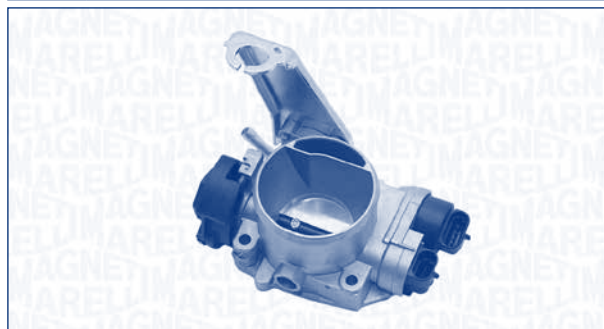

FIAT

BRAVA (182)

1.6 16V (182.BH)	Petrol	66	01/98 → 10/01
------------------	--------	----	---------------

BRAVO I (182)

1.6 16V (182.AH)	Petrol	66	01/98 → 10/01
------------------	--------	----	---------------

MULTIPLA (186)

1.6 100 16V (186AXA1A)	Petrol	76	04/99 → 06/10 ENGINE: 182A4000-
---------------------------	--------	----	---------------------------------

PALIO (178BX)

1.6 16V	Petrol	74	01/99 →
---------	--------	----	---------

PALIO Weekend (178DX)

1.6 16V (178DX.D1A)	Petrol	74	01/99 → 02/01
------------------------	--------	----	---------------

1.6 16V (178DYC1A06)	Petrol	76	02/01 →
-------------------------	--------	----	---------

LANCIA

DEDRA (835)

1.6 16V (835EI)	Petrol	76	01/96 → 07/99
-----------------	--------	----	---------------

DEDRA SW (835)

1.6 16V (835EI)	Petrol	76	01/96 → 07/99
-----------------	--------	----	---------------

LYBRA (839AX)

1.6 16V (839AXA1A)	Petrol	76	07/99 → 10/05
-----------------------	--------	----	---------------

LYBRA SW (839BX)

1.6 16V (839BXA1A)	Petrol	76	07/99 → 10/05
-----------------------	--------	----	---------------

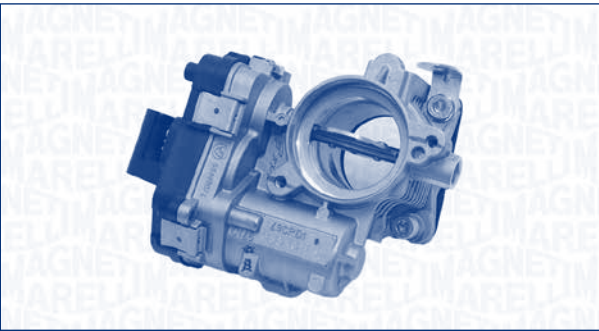
48CPD1
B3 CORPO FARFALLATO
THROTTLE BODY

ALFA ROMEO
159 (939)

1.9 JTDM 8V Diesel 85 09/05 → 11/11

FIAT
CROMA (194)

1.9 D Multijet Diesel 85 06/05 →

1.9 D Multijet Diesel 88 06/05 →

PUNTO / GRANDE PUNTO (199)

1.9 D Multijet Diesel 88 10/05 →

1.9 D Multijet Diesel 96 10/05 →

FIAT
SEDICI

1.9 D Multijet 4x4 Diesel 88 06/06 →

OPEL
ASTRA H (L48)

1.9 CDTI Diesel 74 09/05 → ENGINE: Z19DTL

1.9 CDTI Diesel 88 06/04 → ENGINE: Z19DT

SIGNUM

1.9 CDTI Diesel 74 08/05 → ENGINE: Z19DT

1.9 CDTI Diesel 88 04/04 → ENGINE: Z19DT

VECTRA C

1.9 CDTI Diesel 74 10/05 → ENGINE: Z19DT

1.9 CDTI Diesel 88 04/04 → ENGINE: Z19DT

VECTRA C GTS

1.9 CDTI Diesel 74 10/05 → ENGINE: Z19DT

1.9 CDTI Diesel 88 04/04 → ENGINE: Z19DT

VECTRA C Station wagon

1.9 CDTI Diesel 88 04/04 → ENGINE: Z19DT

ZAFIRA B (A05)

1.9 CDTI Diesel 74 07/05 → ENGINE: Z19DTL

1.9 CDTI Diesel 88 07/05 → ENGINE: Z19DT

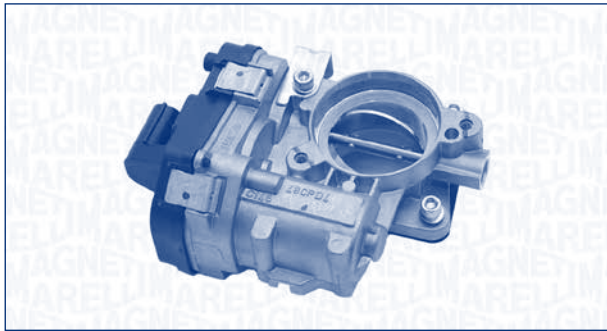
48CPD4
B3 CORPO FARFALLATO
THROTTLE BODY

ALFA ROMEO
159 (939)

1.9 JTDM 16V Diesel 110 09/05 → 11/11

159 Sportwagon (939)

1.9 JTDM 16V Diesel 110 03/06 → 11/11

FIAT
CROMA (194)

1.9 D Multijet Diesel 110 06/05 →

2.4 D Multijet Diesel 147 06/05 →

OPEL
ASTRA H (L48)

1.9 CDTI Diesel 110 09/04 →

SIGNUM

2.0 DTI Diesel 74 05/03 →

VECTRA C

1.9 CDTI Diesel 110 04/04 →

VECTRA C GTS

1.9 CDTI Diesel 110 04/04 →

SAAB
9-3 (YS3F)

1.9 TiD Diesel 110 09/04 →

9-5 (YS3E)

1.9 TiD Diesel 110 01/06 →

48CPD6

B3 CORPO FARFALLATO
THROTTLE BODY

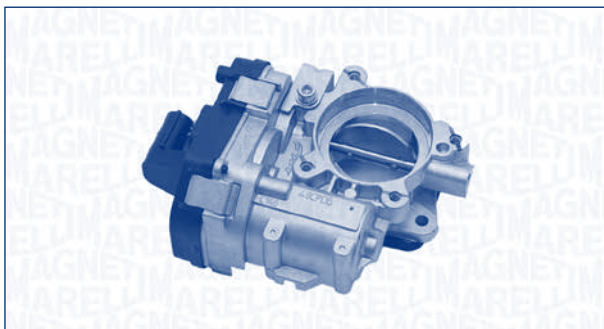

FIAT

BRAVO II (198)

1.9 D Multijet Diesel 110 04/07 →

48CPD6G

B3 CORPO FARFALLATO
THROTTLE BODY

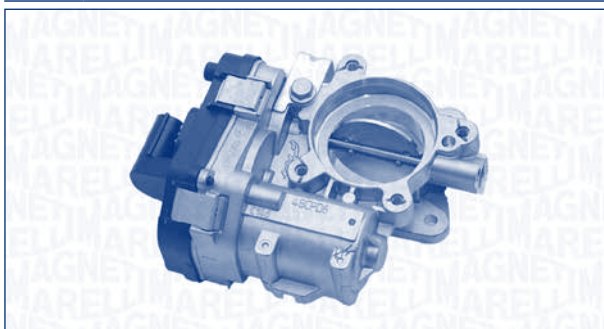

ALFA ROMEO

BRERA

2.0 JTDM Diesel 125 05/09 →

FIAT

BRAVO II (198)

1.6 D Multijet Diesel 77 03/08 →

1.6 D Multijet Diesel 88 03/08 →

2.0 D Multijet Diesel 121 09/08 →

LINEA (323)

1.6 D Multijet Diesel 77 06/09 →

PUNTO EVO (199)

1.6 D Multijet Diesel 88 10/09 → 02/12

LANCIA

DELTA III (844)

1.6 D Multijet Diesel 88 09/08 →

1.9 D Multijet Diesel 140 01/09 →

2.0 D Multijet Diesel 121 09/08 →

48CPD8

B3 CORPO FARFALLATO
THROTTLE BODY

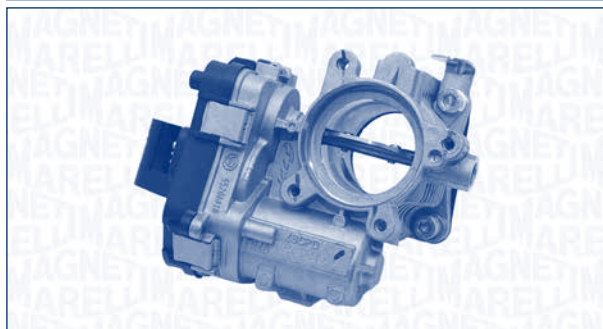

ALFA ROMEO

147 (937)

1.9 JTD (937AXD1A) Diesel 85 04/01 → 03/10

FIAT

DOBLO (119)

1.9 D Multijet Diesel 88 10/05 →

MULTIPLA (186)

1.9 JTD (186AXE1A) Diesel 88 04/02 → 06/10

1.9 JTD 115 Diesel 85 07/02 → 06/10

48CPD9

B3 CORPO FARFALLATO
THROTTLE BODY

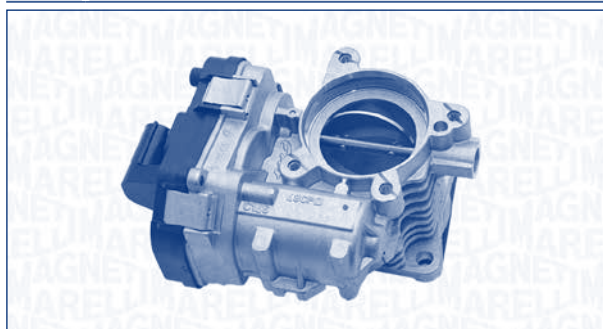

FIAT

BRAVO II (198)

1.9 D Multijet Diesel 88 04/07 → ENGINE: 192A8000

STILO (192)

1.9 JTD (192_XE1A) Diesel 85 10/01 → 11/06 ENGINE: 192A1000, 937A7000

1.9 JTD (192AXS1B, 192BXS1B) Diesel 66 09/04 → 11/06 ENGINE: 192B5000

48CPD9

FIAT
STILO Multi Wagon (192)

1.9 JTD	Diesel	85	01/03 → 08/08	ENGINE: 192A1000, 937A7000
---------	--------	----	---------------	-------------------------------

50CAD281
B3 **CORPO FARFALLATO
THROTTLE BODY**

CITROËN
C8 (EA_, EB_)

2.0 HDi	Diesel	88	11/07 →	ENGINE: RHK(DW10UTED4)
---------	--------	----	---------	---------------------------

JUMPY

2.0 HDi 120	Diesel	88	11/07 →	ENGINE: RHK(DW10UTED4)
-------------	--------	----	---------	---------------------------

JUMPY Furgonato

2.0 HDi 120	Diesel	88	11/07 →	ENGINE: RHK(DW10UTED4)
-------------	--------	----	---------	---------------------------

FIAT
SCUDO (270_)

2.0 D Multijet	Diesel	88	11/07 →	ENGINE: RHK
----------------	--------	----	---------	-------------

2.0 D Multijet 4x4	Diesel	88	11/07 →	ENGINE: RHK
--------------------	--------	----	---------	-------------

SCUDO Furgonato (270_)

2.0 D Multijet	Diesel	88	11/07 →	ENGINE: RHK
----------------	--------	----	---------	-------------

2.0 D Multijet 4x4	Diesel	88	11/07 →	ENGINE: RHK
--------------------	--------	----	---------	-------------

SCUDO Pianale piatto/Telaio (270_)

2.0 D Multijet	Diesel	88	11/07 →	ENGINE: RHK
----------------	--------	----	---------	-------------

ULYSSE (179AX)

2.0 D Multijet	Diesel	88	11/07 → 06/11	ENGINE: RHK
----------------	--------	----	---------------	-------------

LANCIA
PHEDRA (179)

2.0 JTD	Diesel	88	11/07 → 11/10	ENGINE: RHK, RHK(DW10UTED4)
---------	--------	----	---------------	--------------------------------

50CAD281

PEUGEOT
807 (E)

2.0 HDi	Diesel	88	11/07 →	ENGINE: RHK(DW10UTED4)
---------	--------	----	---------	---------------------------

EXPERT Furgonato (VF3A_, VF3U_, VF3X_)

2.0 HDi 120	Diesel	88	11/07 →	ENGINE: RHK(DW10UTED4)
-------------	--------	----	---------	---------------------------

EXPERT Pianale piatto/Telaio

2.0 HDi 120	Diesel	88	11/07 →	ENGINE: RHK(DW10UTED4)
-------------	--------	----	---------	---------------------------

EXPERT Tepee (VF3V_)

2.0 HDi 120	Diesel	88	11/07 →	ENGINE: RHK(DW10UTED4)
-------------	--------	----	---------	---------------------------

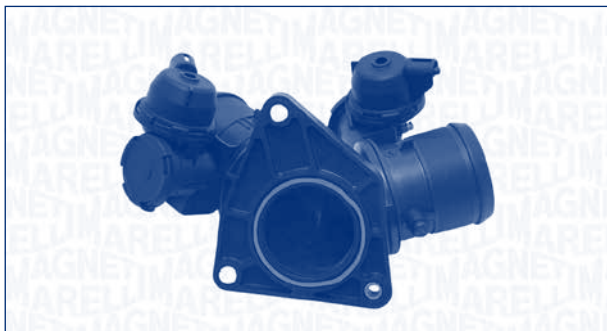
50CDDF4/1
B3 **CORPO FARFALLATO
THROTTLE BODY**

FORD
C-MAX (DM2)

2.0 TDCi	Diesel	100	03/07 → 07/10	ENGINE: G6DA, G6DB, G6DD, G6DG
----------	--------	-----	---------------	-----------------------------------

FOCUS C-MAX

2.0 TDCi	Diesel	100	10/03 → 03/07	ENGINE: G6DA
----------	--------	-----	---------------	--------------

FOCUS II (DA_)

2.0 TDCi	Diesel	100	11/04 → 01/08	ENGINE: G6DA
----------	--------	-----	---------------	--------------

FOCUS II Cabriolet

2.0 TDCi	Diesel	100	10/06 → 07/10	ENGINE: G6DA
----------	--------	-----	---------------	--------------

FOCUS II Station wagon (DA_)

2.0 TDCi	Diesel	100	11/04 → 01/08	ENGINE: G6DA
----------	--------	-----	---------------	--------------

FOCUS II Tre volumi (DA_)

2.0 TDCi	Diesel	100	12/07 → 07/11	ENGINE: G6DA, G6DB, G6DD
----------	--------	-----	---------------	-----------------------------

50CDDP1

B3 CORPO FARFALLATO
THROTTLE BODY

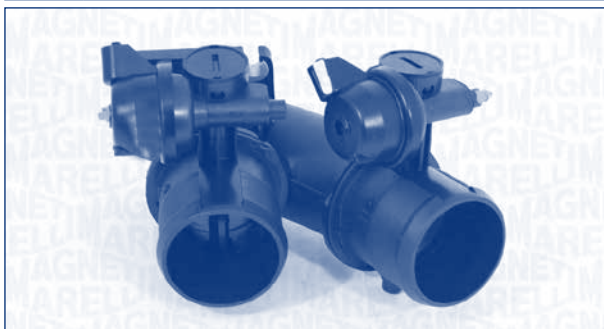

CITROËN

C8 (EA_, EB_)

2.2 HDi	Diesel	94	07/02 →	ENGINE: 4HW (DW12TED4)
---------	--------	----	---------	------------------------

PEUGEOT

607 (9D, 9U)

2.2 HDi	Diesel	98	02/00 →	ENGINE: 4HX (DW12TED4/FAP)
---------	--------	----	---------	----------------------------

50CDDP8

B3 CORPO FARFALLATO
THROTTLE BODY

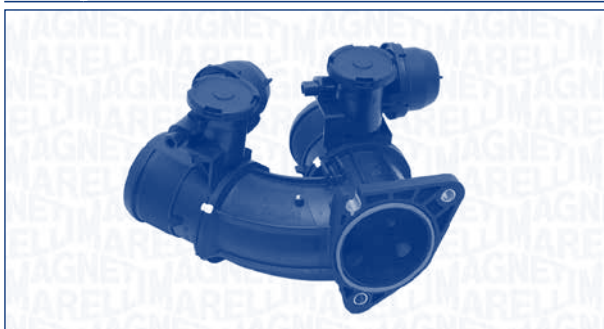

CITROËN

C4 Coupé (LA_)

2.0 HDi	Diesel	100	11/04 →	ENGINE: RHR (DW10BTED4)
---------	--------	-----	---------	-------------------------

C4 Grand Picasso I (UA_)

2.0 HDi 138	Diesel	100	10/06 →	ENGINE: RHR (DW10BTED4), RHJ (DW10BTED4)
-------------	--------	-----	---------	--

C4 I (LC_)

2.0 HDi	Diesel	100	11/04 →	ENGINE: RHR (DW10BTED4)
---------	--------	-----	---------	-------------------------

50CDDP8



CITROËN

C4 Picasso I (UD_)

2.0 HDi 138	Diesel	100	02/07 →	ENGINE: RHR (DW10BTED4), RHJ (DW10BTED4)
-------------	--------	-----	---------	--

C5 II (RC_)

2.0 HDi (RCRHRH)	Diesel	100	09/04 →	ENGINE: RHR (DW10BTED4)
------------------	--------	-----	---------	-------------------------

C5 II Break (RE_)

2.0 HDi (RERHRH)	Diesel	100	09/04 →	ENGINE: RHR (DW10BTED4)
------------------	--------	-----	---------	-------------------------

C5 III (RD_)

2.0 HDi	Diesel	100	02/08 →	ENGINE: RHR (DW10BTED4)
---------	--------	-----	---------	-------------------------

C5 III Break (TD_)

2.0 HDi	Diesel	100	02/08 →	ENGINE: RHR (DW10BTED4)
---------	--------	-----	---------	-------------------------

C8 (EA_, EB_)

2.0 HDi 135	Diesel	100	03/06 →	ENGINE: RHR (DW10BTED4)
-------------	--------	-----	---------	-------------------------

PEUGEOT

307 (3A/C)

2.0 HDi 135	Diesel	100	10/03 →	ENGINE: RHR (DW10BTED4)
-------------	--------	-----	---------	-------------------------

307 Break (3E)

2.0 HDi 135	Diesel	100	02/04 →	ENGINE: RHR (DW10BTED4)
-------------	--------	-----	---------	-------------------------

307 CC (3B)

2.0 HDi 135	Diesel	100	06/05 →	ENGINE: RHR (DW10BTED4)
-------------	--------	-----	---------	-------------------------

307 SW (3H)

2.0 HDi 135	Diesel	100	02/04 →	ENGINE: RHR (DW10BTED4)
-------------	--------	-----	---------	-------------------------

407 (6D_)

2.0 HDi	Diesel	103	08/08 →	ENGINE: RHR (DW10BTED4)
---------	--------	-----	---------	-------------------------

2.0 HDi 135	Diesel	100	05/04 →	ENGINE: RHR (DW10BTED4)
-------------	--------	-----	---------	-------------------------

407 Coupé (6C_)

2.0 HDi	Diesel	103	09/08 → 12/09	ENGINE: RHR (DW10BTED4)
---------	--------	-----	---------------	-------------------------

407 SW (6E_)

2.0 HDi	Diesel	103	08/08 →	ENGINE: RHR (DW10BTED4)
---------	--------	-----	---------	-------------------------

2.0 HDi 135	Diesel	100	05/04 →	ENGINE: RHR (DW10BTED4)
-------------	--------	-----	---------	-------------------------

50CDDP8

KW

PEUGEOT
607 (9D, 9U)

2.0 HDi	Diesel	100	09/05 →	ENGINE: RHR (DW10BTED4)
---------	--------	-----	---------	-------------------------

807 (E)

2.0 HDi	Diesel	100	06/06 →	ENGINE: RHR (DW10BTED4)
---------	--------	-----	---------	-------------------------

50CDDP9
B3 **CORPO FARFALLATO
THROTTLE BODY**

KW

CITROËN
C4 Coupé (LA_)

2.0 HDi	Diesel	100	11/04 →	ENGINE: DW10BTED4, RHR (DW10BTED4)
---------	--------	-----	---------	------------------------------------

C5 II (RC_)

2.0 HDi (RCRHRH)	Diesel	100	09/04 →	ENGINE: DW10BTED4, RHR (DW10BTED4)
------------------	--------	-----	---------	------------------------------------

PEUGEOT
407 Coupé (6C_)

2.0 HDi	Diesel	100	10/05 →	ENGINE: RHR (DW10BTED4)
---------	--------	-----	---------	-------------------------

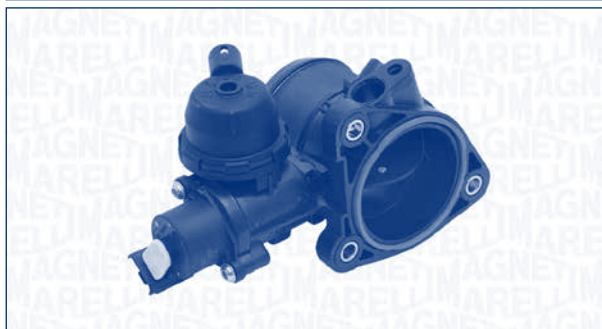
50CDSF5
B3 **CORPO FARFALLATO
THROTTLE BODY**

KW

FORD
C-MAX (DM2)

2.0 TDCi	Diesel	81	02/08 →	ENGINE: IXDA
----------	--------	----	---------	--------------

FOCUS II (DA_)

2.0 TDCi	Diesel	81	02/08 → 07/11	ENGINE: IXDA
----------	--------	----	---------------	--------------

FOCUS II Station wagon (DA_)

2.0 TDCi	Diesel	81	02/08 → 07/11	ENGINE: IXDA
----------	--------	----	---------------	--------------

FOCUS II Tre volumi (DA_)

2.0 TDCi	Diesel	81	02/08 → 07/11	ENGINE: IXDA
----------	--------	----	---------------	--------------

MONDEO IV (BA7)

2.0 TDCi	Diesel	103	03/07 →	ENGINE: QXBA
----------	--------	-----	---------	--------------

MONDEO IV Tre volumi (BA7)

2.0 TDCi	Diesel	103	03/07 →	ENGINE: QXBA
----------	--------	-----	---------	--------------

MONDEO IV Turnier (BA7)

2.0 TDCi	Diesel	103	03/07 →	ENGINE: QXBA
----------	--------	-----	---------	--------------

50CDSP3
B3 **CORPO FARFALLATO
THROTTLE BODY**

KW

CITROËN
C8 (EA_, EB_)

2.0 HDi	Diesel	88	02/07 → 11/07	ENGINE: RHK (DW10UTED4)
---------	--------	----	---------------	-------------------------

50CDSP3



CITROËN

JUMPY

2.0 HDi 120	Diesel	88	01/07 → 11/07	ENGINE: RHK (DW10UTED4)
-------------	--------	----	---------------	-------------------------

JUMPY Furgonato

2.0 HDi 120	Diesel	88	01/07 → 11/07	ENGINE: RHK (DW10UTED4)
-------------	--------	----	---------------	-------------------------

FIAT

SCUDO (270_)

2.0 D Multijet	Diesel	88	01/07 → 11/07	ENGINE: RHK
2.0 D Multijet 4x4	Diesel	88	01/07 → 11/07	ENGINE: RHK

SCUDO Furgonato (270_)

2.0 D Multijet	Diesel	88	01/07 → 11/07	ENGINE: RHK
2.0 D Multijet 4x4	Diesel	88	01/07 → 11/07	ENGINE: RHK

SCUDO Pianale piatto/Telaio (270_)

2.0 D Multijet	Diesel	88	01/07 → 11/07	ENGINE: RHK
----------------	--------	----	---------------	-------------

PEUGEOT

807 (E)

2.0 HDi	Diesel	88	02/06 → 11/07	ENGINE: RHK (DW10UTED4)
---------	--------	----	---------------	-------------------------

EXPERT Furgonato (VF3A_, VF3U_, VF3X_)

2.0 HDi 120	Diesel	88	01/07 → 11/07	ENGINE: RHK (DW10UTED4)
-------------	--------	----	---------------	-------------------------

EXPERT Pianale piatto/Telaio

2.0 HDi 120	Diesel	88	01/07 → 11/07	ENGINE: RHK (DW10UTED4)
-------------	--------	----	---------------	-------------------------

EXPERT Tepee (VF3V_)

2.0 HDi 120	Diesel	88	01/07 → 11/07	ENGINE: RHK (DW10UTED4)
-------------	--------	----	---------------	-------------------------

50CDSP3/F

B3 CORPO FARFALLATO THROTTLE BODY



FORD

FOCUS II (DA_)

2.0 TDCi	Diesel	100	03/07 →	ENGINE: G6DA, G6DB, G6DD
----------	--------	-----	---------	--------------------------

FOCUS II Cabriolet

2.0 TDCi	Diesel	100	03/07 →	ENGINE: G6DA, G6DB, G6DD
----------	--------	-----	---------	--------------------------

FOCUS II Station wagon (DA_)

2.0 TDCi	Diesel	100	03/07 →	ENGINE: G6DA, G6DB, G6DD
----------	--------	-----	---------	--------------------------

FOCUS II Tre volumi (DA_)

2.0 TDCi	Diesel	100	03/07 →	ENGINE: G6DA, G6DB, G6DD
----------	--------	-----	---------	--------------------------

MONDEO IV (BA7)

2.0 TDCi	Diesel	103	03/07 →	ENGINE: QXBB
----------	--------	-----	---------	--------------

MONDEO IV Tre volumi (BA7)

2.0 TDCi	Diesel	103	03/07 →	ENGINE: QXBB
----------	--------	-----	---------	--------------

MONDEO IV Turnier (BA7)

2.0 TDCi	Diesel	103	03/07 →	ENGINE: QXBB
----------	--------	-----	---------	--------------

S-MAX (WA6)

2.0 TDCi	Diesel	103	05/06 →	ENGINE: QXWC, UFWA, QXWA, QXWB
----------	--------	-----	---------	--------------------------------

50CDSP6
B3 CORPO FARFALLATO
THROTTLE BODY

CITROËN
C8 (EA_, EB_)

2.0 HDi	Diesel	88	02/07 →	ENGINE: RHK (DW10UTED4)
---------	--------	----	---------	----------------------------

JUMPY

2.0 HDi 120	Diesel	88	01/07 →	ENGINE: RHK (DW10UTED4)
-------------	--------	----	---------	----------------------------

JUMPY Furgonato

2.0 HDi 120	Diesel	88	01/07 →	ENGINE: RHK (DW10UTED4)
-------------	--------	----	---------	----------------------------

PEUGEOT
807 (E)

2.0 HDi	Diesel	79	06/02 →	ENGINE: RHK (DW10UTED4)
---------	--------	----	---------	----------------------------

2.0 HDi	Diesel	88	02/06 →	ENGINE: RHK (DW10UTED4)
---------	--------	----	---------	----------------------------

EXPERT Furgonato (VF3A_, VF3U_, VF3X_)

2.0 HDi 120	Diesel	88	01/07 →	ENGINE: RHK (DW10UTED4)
-------------	--------	----	---------	----------------------------

EXPERT Pianale piatto/Telaio

2.0 HDi 120	Diesel	88	01/07 →	ENGINE: RHK (DW10UTED4)
-------------	--------	----	---------	----------------------------

EXPERT Tepee (VF3V_)

2.0 HDi 120	Diesel	88	01/07 →	ENGINE: RHK (DW10UTED4)
-------------	--------	----	---------	----------------------------

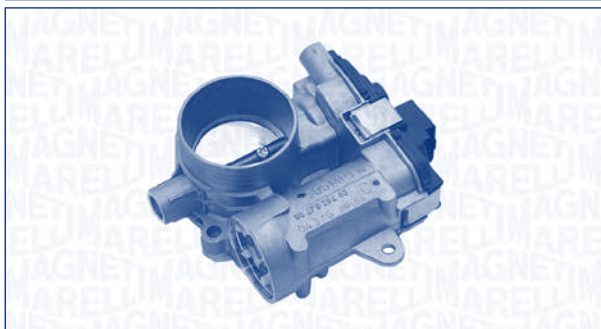
50SMP1
B3 CORPO FARFALLATO
THROTTLE BODY

CITROËN
C2 (JM_)

1.4 16V	Petrol	65	06/06 →	ENGINE: KFUET3J4
---------	--------	----	---------	------------------

C3 I (FC_)

1.4 16V	Petrol	65	12/03 →	ENGINE: KFUET3J4
---------	--------	----	---------	------------------

C4 I (LC_)

1.4 16V	Petrol	65	11/04 →	ENGINE: KFUET3J4
---------	--------	----	---------	------------------

PEUGEOT
1007 (KM_)

1.4 16V	Petrol	65	10/05 →	ENGINE: KFUET3J4
---------	--------	----	---------	------------------

206 2 volumi /Coda spiovente (2A/C)

1.4 16V	Petrol	65	10/03 →	ENGINE: KFUET3J4
---------	--------	----	---------	------------------

206 SW (2E/K)

1.4 16V	Petrol	65	10/03 →	ENGINE: KFUET3J4
---------	--------	----	---------	------------------

207 (WA_, WC_)

1.4 16V	Petrol	65	02/06 →	ENGINE: KFUET3J4
---------	--------	----	---------	------------------

307 (3A/C)

1.4 16V	Petrol	65	11/03 →	ENGINE: KFUET3J4
---------	--------	----	---------	------------------

307 Break (3E)

1.4 16V	Petrol	65	11/03 →	ENGINE: KFUET3J4
---------	--------	----	---------	------------------

307 SW (3H)

1.4 16V	Petrol	65	11/03 →	ENGINE: KFUET3J4
---------	--------	----	---------	------------------

52SXP31

B3 CORPO FARFALLATO
THROTTLE BODY



CITROËN

XSARA PICASSO (N68)

2.0 HDi	Diesel	80	12/99 →	ENGINE: RHZ (DW10ATED)
---------	--------	----	---------	------------------------

PEUGEOT

307 (3A/C)

2.0 HDi 110	Diesel	79	08/00 →	ENGINE: RHS (DW10ATED)
-------------	--------	----	---------	------------------------

54DTE3I

B3 CORPO FARFALLATO
THROTTLE BODY

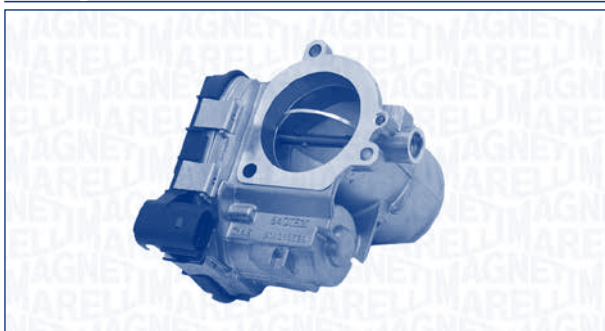

FIAT

DUCATO Autobus (250)

110 Multijet 2,3 D	Diesel	83	10/11 →	ENGINE: F1AE3481G
150 Multijet 2,3 D	Diesel	109	06/11 →	ENGINE: F1AE3481E

DUCATO Furgonato (250)

110 Multijet 2,3 D	Diesel	83	10/11 →	ENGINE: F1AE3481G
150 Multijet 2,3 D	Diesel	109	06/11 →	ENGINE: F1AE3481E

DUCATO Pianale piatto/Telaio (250)

110 Multijet 2,3 D	Diesel	83	10/11 →	ENGINE: F1AE3481G
150 Multijet 2,3 D	Diesel	109	06/11 →	ENGINE: F1AE3481E

54DTS3I

B3 CORPO FARFALLATO
THROTTLE BODY

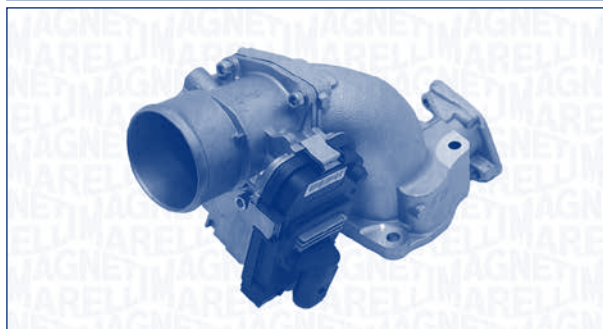

FIAT

DUCATO Autobus (250)

120 Multijet 2,3 D	Diesel	88	07/06 →	
--------------------	--------	----	---------	--

DUCATO Furgonato (250)

120 Multijet 2,3 D	Diesel	88	07/06 →	
130 Multijet 2,3 D	Diesel	96	01/07 →	

DUCATO Pianale piatto/Telaio (250)

120 Multijet 2,3 D	Diesel	88	07/06 →	
130 Multijet 2,3 D	Diesel	96	01/07 →	

IVECO

DAILY IV Autobus

35S14 G	Petrol/ CNG	100	07/09 →	ENGINE: F1CE0441A
35S14, 35S14 /P	Diesel	100	05/06 →	ENGINE: F1AE0481HA

DAILY IV Cassone / Furgonato / Promiscuo

29L10 V	Diesel	70	05/06 →	ENGINE: F1AE0481FA
29L12 V, 29L12 V/P	Diesel	85	05/06 →	ENGINE: F1AE0481GA
29L14 C, 29L14 C/P, 29L14 V, 29L14 V/P	Diesel	100	05/06 →	ENGINE: F1AE0481HA
35C10, 35S10	Diesel	70	05/06 →	ENGINE: F1AE0481FA
35C11 V, 35S11 V	Diesel	78	07/07 →	ENGINE: F1AE0481FA
35C12 V, 35C12 V/P, 35S12 V, 35S12 V/P	Diesel	85	05/06 →	ENGINE: F1AE0481GA
35C13 V, 35C13 V/P, 35S13 V, 35S13 V/P	Diesel	93	07/07 →	ENGINE: F1AE0481GA

54DTS3I

IVECO
DAILY IV Cassone / Furgonato / Promiscuo

35S14 C, 35S14 C/P, 35S14 V, 35S14 V/P, 35C14 V, 35C14 V/P	Diesel	100	05/06 →	ENGINE: F1AE0481HA
40C10 V	Diesel	70	05/06 →	ENGINE: F1AE0481FA
40C11 V	Diesel	78	07/07 →	ENGINE: F1AE0481FA
40C12 V, 40C14 V/P	Diesel	85	05/06 →	ENGINE: F1AE0481GA
40C13 V, 40C13 V/P	Diesel	93	07/07 →	ENGINE: F1AE0481GA

DAILY IV Pianale piatto/Telaio

29L10	Diesel	70	05/06 →	ENGINE: F1AE0481FA
29L12	Diesel	85	05/06 →	ENGINE: F1AE0481GA
29L14	Diesel	100	05/06 →	ENGINE: F1AE0481HA
35C10, 35S10	Diesel	70	05/06 →	ENGINE: F1AE0481FA
35C11, 35S11, 35S11 D, 35S11 /P	Diesel	78	07/07 →	ENGINE: F1AE0481FA
35C12, 35S12	Diesel	85	05/06 →	ENGINE: F1AE0481GA
35C13, 35C13/P, 35S13 D, 35S13, 35S13 /P	Diesel	93	07/07 →	ENGINE: F1AE0481GA
35C14, 35S14, 35S14 /P	Diesel	100	05/06 →	ENGINE: F1AE0481HA
40C10	Diesel	70	05/06 →	ENGINE: F1AE0481FA
40C11, 40C11 D	Diesel	78	07/07 →	ENGINE: F1AE0481FA
40C12	Diesel	85	05/06 →	ENGINE: F1AE0481GA
40C13, 40C13 /P	Diesel	93	07/07 →	ENGINE: F1AE0481GA

DAILY IV Ribaltabile

35C10 K	Diesel	70	05/06 →	ENGINE: F1AE0481FA
35C11 K, 35C11 DK, 35S11 K, 35S11 DK	Diesel	78	07/07 →	ENGINE: F1AE0481FA
35C12	Diesel	85	05/06 →	ENGINE: F1AE0481GA
35C13 K, 35C13 DK, 35S13 K, 35S13 DK	Diesel	93	07/07 →	ENGINE: F1AE0481GA
35S14 K, 35S14 DK	Diesel	100	07/07 →	ENGINE: F1AE0481HA

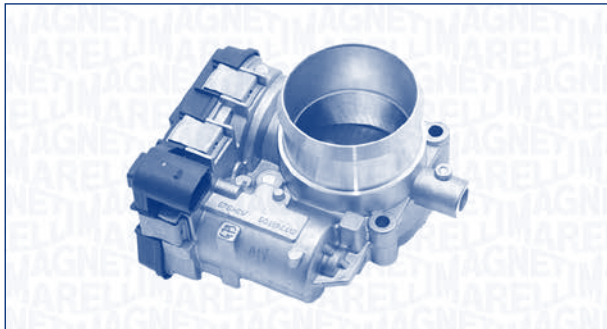
57SMI1
**B3 CORPO FARFALLATO
THROTTLE BODY**

FIAT
DUCATO Pianale piatto/Telaio (250)

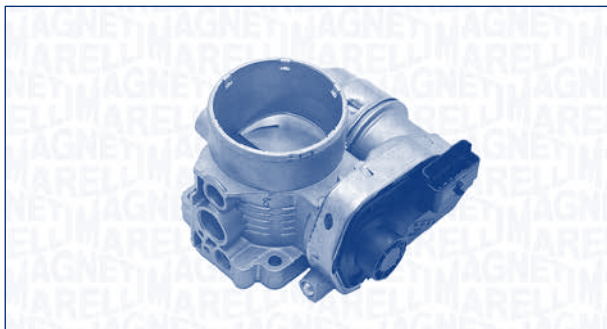
140 Natural Power	Petrol/CNG	100	04/09 →	ENGINE: F1CE0441A
140 Natural Power	Petrol/CNG	100	04/09 →	ENGINE: F1CE0441A

60CPM
**B3 CORPO FARFALLATO
THROTTLE BODY**

PEUGEOT
407 (6D_)

2.2 16V	Petrol	120	09/05 →	ENGINE: 3FY (EW12J4)
---------	--------	-----	---------	----------------------

407 SW (6E_)

2.2 16V	Petrol	120	09/05 →	ENGINE: 3FY (EW12J4)
---------	--------	-----	---------	----------------------

60CPM1

B3 CORPO FARFALLATO
THROTTLE BODY



CITROËN

C5 I (DC_)

2.0 16V HPi (DCRLZB)	Petrol	103	03/01 → 08/04	ENGINE: RLZEW10D
----------------------	--------	-----	---------------	------------------

C5 I Break (DE_)

2.0 16V HPi (DERLZB)	Petrol	103	06/01 → 08/04	ENGINE: RLZEW10D
----------------------	--------	-----	---------------	------------------

PEUGEOT

406 (8B)

2.0 16V HPi	Petrol	103	05/01 → 05/04	ENGINE: RLZEW10D
-------------	--------	-----	---------------	------------------

406 Break (8E/F)

2.0 16V HPi	Petrol	103	05/01 → 10/04	ENGINE: RLZEW10D
-------------	--------	-----	---------------	------------------

60CPM2

B3 CORPO FARFALLATO
THROTTLE BODY

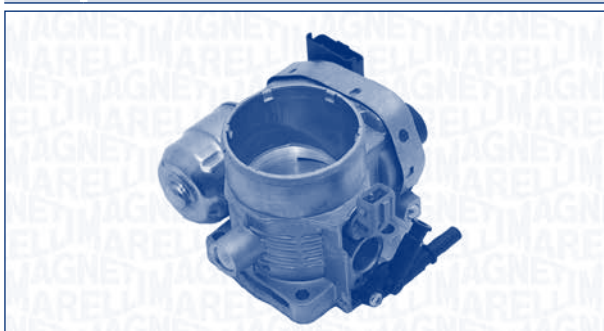

CITROËN

C8 (EA_, EB_)

2.2	Petrol	116	07/02 →	ENGINE: 3FZ (EW12J4)
-----	--------	-----	---------	----------------------

PEUGEOT

406 (8B)

2.2	Petrol	116	07/00 → 05/04	ENGINE: 3FZ (EW12J4)
-----	--------	-----	---------------	----------------------

60CPM2



PEUGEOT

406 Break (8E/F)

2.2	Petrol	116	07/00 → 10/04	ENGINE: 3FZ (EW12J4)
-----	--------	-----	---------------	----------------------

407 (6D_)

2.2	Petrol	116	05/04 →	ENGINE: 3FZ (EW12J4)
-----	--------	-----	---------	----------------------

407 Coupé (6C_)

2.2 16V	Petrol	120	10/05 →	ENGINE: 3FY (EW12J4)
---------	--------	-----	---------	----------------------

607 (9D, 9U)

2.2 16V	Petrol	116	02/00 →	ENGINE: 3FZ (EW12J4)
---------	--------	-----	---------	----------------------

807 (E)

2.2	Petrol	116	06/02 →	ENGINE: 3FZ (EW12J4)
-----	--------	-----	---------	----------------------

60XR32

B3 CORPO FARFALLATO
THROTTLE BODY



RENAULT

SCÉNIC I (JA0/1_)

2.0 16V	Petrol	103	09/99 → 08/03	ENGINE: F4R744
---------	--------	-----	---------------	----------------

2.0 16V RX4	Petrol	102	06/00 → 08/03	ENGINE: F4R744
-------------	--------	-----	---------------	----------------

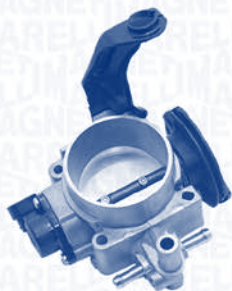
60XR9
B3 CORPO FARFALLATO
THROTTLE BODY

RENAULT
LAGUNA I (B56_, 556_)

2.0	Petrol	103	06/95 → 02/01	ENGINE: N7Q700, N7Q704
2.0	Petrol	70	11/93 → 03/01	
2.0	Petrol	84	06/95 → 02/01	ENGINE: F3R768

MEGANE I (BA0/1_)

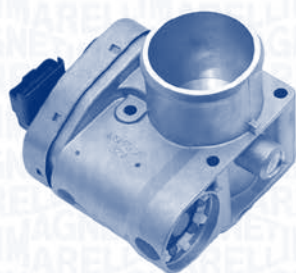
2.0 i (BA0G)	Petrol	84	01/96 → 08/03	ENGINE: F3R750, F3R751
--------------	--------	----	---------------	---------------------------

KIT48SMF5
B3 CORPO FARFALLATO
THROTTLE BODY

FIAT
DOBLO (119)

1.6 16V (223AXD1A)	Petrol	76	10/01 →	
-----------------------	--------	----	---------	--

DOBLO Cargo (223)

1.6 16V (223ZXD1A)	Petrol	76	10/01 →	
-----------------------	--------	----	---------	--

STILO (192)

1.6 16V (192_XB1A)	Petrol	76	10/01 → 11/06	
-----------------------	--------	----	---------------	--

KIT48SMF5

FIAT
STILO Multi Wagon (192)

1.6 16V	Petrol	76	01/03 → 08/08	
---------	--------	----	---------------	--

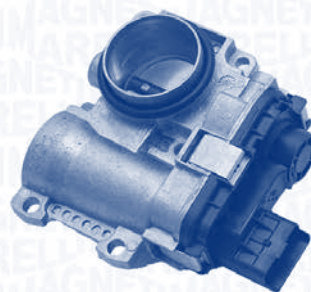
SMR00102Y
B3 CORPO FARFALLATO
THROTTLE BODY

RENAULT
CLIO II (BB0/1/2_, CB0/1/2_)

1.2 16V	Petrol	54	06/06 →	ENGINE: D4F706, D4F712
1.2 16V (BB05, BB0W, BB11, BB27, BB2T, BB2U, BB2V, CB05...)	Petrol	55	06/01 →	ENGINE: D4F706, D4F712, D4F714, D4F722, D4F728

KANGOO (KC0/1_)

1.2 16V (KC03, KC05, KC06, KC0T, KC0W)	Petrol	55	06/01 →	ENGINE: D4F712, D4F714, D4F716
--	--------	----	---------	-----------------------------------

KANGOO Express (FC0/1_)

1.2 16V (FC05)	Petrol	55	10/01 →	ENGINE: D4F712, D4F714, D4F730
----------------	--------	----	---------	-----------------------------------

THALIA I (LB0/1/2_)

1.2 16V	Petrol	55	04/02 →	ENGINE: D4F712
---------	--------	----	---------	----------------

TWINGO I (C06_)

1.2 16V (C060)	Petrol	44	08/04 →	ENGINE: D4F708
1.2 16V (C06C, C06D, C06K)	Petrol	55	01/01 →	ENGINE: D4F702

TB0001

B3 CORPO FARFALLATO
THROTTLE BODY

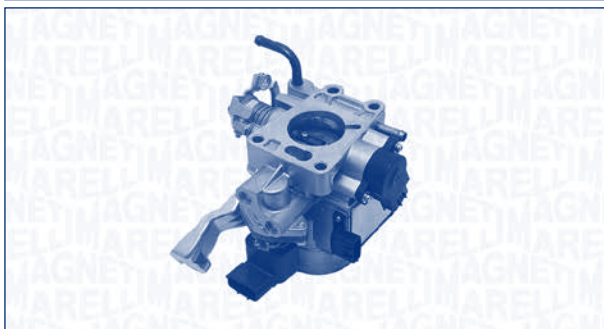

NISSAN

MICRA II (K11)

1.3 i 16V Petrol 55 02/98 → 07/00

TB0002

B3 CORPO FARFALLATO
THROTTLE BODY



OPEL

ASTRA H (L48)

1.7 CDTI Diesel 81 02/07 →

1.7 CDTI Diesel 92 02/07 →

ASTRA H GTC (L08)

1.7 CDTI Diesel 81 02/07 →

1.7 CDTI Diesel 92 02/07 →

ASTRA H Station wagon (L35)

1.7 CDTI Diesel 81 02/07 →

1.7 CDTI Diesel 92 02/07 →

ASTRA H Van (L70)

1.7 CDTI Diesel 81 02/07 →

1.7 CDTI Diesel 92 02/07 →

ASTRA J

1.7 CDTI Diesel 81 12/09 →

1.7 CDTI Diesel 92 12/09 →

TB0002



OPEL

CORSA D

1.7 CDTI Diesel 92 07/06 →

MERIVA

1.7 CDTI Diesel 74 09/03 → 05/10

1.7 CDTI Diesel 92 09/06 → 05/10

ZAFIRA B (A05)

1.7 CDTI Diesel 81 01/08 →

1.7 CDTI Diesel 92 01/08 →

ZAFIRA B Van

1.7 CDTI Diesel 81 01/08 →

TB0003

B3 CORPO FARFALLATO
THROTTLE BODY

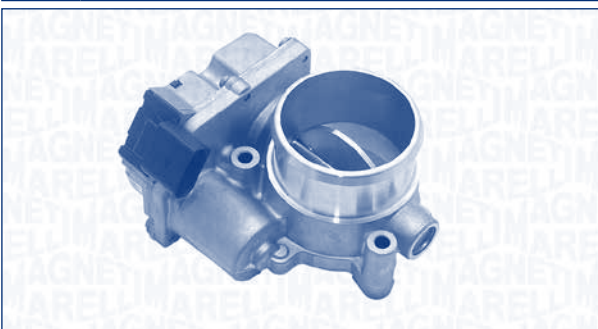

KIA

CARENS III (UN)

2.0 CRDi 115 Diesel 85 05/07 →

2.0 CRDi 140 Diesel 103 09/06 →

TB0004

B3 CORPO FARFALLATO
THROTTLE BODY

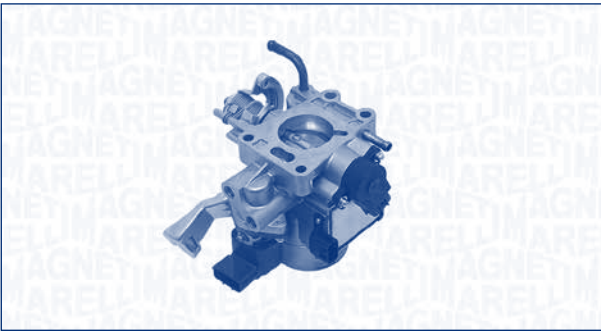

NISSAN

MICRA II (K11)

1.3 i 16V Petrol 55 12/95 → 02/98

TB0006

B3 CORPO FARFALLATO
THROTTLE BODY

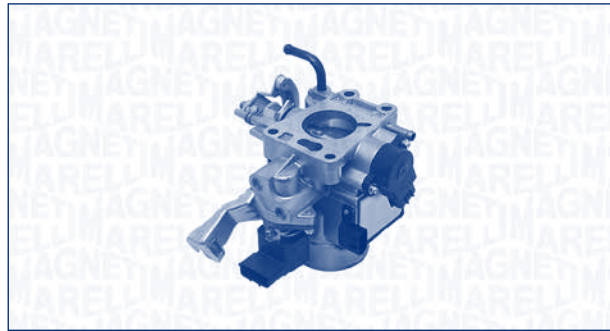

NISSAN

MICRA II (K11)

1.0 i 16V Petrol 40 08/92 → 12/95

TB0005

B3 CORPO FARFALLATO
THROTTLE BODY

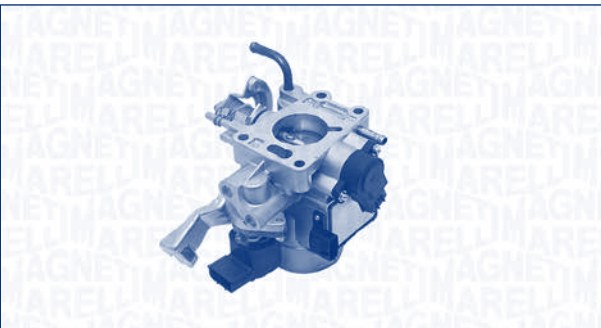

NISSAN

MICRA II (K11)

1.3 i 16V Petrol 55 08/92 → 12/95

TB0007

B3 CORPO FARFALLATO
THROTTLE BODY

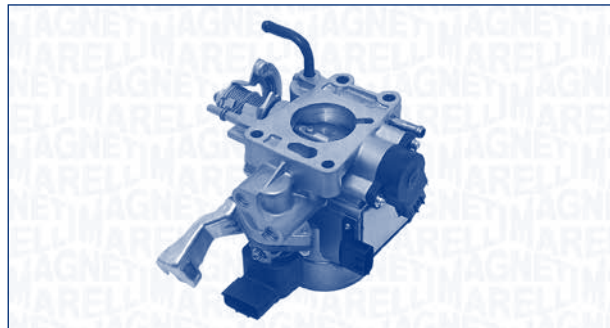

NISSAN

MICRA II (K11)

1.0 i 16V Petrol 40 12/95 → 02/98

TB0008

B3 CORPO FARFALLATO
THROTTLE BODY

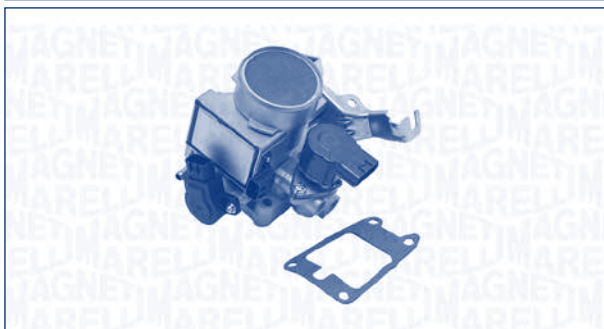

NISSAN

MICRA II (K11)

1.0 i 16V Petrol 40 02/98 → 07/00

TB0009

B3 CORPO FARFALLATO
THROTTLE BODY

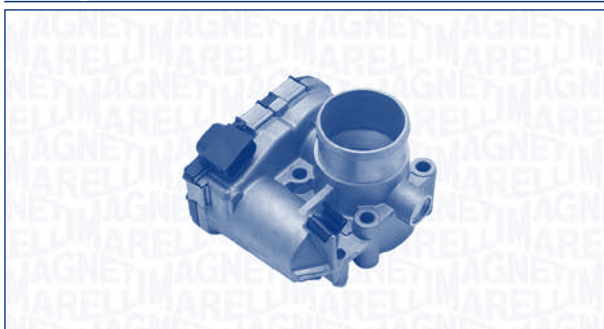

ALFA ROMEO

MITO (955)

1.4 Petrol 58 09/08 →

FIAT

BRAVO II (198)

1.4 Petrol 66 04/07 →

IDEA

1.4 16V Petrol 70 01/04 →

PUNTO (188)

1.4 Petrol 70 09/03 →

STILO (192)

1.4 16V Petrol 66 03/05 → 11/06

1.4 16V Petrol 70 01/04 → 11/06

STILO Multi Wagon (192)

1.4 16V Petrol 66 03/05 → 08/08

1.4 16V Petrol 70 01/04 → 08/08

TB0009



LANCIA

MUSA (350)

1.4 Petrol 70 10/04 →

TB0010

B3 CORPO FARFALLATO
THROTTLE BODY

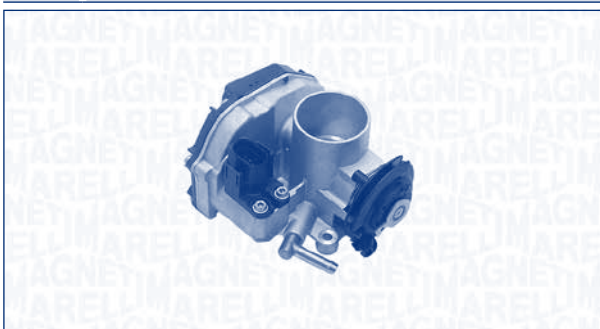

SEAT

CORDOBA (6K1, 6K2)

1.4 i Petrol 44 06/94 → 06/99

1.6 i Petrol 55 02/93 → 06/99

IBIZA II (6K1)

1.0 i Petrol 37 09/96 → 08/99

1.4 i Petrol 44 09/93 → 08/99

1.6 i Petrol 55 03/93 → 08/99

INCA (6K9)

1.6 i Petrol 55 06/97 → 09/00

SKODA

FELICIA I Fun (797)

1.6 Petrol 55 06/97 → 04/02

FELICIA I Station wagon (6U5)

1.6 GLX Petrol 55 08/95 → 03/98

VOLKSWAGEN

GOLF III (1H1)

1.4 Petrol 44 10/91 → 08/97

1.6 Petrol 55 09/92 → 08/97

GOLF III Variant (1H5)

1.4 Petrol 44 07/93 → 04/99

POLO (6N1)

55 1.4 Petrol 40 08/95 → 10/99

75 1.6 Petrol 55 10/94 → 10/99

POLO CLASSIC (6KV2)

60 1.4 Petrol 44 12/95 → 09/01

75 1.6 Petrol 55 11/95 → 09/01

TB0010

KW

VOLKSWAGEN
VENTO (1H2)

1.4	Petrol	44	11/91 → 09/98
1.6	Petrol	55	09/92 → 09/98

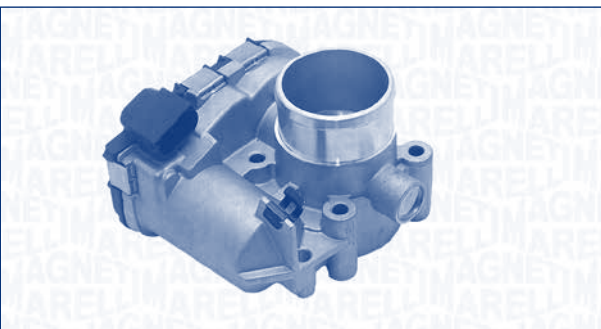
TB0011
B3
**CORPO FARFALLATO
THROTTLE BODY**

KW

FIAT
BRAVA (182)

1.2 16V 80	Petrol	59	10/00 → 09/01
------------	--------	----	---------------

BRAVO I (182)

1.2 16V 80	Petrol	59	10/00 → 09/01
------------	--------	----	---------------

IDEA

1.2 16V	Petrol	59	01/04 →
---------	--------	----	---------

PUNTO (188)

1.2 16V 80 (188.233, .235, .253, .255, .333, .353, .639...)	Petrol	59	09/99 →
--	--------	----	---------

STILO (192)

1.2 16V (192_XA1B)	Petrol	59	02/02 → 12/03
-----------------------	--------	----	---------------

LANCIA
Y (840A)

1.2 16V (840AG1A)	Petrol	59	10/00 → 06/03
----------------------	--------	----	---------------

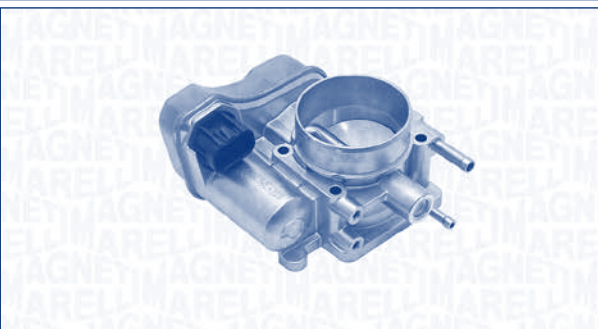
TB0012
B3
**CORPO FARFALLATO
THROTTLE BODY**

KW

OPEL
ASTRA H (L48)

1.8	Petrol	103	01/06 →
1.8	Petrol	92	03/04 →

ASTRA H GTC (L08)

1.8	Petrol	103	01/06 →
1.8	Petrol	92	03/05 →

ASTRA H Station wagon (L35)

1.8	Petrol	92	08/04 →
-----	--------	----	---------

ASTRA H TwinTop (L67)

1.8	Petrol	92	09/05 →
-----	--------	----	---------

CORSA C (F08, F68)

1.8	Petrol	92	09/00 → 12/09
-----	--------	----	---------------

MERIVA

1.8	Petrol	92	05/03 → 05/10
-----	--------	----	---------------

OMEGA B (25_, 26_, 27_)

2.2 16V	Petrol	106	09/99 → 07/03
---------	--------	-----	---------------

OMEGA B Station wagon (21_, 22_, 23_)

2.2 16V	Petrol	106	09/99 → 07/03
---------	--------	-----	---------------

SIGNUM

1.8	Petrol	103	09/05 →
1.8	Petrol	90	05/03 →

TIGRA TwinTop

1.8	Petrol	92	06/04 →
-----	--------	----	---------

VECTRA B (36_)

1.8 i 16V	Petrol	92	09/00 → 04/02
-----------	--------	----	---------------

VECTRA B 2 volumi /Coda spiovente (38_)

1.8 i 16V	Petrol	92	09/00 → 07/03
-----------	--------	----	---------------

VECTRA B Station wagon (31_)

1.8 i 16V	Petrol	92	09/00 → 07/03
-----------	--------	----	---------------

VECTRA C

1.8	Petrol	103	01/06 →
1.8	Petrol	81	04/02 →
1.8 16V	Petrol	90	04/02 →

TB0012



OPEL

VECTRA C GTS

1.8 Petrol 103 01/06 →

VECTRA C Station wagon

1.8 Petrol 103 01/06 →

1.8 Petrol 90 10/03 →

ZAFIRA A (F75_)

1.8 16V Petrol 92 09/00 → 06/05

TB0013

B3 CORPO FARFALLATO THROTTLE BODY

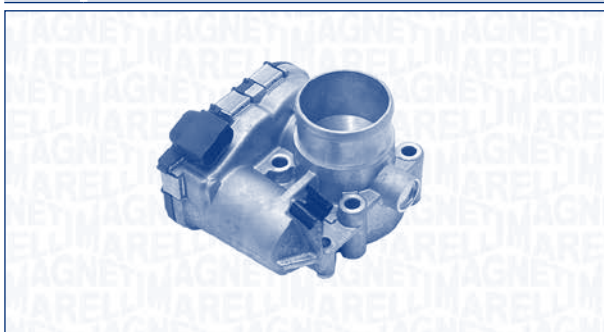

LANCIA

YPSILON (843)

1.4 16V Petrol 70 10/03 → 12/11

TB0014

B3 CORPO FARFALLATO THROTTLE BODY

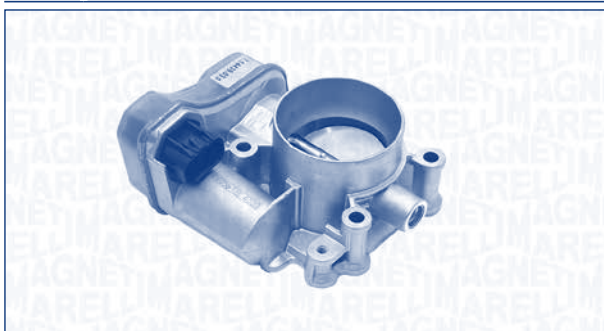

OPEL

SIGNUM

2.2 direct Petrol 114 05/03 →

VECTRA C

2.2 direct Petrol 114 10/03 →

TB0014



OPEL

VECTRA C GTS

2.2 direct Petrol 114 10/03 →

VECTRA C Station wagon

2.2 direct Petrol 114 10/03 →

ZAFIRA B (A05)

2.2 Petrol 110 07/05 →

VAUXHALL

SIGNUM

2.2 i Petrol 114 05/03 → 05/08

ZAFIRA Mk II (B) (M75)

2.2 Petrol 110 07/05 →

TB0015

B3 CORPO FARFALLATO THROTTLE BODY

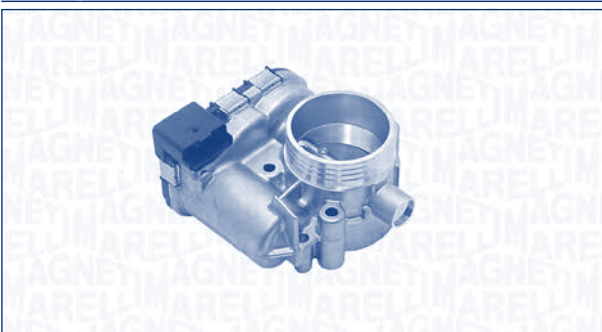

CITROËN

BERLINGO (MF)

1.6 16V (MFNFU) Petrol 80 10/00 →

BERLINGO Furgonato (M_)

1.6 16V (MBNFU) Petrol 80 10/00 →

C2 (JM_)

1.6 Petrol 80 09/03 →

1.6 VTS Petrol 90 01/05 →

C3 I (FC_)

1.6 16V Petrol 80 02/02 →

C3 Pluriel (HB_)

1.6 Petrol 80 05/03 →

C4 I (LC_)

1.6 16V Bio-Flex BiFuel 80 09/07 →

XSARA (N1)

1.6 16V Petrol 80 09/00 → 03/05

TB0015

CITROËN
XSARA Break (N2)

1.6 16V Petrol 80 09/00 → 08/05

XSARA Coupé (N0)

1.6 16V Petrol 80 09/00 → 03/05

PEUGEOT
1007 (KM_)

1.6 16V Petrol 80 04/05 →

206 2 volumi /Coda spiovente (2A/C)

1.6 16V Petrol 80 12/00 →

206 CC (2D)

1.6 16V Petrol 80 09/00 →

206 SW (2E/K)

1.6 16V Petrol 80 07/02 →

206 Tre volumi

1.6 16V Petrol 80 03/07 →

307 (3A/C)

1.6 16V Petrol 80 08/00 →

307 Break (3E)

1.6 16V Petrol 80 03/02 →

307 SW (3H)

1.6 16V Petrol 80 03/02 →

308 SW

1.6 Bioflex BiFuel 82 03/09 →

RANCH MPV / Space wagon (5F)

1.6 16V Petrol 80 07/01 →

KIT EC2/1
B2
**KIT ELETTROVALVOLA CANISTER
CANISTER VALVE KIT**

FIAT
500 (312)

1.2 Petrol 51 10/07 →

KIT EC2/1

FIAT
DOBLO (119)

1.2 (223AXA1A) Petrol 48 03/01 →

1.4 Petrol 57 10/05 →

DOBLO Cargo (223)

1.2 (223ZXA1A) Petrol 48 03/01 →

1.4 Petrol 57 10/05 →

LINEA (323)

1.4 Petrol 57 06/07 →

PALIO (178BX)

1.2 Petrol 54 01/01 →

PALIO Weekend (178DX)

1.2 (178DYA1A) Petrol 44 02/01 →

PANDA (141A_)

1100 Petrol 40 01/01 → 09/03

1100 Trekking 4x4 Petrol 37 01/01 → 09/03

PANDA (169)

1.1 Petrol 40 09/03 →

1.2 Petrol 44 09/03 →

1.2 4x4 Petrol 44 10/04 →

PANDA Van (141_)

1000 i.e Petrol 33 01/01 → 09/03

PUNTO (188)

1.2 60 (188.030, .050, .130, .150, .230, .250) Petrol 44 01/01 →

1.2 Natural Power BiFuel 44 09/03 →

PUNTO / GRANDE PUNTO (199)

1.2 Petrol 48 10/05 →

1.4 Petrol 57 10/05 →

PUNTO Van (188AX)

1.2 60 Petrol 44 01/01 → 10/09

SEICENTO (187)

1.1 (187AXB, 187AXB1A) Petrol 40 01/01 → 01/10

SEICENTO Van (187)

1.1 (187CXB/C) Petrol 40 01/01 → 01/10

STRADA Pick-up (178E)

1.2 Petrol 44 04/03 →

LANCIA
MUSA (350)

1.4 Petrol 57 09/05 →

KIT EC2/1

LANCIA
Y (840A)

1.2 (840AA, 840AF1A)	Petrol	44	01/01 → 09/03
----------------------	--------	----	---------------

YPSILON (843)

1.2	Petrol	44	10/03 → 12/11
-----	--------	----	---------------

KITEC1/02
**B2 KIT ELETTROVALVOLA CANISTER
CANISTER VALVE KIT**

FIAT
BRAVA (182)

1.6 16V (182.BH)	Petrol	66	10/95 → 12/97
------------------	--------	----	---------------

BRAVO I (182)

1.6 16V (182.AH)	Petrol	66	10/95 → 12/97
------------------	--------	----	---------------

CINQUECENTO (170)

0.9 i.e. S (170AF, 170CF)	Petrol	29	07/91 → 12/97
---------------------------	--------	----	---------------

1.1 Sporting (170AH)	Petrol	40	10/94 → 12/97
----------------------	--------	----	---------------

PALIO (178BX)

1.6 16V	Petrol	74	04/96 →
---------	--------	----	---------

PALIO Weekend (178DX)

1.6 16V (178DX.D1A)	Petrol	74	04/96 → 02/01
---------------------	--------	----	---------------

1.6 16V (178DYC1A06)	Petrol	76	02/01 →
----------------------	--------	----	---------

PANDA (141A_)

900	Petrol	29	04/92 → 12/96
-----	--------	----	---------------

1100	Petrol	37	05/91 → 12/97
------	--------	----	---------------

1000 i.e. Cat.	Petrol	33	10/87 → 12/97
----------------	--------	----	---------------

1100 Trekking 4x4	Petrol	37	10/91 → 07/04
-------------------	--------	----	---------------

KITEC1/02

FIAT
PUNTO (176)

1.2 16V	Petrol	63	04/97 → 09/99
---------	--------	----	---------------

55 1.1	Petrol	40	09/93 → 12/97
--------	--------	----	---------------

60 1.2	Petrol	44	03/94 → 12/97
--------	--------	----	---------------

75 1.2	Petrol	54	01/94 → 12/97
--------	--------	----	---------------

PUNTO Cabriolet (176C)

60 1.2	Petrol	44	05/95 → 12/97
--------	--------	----	---------------

85 16V 1.2	Petrol	63	04/97 → 06/00
------------	--------	----	---------------

PUNTO Van (176L)

1.1	Petrol	40	04/96 → 12/97
-----	--------	----	---------------

SIENA (178_)

1.6 16V	Petrol	78	09/98 →
---------	--------	----	---------

TEMPRA (159)

1.8 i.e. (159.AV)	Petrol	76	09/93 → 08/96
-------------------	--------	----	---------------

1.8 i.e. (159.BY)	Petrol	74	10/94 → 08/96
-------------------	--------	----	---------------

TEMPRA S.W. (159)

1.8 i.e. (159.AV)	Petrol	76	09/93 → 08/96
-------------------	--------	----	---------------

1.8 i.e. (159.BY)	Petrol	74	10/94 → 08/96
-------------------	--------	----	---------------

TIPO (160)

1.8 i.e.	Petrol	66	09/93 → 04/95
----------	--------	----	---------------

1.8 i.e. (160.ED)	Petrol	76	04/93 → 04/95
-------------------	--------	----	---------------

1.8 i.e. (160.EQ, 160.AM)	Petrol	74	10/94 → 04/95
---------------------------	--------	----	---------------

LANCIA
DEDRA (835)

1.6 16V (835EI)	Petrol	76	01/96 → 07/99
-----------------	--------	----	---------------

1.8 i.e. (835FA)	Petrol	74	07/94 → 12/97
------------------	--------	----	---------------

DEDRA SW (835)

1.6 16V (835EI)	Petrol	76	01/96 → 07/99
-----------------	--------	----	---------------

1.8 i.e. (835FA)	Petrol	74	07/94 → 12/97
------------------	--------	----	---------------

DELTA II (836)

1.8 i.e. (836AE)	Petrol	76	06/93 → 12/97
------------------	--------	----	---------------

1.8 i.e. (836AG, 836AL)	Petrol	66	07/94 → 12/97
-------------------------	--------	----	---------------

Y (840A)

1.1 (840AE)	Petrol	40	11/95 → 09/03
-------------	--------	----	---------------

1.2 (840AA, 840AF1A)	Petrol	44	03/96 → 09/03
----------------------	--------	----	---------------

1.2 16V (840AD)	Petrol	63	04/97 → 09/03
-----------------	--------	----	---------------

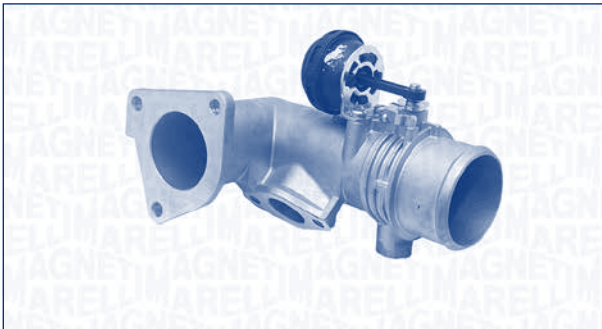
TB0016
B3 **REGOLATORE ARIA MOTORE
CONTROL FLAP - AIR SUPPLY**

FIAT
PUNTO (188)

1.9 JTD	Diesel	63	10/01 →
1.9 JTD	Diesel	74	06/03 →
1.9 JTD 80 (188.237, .257, .337, .357)	Diesel	59	09/99 →

PUNTO Van (188AX)

1.9 JTD	Diesel	63	02/00 → 10/09
---------	--------	----	---------------

TB0017
B3 **REGOLATORE ARIA MOTORE
CONTROL FLAP - AIR SUPPLY**

ALFA ROMEO
147 (937)

1.9 JTD 16V	Diesel	100	10/04 → 03/10
1.9 JTD 16V	Diesel	103	11/02 → 03/10
1.9 JTD 16V	Diesel	93	09/03 → 09/04
1.9 JTDM	Diesel	85	10/04 → 03/10
1.9 JTDM 16V	Diesel	110	09/04 → 03/10
1.9 JTDM 8V	Diesel	88	07/05 → 03/10

TB0017

ALFA ROMEO
156 (932)

1.9 JTD	Diesel	100	11/02 → 11/04
1.9 JTD	Diesel	93	11/03 → 09/05
1.9 JTD 16V	Diesel	103	11/02 → 09/05
2.4 JTD	Diesel	129	10/03 → 09/05

156 Sportwagon (932)

1.9 JTD	Diesel	100	11/02 → 11/04
1.9 JTD	Diesel	93	11/03 → 05/06
1.9 JTD 16V	Diesel	103	11/02 → 05/06
1.9 JTD 16V Q4	Diesel	110	07/04 → 05/06
2.4 JTD	Diesel	129	10/03 → 05/06

166 (936)

2.4 JTD	Diesel	110	04/02 → 06/07
---------	--------	-----	---------------

166 (936)

2.4 JTD	Diesel	129	10/03 → 06/07
---------	--------	-----	---------------

GT (937)

1.9 JTD	Diesel	110	11/03 → 09/10
---------	--------	-----	---------------

LANCIA
THESIS (841AX)

2.4 JTD	Diesel	129	05/03 → 07/09
---------	--------	-----	---------------

TB0018
B3 **REGOLATORE ARIA MOTORE
CONTROL FLAP - AIR SUPPLY**

ALFA ROMEO
147 (937)

1.9 JTD	Diesel	74	06/03 → 03/10
---------	--------	----	---------------

156 (932)

1.9 JTD (932A2B_)	Diesel	81	10/00 → 05/01
2.4 JTD (932AXC)	Diesel	110	03/02 → 09/05

TB0018



ALFA ROMEO

156 Sportwagon (932)

1.9 JTD (932B2B_)	Diesel	81	10/00 → 05/01
----------------------	--------	----	---------------

2.4 JTD (932BXC)	Diesel	110	03/02 → 05/06
---------------------	--------	-----	---------------

166 (936)

2.4 JTD (936A2B_)	Diesel	103	10/00 → 06/07
----------------------	--------	-----	---------------

FIAT

BRAVA (182)

1.9 JTD	Diesel	74	09/00 → 10/01
---------	--------	----	---------------

1.9 JTD 105	Diesel	77	12/98 → 10/01
-------------	--------	----	---------------

BRAVO I (182)

1.9 JTD	Diesel	74	09/00 → 10/01
---------	--------	----	---------------

MAREA (185)

1.9 JTD 105	Diesel	77	04/99 → 01/01
-------------	--------	----	---------------

1.9 JTD 110	Diesel	81	01/01 → 05/02
-------------	--------	----	---------------

MAREA Weekend (185)

1.9 JTD 105	Diesel	77	04/99 → 05/02
-------------	--------	----	---------------

1.9 JTD 110	Diesel	81	01/01 → 05/02
-------------	--------	----	---------------

LANCIA

LYBRA (839AX)

1.9 JTD	Diesel	85	05/01 → 10/05
---------	--------	----	---------------

2.4 JTD	Diesel	110	05/02 → 10/05
---------	--------	-----	---------------

2.4 JTD (839AXE1A)	Diesel	99	07/99 → 02/01
-----------------------	--------	----	---------------

LANCIA

LYBRA (839AX)

2.4 JTD (839AXL1A)	Diesel	103	09/00 → 05/02
-----------------------	--------	-----	---------------

LYBRA SW (839BX)

1.9 JTD	Diesel	85	05/01 → 10/05
---------	--------	----	---------------

2.4 JTD	Diesel	110	05/02 → 10/05
---------	--------	-----	---------------

2.4 JTD (839BXE1A)	Diesel	99	10/99 → 09/00
-----------------------	--------	----	---------------

2.4 JTD (839BXL1A)	Diesel	103	09/00 → 10/05
-----------------------	--------	-----	---------------

THEISIS (841AX)

2.4 D Multijet	Diesel	136	04/06 → 07/09
----------------	--------	-----	---------------

2.4 JTD (841AXD1B02)	Diesel	110	07/02 → 07/09
-------------------------	--------	-----	---------------

TB0019

B3 **REGOLATORE ARIA MOTORE**
CONTROL FLAP - AIR SUPPLY

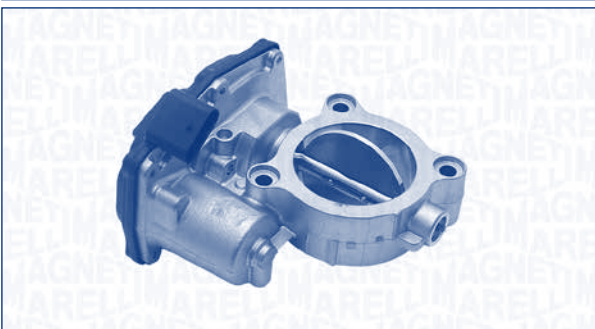

BMW

3 (E90)

318 d	Diesel	105	09/05 → 12/11
-------	--------	-----	---------------

320 d	Diesel	130	09/07 → 12/11
-------	--------	-----	---------------

320 d	Diesel	135	01/10 → 12/11
-------	--------	-----	---------------

3 Cabriolet (E93)

320 d	Diesel	130	03/07 →
-------	--------	-----	---------

3 Coupé (E92)

320 d	Diesel	130	03/07 →
-------	--------	-----	---------

320 d	Diesel	135	01/10 →
-------	--------	-----	---------

3 Touring (E91)

318 d	Diesel	100	07/07 →
-------	--------	-----	---------

318 d	Diesel	105	09/07 →
-------	--------	-----	---------

320 d	Diesel	120	09/05 →
-------	--------	-----	---------

320 d	Diesel	130	09/07 →
-------	--------	-----	---------

320 d	Diesel	135	01/10 →
-------	--------	-----	---------

5 (F10, F18)

520 d	Diesel	135	03/10 →
-------	--------	-----	---------

5 Touring (F11)

520 d	Diesel	135	09/10 →
-------	--------	-----	---------

AMM19651
B4 **SENSORE MASSA ARIA**
AIR MASS SENSOR

FORD
FIESTA V (JH_, JD_)

1.4 TDCi	Diesel	50	02/04 → 06/08	ENGINE: DURATORQ14TDCI
----------	--------	----	---------------	---------------------------

FUSION (JU_)

1.4 TDCi	Diesel	50	02/04 →	ENGINE: DURATORQ14TDCI
----------	--------	----	---------	---------------------------

AMM19652
B4 **SENSORE MASSA ARIA**
AIR MASS SENSOR

FORD
FOCUS II (DA_)

1.6 Ti	Petrol	85	11/04 →	ENGINE: ZETEC-S
--------	--------	----	---------	-----------------

FOCUS II Station wagon (DA_)

1.6 Ti	Petrol	85	11/04 →	ENGINE: ZETEC-S
--------	--------	----	---------	-----------------

FOCUS II Tre volumi (DA_)

1.6 Ti	Petrol	85	04/05 →	ENGINE: ZETEC-S
--------	--------	----	---------	-----------------

AMM19654
B4 **SENSORE MASSA ARIA**
AIR MASS SENSOR

FORD
FIESTA V (JH_, JD_)

1.6 TDCi	Diesel	66	11/04 → 06/08	ENGINE: DURATORQ16TDCI
----------	--------	----	---------------	---------------------------

FOCUS C-MAX

1.6 TDCi	Diesel	66	02/05 → 03/07	ENGINE: DURATORQ16TDCI
----------	--------	----	---------------	---------------------------

1.6 TDCi	Diesel	80	10/03 → 03/07	ENGINE: DURATORQ16TDCI
----------	--------	----	---------------	---------------------------

FOCUS II (DA_)

1.6 TDCi	Diesel	80	11/04 →	ENGINE: DURATORQ16TDCI
----------	--------	----	---------	---------------------------

FUSION (JU_)

1.6 TDCi	Diesel	66	11/04 →	ENGINE: DURATORQ16TDCI
----------	--------	----	---------	---------------------------

AMM19655
B4 **SENSORE MASSA ARIA**
AIR MASS SENSOR

FORD
FOCUS II Station wagon (DA_)

1.8 TDCi	Diesel	85	11/04 →	
----------	--------	----	---------	--

FOCUS II Tre volumi (DA_)

1.8 TDCi	Diesel	85	04/05 →	
----------	--------	----	---------	--

AMM19656

B4 **SENSORE MASSA ARIA**
AIR MASS SENSOR



CITROËN

JUMPER Autobus

2.2 HDi 100	Diesel	74	04/06 →	
2.2 HDi 120	Diesel	88	04/06 →	
2.2 HDi 130	Diesel	96	07/11 →	

JUMPER Furgonato

2.2 HDi 100	Diesel	74	04/06 →	
2.2 HDi 120	Diesel	88	04/06 →	
2.2 HDi 130	Diesel	96	07/11 →	

JUMPER Pianale piatto/Telaio

2.2 HDi 100	Diesel	74	04/06 →	
2.2 HDi 120	Diesel	88	04/06 →	
2.2 HDi 130	Diesel	96	07/11 →	

FIAT

DUCATO Autobus (250)

100 Multijet 2,2 D	Diesel	74	07/06 →	
--------------------	--------	----	---------	--

DUCATO Furgonato (250)

100 Multijet 2,2 D	Diesel	74	07/06 →	
--------------------	--------	----	---------	--

DUCATO Pianale piatto/Telaio (250)

100 Multijet 2,2 D	Diesel	74	07/06 →	
--------------------	--------	----	---------	--

FORD

GALAXY (WA6)

1.8 TDCi	Diesel	74	05/06 →	
1.8 TDCi	Diesel	92	05/06 →	
2.0 TDCi	Diesel	103	05/06 →	
2.0 TDCi	Diesel	85	11/07 →	
2.0 TDCi	Diesel	96	05/06 →	

MONDEO IV (BA7)

1.8 TDCi	Diesel	74	03/07 →	
2.0 TDCi	Diesel	103	03/07 →	
2.0 TDCi	Diesel	85	11/07 →	
2.0 TDCi	Diesel	96	03/07 →	
2.2 TDCi	Diesel	129	03/08 →	

AMM19656



FORD

MONDEO IV Tre volumi (BA7)

2.0 TDCi	Diesel	103	03/07 →	
2.0 TDCi	Diesel	85	11/07 →	
2.0 TDCi	Diesel	96	03/07 →	
2.2 TDCi	Diesel	129	03/08 →	

MONDEO IV Turnier (BA7)

1.8 TDCi	Diesel	74	03/07 →	
2.0 TDCi	Diesel	103	03/07 →	
2.0 TDCi	Diesel	85	11/07 →	
2.0 TDCi	Diesel	96	03/07 →	
2.2 TDCi	Diesel	129	03/08 →	

S-MAX (WA6)

1.8 TDCi	Diesel	92	05/06 →	
2.0 TDCi	Diesel	103	05/06 →	
2.0 TDCi	Diesel	85	11/07 →	
2.0 TDCi	Diesel	96	05/06 →	

TOURNEO CONNECT

1.8 Di	Diesel	55	08/06 →	
1.8 TDCi	Diesel	81	08/06 →	
1.8 Turbo Di	Diesel	66	08/06 →	

TRANSIT Autobus

2.2 TDCi	Diesel	103	10/07 →	
2.2 TDCi	Diesel	63	04/06 →	
2.2 TDCi	Diesel	81	04/06 →	
2.2 TDCi	Diesel	96	04/06 →	
2.4 TDCi	Diesel	74	04/06 →	
2.4 TDCi	Diesel	85	04/06 →	
2.4 TDCi 4x4	Diesel	103	11/06 →	
3.2 TDCi	Diesel	147	02/08 →	

TRANSIT CONNECT (P65_, P70_, P80_)

1.8 Di	Diesel	55	08/06 →	
1.8 TDCi	Diesel	66	06/02 →	ENGINE: DURATORQ18TDCI
1.8 TDCi	Diesel	81	08/06 →	ENGINE: DURATORQ18TDCI

TRANSIT Furgonato

2.2 TDCi	Diesel	103	10/07 →	
2.2 TDCi	Diesel	63	04/06 →	
2.2 TDCi	Diesel	81	04/06 →	
2.2 TDCi	Diesel	96	04/06 →	
2.4 TDCi	Diesel	74	04/06 →	
2.4 TDCi	Diesel	85	04/06 →	
2.4 TDCi 4x4	Diesel	103	11/06 →	
3.2 TDCi	Diesel	147	09/07 →	

AMM19656

FORD
TRANSIT Pianale piatto/Telaio

2.2 TDCi	Diesel	103	10/07 →
2.2 TDCi	Diesel	63	04/06 →
2.2 TDCi	Diesel	81	04/06 →
2.2 TDCi	Diesel	96	04/06 →
2.4 TDCi	Diesel	74	04/06 →
2.4 TDCi	Diesel	85	04/06 →
2.4 TDCi 4x4	Diesel	103	11/06 →
3.2 TDCi	Diesel	147	09/07 →

TRANSIT TOURNEO

2.2 TDCi	Diesel	103	10/07 →
2.2 TDCi	Diesel	81	07/06 →
2.2 TDCi	Diesel	96	07/06 →

LAND ROVER
DEFENDER Cabrio (LD)

2.2 Td4	Diesel	90	08/11 →
2.4 Td4 4x4	Diesel	90	05/07 →

DEFENDER Pick-up (LD_)

2.2 Td4	Diesel	90	08/11 →
2.4 Td4 4x4	Diesel	90	05/07 →

DEFENDER Station Wagon (LD)

2.2 Td4	Diesel	90	08/11 →
2.4 Td4 4x4	Diesel	90	05/07 →

FREELANDER 2 (FA_)

2.2 Td4 4x4	Diesel	110	10/06 →
2.2 Td4 4x4	Diesel	112	01/07 →
2.2 Td4 4x4	Diesel	115	10/06 →
2.2 Td4 4x4	Diesel	118	10/06 →

PEUGEOT
BOXER Autobus

2.2 HDi 100	Diesel	74	04/06 →
2.2 HDi 120	Diesel	88	04/06 →
2.2 HDi 130	Diesel	96	03/11 →

BOXER Furgonato

2.2 HDi 100	Diesel	74	04/06 →
2.2 HDi 120	Diesel	88	04/06 →
2.2 HDi 130	Diesel	96	03/11 →

BOXER Pianale piatto/Telaio

2.2 HDi 100	Diesel	74	04/06 →
2.2 HDi 120	Diesel	88	04/06 →
2.2 HDi 130	Diesel	96	03/11 →

AMM19656

VOLVO
S80 II (AS)

2.0 TDi	Diesel	100	02/08 →
---------	--------	-----	---------

V70 III (BW)

2.0 D	Diesel	100	10/07 →
-------	--------	-----	---------

AMM19657
B4 **SENSORE MASSA ARIA**
AIR MASS SENSOR

FORD
ESCORT CLASSIC (AAL, ABL)

1.8 TD	Diesel	66	10/98 → 07/00
--------	--------	----	---------------

ESCORT CLASSIC Turnier (ANL)

1.8 TD	Diesel	66	02/99 → 07/00
--------	--------	----	---------------

ESCORT VII (GAL, AAL, ABL)

1.8 16V	Petrol	85	01/95 → 10/98	ENGINE: ZETEC-E
1.8 TD	Diesel	66	01/95 → 10/98	ENGINE: DIESEL18TI

ESCORT VII Cabriolet (ALL)

1.8 16V XR3i	Petrol	85	10/95 → 08/98	ENGINE: ZETEC-E
1.8 TD	Diesel	66	09/95 → 08/98	

ESCORT VII Station wagon (GAL, ANL)

1.8 16V	Petrol	85	01/95 → 02/99	ENGINE: ZETEC-E
1.8 TD	Diesel	66	01/95 → 02/99	ENGINE: DIESEL18TI

ESCORT VII Tre volumi (GAL, AFL)

1.8 16V	Petrol	85	01/95 → 02/99	ENGINE: ZETEC-E
1.8 TD	Diesel	66	01/95 → 02/99	ENGINE: DIESEL18TI

MONDEO I (GBP)

1.8 i 16V	Petrol	82	07/94 → 08/96	ENGINE: ZETEC-E
1.8 i 16V	Petrol	85	02/93 → 08/96	ENGINE: ZETEC-E
1.8 i 16V 4x4	Petrol	85	02/93 → 08/96	ENGINE: ZETEC-E
1.8 TD	Diesel	65	06/93 → 08/96	ENGINE: DIESEL18TI
1.8 TD	Diesel	66	10/95 → 08/96	ENGINE: DIESEL18TI

AMM19657



FORD

MONDEO I Station wagon (BNP)

1.8 i 16V	Petrol	82	07/94 → 08/96	ENGINE: ZETEC-E
1.8 i 16V	Petrol	85	04/93 → 08/96	ENGINE: ZETEC-E
1.8 i 16V 4x4	Petrol	85	04/93 → 08/96	ENGINE: ZETEC-E
1.8 TD	Diesel	65	06/93 → 08/96	ENGINE: DIESEL18TI
1.8 TD	Diesel	66	11/95 → 08/96	ENGINE: DIESEL18TI

MONDEO I Tre volumi (GBP)

1.8 i 16V	Petrol	82	01/94 → 08/96	ENGINE: ZETEC-E
1.8 i 16V	Petrol	85	02/93 → 08/96	ENGINE: ZETEC-E
1.8 TD	Diesel	65	06/93 → 08/96	ENGINE: DIESEL18TI
1.8 TD	Diesel	66	10/95 → 08/96	ENGINE: DIESEL18TI

SCORPIO II (GFR, GGR)

2.0 i	Petrol	85	10/94 → 08/98	ENGINE: DOHC20
2.0 i 16V	Petrol	100	10/94 → 08/98	

SCORPIO II Station wagon (GNR, GGR)

2.0 i	Petrol	85	10/94 → 08/98	
2.0 i 16V	Petrol	100	10/94 → 08/98	

TRANSIT Furgonato (E_ _)

2.0 (EAL, EAS)	Petrol	84	06/94 → 03/00	
----------------	--------	----	---------------	--

TRANSIT Pianale piatto/Telaio (E_ _)

2.0 (EME/L/S, ENE/L/S)	Petrol	84	08/94 → 03/00	
------------------------	--------	----	---------------	--

AMM19664



FORD

MONDEO III Station wagon (BWY)

2.0 16V TDDi / TDCi	Diesel	85	11/00 → 08/07	ENGINE: DURATORQ20TDCI
2.0 TDCi	Diesel	96	10/01 → 08/07	ENGINE: DURATORQ20TDCI

MONDEO III Tre volumi (B4Y)

2.0 16V TDDi / TDCi	Diesel	85	11/00 → 08/07	ENGINE: DURATORQ20TDCI
2.0 TDCi	Diesel	96	10/01 → 08/07	ENGINE: DURATORQ20TDCI

TRANSIT Autobus (FD_ _ , FB_ _ , FS_ _ , FZ_ _ , FC_ _)

2.0 TDCi (F_F_ , F_E_ , F_G_)	Diesel	92	08/02 → 05/06	ENGINE: DURATORQ20TDCI
--------------------------------	--------	----	---------------	------------------------

TRANSIT Furgonato (FA_ _)

2.0 TDCi	Diesel	92	08/02 → 05/06	ENGINE: DURATORQ20TDCI
----------	--------	----	---------------	------------------------

TRANSIT Pianale piatto/Telaio (FM_ _ , FN_ _)

2.0 TDCi (F_E_ , F_F_)	Diesel	92	08/02 → 05/06	ENGINE: DURATORQ20TDCI
-------------------------	--------	----	---------------	------------------------

AMM19665

**B4 SENSORE MASSA ARIA
AIR MASS SENSOR**

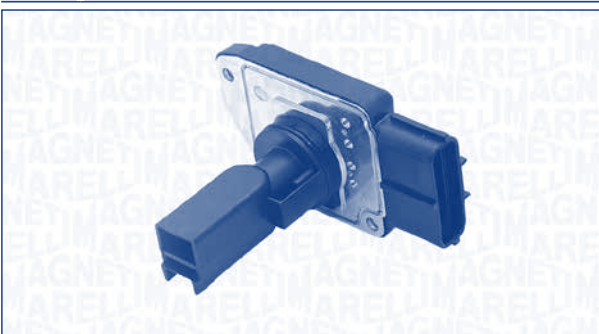

FORD

MONDEO III (B5Y)

2.2 TDCi	Diesel	114	09/04 → 08/07	ENGINE: DURATORQ22TDCI
----------	--------	-----	---------------	------------------------

MONDEO III Station wagon (BWY)

2.2 TDCi	Diesel	114	09/04 → 08/07	ENGINE: DURATORQ22TDCI
----------	--------	-----	---------------	------------------------

MONDEO III Tre volumi (B4Y)

2.2 TDCi	Diesel	114	09/04 → 08/07	ENGINE: DURATORQ22TDCI
----------	--------	-----	---------------	------------------------

AMM19664

**B4 SENSORE MASSA ARIA
AIR MASS SENSOR**



FORD

MONDEO III (B5Y)

2.0 16V TDDi / TDCi	Diesel	85	11/00 → 08/07	ENGINE: DURATORQ20TDCI
2.0 TDCi	Diesel	96	10/01 → 08/07	ENGINE: DURATORQ20TDCI

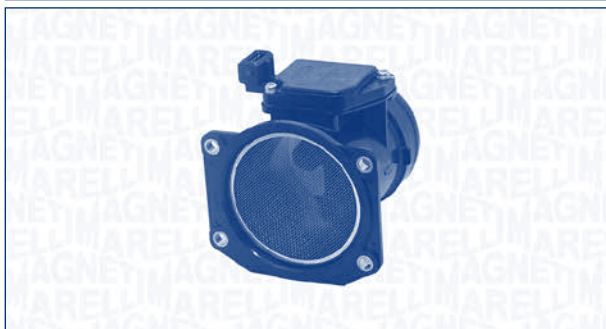
AMM19666
B4 **SENSORE MASSA ARIA**
AIR MASS SENSOR

AUDI
A4 (8D2, B5)

1.6	Petrol	74	07/96 → 12/97
1.8	Petrol	85	07/97 → 12/98
1.8	Petrol	92	07/96 → 04/99
1.8 quattro	Petrol	92	07/96 → 04/99

A4 Avant (8D5, B5)

1.6	Petrol	74	07/96 → 12/97
1.8	Petrol	85	07/96 → 12/98
1.8	Petrol	92	07/96 → 12/98
1.8 quattro	Petrol	85	07/96 → 04/99
1.8 quattro	Petrol	92	07/96 → 04/99

A6 (4B2, C5)

1.8	Petrol	85	05/97 → 05/00
1.8	Petrol	92	12/97 → 01/05

A6 Avant (4B5, C5)

1.8	Petrol	85	02/98 → 05/00
1.8	Petrol	92	12/97 → 01/05

VOLKSWAGEN
PASSAT (3B2)

1.8 Syncro / 4motion	Petrol	92	10/96 → 01/99
----------------------	--------	----	---------------

PASSAT Variant (3B5)

1.8 Syncro / 4motion	Petrol	92	06/97 → 01/99
----------------------	--------	----	---------------

AMM19667
B4 **SENSORE MASSA ARIA**
AIR MASS SENSOR

AUDI
A4 (8D2, B5)

2.4	Petrol	121	03/97 → 07/97
2.4 quattro	Petrol	121	03/97 → 07/97
2.8	Petrol	142	04/97 → 12/98
2.8 quattro	Petrol	142	04/97 → 12/98

A4 Avant (8D5, B5)

2.4	Petrol	120	08/97 → 07/98
2.4	Petrol	121	08/97 → 07/98
2.4 quattro	Petrol	121	08/97 → 07/98
2.8	Petrol	142	04/97 → 12/98
2.8 quattro	Petrol	142	04/97 → 12/98

A6 (4B2, C5)

2.4	Petrol	115	08/98 → 07/99
2.4	Petrol	120	05/97 → 01/05
2.4	Petrol	121	04/97 → 01/99
2.4 quattro	Petrol	120	05/97 → 01/05
2.4 quattro	Petrol	121	04/97 → 01/99
2.8	Petrol	132	04/98 → 07/98
2.8	Petrol	142	04/97 → 12/98
2.8 quattro	Petrol	142	04/97 → 12/98

A6 Avant (4B5, C5)

2.4	Petrol	115	08/98 → 07/99
2.4	Petrol	120	12/97 → 01/99
2.4	Petrol	121	12/97 → 01/99
2.4 quattro	Petrol	120	12/97 → 01/99
2.4 quattro	Petrol	121	12/97 → 01/99
2.8	Petrol	132	04/98 → 07/98
2.8	Petrol	142	12/97 → 12/98
2.8 quattro	Petrol	142	12/97 → 12/98

AMM19669

B4 **SENSORE MASSA ARIA**
AIR MASS SENSOR



AUDI

100 (4A, C4)

2.8 E	Petrol	128	12/90 → 06/94
2.8 E quattro	Petrol	128	12/90 → 06/94

100 Avant (4A, C4)

2.8 E	Petrol	128	09/91 → 06/94
2.8 E quattro	Petrol	128	09/91 → 06/94

80 (8C, B4)

2.8	Petrol	128	09/91 → 12/94
2.8 quattro	Petrol	128	09/91 → 12/94

80 Avant (8C, B4)

2.8	Petrol	128	09/91 → 01/96
2.8 quattro	Petrol	128	08/92 → 07/95

A4 (8D2, B5)

2.8	Petrol	128	09/95 → 07/97
2.8	Petrol	142	10/96 → 11/00
2.8 quattro	Petrol	128	01/95 → 07/97
2.8 quattro	Petrol	142	10/96 → 11/00

A4 Avant (8D5, B5)

2.8	Petrol	128	03/96 → 09/96
2.8	Petrol	142	10/96 → 09/01
2.8 quattro	Petrol	128	01/96 → 09/96
2.8 quattro	Petrol	142	10/96 → 09/01

A6 (4A, C4)

2.8	Petrol	128	06/94 → 02/97
2.8	Petrol	142	12/95 → 02/97
2.8 quattro	Petrol	128	06/94 → 02/97
2.8 quattro	Petrol	142	12/95 → 02/97

A6 Avant (4A, C4)

2.8	Petrol	128	06/94 → 12/97
2.8	Petrol	142	12/95 → 12/97
2.8 quattro	Petrol	128	06/94 → 12/97
2.8 quattro	Petrol	142	12/95 → 12/97

AMM19669



AUDI

A8 (4D2, 4D8)

2.8	Petrol	120	07/95 → 03/96
2.8	Petrol	128	03/94 → 03/96
2.8	Petrol	142	04/96 → 09/02
2.8 quattro	Petrol	120	07/95 → 03/96
2.8 quattro	Petrol	128	03/94 → 03/96
2.8 quattro	Petrol	142	04/96 → 09/02

CABRIOLET (8G7, B4)

2.6	Petrol	102	05/95 → 08/00
2.6	Petrol	110	06/93 → 08/00
2.8	Petrol	128	11/92 → 08/00

COUPE (89, 8B)

2.8	Petrol	128	09/91 → 12/96
2.8 quattro	Petrol	128	08/91 → 12/96

AMM19670

B4 **SENSORE MASSA ARIA**
AIR MASS SENSOR

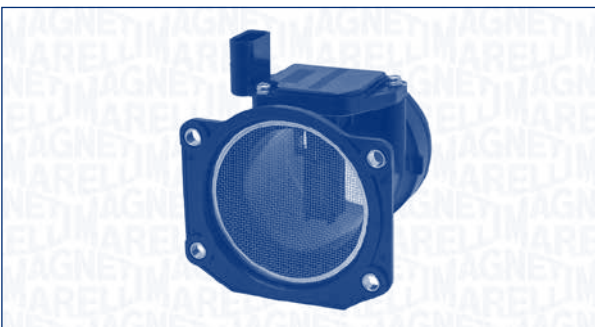

AUDI

A3 (8L1)

1.6	Petrol	75	08/00 → 05/03
-----	--------	----	---------------

A4 (8D2, B5)

1.6	Petrol	74	01/98 → 12/98
-----	--------	----	---------------

A4 Avant (8D5, B5)

1.6	Petrol	74	01/98 → 12/98
-----	--------	----	---------------

SEAT

CORDOBA (6K2)

1.6	Petrol	74	06/99 → 10/00
-----	--------	----	---------------

CORDOBA Vario (6K5)

1.6	Petrol	74	06/99 → 12/02
-----	--------	----	---------------

IBIZA III (6K1)

1.6	Petrol	74	08/99 → 02/02
-----	--------	----	---------------

LEON (1M1)

1.6	Petrol	74	11/99 → 06/06
-----	--------	----	---------------

AMM19670

SEAT
TOLEDO II (1M2)

1.6 Petrol 74 04/99 → 09/00

SKODA
OCTAVIA Combi (1U5)

1.6 Petrol 74 07/98 → 12/07

VOLKSWAGEN
BORA (1J2)

1.6 Petrol 74 10/98 → 05/00

1.6 Petrol 75 08/00 → 05/05

BORA Station wagon (1J6)

1.6 Petrol 74 05/99 → 05/00

1.6 Petrol 75 08/00 → 05/05

GOLF IV (1J1)

1.6 Petrol 74 08/97 → 02/00

1.6 Petrol 75 08/00 → 06/05

GOLF IV Variant (1J5)

1.6 Petrol 74 05/99 → 02/00

1.6 Petrol 75 08/00 → 06/06

NEW BEETLE (9C1, 1C1)

1.6 Petrol 75 06/00 → 09/10

PASSAT (3B3)

1.6 Petrol 75 11/00 → 05/05

2.0 Petrol 85 11/00 → 05/05

2.0 4motion Petrol 85 11/00 → 05/05

PASSAT Variant (3B6)

1.6 Petrol 75 11/00 → 05/05

2.0 Petrol 85 11/00 → 05/05

2.0 4motion Petrol 85 11/00 → 05/05

POLO CLASSIC (6KV2)

100 1.6 Petrol 74 10/99 → 09/01

POLO Variant (6KV5)

1.6 Petrol 74 10/99 → 09/01

TRANSPORTER IV Furgonato (70XA)

2.5 Syncro Petrol 85 05/99 → 04/03

TRANSPORTER IV Pianale piatto/Telaio (70XD)

2.5 Petrol 85 05/99 → 04/03

2.5 Syncro Petrol 85 05/99 → 04/03

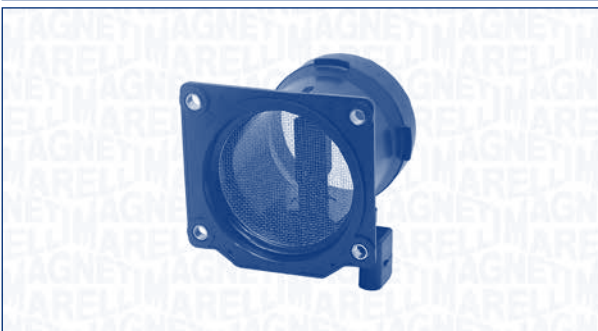
AMM19671
B4 **SENSORE MASSA ARIA**
AIR MASS SENSOR

AUDI
A4 (8D2, B5)

2.4 Petrol 120 08/97 → 11/00

2.4 Petrol 121 08/98 → 11/00

2.4 quattro Petrol 120 08/97 → 11/00

2.4 quattro Petrol 121 08/98 → 11/00

2.8 Petrol 142 07/98 → 11/00

2.8 quattro Petrol 142 07/98 → 11/00

A4 (8E2, B6)

2.4 Petrol 125 09/01 → 12/04

A4 Avant (8D5, B5)

2.4 Petrol 120 07/98 → 09/01

2.4 Petrol 121 08/98 → 09/01

2.4 quattro Petrol 120 08/98 → 09/01

2.4 quattro Petrol 121 08/98 → 09/01

2.8 Petrol 142 07/98 → 09/01

2.8 quattro Petrol 142 07/98 → 09/01

A4 Avant (8E5, B6)

2.4 Petrol 125 09/01 → 12/04

A4 Cabriolet (8H7, B6, 8HE, B7)

2.4 Petrol 120 04/02 → 12/05

2.4 Petrol 125 04/02 → 12/05

A6 (4B2, C5)

2.4 Petrol 100 02/99 → 01/05

2.4 Petrol 120 11/98 → 05/00

2.4 Petrol 121 11/98 → 06/00

2.4 Petrol 125 08/01 → 01/05

2.4 quattro Petrol 120 11/98 → 05/00

2.4 quattro Petrol 121 11/98 → 06/00

2.4 quattro Petrol 125 08/01 → 01/05

2.8 Petrol 140 07/99 → 06/01

2.8 Petrol 142 11/98 → 06/01

2.8 quattro Petrol 142 11/98 → 06/01

AMM19671



AUDI

A6 Avant (4B5, C5)

2.4	Petrol	100	02/99 → 01/05
2.4	Petrol	120	11/98 → 05/00
2.4	Petrol	121	11/98 → 06/01
2.4	Petrol	125	08/01 → 01/05
2.4 quattro	Petrol	120	11/98 → 05/00
2.4 quattro	Petrol	121	11/98 → 06/01
2.4 quattro	Petrol	125	08/01 → 01/05
2.8	Petrol	140	07/99 → 06/01
2.8	Petrol	142	11/98 → 06/01
2.8 quattro	Petrol	142	11/98 → 06/01

A8 (4D2, 4D8)

2.8	Petrol	142	01/99 → 09/02
2.8 quattro	Petrol	142	01/99 → 04/99

SKODA

SUPERB (3U4)

2.8 V6	Petrol	142	01/02 → 03/08
--------	--------	-----	---------------

VOLKSWAGEN

PASSAT (3B3)

2.8 4motion	Petrol	142	11/00 → 05/05
-------------	--------	-----	---------------

PASSAT Variant (3B5)

2.8 V6 Syncro/4motion	Petrol	142	01/99 → 11/00
-----------------------	--------	-----	---------------

PASSAT Variant (3B6)

2.8 4motion	Petrol	142	11/00 → 05/05
-------------	--------	-----	---------------

AMM19672

B4 **SENSORE MASSA ARIA**
AIR MASS SENSOR

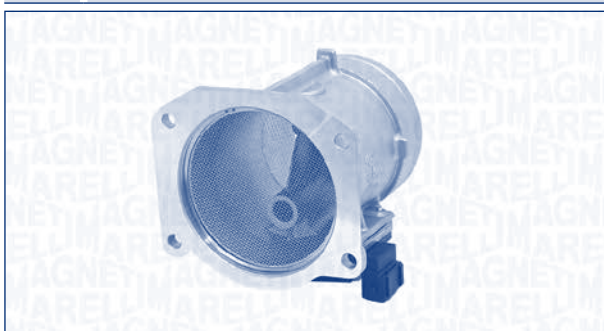

AUDI

A4 (8D2, B5)

1.6	Petrol	74	12/94 → 10/96
1.8	Petrol	92	01/95 → 06/97
1.8 quattro	Petrol	85	07/95 → 06/97

AMM19672



AUDI

A4 (8D2, B5)

1.8 quattro	Petrol	92	01/95 → 06/97
-------------	--------	----	---------------

A4 Avant (8D5, B5)

1.6	Petrol	74	02/96 → 10/96
1.8	Petrol	92	02/96 → 06/97
1.8 quattro	Petrol	85	07/95 → 09/01
1.8 quattro	Petrol	92	01/96 → 09/01

A6 (4A, C4)

1.8	Petrol	92	12/95 → 02/97
1.8 quattro	Petrol	92	12/95 → 02/97

A6 Avant (4A, C4)

1.8	Petrol	92	12/95 → 12/97
1.8 quattro	Petrol	92	12/95 → 12/97

SEAT

CORDOBA (6K1, 6K2)

2.0 i	Petrol	85	02/93 → 06/99
-------	--------	----	---------------

IBIZA II (6K1)

2.0 i	Petrol	85	04/96 → 08/99
-------	--------	----	---------------

TOLEDO I (1L)

2.0 i	Petrol	85	09/96 → 03/99
-------	--------	----	---------------

VOLKSWAGEN

CORRADO (53I)

2.0 i	Petrol	85	07/94 → 07/95
-------	--------	----	---------------

GOLF III (1H1)

1.6	Petrol	74	01/96 → 08/97
2.0	Petrol	85	10/94 → 08/97
2.0 Syncro (1HX1)	Petrol	85	08/95 → 08/97

GOLF III Cabriolet (1E7)

1.6	Petrol	74	12/95 → 05/98
2.0	Petrol	85	07/93 → 05/98

GOLF III Variant (1H5)

1.6	Petrol	74	01/96 → 04/99
2.0	Petrol	85	10/94 → 04/99
2.0 Syncro	Petrol	85	08/95 → 04/99

GOLF IV Cabriolet (1E7)

1.6	Petrol	74	06/98 → 06/02
2.0	Petrol	85	06/98 → 06/02

PASSAT (3A2, 35I)

1.6	Petrol	74	12/95 → 08/96
2.0	Petrol	79	03/95 → 08/96
2.0	Petrol	85	10/94 → 08/96

AMM19672

VOLKSWAGEN
PASSAT Variant (3A5, 35I)

1.6	Petrol	74	07/94 → 12/95
2.0	Petrol	79	03/95 → 08/96
2.0	Petrol	85	10/94 → 05/97

POLO CLASSIC (6KV2)

100 1.6	Petrol	74	12/95 → 05/98
---------	--------	----	---------------

POLO Variant (6KV5)

1.6	Petrol	74	05/97 → 05/98
-----	--------	----	---------------

SHARAN (7M8, 7M9, 7M6)

2.0	Petrol	85	09/95 → 02/00
-----	--------	----	---------------

VENTO (1H2)

2.0	Petrol	85	10/94 → 07/95
-----	--------	----	---------------

AMM19674
B4 **SENSORE MASSA ARIA**
AIR MASS SENSOR

AUDI
A4 (8E2, B6)

3.0	Petrol	160	04/01 → 12/04
3.0	Petrol	162	11/00 → 12/04

A4 Avant (8E5, B6)

3.0	Petrol	160	04/01 → 12/04
3.0	Petrol	162	09/01 → 12/04
3.0 quattro	Petrol	160	04/01 → 12/04
3.0 quattro	Petrol	162	09/01 → 12/04

A6 (4B2, C5)

3.0	Petrol	162	08/01 → 01/05
-----	--------	-----	---------------

A6 Avant (4B5, C5)

3.0	Petrol	162	08/01 → 01/05
-----	--------	-----	---------------

ALLROAD (4BH, C5)

2.7 T quattro	Petrol	184	05/00 → 08/05
---------------	--------	-----	---------------

AMM19752
B4 **SENSORE MASSA ARIA**
AIR MASS SENSOR

AUDI
A3 (8L1)

1.9 TDI	Diesel	96	08/00 → 05/03
1.9 TDI quattro	Diesel	96	08/00 → 05/03

A3 (8P1)

2.0	Petrol	120	06/06 → 08/12
2.0 TDi	Diesel	100	05/03 → 08/12
2.0 TDi	Diesel	103	06/05 → 06/08
2.0 TDi	Diesel	125	03/06 → 08/12
2.0 TDI 16V	Diesel	103	05/03 → 08/12
2.0 TDI 16V quattro	Diesel	103	08/04 → 08/12
2.0 TDI quattro	Diesel	100	05/03 → 06/08
2.0 TDI quattro	Diesel	103	01/06 → 06/08
2.0 TDI quattro	Diesel	125	03/06 → 08/12

A3 Sportback (8PA)

2.0	Petrol	120	06/06 → 03/13
2.0 TDi	Diesel	100	09/04 → 03/13
2.0 TDi	Diesel	103	06/05 → 06/08
2.0 TDi	Diesel	125	03/06 → 03/13
2.0 TDI 16V	Diesel	103	09/04 → 03/13
2.0 TDI quattro	Diesel	103	01/06 → 06/08
2.0 TDI quattro	Diesel	125	03/06 → 03/13

A4 (8E2, B6)

1.9 TDI	Diesel	85	06/04 → 12/04
1.9 TDI	Diesel	96	11/00 → 12/04
1.9 TDI quattro	Diesel	96	11/01 → 12/04
2.0 TDi	Diesel	93	10/05 → 10/07

A4 (8EC, B7)

1.9 TDI	Diesel	85	11/04 → 06/08
2.0 TDi	Diesel	100	11/04 → 06/08
2.0 TDi	Diesel	103	11/04 → 06/08
2.0 TDi	Diesel	120	06/06 → 06/08
2.0 TDi	Diesel	125	06/06 → 06/08
2.0 TDi	Diesel	89	09/05 → 09/06

AMM19752



KW



AUDI

A4 (8EC, B7)

2.0 TDi	Diesel	93	11/05 → 11/06
2.0 TDI 16V	Diesel	103	11/04 → 06/08
2.0 TDI quattro	Diesel	103	01/06 → 06/08
2.0 TDI quattro	Diesel	120	06/06 → 06/08
2.0 TDI quattro	Diesel	125	06/06 → 06/08

A4 Avant (8E5, B6)

1.9 TDI	Diesel	85	06/04 → 12/04
1.9 TDI	Diesel	96	09/01 → 12/04
1.9 TDI quattro	Diesel	96	11/01 → 12/04

A4 Avant (8ED, B7)

1.9 TDI	Diesel	85	11/04 → 06/08
2.0 TDi	Diesel	100	11/04 → 06/08
2.0 TDi	Diesel	103	11/04 → 06/08
2.0 TDi	Diesel	120	06/06 → 06/08
2.0 TDi	Diesel	125	06/06 → 06/08
2.0 TDi	Diesel	89	09/05 → 09/06
2.0 TDi	Diesel	93	11/05 → 11/06
2.0 TDI 16V	Diesel	103	11/04 → 06/08
2.0 TDI quattro	Diesel	103	01/06 → 06/08
2.0 TDI quattro	Diesel	120	06/06 → 06/08
2.0 TDI quattro	Diesel	125	06/06 → 06/08

A4 Cabriolet (8H7, B6, 8HE, B7)

2.0 TDi	Diesel	100	01/06 → 03/09
2.0 TDi	Diesel	103	01/06 → 03/09

A6 (4B2, C5)

1.9 TDI	Diesel	96	08/01 → 01/05
---------	--------	----	---------------

A6 (4F2, C6)

2.0 TDi	Diesel	100	05/05 → 03/11
2.0 TDi	Diesel	103	07/04 → 10/08
2.0 TDi	Diesel	89	09/05 → 06/06

A6 Avant (4B5, C5)

1.9 TDI	Diesel	96	08/01 → 01/05
2.0 TDi	Diesel	100	06/05 → 08/11
2.0 TDi	Diesel	103	06/05 → 10/08
2.0 TDi	Diesel	89	09/05 → 06/06

FORD

GALAXY (WGR)

1.9 TDI	Diesel	110	05/05 → 05/06
1.9 TDI	Diesel	96	02/03 → 05/06

AMM19752



KW



SEAT

ALHAMBRA (7V8, 7V9)

1.9 TDI	Diesel	110	05/05 → 05/07
1.9 TDI	Diesel	96	11/02 → 11/08
1.9 Tdi 4x4	Diesel	96	06/05 → 11/08
2.0 TDi	Diesel	103	11/05 → 03/10

ALTEA (5P1)

2.0 TDi	Diesel	100	03/04 → 05/09
2.0 TDi	Diesel	103	11/05 →
2.0 TDi	Diesel	125	03/06 →
2.0 TDI 16V	Diesel	103	03/04 →

ALTEA XL (5P5, 5P8)

2.0 TDi	Diesel	100	11/06 → 03/09
2.0 TDi	Diesel	103	10/06 →
2.0 TDi	Diesel	125	06/07 →
2.0 TDI 16V	Diesel	103	10/06 →
2.0 TDI 4x4	Diesel	103	06/07 →
2.0 TDI 4x4	Diesel	125	06/07 →

CORDOBA (6L2)

1.9 TDI	Diesel	96	10/02 → 11/09
---------	--------	----	---------------

IBIZA IV (6L1)

1.9 TDI	Diesel	96	02/02 → 11/09
1.9 TDI Cupra R	Diesel	118	03/04 → 02/08

LEON (1M1)

1.9 TDI	Diesel	110	02/01 → 06/06
1.9 TDI	Diesel	96	05/03 → 06/06
1.9 TDI Syncro	Diesel	110	05/02 → 06/06

LEON (1P1)

2.0 D	Diesel	100	07/05 →
2.0 TDi	Diesel	100	09/05 → 05/10
2.0 TDi	Diesel	103	10/05 →
2.0 TDi	Diesel	125	05/06 →
2.0 TDI 16V	Diesel	103	07/05 →

TOLEDO II (1M2)

1.9 TDI	Diesel	96	05/03 → 05/06
---------	--------	----	---------------

TOLEDO III (5P2)

2.0 TDi	Diesel	100	09/04 → 05/09
2.0 TDi	Diesel	103	12/05 → 05/09
2.0 TDi	Diesel	125	01/06 → 05/09
2.0 TDI 16V	Diesel	103	09/04 → 05/09

SKODA

FABIA (6Y2)

1.9 TDI RS	Diesel	96	06/03 → 03/08
------------	--------	----	---------------

OCTAVIA (1U2)

1.9 TDI	Diesel	96	12/02 → 09/04
---------	--------	----	---------------

AMM19752

SKODA
OCTAVIA (1Z3)

2.0 TDi	Diesel	100	02/04 → 05/10
2.0 TDi	Diesel	103	11/05 →
2.0 TDi 16V	Diesel	103	02/04 →
2.0 TDi RS	Diesel	125	04/06 →

OCTAVIA Combi (1U5)

1.9 TDi	Diesel	96	12/02 → 09/04
---------	--------	----	---------------

OCTAVIA Combi (1Z5)

2.0 TDi	Diesel	103	11/05 →
2.0 TDi 16V	Diesel	100	02/04 → 05/10
2.0 TDi 16V	Diesel	103	02/04 →
2.0 TDi 4x4	Diesel	103	07/06 →
2.0 TDi RS	Diesel	125	04/06 →

SUPERB (3T4)

2.0 TDi	Diesel	103	06/08 →
---------	--------	-----	---------

SUPERB (3U4)

1.9 TDi	Diesel	77	10/05 → 05/07
1.9 TDi	Diesel	85	01/07 → 03/08
1.9 TDi	Diesel	96	01/02 → 03/08
2.0 TDi	Diesel	103	10/05 → 03/08

VOLKSWAGEN
BORA (1J2)

1.9 TDi	Diesel	110	05/00 → 05/05
1.9 TDi	Diesel	96	11/00 → 05/05
1.9 TDi 4motion	Diesel	110	05/00 → 05/05
1.9 TDi 4motion	Diesel	96	11/00 → 05/05

BORA Station wagon (1J6)

1.9 TDi	Diesel	110	05/01 → 05/05
1.9 TDi	Diesel	96	11/00 → 05/05
1.9 TDi 4motion	Diesel	110	05/01 → 05/05
1.9 TDi 4motion	Diesel	96	11/00 → 05/05

CADDY III Furgonato (2KA, 2KH, 2CA, 2CH)

2.0 TDi	Diesel	103	09/07 → 08/10
---------	--------	-----	---------------

CADDY III Station wagon (2KB, 2KJ, 2CB, 2CJ)

2.0 TDi	Diesel	103	09/07 → 08/10
---------	--------	-----	---------------

EOS (1F7, 1F8)

2.0 TDi	Diesel	103	06/06 → 05/08
---------	--------	-----	---------------

GOLF IV (1J1)

1.9 TDi	Diesel	110	05/00 → 06/05
1.9 TDi	Diesel	96	11/00 → 06/05
1.9 TDi 4motion	Diesel	110	02/00 → 06/05
1.9 TDi 4motion	Diesel	96	11/00 → 06/05

GOLF IV Variant (1J5)

1.9 TDi	Diesel	96	11/00 → 06/06
1.9 TDi 4motion	Diesel	96	11/00 → 06/06

AMM19752

VOLKSWAGEN
GOLF PLUS (5M1, 521)

2.0 TDi	Diesel	100	05/05 →
2.0 TDi 16V	Diesel	103	01/05 →

GOLF V (1K1)

2.0 TDi	Diesel	100	10/03 → 11/08
2.0 TDi	Diesel	103	12/04 → 11/08
2.0 TDi	Diesel	125	11/05 → 11/08
2.0 TDi 16V	Diesel	103	10/03 → 11/08
2.0 TDi 16V 4motion	Diesel	103	08/04 → 11/08
2.0 TDi 4motion	Diesel	103	08/04 → 11/08

GOLF V Variant (1K5)

2.0 TDi	Diesel	100	06/07 → 07/09
2.0 TDi	Diesel	103	06/07 → 07/09
2.0 TDi 16V	Diesel	103	06/07 → 07/09

JETTA III (1K2)

2.0 TDi	Diesel	100	09/05 → 10/10
2.0 TDi	Diesel	103	10/05 → 10/10
2.0 TDi	Diesel	125	10/06 → 10/10
2.0 TDi 16V	Diesel	103	08/05 → 10/10

LT 28-35 II Autobus (2DB, 2DE, 2DK)

2.8 TDi	Diesel	116	05/01 → 06/06
2.8 TDi	Diesel	92	02/97 → 12/98
2.8 TDi	Diesel	96	01/99 → 01/02

LT 28-46 II Furgonato (2DA, 2DD, 2DH)

2.8 TDi	Diesel	116	04/02 → 07/06
2.8 TDi	Diesel	116	05/03 → 06/06
2.8 TDi	Diesel	92	06/97 → 12/98
2.8 TDi	Diesel	96	01/99 → 07/06

LT 28-46 II Pianale piatto/Telaio (2DC, 2DF, 2DG, 2DL, 2DM)

2.8 TDi	Diesel	116	04/02 → 07/06
2.8 TDi	Diesel	92	06/97 → 12/98
2.8 TDi	Diesel	96	01/99 → 07/06

MULTIVAN V (7HM, 7HN, 7HF, 7EF, 7EM, 7EN)

2.5 TDi	Diesel	120	11/03 → 11/09
2.5 TDi	Diesel	128	04/03 → 11/09
2.5 TDi	Diesel	96	04/03 → 11/09
2.5 TDi 4motion	Diesel	128	07/04 → 11/09
2.5 TDi 4motion	Diesel	96	07/04 → 11/09

PASSAT (3B3)

1.9 TDi	Diesel	96	11/00 → 05/05
1.9 TDi 4motion	Diesel	96	11/00 → 05/05
2.0 TDi	Diesel	100	12/03 → 05/05

AMM19752



VOLKSWAGEN

PASSAT (3C2)

2.0 TDi	Diesel	100	03/05 → 11/10
2.0 TDi	Diesel	103	03/05 → 05/09
2.0 TDi	Diesel	120	08/05 → 05/09
2.0 TDi	Diesel	125	08/05 → 07/10
2.0 TDi	Diesel	88	11/05 → 05/06
2.0 TDi	Diesel	90	08/05 → 07/06
2.0 TDI 16V	Diesel	103	03/05 → 07/10
2.0 TDI 16V 4motion	Diesel	103	03/05 → 08/10
2.0 TDI 4motion	Diesel	103	03/05 → 05/09

PASSAT Variant (3B6)

1.9 TDI	Diesel	96	11/00 → 05/05
1.9 TDI 4motion	Diesel	96	11/00 → 05/05
2.0 TDi	Diesel	100	12/03 → 05/05

PASSAT Variant (3C5)

2.0 TDi	Diesel	100	08/05 → 11/10
2.0 TDi	Diesel	103	08/05 → 05/09
2.0 TDi	Diesel	120	08/05 → 05/09
2.0 TDi	Diesel	125	08/05 → 11/10
2.0 TDi	Diesel	90	08/05 → 02/06
2.0 TDI 16V	Diesel	103	08/05 → 11/10
2.0 TDI 16V 4motion	Diesel	103	08/05 → 11/10
2.0 TDI 4motion	Diesel	103	08/05 → 05/09

PHAETON (3D_)

5.0 V10 TDI 4motion	Diesel	230	11/02 →
---------------------	--------	-----	---------

POLO (9N_)

1.9 TDI	Diesel	96	11/03 → 11/09
---------	--------	----	---------------

SHARAN (7M8, 7M9, 7M6)

1.9 TDI	Diesel	110	06/05 → 03/10
1.9 TDI	Diesel	96	11/02 → 03/10
2.0 TDi	Diesel	103	11/05 → 03/10

TOUAREG (7LA, 7L6, 7L7)

2.5 R5 TDI	Diesel	120	08/03 → 05/10
2.5 R5 TDI	Diesel	128	01/03 → 05/10
5.0 R50 TDI	Diesel	257	10/07 → 05/10
5.0 V10 TDI	Diesel	230	10/02 → 05/10

TOURAN (1T1, 1T2)

2.0 TDi	Diesel	100	02/03 → 05/10
2.0 TDi	Diesel	103	12/05 → 05/10
2.0 TDi	Diesel	125	12/05 → 05/10
2.0 TDI 16V	Diesel	103	08/03 → 05/10

AMM19752



VOLKSWAGEN

TRANSPORTER IV Autobus (70XB, 70XC, 7DB, 7DW)

2.5 TDI	Diesel	111	05/98 → 04/03
---------	--------	-----	---------------

TRANSPORTER IV Furgonato (70XA)

2.5 TDI	Diesel	111	09/00 → 04/03
---------	--------	-----	---------------

TRANSPORTER V Autobus (7HB, 7HJ, 7EB, 7EJ, 7EF)

2.5 TDI	Diesel	120	11/03 → 11/09
2.5 TDI	Diesel	128	04/03 → 11/09
2.5 TDI	Diesel	96	04/03 → 11/09
2.5 TDI 4motion	Diesel	128	07/04 → 11/09
2.5 TDI 4motion	Diesel	96	07/04 → 11/09
2.5 TDI 4motion	Diesel	96	05/06 →

TRANSPORTER V Furgonato (7HA, 7HH, 7EA, 7EH)

2.5 TDI	Diesel	128	04/03 → 11/09
2.5 TDI	Diesel	96	04/03 → 11/09
2.5 TDI 4motion	Diesel	128	07/04 → 11/09
2.5 TDI 4motion	Diesel	128	05/06 →
2.5 TDI 4motion	Diesel	96	07/04 → 11/09
2.5 TDI 4motion	Diesel	96	05/06 →

TRANSPORTER V Pianale piatto/Telaio (7JD, 7JE, 7JL, 7JY, 7JZ)

2.5 TDI	Diesel	128	04/03 → 11/09
2.5 TDI	Diesel	96	04/03 → 11/09
2.5 TDI 4motion	Diesel	128	04/04 → 11/09
2.5 TDI 4motion	Diesel	96	07/04 → 11/09

AMM19764

B4 **SENSORE MASSA ARIA**
AIR MASS SENSOR

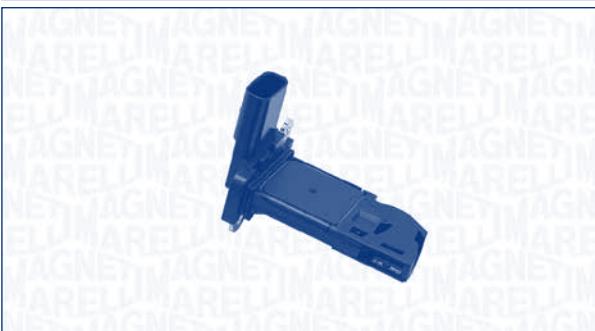

FORD

FOCUS C-MAX

1.6 TDCi	Diesel	66	02/05 → 03/07
1.6 TDCi	Diesel	80	10/03 → 03/07
1.8 TDCi	Diesel	85	01/05 → 03/07

AMM19764

FORD
FOCUS II (DA_)

1.6 TDCi	Diesel	80	11/04 →
----------	--------	----	---------

AMM19765

PEUGEOT
307 Break (3E)

1.4 HDi	Diesel	50	03/02 →
---------	--------	----	---------

AMM19765
B4 **SENSORE MASSA ARIA**
AIR MASS SENSOR

CITROËN
C2 (JM_)

1.4 HDi	Diesel	50	09/03 →
---------	--------	----	---------

C3 I (FC_)

1.4 HDi	Diesel	50	02/02 →
---------	--------	----	---------

C3 Pluriel (HB_)

1.4 HDi	Diesel	50	04/04 →
---------	--------	----	---------

XSARA (N1)

1.4 HDi	Diesel	50	01/03 → 03/05
---------	--------	----	---------------

XSARA Break (N2)

1.4 HDi	Diesel	50	01/03 → 08/05
---------	--------	----	---------------

XSARA Coupé (N0)

1.4 HDi	Diesel	50	01/03 → 03/05
---------	--------	----	---------------

FORD
FIESTA V (JH_, JD_)

1.4 TDCi	Diesel	50	11/01 → 06/08
----------	--------	----	---------------

FUSION (JU_)

1.4 TDCi	Diesel	50	08/02 →
----------	--------	----	---------

PEUGEOT
1007 (KM_)

1.4 HDi	Diesel	50	04/05 →
---------	--------	----	---------

206 2 volumi /Coda spiovente (2A/C)

1.4 HDi eco 70	Diesel	50	09/01 →
----------------	--------	----	---------

206 SW (2E/K)

1.4 HDi	Diesel	50	07/02 →
---------	--------	----	---------

307 (3A/C)

1.4 HDi	Diesel	50	10/01 →
---------	--------	----	---------

AMM19766
B4 **SENSORE MASSA ARIA**
AIR MASS SENSOR

FORD
ESCORT VI (GAL)

1.4	Petrol	55	01/94 → 01/95
-----	--------	----	---------------

1.6 i 16V	Petrol	65	01/94 → 01/95
-----------	--------	----	---------------

1.6 i 16V	Petrol	66	09/92 → 01/95
-----------	--------	----	---------------

ESCORT VI Cabriolet (ALL)

1.4 i	Petrol	55	07/93 → 01/95
-------	--------	----	---------------

1.6 16V XR3i	Petrol	66	12/92 → 01/95
--------------	--------	----	---------------

1.6 i 16V	Petrol	65	02/94 → 01/95
-----------	--------	----	---------------

ESCORT VI Station wagon (GAL)

1.4	Petrol	55	01/94 → 01/95
-----	--------	----	---------------

1.6 i 16V	Petrol	65	01/94 → 01/95
-----------	--------	----	---------------

1.6 i 16V	Petrol	66	09/92 → 01/95
-----------	--------	----	---------------

ESCORT VI Tre volumi (GAL)

1.4	Petrol	55	08/93 → 01/95
-----	--------	----	---------------

1.6 i 16V	Petrol	65	01/94 → 01/95
-----------	--------	----	---------------

1.6 i 16V	Petrol	66	08/93 → 01/95
-----------	--------	----	---------------

ESCORT VII (GAL, AAL, ABL)

1.4	Petrol	55	01/95 → 10/98
-----	--------	----	---------------

1.6 i 16V	Petrol	65	01/95 → 08/95
-----------	--------	----	---------------

ESCORT VII Cabriolet (ALL)

1.4	Petrol	55	02/95 → 08/98
-----	--------	----	---------------

1.6 16V XR3i	Petrol	65	02/95 → 12/96
--------------	--------	----	---------------

ESCORT VII Station wagon (GAL, ANL)

1.4	Petrol	55	01/95 → 02/99
-----	--------	----	---------------

1.6 i 16V	Petrol	65	01/95 → 08/95
-----------	--------	----	---------------

AMM19766



FORD

ESCORT VII Tre volumi (GAL, AFL)

1.4	Petrol	55	01/95 → 02/99
1.6 i 16V	Petrol	65	01/95 → 08/95

FIESTA III (GFJ)

1.4 Cat.	Petrol	54	03/89 → 12/95
1.6 i 16V	Petrol	65	01/94 → 12/95

ORION III (GAL)

1.6 i 16V	Petrol	66	07/92 → 12/93
-----------	--------	----	---------------

AMM19769

B4 **SENSORE MASSA ARIA**
AIR MASS SENSOR



AUDI

A4 (8E2, B6)

2.5 TDI	Diesel	114	08/01 → 07/02
2.5 TDI	Diesel	120	07/02 → 12/04
2.5 TDI quattro	Diesel	132	11/00 → 12/04

A4 Avant (8E5, B6)

2.5 TDI	Diesel	114	09/01 → 07/02
2.5 TDI	Diesel	120	07/02 → 12/04
2.5 TDI quattro	Diesel	132	09/01 → 12/04

A4 Cabriolet (8H7, B6, 8HE, B7)

2.5 TDI	Diesel	120	08/02 → 12/05
---------	--------	-----	---------------

A6 (4B2, C5)

2.5 TDI	Diesel	114	08/01 → 01/05
2.5 TDI	Diesel	120	07/02 → 01/05
2.5 TDI	Diesel	132	02/00 → 01/05
2.5 TDI quattro	Diesel	132	02/00 → 01/05

A6 Avant (4B5, C5)

2.5 TDI	Diesel	114	08/01 → 01/05
2.5 TDI	Diesel	120	07/02 → 01/05
2.5 TDI	Diesel	132	02/00 → 01/05
2.5 TDI quattro	Diesel	132	02/00 → 01/05

AMM19769



AUDI

A8 (4D2, 4D8)

2.5 TDI	Diesel	132	09/00 → 09/02
---------	--------	-----	---------------

ALLROAD (4BH, C5)

2.5 TDI quattro	Diesel	120	05/03 → 08/05
2.5 TDI quattro	Diesel	132	05/00 → 08/05

SKODA

SUPERB (3U4)

2.5 TDI	Diesel	114	12/01 → 08/03
2.5 TDI	Diesel	120	06/03 → 03/08

VOLKSWAGEN

PASSAT (3B3)

2.5 TDI	Diesel	110	11/00 → 05/05
2.5 TDI	Diesel	120	05/03 → 05/05
2.5 TDI 4motion	Diesel	110	11/00 → 05/05
2.5 TDI 4motion	Diesel	132	01/03 → 05/05

PASSAT Variant (3B6)

2.5 TDI	Diesel	110	11/00 → 05/05
2.5 TDI	Diesel	120	05/03 → 05/05
2.5 TDI 4motion	Diesel	110	11/00 → 05/05
2.5 TDI 4motion	Diesel	132	01/03 → 05/05

AMM19770

B4 **SENSORE MASSA ARIA**
AIR MASS SENSOR



FORD

FIESTA VI

1.4 TDCi	Diesel	50	01/09 →	ENGINE: F6JB
1.4 TDCi	Diesel	51	07/10 →	ENGINE: F6JD,KVJA

MONDEO IV Tre volumi (BA7)

1.6 Ti	Petrol	92	03/07 →	ENGINE: PNBA
--------	--------	----	---------	--------------

MAZDA

2 (DY)

1.4 CD	Diesel	50	04/03 →	ENGINE: F6JA,F6JB
--------	--------	----	---------	-------------------

AMM19770

VOLVO
S60 II

DRIVe / D2 Diesel 84 01/11 → ENGINE: D4162T

S80 II (AS)

1.6 DRIVe Diesel 84 06/11 → ENGINE: D4162T

V50 (MW)

1.6 D2 Diesel 84 01/10 → ENGINE: D4162T

V60

1.6 DRIVe Diesel 84 06/11 → ENGINE: D4162T

V70 III (BW)

1.6 DRIVe / D2 Diesel 84 06/11 → ENGINE: D4162T

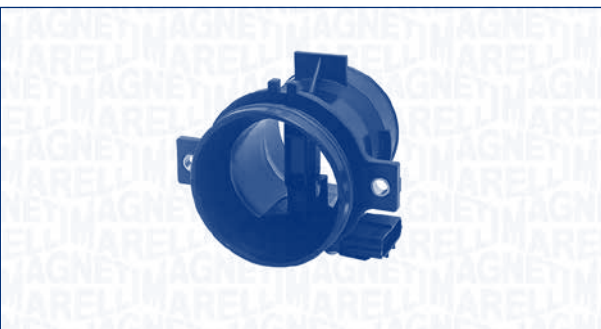
AMM19780
B4 **SENSORE MASSA ARIA**
AIR MASS SENSOR

FORD
COUGAR (EC_)

2.0 16V Petrol 96 08/98 → 12/01 ENGINE: EDDB, EDBC, EDBD

FOCUS (DAW, DBW)

1.8 16V Petrol 85 10/98 → 11/04 ENGINE: EYDC, EYDB, EYDD, EYDE, EYDF, EYDG, EYDI, EYDJ, EYDL

FOCUS (DAW, DBW)

2.0 16V Petrol 96 10/98 → 11/04 ENGINE: EDDC, EDDB, EDDD, EDDF

FOCUS C-MAX

1.8 Petrol 88 10/03 → 03/07 ENGINE: CSDB, CSDB

FOCUS Station wagon (DNW)

1.8 16V Petrol 85 02/99 → 11/04 ENGINE: EYDC, EYDB, EYDD, EYDE, EYDF, EYDG, EYDI, EYDJ, EYDL

AMM19780

FORD
FOCUS Station wagon (DNW)

2.0 16V Petrol 96 02/99 → 11/04 ENGINE: EDDC, EDDB, EDDD, EDDF

FOCUS Tre volumi (DFW)

1.8 16V Petrol 85 02/99 → 11/04 ENGINE: EYDC, EYDB, EYDD, EYDE, EYDF, EYDG, EYDI, EYDJ, EYDL

2.0 16V Petrol 96 02/99 → 11/04 ENGINE: EDDC, EDDB, EDDD, EDDF

MONDEO II (BAP)

1.6 i 16V Petrol 70 05/98 → 11/00 ENGINE: L1L, L1N, L1Q

MONDEO II Station wagon (BNP)

1.6 i 16V Petrol 70 05/98 → 11/00 ENGINE: L1L, L1N, L1Q

MONDEO II Tre volumi (BFP)

1.6 i 16V Petrol 70 05/98 → 11/00 ENGINE: L1L, L1N, L1Q

MONDEO III (B5Y)

1.8 16V Petrol 81 11/00 → 08/07 ENGINE: CGBA, CGBB

1.8 16V Petrol 92 11/00 → 08/07 ENGINE: CHBA, CHBB

2.0 16V Petrol 107 11/00 → 08/07 ENGINE: CJBA, CJBB

MONDEO III Station wagon (BWY)

1.8 16V Petrol 81 11/00 → 08/07 ENGINE: CGBA, CGBB

1.8 16V Petrol 92 11/00 → 08/07 ENGINE: CHBA, CHBB

2.0 16V Petrol 107 11/00 → 08/07 ENGINE: CJBA, CJBB

MONDEO III Tre volumi (B4Y)

1.8 16V Petrol 81 11/00 → 08/07 ENGINE: CGBA, CGBB

1.8 16V Petrol 92 11/00 → 08/07 ENGINE: CHBA, CHBB

2.0 16V Petrol 107 11/00 → 08/07 ENGINE: CJBA, CJBB

TOURNEO CONNECT

1.8 16V Petrol 85 06/02 → ENGINE: EYPA, EYPC, EYPD

TRANSIT CONNECT (P65_, P70_, P80_)

1.8 16V Petrol 85 06/02 → ENGINE: EYPA, EYPC, EYPD

PAS001

B5 **SENSORE PEDALE ACCELERATORE**
ACCELERATOR PEDAL SENSOR



OPEL

ASTRA G 2 volumi /Coda spiovente (F48_, F08_)

1.2 16V	Petrol	55	09/00 → 01/05
1.4	Petrol	66	09/07 → 12/09
1.4 16V	Petrol	66	02/98 → 01/05
1.6	Petrol	62	09/00 → 01/05
1.6	Petrol	76	12/02 → 12/09
1.6 16V	Petrol	74	02/98 → 01/05
1.7 CDTI	Diesel	59	04/03 → 12/09
1.8 16V	Petrol	92	09/00 → 01/05
2.0 DTI 16V	Diesel	74	08/99 → 01/05
2.0 OPC	Petrol	141	09/02 → 01/05
2.0 OPC	Petrol	147	11/02 → 01/05
2.2 16V	Petrol	108	06/00 → 01/05

ASTRA G Cabriolet (F67)

1.6	Petrol	76	01/03 → 10/05
1.6 16V	Petrol	74	03/01 → 10/05
1.8 16V	Petrol	92	03/01 → 10/05
2.0 OPC	Petrol	141	03/02 → 10/05
2.2 16V	Petrol	108	03/01 → 10/05

ASTRA G Coupé (F07_)

1.6 16V	Petrol	74	03/00 → 05/05
1.6 16V	Petrol	76	03/00 → 05/05
1.8 16V	Petrol	92	09/00 → 05/05
2.0 16V Turbo	Petrol	140	09/00 → 08/01
2.0 16V Turbo	Petrol	141	08/01 → 05/05
2.2 16V	Petrol	108	09/00 → 05/05

ASTRA G Furgonato (F70)

1.6	Petrol	62	09/00 → 04/05
-----	--------	----	---------------

ASTRA G Station wagon (F35_)

1.2 16V	Petrol	55	09/00 → 07/04
1.4	Petrol	66	09/07 → 12/09
1.4 16V	Petrol	66	06/98 → 07/04
1.6	Petrol	62	09/00 → 07/04
1.6	Petrol	76	12/02 → 07/09

PAS001



OPEL

ASTRA G Station wagon (F35_)

1.6 16V	Petrol	74	02/98 → 07/04
1.6 CNG	Petrol/ CNG	71	03/03 → 07/04
1.7 CDTI	Diesel	59	04/03 → 07/09
1.8 16V	Petrol	92	09/00 → 07/04
2.0 DTI 16V	Diesel	74	08/99 → 07/04
2.0 OPC	Petrol	141	09/02 → 07/04
2.2 16V	Petrol	108	03/01 → 07/04

ASTRA G Tre volumi (F69_)

1.2 16V	Petrol	55	09/00 → 01/05
1.4	Petrol	66	09/07 → 12/09
1.4 16V	Petrol	66	09/98 → 01/05
1.6	Petrol	62	09/00 → 01/05
1.6	Petrol	76	12/02 → 12/09
1.6 16V	Petrol	74	09/98 → 01/05
1.7 CDTI	Diesel	59	04/03 → 12/09
1.8 16V	Petrol	92	06/00 → 01/05
2.0 DTI 16V	Diesel	74	08/99 → 01/05
2.2 16V	Petrol	108	03/01 → 01/05

ASTRA H (L48)

1.2	Petrol	48	10/06 →
1.2	Petrol	59	08/05 →
1.3 CDTI	Diesel	66	08/05 →
1.4	Petrol	55	04/04 → 10/04
1.4	Petrol	59	04/04 → 10/04
1.4	Petrol	66	03/04 →
1.4 LPG	Petrol/ LPG	66	08/09 →
1.6	Petrol	77	03/04 →
1.6	Petrol	85	12/06 →
1.6 Turbo	Petrol	132	02/07 →
1.7 CDTI	Diesel	59	03/04 →
1.7 CDTI	Diesel	74	03/04 →
1.7 CDTI	Diesel	81	02/07 →
1.7 CDTI	Diesel	92	02/07 →
1.8	Petrol	103	01/06 →
1.8	Petrol	92	03/04 →
1.9 CDTI	Diesel	110	09/04 →
1.9 CDTI	Diesel	74	09/05 →
1.9 CDTI	Diesel	88	06/04 →
1.9 CDTI 16V	Diesel	88	04/04 →
2.0 Turbo	Petrol	125	03/04 →
2.0 Turbo	Petrol	147	09/04 →
2.0 Turbo	Petrol	177	03/05 →

PAS001

OPEL
ASTRA H GTC (L08)

1.2	Petrol	48	10/06 →	
1.2	Petrol	59	08/05 →	
1.3 CDTI	Diesel	66	04/05 →	
1.4	Petrol	55	03/05 →	
1.4	Petrol	66	03/05 →	
1.6	Petrol	77	03/05 →	
1.6	Petrol	85	12/06 →	
1.6 Turbo	Petrol	132	02/07 →	
1.7 CDTI	Diesel	59	03/05 →	
1.7 CDTI	Diesel	74	03/05 →	
1.7 CDTI	Diesel	81	02/07 →	
1.7 CDTI	Diesel	92	02/07 →	
1.8	Petrol	103	01/06 →	
1.8	Petrol	92	03/05 →	
1.9 CDTI	Diesel	110	03/05 →	
1.9 CDTI	Diesel	74	01/06 →	
1.9 CDTI	Diesel	88	09/05 →	
1.9 CDTI 16V	Diesel	88	03/05 →	
2.0 Turbo	Petrol	125	03/05 →	
2.0 Turbo	Petrol	147	03/05 →	
2.0 Turbo	Petrol	177	08/05 →	

ASTRA H Station wagon (L35)

1.3 CDTI	Diesel	66	08/05 →	
1.4	Petrol	55	08/04 →	
1.4	Petrol	66	08/04 →	
1.6	Petrol	77	08/04 →	
1.6	Petrol	85	12/06 →	
1.6 Turbo	Petrol	132	02/07 →	
1.7 CDTI	Diesel	59	08/04 →	
1.7 CDTI	Diesel	74	08/04 →	
1.7 CDTI	Diesel	81	02/07 →	
1.7 CDTI	Diesel	92	02/07 →	
1.8	Petrol	103	08/05 →	
1.8	Petrol	92	08/04 →	
1.9 CDTI	Diesel	103	12/04 →	
1.9 CDTI	Diesel	110	09/04 →	
1.9 CDTI	Diesel	74	09/05 →	
1.9 CDTI	Diesel	88	09/05 →	
1.9 CDTI 16V	Diesel	88	08/04 →	
2.0 Turbo	Petrol	125	08/04 →	
2.0 Turbo	Petrol	147	09/04 →	

PAS001

OPEL
ASTRA H Tre volumi (L69)

1.3 CDTI	Diesel	66	02/07 →	
1.6	Petrol	85	02/07 →	
1.7 CDTI	Diesel	74	02/07 →	
1.7 CDTI	Diesel	81	02/07 →	
1.8	Petrol	103	02/07 →	

ASTRA H TwinTop (L67)

1.6	Petrol	77	09/05 →	
1.6	Petrol	85	12/06 →	
1.6 Turbo	Petrol	132	02/07 →	
1.8	Petrol	103	09/05 →	
1.8	Petrol	92	09/05 →	
1.9 CDTI	Diesel	110	09/05 →	
2.0 Turbo	Petrol	125	09/05 →	
2.0 Turbo	Petrol	147	09/05 →	

ASTRA H Van (L70)

1.3 CDTI	Diesel	66	08/05 →	
1.7 CDTI	Diesel	74	03/04 →	
1.7 CDTI	Diesel	81	02/07 →	
1.7 CDTI	Diesel	92	02/07 →	
1.9 CDTI	Diesel	110	09/04 →	
1.9 CDTI	Diesel	88	09/05 →	
1.9 CDTI 16V	Diesel	88	08/04 →	

VAUXHALL
ASTRA Mk IV (G) 2 volumi /Coda spiovente

1.2 16V	Petrol	55	09/00 → 05/05	
1.4 16V	Petrol	66	02/98 → 05/05	
1.6	Petrol	62	09/00 → 05/05	
1.6 16V	Petrol	74	02/98 → 05/05	
1.7 CDTI 16V	Diesel	59	04/03 → 05/05	
1.8 16V	Petrol	92	09/00 → 05/05	
2.0 DTI 16V	Diesel	74	08/99 → 05/05	
2.2 16V	Petrol	108	03/01 → 05/05	

ASTRA Mk IV (G) Cabriolet

1.6 16V	Petrol	74	03/01 → 10/05	
1.8 16V	Petrol	92	03/01 → 10/05	
2.0	Petrol	147	09/02 → 07/06	
2.0 Turbo	Petrol	141	03/02 → 10/05	
2.2 16V	Petrol	108	03/01 → 10/05	

ASTRA Mk IV (G) Coupé (F67)

1.8 16V	Petrol	92	09/00 → 08/05	
1.8 16V Dualfuel	Petrol/ LPG	87	09/02 → 08/05	
2.0	Petrol	147	08/02 → 05/05	
2.0 16V Turbo	Petrol	140	09/00 → 08/05	

PAS001



VAUXHALL

ASTRA Mk IV (G) Coupé (F67)

2.2 16V	Petrol	108	03/00 → 08/05
---------	--------	-----	---------------

ASTRA Mk IV (G) Station wagon

1.2 16V	Petrol	55	09/00 → 05/05
---------	--------	----	---------------

1.4 16V	Petrol	66	02/98 → 05/05
---------	--------	----	---------------

1.6	Petrol	62	03/98 → 04/04
-----	--------	----	---------------

1.6 16V	Petrol	74	03/98 → 04/04
---------	--------	----	---------------

1.6 Dualfuel	Petrol/ LPG	63	03/98 → 04/04
--------------	----------------	----	---------------

1.7 CDTI 16V	Diesel	59	04/03 → 05/05
--------------	--------	----	---------------

1.8 16V	Petrol	92	09/00 → 05/05
---------	--------	----	---------------

1.8 16V Dualfuel	Petrol/ LPG	87	09/02 → 05/05
------------------	----------------	----	---------------

2.0 DTI 16V	Diesel	74	03/98 → 04/04
-------------	--------	----	---------------

2.2 16V	Petrol	108	03/01 → 05/05
---------	--------	-----	---------------

ASTRA Mk IV (G) Tre volumi

1.2 16V	Petrol	55	09/00 → 05/05
---------	--------	----	---------------

1.4 16V	Petrol	66	09/98 → 05/05
---------	--------	----	---------------

1.6	Petrol	62	09/00 → 05/05
-----	--------	----	---------------

1.6 16V	Petrol	74	09/98 → 05/05
---------	--------	----	---------------

1.6 Dualfuel	Petrol/ LPG	63	09/02 → 05/05
--------------	----------------	----	---------------

1.7 CDTI 16V	Diesel	59	04/03 → 05/05
--------------	--------	----	---------------

1.8 16V	Petrol	92	02/98 → 07/04
---------	--------	----	---------------

1.8 16V Dualfuel	Petrol/ LPG	87	02/98 → 07/04
------------------	----------------	----	---------------

2.0 DTI 16V	Diesel	74	02/98 → 07/04
-------------	--------	----	---------------

2.2 16V	Petrol	108	03/01 → 05/05
---------	--------	-----	---------------

ASTRA Mk V (H) 2 volumi /Coda spiovente

1.3 CDTI	Diesel	66	01/04 → 05/09
----------	--------	----	---------------

1.4	Petrol	66	01/04 → 05/09
-----	--------	----	---------------

1.6	Petrol	77	01/04 → 05/09
-----	--------	----	---------------

1.6	Petrol	85	01/04 → 05/09
-----	--------	----	---------------

1.7 CDTI	Diesel	59	01/04 → 05/09
----------	--------	----	---------------

1.7 CDTI	Diesel	74	01/04 → 05/09
----------	--------	----	---------------

1.7 CDTI	Diesel	81	01/04 → 05/09
----------	--------	----	---------------

1.7 TD	Diesel	79	01/04 → 05/09
--------	--------	----	---------------

1.8	Petrol	103	01/04 → 05/09
-----	--------	-----	---------------

1.8	Petrol	92	01/04 → 05/09
-----	--------	----	---------------

1.9 CDTI	Diesel	110	01/04 → 05/09
----------	--------	-----	---------------

1.9 CDTI	Diesel	88	01/04 → 05/09
----------	--------	----	---------------

1.9 CDTI 16V	Diesel	88	01/04 → 05/09
--------------	--------	----	---------------

2.0 Turbo	Petrol	125	01/04 → 05/09
-----------	--------	-----	---------------

2.0 Turbo	Petrol	147	01/04 → 05/09
-----------	--------	-----	---------------

2.0 Turbo	Petrol	177	01/04 → 05/09
-----------	--------	-----	---------------

PAS001



VAUXHALL

ASTRA Mk V (H) Sport Hatch

1.3 CDTI	Diesel	66	04/05 → 11/10
----------	--------	----	---------------

1.4 i 16V	Petrol	66	03/05 → 11/10
-----------	--------	----	---------------

1.6	Petrol	132	10/06 → 11/10
-----	--------	-----	---------------

1.6	Petrol	77	02/05 → 11/10
-----	--------	----	---------------

1.6 i 16V	Petrol	85	12/06 → 11/10
-----------	--------	----	---------------

1.7 CDTI	Diesel	74	02/05 → 11/10
----------	--------	----	---------------

1.7 CDTI	Diesel	81	02/07 → 11/10
----------	--------	----	---------------

1.8	Petrol	92	02/05 → 11/10
-----	--------	----	---------------

1.8 i 16V	Petrol	103	03/07 → 11/10
-----------	--------	-----	---------------

1.9 CDTI	Diesel	110	02/05 → 11/10
----------	--------	-----	---------------

1.9 CDTI	Diesel	74	08/05 → 11/10
----------	--------	----	---------------

1.9 CDTI	Diesel	88	02/05 → 11/10
----------	--------	----	---------------

2.0 Turbo	Petrol	125	02/05 → 11/10
-----------	--------	-----	---------------

2.0 VXR	Petrol	176	02/09 → 11/10
---------	--------	-----	---------------

ASTRA Mk V (H) Station wagon

1.3 CDTI	Diesel	66	08/04 → 03/09
----------	--------	----	---------------

1.4	Petrol	66	08/04 → 03/09
-----	--------	----	---------------

1.6	Petrol	132	08/04 → 03/09
-----	--------	-----	---------------

1.6	Petrol	77	08/04 → 03/09
-----	--------	----	---------------

1.6	Petrol	85	08/04 → 03/09
-----	--------	----	---------------

1.7 CDTI	Diesel	74	08/04 → 03/09
----------	--------	----	---------------

1.7 CDTI	Diesel	81	08/04 → 03/09
----------	--------	----	---------------

1.7 TD	Diesel	79	08/04 → 03/09
--------	--------	----	---------------

1.8	Petrol	103	10/04 → 03/09
-----	--------	-----	---------------

1.8	Petrol	92	10/04 → 03/09
-----	--------	----	---------------

1.9 CDTI	Diesel	110	08/04 → 03/09
----------	--------	-----	---------------

1.9 CDTI	Diesel	74	08/04 → 03/09
----------	--------	----	---------------

1.9 CDTI	Diesel	88	08/04 → 03/09
----------	--------	----	---------------

1.9 CDTI	Diesel	88	08/04 → 03/09
----------	--------	----	---------------

2.0 Turbo	Petrol	125	08/04 → 10/10
-----------	--------	-----	---------------

2.0 Turbo	Petrol	147	08/04 → 10/10
-----------	--------	-----	---------------

ASTRA TwinTop Mk V (H)

1.6	Petrol	132	10/06 → 11/10
-----	--------	-----	---------------

1.6	Petrol	77	09/05 → 11/10
-----	--------	----	---------------

1.6 i 16V	Petrol	85	10/06 → 11/10
-----------	--------	----	---------------

1.8	Petrol	103	05/08 → 11/10
-----	--------	-----	---------------

1.9 CDTI	Diesel	110	01/06 → 11/10
----------	--------	-----	---------------

2.0	Petrol	125	02/06 → 11/10
-----	--------	-----	---------------

2.0 Turbo	Petrol	147	01/06 → 11/10
-----------	--------	-----	---------------

ASTRAVAN Mk IV (G)

1.6 i	Petrol	62	09/00 → 08/06
-------	--------	----	---------------

1.7 CDTI	Diesel	59	04/04 → 08/06
----------	--------	----	---------------

2.0 DTI	Diesel	74	04/04 → 08/06
---------	--------	----	---------------

PAS001

KW

VAUXHALL
ASTRAVAN Mk V (H)

1.3 CDTI	Diesel	66	08/05 →	
1.4 i	Petrol	66	03/05 →	
1.6	Petrol	76	03/05 →	
1.7 CDTI	Diesel	59	03/05 → 07/06	
1.7 CDTI	Diesel	74	03/05 → 11/11	
1.9 CDTI	Diesel	110	03/05 → 11/11	
1.9 CDTI	Diesel	88	03/05 → 11/11	

PAS002
B5
**SENSORE PEDALE ACCELERATORE
ACCELERATOR PEDAL SENSOR**

KW

OPEL
CORSA D

1.2	Petrol	63	06/10 →	
-----	--------	----	---------	--

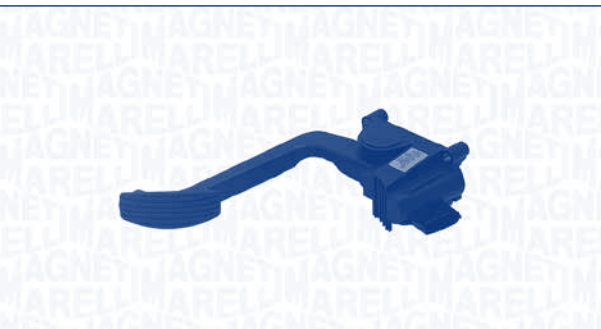
PAS003
B5
**SENSORE PEDALE ACCELERATORE
ACCELERATOR PEDAL SENSOR**

KW

FIAT
MULTIPLA (186)

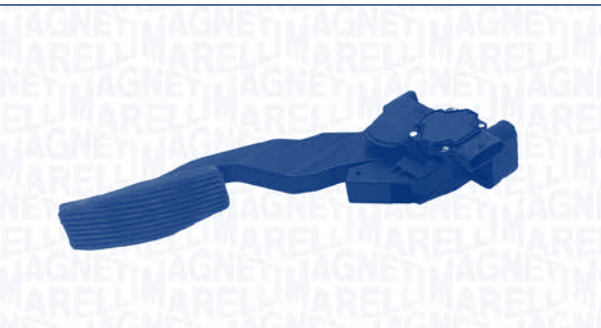
1.9 JTD (186AXE1A)	Diesel	88	04/02 → 06/10	
1.9 JTD 105 (186AXB1A)	Diesel	77	04/99 → 06/10	
1.9 JTD 110	Diesel	81	03/01 → 07/02	
1.9 JTD 115	Diesel	85	07/02 → 06/10	

PAS004
B5
**SENSORE PEDALE ACCELERATORE
ACCELERATOR PEDAL SENSOR**

KW

OPEL
ZAFIRA A (F75_)

2.0 DI 16V	Diesel	60	10/99 → 06/05	
2.0 DTI 16V	Diesel	74	09/00 → 06/05	

VAUXHALL
ZAFIRA Mk I (A) (F75)

2.0 DI 16V	Diesel	60	10/99 → 08/05	
2.0 DTI 16V	Diesel	74	04/99 → 08/05	

PAS005

B5 **SENSORE PEDALE ACCELERATORE**
ACCELERATOR PEDAL SENSOR



MERCEDES-BENZ

SPRINTER 2-t Autobus (901, 902)

214 NGT	Bifuel	92	04/00 → 05/06
216 CDI	Diesel	115	04/00 → 05/06

SPRINTER 2-t Furgonato (901, 902)

214	Petrol	105	02/95 → 05/06
208 CDI	Diesel	60	04/00 → 05/06
211 CDI	Diesel	80	04/00 → 05/06
213 CDI	Diesel	95	04/00 → 05/06
214 NGT	Bifuel	92	04/00 → 05/06
216 CDI	Diesel	115	04/00 → 05/06

SPRINTER 2-t Pianale piatto/Telaio (901, 902)

214	Petrol	105	02/95 → 05/06
208 CDI	Diesel	60	04/00 → 05/06
211 CDI	Diesel	80	04/00 → 05/06
213 CDI	Diesel	95	04/00 → 05/06
214 NGT	Bifuel	92	04/00 → 05/06
216 CDI	Diesel	115	04/00 → 05/06

SPRINTER 3-t Autobus (903)

314	Petrol	105	02/95 → 05/06
308 CDI	Diesel	60	04/00 → 05/06
311 CDI	Diesel	80	04/00 → 05/06
311 CDI 4x4	Diesel	80	08/02 → 05/06
313 CDI	Diesel	95	04/00 → 05/06
313 CDI 4x4	Diesel	95	08/02 → 05/06
314 4x4	Petrol	105	08/02 → 05/06
314 NGT	Bifuel	92	04/00 → 05/06
316 CDI	Diesel	115	04/00 → 05/06
316 CDI 4x4	Diesel	115	08/02 → 05/06

SPRINTER 3-t Furgonato (903)

314	Petrol	105	02/95 → 05/06
308 CDI	Diesel	60	04/00 → 05/06
311 CDI	Diesel	80	04/00 → 05/06
311 CDI 4x4	Diesel	80	08/02 → 05/06
313 CDI	Diesel	95	04/00 → 05/06

PAS005



MERCEDES-BENZ

SPRINTER 3-t Furgonato (903)

313 CDI 4x4	Diesel	95	08/02 → 05/06
314 4x4	Petrol	105	08/02 → 05/06
314 NGT	Bifuel	92	04/00 → 05/06
316 CDI	Diesel	115	04/00 → 05/06
316 CDI 4x4	Diesel	115	08/02 → 05/06

SPRINTER 3-t Pianale piatto/Telaio (903)

314	Petrol	105	02/95 → 05/06
308 CDI	Diesel	60	04/00 → 05/06
311 CDI	Diesel	80	04/00 → 05/06
311 CDI 4x4	Diesel	80	08/02 → 05/06
313 CDI	Diesel	95	04/00 → 05/06
313 CDI 4x4	Diesel	95	08/02 → 05/06
314 4x4	Petrol	105	08/02 → 05/06
314 NGT	Bifuel	92	04/00 → 05/06
316 CDI	Diesel	115	04/00 → 05/06
316 CDI 4x4	Diesel	115	08/02 → 05/06

SPRINTER 4-t Autobus (904)

414	Petrol	105	02/96 → 05/06
408 CDI	Diesel	60	04/00 → 05/06
411 CDI	Diesel	80	04/00 → 05/06
413 CDI	Diesel	95	04/00 → 05/06
416 CDI	Diesel	115	04/00 → 05/06

SPRINTER 4-t Furgonato (904)

414	Petrol	105	02/96 → 05/06
408 CDI	Diesel	60	04/00 → 05/06
411 CDI	Diesel	80	04/00 → 05/06
411 CDI 4x4	Diesel	80	04/00 → 05/06
413 CDI	Diesel	95	04/00 → 05/06
413 CDI 4x4	Diesel	95	04/00 → 05/06
414 4x4	Petrol	105	05/97 → 05/06
416 CDI	Diesel	115	04/00 → 05/06
416 CDI 4x4	Diesel	115	04/00 → 05/06

SPRINTER 4-t Pianale piatto/Telaio (904)

414	Petrol	105	02/96 → 05/06
408 CDI	Diesel	60	04/00 → 05/06
411 CDI	Diesel	80	04/00 → 05/06
411 CDI 4x4	Diesel	80	04/00 → 05/06
413 CDI	Diesel	95	04/00 → 05/06
413 CDI 4x4	Diesel	95	04/00 → 05/06
414 4x4	Petrol	105	05/97 → 05/06
416 CDI	Diesel	115	04/00 → 05/06
416 CDI 4x4	Diesel	115	04/00 → 05/06

PAS006
B5
**SENSORE PEDALE ACCELERATORE
ACCELERATOR PEDAL SENSOR**

KW

OPEL
ASTRA G 2 volumi /Coda spiovente (F48_, F08_)

1.7 DTI 16V	Diesel	55	02/00 → 01/05
-------------	--------	----	---------------

1.7 TD	Diesel	50	02/98 → 08/00
--------	--------	----	---------------

2.0 DI	Diesel	60	02/98 → 01/05
--------	--------	----	---------------

2.2 DTI	Diesel	92	09/02 → 01/05
---------	--------	----	---------------

ASTRA G Cabriolet (F67)

2.2 DTI	Diesel	92	09/02 → 10/05
---------	--------	----	---------------

ASTRA G Coupé (F07_)

2.2 DTI	Diesel	92	09/02 → 05/05
---------	--------	----	---------------

ASTRA G Furgonato (F70)

1.7 TD	Diesel	50	01/99 → 04/05
--------	--------	----	---------------

2.0 DI	Diesel	60	01/99 → 04/05
--------	--------	----	---------------

ASTRA G Station wagon (F35_)

1.7 DTI 16V	Diesel	55	02/00 → 07/04
-------------	--------	----	---------------

1.7 TD	Diesel	50	02/98 → 08/00
--------	--------	----	---------------

2.0 DI	Diesel	60	02/98 → 07/04
--------	--------	----	---------------

2.2 DTI	Diesel	92	09/02 → 07/04
---------	--------	----	---------------

ASTRA G Tre volumi (F69_)

1.7 DTI 16V	Diesel	55	02/00 → 01/05
-------------	--------	----	---------------

1.7 TD	Diesel	50	09/98 → 08/00
--------	--------	----	---------------

2.0 DI	Diesel	60	09/98 → 01/05
--------	--------	----	---------------

2.2 DTI	Diesel	92	09/02 → 01/05
---------	--------	----	---------------

VAUXHALL
ASTRA Mk IV (G) 2 volumi /Coda spiovente

1.7 TD	Diesel	50	02/98 → 08/00
--------	--------	----	---------------

2.0 DI	Diesel	60	02/98 → 05/05
--------	--------	----	---------------

ASTRA Mk IV (G) Station wagon

1.7 TD	Diesel	50	02/98 → 08/00
--------	--------	----	---------------

2.0 DI	Diesel	60	03/98 → 04/04
--------	--------	----	---------------

ASTRA Mk IV (G) Tre volumi

1.7 TD	Diesel	50	09/98 → 08/00
--------	--------	----	---------------

2.0 DI	Diesel	60	02/98 → 07/04
--------	--------	----	---------------

PAS006

KW

VAUXHALL
ASTRAVAN Mk IV (G)

1.7 TD	Diesel	50	08/98 → 08/06
--------	--------	----	---------------

2.0 DI	Diesel	60	08/98 → 08/06
--------	--------	----	---------------

CA0005504
B6
**SENSORE POSIZIONE FARFALLA
THROTTLE POSITION SENSOR**

KW

CITROËN
ZX (N2)

2.0 i	Petrol	89	07/92 → 06/97	ENGINE: (ES9J4-XU10J4RS)
-------	--------	----	---------------	-----------------------------

PEUGEOT
306 (7B, N3, N5)

2.0	Petrol	97	03/97 → 05/01	ENGINE: (ES9J4-XU10J4RS)
-----	--------	----	---------------	-----------------------------

306 2 volumi /Coda spiovente (7A, 7C, N3, N5)

2.0 XSi	Petrol	89	05/93 → 05/01	ENGINE: (ES9J4-XU10J4RS)
---------	--------	----	---------------	-----------------------------

306 Cabriolet (7D, N3, N5)

2.0	Petrol	89	03/94 → 04/02	ENGINE: (ES9J4-XU10J4RS)
-----	--------	----	---------------	-----------------------------

RENAULT
ESPACE II (J/S63_)

2.0 (J636)	Petrol	76	01/91 → 10/96	ENGINE: (ES9J4-XU10J4RS)
------------	--------	----	---------------	-----------------------------

MEGANE I (BA0/1_)

2.0 i	Petrol	80	03/99 → 08/03	ENGINE: (ES9J4-XU10J4RS)
-------	--------	----	---------------	-----------------------------

2.0 i (BA0G)	Petrol	84	01/96 → 08/03	ENGINE: (ES9J4-XU10J4RS)
--------------	--------	----	---------------	-----------------------------

CA0005504



RENAULT

MEGANE I Cabriolet (EA0/1_)

2.0 (EA0G) Petrol 84 04/97 → 08/03 ENGINE: (ES9J4-XU10J4RS)

2.0 i (EA0G) Petrol 80 03/99 → 08/03 ENGINE: (ES9J4-XU10J4RS)

MEGANE I Classic (LA0/1_)

2.0 i (LA0G) Petrol 80 03/99 → 08/03 ENGINE: (ES9J4-XU10J4RS)

MEGANE I Coach (DA0/1_)

2.0 i Petrol 80 03/99 → 08/03 ENGINE: (ES9J4-XU10J4RS)

2.0 i (DA0G) Petrol 84 03/96 → 08/03 ENGINE: (ES9J4-XU10J4RS)

SAFRANE I (B54_)

2.0 (B540) Petrol 77 11/92 → 07/96 ENGINE: (ES9J4-XU10J4RS)

CA0077265/1

B6 **SENSORE POSIZIONE FARFALLA**
THROTTLE POSITION SENSOR



CITROËN

SAXO (S0, S1)

1.1 X,SX Petrol 44 05/96 → 09/03 ENGINE: TU1JP

PEUGEOT

206 2 volumi /Coda spiovente (2A/C)

1.1 i Petrol 44 09/98 → ENGINE: TU1JP

1.4 i Petrol 55 09/98 → ENGINE: TU3JP

206 SW (2E/K)

1.1 Petrol 44 07/02 → ENGINE: TU1JP

1.4 Petrol 55 07/02 → ENGINE: TU3JP

CP90/011

B6 **SENSORE POSIZIONE FARFALLA**
THROTTLE POSITION SENSOR



CITROËN

BX (XB-)

16 E Petrol 65 05/89 → 02/93

BX Break (XB-)

16 Petrol 65 05/89 → 12/94

XM (Y3)

2.0 i Petrol 79 05/89 → 04/94

XM Break (Y3)

2.0 i (Y3A) Petrol 79 11/91 → 04/94

PEUGEOT

309 II (3C, 3A)

1.6 Petrol 65 07/89 → 12/93

405 I (15B)

1.6 Petrol 65 07/87 → 12/92

1.6 Petrol 66 10/89 → 12/92

405 I Break (15E)

1.6 Petrol 65 10/88 → 08/92

1.6 Petrol 66 10/88 → 08/92

IPF2C
B6 **SENSORE POSIZIONE FARFALLA
THROTTLE POSITION SENSOR**

FIAT
DOBLO (119)

1.2 (223AXA1A) Petrol 48 03/01 → ENGINE: 223A5000

DOBLO Cargo (223)

1.2 (223ZX1A) Petrol 48 03/01 → ENGINE: 223A5000

PUNTO (188)

1.2 60 (188.030, .050, .130, .150, .230, .250) Petrol 44 09/99 → ENGINE: 188A4000

PUNTO Van (188AX)

1.2 60 Petrol 44 02/00 → 10/09 ENGINE: 188A4000

SEICENTO (187)

1.1 (187AXB, 187AXB1A) Petrol 40 01/98 → 01/10 ENGINE: 176B2000, 187A1000

SEICENTO Van (187)

1.1 (187CXB/C) Petrol 40 01/98 → 01/10 ENGINE: 176B2000

KITPF1C
B6 **SENSORE POSIZIONE FARFALLA
THROTTLE POSITION SENSOR**

ALFA ROMEO
145 (930)

1.4 i.e. Petrol 66 07/94 → 12/96

KITPF1C

ALFA ROMEO
146 (930)

1.4 i.e. Petrol 66 12/94 → 12/96

FIAT
BRAVA (182)

1.6 16V (182.BH) Petrol 66 10/95 → 03/98

BRAVO I (182)

1.6 16V (182.AH) Petrol 66 10/95 → 03/98

PALIO (178BX)

1.6 16V Petrol 74 04/96 → 12/98

PALIO Weekend (178DX)

1.6 16V (178DX.D1A) Petrol 74 04/96 → 12/98

TEMPRA (159)

1.8 i.e. (159.AN) Petrol 77 03/92 → 08/96

1.8 i.e. (159.AN) Petrol 81 03/90 → 08/96

1.8 i.e. (159.AV) Petrol 76 09/93 → 08/96

1.8 i.e. (159.AZ) Petrol 66 09/93 → 08/96

1.8 i.e. (159.BY) Petrol 74 10/94 → 08/96

TEMPRA S.W. (159)

1.8 i.e. (159.AN) Petrol 77 03/92 → 12/93

1.8 i.e. (159.AN) Petrol 81 03/90 → 08/96

1.8 i.e. (159.AV) Petrol 76 09/93 → 08/96

1.8 i.e. (159.AZ) Petrol 66 09/93 → 08/96

1.8 i.e. (159.BY) Petrol 74 10/94 → 08/96

TIPO (160)

1.8 i.e. Petrol 71 03/93 → 04/95

1.8 i.e. Petrol 66 09/93 → 04/95

1.8 i.e. Petrol 81 10/90 → 06/93

1.8 i.e. (160.ED) Petrol 76 04/93 → 04/95

1.8 i.e. (160.EQ, 160.AM) Petrol 74 10/94 → 04/95

LANCIA
DEDRA (835)

1.8 i.e. (835AT) Petrol 66 08/93 → 12/96

DEDRA (835)

1.8 i.e. (835BD, 835AD) Petrol 77 09/89 → 12/96

1.8 i.e. (835FA) Petrol 74 07/94 → 12/96

DELTA II (836)

1.8 i.e. (836AE) Petrol 76 06/93 → 12/97

1.8 i.e. (836AG, 836AL) Petrol 66 07/94 → 12/97

KITPF2C

B6 **SENSORE POSIZIONE FARFALLA**
THROTTLE POSITION SENSOR

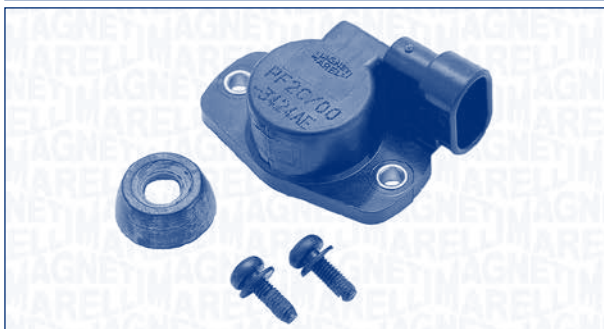

CITROËN

AX (ZA-)

11	Petrol	40	06/91 → 04/94
11	Petrol	44	06/91 → 12/96
11 4x4	Petrol	40	06/91 → 07/92

BERLINGO (MF)

1.8 i (MFLFX)	Petrol	66	05/97 →
---------------	--------	----	---------

BERLINGO Furgonato (M_)

1.8 i	Petrol	66	08/99 → 10/02
-------	--------	----	---------------

XANTIA (X1)

1.8 i	Petrol	66	04/97 → 01/98
-------	--------	----	---------------

XSARA (N1)

1.4 i	Petrol	55	04/97 → 03/05
1.8 i	Petrol	66	04/97 → 09/00

XSARA Break (N2)

1.4 i	Petrol	55	10/97 → 08/05
1.8 i	Petrol	66	10/97 → 09/00

ZX (N2)

1.4 i	Petrol	55	01/94 → 06/97
-------	--------	----	---------------

ZX Break (N2)

1.4 i	Petrol	55	01/94 → 10/97
-------	--------	----	---------------

FIAT

CINQUECENTO (170)

0.9 i.e. (170AC)	Petrol	30	07/91 → 12/93
0.9 i.e. S (170AF, 170CF)	Petrol	29	07/91 → 01/98
1.1 Sporting (170AH)	Petrol	40	10/94 → 01/98

PALIO (178BX)

1.2	Petrol	54	06/98 → 12/00
-----	--------	----	---------------

PALIO Weekend (178DX)

1.2 (178DX. G1A)	Petrol	54	04/96 → 02/01
------------------	--------	----	---------------

KITPF2C



FIAT

PANDA (141A_)

900	Petrol	29	04/92 → 12/96
900	Petrol	33	04/92 → 06/94
1100	Petrol	37	04/92 → 12/99
1100	Petrol	40	02/95 → 12/00
1000 i.e. Cat.	Petrol	33	04/92 → 08/98
1100 4x4	Petrol	40	02/95 → 12/00
1100 Trekking 4x4	Petrol	37	04/92 → 12/00

PUNTO (176)

1.2 16V	Petrol	63	04/97 → 04/99
55 1.1	Petrol	40	09/93 → 09/99
60 1.2	Petrol	43	01/94 → 09/99
60 1.2	Petrol	44	03/94 → 09/99
75 1.2	Petrol	54	12/93 → 09/99

PUNTO Cabriolet (176C)

60 1.2	Petrol	43	04/94 → 06/00
60 1.2	Petrol	44	05/95 → 06/00
85 16V 1.2	Petrol	63	04/97 → 04/99

PUNTO Van (176L)

1.1	Petrol	40	04/96 → 02/00
-----	--------	----	---------------

SEICENTO (187)

0.9 (187AXA, 187AXA1A)	Petrol	29	01/98 → 01/10
1.1 (187AXB, 187AXB1A)	Petrol	40	01/98 → 01/10
0.9 (187AXA)	Petrol	29	01/98 → 01/10
1.1 (187CXB/C)	Petrol	40	01/98 → 01/10

SIENA (178_)

1.2	Petrol	54	09/98 →
-----	--------	----	---------

STRADA Pick-up (178E)

1.2	Petrol	54	06/99 →
-----	--------	----	---------

UNO (146A/E)

55 1.0	Petrol	41	03/94 → 08/00
--------	--------	----	---------------

LANCIA

Y (840A)

1.1 (840AE)	Petrol	40	11/95 → 12/00
1.2 (840AA, 840AF1A)	Petrol	44	03/96 → 12/00
1.2 16V (840AD)	Petrol	63	04/97 → 04/99

KITPF2C

KW

PEUGEOT
106 I (1A, 1C)

1.1	Petrol	44	09/91 → 04/96
1.4	Petrol	55	09/91 → 04/96
1.4	Petrol	69	09/91 → 04/96
1.6	Petrol	65	06/93 → 04/96
1.6	Petrol	76	01/94 → 04/96

205 II (20A/C)

1.1	Petrol	44	07/89 → 09/98
-----	--------	----	---------------

206 2 volumi /Coda spiovente (2A/C)

1.1 i	Petrol	44	09/98 → 12/98
1.4 i	Petrol	55	09/98 → 12/98

306 (7B, N3, N5)

1.1	Petrol	44	06/94 → 05/01
1.4 SL	Petrol	55	06/94 → 05/01

306 2 volumi /Coda spiovente (7A, 7C, N3, N5)

1.1	Petrol	44	05/93 → 05/01
1.4	Petrol	55	05/93 → 05/01

306 Break (7E, N3, N5)

1.4	Petrol	55	03/97 → 04/02
-----	--------	----	---------------

406 (8B)

1.8	Petrol	66	05/97 → 12/00
-----	--------	----	---------------

406 Break (8E/F)

1.8	Petrol	66	05/97 → 12/00
-----	--------	----	---------------

RANCH MPV / Space wagon (5F)

1.4	Petrol	55	06/96 → 12/00
1.8	Petrol	66	05/97 → 12/00

RENAULT
CLIO I (B/C57_, 5/357_)

1.2 (B/C57R)	Petrol	40	01/91 → 06/96
--------------	--------	----	---------------

TWINGO I (C06_)

1.2 (C063, C064)	Petrol	40	03/93 → 10/96
------------------	--------	----	---------------

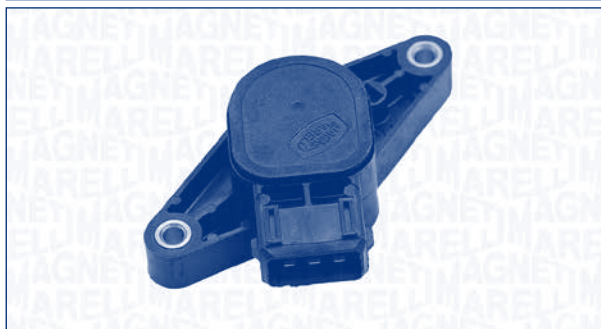
PF16080067
B6
**SENSORE POSIZIONE FARFALLA
THROTTLE POSITION SENSOR**

KW

CITROËN
EVASION (22, U6)

1.8	Petrol	73	05/97 → 07/02
-----	--------	----	---------------

EVASION (22, U6)

2.0	Petrol	89	01/96 → 07/02
-----	--------	----	---------------

JUMPER Autobus (230P)

2.0	Petrol	80	01/96 → 04/02
-----	--------	----	---------------

JUMPER Furgonato (230L)

2.0	Petrol	80	01/96 → 04/02
-----	--------	----	---------------

JUMPER Pianale piatto/Telaio (230)

2.0	Petrol	80	01/96 → 04/02
-----	--------	----	---------------

XANTIA (X1)

1.6 i	Petrol	65	01/96 → 01/98
1.8 i	Petrol	74	01/96 → 01/98
2.0 i	Petrol	89	01/96 → 01/98

XANTIA Break (X1)

1.8 i	Petrol	74	01/96 → 01/98
2.0 i	Petrol	89	01/96 → 01/98

XSARA (N1)

1.8 i	Petrol	66	04/97 → 09/00
1.8 i Aut.	Petrol	74	04/97 → 09/00

XSARA Break (N2)

1.8 i	Petrol	66	10/97 → 09/00
1.8 i Aut.	Petrol	74	10/97 → 09/00

ZX (N2)

1.6 i	Petrol	65	01/96 → 06/97
1.8 i	Petrol	74	01/96 → 06/97
2.0 i	Petrol	89	01/96 → 06/97

FIAT
DUCATO Autobus (230)

2.0 Panorama/ Combinato	Petrol	80	01/96 → 04/02
----------------------------	--------	----	---------------

DUCATO Furgonato (230L)

2.0	Petrol	80	01/96 → 04/02
-----	--------	----	---------------

PF16080067



FIAT

ULYSSE (220)

1.8 (220.BB5)	Petrol	73	05/97 → 08/02
2.0 (220.AC5)	Petrol	89	01/96 → 08/02

PEUGEOT

106 I (1A, 1C)

1.3	Petrol	72	01/96 → 04/96
-----	--------	----	---------------

306 (7B, N3, N5)

1.8 ST	Petrol	74	01/96 → 05/01
2.0	Petrol	97	03/97 → 05/01

405 II Break (4E)

1.6	Petrol	65	01/96 → 10/96
1.8	Petrol	74	01/96 → 10/96
2.0	Petrol	89	01/96 → 10/96

406 (8B)

1.6	Petrol	65	01/96 → 05/04
1.8	Petrol	66	05/97 → 05/04

406 Break (8E/F)

1.8	Petrol	66	05/97 → 10/04
-----	--------	----	---------------

806 (221)

2.0	Petrol	89	01/96 → 08/02
-----	--------	----	---------------

BOXER Autobus (230P)

2.0 i	Petrol	80	01/96 → 04/02
-------	--------	----	---------------

BOXER Furgonato (230L)

2.0 i	Petrol	80	01/96 → 04/02
-------	--------	----	---------------

BOXER Pianale piatto/Telaio (ZCT_)

2.0 i	Petrol	80	01/96 → 04/02
-------	--------	----	---------------

PF90/018

B6 **SENSORE POSIZIONE FARFALLA**
THROTTLE POSITION SENSOR



CITROËN

BX Break (XB-_)

16	Petrol	65	05/89 → 12/94
----	--------	----	---------------

EVASION (22, U6)

2.0	Petrol	89	06/94 → 12/95
-----	--------	----	---------------

JUMPER Autobus (230P)

2.0	Petrol	80	02/94 → 12/95
-----	--------	----	---------------

JUMPER Furgonato (230L)

2.0	Petrol	80	03/94 → 12/95
-----	--------	----	---------------

JUMPER Pianale piatto/Telaio (230)

2.0	Petrol	80	03/94 → 12/95
-----	--------	----	---------------

XANTIA (X1)

1.6 i	Petrol	65	03/93 → 12/95
1.8 i	Petrol	74	03/93 → 12/95
2.0 i	Petrol	89	03/93 → 12/95

XANTIA Break (X1)

1.8 i	Petrol	74	06/95 → 12/95
2.0 i	Petrol	89	06/95 → 12/95

ZX (N2)

1.6 i	Petrol	65	03/91 → 12/95
2.0 i	Petrol	89	07/92 → 12/95

ZX Break (N2)

1.6 i	Petrol	65	10/93 → 12/95
-------	--------	----	---------------

FIAT

DUCATO Autobus (230)

2.0 Panorama/ Combinato	Petrol	80	03/94 → 12/95
----------------------------	--------	----	---------------

DUCATO Furgonato (230L)

2.0	Petrol	80	03/94 → 12/95
-----	--------	----	---------------

ULYSSE (220)

2.0 (220.AC5)	Petrol	89	06/94 → 12/95
---------------	--------	----	---------------

PEUGEOT

205 I Cabriolet (741B, 20D)

1.6 CJ	Petrol	65	08/92 → 12/94
--------	--------	----	---------------

PF90/018

KW

PEUGEOT
306 (7B, N3, N5)

1.8 ST	Petrol	74	06/94 → 05/01
--------	--------	----	---------------

306 2 volumi /Coda spiovente (7A, 7C, N3, N5)

1.8	Petrol	74	05/93 → 05/01
-----	--------	----	---------------

2.0 XSi	Petrol	89	05/93 → 05/01
---------	--------	----	---------------

306 Cabriolet (7D, N3, N5)

1.8	Petrol	74	03/94 → 04/02
-----	--------	----	---------------

2.0	Petrol	89	03/94 → 04/02
-----	--------	----	---------------

405 I (15B)

1.6	Petrol	65	01/92 → 12/92
-----	--------	----	---------------

1.6	Petrol	66	01/92 → 12/92
-----	--------	----	---------------

405 I Break (15E)

1.6	Petrol	65	01/92 → 08/92
-----	--------	----	---------------

1.6	Petrol	66	01/92 → 08/92
-----	--------	----	---------------

405 II (4B)

1.6	Petrol	65	08/92 → 10/95
-----	--------	----	---------------

1.8	Petrol	74	08/92 → 10/95
-----	--------	----	---------------

2.0	Petrol	89	08/92 → 10/95
-----	--------	----	---------------

2.0 T 16 X4	Petrol	144	08/92 → 10/95
-------------	--------	-----	---------------

2.0 X4	Petrol	89	08/92 → 10/95
--------	--------	----	---------------

405 II Break (4E)

1.6	Petrol	65	08/92 → 12/95
-----	--------	----	---------------

1.8	Petrol	74	08/92 → 12/95
-----	--------	----	---------------

2.0	Petrol	89	08/92 → 12/95
-----	--------	----	---------------

2.0 4x4	Petrol	89	08/92 → 12/95
---------	--------	----	---------------

806 (221)

2.0	Petrol	89	06/94 → 12/95
-----	--------	----	---------------

BOXER Autobus (230P)

2.0 i	Petrol	80	03/94 → 12/95
-------	--------	----	---------------

BOXER Furgonato (230L)

2.0 i	Petrol	80	06/94 → 12/95
-------	--------	----	---------------

BOXER Pianale piatto/Telaio (ZCT_)

2.0 i	Petrol	80	06/94 → 12/95
-------	--------	----	---------------

SVF001
B6
**SENSORE POSIZIONE FARFALLA
THROTTLE POSITION SENSOR**

KW

FORD
ESCORT CLASSIC Turnier (ANL)

1.6 16V	Petrol	66	02/99 → 07/00
---------	--------	----	---------------

1.8 TD	Diesel	66	02/99 → 07/00
--------	--------	----	---------------

ESCORT V (GAL)

1.8 16V XR3i	Petrol	77	02/92 → 12/92
--------------	--------	----	---------------

1.8 16V XR3i	Petrol	96	02/92 → 12/92
--------------	--------	----	---------------

RS 2000	Petrol	110	12/92 → 12/92
---------	--------	-----	---------------

ESCORT V Cabriolet (ALL)

1.4	Petrol	52	07/90 → 12/92
-----	--------	----	---------------

1.8 16V XR3i	Petrol	77	02/92 → 12/92
--------------	--------	----	---------------

1.8 16V XR3i	Petrol	96	02/92 → 12/92
--------------	--------	----	---------------

ESCORT V Station wagon (GAL, AVL)

1.8 16V	Petrol	77	02/92 → 12/92
---------	--------	----	---------------

ESCORT VI (GAL)

1.3	Petrol	44	12/92 → 04/94
-----	--------	----	---------------

1.4	Petrol	52	12/92 → 04/94
-----	--------	----	---------------

1.4	Petrol	55	01/94 → 04/94
-----	--------	----	---------------

1.6 i 16V	Petrol	65	01/94 → 01/95
-----------	--------	----	---------------

1.6 i 16V	Petrol	66	09/92 → 01/95
-----------	--------	----	---------------

1.8 16V XR3i	Petrol	96	09/92 → 01/95
--------------	--------	----	---------------

1.8 i 16V	Petrol	77	09/92 → 01/95
-----------	--------	----	---------------

1.8 XR3i 16V 4x4	Petrol	77	08/93 → 01/95
------------------	--------	----	---------------

1.8 XR3i 16V 4x4	Petrol	96	08/93 → 01/95
------------------	--------	----	---------------

RS 2000	Petrol	110	12/92 → 01/95
---------	--------	-----	---------------

RS 2000 4x4	Petrol	110	08/93 → 01/95
-------------	--------	-----	---------------

ESCORT VI Cabriolet (ALL)

1.4	Petrol	52	12/92 → 04/94
-----	--------	----	---------------

1.4 i	Petrol	55	07/93 → 04/94
-------	--------	----	---------------

1.6 16V XR3i	Petrol	66	12/92 → 01/95
--------------	--------	----	---------------

1.6 i 16V	Petrol	65	02/94 → 01/95
-----------	--------	----	---------------

1.8 16V XR3i	Petrol	77	12/92 → 01/95
--------------	--------	----	---------------

1.8 16V XR3i	Petrol	96	12/92 → 01/95
--------------	--------	----	---------------

SVF001



FORD

ESCORT VI Station wagon (GAL)

1.3	Petrol	44	12/92 → 04/94
1.4	Petrol	52	12/92 → 01/94
1.4	Petrol	55	01/94 → 01/95
1.6 i 16V	Petrol	65	01/94 → 01/95
1.6 i 16V	Petrol	66	09/92 → 01/95
1.8 i 16V	Petrol	77	01/93 → 01/95
1.8 i 16V	Petrol	96	02/93 → 01/95

ESCORT VI Tre volumi (GAL)

1.3	Petrol	44	08/93 → 04/94
1.4	Petrol	52	08/93 → 04/94
1.4	Petrol	55	08/93 → 04/94
1.6 i 16V	Petrol	65	01/94 → 01/95
1.6 i 16V	Petrol	66	08/93 → 01/95
1.8 i 16V	Petrol	77	08/93 → 01/95

ESCORT VII (GAL, AAL, ABL)

1.6 16V	Petrol	66	01/95 → 10/98
1.6 16V 4x4	Petrol	66	01/95 → 10/98
1.6 i 16V	Petrol	65	01/95 → 08/95
1.8 16V	Petrol	77	01/95 → 08/95
1.8 16V	Petrol	85	01/95 → 10/98
RS 2000	Petrol	110	02/95 → 02/98
RS 2000 4x4	Petrol	110	02/95 → 10/98

ESCORT VII Cabriolet (ALL)

1.6 16V XR3i	Petrol	65	02/95 → 12/96
1.6 16V XR3i	Petrol	66	02/95 → 09/99
1.8 16V XR3i	Petrol	77	02/95 → 08/98
1.8 16V XR3i	Petrol	85	10/95 → 08/98
1.8 16V XR3i	Petrol	96	02/95 → 08/00

ESCORT VII Station wagon (GAL, ANL)

1.6 16V	Petrol	66	01/95 → 02/99
1.6 i 16V	Petrol	65	01/95 → 08/95
1.8 16V	Petrol	77	01/95 → 08/95
1.8 16V	Petrol	85	01/95 → 02/99

ESCORT VII Tre volumi (GAL, AFL)

1.6 i 16V	Petrol	65	01/95 → 08/95
1.6 i 16V	Petrol	66	01/95 → 02/99
1.8 16V	Petrol	77	01/95 → 08/95
1.8 16V	Petrol	85	01/95 → 02/99

FIESTA III (GFJ)

1.1	Petrol	37	12/92 → 12/95
1.1	Petrol	40	12/92 → 12/95
1.4	Petrol	52	12/92 → 12/95
1.4	Petrol	54	12/92 → 12/95
1.4 Cat.	Petrol	54	12/92 → 12/95

SVF001



FORD

FIESTA III (GFJ)

1.6	Petrol	65	12/92 → 01/94
1.6 i 16V	Petrol	65	01/94 → 12/95
1.6 XR2i	Petrol	76	12/92 → 03/93
1.6 XR2i	Petrol	81	12/92 → 01/94
1.8 16V	Petrol	77	02/92 → 12/95
1.8 XR2i 16V	Petrol	96	02/92 → 12/95

FIESTA IV (JA_, JB_)

1.6 16V Sport	Petrol	76	02/00 → 01/02
---------------	--------	----	---------------

FIESTA V (JH_, JD_)

1.6 16V	Petrol	74	11/01 → 06/08
---------	--------	----	---------------

SIERRA (GBG, GB4)

2.0 4x4	Petrol	92	12/92 → 02/93
2.0 i	Petrol	74	01/87 → 12/89
2.0 i	Petrol	92	12/92 → 02/93

SIERRA 2 volumi /Coda spiovente (GBC, GBG)

2.0 i	Petrol	74	12/92 → 02/93
2.0 i	Petrol	92	12/92 → 02/93

SIERRA Station wagon (BNG)

1.6 i	Petrol	59	12/92 → 02/93
2.0 4x4	Petrol	88	12/92 → 02/93
2.0 4x4	Petrol	92	12/92 → 02/93
2.0 i	Petrol	74	12/92 → 02/93
2.0 i	Petrol	85	12/92 → 02/93
2.0 i	Petrol	88	12/92 → 02/93
2.0 i	Petrol	92	12/92 → 02/93
2.0 i Cat.	Petrol	74	12/92 → 02/93

SVF005

B6 **SENSORE POSIZIONE FARFALLA**
THROTTLE POSITION SENSOR



FORD

ESCORT CLASSIC (AAL, ABL)

1.6 16V	Petrol	66	10/98 → 07/00	ENGINE: ZETEC-E
---------	--------	----	---------------	-----------------

SVF005

FORD
ESCORT CLASSIC Turnier (ANL)

1.6 16V	Petrol	66	02/99 → 07/00	ENGINE: ZETEC-E
---------	--------	----	---------------	-----------------

ESCORT VII (GAL, AAL, ABL)

1.6 16V	Petrol	66	08/95 → 10/98	ENGINE: ZETEC-E
---------	--------	----	---------------	-----------------

1.6 16V 4x4	Petrol	66	08/95 → 10/98	ENGINE: ZETEC-E
-------------	--------	----	---------------	-----------------

1.6 i 16V	Petrol	65	08/95 → 08/95	ENGINE: ZETEC-E
-----------	--------	----	---------------	-----------------

1.8 16V	Petrol	85	08/95 → 10/98	ENGINE: ZETEC-E
---------	--------	----	---------------	-----------------

ESCORT VII Cabriolet (ALL)

1.6 16V XR3i	Petrol	65	08/95 → 12/96	ENGINE: ZETEC-E
--------------	--------	----	---------------	-----------------

1.6 16V XR3i	Petrol	66	08/95 → 09/99	ENGINE: ZETEC-E
--------------	--------	----	---------------	-----------------

1.8 16V XR3i	Petrol	77	08/95 → 08/98	ENGINE: ZETEC-E
--------------	--------	----	---------------	-----------------

1.8 16V XR3i	Petrol	85	10/95 → 08/98	ENGINE: ZETEC-E
--------------	--------	----	---------------	-----------------

1.8 16V XR3i	Petrol	96	08/95 → 08/00	ENGINE: ZETEC-E
--------------	--------	----	---------------	-----------------

ESCORT VII Station wagon (GAL, ANL)

1.6 16V	Petrol	66	08/95 → 02/99	ENGINE: ZETEC-E
---------	--------	----	---------------	-----------------

1.6 i 16V	Petrol	65	08/95 → 08/95	ENGINE: ZETEC-E
-----------	--------	----	---------------	-----------------

1.8 16V	Petrol	85	08/95 → 02/99	ENGINE: ZETEC-E
---------	--------	----	---------------	-----------------

ESCORT VII Tre volumi (GAL, AFL)

1.6 i 16V	Petrol	65	08/95 → 08/95	ENGINE: ZETEC-E
-----------	--------	----	---------------	-----------------

1.6 i 16V	Petrol	66	08/95 → 02/99	ENGINE: ZETEC-E
-----------	--------	----	---------------	-----------------

1.8 16V	Petrol	85	08/95 → 02/99	ENGINE: ZETEC-E
---------	--------	----	---------------	-----------------

FOCUS (DAW, DBW)

RS	Petrol	158	10/02 → 11/04	
----	--------	-----	---------------	--

GALAXY (WGR)

2.0 i	Petrol	85	07/96 → 05/06	ENGINE: ZETEC-E20
-------	--------	----	---------------	-------------------

2.3 4x4	Petrol	107	09/96 → 03/00	ENGINE: DOHC23
---------	--------	-----	---------------	----------------

MONDEO I (GBP)

1.8 i 16V	Petrol	82	07/94 → 08/96	ENGINE: ZETEC-E
-----------	--------	----	---------------	-----------------

1.8 i 16V	Petrol	85	02/93 → 08/96	ENGINE: ZETEC-E
-----------	--------	----	---------------	-----------------

1.8 i 16V 4x4	Petrol	85	02/93 → 08/96	ENGINE: ZETEC-E
---------------	--------	----	---------------	-----------------

MONDEO I Station wagon (BNP)

1.8 i 16V	Petrol	82	07/94 → 08/96	ENGINE: ZETEC-E
-----------	--------	----	---------------	-----------------

1.8 i 16V	Petrol	85	04/93 → 08/96	ENGINE: ZETEC-E
-----------	--------	----	---------------	-----------------

1.8 i 16V 4x4	Petrol	85	04/93 → 08/96	ENGINE: ZETEC-E
---------------	--------	----	---------------	-----------------

MONDEO I Tre volumi (GBP)

1.8 i 16V	Petrol	82	01/94 → 08/96	ENGINE: ZETEC-E
-----------	--------	----	---------------	-----------------

1.8 i 16V	Petrol	85	02/93 → 08/96	ENGINE: ZETEC-E
-----------	--------	----	---------------	-----------------

TRANSIT Autobus (FD __, FB __, FS __, FZ __, FC __)

2.3 16V [RWD] (F_B __, F_C __, F_A __)	Petrol	107	08/00 → 05/06	ENGINE: DOHC23
--	--------	-----	---------------	----------------

TRANSIT Furgonato (FA __)

2.3 16V [RWD] (FAA __, FAB __, FAC __)	Petrol	107	04/01 → 05/06	ENGINE: DOHC23
--	--------	-----	---------------	----------------

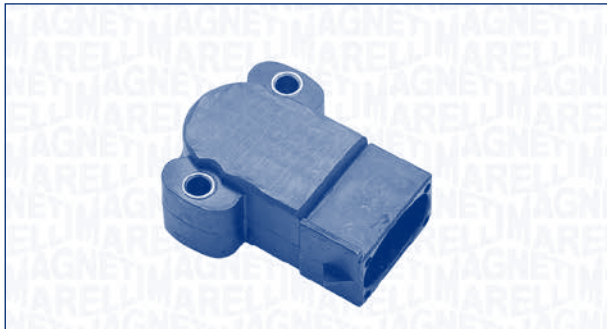
SVF006
B6
**SENSORE POSIZIONE FARFALLA
THROTTLE POSITION SENSOR**

FORD
ESCORT V (GAL)

1.8 16V XR3i	Petrol	77	02/92 → 12/92	ENGINE: ZETEC-E
--------------	--------	----	---------------	-----------------

1.8 16V XR3i	Petrol	96	02/92 → 12/92	ENGINE: ZETEC-E
--------------	--------	----	---------------	-----------------

ESCORT V Cabriolet (ALL)

1.8 16V XR3i	Petrol	77	02/92 → 12/92	ENGINE: ZETEC-E
--------------	--------	----	---------------	-----------------

1.8 16V XR3i	Petrol	96	02/92 → 12/92	ENGINE: ZETEC-E
--------------	--------	----	---------------	-----------------

ESCORT V Station wagon (GAL, AVL)

1.8 16V	Petrol	77	02/92 → 12/92	ENGINE: ZETEC-E
---------	--------	----	---------------	-----------------

ESCORT VI (GAL)

1.6 i 16V	Petrol	65	01/94 → 01/95	ENGINE: ZETEC-E
-----------	--------	----	---------------	-----------------

1.6 i 16V	Petrol	66	09/92 → 01/95	ENGINE: ZETEC-E
-----------	--------	----	---------------	-----------------

1.8 16V XR3i	Petrol	96	09/92 → 01/95	ENGINE: ZETEC-E
--------------	--------	----	---------------	-----------------

1.8 i 16V	Petrol	77	09/92 → 01/95	ENGINE: ZETEC-E
-----------	--------	----	---------------	-----------------

1.8 XR3i 16V 4x4	Petrol	77	08/93 → 01/95	ENGINE: ZETEC-E
------------------	--------	----	---------------	-----------------

1.8 XR3i 16V 4x4	Petrol	96	08/93 → 01/95	ENGINE: ZETEC-E
------------------	--------	----	---------------	-----------------

ESCORT VI Cabriolet (ALL)

1.4 i	Petrol	55	07/93 → 01/95	ENGINE: ZETEC-S
-------	--------	----	---------------	-----------------

1.6 16V XR3i	Petrol	66	12/92 → 01/95	ENGINE: ZETEC-E
--------------	--------	----	---------------	-----------------

1.8 16V XR3i	Petrol	77	12/92 → 01/95	ENGINE: ZETEC-E
--------------	--------	----	---------------	-----------------

1.8 16V XR3i	Petrol	96	12/92 → 01/95	ENGINE: ZETEC-E
--------------	--------	----	---------------	-----------------

ESCORT VI Station wagon (GAL)

1.4	Petrol	55	01/94 → 01/95	ENGINE: ZETEC-S
-----	--------	----	---------------	-----------------

1.6 i 16V	Petrol	66	09/92 → 01/95	ENGINE: ZETEC-E
-----------	--------	----	---------------	-----------------

1.8 i 16V	Petrol	77	01/93 → 01/95	ENGINE: ZETEC-E
-----------	--------	----	---------------	-----------------

1.8 i 16V	Petrol	96	02/93 → 01/95	ENGINE: ZETEC-E
-----------	--------	----	---------------	-----------------

ESCORT VI Tre volumi (GAL)

1.4	Petrol	55	08/93 → 01/95	ENGINE: ZETEC-S
-----	--------	----	---------------	-----------------

1.6 i 16V	Petrol	66	08/93 → 01/95	ENGINE: ZETEC-E
-----------	--------	----	---------------	-----------------

1.8 i 16V	Petrol	77	08/93 → 01/95	ENGINE: ZETEC-E
-----------	--------	----	---------------	-----------------

SVF006



kw



FORD

ESCORT VII (GAL, AAL, ABL)

1.3	Petrol	44	01/95 → 10/98	ENGINE: HCS
1.6 16V	Petrol	66	01/95 → 10/98	ENGINE: ZETEC-E
1.6 16V 4x4	Petrol	66	01/95 → 10/98	ENGINE: ZETEC-E
1.8 16V	Petrol	77	01/95 → 08/95	ENGINE: ZETEC-E
1.8 16V	Petrol	85	01/95 → 10/98	ENGINE: ZETEC-E

ESCORT VII Cabriolet (ALL)

1.4	Petrol	55	02/95 → 08/98	ENGINE: ZETEC-S
1.6 16V XR3i	Petrol	65	02/95 → 12/96	ENGINE: ZETEC-E
1.6 16V XR3i	Petrol	66	02/95 → 09/99	ENGINE: ZETEC-E

ESCORT VII Station wagon (GAL, ANL)

1.3	Petrol	44	01/95 → 01/99	ENGINE: HCS
1.6 16V	Petrol	66	01/95 → 02/99	ENGINE: ZETEC-E
1.8 16V	Petrol	77	01/95 → 08/95	ENGINE: ZETEC-E
1.8 16V	Petrol	85	01/95 → 02/99	ENGINE: ZETEC-E

ESCORT VII Tre volumi (GAL, AFL)

1.3	Petrol	44	01/95 → 02/99	ENGINE: HCS13EFI
1.6 i 16V	Petrol	66	01/95 → 02/99	ENGINE: ZETEC-E
1.8 16V	Petrol	77	01/95 → 08/95	ENGINE: ZETEC-E
1.8 16V	Petrol	85	01/95 → 02/99	ENGINE: ZETEC-E

FIESTA III (GFJ)

1.4 Cat.	Petrol	54	03/89 → 12/95	ENGINE: ZETEC-S
1.6 i 16V	Petrol	65	01/94 → 12/95	ENGINE: ZETEC-E
1.8 16V	Petrol	77	02/92 → 12/95	ENGINE: ZETEC-E
1.8 XR2i 16V	Petrol	96	02/92 → 12/95	ENGINE: ZETEC-E

FIESTA IV (JA_, JB_)

1.0 i	Petrol	38	02/97 → 09/99	
1.25 i 16V	Petrol	55	08/95 → 12/99	ENGINE: ZETEC-S
1.3 i	Petrol	37	08/95 → 01/02	ENGINE: HCS13EFI
1.3 i	Petrol	44	08/95 → 01/02	ENGINE: HCS13EFI

KA (RB_)

1.3 i	Petrol	36	06/98 → 11/08	ENGINE: HCS13EFI
-------	--------	----	---------------	------------------

ORION III (GAL)

1.6	Petrol	66	07/90 → 12/92	ENGINE: ZETEC-E
1.6 i	Petrol	77	07/90 → 09/92	ENGINE: ZETEC-E

PUMA (EC_)

1.4 16V	Petrol	66	11/97 → 10/00	ENGINE: CVH
---------	--------	----	---------------	-------------

SVF008

B6

**SENSORE POSIZIONE FARFALLA
THROTTLE POSITION SENSOR**



kw



FORD

FIESTA IV (JA_, JB_)

1.25 i 16V	Petrol	55	12/96 → 01/02	ENGINE: ZETEC-S
------------	--------	----	---------------	-----------------

FIESTA V (JH_, JD_)

1.25 16V	Petrol	51	03/03 → 06/08	ENGINE: ZETEC-S
1.25 16V	Petrol	55	05/02 → 06/08	ENGINE: ZETEC-S
1.3	Petrol	44	11/01 → 06/08	ENGINE: ROCAM13SOHC
1.3	Petrol	51	11/01 → 06/08	ENGINE: ROCAM13SOHC

FOCUS (DAW, DBW)

1.4 16V	Petrol	55	10/98 → 11/04	ENGINE: ZETEC-S
1.6 16V	Petrol	74	10/98 → 11/04	ENGINE: ZETECROCAM16SOHC

FOCUS C-MAX

1.6	Petrol	74	10/03 → 05/05	ENGINE: ZETEC-S
-----	--------	----	---------------	-----------------

FOCUS Station wagon (DNW)

1.4 16V	Petrol	55	02/99 → 11/04	ENGINE: ZETEC-S
1.6 16V	Petrol	74	02/99 → 11/04	ENGINE: ZETECROCAM16SOHC

FOCUS Tre volumi (DFW)

1.4 16V	Petrol	55	02/99 → 11/04	ENGINE: ZETEC-S
1.6 16V	Petrol	74	02/99 → 11/04	ENGINE: ZETECROCAM16SOHC

KA (RB_)

1.3 i	Petrol	36	10/02 → 11/08	ENGINE: ROCAM13SOHC
1.3 i	Petrol	51	10/02 → 11/08	ENGINE: ROCAM13SOHC

MAVERICK

2.0 16V	Petrol	91	02/01 →	ENGINE: ZETEC2016VEFI
2.3 16V	Petrol	110	03/04 →	ENGINE: DOHC23

SVF008

KW

FORD
MONDEO II (BAP)

1.6 i 16V	Petrol	70	05/98 → 11/00	ENGINE: ZETECROCAM16SOHC
2.5 24V	Petrol	125	10/00 → 11/00	
2.5 ST 200	Petrol	151	10/00 → 11/00	

MONDEO II Station wagon (BNP)

1.6 i 16V	Petrol	70	05/98 → 11/00	ENGINE: ETECROCAM16SOHC
2.5 24V	Petrol	125	10/00 → 11/00	
2.5 ST 200	Petrol	151	10/00 → 11/00	

MONDEO II Tre volumi (BFP)

1.6 i 16V	Petrol	70	05/98 → 11/00	ENGINE: ZETECROCAM16SOHC
2.5 24V	Petrol	125	10/00 → 11/00	
2.5 ST 200	Petrol	151	10/00 → 11/00	

MONDEO III (B5Y)

1.8 16V	Petrol	81	11/00 → 08/07	ENGINE: DURATECHE18SCI
1.8 16V	Petrol	92	11/00 → 08/07	ENGINE: DURATECHE18SCI
2.0 16V	Petrol	107	11/00 → 08/07	ENGINE: ZETEC2016VEFI
2.5 V6 24V	Petrol	125	11/00 → 08/07	

MONDEO III Station wagon (BWY)

1.8 16V	Petrol	81	11/00 → 08/07	ENGINE: DURATECHE18SCI
1.8 16V	Petrol	92	11/00 → 08/07	ENGINE: DURATECHE18SCI
2.0 16V	Petrol	107	11/00 → 08/07	ENGINE: ZETEC2016VEFI
2.5 V6 24V	Petrol	125	11/00 → 08/07	

MONDEO III Tre volumi (B4Y)

1.8 16V	Petrol	81	11/00 → 08/07	ENGINE: DURATECHE18SCI
1.8 16V	Petrol	92	11/00 → 08/07	ENGINE: DURATECHE18SCI
2.0 16V	Petrol	107	11/00 → 08/07	ENGINE: ZETEC2016VEFI
2.5 V6 24V	Petrol	125	11/00 → 08/07	

PUMA (EC_)

1.6 16V	Petrol	76	08/00 → 06/02	ENGINE: ZETECROCAM16SOHC
---------	--------	----	---------------	-----------------------------

SVF009
B6
**SENSORE POSIZIONE FARFALLA
THROTTLE POSITION SENSOR**

KW

ALFA ROMEO
164 (164)

3.0 i.e. QV (164.AG)	Petrol	147	09/90 → 09/92	
3.0 V6 (164.A)	Petrol	141	06/87 → 09/92	
3.0 V6 (164.AD, 164.AH, 164.AB)	Petrol	135	04/88 → 09/92	

75 (162B)

1.8 (162.B1H)	Petrol	90	08/89 → 02/92	
1.8 (162.B1H)	Petrol	95	08/89 → 02/92	
1.8 (162.B1L, 162.B1F)	Petrol	88	09/88 → 02/92	
3.0 V6 (162.B6C)	Petrol	141	02/90 → 02/92	

RZ

3.0 V6 Zagato	Petrol	152	01/92 → 02/92	
---------------	--------	-----	---------------	--

SPIDER (115)

2000	Petrol	88	01/90 → 12/93	
2000 Veloce	Petrol	93	01/90 → 12/93	

LANCIA
THEMA (834)

2000 i.e. 16V (834AA)	Petrol	108	05/88 → 05/92	
2000 i.e. 16V (834AI)	Petrol	104	02/89 → 05/92	

THEMA SW (834)

2000 i.e. 16V (834AA)	Petrol	108	05/89 → 05/92	
2000 i.e. 16V (834AI)	Petrol	104	02/89 → 05/92	

SAAB
900 I (AC4, AM4)

2.0 i	Petrol	81	09/85 → 08/90	
-------	--------	----	---------------	--

SVF009



SAAB

900 I Cabriolet

2.0 -16	Petrol	93	01/90 → 08/93
2.0 S Turbo-16	Petrol	104	09/91 → 08/93
2.0 Turbo-16	Petrol	118	09/90 → 08/93

900 I Combi Coupe

2.0 -16	Petrol	93	01/89 → 08/92
2.0 i	Petrol	81	09/85 → 08/90
2.0 S Turbo-16	Petrol	104	09/91 → 07/93
2.0 Turbo-16	Petrol	118	11/85 → 08/89
2.0 Turbo-16 S	Petrol	129	02/84 → 12/88

9000

2.0 -16 Turbo	Petrol	118	05/88 → 08/90
2.0 -16 Turbo CD	Petrol	120	09/88 → 08/90
2.0 -16 Turbo CD	Petrol	136	09/89 → 08/90

9000 2 volumi /Coda spiovente

2.0 -16	Petrol	92	08/86 → 12/88
2.0 -16	Petrol	94	12/85 → 08/88
2.0 -16 CS	Petrol	94	09/89 → 08/90
2.0 -16 Turbo	Petrol	118	01/90 → 08/90
2.0 -16 Turbo	Petrol	120	05/88 → 08/90
2.0 -16 Turbo	Petrol	129	09/84 → 08/90
2.0 -16 Turbo CS	Petrol	136	09/88 → 08/90
2.3 -16 CS	Petrol	107	09/89 → 08/90

SVF010

B6 **SENSORE POSIZIONE FARFALLA**
THROTTLE POSITION SENSOR



BMW

5 (E34)

520 i	Petrol	95	01/88 → 12/90
525 i	Petrol	125	01/88 → 12/90

Z1

2.5	Petrol	125	06/88 → 06/91
-----	--------	-----	---------------

SVF010



CITROËN

BX (XB-_)

16	Petrol	76	03/86 → 02/93
19 GTi	Petrol	90	07/86 → 05/90
19 GTi	Petrol	88	06/88 → 02/93
19 GTi 16V	Petrol	108	03/88 → 02/93
19 GTi 4x4	Petrol	88	06/88 → 02/93

BX Break (XB-_)

16	Petrol	76	03/86 → 12/94
19	Petrol	88	06/88 → 03/93
19 Cat.	Petrol	75	07/86 → 12/94

VISA

16 GTI	Petrol	83	06/86 → 03/91
--------	--------	----	---------------

ZX (N2)

1.9 i	Petrol	88	03/91 → 06/97
-------	--------	----	---------------

FERRARI

328 GTB

3.2	Petrol	199	09/85 → 09/89
3.2	Petrol	199	09/85 → 09/89

MONDIAL

3.2 Quattrovalvole	Petrol	199	10/85 → 12/87
--------------------	--------	-----	---------------

MONDIAL Cabriolet

3.2 Quattrovalvole	Petrol	199	09/85 → 12/87
--------------------	--------	-----	---------------

TESTAROSSA

5.0	Petrol	272	08/86 → 10/91
5.0	Petrol	287	01/86 → 10/91

PEUGEOT

205 I Cabriolet (741B, 20D)

1.6 CTI	Petrol	76	04/86 → 10/87
1.9 CTI	Petrol	75	10/87 → 10/94

205 II (20A/C)

1.9 GTI	Petrol	88	10/87 → 10/94
1.9 GTI	Petrol	94	10/87 → 09/98
1.9 GTI Cat.	Petrol	75	10/87 → 07/94

309 II (3C, 3A)

1.9	Petrol	72	08/89 → 12/93
1.9 GTI	Petrol	88	07/89 → 12/93
1.9 GTI 16V	Petrol	116	02/90 → 07/90

405 I (15B)

1.9	Petrol	88	07/88 → 12/92
1.9 Injection	Petrol	77	07/87 → 12/92
1.9 Sport MI-16	Petrol	108	04/88 → 12/92
1.9 Sport MI-16	Petrol	116	07/87 → 11/91
1.9 SPort MI-16 4x4	Petrol	108	04/88 → 12/92

SVF010

PEUGEOT
405 I Break (15E)

1.9	Petrol	77	10/88 → 08/92
1.9	Petrol	88	10/88 → 08/92

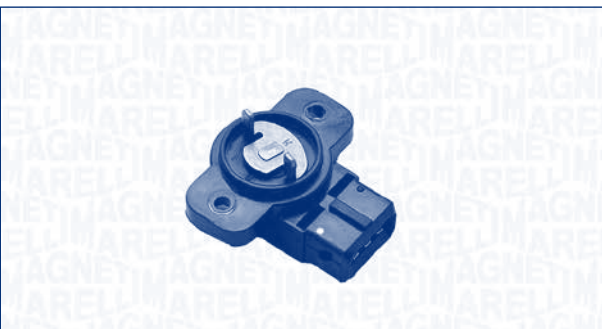
SVF011
B6 **SENSORE POSIZIONE FARFALLA**
THROTTLE POSITION SENSOR

HYUNDAI
ATOS (MX)

1.0 i	Petrol	43	03/01 →
-------	--------	----	---------

ATOS PRIME (MX)

1.0 i	Petrol	43	03/01 →
-------	--------	----	---------

COUPE (GK)

2.7 V6	Petrol	123	03/02 → 08/09
--------	--------	-----	---------------

H-1 Furgonato

2.4	Petrol	82	03/00 → 04/04
-----	--------	----	---------------

SONATA IV (EF)

2.5 V6 24V	Petrol	118	06/98 → 10/01
------------	--------	-----	---------------

SONATA IV (EF)

2.7 V6	Petrol	127	10/01 → 11/04
--------	--------	-----	---------------

TRAJET (FO)

2.7 V6	Petrol	127	09/00 → 07/08
--------	--------	-----	---------------

TUCSON (JM)

2.7 Trazione integrale	Petrol	129	08/04 → 03/10
------------------------	--------	-----	---------------

XG (XG)

250	Petrol	120	12/98 → 12/05
-----	--------	-----	---------------

SVF012
B6 **SENSORE POSIZIONE FARFALLA**
THROTTLE POSITION SENSOR

BMW
3 (E30)

316 i	Petrol	73	09/88 → 06/91
316 i	Petrol	75	09/88 → 06/91
318 i	Petrol	83	09/87 → 06/91
318 i	Petrol	85	09/87 → 06/91

3 Cabriolet (E30)

318 i	Petrol	83	09/90 → 10/93
-------	--------	----	---------------

3 Touring (E30)

318 i	Petrol	83	04/89 → 06/94
318 i	Petrol	85	04/89 → 06/91

5 (E34)

518 i	Petrol	83	08/89 → 09/91
-------	--------	----	---------------

OPEL
CORSA A 2 volumi /Coda spiovente (93_, 94_, 98_, 99_)

1.6 GSI	Petrol	74	05/88 → 03/92
---------	--------	----	---------------

KADETT E (39_, 49_)

1.8	Petrol	84	09/87 → 08/90
-----	--------	----	---------------

OMEGA A (16_, 17_, 19_)

1.8	Petrol	85	09/86 → 03/94
-----	--------	----	---------------

OMEGA A Station wagon (66_, 67_)

1.8	Petrol	85	09/86 → 03/94
-----	--------	----	---------------

VECTRA A (86_, 87_)

2.0	Petrol	74	09/88 → 09/89
2.0 i	Petrol	85	09/88 → 08/90
2.0 i	Petrol	95	09/88 → 08/90
2.0 i 4x4	Petrol	85	01/89 → 08/90
2.0 i 4x4	Petrol	95	01/89 → 08/90

VECTRA A 2 volumi /Coda spiovente (88_, 89_)

2.0	Petrol	74	09/88 → 09/89
2.0 i	Petrol	85	09/88 → 08/90
2.0 i GT	Petrol	95	09/88 → 08/90

SVF012



kw



VAUXHALL

ASTRA Mk II 2 volumi /Coda spiovente

1.8 GTE	Petrol	82	09/86 → 08/91
2.0 GTE	Petrol	95	09/86 → 08/91

ASTRA Mk II Belmont

1.8	Petrol	82	01/86 → 12/90
1.8 i	Petrol	85	09/86 → 08/91

CARLTON Mk III

1.8 i	Petrol	85	09/86 → 03/94
2.0 i	Petrol	90	09/86 → 03/94

CARLTON Mk III Station wagon

1.8 i	Petrol	85	09/86 → 03/94
2.0 i	Petrol	90	09/86 → 03/94

SVF013

B6 **SENSORE POSIZIONE FARFALLA**
THROTTLE POSITION SENSOR



kw



OPEL

ASTRA F (56_, 57_)

1.4 Si	Petrol	60	03/92 → 09/98
1.6 i 16V	Petrol	74	08/94 → 09/98
1.6 Si	Petrol	74	05/92 → 12/94

ASTRA F 2 volumi /Coda spiovente (53_, 54_, 58_, 59_)

1.4 Si	Petrol	60	03/92 → 01/98
--------	--------	----	---------------

SVF013



kw



OPEL

ASTRA F 2 volumi /Coda spiovente (53_, 54_, 58_, 59_)

1.6 i 16V	Petrol	74	08/94 → 01/98
1.6 Si	Petrol	74	03/92 → 12/94

ASTRA F Cabriolet (53_B)

1.4 Si	Petrol	60	05/93 → 03/01
--------	--------	----	---------------

ASTRA F CLASSIC 2 volumi /Coda spiovente

1.6 i 16V	Petrol	74	01/98 → 08/02
-----------	--------	----	---------------

ASTRA F CLASSIC Station wagon

1.6 i 16V	Petrol	74	01/98 → 01/05
-----------	--------	----	---------------

ASTRA F CLASSIC Tre volumi

1.6 i 16V	Petrol	74	01/98 → 08/02
-----------	--------	----	---------------

ASTRA F Station wagon (51_, 52_)

1.4 Si	Petrol	60	03/92 → 01/98
1.6 i 16V	Petrol	74	08/94 → 01/98
1.6 Si	Petrol	74	03/92 → 12/94

ASTRA G 2 volumi /Coda spiovente (F48_, F08_)

1.4 16V	Petrol	66	02/98 → 01/05
1.6 16V	Petrol	74	02/98 → 01/05

ASTRA G Station wagon (F35_)

1.4 16V	Petrol	66	06/98 → 07/04
1.6 16V	Petrol	74	02/98 → 07/04

ASTRA G Tre volumi (F69_)

1.4 16V	Petrol	66	09/98 → 01/05
1.6 16V	Petrol	74	09/98 → 01/05

COMBO (71_)

1.4	Petrol	60	07/94 → 10/01
1.4 16V	Petrol	66	08/99 → 10/01

CORSA A 2 volumi /Coda spiovente (93_, 94_, 98_, 99_)

1.4 Si	Petrol	60	09/91 → 03/93
--------	--------	----	---------------

CORSA B (73_, 78_, 79_)

1.4 i 16V	Petrol	63	08/97 → 09/00
1.4 i 16V	Petrol	66	09/94 → 09/00
1.4 Si	Petrol	60	03/93 → 09/00
1.6 GSI 16V	Petrol	80	03/93 → 09/00
1.6 i 16V	Petrol	74	08/97 → 09/00
1.6 i 16V	Petrol	78	09/94 → 09/00

FRONTERA B (6B_)

2.2 i (6B_ZC, 6B_VF, 6B_66, 6B_76)	Petrol	100	10/98 →	CHASSIS: → YV5999999
------------------------------------	--------	-----	---------	-------------------------

TIGRA (95_)

1.4 16V	Petrol	63	08/97 → 12/00
1.4 16V	Petrol	66	07/94 → 12/00
1.6 16V	Petrol	74	08/97 → 08/98
1.6 16V	Petrol	78	07/94 → 08/98

SVF013

OPEL
VECTRA B (36_)

1.6 i 16V	Petrol	74	10/95 → 04/02
-----------	--------	----	---------------

VECTRA B 2 volumi /Coda spiovente (38_)

1.6 i 16V	Petrol	74	10/95 → 07/02
-----------	--------	----	---------------

ZAFIRA A (F75_)

1.6 16V	Petrol	74	04/99 → 06/05
---------	--------	----	---------------

VAUXHALL
ASTRA Mk III (F)

1.4 i	Petrol	60	04/92 → 09/98
-------	--------	----	---------------

1.4 i 16V	Petrol	66	02/96 → 09/98
-----------	--------	----	---------------

1.6 i	Petrol	74	05/92 → 12/94
-------	--------	----	---------------

1.6 i 16V	Petrol	74	08/94 → 09/98
-----------	--------	----	---------------

ASTRA Mk III (F) 2 volumi /Coda spiovente

1.4 i	Petrol	60	03/92 → 02/98
-------	--------	----	---------------

1.4 i 16V	Petrol	66	02/96 → 02/98
-----------	--------	----	---------------

1.6 i	Petrol	74	03/92 → 02/98
-------	--------	----	---------------

ASTRA Mk III (F) Cabriolet

1.4 i	Petrol	60	05/93 → 03/01
-------	--------	----	---------------

1.4 i 16V	Petrol	66	01/96 → 03/01
-----------	--------	----	---------------

ASTRA Mk III (F) Station wagon

1.4 i	Petrol	60	03/91 → 02/98
-------	--------	----	---------------

1.4 i 16V	Petrol	66	02/96 → 01/98
-----------	--------	----	---------------

1.6 i 16V	Petrol	74	01/94 → 02/98
-----------	--------	----	---------------

1.6 Si	Petrol	74	03/91 → 12/94
--------	--------	----	---------------

ASTRA Mk IV (G) 2 volumi /Coda spiovente

1.4 16V	Petrol	66	02/98 → 05/05
---------	--------	----	---------------

1.6 16V	Petrol	74	02/98 → 05/05
---------	--------	----	---------------

ASTRA Mk IV (G) Station wagon

1.4 16V	Petrol	66	02/98 → 05/05
---------	--------	----	---------------

1.6 16V	Petrol	74	03/98 → 04/04
---------	--------	----	---------------

ASTRA Mk IV (G) Tre volumi

1.4 16V	Petrol	66	09/98 → 05/05
---------	--------	----	---------------

1.6 16V	Petrol	74	09/98 → 05/05
---------	--------	----	---------------

COMBO Mk I (B)

1.4	Petrol	60	07/94 → 10/01
-----	--------	----	---------------

COMBO Mk II (C) Cassone / Furgonato / Promiscuo (F25)

1.4 i 16V	Petrol	66	01/04 → 11/11
-----------	--------	----	---------------

FRONTERA Mk II (B)

2.2 i	Petrol	100	10/98 → 10/04	CHASSIS: → YV5999999
-------	--------	-----	---------------	-------------------------

NOVA 2 volumi /Coda spiovente

1.6 GSI	Petrol	74	05/88 → 03/92
---------	--------	----	---------------

SVF013

VAUXHALL
TIGRA Mk I (F07)

1.4 16V	Petrol	66	07/94 → 12/00
---------	--------	----	---------------

1.6 16V	Petrol	78	07/94 → 12/00
---------	--------	----	---------------

VECTRA (B)

1.6 i 16V	Petrol	74	08/95 → 10/01
-----------	--------	----	---------------

VECTRA (B) 2 volumi /Coda spiovente

1.6 i 16V	Petrol	74	08/95 → 10/01
-----------	--------	----	---------------

VECTRA (B) Station wagon

1.6 i 16V	Petrol	74	11/96 → 03/02
-----------	--------	----	---------------

ZAFIRA Mk I (A) (F75)

1.6 16V	Petrol	74	04/99 → 08/05
---------	--------	----	---------------

SVF014
B6 **SENSORE POSIZIONE FARFALLA**
THROTTLE POSITION SENSOR

OPEL
ASTRA F (56_, 57_)

1.4 i	Petrol	44	09/91 → 09/98
-------	--------	----	---------------

1.6	Petrol	55	09/95 → 09/98
-----	--------	----	---------------

1.6 i	Petrol	52	05/93 → 07/96
-------	--------	----	---------------

1.6 i	Petrol	55	03/92 → 09/98
-------	--------	----	---------------

ASTRA F 2 volumi /Coda spiovente (53_, 54_, 58_, 59_)

1.4 i	Petrol	44	03/92 → 01/98
-------	--------	----	---------------

1.6	Petrol	55	09/95 → 01/98
-----	--------	----	---------------

1.6 i	Petrol	52	05/93 → 07/96
-------	--------	----	---------------

1.6 i	Petrol	55	09/91 → 01/98
-------	--------	----	---------------

1.8 i	Petrol	66	09/91 → 01/98
-------	--------	----	---------------

SVF014



KW



OPEL

ASTRA F CLASSIC 2 volumi /Coda spiovente

1.4 i Petrol 44 01/98 → 08/02

ASTRA F CLASSIC Station wagon

1.4 i Petrol 44 01/98 → 01/05

1.6 i Petrol 55 01/98 → 01/05

ASTRA F CLASSIC Tre volumi

1.4 i Petrol 44 01/98 → 08/02

ASTRA F Station wagon (51_, 52_)

1.4 i Petrol 44 09/91 → 01/98

1.6 Petrol 55 09/95 → 01/98

1.6 i Petrol 52 05/93 → 07/96

1.6 i Petrol 55 09/91 → 01/98

1.8 i Petrol 66 09/91 → 01/98

ASTRA F Van (55_)

1.4 i Petrol 44 10/91 → 01/99

1.6 i Petrol 55 10/91 → 04/93

ASTRA G 2 volumi /Coda spiovente (F48_, F08_)

1.6 Petrol 55 02/98 → 09/00

ASTRA G Furgonato (F70)

1.6 Petrol 55 01/99 → 09/00

ASTRA G Station wagon (F35_)

1.6 Petrol 55 02/98 → 09/00

ASTRA G Tre volumi (F69_)

1.6 Petrol 55 09/98 → 09/00

COMBO (71_)

1.2 Petrol 33 07/94 → 10/01

1.4 Petrol 44 07/94 → 10/01

CORSA A 2 volumi /Coda spiovente (93_, 94_, 98_, 99_)

1.3 i Petrol 44 09/86 → 09/90

1.4 i Petrol 40 01/85 → 03/93

1.4 i Petrol 44 01/90 → 03/93

1.6 GSI Petrol 55 08/88 → 09/92

CORSA A TR (91_, 92_, 96_, 97_)

1.2 i Petrol 33 09/89 → 03/93

1.4 i Petrol 44 10/89 → 03/93

CORSA B (73_, 78_, 79_)

1.2 i Petrol 33 03/93 → 09/00

1.2 i Petrol 33 03/93 → 09/00

CORSA B Furgonato (73_)

1.4 i Petrol 44 08/99 → 09/00

KADETT E Cabriolet (43B_)

1.4 i Petrol 44 01/90 → 08/91

KADETT E Combo (38_, 48_)

1.4 i Petrol 44 08/91 → 07/94

1.6 i Petrol 55 08/91 → 07/94

SVF014



KW



OPEL

KADETT E Furgonato (37_, 47_)

1.4 i Petrol 44 01/90 → 08/91

1.6 i Petrol 55 08/89 → 09/93

1.8 i Petrol 66 08/84 → 09/92

VECTRA A (86_, 87_)

1.6 i Petrol 52 09/93 → 11/95

1.6 i Petrol 55 09/88 → 11/95

1.6 i Petrol 55 09/93 → 11/95

VECTRA A 2 volumi /Coda spiovente (88_, 89_)

1.6 i Petrol 55 09/93 → 11/95

1.6 i Cat. Petrol 55 09/88 → 11/95

1.8 i Cat. Petrol 66 03/90 → 11/95

VECTRA B (36_)

1.6 i Petrol 55 10/95 → 04/02

1.6 i Petrol 55 10/95 → 04/02

VECTRA B 2 volumi /Coda spiovente (38_)

1.6 i Petrol 55 10/95 → 07/03

1.6 i Petrol 55 10/95 → 07/03

VECTRA B Station wagon (31_)

1.6 i Petrol 55 11/96 → 06/00

VAUXHALL

ASTRA Mk III (F)

1.4 i Petrol 44 04/92 → 09/98

1.6 i Petrol 52 08/94 → 07/96

1.6 i Petrol 55 03/92 → 09/98

1.8 i Petrol 66 03/92 → 09/98

ASTRA Mk III (F) 2 volumi /Coda spiovente

1.4 i Petrol 44 09/91 → 02/98

1.6 i Petrol 52 07/94 → 02/98

1.6 i Petrol 55 09/91 → 02/98

1.8 i Petrol 66 09/91 → 02/98

ASTRA Mk III (F) Cabriolet

1.6 i Petrol 52 03/93 → 08/96

1.6 i Petrol 55 01/96 → 03/01

ASTRA Mk III (F) Station wagon

1.4 i Petrol 44 09/91 → 02/98

1.6 i Petrol 52 07/94 → 02/98

1.6 i Petrol 55 09/91 → 02/98

1.8 i Petrol 66 09/91 → 02/98

ASTRA Mk IV (G) 2 volumi /Coda spiovente

1.6 Petrol 55 02/98 → 09/00

ASTRA Mk IV (G) Station wagon

1.6 Petrol 55 03/98 → 04/04

ASTRA Mk IV (G) Tre volumi

1.6 Petrol 55 09/98 → 09/00

SVF014

VAUXHALL
ASTRAVAN Mk III (F)

1.4 i	Petrol	44	01/91 → 10/94
1.6 i	Petrol	52	02/94 → 10/96
1.6 i	Petrol	55	01/91 → 08/98

ASTRAVAN Mk IV (G)

1.6 i	Petrol	55	08/98 → 09/00
-------	--------	----	---------------

CAVALIER Mk III (87)

1.6 i	Petrol	52	09/93 → 11/95
1.6 i	Petrol	55	09/88 → 11/95
1.8 i Cat.	Petrol	66	03/90 → 11/95

CAVALIER Mk III 2 volumi /Coda spiovente

1.6 i	Petrol	52	09/93 → 11/95
1.6 i	Petrol	55	09/88 → 11/95
1.8 i Cat.	Petrol	66	03/90 → 11/95

COMBO Mk I (B)

1.2	Petrol	33	07/94 → 10/01
1.4	Petrol	44	07/94 → 10/01

CORSAVAN Mk I (B)

1.4 i	Petrol	44	01/94 → 09/00
-------	--------	----	---------------

VECTRA (B)

1.6 i	Petrol	55	08/95 → 10/01
-------	--------	----	---------------

VECTRA (B) 2 volumi /Coda spiovente

1.6 i	Petrol	55	08/95 → 10/01
-------	--------	----	---------------

VECTRA (B) Station wagon

1.6 i	Petrol	55	11/96 → 03/02
-------	--------	----	---------------

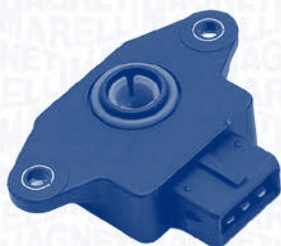
SVF015
B6 **SENSORE POSIZIONE FARFALLA**
THROTTLE POSITION SENSOR

ALFA ROMEO
145 (930)

1.6 i.e.	Petrol	76	10/94 → 12/94
1.7 i.e. 16V	Petrol	95	10/94 → 12/96
2.0 16V T.S.	Petrol	110	10/95 → 04/98

SVF015

ALFA ROMEO
145 (930)

1.7 i.e. 16V	Petrol	95	12/94 → 12/96
2.0 16V T.S.	Petrol	110	10/95 → 04/98

155 (167)

1.7 T.S.	Petrol	83	04/93 → 04/96
----------	--------	----	---------------

1.7 T.S. (167. A4D, 167.A4H)	Petrol	85	04/93 → 04/96
------------------------------	--------	----	---------------

1.8 T.S.	Petrol	95	02/92 → 06/93
----------	--------	----	---------------

1.8 T.S. Sport (167.A4A, 167. A4C, 167.A4E)	Petrol	93	01/92 → 04/96
---	--------	----	---------------

2.0 T.S. (167.A2)	Petrol	106	02/92 → 04/93
-------------------	--------	-----	---------------

2.0 T.S. (167.A2A)	Petrol	104	04/93 → 02/95
--------------------	--------	-----	---------------

2.0 T.S. 16V (167.A2G)	Petrol	110	03/95 → 10/97
------------------------	--------	-----	---------------

2.5 V6 (167.A1)	Petrol	121	02/92 → 04/96
-----------------	--------	-----	---------------

2.5 V6 (167.A1C, 167.A1E)	Petrol	120	05/96 → 12/97
---------------------------	--------	-----	---------------

164 (164)

2.0 T.S. (164.H3)	Petrol	106	09/92 → 09/98
-------------------	--------	-----	---------------

3.0 24V (164.K1)	Petrol	155	09/92 → 09/98
------------------	--------	-----	---------------

3.0 24V Q4 (164.K1M, 164.K1C)	Petrol	170	02/94 → 09/98
-------------------------------	--------	-----	---------------

3.0 24V QV (164.H1)	Petrol	171	09/92 → 09/98
---------------------	--------	-----	---------------

3.0 V6 (164. H1A, 164.H1B, 164.K1P)	Petrol	132	09/92 → 09/98
-------------------------------------	--------	-----	---------------

33 (907A)

1.5 i.e.	Petrol	71	04/92 → 09/94
----------	--------	----	---------------

1.7 i.e. (907.A1A)	Petrol	77	04/92 → 09/94
--------------------	--------	----	---------------

33 Sportwagon (907B)

1.5 i.e.	Petrol	71	04/92 → 09/94
----------	--------	----	---------------

1.7 i.e. (907.B1A)	Petrol	77	04/92 → 09/94
--------------------	--------	----	---------------

GTV (916C_)

2.0 T.SPARK 16V (916.C2_, 916C2C00)	Petrol	110	06/95 → 09/00
-------------------------------------	--------	-----	---------------

3.0 V6 24V (916.C1B_)	Petrol	160	10/00 → 10/05
-----------------------	--------	-----	---------------

SVF015

KW

ALFA ROMEO
SPIDER (916S_)

2.0 T.SPARK 16V (916S2B)	Petrol	114	05/98 → 08/00
-----------------------------	--------	-----	---------------

2.0 T.SPARK 16V (916S2C00)	Petrol	110	06/95 → 04/05
-------------------------------	--------	-----	---------------

3.0 V6 (916S1)	Petrol	141	06/95 → 09/00
----------------	--------	-----	---------------

3.0 V6 (916S1B00)	Petrol	160	09/94 → 08/00
----------------------	--------	-----	---------------

CITROËN
AX (ZA-_)

1.4 GTi	Petrol	74	06/91 → 12/92
---------	--------	----	---------------

BX (XB-_)

19 GTi	Petrol	90	05/90 → 07/90
--------	--------	----	---------------

EVASION (22, U6)

2.0 Turbo C.T.	Petrol	108	06/94 → 06/95
----------------	--------	-----	---------------

XANTIA (X1)

2.0 i 16V	Petrol	110	06/94 → 01/98
-----------	--------	-----	---------------

2.0 i 16V	Petrol	112	03/93 → 01/98
-----------	--------	-----	---------------

XM (Y3)

2.0 i	Petrol	89	05/89 → 06/94
-------	--------	----	---------------

2.0 i Turbo	Petrol	104	09/92 → 06/94
-------------	--------	-----	---------------

XM (Y4)

2.0 Turbo	Petrol	108	07/94 → 09/95
-----------	--------	-----	---------------

XM Break (Y3)

2.0 i	Petrol	89	11/91 → 04/94
-------	--------	----	---------------

2.0 Turbo	Petrol	104	09/92 → 04/94
-----------	--------	-----	---------------

ZX (N2)

2.0 i 16V	Petrol	110	06/94 → 05/95
-----------	--------	-----	---------------

2.0 i 16V	Petrol	112	07/92 → 10/94
-----------	--------	-----	---------------

FERRARI
456 GT/GTA

5.5 (F116)	Petrol	325	01/93 → 03/96
------------	--------	-----	---------------

512 TR

5.0	Petrol	315	01/92 → 10/94
-----	--------	-----	---------------

F355 BERLINETTA

3.5	Petrol	280	05/94 → 10/95
-----	--------	-----	---------------

F355 GTS

3.5 Spider	Petrol	280	07/94 → 10/95
------------	--------	-----	---------------

FIAT
BRAVO I (182)

2.0 HGT 20V (182.AD)	Petrol	108	10/95 → 07/98
-------------------------	--------	-----	---------------

PUNTO (176)

1.4 GT Turbo	Petrol	98	01/94 → 09/96
--------------	--------	----	---------------

SVF015

KW

FIAT
ULYSSE (220)

2.0 Turbo (220.AD5)	Petrol	108	09/94 → 06/95
------------------------	--------	-----	---------------

HYUNDAI
ACCENT I (X-3)

1.3	Petrol	44	10/94 → 07/99
-----	--------	----	---------------

1.3	Petrol	55	10/94 → 07/99
-----	--------	----	---------------

1.3 i 12V	Petrol	62	10/94 → 07/99
-----------	--------	----	---------------

1.5 i 12V	Petrol	65	10/94 → 07/99
-----------	--------	----	---------------

1.5 i 16V	Petrol	73	12/95 → 07/99
-----------	--------	----	---------------

ACCENT Tre volumi (X-3)

1.3	Petrol	44	10/94 → 07/99
-----	--------	----	---------------

1.3	Petrol	55	10/94 → 07/99
-----	--------	----	---------------

1.3 i 12V	Petrol	62	10/94 → 07/99
-----------	--------	----	---------------

1.5 i 12V	Petrol	65	10/94 → 07/99
-----------	--------	----	---------------

1.5 i 16V	Petrol	73	10/95 → 07/99
-----------	--------	----	---------------

COUPE (RD)

1.6 16V	Petrol	85	03/98 → 09/01
---------	--------	----	---------------

1.6 i 16V	Petrol	84	12/96 → 09/01
-----------	--------	----	---------------

LANTRA II (J-2)

1.5 12V	Petrol	65	12/96 → 09/00
---------	--------	----	---------------

1.6 16V	Petrol	84	11/95 → 09/00
---------	--------	----	---------------

1.6 i	Petrol	66	11/95 → 09/00
-------	--------	----	---------------

1.8 16V	Petrol	94	11/95 → 09/00
---------	--------	----	---------------

LANTRA II Wagon (J-2)

1.5 12V	Petrol	65	04/97 → 09/00
---------	--------	----	---------------

2.0 16V	Petrol	102	12/96 → 09/00
---------	--------	-----	---------------

S COUPE (SLC)

1.5 i	Petrol	65	07/92 → 04/95
-------	--------	----	---------------

1.5 i Turbo	Petrol	85	07/92 → 04/95
-------------	--------	----	---------------

KIA
CARENS I (FC)

1.8 i	Petrol	81	11/00 → 07/02
-------	--------	----	---------------

CARNIVAL I (UP)

2.5 V6	Petrol	121	08/99 → 10/01
--------	--------	-----	---------------

CARNIVAL II (GQ)

2.5 V6	Petrol	110	10/01 →
--------	--------	-----	---------

PRIDE Station wagon

1.3	Petrol	47	08/99 → 01/00
-----	--------	----	---------------

RETONA (CE)

2.0 16V	Petrol	94	05/00 → 12/00
---------	--------	----	---------------

RIO Station wagon (DC)

1.3	Petrol	55	08/00 → 02/05
-----	--------	----	---------------

1.3	Petrol	60	08/00 → 02/05
-----	--------	----	---------------

1.5 16V	Petrol	71	09/02 → 02/05
---------	--------	----	---------------

SVF015

KIA
RIO Station wagon (DC)

1.5 16V Petrol 72 08/00 → 02/05

RIO Tre volumi (DC_)

1.3 Petrol 55 09/00 → 02/05

1.5 16V Petrol 72 09/00 → 02/05

SHUMA (FB)

1.5 i 16V Petrol 65 10/97 → 03/01

1.8 i 16V Petrol 81 10/97 → 03/01

SHUMA II (FB)

1.6 Petrol 75 05/01 → 08/04

1.8 Petrol 84 04/03 → 08/04

SHUMA II Tre volumi (FB)

1.6 Petrol 75 05/01 → 05/04

SHUMA Tre volumi (FB)

1.5 i 16V Petrol 65 10/97 → 10/01

SPORTAGE (K00)

2.0 Petrol 87 10/00 → 08/03

2.0 4WD Petrol 87 10/00 → 08/03

2.0 i 16V Petrol 94 10/99 → 08/03

2.0 i 16V 4WD Petrol 94 04/94 → 10/98

2.0 i 4WD Petrol 70 04/94 → 09/98

LANCIA
KAPPA (838A)

2.0 16V Turbo (838AB1AA) Petrol 151 02/95 → 06/98

2.0 20V (838AA1AA) Petrol 107 10/94 → 06/96

2.0 20V Turbo (838AM1AA) Petrol 162 06/98 → 12/00

2.4 20V (838AC1AA, 838AC11A) Petrol 129 11/94 → 06/98

3.0 24V (838AD1AA, 838AD11A, 838XD1AA, 838ZD1AA) Petrol 150 11/94 → 06/98

KAPPA Coupé (838)

2.0 20V Petrol 114 07/96 → 06/98

2.0 20V Turbo (838CM) Petrol 162 06/98 → 06/00

KAPPA SW (838B)

2.0 20V Turbo (838BM1AA) Petrol 162 06/98 → 12/00

SVF015

LANCIA
THEMA (834)

3000 V6 (834GD, 834FD) Petrol 126 08/92 → 07/94

THEMA SW (834)

2000 16V (834FA) Petrol 112 05/92 → 07/94

THEMA SW (834)

3000 V6 (834GD, 834FD) Petrol 126 09/92 → 07/94

ZETA (220)

2.0 Turbo (220AD5, 220CD5) Petrol 108 05/95 → 06/95

OPEL

1.8 i 16V Petrol 85 09/95 → 09/98

1.8 i 16V Petrol 92 09/93 → 10/94

2.0 i Petrol 85 03/92 → 02/98

ASTRA F (56_, 57_)

2.0 i 16V Petrol 100 02/95 → 02/98

ASTRA F 2 volumi /Coda spiovente (53_, 54_, 58_, 59_)

1.8 i 16V Petrol 85 09/95 → 01/98

1.8 i 16V Petrol 92 09/93 → 08/94

2.0 GSI 16V Petrol 110 09/92 → 01/98

2.0 i Petrol 85 09/91 → 01/98

2.0 i 16V Petrol 100 02/95 → 01/98

ASTRA F Cabriolet (53_B)

1.8 i 16V Petrol 85 09/95 → 08/98

2.0 i Petrol 85 03/93 → 10/94

ASTRA F Station wagon (51_, 52_)

1.8 i 16V Petrol 85 09/95 → 01/98

1.8 i 16V Petrol 92 09/93 → 01/98

2.0 i Petrol 85 09/91 → 07/94

2.0 i 16V Petrol 100 02/95 → 01/98

2.0 i 16V Petrol 110 03/93 → 01/98

CALIBRA A (85_)

2.0 i Petrol 85 06/90 → 03/97

2.0 i 16V Petrol 100 02/94 → 08/96

2.0 i 16V 4x4 Petrol 100 02/94 → 08/96

2.0 i 4x4 Petrol 85 06/90 → 03/97

2.0 i Turbo 4x4 Petrol 150 03/92 → 03/97

CORSA A 2 volumi /Coda spiovente (93_, 94_, 98_, 99_)

1.6 GSI Petrol 72 09/89 → 03/93

FRONTERA A (5_MWL4)

2.2 i (54MWL4) Petrol 100 03/95 → 10/98

2.4 i (53MWL4) Petrol 92 03/92 → 08/95

SVF015

KW

OPEL
FRONTERA A Sport (5_SUD2)

2.0 i (52SUD2, 55SUD2)	Petrol	85	03/92 → 08/95
------------------------	--------	----	---------------

OMEGA A (16_, 17_, 19_)

2.0	Petrol	73	09/90 → 02/92	CHASSIS: L1019855 →
-----	--------	----	---------------	------------------------

2.0	Petrol	74	09/90 → 02/92	CHASSIS: L1019855 →
-----	--------	----	---------------	------------------------

2.0	Petrol	90	09/86 → 03/94	CHASSIS: L1019855 →
-----	--------	----	---------------	------------------------

2.0 i	Petrol	85	09/86 → 03/94	CHASSIS: L1019855 →
-------	--------	----	---------------	------------------------

2.4 i	Petrol	92	09/88 → 03/94
-------	--------	----	---------------

2.6 i	Petrol	110	09/90 → 03/94
-------	--------	-----	---------------

3.0 24V (3000)	Petrol	147	09/89 → 03/94
----------------	--------	-----	---------------

3.0 24V (3000)	Petrol	150	09/89 → 03/94
----------------	--------	-----	---------------

OMEGA A Station wagon (66_, 67_)

2.0	Petrol	74	09/90 → 02/92	CHASSIS: L1019855 →
-----	--------	----	---------------	------------------------

2.0	Petrol	90	09/86 → 03/94	CHASSIS: L1019855 →
-----	--------	----	---------------	------------------------

2.0 i	Petrol	73	09/90 → 02/92	CHASSIS: L1019855 →
-------	--------	----	---------------	------------------------

2.0 i	Petrol	85	09/86 → 03/94	CHASSIS: L1019855 →
-------	--------	----	---------------	------------------------

2.4 i	Petrol	92	09/88 → 03/94
-------	--------	----	---------------

2.6 i	Petrol	110	09/90 → 03/94
-------	--------	-----	---------------

3.0 24V	Petrol	147	09/89 → 03/94
---------	--------	-----	---------------

3.0 Cat.	Petrol	130	01/88 → 03/94	CHASSIS: L1019855 →
----------	--------	-----	---------------	------------------------

OMEGA B (25_, 26_, 27_)

2.0	Petrol	85	03/94 → 09/99
-----	--------	----	---------------

2.0	Petrol	85	03/94 → 08/98
-----	--------	----	---------------

2.0 16V	Petrol	100	03/94 → 09/99
---------	--------	-----	---------------

2.5 V6	Petrol	125	03/94 → 09/00	CHASSIS: → T1999999
--------	--------	-----	---------------	------------------------

3.0 V6	Petrol	155	04/94 → 02/01	CHASSIS: → T1999999
--------	--------	-----	---------------	------------------------

OMEGA B Station wagon (21_, 22_, 23_)

2.0	Petrol	85	03/94 → 09/99
-----	--------	----	---------------

2.0 16V	Petrol	100	03/94 → 09/99
---------	--------	-----	---------------

2.5 V6	Petrol	125	03/94 → 09/00	CHASSIS: → T1999999
--------	--------	-----	---------------	------------------------

3.0 V6	Petrol	155	04/94 → 02/01	CHASSIS: → T1999999
--------	--------	-----	---------------	------------------------

SVF015

KW

OPEL
SENATOR B (29_)

2.6 i	Petrol	110	09/90 → 09/93
-------	--------	-----	---------------

3.0 24V	Petrol	150	09/89 → 09/93
---------	--------	-----	---------------

VECTRA A (86_, 87_)

2.0 i	Petrol	85	09/90 → 10/90
-------	--------	----	---------------

2.0 i	Petrol	95	09/90 → 09/92
-------	--------	----	---------------

2.0 i 16V	Petrol	100	06/94 → 08/95
-----------	--------	-----	---------------

2.0 i 16V 4x4	Petrol	100	06/94 → 08/95
---------------	--------	-----	---------------

2.0 i 4x4	Petrol	85	09/90 → 10/90
-----------	--------	----	---------------

2.0 i 4x4	Petrol	95	09/90 → 09/92
-----------	--------	----	---------------

2.5 V6	Petrol	125	02/93 → 08/95
--------	--------	-----	---------------

VECTRA A 2 volumi /Coda spiovente (88_, 89_)

2.0 i	Petrol	85	09/90 → 10/90
-------	--------	----	---------------

2.0 i 16V	Petrol	100	06/94 → 08/95
-----------	--------	-----	---------------

2.0 i GT	Petrol	95	09/90 → 08/95
----------	--------	----	---------------

2.5 V6	Petrol	125	02/93 → 08/95
--------	--------	-----	---------------

VECTRA B (36_)

1.8 i 16V	Petrol	85	10/95 → 09/00
-----------	--------	----	---------------

2.0 i 16V	Petrol	100	10/95 → 09/00
-----------	--------	-----	---------------

2.5 i V6	Petrol	125	10/95 → 08/97	CHASSIS: → V7999999
----------	--------	-----	---------------	------------------------

VECTRA B 2 volumi /Coda spiovente (38_)

1.8 i 16V	Petrol	85	10/95 → 09/00
-----------	--------	----	---------------

2.0 i 16V	Petrol	100	10/95 → 09/00
-----------	--------	-----	---------------

2.5 i V6	Petrol	125	10/95 → 08/97	CHASSIS: → V7999999
----------	--------	-----	---------------	------------------------

PEUGEOT
106 I (1A, 1C)

1.4	Petrol	69	09/91 → 04/96
-----	--------	----	---------------

1.6	Petrol	65	06/93 → 01/95
-----	--------	----	---------------

306 (7B, N3, N5)

1.6 SR	Petrol	65	06/94 → 04/97
--------	--------	----	---------------

2.0 S16	Petrol	110	06/94 → 06/95
---------	--------	-----	---------------

2.0 S16	Petrol	112	06/94 → 06/95
---------	--------	-----	---------------

306 2 volumi /Coda spiovente (7A, 7C, N3, N5)

1.6	Petrol	65	05/93 → 04/97
-----	--------	----	---------------

2.0 S16	Petrol	110	06/94 → 06/95
---------	--------	-----	---------------

2.0 S16	Petrol	112	05/93 → 06/95
---------	--------	-----	---------------

405 II (4B)

2.0	Petrol	89	08/92 → 10/95
-----	--------	----	---------------

2.0 16V	Petrol	110	06/94 → 06/95
---------	--------	-----	---------------

2.0 MI-16	Petrol	112	08/92 → 06/95
-----------	--------	-----	---------------

405 II Break (4E)

2.0	Petrol	89	08/92 → 10/96
-----	--------	----	---------------

SVF015

KW

PEUGEOT
605 (6B)

2.0	Petrol	89	06/89 → 06/94
2.0 Turbo	Petrol	104	07/92 → 06/94
2.0 Turbo	Petrol	108	07/94 → 06/95

806 (221)

2.0 Turbo	Petrol	108	06/94 → 06/95
-----------	--------	-----	---------------

PORSCHE
911 (993)

3.6 Carrera	Petrol	200	10/93 → 08/95
3.6 Carrera	Petrol	210	08/95 → 09/97
3.6 Carrera 4	Petrol	200	07/94 → 08/95
3.6 Carrera 4	Petrol	210	08/95 → 09/97
3.6 Turbo 4	Petrol	300	03/95 → 09/97
3.8 Carrera 4	Petrol	221	08/95 → 09/97
3.8 Carrera RS	Petrol	221	06/95 → 09/97

911 Cabriolet (993)

3.6 Carrera	Petrol	200	07/94 → 08/95
3.6 Carrera	Petrol	210	08/95 → 09/97
3.6 Carrera 4	Petrol	200	07/94 → 08/95
3.6 Carrera 4	Petrol	210	08/95 → 09/97
3.8 Carrera	Petrol	221	08/95 → 08/95
3.8 Carrera 4	Petrol	221	08/95 → 09/97

911 Targa (993)

3.6 Carrera	Petrol	210	08/95 → 09/97
-------------	--------	-----	---------------

968

3.0	Petrol	176	06/91 → 11/95
-----	--------	-----	---------------

968 Cabriolet

3.0	Petrol	176	06/91 → 11/95
-----	--------	-----	---------------

RENAULT
19 II (B/C53_)

1.7 (B/C53C)	Petrol	66	04/92 → 12/95
--------------	--------	----	---------------

SAAB
900 I Combi Coupe

2.1 -16	Petrol	100	09/90 → 07/93
---------	--------	-----	---------------

900 II

2.0 -16 Turbo	Petrol	136	07/93 → 08/96
2.0 i	Petrol	96	08/94 → 08/96
2.0 i	Petrol	98	07/93 → 07/94
2.3 -16	Petrol	110	07/93 → 08/96
2.5 -24 V6	Petrol	125	07/93 → 08/97

900 II Cabriolet

2.0 -16 Turbo	Petrol	136	12/93 → 08/96
2.0 i	Petrol	96	12/93 → 08/96
2.3 -16	Petrol	110	12/93 → 08/96
2.5 -24 V6	Petrol	125	12/93 → 08/97

SVF015

KW

SAAB
900 II Coupé

2.0 i	Petrol	98	12/93 → 07/94
-------	--------	----	---------------

9000

2.0 -16 CD	Petrol	96	09/93 → 08/96
2.0 -16 Turbo CD	Petrol	136	09/90 → 08/92
2.3 -16 CD	Petrol	107	09/91 → 08/93
2.3 -16 CD Turbo	Petrol	147	09/93 → 08/96
2.3 -16 CDE	Petrol	108	09/93 → 08/96
2.3 -16 CDE Eco-Power	Petrol	125	09/93 → 08/96
2.3 -16 Turbo	Petrol	143	09/90 → 08/93

9000 2 volumi /Coda spiovente

2.0 -16 CS	Petrol	94	09/90 → 08/93
2.0 -16 CS	Petrol	96	09/93 → 08/96
2.0 -16 Turbo	Petrol	118	09/90 → 08/93
2.0 -16 Turbo CS	Petrol	136	09/90 → 08/92
2.3 -16 CS	Petrol	107	09/90 → 08/93
2.3 -16 CSE	Petrol	108	09/93 → 08/96
2.3 -16 CSE Eco Power	Petrol	125	09/93 → 08/96
2.3 -16 Turbo	Petrol	143	09/90 → 08/93
2.3 -16 Turbo CSE	Petrol	147	09/93 → 08/96

TOYOTA
CARINA E (_T19_)

1.6 (AT190)	Petrol	73	02/94 → 01/96
1.6 16V	Petrol	78	10/95 → 09/97
1.6 GLI (AT190)	Petrol	79	12/93 → 09/97

CARINA E Sportswagon (_T19_)

1.6 GLI (AT190_)	Petrol	79	01/93 → 09/97
1.6 i (AT190_)	Petrol	73	02/95 → 01/96

CARINA E Tre volumi (_T19_)

1.6 (AT190)	Petrol	73	01/95 → 01/96
1.6 (AT190)	Petrol	79	01/93 → 09/97

COROLLA (_E11_)

1.4 16V (ZZE111_)	Petrol	71	02/00 → 09/01
-------------------	--------	----	---------------

COROLLA Compact (_E11_)

1.4 (ZZE111_)	Petrol	71	02/00 → 07/01
---------------	--------	----	---------------

COROLLA Liftback (_E11_)

1.4 (ZZE111_)	Petrol	71	02/00 → 09/01
---------------	--------	----	---------------

COROLLA Wagon (_E11_)

1.4 16V (ZZE111_)	Petrol	71	02/00 → 09/01
-------------------	--------	----	---------------

SVF015

KW

VAUXHALL
ASTRA Mk III (F)

2.0 i Petrol 85 03/92 → 02/98

ASTRA Mk III (F) 2 volumi /Coda spiovente

2.0 i Petrol 85 09/91 → 02/98

ASTRA Mk III (F) Cabriolet

2.0 i Petrol 85 03/93 → 10/94

ASTRA Mk III (F) Station wagon

2.0 i Petrol 85 09/91 → 02/98

FRONTERA Mk I (A)

2.2 i Petrol 100 03/95 → 10/98

2.4 i Petrol 92 03/92 → 08/95

FRONTERA Mk I (A) Sport

2.0 i Petrol 85 03/92 → 10/98

OMEGA (B)

2.0 Petrol 85 09/95 → 09/96

SINTRA

2.2 i 16 V Petrol 104 11/96 → 04/99

3.0 i 24V Petrol 148 11/96 → 04/99

VECTRA (B)

1.8 i 16V Petrol 85 10/95 → 08/99

2.0 i 16V Petrol 100 10/95 → 01/01

 2.5 i GSi Petrol 143 03/98 → 07/00 CHASSIS:
→ V7999999

 2.5 i V6 Petrol 125 09/95 → 08/00 CHASSIS:
→ V7999999

VECTRA (B) 2 volumi /Coda spiovente

1.8 i 16V Petrol 85 10/95 → 08/99

2.0 i 16V Petrol 100 10/95 → 01/01

 2.5 i GSi Petrol 143 03/98 → 07/00 CHASSIS:
→ V7999999

 2.5 i V6 Petrol 125 09/95 → 08/00 CHASSIS:
→ V7999999

VECTRA (B) Station wagon

1.8 i 16V Petrol 85 11/96 → 08/99

2.0 i 16V Petrol 100 10/95 → 01/01

 2.5 i GSi Petrol 143 05/98 → 09/99 CHASSIS:
→ V7999999

 2.5 i V6 Petrol 125 11/96 → 08/00 CHASSIS:
→ V7999999

VOLVO
440 K (445)

1.7 Petrol 75 08/89 → 07/91

2.0 Petrol 80 08/93 → 07/96

2.0 Petrol 81 08/92 → 07/95

SVF015

KW

VOLVO
460 L (464)

1.7 Petrol 75 03/90 → 07/92

2.0 Petrol 80 08/93 → 07/96

2.0 Petrol 81 08/92 → 07/95

480 E

1.7 Petrol 75 08/89 → 12/93

2.0 Petrol 81 08/92 → 09/95

850 (LS)

2.0 Petrol 105 09/91 → 12/96

2.0 Petrol 93 08/94 → 12/96

2.5 Petrol 103 09/92 → 07/94

2.5 Petrol 106 08/94 → 12/96

2.5 Petrol 125 08/91 → 12/96

850 Station wagon (LW)

2.0 Petrol 93 08/94 → 12/96

2.5 Petrol 103 08/92 → 07/94

2.5 Petrol 125 09/92 → 12/96

960 (964)

2.9 Petrol 150 08/90 → 07/94

960 II (964)

2.5 Petrol 125 07/94 → 12/96

2.9 Petrol 150 07/94 → 12/96

960 II Station wagon (965)

2.5 Petrol 125 08/94 → 12/96

2.9 Petrol 150 09/94 → 12/96

960 Kombi (965)

2.9 Petrol 150 08/90 → 07/94

C70 I Cabriolet

2.0 Petrol 132 03/98 → 07/98

2.3 T5 Petrol 176 08/98 → 07/02

2.3 T5 Petrol 180 07/02 → 10/05

2.4 T Petrol 147 07/02 → 10/05

2.5 Petrol 125 03/99 → 07/00

2.5 T Petrol 142 08/98 → 07/99

C70 I Coupé

2.0 Petrol 132 03/97 → 07/98

2.0 T Petrol 166 03/97 → 07/00

2.3 T-5 Petrol 176 09/97 → 09/02

2.5 Petrol 121 03/99 → 07/00

C70 I Coupé

2.5 Petrol 125 05/99 → 07/00

2.5 T Petrol 142 01/98 → 07/99

SVF015

VOLVO
S70 (LS)

2.0	Petrol	120	08/98 → 07/00
2.4	Petrol	103	08/99 → 07/00
2.5	Petrol	121	06/98 → 07/99
2.5 Bifuel	Petrol/ CNG	106	10/98 → 07/99

V70 I (LV)

2.0	Petrol	120	08/98 → 03/00
2.3 T AWD	Petrol	184	08/97 → 07/98
2.3 T-5 AWD	Petrol	176	01/97 → 03/00
2.5	Petrol	121	06/98 → 07/98
2.5 AWD	Petrol	195	03/99 → 03/00

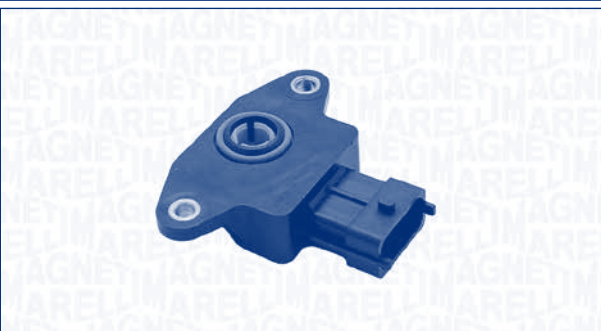
SVF016
B6 **SENSORE POSIZIONE FARFALLA
THROTTLE POSITION SENSOR**

HONDA
ACCORD VI (CG, CK)

1.6 i	Petrol	85	10/98 → 12/02
-------	--------	----	---------------

HYUNDAI
ACCENT II (LC)

1.3	Petrol	55	01/00 → 11/05
1.3	Petrol	61	01/00 → 11/05
1.3	Petrol	62	08/02 → 11/05
1.3	Petrol	63	01/00 → 11/05
1.5	Petrol	66	01/00 → 11/05
1.5	Petrol	75	09/00 → 11/05
1.6	Petrol	77	12/02 → 11/05

ACCENT Tre volumi (LC)

1.3	Petrol	55	01/00 → 11/05
1.3	Petrol	63	01/00 → 11/05
1.5	Petrol	66	01/00 → 11/05
1.6	Petrol	77	12/02 → 11/05

SVF016

HYUNDAI
COUPE (GK)

1.6 16V	Petrol	77	03/02 → 08/09
1.6 16V	Petrol	79	03/02 → 08/09
2.0	Petrol	102	03/02 → 08/09
2.0 GLS	Petrol	105	02/03 → 08/09

ELANTRA (XD)

1.6	Petrol	77	05/03 → 07/06
1.6	Petrol	79	06/00 → 07/06
1.8	Petrol	97	06/00 → 07/06
2.0	Petrol	102	06/00 → 07/06
2.0	Petrol	104	06/00 → 07/06
2.0	Petrol	105	10/03 → 07/06

ELANTRA Tre volumi (XD)

1.6	Petrol	77	05/03 → 07/06
1.6	Petrol	79	06/00 → 07/06
1.8	Petrol	97	06/00 → 07/06
2.0	Petrol	102	06/00 → 07/06
2.0	Petrol	104	06/00 → 07/06
2.0	Petrol	105	10/03 → 07/06

GETZ (TB)

1.1	Petrol	46	09/02 → 09/05
1.3	Petrol	63	09/03 → 08/05
1.3 i	Petrol	60	09/02 → 03/04
1.6	Petrol	77	09/02 → 09/05

MATRIX (FC)

1.6	Petrol	76	06/01 → 08/10
1.8	Petrol	90	06/01 → 08/10

TRAJET (FO)

2.0	Petrol	100	03/04 → 07/08
2.0	Petrol	103	03/04 → 07/08

TUCSON (JM)

2.0	Petrol	104	08/04 → 03/10
2.0 Trazione integrale	Petrol	104	08/04 → 03/10

LAND ROVER
DISCOVERY II (LJ, LT)

4.0 V8 4x4	Petrol	136	11/98 → 06/04
------------	--------	-----	---------------

NISSAN
MICRA II (K11)

1.0 i 16V	Petrol	40	07/00 → 09/00
1.0 i 16V	Petrol	44	09/00 → 10/02
1.4 i 16V	Petrol	60	09/00 → 10/02

SVF016



KW



OPEL

ASTRA G 2 volumi /Coda spiovente (F48_, F08_)

1.2 16V	Petrol	48	02/98 → 09/00
2.0 16V	Petrol	100	02/98 → 01/04
2.0 16V OPC	Petrol	118	11/99 → 09/02

ASTRA G Cabriolet (F67)

2.0 16V Turbo	Petrol	147	11/02 → 08/05
2.0 OPC	Petrol	141	03/02 → 08/05

ASTRA G Coupé (F07_)

2.0 16V Turbo	Petrol	140	09/00 → 08/01
2.0 16V Turbo	Petrol	141	08/01 → 02/05
2.0 16V Turbo	Petrol	147	11/02 → 02/05

ASTRA G Station wagon (F35_)

1.2 16V	Petrol	48	02/98 → 09/00
2.0 16V	Petrol	100	02/98 → 06/04

ASTRA G Tre volumi (F69_)

1.2 16V	Petrol	48	09/98 → 09/00
2.0 16V	Petrol	100	09/98 → 01/04

CORSA B (73_, 78_, 79_)

1.2 i 16V	Petrol	48	03/98 → 09/00
-----------	--------	----	---------------

VECTRA B (36_)

2.5 i V6	Petrol	125	09/97 → 09/00	CHASSIS: W1000001 →
i 500 2.5	Petrol	143	05/98 → 09/00	

VECTRA B 2 volumi /Coda spiovente (38_)

2.5 i V6	Petrol	125	09/97 → 09/00	CHASSIS: W1000001 →
----------	--------	-----	---------------	------------------------

VECTRA B Station wagon (31_)

i 500 2.5	Petrol	143	05/98 → 09/00
-----------	--------	-----	---------------

PORSCHE

911 (996)

3.4 Carrera	Petrol	221	09/97 → 09/01
3.4 Carrera 4	Petrol	221	09/98 → 09/01
3.6 Carrera	Petrol	235	10/01 → 07/04
3.6 Carrera 4	Petrol	235	10/01 → 07/04
3.6 Carrera 4S	Petrol	254	02/03 → 07/04
3.6 Carrera S	Petrol	254	02/03 → 07/04
3.6 GT3	Petrol	265	03/99 → 08/01
3.6 GT3	Petrol	280	09/03 → 08/05

911 Cabriolet (996)

3.4 Carrera	Petrol	221	02/98 → 09/01
3.4 Carrera 4	Petrol	221	09/98 → 09/01
3.6 Carrera	Petrol	235	10/01 → 07/04
3.6 Carrera 4	Petrol	235	10/01 → 07/04

SVF016



KW



PORSCHE

911 Cabriolet (996)

3.6 Carrera 4S	Petrol	254	06/02 → 07/04
3.6 Carrera S	Petrol	254	06/02 → 07/04

911 Targa (996)

3.6	Petrol	235	12/01 → 07/04
-----	--------	-----	---------------

BOXSTER (986)

2.7	Petrol	162	08/99 → 07/02
2.7	Petrol	168	09/02 → 10/04
S 3,2	Petrol	191	09/02 → 10/04
S 3.2	Petrol	185	08/99 → 07/02
S 3.2	Petrol	196	01/04 → 10/04

SAAB

900 II

2.0 -16 Turbo	Petrol	136	09/96 → 02/98
2.0 i	Petrol	96	09/96 → 02/98
2.3 -16	Petrol	110	09/96 → 02/98

900 II Cabriolet

2.0 -16 Turbo	Petrol	136	09/96 → 02/98
2.0 i	Petrol	96	09/96 → 02/98
2.3 -16	Petrol	110	09/96 → 02/98

9000

2.0 -16 CD	Petrol	110	09/96 → 12/98
2.0 -16 CD	Petrol	96	09/96 → 12/98
2.0 -16 Turbo CD	Petrol	108	09/96 → 12/98
2.3 -16 CD Turbo	Petrol	147	09/96 → 12/98
2.3 -16 CDE	Petrol	108	09/96 → 12/98
2.3 -16 CDE Eco-Power	Petrol	125	09/96 → 12/98

9000 2 volumi /Coda spiovente

2.0 -16 CS	Petrol	96	09/96 → 12/98
2.0 -16 ND Turbo	Petrol	110	09/96 → 12/98
2.3 -16 Aero CS	Petrol	162	09/96 → 12/98
2.3 -16 Aero CS	Petrol	165	09/96 → 12/98
2.3 -16 CSE	Petrol	108	09/96 → 12/98
2.3 -16 CSE Eco Power	Petrol	125	09/96 → 12/98
2.3 -16 Turbo CSE	Petrol	147	09/96 → 12/98

9-3 (YS3D)

2.0 i	Petrol	96	02/98 → 08/00
2.0 SE Turbo	Petrol	147	09/98 → 08/00
2.0 Turbo	Petrol	110	01/01 → 09/02
2.0 Turbo	Petrol	113	10/98 → 08/00
2.0 Turbo	Petrol	136	02/98 → 08/00
2.0 Turbo	Petrol	151	10/99 → 09/02

SVF016

SAAB
9-3 (YS3D)

2.3 i	Petrol	110	02/98 → 08/00
2.3 Turbo	Petrol	165	09/99 → 08/00

9-3 Cabriolet (YS3D)

2.0 i	Petrol	96	02/98 → 08/00
2.0 SE Turbo	Petrol	147	09/98 → 08/00
2.0 Turbo	Petrol	113	10/98 → 08/00
2.0 Turbo	Petrol	136	02/98 → 08/03
2.3 i	Petrol	110	02/98 → 08/00

VAUXHALL
ASTRA Mk IV (G) 2 volumi /Coda spiovente

1.2 16V	Petrol	48	02/98 → 09/00
2.0 16V	Petrol	100	02/98 → 05/05

ASTRA Mk IV (G) Station wagon

1.2 16V	Petrol	48	02/98 → 09/00
2.0 16V	Petrol	100	02/98 → 05/05

ASTRA Mk IV (G) Tre volumi

1.2 16V	Petrol	48	09/98 → 09/00
2.0 16V	Petrol	100	09/98 → 05/05

CORSA Mk I (B)

1.2 i 16V	Petrol	48	03/98 → 09/00
-----------	--------	----	---------------

KITBLOW
**B2 TUBO CONN. CANISTER
TUBE CONNECTING CANISTER VALVE**

CITROËN
C8 (EA_, EB_)

2.2	Petrol	116	07/02 →	ENGINE: 3FZ(EW12J4)
-----	--------	-----	---------	------------------------

PEUGEOT
406 (8B)

2.2	Petrol	116	07/00 → 05/04	ENGINE: 3FZ(EW12J4)
-----	--------	-----	---------------	------------------------

KITBLOW

PEUGEOT
406 Break (8E/F)

2.2	Petrol	116	07/00 → 10/04	ENGINE: 3FZ(EW12J4)
-----	--------	-----	---------------	------------------------

407 (6D_)

2.2	Petrol	116	05/04 →	ENGINE: 3FZ(EW12J4)
-----	--------	-----	---------	------------------------

407 Coupé (6C_)

2.2 16V	Petrol	120	10/05 →	ENGINE: 3FY(EW12J4)
---------	--------	-----	---------	------------------------

607 (9D, 9U)

2.2 16V	Petrol	116	02/00 →	ENGINE: 3FZ(EW12J4)
---------	--------	-----	---------	------------------------

807 (E)

2.2	Petrol	116	06/02 →	ENGINE: 3FZ(EW12J4)
-----	--------	-----	---------	------------------------

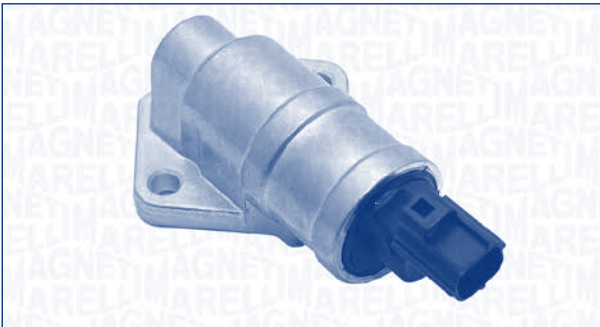
VAE3390
**B2 VALVOLA DI REGOLAZIONE
IDLE CONTROL VALVE**

FORD
FOCUS (DAW, DBW)

1.4 16V	Petrol	55	08/00 → 11/04
1.6 16V	Petrol	74	08/00 → 11/04

FOCUS Station wagon (DNW)

1.4 16V	Petrol	55	08/00 → 11/04
1.6 16V	Petrol	74	08/00 → 11/04

FOCUS Tre volumi (DFW)

1.4 16V	Petrol	55	08/00 → 11/04
1.6 16V	Petrol	74	08/00 → 11/04

VAE3391

B2 VALVOLA DI REGOLAZIONE
IDLE CONTROL VALVE

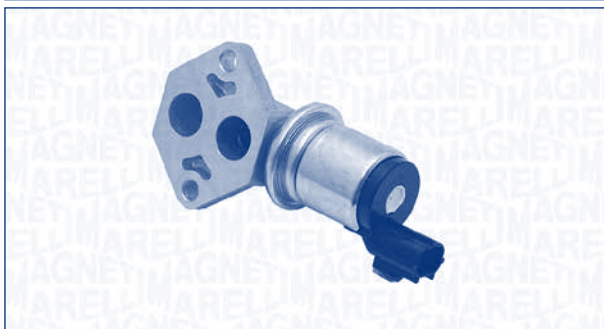

KW



FORD

COURIER Furgonato (J5_, J3_)

1.3 Petrol 44 09/98 →

ESCORT VII (GAL, AAL, ABL)

1.3 Petrol 44 09/98 → 10/98

ESCORT VII Station wagon (GAL, ANL)

1.3 Petrol 44 09/98 → 01/99

ESCORT VII Tre volumi (GAL, AFL)

1.3 Petrol 44 09/98 → 02/99

FIESTA IV (JA_, JB_)

1.3 i Petrol 37 09/98 → 01/02

1.3 i Petrol 44 09/98 → 01/02

FOCUS (DAW, DBW)

1.8 16V Petrol 85 10/98 → 11/04

2.0 16V Petrol 96 10/98 → 11/04

FOCUS Station wagon (DNW)

1.8 16V Petrol 85 02/99 → 11/04

2.0 16V Petrol 96 02/99 → 11/04

FOCUS Tre volumi (DFW)

1.8 16V Petrol 85 02/99 → 11/04

2.0 16V Petrol 96 02/99 → 11/04

KA (RB_)

1.3 i Petrol 36 09/98 → 10/02

TOURNEO CONNECT

1.8 16V Petrol 85 06/02 →

TRANSIT CONNECT (P65_, P70_, P80_)

1.8 16V Petrol 85 06/02 →

GRUPPO C - GROUP C

FEI0001

INIETTORE
FUEL INJECTOR



KW



RENAULT

CLIO I (B/C57_, 5/357_)

1.2 (5/357Y, 5/357K) Petrol 40 01/96 → 09/98

CLIO II (BB0/1/2_, CB0/1/2_)

1.2 (BB0A, BB0F, BB10, BB1K, BB28, BB2D, BB2H, CB0A...)

Petrol 43 09/98 →

1.2 (BB0A, CB0A) Petrol 44 03/99 → 05/01

CLIO II Furgonato (SB0/1/2_)

1.1 (SB0A, SB0F, SB1K, SB2D) Petrol 43 09/98 →

1.2 (SB0A, SB0F, SB10) Petrol 44 03/99 → 10/03

KANGOO (KC0/1_)

1.2 (KC0A, KC0K, KC0F, KC01) Petrol 43 08/97 →

KANGOO Express (FC0/1_)

1.2 (FC01, FC0A, FC0F) Petrol 43 08/97 →

1.2 (FC1A) Petrol 44 07/98 → 07/01

FEI0002
**INIETTORE
FUEL INJECTOR**

KW

CITROËN
BERLINGO (B9)

1.4	Petrol	55	03/09 →
-----	--------	----	---------

BERLINGO (MF)

1.4	Petrol	53	11/02 → 10/05
-----	--------	----	---------------

1.4 i bivalent (MFKFW)	BiFuel	55	04/03 →
---------------------------	--------	----	---------

BERLINGO Furgonato (M_)

1.4 i bivalent (MBKFW)	BiFuel	55	04/03 →
---------------------------	--------	----	---------

C2 (JM_)

1.4	Petrol	54	09/03 →
-----	--------	----	---------

C3 I (FC_)

1.4 i	Petrol	54	02/02 →
-------	--------	----	---------

1.4 i Bivalent	Petrol/ CNG	54	02/02 →
----------------	----------------	----	---------

C3 Pluriel (HB_)

1.4	Petrol	54	05/03 →
-----	--------	----	---------

XSARA (N1)

1.4 i	Petrol	55	04/97 → 03/05
-------	--------	----	---------------

XSARA Break (N2)

1.4 i	Petrol	55	10/97 → 08/05
-------	--------	----	---------------

XSARA Coupé (N0)

1.4 i	Petrol	55	03/98 → 03/05
-------	--------	----	---------------

PEUGEOT
1007 (KM_)

1.4	Petrol	54	04/05 →
-----	--------	----	---------

206 2 volumi /Coda spiovente (2A/C)

1.4 i	Petrol	55	09/98 →
-------	--------	----	---------

1.4 LPG	Petrol/ LPG	55	05/06 → 09/07
---------	----------------	----	---------------

206 SW (2E/K)

1.4	Petrol	55	07/02 →
-----	--------	----	---------

206 Tre volumi

1.4	Petrol	55	03/07 →
-----	--------	----	---------

FEI0002

KW

PEUGEOT
306 (7B, N3, N5)

1.4 SL	Petrol	55	06/94 → 05/01
--------	--------	----	---------------

306 2 volumi /Coda spiovente (7A, 7C, N3, N5)

1.4	Petrol	55	05/93 → 05/01
-----	--------	----	---------------

306 Break (7E, N3, N5)

1.4	Petrol	55	03/97 → 04/02
-----	--------	----	---------------

307 (3A/C)

1.4	Petrol	55	08/00 →
-----	--------	----	---------

RANCH Furgonato (5)

1.4 BiFuel	Petrol/ CNG	55	04/03 →
------------	----------------	----	---------

RANCH MPV / Space wagon (5F)

1.4	Petrol	54	11/02 → 10/06
-----	--------	----	---------------

1.4	Petrol	55	06/96 →
-----	--------	----	---------

FEI0003
**INIETTORE
FUEL INJECTOR**

KW

CHEVROLET
MATIZ (M200, M250)

0.8	Petrol	38	03/05 →
-----	--------	----	---------

DAEWOO
MATIZ (KLYA)

0.8	Petrol	38	09/98 →
-----	--------	----	---------

1.0	Petrol	47	01/03 →
-----	--------	----	---------

FEI0004

**INIETTORE
FUEL INJECTOR**



OPEL

AGILA (A) (H00)

1.0	Petrol	44	08/03 → 12/07
1.2 16V Twinport	Petrol	59	07/04 → 12/07

ASTRA G 2 volumi /Coda spiovente (F48_, F08_)

1.4	Petrol	66	09/07 → 12/09
-----	--------	----	---------------

ASTRA G Tre volumi (F69_)

1.4	Petrol	66	09/07 → 12/09
-----	--------	----	---------------

ASTRA GTC J

1.4	Petrol	74	10/11 →
-----	--------	----	---------

ASTRA H (L48)

1.4	Petrol	55	04/04 → 10/04
-----	--------	----	---------------

1.4	Petrol	66	03/04 →
-----	--------	----	---------

1.4 LPG	Petrol/ LPG	66	08/09 →
---------	----------------	----	---------

ASTRA H GTC (L08)

1.4	Petrol	55	03/05 →
-----	--------	----	---------

1.4	Petrol	66	03/05 →
-----	--------	----	---------

ASTRA H Station wagon (L35)

1.4	Petrol	55	08/04 →
-----	--------	----	---------

1.4	Petrol	66	08/04 →
-----	--------	----	---------

ASTRA J

1.4	Petrol	64	12/09 →
-----	--------	----	---------

1.4	Petrol	74	12/09 →
-----	--------	----	---------

ASTRA J Sports Tourer

1.4	Petrol	74	10/10 →
-----	--------	----	---------

COMBO Cassone / Furgonato / Promiscuo

1.4 16V	Petrol	66	08/05 →
---------	--------	----	---------

COMBO Tour

1.4	Petrol	66	10/04 →
-----	--------	----	---------

CORSA C (F08, F68)

1.0	Petrol	44	06/03 → 12/09
-----	--------	----	---------------

1.2 Twinport	Petrol	59	07/04 → 12/09
--------------	--------	----	---------------

1.4 Twinport	Petrol	66	06/03 → 12/09
--------------	--------	----	---------------

FEI0004



OPEL

CORSA C Furgonato (F08, W5L)

1.2	Petrol	59	07/05 →
-----	--------	----	---------

CORSA D

1.0	Petrol	44	07/06 →
-----	--------	----	---------

1.0	Petrol	48	01/10 →
-----	--------	----	---------

1.2	Petrol	63	06/10 →
-----	--------	----	---------

1.2	Petrol	51	06/10 →
-----	--------	----	---------

1.2	Petrol	59	07/06 →
-----	--------	----	---------

1.2 LPG	Petrol/ LPG	59	09/09 →
---------	----------------	----	---------

1.2 LPG	Petrol/ LPG	61	06/11 →
---------	----------------	----	---------

1.2 LPG	Petrol/ LPG	63	08/11 →
---------	----------------	----	---------

1.4	Petrol	64	09/09 →
-----	--------	----	---------

1.4	Petrol	66	07/06 →
-----	--------	----	---------

1.4	Petrol	74	06/10 →
-----	--------	----	---------

1.4 LPG	Petrol/ LPG	64	09/09 →
---------	----------------	----	---------

1.4 LPG	Petrol/ LPG	66	07/06 →
---------	----------------	----	---------

CORSA D Van

1.0	Petrol	48	01/10 →
-----	--------	----	---------

1.2	Petrol	51	06/10 →
-----	--------	----	---------

1.2	Petrol	59	07/09 →
-----	--------	----	---------

1.2	Petrol	63	06/10 →
-----	--------	----	---------

MERIVA

1.4 16V Twinport	Petrol	66	07/04 → 05/10
------------------	--------	----	---------------

1.4 16V Twinport LPG	Petrol/ LPG	66	07/04 → 05/10
-------------------------	----------------	----	---------------

MERIVA B

1.4	Petrol	74	06/10 →
-----	--------	----	---------

TIGRA TwinTop

1.4	Petrol	66	06/04 →
-----	--------	----	---------

FEI0005
**INIETTORE
FUEL INJECTOR**

FORD
MONDEO III (B5Y)

3.0 V6 24V Petrol 150 09/04 → 08/07

ST220 Petrol 166 04/02 → 08/07

MONDEO III Station wagon (BWY)

3.0 V6 24V Petrol 150 09/04 → 08/07

ST220 Petrol 166 04/02 → 08/07

MONDEO III Tre volumi (B4Y)

3.0 V6 24V Petrol 150 09/04 → 08/07

ST220 Petrol 166 04/02 → 08/07

FEI0007
**INIETTORE
FUEL INJECTOR**

FORD
GALAXY (WA6)

2.3 Petrol 118 07/07 →

MONDEO IV (BA7)

2.3 Petrol 118 07/07 →

MONDEO IV Tre volumi (BA7)

2.3 Petrol 118 07/07 →

MONDEO IV Turnier (BA7)

2.3 Petrol 118 07/07 →

S-MAX (WA6)

2.3 Petrol 118 07/07 →

TRANSIT Furgonato

2.3 16V Petrol 107 04/06 →

TRANSIT Pianale piatto/Telaio

2.3 16V Petrol 107 04/06 →

FEI0006
**INIETTORE
FUEL INJECTOR**

FORD
FOCUS II (DA_)

2.5 RS Petrol 224 01/09 → 12/11

FEI0008
**INIETTORE
FUEL INJECTOR**

FORD
KA (RB_)

1.6 i Petrol 70 07/03 → 11/08

STREET KA (RL2)

1.6 Petrol 70 05/03 → 07/05

FEI0009

**INIETTORE
FUEL INJECTOR**



FORD

C-MAX (DM2)

1.8 Flexifuel	Petrol/ Ethanol	92	03/07 → 07/10
---------------	--------------------	----	---------------

FOCUS C-MAX

1.8 Flexifuel	Petrol/ Ethanol	92	01/06 → 03/07
---------------	--------------------	----	---------------

FOCUS II (DA_)

1.8 Flexifuel	Petrol/ Ethanol	92	01/06 → 12/11
---------------	--------------------	----	---------------

1.8 Flexifuel	Petrol/ Ethanol	96	12/05 → 01/08
---------------	--------------------	----	---------------

FOCUS II Station wagon (DA_)

1.8 Flexifuel	Petrol/ Ethanol	92	01/06 → 12/11
---------------	--------------------	----	---------------

FOCUS II Tre volumi (DA_)

1.8 Flexifuel	Petrol/ Ethanol	92	06/06 → 01/08
---------------	--------------------	----	---------------

MAZDA

6 (GG)

2.3	Petrol	120	03/05 → 03/05
-----	--------	-----	---------------

2.3	Petrol	122	06/02 → 08/04
-----	--------	-----	---------------

6 Hatchback (GG)

2.3	Petrol	122	08/02 → 08/04
-----	--------	-----	---------------

6 Station Wagon (GY)

2.3	Petrol	122	08/02 → 03/05
-----	--------	-----	---------------

2.3 AWD	Petrol	119	11/02 → 03/05
---------	--------	-----	---------------

MPV II (LW)

2.3	Petrol	104	07/02 → 06/04
-----	--------	-----	---------------

VOLVO

C30

1.8 FlexFuel	BiFuel	92	01/07 → 07/10
--------------	--------	----	---------------

S40 II (MS)

1.8 FlexFuel	BiFuel	92	04/06 → 07/10
--------------	--------	----	---------------

FEI0009



VOLVO

V50 (MW)

1.8 FlexFuel	BiFuel	92	04/06 → 07/10
--------------	--------	----	---------------

FEI0010

**INIETTORE
FUEL INJECTOR**



FORD

KA (RU8)

1.2	Petrol	51	10/08 →
-----	--------	----	---------

FEI0011

**INIETTORE
FUEL INJECTOR**



FORD

FOCUS C-MAX

1.8	Petrol	88	10/03 → 05/04
-----	--------	----	---------------

1.8	Petrol	92	04/04 → 05/04
-----	--------	----	---------------

MONDEO III (B5Y)

1.8 16V	Petrol	81	11/00 → 03/07
---------	--------	----	---------------

1.8 16V	Petrol	92	11/00 → 03/07
---------	--------	----	---------------

MONDEO III Station wagon (BWY)

1.8 16V	Petrol	81	11/00 → 03/07
---------	--------	----	---------------

1.8 16V	Petrol	92	11/00 → 03/07
---------	--------	----	---------------

FEI0011

KW

FORD
MONDEO III Tre volumi (B4Y)

1.8 16V	Petrol	81	11/00 → 03/07
1.8 16V	Petrol	92	11/00 → 03/07

MAZDA
3 (BK)

2.0	Petrol	104	04/04 → 03/06
2.0	Petrol	110	10/03 → 03/06

3 Tre volumi (BK)

2.0	Petrol	104	04/04 → 03/06
2.0	Petrol	110	02/04 → 03/06

5 (CR19)

2.0	Petrol	107	03/05 → 09/07
-----	--------	-----	---------------

6 (GG)

2.0	Petrol	104	06/02 → 03/05
2.0	Petrol	108	03/05 → 03/05

6 Hatchback (GG)

2.0	Petrol	104	08/02 → 03/05
2.0	Petrol	108	03/05 → 03/05

6 Station Wagon (GY)

2.0	Petrol	104	08/02 → 03/05
2.0	Petrol	108	03/05 → 03/05

FEI0012
**INIETTORE
FUEL INJECTOR**

KW

FORD
FIESTA IV (JA_, JB_)

1.25 i 16V	Petrol	55	01/97 → 12/99
------------	--------	----	---------------

PUMA (EC_)

1.4 16V	Petrol	66	11/97 → 10/00
---------	--------	----	---------------

FEI0013
**INIETTORE
FUEL INJECTOR**

KW

FORD
B-MAX

1.6 Ti	Petrol	77	03/13 →
--------	--------	----	---------

C-MAX II

1.6	Petrol	63	08/11 →
-----	--------	----	---------

FIESTA Van

1.25	Petrol	60	01/09 →
------	--------	----	---------

FIESTA VI

1.25	Petrol	44	06/08 →
1.25	Petrol	60	06/08 →
1.4	Petrol	71	06/08 →
1.4 LPG	Petrol/ LPG	71	05/09 → 11/12

FOCUS III

1.6 Ti	Petrol	63	08/11 →
--------	--------	----	---------

FOCUS III Tre volumi

1.6 Ti	Petrol	63	02/12 →
--------	--------	----	---------

FOCUS III Turnier

1.6 Ti	Petrol	63	02/12 →
--------	--------	----	---------

FEI0014

**INIETTORE
FUEL INJECTOR**



FORD

C-MAX (DM2)

1.8	Petrol	90	03/07 → 07/10
1.8	Petrol	92	03/07 → 07/10
2.0	Petrol	107	03/07 → 07/10
2.0 CNG	Petrol/ CNG	107	04/09 → 07/10
2.0 LPG	Petrol/ LPG	107	06/08 → 07/10

FIESTA V (JH_, JD_)

ST150	Petrol	110	03/05 → 06/08
-------	--------	-----	---------------

FOCUS C-MAX

1.8	Petrol	92	06/04 → 03/07
2.0	Petrol	107	04/04 → 03/07

FOCUS II (DA_)

1.8	Petrol	92	03/06 → 12/11
2.0	Petrol	104	06/05 → 09/08 ENGINE: AOD
2.0	Petrol	107	11/04 → 12/11
2.0 CNG	Petrol/ CNG	107	04/09 → 12/11
2.0 LPG	Petrol/ LPG	107	06/08 → 12/11

FOCUS II Cabriolet

2.0	Petrol	107	10/06 → 07/10
-----	--------	-----	---------------

FOCUS II Station wagon (DA_)

1.8	Petrol	92	03/06 → 12/11
2.0	Petrol	107	11/04 → 12/11
2.0 LPG	Petrol/ LPG	107	06/08 → 12/11

FOCUS II Tre volumi (DA_)

1.8	Petrol	92	12/07 → 12/11
2.0	Petrol	107	04/05 → ENGINE: AODA, AODB, ENGINE: AODA, AOD<EURO4>, AOD<EURO5>

FEI0014



FORD

GALAXY (WA6)

2.0	Petrol	107	05/06 →
-----	--------	-----	---------

MONDEO III (B5Y)

2.0 16V	Petrol	107	11/00 → 03/07
---------	--------	-----	---------------

MONDEO III Station wagon (BWY)

2.0 16V	Petrol	107	11/00 → 03/07
---------	--------	-----	---------------

MONDEO III Tre volumi (B4Y)

2.0 16V	Petrol	107	11/00 → 03/07
---------	--------	-----	---------------

MONDEO IV (BA7)

2.0	Petrol	107	03/07 →
-----	--------	-----	---------

MONDEO IV Tre volumi (BA7)

2.0	Petrol	107	03/07 →
-----	--------	-----	---------

MONDEO IV Turnier (BA7)

2.0	Petrol	107	03/07 →
-----	--------	-----	---------

S-MAX (WA6)

2.0	Petrol	107	05/06 →
-----	--------	-----	---------

MAZDA

323 F VI (BJ)

2.0	Petrol	96	01/01 → 05/04
2.0	Petrol	96	01/01 → 08/03

5 (CR19)

1.8	Petrol	85	03/05 → 03/05
-----	--------	----	---------------

6 (GG)

1.8	Petrol	88	08/02 → 03/05
-----	--------	----	---------------

6 Hatchback (GG)

1.8	Petrol	88	08/02 → 03/05
-----	--------	----	---------------

6 Station Wagon (GY)

1.8	Petrol	88	08/02 → 03/05
-----	--------	----	---------------

MPV II (LW)

2.0	Petrol	88	08/00 → 04/02
2.0	Petrol	90	09/99 → 08/00

PREMACY (CP)

2.0	Petrol	96	11/01 → 03/05
-----	--------	----	---------------

VOLVO

C30

1.8	Petrol	92	10/06 → 07/10
2.0	Petrol	107	10/06 → 12/12

S40 II (MS)

1.8	Petrol	92	04/04 → 07/10
2.0	Petrol	107	10/06 → 08/12

S80 II (AS)

2.0	Petrol	107	01/08 → 07/12
-----	--------	-----	---------------

V50 (MW)

1.8	Petrol	92	04/04 → 07/10
2.0	Petrol	107	10/06 → 12/12

FEI0014

VOLVO
V70 III (BW)

2.0	Petrol	107	10/07 → 07/11
-----	--------	-----	---------------

FEI0017
**INIETTORE
FUEL INJECTOR**

FORD
B-MAX

1.6 Ti	Petrol	77	10/12 →
--------	--------	----	---------

C-MAX (DM2)

1.6	Petrol	74	03/07 → 07/10
-----	--------	----	---------------

FIESTA IV (JA_, JB_)

1.25 i 16V	Petrol	55	01/00 → 01/02
------------	--------	----	---------------

1.6 16V Sport	Petrol	76	02/00 → 01/02
---------------	--------	----	---------------

FIESTA V (JH_, JD_)

1.25 16V	Petrol	51	03/03 → 06/08
----------	--------	----	---------------

1.25 16V	Petrol	55	12/02 → 06/08
----------	--------	----	---------------

1.4 16V	Petrol	59	11/01 → 06/08
---------	--------	----	---------------

1.6 16V	Petrol	74	11/01 → 06/08
---------	--------	----	---------------

FIESTA VI

1.6 Ti	Petrol	88	06/08 → 11/12
--------	--------	----	---------------

1.6 Ti	Petrol	99	01/11 → 11/12
--------	--------	----	---------------

FOCUS (DAW, DBW)

1.4 16V	Petrol	55	10/98 → 11/04
---------	--------	----	---------------

1.6 16V	Petrol	74	10/98 → 11/04
---------	--------	----	---------------

FOCUS C-MAX

1.6	Petrol	74	10/03 → 03/07
-----	--------	----	---------------

1.6 Ti	Petrol	85	08/04 → 03/07
--------	--------	----	---------------

FOCUS II (DA_)

1.4	Petrol	59	11/04 → 12/11
-----	--------	----	---------------

1.6	Petrol	74	11/04 → 12/11
-----	--------	----	---------------

1.6 LPG	Petrol/ LPG	85	10/09 → 12/11
---------	----------------	----	---------------

1.6 Ti	Petrol	85	11/04 → 12/11
--------	--------	----	---------------

FEI0017

FORD
FOCUS II Cabriolet

1.6	Petrol	74	10/06 → 07/10
-----	--------	----	---------------

FOCUS II Station wagon (DA_)

1.4	Petrol	59	11/04 → 12/11
-----	--------	----	---------------

1.6	Petrol	74	11/04 → 12/11
-----	--------	----	---------------

FOCUS II Station wagon (DA_)

1.6 LPG	Petrol/ LPG	85	10/09 → 12/11
---------	----------------	----	---------------

1.6 Ti	Petrol	85	11/04 → 12/11
--------	--------	----	---------------

FOCUS II Tre volumi (DA_)

1.4	Petrol	59	04/05 → 12/11
-----	--------	----	---------------

1.6	Petrol	74	04/05 → 12/11
-----	--------	----	---------------

1.6 Ti	Petrol	85	04/05 → 12/11
--------	--------	----	---------------

FOCUS Station wagon (DNW)

1.4 16V	Petrol	55	02/99 → 11/04
---------	--------	----	---------------

1.6 16V	Petrol	74	02/99 → 11/04
---------	--------	----	---------------

FOCUS Tre volumi (DFW)

1.4 16V	Petrol	55	02/99 → 11/04
---------	--------	----	---------------

1.6 16V	Petrol	74	02/99 → 11/04
---------	--------	----	---------------

FUSION (JU_)

1.25	Petrol	55	03/05 → 06/12
------	--------	----	---------------

1.4	Petrol	59	10/02 → 06/12
-----	--------	----	---------------

1.6	Petrol	74	10/02 → 06/12
-----	--------	----	---------------

MONDEO IV (BA7)

1.6 Ti	Petrol	81	03/07 → 08/10
--------	--------	----	---------------

1.6 Ti	Petrol	92	03/07 → 08/10
--------	--------	----	---------------

MONDEO IV Tre volumi (BA7)

1.6 Ti	Petrol	81	03/07 → 08/10
--------	--------	----	---------------

1.6 Ti	Petrol	92	03/07 → 08/10
--------	--------	----	---------------

MONDEO IV Turnier (BA7)

1.6 Ti	Petrol	81	03/07 → 08/10
--------	--------	----	---------------

1.6 Ti	Petrol	92	03/07 → 08/10
--------	--------	----	---------------

PUMA (EC_)

1.6 16V	Petrol	76	08/00 → 12/01
---------	--------	----	---------------

IPM001

**INIETTORE
FUEL INJECTOR**



PEUGEOT

206 2 volumi /Coda spiovente (2A/C)

1.4 i Petrol 55 09/98 →

IPM002

**INIETTORE
FUEL INJECTOR**



CITROËN

C2 (JM_)

1.1 Petrol 44 09/03 → ENGINE: HFX(TU1JP)

C3 I (FC_)

1.1 i Petrol 44 02/02 → ENGINE: HFX(TU1JP)

PEUGEOT

206 2 volumi /Coda spiovente (2A/C)

1.1 i Petrol 44 09/98 →

206 SW (2E/K)

1.1 Petrol 44 07/02 →

IPM012

**INIETTORE
FUEL INJECTOR**



CITROËN

C3 I (FC_)

1.4 16V Petrol 65 12/03 → ENGINE: ET3

1.4 i Bivalent Petrol/
CNG 54 02/02 → ENGINE: ET3

C3 Pluriel (HB_)

1.4 Petrol 54 05/03 → ENGINE: ET3

C4 Coupé (LA_)

1.4 16V Petrol 65 11/04 → ENGINE: ET3

C4 I (LC_)

1.4 16V Petrol 65 11/04 → ENGINE: ET3

PEUGEOT

207 (WA_, WC_)

1.4 Petrol 53 02/06 → ENGINE: ET3

1.4 16V Petrol 65 02/06 → ENGINE: ET3

307 (3A/C)

1.4 Petrol 55 08/00 → ENGINE: ET3

1.4 16V Petrol 65 11/03 → ENGINE: ET3

307 Break (3E)

1.4 16V Petrol 65 11/03 → ENGINE: ET3

307 SW (3H)

1.4 16V Petrol 65 11/03 → ENGINE: ET3

IPM019
**INIETTORE
FUEL INJECTOR**

KW

FIAT
DUCATO Pianale piatto/Telaio (250)

140 Natural Power	Petrol/CNG	100	04/09 →	ENGINE: F1CE0441A
-------------------	------------	-----	---------	-------------------

IWP001/1
**INIETTORE
FUEL INJECTOR**

KW

FIAT
BRAVA (182)

1.6 16V (182.BH)	Petrol	66	10/95 → 12/97
------------------	--------	----	---------------

BRAVO I (182)

1.6 16V (182.AH)	Petrol	66	10/95 → 12/97
------------------	--------	----	---------------

PALIO Weekend (178DX)

1.6 16V (178DX. D1A)	Petrol	74	04/96 → 02/01
----------------------	--------	----	---------------

IWP006
**INIETTORE
FUEL INJECTOR**

KW

FIAT
BRAVA (182)

1.8 GT 16V (182.BC)	Petrol	83	10/95 → 10/01
---------------------	--------	----	---------------

BRAVO I (182)

1.8 GT (182.AC)	Petrol	83	10/95 → 10/01
-----------------	--------	----	---------------

PUNTO (188)

1.8 130 HGT (188.738, .718)	Petrol	96	09/99 →
-----------------------------	--------	----	---------

STILO (192)

1.8 16V (192_XC1A)	Petrol	98	10/01 → 11/06
--------------------	--------	----	---------------

IWP022
**INIETTORE
FUEL INJECTOR**

KW

FORD
GALAXY (WGR)

2.8 i V6	Petrol	128	11/95 → 04/00
----------	--------	-----	---------------

2.8 i V6 4x4	Petrol	128	07/96 → 03/00
--------------	--------	-----	---------------

VOLKSWAGEN
CORRADO (53I)

2.9 VR6	Petrol	140	08/91 → 07/95
---------	--------	-----	---------------

IWP022



VOLKSWAGEN

GOLF III (1H1)

2.8 VR6 Petrol 128 01/92 → 08/97

2.9 VR6 Syncro (1HX1) Petrol 140 10/94 → 08/97

PASSAT (3A2, 35I)

2.8 VR6 Petrol 128 10/91 → 08/96

PASSAT Variant (3A5, 35I)

2.8 VR6 Petrol 128 10/91 → 03/97

2.9 VR6 Syncro Petrol 135 01/94 → 05/97

SHARAN (7M8, 7M9, 7M6)

2.8 VR6 Petrol 128 09/95 → 02/00

VENTO (1H2)

2.8 VR6 Petrol 128 01/92 → 12/97

IWP023

**INIETTORE
FUEL INJECTOR**



FIAT

PUNTO (176)

75 1.2 Petrol 54 02/98 → 09/98

PUNTO (188)

1.2 60 (188.030, .050, .130, .150, .230, .250) Petrol 44 09/99 →

SEAT

CORDOBA (6K1, 6K2)

1.6 i Petrol 55 02/93 → 06/99

CORDOBA Vario (6K5)

1.6 i Petrol 55 09/96 → 06/99

IBIZA II (6K1)

1.6 i Petrol 55 03/93 → 08/99

IWP023



SKODA

105,120 (744)

1.2 120 L Petrol 38 10/83 → 12/90

FELICIA I (6U1)

1.6 LX Petrol 55 08/95 → 03/98

VOLKSWAGEN

POLO (6N1)

75 1.6 Petrol 55 10/94 → 10/99

VENTO (1H2)

1.6 Petrol 55 09/92 → 09/98

IWP024

**INIETTORE
FUEL INJECTOR**



VOLKSWAGEN

GOL

2.0 Petrol 85 10/96 → 05/02

PARATI

2.0 Petrol 85 01/97 → 07/99

QUANTUM

2.0 Petrol 91 01/97 → 08/98

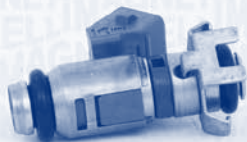
IWP042
**INIETTORE
FUEL INJECTOR**

KW

RENAULT
CLIO II (BB0/1/2_, CB0/1/2_)

2.0 16V Sport Petrol 132 01/04 → 05/05

2.0 16V Sport (CB0M) Petrol 124 02/00 → 05/05

ESPACE III (JE0_)

2.0 16V (JE0N, JE0L, JE02) Petrol 103 10/98 → 10/02

LAGUNA I (B56_, 556_)

1.8 16V (B563, B564) Petrol 88 04/98 → 03/01

LAGUNA I Grandtour (K56_)

1.8 16V (K563, K564) Petrol 88 04/98 → 03/01

LAGUNA II (BG0/1_)

1.8 16V (BG06, BG0J, BG0M) Petrol 85 03/01 →

1.8 16V (BG0B, BG0C, BG0J, BG0M, BG0V) Petrol 89 03/01 →

1.8 16V (BG0B, BG0M) Petrol 88 03/01 →

LAGUNA II Grandtour (KG0/1_)

1.8 16V Petrol 89 03/01 →

1.8 16V (KG0B, KG0M) Petrol 88 03/01 →

1.8 16V (KG0J) Petrol 85 03/01 →

MEGANE II (BM0/1_, CM0/1_)

2.0 16V (BM0U, CM0U) Petrol 99 11/02 →

SCÉNIC I (JA0/1_)

2.0 16V (JA1B, JA1D) Petrol 102 07/00 → 08/03

TRAFIC II Autobus (JL)

2.0 16V Petrol 86 08/06 →

IWP042

KW

RENAULT
TRAFIC II Furgonato (FL)

2.0 16V Petrol 86 08/06 →

IWP044
**INIETTORE
FUEL INJECTOR**

KW

SEAT
INCA (6K9)

1.6 i Petrol 55 06/97 → 09/00 ENGINE: AEE,ALM

VOLKSWAGEN
GOL

1.6 Petrol 68 12/98 → 05/02

1.6 Petrol 73 12/98 → 05/08 ENGINE: BWX

1.8 Petrol 77 04/98 → 05/02

PARATI

1.6 Petrol 65 01/97 → 07/99

1.6 Petrol 73 01/97 → 07/99

1.8 Petrol 72 05/96 → 07/02

POLO CLASSIC (6KV2)

1.8 Petrol 73 05/96 → 09/01

QUANTUM

1.8 Petrol 76 01/97 → 12/01

SAVEIRO Pianale piatto/Telaio

1.6 Petrol 73 07/97 → 01/00

1.8 Petrol 72 12/97 → 07/01

IWP045

**INIETTORE
FUEL INJECTOR**



FIAT

PUNTO (176)

1.2 16V Petrol 63 04/97 → 09/99

PUNTO Cabriolet (176C)

85 16V 1.2 Petrol 63 04/97 → 06/00

LANCIA

Y (840A)

1.2 16V (840AD) Petrol 63 04/97 → 09/03

IWP049/1

**INIETTORE
FUEL INJECTOR**



CITROËN

BERLINGO (MF)

1.8 i (MFLFX) Petrol 66 05/97 →

XSARA (N1)

1.8 i Petrol 66 04/97 → 09/00

XSARA Break (N2)

1.8 i Petrol 66 10/97 → 09/00

PEUGEOT

406 (8B)

1.8 Petrol 66 05/97 → 05/04

406 Break (8E/F)

1.8 Petrol 66 05/97 → 10/04

IWP049/1



PEUGEOT

RANCH MPV / Space wagon (5F)

1.8 Petrol 66 05/97 → ENGINE: XU7JB

IWP058

**INIETTORE
FUEL INJECTOR**



SEAT

AROSA (6H)

1.4 16V Petrol 74 01/00 → 06/04

VOLKSWAGEN

GOLF IV (1J1)

1.4 16V Petrol 55 08/97 → 06/05

GOLF IV Variant (1J5)

1.4 16V Petrol 55 05/99 → 06/06

POLO (6N2)

1.4 16V Petrol 55 10/99 → 09/01

1.4 16V Petrol 74 10/99 → 09/01

POLO Variant (6KV5)

1.4 16V Petrol 55 10/99 → 09/01

IWP064
**INIETTORE
FUEL INJECTOR**

LANCIA
DEDRA (835)

1.6 16V (835EI) Petrol 76 01/96 → 07/99

DEDRA SW (835)

1.6 16V (835EI) Petrol 76 01/96 → 07/99

LYBRA (839AX)

1.6 16V (839AXA1A) Petrol 76 07/99 → 10/05

LYBRA SW (839BX)

1.6 16V (839BXA1A) Petrol 76 07/99 → 10/05

IWP091
**INIETTORE
FUEL INJECTOR**

VOLKSWAGEN
LUPO (6X1, 6E1)

1.6 GTI Petrol 92 09/00 → 07/05 ENGINE: AVY

POLO (6N2)

1.6 16V GTI Petrol 92 10/99 → 09/01 ENGINE: AVY

IWP092
**INIETTORE
FUEL INJECTOR**

SEAT
CORDOBA (6K2)

1.4 16V Petrol 55 05/00 → 10/02 ENGINE: AUA,APE

IBIZA III (6K1)

1.4 16V Petrol 55 05/00 → 02/02 ENGINE: AUA,APE

INCA (6K9)

1.4 16V Petrol 55 04/00 → 06/03 ENGINE: AUA

LEON (1M1)

1.4 16V Petrol 55 11/99 → 06/06

SKODA
OCTAVIA (1U2)

1.4 16V Petrol 55 09/00 → 12/10 ENGINE: AXP,BCA

OCTAVIA Combi (1U5)

1.4 16V Petrol 55 08/00 → 12/10 ENGINE: AXP,BCA

VOLKSWAGEN
BORA (1J2)

1.4 16V Petrol 55 03/00 → 05/05 ENGINE: APE, AHW, AKQ, AXP, BCA

BORA Station wagon (1J6)

1.4 16V Petrol 55 09/01 → 05/05 ENGINE: AHW,AXP,BCA

LUPO (6X1, 6E1)

1.4 16V Petrol 55 09/98 → 07/05

POLO (6N2)

1.4 16V Petrol 55 10/99 → 09/01 ENGINE: APE,AUA

POLO Variant (6KV5)

1.4 16V Petrol 55 10/99 → 09/01 ENGINE: APE,AUA

IWP098

**INIETTORE
FUEL INJECTOR**



RENAULT

ESPACE IV (JK0/1_)

2.0 Turbo (JK0B, JK0N)	Petrol	120	11/02 →	ENGINE: F4R-794,795,796,797
------------------------	--------	-----	---------	-----------------------------

LAGUNA II (BG0/1_)

2.0 16V Turbo (BG0S, BG0Z, BG1L, BG1M)	Petrol	120	01/03 →	ENGINE: F4R-765,786,787,887
--	--------	-----	---------	-----------------------------

LAGUNA II Grandtour (KG0/1_)

2.0 16V Turbo (KG0S, KG0Z, KG1L, KG1M)	Petrol	120	01/03 →	ENGINE: F4R-765,786,787,887
--	--------	-----	---------	-----------------------------

MEGANE II (BM0/1_, CM0/1_)

2.0 16V Turbo	Petrol	120	05/04 →	ENGINE: F4R-776
---------------	--------	-----	---------	-----------------

SCÉNIC II (JM0/1_)

2.0 16V Turbo (JM0W)	Petrol	120	05/04 →	ENGINE: F4R-776
----------------------	--------	-----	---------	-----------------

IWP099

**INIETTORE
FUEL INJECTOR**



RENAULT

CLIO II (BB0/1/2_, CB0/1/2_)

1.2	Petrol	55	06/01 → 10/03	
-----	--------	----	---------------	--

IWP099



RENAULT

CLIO II (BB0/1/2_, CB0/1/2_)

1.2 16V (BB05, BB0W, BB11, BB27, BB2T, BB2U, BB2V, CB05...)	Petrol	55	06/01 →	ENGINE: D4F712, D4F714, D4F722, D4F706, D4F728
---	--------	----	---------	--

KANGOO (KC0/1_)

1.2 16V (KC03, KC05, KC06, KC0T, KC0W)	Petrol	55	06/01 →	ENGINE: D4F712, D4F714, D4F716
--	--------	----	---------	--------------------------------

KANGOO Express (FC0/1_)

1.2 16V (FC05)	Petrol	55	10/01 →	ENGINE: D4F712, D4F714, D4F730
----------------	--------	----	---------	--------------------------------

THALIA I (LB0/1/2_)

1.2 16V	Petrol	55	04/02 →	ENGINE: D4F712
---------	--------	----	---------	----------------

TWINGO I (C06_)

1.2 16V (C06C, C06D, C06K)	Petrol	55	01/01 →	ENGINE: D4F702
----------------------------	--------	----	---------	----------------

IWP116/1

**INIETTORE
FUEL INJECTOR**



FIAT

DOBLO (119)

1.2 (223AXA1A)	Petrol	48	03/01 →	
----------------	--------	----	---------	--

DOBLO Cargo (223)

1.2 (223ZX1A)	Petrol	48	03/01 →	
---------------	--------	----	---------	--

PALIO (178BX)

1.2	Petrol	54	01/01 →	
-----	--------	----	---------	--

PALIO Weekend (178DX)

1.2 (178DYA1A)	Petrol	44	02/01 →	
----------------	--------	----	---------	--

PANDA (141A_)

1100	Petrol	40	01/01 → 09/03	
------	--------	----	---------------	--

1100 4x4	Petrol	40	01/01 → 07/04	
----------	--------	----	---------------	--

1100 Trekking 4x4	Petrol	37	01/01 → 07/04	
-------------------	--------	----	---------------	--

IWP116/1

FIAT
PUNTO (188)

1.2 60 (188.030, .050, .130, .150, .230, .250)	Petrol	44	01/01 →
--	--------	----	---------

PUNTO Van (188AX)

1.2 60	Petrol	44	01/01 → 10/09
--------	--------	----	---------------

SEICENTO (187)

1.1 (187AXB, 187AXB1A)	Petrol	40	01/01 → 01/10
------------------------	--------	----	---------------

SEICENTO Van (187)

1.1 (187CXB/C)	Petrol	40	01/01 → 01/10
----------------	--------	----	---------------

SIENA (178_)

1.2	Petrol	54	01/01 →
-----	--------	----	---------

STRADA Pick-up (178E)

1.2	Petrol	44	04/03 →
-----	--------	----	---------

1.2	Petrol	54	01/01 →
-----	--------	----	---------

LANCIA
Y (840A)

1.2 (840AA, 840AF1A)	Petrol	44	01/01 → 09/03
----------------------	--------	----	---------------

IWP119
**INIETTORE
FUEL INJECTOR**

FORD
FIESTA V (JH_, JD_)

1.3	Petrol	44	11/01 → 06/08
-----	--------	----	---------------

1.3	Petrol	51	11/01 → 06/08
-----	--------	----	---------------

KA (RB_)

1.3 i	Petrol	51	08/02 → 11/08
-------	--------	----	---------------

IWP123
**INIETTORE
FUEL INJECTOR**

SEAT
LEON (1M1)

1.6 16 V	Petrol	77	09/00 → 06/06
----------	--------	----	---------------

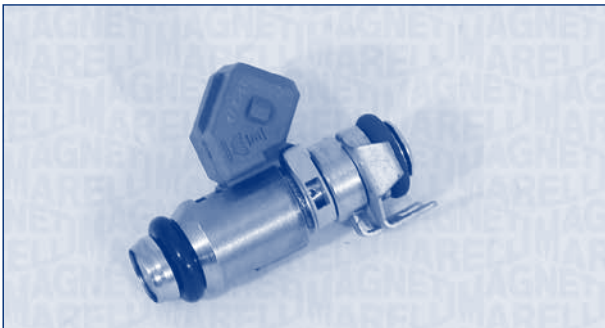
IWP142
**INIETTORE
FUEL INJECTOR**

RENAULT
CLIO II (BB0/1/2_, CB0/1/2_)

1.4 16V (B/CB0L)	Petrol	70	10/99 → 08/00
------------------	--------	----	---------------

1.4 16V (B/CB0P)	Petrol	72	08/00 → 10/07
------------------	--------	----	---------------

1.6 16V (BB01, BB0H, BB0T, BB14, BB1D, BB1R, BB2KL...)	Petrol	79	09/98 → 10/07
--	--------	----	---------------

LAGUNA I (B56_, 556_)

1.6 16V (B568, B561)	Petrol	79	05/98 → 02/01
----------------------	--------	----	---------------

LAGUNA I Grandtour (K56_)

1.6 16V (K568)	Petrol	79	05/98 → 02/01
----------------	--------	----	---------------

MEGANE I (BA0/1_)

1.4 16V (BA0D, BA1H, BA0W, BA10)	Petrol	70	03/99 → 10/02
----------------------------------	--------	----	---------------

IWP142



RENAULT

MEGANE I (BA0/1_)

1.6 16V (BA11, BA04, BA0B, BA1J)	Petrol	79	03/99 → 10/02
----------------------------------	--------	----	---------------

MEGANE I Classic (LA0/1_)

1.4 16V (LA0D, LA1H, IA0W, LA10)	Petrol	70	03/99 → 08/03
----------------------------------	--------	----	---------------

1.6 16V (La04, LA11, LA0B, LA1C, LA1J)	Petrol	79	03/99 → 08/03
--	--------	----	---------------

MEGANE I Grandtour (KA0/1_)

1.4 16V (KA0D, KA1H, KA0W, KA10)	Petrol	70	03/99 → 08/03
----------------------------------	--------	----	---------------

1.6 16V (KA0B, KA04, KA11)	Petrol	79	03/99 → 08/03
----------------------------	--------	----	---------------

MEGANE Scenic (JA0/1_)

1.6 16V (JA0B, JA04, JA11)	Petrol	79	08/99 → 10/99
----------------------------	--------	----	---------------

SCÉNIC I (JA0/1_)

1.4 16V (JA0D, JA1H, Ja0W, JA10)	Petrol	70	09/99 → 04/03
----------------------------------	--------	----	---------------

IWP143

**INIETTORE
FUEL INJECTOR**



RENAULT

CLIO II (BB0/1/2_, CB0/1/2_)

1.6 16V	Petrol	82	10/01 → 12/08
---------	--------	----	---------------

IWP160

**INIETTORE
FUEL INJECTOR**



FIAT

500 (312)

1.2	Petrol	51	10/07 →
-----	--------	----	---------

DOBLO (119)

1.4	Petrol	57	10/05 →
-----	--------	----	---------

DOBLO Cargo (223)

1.4	Petrol	57	10/05 →
-----	--------	----	---------

IDEA

1.4	Petrol	57	10/05 →
-----	--------	----	---------

LINEA (323)

1.4	Petrol	57	06/07 →
-----	--------	----	---------

PUNTO / GRANDE PUNTO (199)

1.2	Petrol	48	10/05 →
-----	--------	----	---------

1.4	Petrol	57	10/05 →
-----	--------	----	---------

PUNTO EVO (199)

1.2	Petrol	48	10/09 → 02/12
-----	--------	----	---------------

QUBO (225)

1.4	Petrol	54	02/08 →
-----	--------	----	---------

LANCIA

MUSA (350)

1.4	Petrol	57	09/05 →
-----	--------	----	---------

YPSILON (843)

1.2	Petrol	44	10/03 → 12/11
-----	--------	----	---------------

1.4	Petrol	57	02/06 → 12/11
-----	--------	----	---------------

IWP163

**INIETTORE
FUEL INJECTOR**



SKODA

OCTAVIA (1Z3)

1.4 Petrol 59 06/04 →

VOLKSWAGEN

GOLF PLUS (5M1, 521)

1.4 16V Petrol 55 01/05 →

GOLF V (1K1)

1.4 16V Petrol 55 10/03 → 05/06

IWP164



FIAT

MULTIPLA (186)

1.6 16V Bipower (186AXC1A) Petrol/CNG 76 10/01 → 06/10

1.6 16V Blupower (186AMA1A) Bifuel 70 04/99 → 06/10

PALIO (178BX)

1.6 16V Petrol 74 04/96 →

PALIO Weekend (178DX)

1.6 16V (178DYC1A06) Petrol 76 02/01 →

SIENA (178_)

1.6 16V Petrol 78 09/98 →

STILO (192)

1.6 16V (192_XB1A) Petrol 76 10/01 → 11/06

STILO Multi Wagon (192)

1.6 16V Petrol 76 01/03 → 08/08

IWP164

**INIETTORE
FUEL INJECTOR**



FIAT

DOBLO (119)

1.6 16V (223AXD1A) Petrol 76 10/01 →

DOBLO Cargo (223)

1.6 16V (223ZXD1A) Petrol 76 10/01 →

MULTIPLA (186)

1.6 100 16V (186AXA1A) Petrol 76 04/99 → 06/10

1.6 16V Bipower (186AMB1A) Petrol/CNG 76 04/99 → 06/10

KIT IWP065

**KIT INIETTORE
FUEL INJECTOR KIT**



FIAT

PALIO (178BX)

1.0 Petrol 45 04/96 →

1.0 Petrol 56 04/96 →

PALIO Weekend (178DX)

1.0 Petrol 45 07/98 → 10/03

UNO (146 A/E)

1.2 Petrol 44 08/00 → 04/10

GRUPPO D - GROUP D

APS11

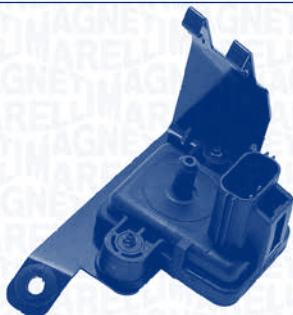
SENSORE PRESSIONE ASSOLUTA
MAP SENSOR

KW



FORD

FOCUS (DAW, DBW)

1.8 TDCi Diesel 85 03/01 → 09/03

FOCUS Station wagon (DNW)

1.8 TDCi Diesel 85 03/01 → 09/03

FOCUS Tre volumi (DFW)

1.8 TDCi Diesel 85 03/01 → 09/03

APS12

SENSORE PRESSIONE ASSOLUTA
MAP SENSOR

KW



FORD

FOCUS (DAW, DBW)

1.4 16V Petrol 55 10/98 → 11/04

1.6 16V Petrol 74 10/98 → 11/04

FOCUS Station wagon (DNW)

1.4 16V Petrol 55 02/99 → 11/04

1.6 16V Petrol 74 02/99 → 11/04

FOCUS Tre volumi (DFW)

1.4 16V Petrol 55 02/99 → 11/04

1.6 16V Petrol 74 02/99 → 11/04

APS13

SENSORE PRESSIONE ASSOLUTA
MAP SENSOR

KW



FORD

C-MAX (DM2)

1.6 Petrol 74 02/07 →

FIESTA IV (JA_, JB_)

1.6 16V Sport Petrol 76 02/00 → 01/02

FIESTA V (JH_, JD_)

1.25 16V Petrol 51 03/03 → 06/08

1.25 16V Petrol 55 05/02 → 06/08

1.3 Petrol 44 11/01 → 06/08

1.3 Petrol 51 11/01 → 06/08

1.4 16V Petrol 59 11/01 → 06/08

1.6 16V Petrol 74 11/01 → 06/08

FIESTA Van

1.3 Petrol 51 10/03 →

FIESTA VI

1.4 Petrol 71 06/08 →

1.4 LPG Petrol/
LPG 71 01/09 →

1.6 Ti Petrol 88 06/08 →

FOCUS C-MAX

1.6 Petrol 74 10/03 → 03/07

1.6 Ti Petrol 85 08/04 → 03/07

FOCUS II (DA_)

1.4 Petrol 59 11/04 →

1.6 Petrol 74 11/04 →

1.6 LPG Petrol/
LPG 85 10/09 →

1.6 Ti Petrol 85 11/04 →

FOCUS II Cabriolet

1.6 Petrol 74 10/06 →

FOCUS II Station wagon (DA_)

1.4 Petrol 59 11/04 →

1.6 Petrol 74 11/04 →

1.6 Ti Petrol 85 11/04 →

APS13

FORD
FOCUS II Tre volumi (DA_)

1.4	Petrol	59	04/05 →	
1.6	Petrol	74	04/05 →	
1.6 Ti	Petrol	85	04/05 →	

FUSION (JU_)

1.25	Petrol	55	08/04 →	
1.3	Petrol	44	11/02 →	
1.4	Petrol	59	08/02 →	
1.6	Petrol	74	08/02 →	

KA (RB_)

1.3 i	Petrol	51	08/02 → 11/08	
1.6 i	Petrol	70	07/03 → 11/08	

STREET KA (RL2)

1.6	Petrol	70	05/03 → 07/05	
-----	--------	----	---------------	--

JAGUAR
S-TYPE (CCX)

R 4,2 V8	Petrol	291	04/02 → 10/07	
----------	--------	-----	---------------	--

XF (_J05_, CC9)

4.2 Kompressor	Petrol	306	03/08 →	
----------------	--------	-----	---------	--

XJ (X350, X358)

R 4.2	Petrol	291	05/03 → 03/09	
-------	--------	-----	---------------	--

MAZDA
2 (DY)

1.25	Petrol	55	04/03 →	
1.4	Petrol	59	04/03 →	
1.6	Petrol	74	04/03 →	

VOLVO
C30

1.6	Petrol	74	10/06 → 12/12	
-----	--------	----	---------------	--

VOLVO
S40 II (MS)

1.6	Petrol	74	01/05 →	
-----	--------	----	---------	--

V50 (MW)

1.6	Petrol	74	01/05 →	
-----	--------	----	---------	--

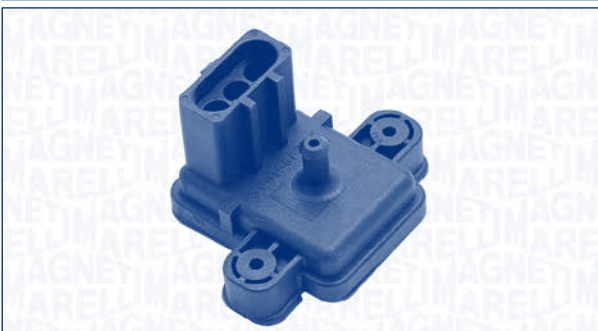
APS14
**SENSORE PRESSIONE ASSOLUTA
MAP SENSOR**

FORD
TRANSIT Autobus (E_ _)

2.5 TD (EBS, EBL, ECL, EDS, EDL, ESS, EUS)	Diesel	63	10/92 → 07/94	
--	--------	----	---------------	--

2.5 TD (ECL, EDS, EDL, EGL, ESS, EUS)	Diesel	74	09/91 → 07/94	
---------------------------------------	--------	----	---------------	--

TRANSIT Furgonato (E_ _)

2.5 DI (EAL, EAS)	Diesel	85	05/99 → 03/00	ENGINE: DIESEL25
-------------------	--------	----	---------------	------------------

2.5 TD (EAL, EAS)	Diesel	63	09/97 → 03/00	
-------------------	--------	----	---------------	--

2.5 TD (EAS)	Diesel	55	10/98 → 03/00	
--------------	--------	----	---------------	--

2.5 TDI (EAL, EAS)	Diesel	74	09/97 → 03/00	
--------------------	--------	----	---------------	--

TRANSIT Pianale piatto/Telaio (E_ _)

2.5 DI (EML, ENE/L)	Diesel	85	05/99 → 03/00	ENGINE: DIESEL25
---------------------	--------	----	---------------	------------------

2.5 TD (EME/L/S, ENE/L/S)	Diesel	55	10/98 → 07/00	
---------------------------	--------	----	---------------	--

2.5 TD (EME/L/S, ENE/L/S)	Diesel	63	09/97 → 03/00	
---------------------------	--------	----	---------------	--

2.5 TD (EME/L/S, ENE/L/S)	Diesel	74	09/97 → 03/00	
---------------------------	--------	----	---------------	--

APS15

**SENSORE PRESSIONE ASSOLUTA
MAP SENSOR**

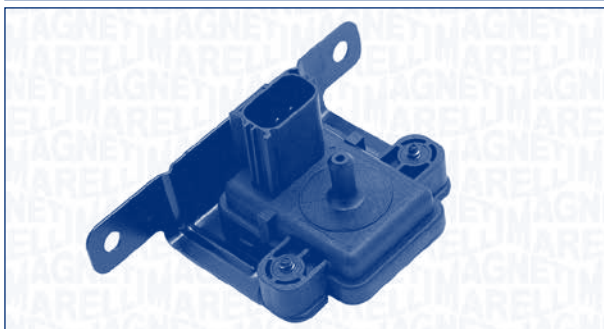

KW



FORD

FOCUS (DAW, DBW)

1.8 DI / TDDi	Diesel	55	08/99 → 11/04	
1.8 TDCi	Diesel	74	08/02 → 09/03	ENGINE: DURATORQTDCI18
1.8 Turbo DI / TDDi	Diesel	66	10/98 → 11/04	

FOCUS Station wagon (DNW)

1.8 DI / TDDi	Diesel	55	08/99 → 11/04	
1.8 TDCi	Diesel	74	08/02 → 09/03	ENGINE: DURATORQTDCI18
1.8 Turbo DI / TDDi	Diesel	66	02/99 → 11/04	

FOCUS Tre volumi (DFW)

1.8 TDCi	Diesel	74	08/02 → 09/03	ENGINE: DURATORQTDCI18
1.8 Turbo DI / TDDi	Diesel	66	02/99 → 11/04	

TRANSIT CONNECT (P65_, P70_, P80_)

1.8 Di	Diesel	55	06/02 →	
1.8 TDCi	Diesel	66	06/02 →	ENGINE: DURATORQTDCI18

APS17

**SENSORE PRESSIONE ASSOLUTA
MAP SENSOR**



KW



FORD

FIESTA IV (JA_, JB_)

1.25 i 16V	Petrol	55	08/95 → 01/02	ENGINE: ZETEC-S
1.3 i	Petrol	37	08/95 → 01/02	ENGINE: HCS13EFI
1.3 i	Petrol	44	08/95 → 01/02	ENGINE: HCS13EFI

KA (RB_)

1.3 i	Petrol	36	06/98 → 11/08	ENGINE: HCS13EFI
-------	--------	----	---------------	------------------

APS18

**SENSORE PRESSIONE ASSOLUTA
MAP SENSOR**



KW



FORD

FIESTA IV (JA_, JB_)

1.25 i 16V	Petrol	55	08/95 → 01/02	
------------	--------	----	---------------	--

APS19
**SENSORE PRESSIONE ASSOLUTA
MAP SENSOR**

KW

FORD
C-MAX (DM2)

1.8	Petrol	92	02/07 →
1.8 Flexifuel	Petrol/ Ethanol	92	02/07 →
2.0	Petrol	107	02/07 →
2.0 CNG	Petrol/ CNG	107	04/09 →
2.0 LPG	Petrol/ LPG	107	06/08 →

FIESTA V (JH_, JD_)

ST150	Petrol	110	03/05 → 06/08
-------	--------	-----	---------------

FOCUS C-MAX

1.8	Petrol	88	10/03 → 03/07
1.8	Petrol	92	04/04 → 03/07
1.8 Flexifuel	Petrol/ Ethanol	92	01/06 → 03/07
2.0	Petrol	107	03/04 → 03/07

FOCUS II (DA_)

1.8	Petrol	92	03/06 →
1.8 Flexifuel	Petrol/ Ethanol	92	01/06 →
2.0	Petrol	107	11/04 →
2.0 CNG	Petrol/ CNG	107	04/09 →
2.0 LPG	Petrol/ LPG	107	06/08 →

FOCUS II Cabriolet

2.0	Petrol	107	10/06 →
-----	--------	-----	---------

FOCUS II Station wagon (DA_)

1.8	Petrol	92	03/06 →
1.8 Flexifuel	Petrol/ Ethanol	92	01/06 →
2.0	Petrol	107	11/04 →

APS19

KW

FORD
FOCUS II Station wagon (DA_)

2.0 LPG	Petrol/ LPG	107	06/08 →
---------	----------------	-----	---------

FOCUS II Tre volumi (DA_)

1.8	Petrol	92	03/06 →
1.8 Flexifuel	Petrol/ Ethanol	92	06/06 →
2.0	Petrol	107	04/05 →

GALAXY (WA6)

2.0	Petrol	107	05/06 →
2.0 Flexifuel	Petrol/ Ethanol	107	05/06 →

MONDEO III (B5Y)

1.8 16V	Petrol	81	11/00 → 08/07
1.8 16V	Petrol	92	11/00 → 08/07
2.0 16V	Petrol	107	11/00 → 08/07

MONDEO III Station wagon (BWY)

1.8 16V	Petrol	81	11/00 → 08/07
1.8 16V	Petrol	92	11/00 → 08/07
2.0 16V	Petrol	107	11/00 → 08/07

MONDEO III Tre volumi (B4Y)

1.8 16V	Petrol	81	11/00 → 08/07
1.8 16V	Petrol	92	11/00 → 08/07
2.0 16V	Petrol	107	11/00 → 08/07

MONDEO IV (BA7)

2.0	Petrol	107	03/07 →
2.0 Flexifuel	Petrol/ Ethanol	107	03/09 →

MONDEO IV Tre volumi (BA7)

2.0	Petrol	107	03/07 →
2.0 Flexifuel	Petrol/ Ethanol	107	03/09 →

MONDEO IV Turnier (BA7)

2.0	Petrol	107	03/07 →
2.0 Flexifuel	Petrol/ Ethanol	107	03/09 →

S-MAX (WA6)

2.0	Petrol	107	05/06 →
2.0 Flexifuel	Petrol/ Ethanol	107	05/06 →

TRANSIT Furgonato

2.3 16V	Petrol	107	04/06 →
---------	--------	-----	---------

TRANSIT Pianale piatto/Telaio

2.3 16V	Petrol	107	04/06 →
---------	--------	-----	---------

APS19



VOLVO

S40 II (MS)

1.8	Petrol	92	04/04 →
1.8 FlexFuel	BiFuel	92	01/06 →
2.0	Petrol	107	10/06 →

V50 (MW)

1.8	Petrol	92	04/04 →
1.8 FlexFuel	BiFuel	92	01/05 →
2.0	Petrol	107	10/06 →
2.0 FlexFuel	BiFuel	107	01/10 →

APS20

**SENSORE PRESSIONE ASSOLUTA
MAP SENSOR**



FORD

TRANSIT Autobus

2.2 TDCi	Diesel	63	04/06 →
2.2 TDCi	Diesel	81	04/06 →
2.2 TDCi	Diesel	96	04/06 →
2.4 TDCi	Diesel	74	04/06 →
2.4 TDCi	Diesel	85	04/06 →
2.4 TDCi	Diesel	103	04/06 →
2.4 TDCi 4x4	Diesel	103	11/06 →
3.2 TDCi	Diesel	147	02/08 →

TRANSIT Furgonato

2.2 TDCi	Diesel	63	04/06 →
2.2 TDCi	Diesel	81	04/06 →
2.2 TDCi	Diesel	96	04/06 →
2.4 TDCi	Diesel	74	04/06 →
2.4 TDCi	Diesel	85	04/06 →
2.4 TDCi	Diesel	103	04/06 →
3.2 TDCi	Diesel	147	09/07 →

TRANSIT Pianale piatto/Telaio

2.2 TDCi	Diesel	63	04/06 →
2.2 TDCi	Diesel	81	04/06 →

APS20



FORD

TRANSIT Pianale piatto/Telaio

2.2 TDCi	Diesel	96	04/06 →
2.4 TDCi	Diesel	74	04/06 →
2.4 TDCi	Diesel	85	04/06 →
2.4 TDCi	Diesel	103	04/06 →
3.2 TDCi	Diesel	147	09/07 →

APS22

**SENSORE PRESSIONE ASSOLUTA
MAP SENSOR**



FORD

FOCUS II (DA_)

2.5 RS	Petrol	224	01/09 →
2.5 ST	Petrol	166	10/05 →

VOLVO

C30

T5	Petrol	162	10/06 → 12/12
----	--------	-----	---------------

C70 II Cabriolet

T5	Petrol	162	03/06 → 07/07
----	--------	-----	---------------

S40 II (MS)

T5	Petrol	162	01/04 → 07/07
T5	Petrol	169	08/07 →
T5 AWD	Petrol	162	04/04 → 07/07
T5 AWD	Petrol	169	08/07 →

S60 I

2.0 T	Petrol	132	08/02 → 07/09
2.3 T5	Petrol	195	08/02 → 09/02
2.4 T	Petrol	147	08/02 → 07/03
2.4 T AWD	Petrol	147	08/02 → 07/03
2.5 T	Petrol	154	04/04 → 07/09
2.5 T AWD	Petrol	154	04/04 → 07/09
T5	Petrol	184	08/02 → 03/04

S80 I (TS, XY)

2.0 T	Petrol	132	12/99 → 07/06
-------	--------	-----	---------------

APS22

VOLVO
S80 I (TS, XY)

2.0 T	Petrol	166	06/98 → 07/06
2.4 D	Diesel	96	10/01 → 07/06
2.4 D5	Diesel	120	08/01 → 07/06
2.4 T	Petrol	147	06/00 → 07/06
2.5 T	Petrol	154	03/03 → 07/06
2.5 T AWD	Petrol	154	07/03 → 07/06
2.8 T6	Petrol	200	05/98 → 07/06
3.0 T6	Petrol	200	06/01 → 07/06

V50 (MW)

T5	Petrol	162	04/04 → 07/07
T5	Petrol	169	08/07 →
T5 AWD	Petrol	162	04/04 → 07/07
T5 AWD	Petrol	169	08/07 →

V70 II (SW)

2.0 T	Petrol	132	08/02 → 07/07
2.3	Petrol	195	08/02 → 07/04
2.3 T5	Petrol	184	08/02 → 07/04
2.4 T	Petrol	147	03/00 → 07/03
2.4 T AWD	Petrol	147	09/01 → 07/03
2.4 T5	Petrol	191	04/04 → 07/07
2.5 T	Petrol	154	04/04 → 07/07
2.5 T AWD	Petrol	154	09/02 → 07/07

XC90 I

2.5 T	Petrol	154	10/02 →
D5	Diesel	120	10/02 →
T6	Petrol	200	10/02 →

APS23

**SENSORE PRESSIONE ASSOLUTA
MAP SENSOR**

ALFA ROMEO
147 (937)

1.9 JTD	Diesel	74	06/03 → 03/10
---------	--------	----	---------------

APS23

ALFA ROMEO
147 (937)

1.9 JTD (937AXD1A)	Diesel	85	04/01 → 03/10	ENGINE: 2705194 →
--------------------	--------	----	---------------	-------------------

156 (932)

1.9 JTD (932A2B, 932A2C)	Diesel	85	05/01 → 09/05	ENGINE: 2705194 →
--------------------------	--------	----	---------------	-------------------

1.9 JTD (932A2B_)	Diesel	81	10/00 → 05/01	ENGINE: 2705194 →
-------------------	--------	----	---------------	-------------------

156 Sportwagon (932)

1.9 JTD (932B2B, 932B2C)	Diesel	85	05/01 → 05/06	ENGINE: 2705194 →
--------------------------	--------	----	---------------	-------------------

1.9 JTD (932B2B_)	Diesel	81	10/00 → 05/01	ENGINE: 2705194 →
-------------------	--------	----	---------------	-------------------

2.4 JTD (932BXC)	Diesel	110	03/02 → 05/06
------------------	--------	-----	---------------

FIAT
DOBLO (119)

1.9 JTD	Diesel	77	07/03 →
---------	--------	----	---------

1.9 JTD (223AXE1A)	Diesel	74	10/01 →
--------------------	--------	----	---------

DOBLO Cargo (223)

1.9 JTD	Diesel	77	07/03 →
---------	--------	----	---------

1.9 JTD (223ZXE1A)	Diesel	74	10/01 →
--------------------	--------	----	---------

IDEA

1.3 JTD	Diesel	51	01/04 →
---------	--------	----	---------

MAREA (185)

1.9 JTD 110	Diesel	81	08/01 → 05/02	ENGINE: 2705195 →
-------------	--------	----	---------------	-------------------

MAREA Weekend (185)

1.9 JTD 110	Diesel	81	08/01 → 05/02	ENGINE: 2705195 →
-------------	--------	----	---------------	-------------------

MULTIPLA (186)

1.9 JTD 105 (186AXB1A)	Diesel	77	04/99 → 12/00
------------------------	--------	----	---------------

1.9 JTD 110	Diesel	81	08/01 → 03/02	ENGINE: 2705195 →
-------------	--------	----	---------------	-------------------

1.9 JTD 115	Diesel	85	07/02 → 06/10
-------------	--------	----	---------------

PANDA (169)

1.3 D Multijet	Diesel	51	01/04 →
----------------	--------	----	---------

1.3 D Multijet 4x4	Diesel	51	10/04 →
--------------------	--------	----	---------

PUNTO (188)

1.3 JTD 16V	Diesel	51	07/03 →
-------------	--------	----	---------

1.9 JTD	Diesel	63	10/01 → 06/03
---------	--------	----	---------------

1.9 JTD 80 (188.237, .257, .337, .357)	Diesel	59	09/99 → 06/03
--	--------	----	---------------

APS23

KW

FIAT
PUNTO Van (188AX)

1.9 JTD Diesel 63 02/00 → 06/03

STILO (192)

1.9 JTD (192_XE1A) Diesel 85 10/01 → 12/03

1.9 JTD (192_XF1A) Diesel 59 02/02 → 12/03

STILO Multi Wagon (192)

1.9 JTD Diesel 59 01/03 → 08/08

1.9 JTD Diesel 85 01/03 → 08/08

STRADA Pick-up (178E)

1.9 JTD Diesel 59 05/03 →

LANCIA
LYBRA (839AX)

1.9 JTD Diesel 85 05/01 → 10/05 ENGINE: 2705194 →

1.9 JTD (839AXI1A) Diesel 81 09/00 → 05/01 ENGINE: 2705194 →

2.4 JTD Diesel 110 05/02 → 10/05

2.4 JTD (839AXL1A) Diesel 103 09/00 → 05/02

LYBRA SW (839BX)

1.9 JTD Diesel 85 05/01 → 10/05 ENGINE: 2705194 →

1.9 JTD (839BXI1A) Diesel 81 09/00 → 05/01 ENGINE: 2705194 →

2.4 JTD Diesel 110 05/02 → 10/05

2.4 JTD (839BXL1A) Diesel 103 09/00 → 10/05

THESIS (841AX)

2.4 JTD (841AXD1B02) Diesel 110 07/02 → 07/09

YPSILON (843)

1.3 JTD Diesel 51 10/03 → 12/11

NISSAN
PRIMASTAR Autobus (X83)

dCi 140 Diesel 99 07/03 →

PRIMASTAR Furgonato (X83)

dCi 140 Diesel 99 07/03 →

OPEL
AGILA (A) (H00)

1.3 CDTI Diesel 51 08/03 → 12/07

CORSA C (F08, F68)

1.3 CDTI Diesel 51 06/03 → 12/09

CORSA C Furgonato (F08, W5L)

1.3 CDTI 16V Diesel 51 08/05 →

APS23

KW

OPEL
TIGRA TwinTop

1.3 CDTI Diesel 51 06/04 →

RENAULT
AVANTIME (DE0_)

2.2 dCi (DE01) Diesel 110 05/02 → 05/03

ESPACE III (JE0_)

2.2 dCi (JE0K) Diesel 95 10/00 → 10/02

ESPACE IV (JK0/1_)

2.2 dCi (JK0H) Diesel 110 11/02 →

LAGUNA II (BG0/1_)

1.9 dCi (BG08, BG0G) Diesel 88 04/01 →

2.2 dCi (BG0F) Diesel 110 10/01 →

LAGUNA II Grandtour (KG0/1_)

1.9 dCi (KG0G) Diesel 88 04/01 →

2.2 dCi (KG0F) Diesel 110 10/01 →

TRAFIC II Autobus (JL)

2.5 dCi 135 (JL0D) Diesel 99 05/03 →

TRAFIC II Furgonato (FL)

2.5 dCi 135 (FL0D) Diesel 99 05/03 →

VEL SATIS (BJ0_)

2.2 dCi (BJ0E, BJ0F) Diesel 110 06/02 →

SMART
CABRIO (450)

0.6 (450.400, S10LD2) Petrol 45 01/01 → 01/04

0.6 (450.432) Petrol 52 06/02 → 01/04

0.6 (450.433, S10LA1) Petrol 40 03/00 → 01/04

0.7 (450.400) Petrol 45 01/03 → 01/04

0.7 (450.414) Petrol 55 01/03 → 01/04

CITY-COUPÉ (450)

0.6 (450.330, 450.332) Petrol 52 06/02 → 01/04

0.6 (450.333, 450.335) Petrol 45 01/01 → 01/04

0.6 (450.341, S1CLA1) Petrol 40 07/98 → 01/04

0.6 (450.342, S1CLB1) Petrol 33 07/98 → 01/04

0.7 (450.314) Petrol 55 01/03 → 01/04

APS23

SMART
CITY-COUPE (450)

0.7 (450.336, 450.352, 450.353)	Petrol	45	01/03 → 01/04
---------------------------------------	--------	----	---------------

FORTWO Cabrio (450)

0.7 (450.414, 450.441, 450.442, 450.443, 450.452)	Petrol	45	01/04 → 01/07
---	--------	----	---------------

0.7 (450.452)	Petrol	55	01/04 → 01/07
---------------	--------	----	---------------

FORTWO Coupé (450)

0.7 (450.314)	Petrol	55	01/04 → 01/07
---------------	--------	----	---------------

0.7 (450.331)	Petrol	37	01/04 → 01/07
---------------	--------	----	---------------

0.7 (450.335, 450.336, 450.341, 450.342, 450.343...)	Petrol	45	01/04 → 01/07
--	--------	----	---------------

ROADSTER (452)

0.7 (452.432)	Petrol	45	04/03 → 11/05
---------------	--------	----	---------------

0.7 (452.434)	Petrol	60	04/03 → 11/05
---------------	--------	----	---------------

ROADSTER Coupé (452)

0.7 (452.334)	Petrol	60	04/03 → 11/05
---------------	--------	----	---------------

VAUXHALL
CORSA Mk II (C) (W5L, F08)

1.3 CDTI 16V	Diesel	52	08/00 → 09/06
--------------	--------	----	---------------

CORSAVAN Mk II (C)

1.3 CDTI 16V	Diesel	52	04/04 → 06/06
--------------	--------	----	---------------

TIGRA TwinTop

1.3 CDTI	Diesel	51	06/04 → 08/09
----------	--------	----	---------------

APS24
**SENSORE PRESSIONE ASSOLUTA
MAP SENSOR**

HONDA
ACCORD VI (CG, CK)

1.6 i	Petrol	85	10/98 → 12/02
-------	--------	----	---------------

SAAB
9-3 (YS3D)

2.2 TiD	Diesel	85	02/98 → 11/00	CHASSIS: 12020001 →
---------	--------	----	---------------	------------------------

2.2 TiD	Diesel	92	11/00 → 09/02	CHASSIS: 12020001 →
---------	--------	----	---------------	------------------------

APS25
**SENSORE PRESSIONE ASSOLUTA
MAP SENSOR**

FIAT
IDEA

1.3 D Multijet	Diesel	66	10/05 →
----------------	--------	----	---------

PUNTO / GRANDE PUNTO (199)

1.3 D Multijet	Diesel	66	10/05 →
----------------	--------	----	---------

LANCIA
YPSILON (843)

1.3 D Multijet	Diesel	66	09/06 → 12/11
----------------	--------	----	---------------

APS26

**SENSORE PRESSIONE ASSOLUTA
MAP SENSOR**



OPEL

ASTRA G 2 volumi /Coda spiovente (F48_, F08_)

2.0 DTI 16V	Diesel	74	08/99 → 01/05	CHASSIS: 12000001 →, → 2H999999
-------------	--------	----	---------------	---------------------------------------

ASTRA G Station wagon (F35_)

2.0 DTI 16V	Diesel	74	08/99 → 07/04	CHASSIS: 12000001 →, → 2H999999
-------------	--------	----	---------------	---------------------------------------

ASTRA G Tre volumi (F69_)

2.0 DTI 16V	Diesel	74	08/99 → 01/05	CHASSIS: 12000001 →, → 2H999999
-------------	--------	----	---------------	---------------------------------------

VECTRA B (36_)

2.0 DTI 16V	Diesel	74	09/00 → 04/02
2.2 DTI 16V	Diesel	92	09/00 → 04/02

VECTRA B 2 volumi /Coda spiovente (38_)

2.0 DTI 16V	Diesel	74	09/00 → 07/03
2.2 DTI 16V	Diesel	92	09/00 → 07/03

VECTRA B Station wagon (31_)

2.0 DTI 16V	Diesel	74	09/00 → 07/03
2.2 DTI 16V	Diesel	92	09/00 → 07/03

VAUXHALL

VECTRA (B)

2.0 DTI 16V	Diesel	74	08/95 → 10/01
2.2 DTI 16V	Diesel	92	08/95 → 10/01

VECTRA (B) 2 volumi /Coda spiovente

2.0 DTI 16V	Diesel	74	06/97 → 10/01
2.2 DTI 16V	Diesel	92	08/95 → 10/01

VECTRA (B) Station wagon

2.0 DTI 16V	Diesel	74	08/95 → 10/01
2.2 DTI 16V	Diesel	92	08/95 → 10/01

APS28

**SENSORE PRESSIONE ASSOLUTA
MAP SENSOR**



RENAULT

AVANTIME (DE0_)

2.0 16V Turbo (DE0U, DE0V)	Petrol	120	11/01 → 05/03
----------------------------	--------	-----	---------------

ESPACE IV (JK0/1_)

2.0 Turbo (JK0B, JK0N)	Petrol	120	11/02 →
------------------------	--------	-----	---------

LAGUNA II (BG0/1_)

1.9 dCi (BG08, BG0G)	Diesel	88	03/01 →
2.0 16V Turbo (BG0S, BG0Z, BG1L, BG1M)	Petrol	120	01/03 → 08/03

LAGUNA II Grandtour (KG0/1_)

1.9 dCi (KG0G)	Diesel	88	03/01 →
2.0 16V Turbo (KG0S, KG0Z, KG1L, KG1M)	Petrol	120	01/03 → 08/03

VEL SATIS (BJ0_)

2.0 16V Turbo (BJ0K)	Petrol	120	06/02 → 08/03
----------------------	--------	-----	---------------

VOLVO

S40 I (VS)

1.9 DI	Diesel	75	07/00 → 12/03
1.9 DI	Diesel	85	07/00 → 12/03

V40 Station wagon (VW)

1.9 DI	Diesel	75	07/00 → 06/04
1.9 DI	Diesel	85	07/00 → 06/04

APS29
**SENSORE PRESSIONE ASSOLUTA
MAP SENSOR**

AUDI
80 (8C, B4)

1.9 TDI Diesel 66 09/91 → 12/94

80 Avant (8C, B4)

1.9 TDI Diesel 66 07/92 → 01/96

BENTLEY
AZURE

6.75 V8 Petrol 286 09/95 → 08/99

CONTINENTAL

6.75 V8 S Petrol 286 05/94 → 12/95

CITROËN
XANTIA (X1)

1.8 i Petrol 74 03/93 → 01/98

XANTIA Break (X1)

1.8 i Petrol 74 09/95 → 01/98

XM (Y3)

2.0 i Petrol 89 04/93 → 06/94

XM Break (Y3)

2.0 i Petrol 89 04/93 → 04/94

XSARA (N1)

1.6 i Petrol 65 07/97 → 06/98

XSARA Break (N2)

1.6 i Petrol 65 10/97 → 06/98

ZX (N2)

1.8 i Petrol 74 07/92 → 06/97

ZX Break (N2)

1.8 i Petrol 74 10/93 → 10/97

PEUGEOT
106 I (1A, 1C)

1.6 Petrol 65 06/93 → 04/96

1.6 Petrol 76 01/94 → 04/96

306 (7B, N3, N5)

1.6 SR Petrol 65 06/94 → 04/97

306 2 volumi /Coda spiovente (7A, 7C, N3, N5)

1.6 Petrol 65 05/93 → 04/97

APS29

PEUGEOT
306 Break (7E, N3, N5)

1.6 Petrol 65 05/97 → 05/98

405 II (4B)

1.8 Petrol 74 08/92 → 10/95

405 II Break (4E)

1.8 Petrol 74 08/92 → 10/96

605 (6B)

2.0 Petrol 89 06/93 → 06/94

SEAT
CORDOBA (6K1, 6K2)

1.9 TDI Diesel 81 03/97 → 06/99

CORDOBA Vario (6K5)

1.9 TDI Diesel 66 06/97 → 06/99

1.9 TDI Diesel 81 07/97 → 06/99

TOLEDO I (1L)

1.9 TDI Diesel 66 08/95 → 03/99

VOLKSWAGEN
CADDY II Station wagon (9K9B)

1.9 TDI Diesel 66 10/96 → 01/04

GOLF III (1H1)

1.9 TDI Diesel 66 09/93 → 09/94

GOLF III Variant (1H5)

1.9 TDI Diesel 66 03/94 → 09/94

PASSAT (3A2, 35I)

1.9 TDI Diesel 66 10/93 → 09/94

PASSAT Variant (3A5, 35I)

1.9 TDI Diesel 66 10/93 → 09/94

POLO Variant (6KV5)

1.9 TDI Diesel 66 05/97 → 09/01

VENTO (1H2)

1.9 TDI Diesel 66 09/93 → 07/94

APS30

**SENSORE PRESSIONE ASSOLUTA
MAP SENSOR**



BMW

3 (E46)

318 d	Diesel	85	09/01 → 03/03
320 d	Diesel	100	04/98 → 09/01
330 d	Diesel	135	10/99 → 02/05
330 xd	Diesel	135	06/00 → 02/05

3 Touring (E46)

318 d	Diesel	85	03/02 → 02/05
320 d	Diesel	100	03/00 → 09/01
330 d	Diesel	135	10/99 → 02/05
330 xd	Diesel	135	06/00 → 02/05

5 (E39)

520 d	Diesel	100	02/00 → 06/03
525 d	Diesel	120	02/00 → 06/03
530 d	Diesel	135	08/98 → 09/00
530 d	Diesel	142	09/00 → 06/03

5 Touring (E39)

520 d	Diesel	100	02/00 → 09/03
525 d	Diesel	120	02/00 → 05/04
530 d	Diesel	135	08/98 → 09/00
530 d	Diesel	142	09/00 → 05/04

7 (E38)

730 d	Diesel	135	08/98 → 04/00
730 d	Diesel	142	04/00 → 11/01
740 d	Diesel	180	05/99 → 11/01

X5 (E53)

3.0 d	Diesel	135	05/01 →
-------	--------	-----	---------

LAND ROVER

FREELANDER (LN)

2.0 Td4 4x4	Diesel	80	03/01 → 10/06
2.0 Td4 4x4	Diesel	82	11/00 → 10/06

MG

MG ZT

2.0 CDTi	Diesel	85	06/02 → 09/03
2.0 CDTi	Diesel	96	11/02 → 07/05

APS30



MG

MG ZT- T

2.0 CDTi	Diesel	85	06/02 → 09/03
2.0 CDTi	Diesel	96	11/02 → 07/05

ROVER

75 (RJ)

2.0 CDT	Diesel	85	02/99 → 05/05
2.0 CDTi	Diesel	96	02/03 → 05/05

75 Tourer (RJ)

2.0 CDT	Diesel	85	08/01 → 05/05
2.0 CDTi	Diesel	96	02/03 → 05/05

APS31

**SENSORE PRESSIONE ASSOLUTA
MAP SENSOR**



ALFA ROMEO

145 (930)

1.9 JTD	Diesel	77	02/99 → 01/01
1.9 TD	Diesel	66	05/98 → 02/99

146 (930)

1.9 JTD	Diesel	77	02/99 → 01/01
1.9 TD	Diesel	66	05/98 → 02/99

147 (937)

1.9 JTD (937AXD1A)	Diesel	85	04/01 → 07/01
--------------------	--------	----	---------------

156 (932)

1.9 JTD (932B2)	Diesel	77	09/97 → 10/00
-----------------	--------	----	---------------

2.4 JTD (932A1B_)	Diesel	103	10/00 → 12/01
-------------------	--------	-----	---------------

2.4 JTD (932B1)	Diesel	100	09/97 → 09/03
-----------------	--------	-----	---------------

156 Sportwagon (932)

1.9 JTD (932B2)	Diesel	77	05/00 → 10/00
-----------------	--------	----	---------------

2.4 JTD (932B1)	Diesel	100	05/00 → 09/03
-----------------	--------	-----	---------------

2.4 JTD (932B1B_)	Diesel	103	10/00 → 12/01
-------------------	--------	-----	---------------

APS31

ALFA ROMEO
156 Sportwagon (932)

1.9 JTD (932B2)	Diesel	77	05/00 → 10/00
2.4 JTD (932B1)	Diesel	100	05/00 → 09/03

2.4 JTD (932B1B_)	Diesel	103	10/00 → 12/01
-------------------	--------	-----	---------------

166 (936)

2.4 JTD	Diesel	110	04/02 → 06/07
---------	--------	-----	---------------

2.4 JTD (936A2A_)	Diesel	100	09/98 → 10/00
-------------------	--------	-----	---------------

2.4 JTD (936A2B_)	Diesel	103	10/00 → 06/07
-------------------	--------	-----	---------------

FIAT
BRAVA (182)

1.9 JTD	Diesel	74	09/00 → 10/01
---------	--------	----	---------------

1.9 JTD 105	Diesel	77	12/98 → 10/01
-------------	--------	----	---------------

BRAVO I (182)

1.9 JTD	Diesel	74	09/00 → 10/01
---------	--------	----	---------------

1.9 JTD 105	Diesel	77	12/98 → 10/01
-------------	--------	----	---------------

MAREA (185)

1.9 JTD 105	Diesel	77	04/99 → 01/01
-------------	--------	----	---------------

1.9 JTD 110	Diesel	81	01/01 → 07/01
-------------	--------	----	---------------

2.4 JTD 130	Diesel	96	04/99 → 05/02
-------------	--------	----	---------------

MAREA Weekend (185)

1.9 JTD 105	Diesel	77	04/99 → 05/02
-------------	--------	----	---------------

1.9 JTD 110	Diesel	81	01/01 → 07/01
-------------	--------	----	---------------

2.4 JTD 130	Diesel	96	04/99 → 05/02
-------------	--------	----	---------------

MULTIPLA (186)

1.9 JTD 110	Diesel	81	03/01 → 07/01
-------------	--------	----	---------------

PUNTO (188)

1.9 JTD 80 (188.237, .257, .337, .357)	Diesel	59	09/99 → 07/01
--	--------	----	---------------

PUNTO Van (188AX)

1.9 JTD	Diesel	63	02/00 → 07/01
---------	--------	----	---------------

LANCIA
KAPPA (838A)

2.4 JTD (838AL1AA)	Diesel	100	06/98 → 12/00
--------------------	--------	-----	---------------

KAPPA SW (838B)

2.4 JTD (838BL1AA)	Diesel	100	06/98 → 12/00
--------------------	--------	-----	---------------

APS31

LANCIA
LYBRA (839AX)

1.9 JTD (839AXD1A)	Diesel	77	10/99 → 09/00
--------------------	--------	----	---------------

2.4 JTD (839AXE1A)	Diesel	99	10/99 → 02/01
--------------------	--------	----	---------------

LYBRA SW (839BX)

1.9 JTD (839BXD1A)	Diesel	77	10/99 → 09/00
--------------------	--------	----	---------------

2.4 JTD (839BXE1A)	Diesel	99	10/99 → 09/00
--------------------	--------	----	---------------

2.4 JTD (839BXL1A)	Diesel	103	09/00 → 05/02
--------------------	--------	-----	---------------

VOLVO
C70 I Cabriolet

2.0 T	Petrol	120	03/00 → 10/05
-------	--------	-----	---------------

2.0 T	Petrol	166	03/98 → 10/05
-------	--------	-----	---------------

2.5 T	Petrol	142	01/99 → 10/05
-------	--------	-----	---------------

C70 I Coupé

2.0 T	Petrol	120	03/00 → 09/02
-------	--------	-----	---------------

2.5 T	Petrol	142	01/99 → 09/02
-------	--------	-----	---------------

S40 I (VS)

1.9 T4	Petrol	147	05/97 → 07/00
--------	--------	-----	---------------

2.0 T	Petrol	118	10/97 → 12/03
-------	--------	-----	---------------

2.0 T	Petrol	120	06/01 → 12/03
-------	--------	-----	---------------

2.0 T	Petrol	121	07/00 → 06/01
-------	--------	-----	---------------

2.0 T4	Petrol	147	07/00 → 12/03
--------	--------	-----	---------------

S60 I

2.4 T	Petrol	147	11/00 → 12/02
-------	--------	-----	---------------

2.4 T AWD	Petrol	147	11/01 → 12/02
-----------	--------	-----	---------------

2.5 T	Petrol	154	02/04 → 04/10
-------	--------	-----	---------------

2.5 T AWD	Petrol	154	04/04 → 04/10
-----------	--------	-----	---------------

T5	Petrol	184	11/00 → 12/02
----	--------	-----	---------------

S80 I (TS, XY)

2.0	Petrol	120	06/98 → 12/02
-----	--------	-----	---------------

2.0 T	Petrol	132	12/99 → 07/02
-------	--------	-----	---------------

2.0 T	Petrol	166	06/98 → 12/02
-------	--------	-----	---------------

2.4 T	Petrol	147	06/00 → 07/02
-------	--------	-----	---------------

2.8 T6	Petrol	200	05/98 → 12/02
--------	--------	-----	---------------

3.0 T6	Petrol	200	06/01 → 12/02
--------	--------	-----	---------------

V40 Station wagon (VW)

1.9 T4	Petrol	147	05/97 → 07/00
--------	--------	-----	---------------

2.0 T	Petrol	118	10/97 → 07/00
-------	--------	-----	---------------

2.0 T	Petrol	120	06/01 → 04/04
-------	--------	-----	---------------

2.0 T	Petrol	121	07/99 → 06/04
-------	--------	-----	---------------

2.0 T4	Petrol	147	07/00 → 04/04
--------	--------	-----	---------------

APS31



VOLVO

V70 II (SW)

2.4 T	Petrol	147	03/00 → 07/02
2.4 T AWD	Petrol	147	09/01 → 07/02

XC70 CROSS COUNTRY

2.4 T XC AWD	Petrol	147	03/00 → 09/02
2.5 T XC AWD	Petrol	154	09/02 → 12/02

APS32

**SENSORE PRESSIONE ASSOLUTA
MAP SENSOR**



BMW

3 (E46)

318 d	Diesel	85	03/03 → 02/05
320 d	Diesel	110	09/01 → 02/05
330 d	Diesel	150	03/03 → 02/05
330 xd	Diesel	150	03/03 → 02/05

3 (E90)

320 d	Diesel	120	01/05 → 12/11
-------	--------	-----	---------------

3 Cabriolet (E46)

320 Cd	Diesel	110	02/05 →
330 Cd	Diesel	150	08/05 →
318 td	Diesel	85	03/03 → 02/05

3 Compact (E46)

320 td	Diesel	110	09/01 → 02/05
--------	--------	-----	---------------

3 Coupé (E46)

320 Cd	Diesel	110	11/03 →
330 Cd	Diesel	150	03/03 →

3 Touring (E46)

318 d	Diesel	85	03/03 → 02/05
320 d	Diesel	110	09/01 → 02/05
330 d	Diesel	150	03/03 → 02/05
330 xd	Diesel	150	03/03 → 02/05

3 Touring (E91)

320 d	Diesel	120	09/05 →
-------	--------	-----	---------

APS32



BMW

5 (E60)

530 d	Diesel	160	07/03 → 03/10
-------	--------	-----	---------------

5 Touring (E61)

530 d	Diesel	160	06/04 →
-------	--------	-----	---------

7 (E65, E66, E67)

730 d	Diesel	160	10/02 →
740 d	Diesel	190	10/02 →

X3 (E83)

2.0 D	Diesel	110	10/04 →
-------	--------	-----	---------

X5 (E53)

3.0 d	Diesel	160	12/03 →
-------	--------	-----	---------

APS33

**SENSORE PRESSIONE ASSOLUTA
MAP SENSOR**



MERCEDES-BENZ

CLASSE A (W168)

A 140 (168.031, 168.131)	Petrol	60	01/01 → 08/04
A 140 (168.031, 168.131)	Petrol	60	07/97 → 08/04
A 160 (168.033, 168.133)	Petrol	75	07/97 → 08/04
A 190 (168.032, 168.132)	Petrol	92	03/99 → 08/04
A 210 (168.035, 168.135)	Petrol	103	03/02 → 08/04

CLASSE C (W202)

C 280 (202.029)	Petrol	145	06/97 → 05/00
C 43 AMG (202.033)	Petrol	225	08/97 → 05/00

APS33

MERCEDES-BENZ
CLASSE C (W203)

C 240 (203.061)	Petrol	125	05/00 → 02/07	
C 240 4-matic (203.081)	Petrol	125	07/02 → 02/07	
C 320 (203.064)	Petrol	160	05/00 → 02/07	
C 320 4-matic (203.084)	Petrol	160	07/02 → 02/07	

CLASSE C Sportcoupe (CL203)

C 320 (203.764)	Petrol	160	09/02 → 05/08	
-----------------	--------	-----	---------------	--

CLASSE C Station wagon (S202)

C 240 T (202.088)	Petrol	125	09/00 → 03/01	
C 280 T (202.089)	Petrol	145	06/97 → 03/01	
C 43 AMG (202.093)	Petrol	225	08/97 → 03/01	

CLASSE C T-Model (S203)

C 240 (203.261)	Petrol	125	03/01 → 08/07	
C 240 4-matic (203.281)	Petrol	125	07/02 → 08/07	
C 320 (203.264, 203.764)	Petrol	160	03/01 → 08/07	
C 320 4-matic (203.284)	Petrol	160	07/02 → 08/07	

CLASSE E (W210)

E 240 (210.062)	Petrol	125	08/00 → 03/02	
E 430 (210.070)	Petrol	205	01/01 → 03/02	
E 430 4-matic (210.083)	Petrol	205	01/01 → 03/02	
E 55 AMG (210.074)	Petrol	260	01/01 → 03/02	
E 55 AMG 4-matic (210.074)	Petrol	260	03/01 → 03/02	

CLASSE E (W211)

E 240 (211.061)	Petrol	130	03/02 → 12/08	
E 240 4-matic (211.080)	Petrol	130	03/03 → 12/08	
E 320 (211.065)	Petrol	165	03/02 → 12/08	
E 320 4-matic (211.082)	Petrol	165	03/03 → 12/08	
E 400 CDI (211.028)	Diesel	191	02/03 → 12/08	ENGINE: 40004860 →
E 500 (211.070)	Petrol	225	03/02 → 12/08	
E 55 AMG Kompressor (211.076)	Petrol	350	10/02 → 12/08	

APS33

MERCEDES-BENZ
CLASSE E Station wagon (S210)

E 240 T (210.262)	Petrol	125	08/00 → 03/03	
E 430 T (210.270)	Petrol	205	01/01 → 03/03	
E 430 T 4-matic (210.283)	Petrol	205	01/01 → 03/03	
E 55 T AMG (210.274)	Petrol	260	01/01 → 03/03	
E 55 T AMG 4-matic (210.283)	Petrol	260	03/01 → 03/03	

CLASSE E T-Model (S211)

E 240 T (211.261)	Petrol	130	03/03 → 07/09	
E 240 T 4-matic (211.280)	Petrol	130	07/03 → 07/09	
E 320 T (211.265)	Petrol	165	03/03 → 07/09	
E 320 T 4-matic (211.282)	Petrol	165	07/03 → 07/09	
E 500 T (211.270)	Petrol	225	10/03 → 07/09	
E 55 T AMG Kompressor (211.276)	Petrol	350	07/03 → 07/09	

CLASSE G (W463)

G 320 (463.232, 463.233, 463.244, 463.245)	Petrol	158	07/97 →	
G 400 CDI (463.332, 463.333)	Diesel	184	12/00 →	ENGINE: 40004860 →
G 500 (463.247, 463.248, 463.249, 463.240, 463.421)	Petrol	218	04/98 →	
G 55 AMG (463.243, 463.246)	Petrol	260	01/01 →	

CLASSE G Cabrio (W463)

G 320 (463.209)	Petrol	158	11/97 →	
G 400 CDI (463.309)	Diesel	184	12/00 →	ENGINE: 40004860 →
G 500 (463)	Petrol	218	04/98 →	

CLASSE M (W163)

ML 320 (163.154)	Petrol	160	01/01 → 08/02	
ML 350	Petrol	173	02/03 → 06/05	
ML 350 (163.157)	Petrol	180	08/02 → 06/05	
ML 400 CDI (163.128)	Diesel	184	09/01 → 06/05	ENGINE: 40004860 →

APS33



MERCEDES-BENZ

CLASSE M (W163)

ML 430 (163.172) Petrol 200 01/01 → 06/05

ML 500 (163.175) Petrol 215 09/01 → 06/05

CLASSE S (W220)

S 280 (220.063, 220.163) Petrol 150 01/01 → 08/05

S 320 (220.065, 220.165) Petrol 165 01/01 → 08/05

S 350 (220.067, 220.167) Petrol 180 09/02 → 08/05

S 350 4-matic (220.087, 220.187) Petrol 180 06/03 → 08/05

S 400 CDI (220.028, 220.128) Diesel 184 06/00 → 08/05 ENGINE: 40004860 →

S 400 CDI (220.028, 220.128) Diesel 191 06/03 → 08/05 ENGINE: 40004860 →

S 430 (220.070, 220.170) Petrol 205 01/01 → 08/05

S 430 4-matic (220.083, 220.183) Petrol 205 09/02 → 08/05

S 500 (220.075, 220.175, 220.875) Petrol 225 01/01 → 08/05

S 500 4-matic (220.084, 220.184) Petrol 225 09/02 → 08/05

S 55 AMG (220.073, 220.173) Petrol 265 01/01 → 08/05

S 55 AMG Kompressor (220.074, 220.174) Petrol 368 06/02 → 08/05

S 600 (220.878, 220.178) Petrol 270 01/00 → 08/05

CLASSE S Coupé (C215)

CL 500 (215.375) Petrol 225 03/99 → 03/06

CL 55 AMG (215.373) Petrol 265 10/99 → 03/06

CL 600 (215.378) Petrol 270 03/99 → 03/06

APS33



MERCEDES-BENZ

CLK (C208)

320 (208.365) Petrol 160 06/97 → 06/02

430 (208.370) Petrol 205 07/98 → 06/02

55 AMG (208.374) Petrol 255 08/99 → 06/02

240 (209.361) Petrol 125 06/02 → 05/09

CLK (C209)

320 (209.365) Petrol 160 06/02 → 05/09

500 (209.375) Petrol 225 06/02 → 05/09

CLK (C209)

55 AMG (209.376) Petrol 270 09/02 → 05/09

CLK Cabriolet (A208)

320 (208.465) Petrol 160 03/98 → 03/02

430 (208.470) Petrol 205 09/98 → 03/02

CLK Cabriolet (A209)

CLK 240 (209.461) Petrol 125 02/03 → 03/10

CLK 320 (209.465) Petrol 160 02/03 → 03/10

CLK 500 (209.475) Petrol 225 02/03 → 03/10

CLK 55 AMG (209.476) Petrol 270 02/03 → 03/10

SL (R230)

350 (230.467) Petrol 180 03/03 → 01/12

500 (230.475) Petrol 225 10/01 → 01/12

SLK (R170)

320 (170.465) Petrol 160 03/00 → 04/04

VANEO (414)

1.6 (414.700) Petrol 60 02/02 → 07/05

1.6 (414.700) Petrol 75 02/02 → 07/05

1.9 (414.700) Petrol 92 02/02 → 07/05

APS34
**SENSORE PRESSIONE ASSOLUTA
MAP SENSOR**

KW

NISSAN
INTERSTAR Autobus (X70)

dCi 80	Diesel	60	07/02 → 11/02
--------	--------	----	---------------

INTERSTAR Furgonato (X70)

dCi 80	Diesel	60	07/02 → 11/02
--------	--------	----	---------------

PRIMASTAR Autobus (X83)

dCi 100	Diesel	74	03/01 → 01/02
---------	--------	----	---------------

dCi 80	Diesel	60	03/01 → 01/02
--------	--------	----	---------------

RENAULT
CLIO II (BB0/1/2_, CB0/1/2_)

1.5 dCi (B/CB07)	Diesel	48	06/01 → 10/02
------------------	--------	----	---------------

1.5 dCi (B/CB08)	Diesel	60	06/01 → 10/02
------------------	--------	----	---------------

CLIO II Furgonato (SB0/1/2_)

1.5 dCi (SB07)	Diesel	48	06/01 → 10/02
----------------	--------	----	---------------

KANGOO (KC0/1_)

1.5 dCi (KC07)	Diesel	48	12/01 → 10/02
----------------	--------	----	---------------

1.5 dCi (KC08, KC09)	Diesel	60	07/02 → 10/02
----------------------	--------	----	---------------

KANGOO Express (FC0/1_)

1.5 dCi (FC07, FC1R)	Diesel	48	12/01 → 10/02
----------------------	--------	----	---------------

THALIA I (LB0/1/2_)

1.5 dCi	Diesel	48	04/02 → 10/02
---------	--------	----	---------------

1.5 dCi	Diesel	60	06/01 → 10/02
---------	--------	----	---------------

APS35
**SENSORE PRESSIONE ASSOLUTA
MAP SENSOR**

KW

CITROËN
C5 I (DC_)

2.0 HDi (DCRHYB)	Diesel	66	03/01 → 08/04
------------------	--------	----	---------------

2.0 HDi (DCRHZB, DCRHZE)	Diesel	80	03/01 → 08/04
--------------------------	--------	----	---------------

2.2 HDi (DC4HXB, DC4HXE)	Diesel	98	03/01 → 08/04
--------------------------	--------	----	---------------

C5 I Break (DE_)

2.0 HDi (DERHSB, DERHSE)	Diesel	79	06/01 → 08/04
--------------------------	--------	----	---------------

2.0 HDi (DERHYB)	Diesel	66	06/01 → 08/04
------------------	--------	----	---------------

2.2 HDi (DE4HXB, DE4HXE)	Diesel	98	06/01 → 08/04
--------------------------	--------	----	---------------

C8 (EA_, EB_)

2.0 HDi	Diesel	79	07/02 → 06/03
---------	--------	----	---------------

2.2 HDi	Diesel	94	07/02 → 06/03
---------	--------	----	---------------

EVASION (22, U6)

2.0 HDi	Diesel	80	08/99 → 07/02
---------	--------	----	---------------

JUMPY (U6U)

2.0 HDi 110	Diesel	80	06/00 → 06/03
-------------	--------	----	---------------

2.0 HDi 95	Diesel	69	10/99 → 06/03
------------	--------	----	---------------

JUMPY Furgonato (BS_, BT_, BY_, BZ_)

2.0 HDi 110	Diesel	80	01/02 →
-------------	--------	----	---------

2.0 HDi 95	Diesel	69	10/99 → 06/03
------------	--------	----	---------------

JUMPY Pianale piatto/Telaio (BU_, BV_, BW_, BX_)

2.0 HDi 95	Diesel	69	10/99 → 06/03
------------	--------	----	---------------

XANTIA (X2)

2.0 HDi 109	Diesel	80	02/99 → 04/03
-------------	--------	----	---------------

2.0 HDi 90	Diesel	66	03/99 → 04/03
------------	--------	----	---------------

APS35



CITROËN

XANTIA Break (X2)

2.0 HDI 109	Diesel	80	02/99 → 04/03
2.0 HDI 90	Diesel	66	03/99 → 04/03

XSARA (N1)

2.0 HDI 109	Diesel	80	05/01 → 03/05
2.0 HDI 90	Diesel	66	02/99 → 03/05

XSARA Break (N2)

2.0 HDI 109	Diesel	80	05/01 → 08/05
2.0 HDI 90	Diesel	66	02/99 → 08/05

XSARA Coupé (N0)

2.0 HDI 109	Diesel	80	05/01 → 03/05
2.0 HDI 90	Diesel	66	02/99 → 03/05

XSARA PICASSO (N68)

2.0 HDi	Diesel	66	12/99 →
---------	--------	----	---------

FIAT

SCUDO Combinato (220P)

2.0 JTD	Diesel	80	12/99 → 12/06
---------	--------	----	---------------

SCUDO Furgonato (220L)

2.0 JTD	Diesel	69	12/99 → 12/06
2.0 JTD	Diesel	80	12/02 → 12/06

ULYSSE (179AX)

2.0 JTD	Diesel	80	08/02 → 08/06
2.2 JTD	Diesel	94	08/02 → 06/03

ULYSSE (220)

2.0 JTD	Diesel	80	10/99 → 08/02
---------	--------	----	---------------

LANCIA

PHEDRA (179)

2.0 JTD (179AXB1A)	Diesel	80	09/02 → 11/10
--------------------	--------	----	---------------

2.2 JTD (179AXC1A)	Diesel	94	09/02 → 06/03
--------------------	--------	----	---------------

ZETA (220)

2.0 JTD (220AN5)	Diesel	80	09/99 → 09/02
------------------	--------	----	---------------

PEUGEOT

406 (8B)

2.0 HDi 110	Diesel	80	06/98 → 08/01
-------------	--------	----	---------------

406 (8B)

2.2 HDi	Diesel	98	03/00 → 05/04
---------	--------	----	---------------

406 Break (8E/F)

2.0 HDi 110	Diesel	80	02/99 → 04/04
2.2 HDi	Diesel	98	03/00 → 10/04

406 Coupé (8C)

2.2 HDi	Diesel	98	03/00 → 12/04
---------	--------	----	---------------

APS35



PEUGEOT

607 (9D, 9U)

2.0 HDi	Diesel	80	05/00 → 11/04
2.2 HDi	Diesel	98	02/00 → 11/04

806 (221)

2.0 HDi	Diesel	80	08/99 → 08/02
2.0 HDi 16V	Diesel	80	08/99 → 08/02

807 (E)

2.0 HDi	Diesel	79	06/02 →
2.2 HDi	Diesel	94	06/02 →

EXPERT (224)

2.0 HDi	Diesel	80	07/00 →
2.0 HDi 16V	Diesel	80	07/00 →

EXPERT Furgonato (222)

2.0 HDi	Diesel	69	07/00 →
2.0 HDi	Diesel	80	07/00 →
2.0 HDi	Diesel	80	07/00 →

APS36

**SENSORE PRESSIONE ASSOLUTA
MAP SENSOR**

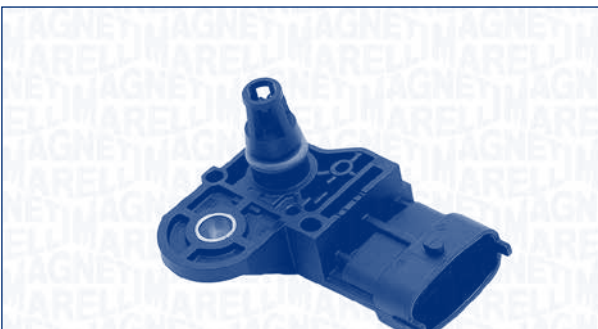

ALFA ROMEO

147 (937)

1.9 JTD 16V	Diesel	100	10/04 → 03/10
1.9 JTDM	Diesel	85	10/04 → 03/10
1.9 JTDM 16V	Diesel	110	09/04 → 03/10
1.9 JTDM 8V	Diesel	88	07/05 → 03/10

159 (939)

1.9 JTDM 16V	Diesel	110	09/05 → 11/11
1.9 JTDM 16V	Diesel	100	09/05 → 11/11
1.9 JTDM 8V	Diesel	88	09/05 → 11/11
2.0 JTDM	Diesel	100	06/10 → 11/11
2.0 JTDM	Diesel	125	05/09 → 11/11
2.4 JTDM	Diesel	147	09/05 → 11/11
2.4 JTDM	Diesel	154	05/07 → 11/11

APS36

ALFA ROMEO
159 (939)

2.4 JTDM Q4	Diesel	154	05/07 → 11/11
-------------	--------	-----	---------------

159 Sportwagon (939)

1.9 JTDM 16V	Diesel	110	03/06 → 11/11
--------------	--------	-----	---------------

1.9 JTDM 16V	Diesel	100	03/06 → 11/11
--------------	--------	-----	---------------

1.9 JTDM 8V	Diesel	88	03/06 → 11/11
-------------	--------	----	---------------

2.0 JTDM	Diesel	100	06/10 → 11/11
----------	--------	-----	---------------

2.0 JTDM	Diesel	125	05/09 → 11/11
----------	--------	-----	---------------

2.4 JTDM	Diesel	147	03/06 → 11/11
----------	--------	-----	---------------

2.4 JTDM	Diesel	154	05/07 → 11/11
----------	--------	-----	---------------

2.4 JTDM Q4	Diesel	154	05/07 → 11/11
-------------	--------	-----	---------------

166 (936)

2.4 JTD	Diesel	129	10/03 → 06/07
---------	--------	-----	---------------

2.4 JTD	Diesel	132	07/06 → 06/07
---------	--------	-----	---------------

2.4 JTD	Diesel	136	07/05 → 06/07
---------	--------	-----	---------------

BRERA

2.4 JTDM 20V	Diesel	147	01/06 →
--------------	--------	-----	---------

2.4 JTDM 20V	Diesel	154	05/07 →
--------------	--------	-----	---------

GIULIETTA (940)

2.0 JTDM	Diesel	103	04/10 →
----------	--------	-----	---------

GT (937)

1.9 JTD	Diesel	110	11/03 → 09/10
---------	--------	-----	---------------

1.9 JTD	Diesel	125	05/08 → 09/10
---------	--------	-----	---------------

MITO (955)

1.3 JTDM	Diesel	66	09/08 →
----------	--------	----	---------

1.3 JTDM	Diesel	70	10/09 →
----------	--------	----	---------

1.6 JTDM	Diesel	88	09/08 →
----------	--------	----	---------

SPIDER (939)

2.0 JTDM	Diesel	125	05/09 →
----------	--------	-----	---------

FIAT
500 (312)

0.9	Petrol	63	07/10 →
-----	--------	----	---------

1.3 D Multijet	Diesel	70	12/09 →
----------------	--------	----	---------

500 C (312)

0.9	Petrol	63	09/09 →
-----	--------	----	---------

BRAVO II (198)

1.6 D Multijet	Diesel	77	03/08 →
----------------	--------	----	---------

1.6 D Multijet	Diesel	88	03/08 →
----------------	--------	----	---------

1.6 D Multijet	Diesel	85	11/08 →
----------------	--------	----	---------

1.9 D Multijet	Diesel	110	04/07 →
----------------	--------	-----	---------

1.9 D Multijet	Diesel	88	04/07 →
----------------	--------	----	---------

2.0 D Multijet	Diesel	121	09/08 →
----------------	--------	-----	---------

2.0 D Multijet	Diesel	120	09/08 →
----------------	--------	-----	---------

BRAVO Van (198)

1.6 Multijet	Diesel	77	03/08 →
--------------	--------	----	---------

APS36

FIAT
CROMA (194)

1.9 D Multijet	Diesel	110	06/05 →
----------------	--------	-----	---------

1.9 D Multijet	Diesel	85	06/05 →
----------------	--------	----	---------

1.9 D Multijet	Diesel	88	06/05 →
----------------	--------	----	---------

1.9 D Multijet	Diesel	100	12/05 →
----------------	--------	-----	---------

2.4 D Multijet	Diesel	147	06/05 →
----------------	--------	-----	---------

DOBLO (119)

1.3 D Multijet	Diesel	62	10/05 →
----------------	--------	----	---------

1.9 D Multijet	Diesel	88	10/05 →
----------------	--------	----	---------

DOBLO Cargo (223)

1.3 JTD 16V Multijet	Diesel	62	08/06 →
----------------------	--------	----	---------

1.9 JTD Multijet	Diesel	88	12/06 →
------------------	--------	----	---------

DOBLO Cassone / Furgonato / Promiscuo (263)

1.3 D Multijet	Diesel	66	02/10 →
----------------	--------	----	---------

1.6 D Multijet	Diesel	77	02/10 →
----------------	--------	----	---------

DOBLO Combi (152, 263)

1.3 D Multijet	Diesel	66	02/10 →
----------------	--------	----	---------

1.6 D Multijet	Diesel	66	02/10 →
----------------	--------	----	---------

DOBLO Pianale piatto/Telaio (263)

1.3 D Multijet	Diesel	66	02/10 →
----------------	--------	----	---------

1.6 D Multijet	Diesel	66	02/10 →
----------------	--------	----	---------

1.6 D Multijet	Diesel	77	02/10 →
----------------	--------	----	---------

2.0 D Multijet	Diesel	99	02/10 →
----------------	--------	----	---------

DUCATO Autobus (250)

115 Multijet 2,0 D	Diesel	85	06/11 →
--------------------	--------	----	---------

DUCATO Furgonato (250)

115 Multijet 2,0 D	Diesel	85	06/11 →
--------------------	--------	----	---------

DUCATO Pianale piatto/Telaio (250)

115 Multijet 2,0 D	Diesel	85	06/11 →
--------------------	--------	----	---------

FIORINO Cassone / Furgonato / Promiscuo (225)

1.3 D Multijet	Diesel	55	11/07 →
----------------	--------	----	---------

1.3 D Multijet	Diesel	70	07/09 →
----------------	--------	----	---------

FREEMONT (JF_, JC)

2.0 JTD	Diesel	100	08/11 →
---------	--------	-----	---------

2.0 JTD	Diesel	103	08/11 →
---------	--------	-----	---------

2.0 JTD	Diesel	120	08/11 →
---------	--------	-----	---------

2.0 JTD	Diesel	125	08/11 →
---------	--------	-----	---------

2.0 JTD 4x4	Diesel	120	08/11 →
-------------	--------	-----	---------

2.0 JTD 4x4	Diesel	125	08/11 →
-------------	--------	-----	---------

APS36



FIAT

IDEA

1.6 D Multijet	Diesel	88	05/08 →
1.9 JTD	Diesel	74	01/04 →

LINEA (323)

1.3 D Multijet	Diesel	66	06/07 →
1.6 D Multijet	Diesel	77	06/09 →

MULTIPLA (186)

1.9 JTD (186AXE1A)	Diesel	88	04/02 → 06/10
--------------------	--------	----	---------------

PANDA (312)

0.9	Petrol	57	02/12 →
0.9	Petrol	63	02/12 →
1.3 D Multijet	Diesel	55	02/12 →

PUNTO / GRANDE PUNTO (199)

1.6 D Multijet	Diesel	88	07/08 →
1.9 D Multijet	Diesel	88	10/05 →
1.9 D Multijet	Diesel	96	10/05 →
1.9 D Multijet	Diesel	85	06/06 →

PUNTO EVO Furgonato (199)

1.3 D Multijet	Diesel	55	03/09 →
----------------	--------	----	---------

PUNTO Van (199)

1.3 D Multijet	Diesel	70	03/09 →
----------------	--------	----	---------

QUBO (225)

1.3 D Multijet	Diesel	55	02/08 →
1.3 D Multijet	Diesel	70	07/10 →

SEDICI

1.9 D Multijet	Diesel	88	06/06 →
1.9 D Multijet 4x4	Diesel	88	06/06 →
2.0 D Multijet	Diesel	99	06/06 →
2.0 D Multijet 4x4	Diesel	99	06/06 →

STILO (192)

1.9 D Multijet	Diesel	110	09/05 → 11/06
1.9 D Multijet	Diesel	88	09/05 → 11/06
1.9 JTD	Diesel	100	04/04 → 11/06
1.9 JTD	Diesel	103	01/04 → 11/06
1.9 JTD	Diesel	93	09/03 → 11/06
1.9 JTD (192_XE1A)	Diesel	85	10/01 → 11/06
1.9 JTD (192AXS1B, 192BXS1B)	Diesel	66	09/04 → 11/06

APS36



FIAT

STILO Multi Wagon (192)

1.9 D Multijet	Diesel	110	09/05 → 08/08
1.9 D Multijet	Diesel	88	09/05 → 08/08
1.9 JTD	Diesel	103	01/04 → 08/08

STRADA Pick-up (178E)

1.3 D Multijet	Diesel	62	05/06 →
----------------	--------	----	---------

LANCIA

DELTA III (844)

1.6 D Multijet	Diesel	88	09/08 →
2.0 D Multijet	Diesel	121	09/08 →
2.0 D Multijet	Diesel	120	09/08 →

MUSA (350)

1.3 D Multijet	Diesel	70	03/09 →
1.6 D Multijet	Diesel	85	07/08 →
1.6 D Multijet	Diesel	88	07/08 →
1.9 D Multijet	Diesel	74	10/04 →

THESIS (841AX)

2.4 D Multijet	Diesel	136	04/06 → 07/09
2.4 JTD	Diesel	129	05/03 → 07/09

YPSILON (843)

1.3 D Multijet	Diesel	77	05/07 → 12/11
----------------	--------	----	---------------

OPEL

COMBO Cassone / Furgonato / Promiscuo (X12)

1.3 CDTi	Diesel	66	02/12 →
1.6 CDTi	Diesel	66	02/12 →
1.6 CDTi	Diesel	74	02/12 →
1.6 CDTi	Diesel	77	02/12 →
2.0 CDTi	Diesel	99	02/12 →

COMBO Tour (X12)

1.6 CDTi	Diesel	66	02/12 →
1.6 CDTi	Diesel	74	02/12 →
1.6 CDTi	Diesel	77	02/12 →
2.0 CDTi	Diesel	99	02/12 →

APS37
**SENSORE PRESSIONE ASSOLUTA
MAP SENSOR**

KW

DACIA
LOGAN (LS_)

1.5 dCi (LS0J, LS0Y)	Diesel	48	09/05 →
1.5 dCi (LS0K)	Diesel	50	01/06 →
1.5 dCi (LS0W)	Diesel	63	09/07 →

LOGAN EXPRESS (FS_)

1.5 dCi (FS0K)	Diesel	50	03/09 →
1.5 dCi (FS0W)	Diesel	63	03/09 →

LOGAN MCV (KS_)

1.5 dCi (KS0K)	Diesel	50	02/07 →
1.5 dCi (KS0W)	Diesel	63	09/07 →

LOGAN Pick-up (US_)

1.5 dCi (US0K)	Diesel	50	03/08 →
1.5 dCi (US0W)	Diesel	63	03/08 →

RENAULT
CLIO II (BB0/1/2_, CB0/1/2_)

1.5 dCi (B/C2J)	Diesel	50	08/04 →
1.5 dCi (B/CB03)	Diesel	59	06/01 → 10/03
1.5 dCi (B/CB07)	Diesel	48	06/01 →
1.5 dCi (B/CB08)	Diesel	60	06/01 →
1.5 dCi (B/CB3N)	Diesel	62	02/07 →

CLIO II Furgonato (SB0/1/2_)

1.5 dCi	Diesel	59	06/01 → 10/04
1.5 dCi	Diesel	60	11/03 →
1.5 dCi (SB07)	Diesel	48	06/01 →

CLIO III (BR0/1, CR0/1)

1.5 dCi	Diesel	48	05/05 →
---------	--------	----	---------

KANGOO (KC0/1_)

1.5 dCi	Diesel	42	07/03 →
1.5 dCi	Diesel	50	06/05 →
1.5 dCi	Diesel	62	06/05 →
1.5 dCi (KC07)	Diesel	48	12/01 →
1.5 dCi (KC08, KC09)	Diesel	60	07/02 →

APS37

KW

RENAULT
KANGOO Express (FC0/1_)

1.5 dCi (FC07, FC1R)	Diesel	48	12/01 →
1.5 dCi (FC08, FC09)	Diesel	60	04/03 →
1.5 dCi (FC1E)	Diesel	50	06/05 →
1.5 dCi (FC1G)	Diesel	62	06/05 →

LOGAN (LS_)

1.5 dCi	Diesel	50	04/07 →
---------	--------	----	---------

LOGAN Station wagon (KS_)

1.5 dCi	Diesel	50	04/07 →
---------	--------	----	---------

MEGANE I Classic (LA0/1_)

1.9 dCi (LA05, LA1F)	Diesel	75	02/01 → 08/03
----------------------	--------	----	---------------

MEGANE I Grandtour (KA0/1_)

1.9 dCi (KA05, KA1F)	Diesel	75	02/01 → 08/03
----------------------	--------	----	---------------

MODUS / GRAND MODUS (F/JP0_)

1.5 dCi (FP0E, JP0E)	Diesel	48	12/04 →
----------------------	--------	----	---------

SCÉNIC I (JA0/1_)

1.9 dCi (JA05, JA1F)	Diesel	75	09/99 → 08/03
1.9 dCi RX4	Diesel	75	11/00 → 08/03

THALIA I (LB0/1/2_)

1.5 dCi	Diesel	47	06/05 →
1.5 dCi	Diesel	48	04/02 →
1.5 dCi	Diesel	50	02/03 →

TRAFIC II Autobus (JL)

1.9 dCi 100 (JLOC)	Diesel	74	03/01 →
1.9 dCi 80 (JLOB)	Diesel	60	03/01 →

TRAFIC II Furgonato (FL)

1.9 dCi 100 (FLOC)	Diesel	74	03/01 →
1.9 dCi 80 (FLOB)	Diesel	60	03/01 →

TRAFIC II Pianale piatto/Telaio (EL)

1.9 dCi 100 (ELOC)	Diesel	74	03/01 →
1.9 dCi 80 (ELOB)	Diesel	60	03/01 →

TWINGO II (CN0_)

1.5 dCi (CN0E)	Diesel	47	03/07 →
----------------	--------	----	---------

APS38

**SENSORE PRESSIONE ASSOLUTA
MAP SENSOR**



CITROËN

BERLINGO (B9)

1.6 HDi 110	Diesel	80	04/08 →	
1.6 HDi 75	Diesel	55	04/08 →	
1.6 HDi 90	Diesel	66	04/08 →	

BERLINGO (MF)

1.6 HDi 75 (MF9HW)	Diesel	55	07/05 →	
1.6 HDi 90 (MF9HX)	Diesel	66	07/05 →	

BERLINGO Furgonato (B9)

1.6 HDi 110	Diesel	80	04/08 →	
1.6 HDi 75	Diesel	55	04/08 →	
1.6 HDi 90	Diesel	66	04/08 →	

C3 I (FC_)

1.4 16V HDi	Diesel	66	02/02 →	
1.6 16V HDi	Diesel	66	10/05 →	
1.6 16V HDi	Diesel	80	09/05 →	

C4 Coupé (LA_)

1.6 HDi	Diesel	66	11/04 →	
1.6 HDi	Diesel	80	11/04 →	
2.0 HDi	Diesel	100	11/04 →	

C4 I (LC_)

1.6 HDi	Diesel	66	11/04 →	
1.6 HDi	Diesel	80	11/04 →	
2.0 HDi	Diesel	100	11/04 →	

C4 Picasso I (UD_)

1.6 HDi	Diesel	80	02/07 →	
2.0 HDi 138	Diesel	100	02/07 →	

C5 II (RC_)

1.6 HDi (RC8HZB)	Diesel	80	09/04 →	
2.0 HDi (RCRHRH)	Diesel	100	09/04 →	

APS38



CITROËN

C5 II Break (RE_)

1.6 HDi (RE8HZB)	Diesel	80	09/04 →	
2.0 HDi (RERHRH)	Diesel	100	09/04 →	

C5 III (RD_)

1.6 HDi	Diesel	80	02/08 →	
2.0 HDi	Diesel	100	02/08 →	

C5 III Break (TD_)

1.6 HDi	Diesel	80	02/08 →	
2.0 HDi	Diesel	100	02/08 →	

C8 (EA_, EB_)

2.0 HDi	Diesel	88	02/07 →	
---------	--------	----	---------	--

JUMPY

1.6 HDi 90 16V	Diesel	66	01/07 →	
2.0 HDi 120	Diesel	88	01/07 →	
2.0 HDi 140	Diesel	100	01/07 →	

JUMPY Furgonato

2.0 HDi 120	Diesel	88	01/07 →	
2.0 HDi 140	Diesel	100	01/07 →	

XSARA PICASSO (N68)

1.6 HDi	Diesel	66	09/05 →	
1.6 HDi	Diesel	80	05/04 →	

FIAT

SCUDO (270_)

1.6 D Multijet	Diesel	66	01/07 →	
2.0 D Multijet	Diesel	100	01/07 →	
2.0 D Multijet	Diesel	88	01/07 →	

SCUDO Furgonato (270_)

1.6 D Multijet	Diesel	66	01/07 →	
2.0 D Multijet	Diesel	100	01/07 →	
2.0 D Multijet	Diesel	88	01/07 →	

SCUDO Pianale piatto/Telaio (270_)

2.0 D Multijet	Diesel	100	01/07 →	
----------------	--------	-----	---------	--

FORD

C-MAX (DM2)

1.6 TDCi	Diesel	66	02/07 →	
1.6 TDCi	Diesel	80	02/07 →	
2.0 TDCi	Diesel	100	02/07 →	
2.0 TDCi	Diesel	81	02/08 →	

FIESTA VI

1.6 TDCi	Diesel	66	06/08 →	
----------	--------	----	---------	--

KUGA I

2.0 TDCi	Diesel	100	03/08 →	
2.0 TDCi 4x4	Diesel	100	03/08 →	

APS38

KW

PEUGEOT
1007 (KM_)

1.6 HDi Diesel 80 06/07 →

206 2 volumi /Coda spiovente (2A/C)

1.6 HDi 110 Diesel 80 05/04 →

206 CC (2D)

1.6 HDi 110 Diesel 80 04/05 →

206 SW (2E/K)

1.6 HDi 110 Diesel 80 05/04 →

207 CC (WD_)

1.6 HDi Diesel 80 02/07 →

207 SW (WK_)

1.6 HDi Diesel 80 06/07 →

307 (3A/C)

1.6 HDi Diesel 66 04/05 →

1.6 HDi 110 Diesel 80 02/04 →

2.0 HDi 110 Diesel 79 08/00 →

2.0 HDi 135 Diesel 100 10/03 →

2.0 HDi 90 Diesel 66 08/00 →

307 Break (3E)

1.6 HDi Diesel 66 04/05 →

1.6 HDi 110 Diesel 80 02/04 →

2.0 HDi 110 Diesel 79 03/02 →

2.0 HDi 135 Diesel 100 02/04 →

2.0 HDi 90 Diesel 66 03/02 →

307 CC (3B)

2.0 HDi 135 Diesel 100 06/05 →

307 SW (3H)

1.6 HDi 110 Diesel 80 02/04 →

2.0 HDi 110 Diesel 79 03/02 →

2.0 HDi 135 Diesel 100 02/04 →

2.0 HDi 90 Diesel 66 03/02 →

308 (4A_, 4C_)

1.6 HDi Diesel 66 09/07 →

1.6 HDi Diesel 80 09/07 →

2.0 HDi Diesel 100 09/07 →

308 SW

1.6 HDi Diesel 66 09/07 →

1.6 HDi Diesel 80 09/07 →

2.0 HDi Diesel 100 09/07 →

407 (6D_)

1.6 HDi 110 Diesel 80 05/04 →

2.0 HDi 135 Diesel 100 05/04 →

407 SW (6E_)

1.6 HDi 110 Diesel 80 05/04 →

2.0 HDi 135 Diesel 100 05/04 →

APS38

KW

PEUGEOT
607 (9D, 9U)

2.0 HDi Diesel 100 09/05 →

EXPERT Furgonato (VF3A_, VF3U_, VF3X_)

1.6 HDi 90 16V Diesel 66 01/07 →

2.0 HDi 120 Diesel 88 01/07 →

2.0 HDi 140 Diesel 100 01/07 →

EXPERT Pianale piatto/Telaio

1.6 HDi 90 Diesel 66 01/07 →

2.0 HDi 120 Diesel 88 01/07 →

2.0 HDi 140 Diesel 100 01/07 →

EXPERT Tepee (VF3V_)

1.6 HDi 90 16V Diesel 66 01/07 →

2.0 HDi 120 Diesel 88 01/07 →

2.0 HDi 140 Diesel 100 01/07 →

RANCH

1.6 HDi Diesel 55 04/08 →

1.6 HDi Diesel 66 04/08 →

1.6 HDi Diesel 80 04/08 →

RANCH Furgonato

1.6 HDi Diesel 55 04/08 →

1.6 HDi Diesel 66 04/08 →

1.6 HDi Diesel 80 04/08 →

SUZUKI
LIANA (ER)

1.4 DDiS Diesel 66 04/04 →

LIANA Station wagon (ER)

1.4 DDiS Diesel 66 04/04 → 12/07

VOLVO
C70 II Cabriolet

2.0 D Diesel 100 01/08 →

APS39

**SENSORE PRESSIONE ASSOLUTA
MAP SENSOR**



KW



AUDI

A2 (8Z0)

1.2 TDI	Diesel	45	03/01 → 01/02
1.4 TDI	Diesel	55	02/00 → 01/02

A3 (8L1)

1.8 T	Petrol	132	05/00 → 05/03
1.8 T quattro	Petrol	110	08/97 → 05/03
1.8 T quattro	Petrol	132	09/00 → 05/03
1.9 TDI	Diesel	74	10/00 → 05/03
S3 quattro	Petrol	154	03/99 → 02/01

A4 (8D2, B5)

1.8 T	Petrol	110	08/98 → 11/00
1.8 T quattro	Petrol	110	02/99 → 11/00
1.9 TDI	Diesel	55	08/97 → 06/00
1.9 TDI	Diesel	66	04/97 → 07/98
1.9 TDI	Diesel	81	08/97 → 06/00
1.9 TDI	Diesel	85	03/00 → 11/00
1.9 TDI quattro	Diesel	85	03/00 → 11/00
2.5 TDI	Diesel	110	09/97 → 11/00
2.5 TDI quattro	Diesel	110	09/97 → 11/00

A4 Avant (8D5, B5)

1.8 T	Petrol	110	08/98 → 09/01
1.8 T quattro	Petrol	110	02/99 → 09/01
1.9 TDI	Diesel	55	08/97 → 09/01
1.9 TDI	Diesel	66	08/97 → 12/98
1.9 TDI	Diesel	81	08/97 → 06/00
1.9 TDI	Diesel	85	03/00 → 09/01
1.9 TDI quattro	Diesel	85	03/00 → 09/01
2.5 TDI	Diesel	110	09/97 → 09/01
2.5 TDI quattro	Diesel	110	09/97 → 06/00
RS4 quattro	Petrol	280	05/00 → 09/01

A6 (4B2, C5)

1.8 T	Petrol	132	12/97 → 10/00
1.8 T quattro	Petrol	110	02/97 → 05/04
1.8 T quattro	Petrol	132	12/97 → 10/00

APS39



KW



AUDI

A6 (4B2, C5)

1.9 TDI	Diesel	81	04/97 → 09/00
1.9 TDI	Diesel	85	07/00 → 04/01
RS6 quattro	Petrol	331	07/02 → 04/04

A6 Avant (4B5, C5)

1.8 T	Petrol	110	12/97 → 04/01
1.8 T	Petrol	132	04/99 → 10/00
1.8 T quattro	Petrol	110	12/97 → 01/05
1.8 T quattro	Petrol	132	12/97 → 10/00
1.9 TDI	Diesel	81	02/98 → 03/01
1.9 TDI	Diesel	85	07/00 → 04/01
RS6 plus quattro	Petrol	353	04/04 → 09/04
RS6 quattro	Petrol	331	07/02 → 04/04

TT (8N3)

1.8 T	Petrol	110	09/02 → 06/06
1.8 T	Petrol	132	10/98 → 06/06
1.8 T quattro	Petrol	132	10/98 → 05/05
1.8 T quattro	Petrol	165	10/98 → 01/01

TT Roadster (8N9)

1.8 T	Petrol	110	01/01 → 06/06
1.8 T	Petrol	132	10/99 → 06/06
1.8 T quattro	Petrol	132	02/00 → 06/06
1.8 T quattro	Petrol	165	10/99 → 01/01

FORD

GALAXY (WGR)

1.9 TDI	Diesel	66	03/95 → 04/01
1.9 TDI	Diesel	85	04/00 → 04/01

SEAT

ALHAMBRA (7V8, 7V9)

1.8 T 20V	Petrol	110	06/00 → 08/01
1.9 TDI	Diesel	85	06/00 → 06/01
1.9 TDI 4motion	Diesel	85	06/00 → 06/01

AROSA (6H)

1.4 TDI	Diesel	55	01/00 → 06/04
---------	--------	----	---------------

CORDOBA (6K2)

1.9 TDI	Diesel	66	06/99 → 10/02
1.9 TDI	Diesel	81	06/99 → 10/02

CORDOBA Vario (6K5)

1.9 TDI	Diesel	66	06/99 → 08/02
1.9 TDI	Diesel	81	06/99 → 08/02

IBIZA III (6K1)

1.9 TDI	Diesel	66	08/99 → 02/02
1.9 TDI	Diesel	81	08/99 → 02/02

LEON (1M1)

1.8 20V T	Petrol	132	11/99 → 02/03
-----------	--------	-----	---------------

APS39

SEAT
LEON (1M1)

1.8 20V T 4	Petrol	132	11/99 → 02/03
1.9 TDI	Diesel	66	11/99 → 02/03
1.9 TDI	Diesel	81	11/99 → 02/03

TOLEDO II (1M2)

1.8 20VT	Petrol	132	05/01 → 05/02
1.9 TDI	Diesel	66	04/99 → 02/03
1.9 TDI	Diesel	81	04/99 → 02/03

SKODA
FABIA (6Y2)

1.9 TDI	Diesel	74	01/00 → 04/04
---------	--------	----	---------------

FABIA Combi (6Y5)

1.9 TDI	Diesel	74	04/00 → 04/04
---------	--------	----	---------------

FABIA Tre volumi (6Y3)

1.9 TDI	Diesel	74	01/00 → 04/04
---------	--------	----	---------------

OCTAVIA (1U2)

1.8 T	Petrol	110	03/98 → 01/03
1.8 T 4x4	Petrol	110	05/01 → 01/03
1.9 TDI	Diesel	81	08/97 → 02/03
RS 1.8 T	Petrol	132	05/01 → 01/03

OCTAVIA Combi (1U5)

1.8 T	Petrol	110	07/98 → 01/03
1.8 T 4x4	Petrol	110	05/01 → 01/03
1.9 TDI	Diesel	66	07/98 → 02/03
1.9 TDI	Diesel	81	07/98 → 02/03
1.9 Tdi 4x4	Diesel	66	11/99 → 02/06
1.9 Tdi 4x4	Diesel	74	09/00 → 02/03
RS 1.8 T	Petrol	132	08/02 → 01/03

SUPERB (3U4)

1.8 T	Petrol	110	12/01 → 12/02
2.5 TDI	Diesel	114	12/01 → 07/03

VOLKSWAGEN
BORA (1J2)

1.8 T	Petrol	110	05/00 → 03/03
1.8 T	Petrol	132	03/02 → 03/03
1.9 TDI	Diesel	96	11/00 → 05/05
1.9 TDI	Diesel	66	10/98 → 06/01
1.9 TDI	Diesel	74	09/00 → 03/03
1.9 TDI	Diesel	81	10/98 → 06/01
1.9 TDI	Diesel	85	12/98 → 01/02
1.9 TDI 4motion	Diesel	96	11/00 → 05/05
1.9 TDI 4motion	Diesel	66	02/99 → 06/01
1.9 TDI 4motion	Diesel	74	09/00 → 03/03
1.9 TDI 4motion	Diesel	85	02/99 → 06/01

APS39

VOLKSWAGEN
BORA Station wagon (1J6)

1.8 T	Petrol	110	05/00 → 03/03
1.8 T	Petrol	132	05/02 → 03/03
1.9 TDI	Diesel	96	11/00 → 05/05
1.9 TDI	Diesel	66	07/04 → 05/05
1.9 TDI	Diesel	74	09/00 → 03/03
1.9 TDI	Diesel	81	05/99 → 06/01
1.9 TDI	Diesel	85	05/99 → 06/01
1.9 TDI 4motion	Diesel	96	11/00 → 05/05
1.9 TDI 4motion	Diesel	74	09/00 → 03/03
1.9 TDI 4motion	Diesel	85	05/99 → 06/01

CADDY II Station wagon (9K9B)

1.9 TDI	Diesel	66	09/00 → 06/03
---------	--------	----	---------------

FOX (5Z1, 5Z3)

1.4 TDI	Diesel	51	04/05 →
---------	--------	----	---------

GOLF IV (1J1)

1.8 T	Petrol	110	08/97 → 05/03
1.8 T GTI	Petrol	132	08/01 → 05/04
1.9 TDI	Diesel	110	09/00 → 05/04
1.9 TDI	Diesel	66	10/97 → 05/04
1.9 TDI	Diesel	74	09/00 → 11/02
1.9 TDI	Diesel	81	08/97 → 11/02
1.9 TDI	Diesel	85	05/99 → 06/01
1.9 TDI	Diesel	96	04/01 → 05/04
1.9 TDI 4motion	Diesel	110	09/00 → 06/05
1.9 TDI 4motion	Diesel	66	07/98 → 04/02
1.9 TDI 4motion	Diesel	74	09/00 → 11/02
1.9 TDI 4motion	Diesel	85	09/99 → 06/01
1.9 TDI 4motion	Diesel	96	04/01 → 05/04

GOLF IV Variant (1J5)

1.8 T	Petrol	110	05/00 → 05/03
1.9 TDI	Diesel	66	05/99 → 05/06

GOLF IV Variant (1J5)

1.9 TDI	Diesel	74	09/00 → 11/02
1.9 TDI	Diesel	81	05/99 → 06/01
1.9 TDI	Diesel	85	08/99 → 06/01
1.9 TDI	Diesel	96	04/01 → 06/06
1.9 TDI 4motion	Diesel	66	05/99 → 04/02
1.9 TDI 4motion	Diesel	74	09/00 → 11/02
1.9 TDI 4motion	Diesel	85	05/99 → 06/01
1.9 TDI 4motion	Diesel	96	04/01 → 06/06

LT 28-35 II Autobus (2DB, 2DE, 2DK)

2.5 TDI	Diesel	80	05/99 → 04/01
---------	--------	----	---------------

APS39



KW



VOLKSWAGEN

LT 28-46 II Furgonato (2DA, 2DD, 2DH)

2.5 TDI Diesel 80 05/99 → 04/01

2.8 TDI Diesel 116 06/03 → 04/06

LT 28-46 II Pianale piatto/Telaio (2DC, 2DF, 2DG, 2DL, 2DM)

2.5 TDI Diesel 80 05/99 → 04/01

2.8 TDI Diesel 116 06/03 → 04/06

LUPO (6X1, 6E1)

1.2 TDI 3L Diesel 45 07/99 → 10/02

1.4 TDI Diesel 55 01/99 → 10/02

NEW BEETLE (9C1, 1C1)

1.8 T Petrol 110 10/99 → 09/10

1.9 TDI Diesel 66 01/98 → 06/04

1.9 TDI Diesel 77 07/05 → 09/10

NEW BEETLE Cabriolet (1Y7)

1.8 T Petrol 110 01/03 → 09/10

1.9 TDI Diesel 74 06/03 → 12/04

1.9 TDI Diesel 77 07/05 → 09/10

2.0 Petrol 85 09/02 → 10/10

PASSAT (3B2)

1.9 TDI Diesel 85 08/98 → 11/00

1.9 TDI 4motion Diesel 85 08/99 → 11/00

1.9 TDI Syncro/4motion Diesel 81 10/96 → 11/00

2.5 TDI Diesel 110 07/98 → 11/00

2.5 TDI Syncro/4motion Diesel 110 12/98 → 11/00

PASSAT (3B3)

1.8 T Petrol 125 02/01 → 02/03

1.8 T 20V Petrol 110 11/00 → 02/03

1.9 TDI Diesel 74 11/00 → 10/01

2.5 TDI Diesel 110 11/00 → 05/03

2.5 TDI 4motion Diesel 110 11/00 → 01/03

PASSAT Variant (3B5)

1.9 TDI Diesel 85 03/99 → 11/00

1.9 TDI 4motion Diesel 85 08/99 → 11/00

1.9 TDI Syncro/4motion Diesel 81 06/97 → 11/00

2.5 TDI Diesel 110 07/98 → 11/00

2.5 TDI Syncro/4motion Diesel 110 12/98 → 11/00

APS39



KW



VOLKSWAGEN

PASSAT Variant (3B6)

1.8 T 20V Petrol 110 11/00 → 02/03

1.9 TDI Diesel 74 11/00 → 10/01

2.5 TDI Diesel 110 11/00 → 05/03

2.5 TDI 4motion Diesel 110 11/00 → 01/03

POLO (6N2)

1.4 TDI Diesel 55 10/99 → 09/01

POLO (9N_)

1.4 TDI Diesel 55 10/01 → 04/02

1.9 TDI Diesel 74 10/01 → 04/02

POLO CLASSIC (6KV2)

110 1.9 TDI Diesel 81 10/99 → 01/02

POLO Variant (6KV5)

1.9 TDI Diesel 66 10/99 → 09/01

1.9 TDI Diesel 81 10/99 → 09/01

SHARAN (7M8, 7M9, 7M6)

1.8 T 20V Petrol 110 05/00 → 06/01

1.9 TDI Diesel 66 03/99 → 06/01

1.9 TDI Diesel 85 04/00 → 06/01

1.9 TDI 4motion Diesel 85 04/00 → 06/01

TRANSPORTER IV Autobus (70XB, 70XC, 7DB, 7DW)

2.5 TDI Diesel 111 05/98 → 04/01

2.5 TDI Diesel 65 05/98 → 04/01

2.5 TDI Diesel 75 09/95 → 04/01

TRANSPORTER IV Furgonato (70XA)

2.5 TDI Diesel 111 09/00 → 04/01

2.5 TDI Diesel 65 12/98 → 04/01

2.5 TDI Diesel 75 09/95 → 04/01

2.5 TDI Syncro Diesel 75 03/98 → 04/01

TRANSPORTER IV Pianale piatto/Telaio (70XD)

2.5 TDI Diesel 65 05/98 → 04/01

2.5 TDI Diesel 75 09/95 → 04/01

2.5 TDI Syncro Diesel 75 05/98 → 04/01

APS40
**SENSORE PRESSIONE ASSOLUTA
MAP SENSOR**

KW

AUDI
A2 (8Z0)

1.2 TDI	Diesel	45	02/02 → 08/05
1.4 TDI	Diesel	55	02/02 → 08/05

A3 (8L1)

1.9 TDI	Diesel	74	11/01 → 05/03
1.9 TDI	Diesel	77	05/03 → 05/10
2.0 TDI 16V	Diesel	103	01/05 → 08/12

A3 Sportback (8PA)

1.9 TDI	Diesel	77	09/04 → 05/10
2.0 TDI 16V	Diesel	103	02/05 → 03/13
2.0 TDI 16V quattro	Diesel	103	11/05 → 03/13

A4 (8E2, B6)

1.9 TDI	Diesel	85	06/04 → 12/04
1.9 TDI	Diesel	74	05/01 → 05/04
2.5 TDI	Diesel	114	08/01 → 07/02
2.5 TDI	Diesel	120	07/02 → 12/04
2.5 TDI quattro	Diesel	132	11/00 → 12/04

A4 (8EC, B7)

1.9 TDI	Diesel	85	11/04 → 11/05
2.5 TDI	Diesel	120	11/04 → 04/06

A4 Avant (8E5, B6)

1.9 TDI	Diesel	85	06/04 → 12/04
1.9 TDI	Diesel	74	11/01 → 05/04
2.5 TDI	Diesel	114	09/01 → 07/02
2.5 TDI	Diesel	120	07/02 → 12/04
2.5 TDI quattro	Diesel	132	09/01 → 12/04
1.9 TDI	Diesel	85	11/04 → 11/05
2.5 TDI	Diesel	120	11/04 → 05/06

A4 Cabriolet (8H7, B6, 8HE, B7)

2.5 TDI	Diesel	120	08/02 → 11/05
---------	--------	-----	---------------

APS40

KW

AUDI
A8 (4E_)

3.0 TDI quattro	Diesel	155	11/03 → 07/10
3.0 TDI quattro	Diesel	171	01/04 → 07/10
4.0 TDI quattro	Diesel	202	05/03 → 07/05

SEAT
ALHAMBRA (7V8, 7V9)

1.8 T 20V	Petrol	110	09/01 → 03/10
1.9 TDI	Diesel	85	07/01 → 03/10
1.9 TDI 4motion	Diesel	85	07/01 → 03/10

ALTEA (5P1)

1.9 TDI	Diesel	77	04/04 →
---------	--------	----	---------

CORDOBA (6L2)

1.4 TDI	Diesel	51	05/05 → 11/09
1.4 TDI	Diesel	55	10/02 → 12/05
1.4 TDI	Diesel	59	06/05 → 11/09
1.9 TDI	Diesel	74	09/02 → 11/09

IBIZA IV (6L1)

1.4 TDI	Diesel	51	05/05 → 11/09
1.4 TDI	Diesel	55	05/02 → 12/05
1.4 TDI	Diesel	59	06/05 → 11/09
1.8 T Cupra R	Petrol	132	01/04 → 02/08
1.8 T FR	Petrol	110	12/03 → 05/08
1.9 TDI	Diesel	74	02/02 → 11/09

LEON (1M1)

1.8 20V T	Petrol	132	03/03 → 04/04
1.8 20V T 4	Petrol	132	03/03 → 04/04
1.9 TDI	Diesel	66	03/03 → 07/04
1.9 TDI	Diesel	74	10/05 → 06/06
1.9 TDI	Diesel	81	03/03 → 07/04

TOLEDO II (1M2)

1.9 TDI	Diesel	66	03/03 → 07/04
1.9 TDI	Diesel	81	03/03 → 12/03

TOLEDO III (5P2)

1.9 TDI	Diesel	77	10/04 → 05/09
---------	--------	----	---------------

SKODA
FABIA (6Y2)

1.4 TDI	Diesel	55	04/03 → 03/08
---------	--------	----	---------------

FABIA (6Y2)

1.9 TDI	Diesel	74	05/04 → 03/08
---------	--------	----	---------------

FABIA Combi (6Y5)

1.4 TDI	Diesel	55	04/03 → 12/07
1.9 TDI	Diesel	74	05/04 → 12/07

FABIA Tre volumi (6Y3)

1.4 TDI	Diesel	55	04/03 → 12/07
1.9 TDI	Diesel	74	05/04 → 12/07

APS40



SKODA

OCTAVIA (1U2)

1.8 T	Petrol	110	02/03 → 09/04
1.8 T 4x4	Petrol	110	02/03 → 09/04
1.9 TDI	Diesel	81	03/03 → 09/04
RS 1.8 T	Petrol	132	02/03 → 09/04

OCTAVIA (1Z3)

1.9 TDI	Diesel	77	06/04 → 12/10
---------	--------	----	---------------

OCTAVIA Combi (1U5)

1.8 T	Petrol	110	02/03 → 09/04
1.8 T 4x4	Petrol	110	02/03 → 09/04
1.9 TDI	Diesel	66	03/03 → 09/04
1.9 TDI	Diesel	81	03/03 → 09/04
1.9 Tdi 4x4	Diesel	74	03/03 → 09/04
RS 1.8 T	Petrol	132	02/03 → 09/04

OCTAVIA Combi (1Z5)

1.9 TDI	Diesel	77	09/04 → 12/10
1.9 Tdi 4x4	Diesel	77	11/04 → 12/10

SUPERB (3U4)

1.9 TDI	Diesel	74	08/02 → 10/05
2.5 TDI	Diesel	120	06/03 → 03/08

VOLKSWAGEN

BORA (1J2)

1.8 T	Petrol	110	04/03 → 05/05
1.8 T	Petrol	132	04/03 → 05/03
1.9 TDI	Diesel	74	04/03 → 05/05
1.9 TDI 4motion	Diesel	74	04/03 → 05/05

BORA Station wagon (1J6)

1.8 T	Petrol	110	04/03 → 05/05
1.8 T	Petrol	132	04/03 → 05/03
1.9 TDI	Diesel	74	04/03 → 05/05
1.9 TDI 4motion	Diesel	74	04/03 → 05/05

CADDY III Furgonato (2KA, 2KH, 2CA, 2CH)

1.9 TDI	Diesel	77	04/04 → 08/10
2.0 SDI	Diesel	51	03/04 → 08/10

CADDY III Station wagon (2KB, 2KJ, 2CB, 2CJ)

1.9 TDI	Diesel	55	09/05 → 08/10
1.9 TDI	Diesel	77	04/04 → 08/10
2.0 SDI	Diesel	51	03/04 → 08/10

GOLF IV (1J1)

1.9 TDI	Diesel	74	05/01 → 05/04
1.9 TDI	Diesel	81	12/02 → 05/04
1.9 TDI 4motion	Diesel	74	12/02 → 06/05

GOLF IV Variant (1J5)

1.9 TDI	Diesel	74	05/01 → 06/06
1.9 TDI 4motion	Diesel	74	12/02 → 06/06

APS40



VOLKSWAGEN

GOLF PLUS (5M1, 521)

1.9 TDI	Diesel	66	05/05 → 12/08
1.9 TDI	Diesel	77	01/05 → 05/05

GOLF V (1K1)

1.9 TDI	Diesel	66	05/04 → 11/08
1.9 TDI	Diesel	77	10/03 → 11/08
1.9 TDI 4motion	Diesel	77	08/04 → 11/08
2.0 SDI	Diesel	55	01/04 → 11/08

JETTA III (1K2)

1.9 TDI	Diesel	77	08/05 → 10/10
---------	--------	----	---------------

LT 28-35 II Autobus (2DB, 2DE, 2DK)

2.5 TDI	Diesel	61	05/01 → 04/06
2.5 TDI	Diesel	70	05/01 → 04/06
2.5 TDI	Diesel	80	05/01 → 04/06

LT 28-46 II Furgonato (2DA, 2DD, 2DH)

2.5 TDI	Diesel	61	05/01 → 04/06
2.5 TDI	Diesel	70	05/01 → 04/06
2.5 TDI	Diesel	80	05/01 → 04/06

LT 28-46 II Pianale piatto/Telaio (2DC, 2DF, 2DG, 2DL, 2DM)

2.5 TDI	Diesel	61	05/01 → 04/06
2.5 TDI	Diesel	70	05/01 → 04/06
2.5 TDI	Diesel	80	05/01 → 04/06

LUPO (6X1, 6E1)

1.2 TDI 3L	Diesel	45	11/02 → 07/05
1.4 TDI	Diesel	55	11/02 → 07/05

MULTIVAN V (7HM, 7HN, 7HF, 7EF, 7EM, 7EN)

1.9 TDI	Diesel	77	04/03 → 11/09
---------	--------	----	---------------

NEW BEETLE (9C1, 1C1)

1.9 TDI	Diesel	74	02/01 → 06/05
1.9 TDI	Diesel	74	01/05 → 06/05

PASSAT (3B3)

1.9 TDI	Diesel	74	11/01 → 05/05
2.5 TDI	Diesel	120	05/03 → 05/05
2.5 TDI 4motion	Diesel	132	01/03 → 05/05

PASSAT (3C2)

1.9 TDI	Diesel	77	03/05 → 11/08
---------	--------	----	---------------

PASSAT Variant (3B6)

1.9 TDI	Diesel	74	11/01 → 05/05
2.5 TDI	Diesel	120	05/03 → 05/05
2.5 TDI 4motion	Diesel	132	01/03 → 05/05

PASSAT Variant (3C5)

1.9 TDI	Diesel	77	08/05 → 11/08
---------	--------	----	---------------

APS40

VOLKSWAGEN
POLO (9N_)

1.4 TDI	Diesel	51	04/05 → 11/09
1.4 TDI	Diesel	55	05/02 → 05/05
1.4 TDI	Diesel	59	04/05 → 11/09
1.8 GTI	Petrol	110	09/05 → 11/09
1.9 TDI	Diesel	74	05/02 → 11/09

POLO Tre volumi (9A4)

1.4 TDI	Diesel	55	07/03 →
---------	--------	----	---------

SHARAN (7M8, 7M9, 7M6)

1.8 T 20V	Petrol	110	07/01 → 03/10
1.9 TDI	Diesel	66	07/01 → 03/10
1.9 TDI	Diesel	85	07/01 → 03/10
1.9 TDI 4motion	Diesel	85	07/01 → 03/10

TOURAN (1T1, 1T2)

1.9 TDI	Diesel	66	06/05 → 05/10
1.9 TDI	Diesel	74	02/03 → 05/04
1.9 TDI	Diesel	77	08/03 → 05/10

TRANSPORTER IV Autobus (70XB, 70XC, 7DB, 7DW)

2.5 TDI	Diesel	111	05/01 → 04/03
2.5 TDI	Diesel	65	05/01 → 04/03
2.5 TDI	Diesel	75	05/01 → 04/03

TRANSPORTER IV Furgonato (70XA)

2.5 TDI	Diesel	111	05/01 → 04/03
2.5 TDI	Diesel	65	05/01 → 04/03
2.5 TDI	Diesel	75	05/01 → 04/03
2.5 TDI Syncro	Diesel	75	05/01 → 04/03

TRANSPORTER IV Pianale piatto/Telaio (70XD)

2.5 TDI	Diesel	65	05/01 → 04/03
2.5 TDI	Diesel	75	05/01 → 04/03
2.5 TDI Syncro	Diesel	75	05/01 → 04/03

TRANSPORTER V Autobus (7HB, 7HJ, 7EB, 7EJ, 7EF)

1.9 TDI	Diesel	63	04/03 → 11/09
1.9 TDI	Diesel	77	04/03 → 11/09

TRANSPORTER V Furgonato (7HA, 7HH, 7EA, 7EH)

1.9 TDI	Diesel	63	04/03 → 11/09
1.9 TDI	Diesel	77	04/03 → 11/09

TRANSPORTER V Pianale piatto/Telaio (7JD, 7JE, 7JL, 7JY, 7JZ)

1.9 TDI	Diesel	63	04/03 → 11/09
1.9 TDI	Diesel	77	04/03 → 11/09

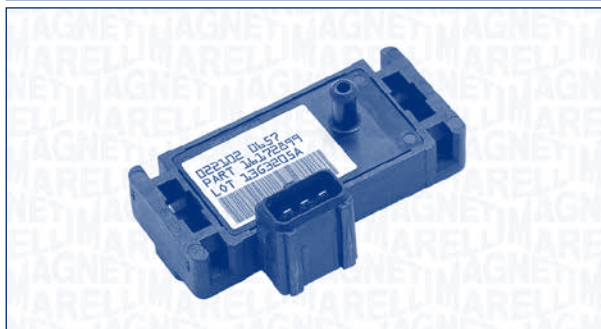
APS41
**SENSORE PRESSIONE ASSOLUTA
MAP SENSOR**

SAAB
900 II

2.0 -16 Turbo	Petrol	136	07/93 → 02/98
---------------	--------	-----	---------------

900 II Cabriolet

2.0 -16 Turbo	Petrol	136	12/93 → 02/98
---------------	--------	-----	---------------

9000

2.0 -16 CD	Petrol	96	09/93 → 12/98
------------	--------	----	---------------

2.0 -16 Turbo CD	Petrol	108	09/92 → 12/98
------------------	--------	-----	---------------

2.3 -16 CD	Petrol	107	08/89 → 12/98
------------	--------	-----	---------------

2.3 -16 CD Turbo	Petrol	147	07/90 → 12/98
------------------	--------	-----	---------------

2.3 -16 CDE	Petrol	108	09/93 → 12/98
-------------	--------	-----	---------------

2.3 -16 CDE Eco-Power	Petrol	125	09/93 → 12/98
-----------------------	--------	-----	---------------

2.3 -16 Turbo	Petrol	143	09/90 → 08/93
---------------	--------	-----	---------------

9000 2 volumi /Coda spiovente

2.0 -16 CS	Petrol	96	09/93 → 12/98
------------	--------	----	---------------

2.0 -16 ND Turbo	Petrol	110	09/93 → 12/98
------------------	--------	-----	---------------

2.3 -16 Aero CS	Petrol	162	02/93 → 12/98
-----------------	--------	-----	---------------

2.3 -16 Aero CS	Petrol	165	02/93 → 12/98
-----------------	--------	-----	---------------

2.3 -16 CS	Petrol	107	09/89 → 12/98
------------	--------	-----	---------------

2.3 -16 CSE	Petrol	108	09/93 → 12/98
-------------	--------	-----	---------------

2.3 -16 CSE Eco Power	Petrol	125	09/93 → 12/98
-----------------------	--------	-----	---------------

2.3 -16 Turbo	Petrol	143	09/90 → 12/98
---------------	--------	-----	---------------

2.3 -16 Turbo CSE	Petrol	147	09/93 → 12/98
-------------------	--------	-----	---------------

APS42

**SENSORE PRESSIONE ASSOLUTA
MAP SENSOR**

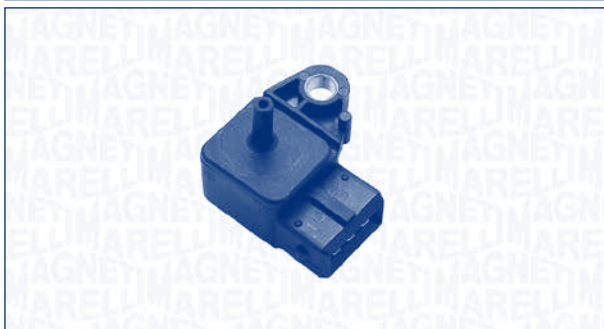

KW



BMW

3 Touring (E36)

325 tds Diesel 105 01/95 → 10/99

5 (E34)

525 tds Diesel 105 10/92 → 09/95

5 (E39)

525 td Diesel 85 01/97 → 06/03

525 tds Diesel 105 01/96 → 06/03

5 Touring (E34)

525 td Diesel 85 03/93 → 01/97

525 tds Diesel 105 10/92 → 01/97

5 Touring (E39)

525 tds Diesel 105 03/97 → 05/04

7 (E38)

725 tds Diesel 105 04/96 → 11/01

LAND ROVER

RANGE ROVER II (LP)

2.5 TD 4x4 Diesel 100 07/94 → 03/02

OPEL

OMEGA B (25_, 26_, 27_)

2.5 TD Diesel 96 04/94 → 07/03

OMEGA B Station wagon (21_, 22_, 23_)

2.5 TD Diesel 96 04/94 → 07/01

VOLVO

850 (LS)

2.5 TDI Diesel 103 08/95 → 12/96

850 Station wagon (LW)

2.5 TDI Diesel 103 08/95 → 12/96

S80 I (TS, XY)

2.5 TDI Diesel 103 01/99 → 07/06

V70 II (SW)

2.5 TDI Diesel 103 03/00 → 08/07

APS43

**SENSORE PRESSIONE ASSOLUTA
MAP SENSOR**



KW



OPEL

ASTRA G 2 volumi /Coda spiovente (F48_, F08_)

1.7 CDTI Diesel 59 04/03 → 12/09

ASTRA G Station wagon (F35_)

1.7 CDTI Diesel 59 04/03 → 07/09

ASTRA G Tre volumi (F69_)

1.7 CDTI Diesel 59 04/03 → 12/09

ASTRA H (L48)

1.7 CDTI Diesel 59 03/04 →

1.7 CDTI Diesel 74 03/04 →

ASTRA H GTC (L08)

1.7 CDTI Diesel 74 03/05 →

ASTRA H Station wagon (L35)

1.7 CDTI Diesel 59 08/04 →

1.7 CDTI Diesel 74 08/04 →

CORSA C (F08, F68)

1.7 CDTI Diesel 74 06/03 → 12/09

MERIVA

1.7 CDTI Diesel 74 09/03 → 05/10

APS44
**SENSORE PRESSIONE ASSOLUTA
MAP SENSOR**

KW

DAEWOO
LEGANZA (KLAJ)

2.0 16V Petrol 98 06/97 → 12/02

NUBIRA (KLAJ)

2.0 16V Petrol 98 05/97 →

NUBIRA Tre volumi (KLAJ)

2.0 16V Petrol 98 05/97 →

NUBIRA Wagon (KLAJ)

2.0 16V Petrol 98 05/97 →

TACUMA (KLAU)

2.0 Petrol 94 09/00 →

FIAT
CROMA (194)

2.2 16V Petrol 108 06/05 →

ISUZU
TROOPER

3.5 V6 24V Petrol 158 04/00 →

TROOPER Fuoristrada aperto

3.5 V6 24V Petrol 158 04/00 →

OPEL
ASTRA G 2 volumi /Coda spiovente (F48_, F08_)

2.2 16V Petrol 108 06/00 → 01/05

ASTRA G Cabriolet (F67)

1.6 16V Petrol 74 03/01 → 10/05

2.2 16V Petrol 108 03/01 → 10/05

ASTRA G Coupé (F07_)

2.2 16V Petrol 108 09/00 → 05/05

ASTRA G Station wagon (F35_)

2.2 16V Petrol 108 03/01 → 07/04

ASTRA G Tre volumi (F69_)

2.2 16V Petrol 108 03/01 → 01/05

ASTRA H (L48)

1.6 Petrol 77 03/04 →

ASTRA H Station wagon (L35)

1.6 Petrol 77 08/04 →

APS44

KW

OPEL
CORSA C (F08, F68)

1.4 Petrol 66 09/00 → 12/09

FRONTERA B (6B_)

2.2 i (6B_ZC, 6B_VF, 6B_66, 6B_76) Petrol 100 10/98 →

FRONTERA B (6B_)

3.2 i (6B1VF, 6B1_6) Petrol 151 10/98 →

MERIVA

1.6 Petrol 64 05/03 → 05/10

1.6 16V Petrol 74 05/03 → 01/06

MONTEREY B

3.5 V6 24V Petrol 158 07/98 → 08/99

SIGNUM

2.2 direct Petrol 114 05/03 →

SPEEDSTER

2.2 Petrol 108 09/00 →

VECTRA B (36_)

1.6 i 16V Petrol 74 10/95 → 04/02

2.2 i 16V Petrol 108 09/00 → 04/02

VECTRA B 2 volumi /Coda spiovente (38_)

1.6 i 16V Petrol 74 10/95 → 07/02

2.2 i 16V Petrol 108 09/00 → 07/03

VECTRA B Station wagon (31_)

2.2 i 16V Petrol 108 09/00 → 07/03

VECTRA C

1.6 16V Petrol 74 06/04 →

2.2 16V Petrol 108 04/02 →

2.2 direct Petrol 114 10/03 →

VECTRA C GTS

2.2 16V Petrol 108 08/02 →

2.2 direct Petrol 114 10/03 →

VECTRA C Station wagon

1.6 16V Petrol 74 06/04 →

2.2 direct Petrol 114 10/03 →

VIVARO Combi (J7)

2.0 16V Petrol 88 08/01 →

VIVARO Furgonato (F7)

2.0 16V Petrol 88 08/01 →

ZAFIRA A (F75_)

2.2 16V Petrol 108 09/00 → 06/05

ZAFIRA B (A05)

1.6 Petrol 77 07/05 →

2.2 Petrol 110 07/05 →

APS44



RENAULT

CLIO II (BB0/1/2_, CB0/1/2_)

1.2 (BB0A, BB0F, BB10, BB1K, BB28, BB2D, BB2H, CB0A...)	Petrol	43	10/99 → 03/02
---	--------	----	---------------

CLIO II Furgonato (SB0/1/2_)

1.1 (SB0A, SB0F, SB1K, SB2D)	Petrol	43	10/99 → 03/02
------------------------------	--------	----	---------------

KANGOO (KC0/1_)

1.2 (KC0A, KC0K, KC0F, KC01)	Petrol	43	10/99 → 03/02
------------------------------	--------	----	---------------

KANGOO Express (FC0/1_)

1.2 (FC01, FC0A, FC0F)	Petrol	43	10/99 → 03/02
------------------------	--------	----	---------------

LAGUNA I (B56_, 556_)

1.6 16V (B568, B561)	Petrol	79	11/97 → 03/01
----------------------	--------	----	---------------

LAGUNA I Grandtour (K56_)

1.6 16V (K568)	Petrol	79	11/97 → 03/01
----------------	--------	----	---------------

APS45

**SENSORE PRESSIONE ASSOLUTA
MAP SENSOR**

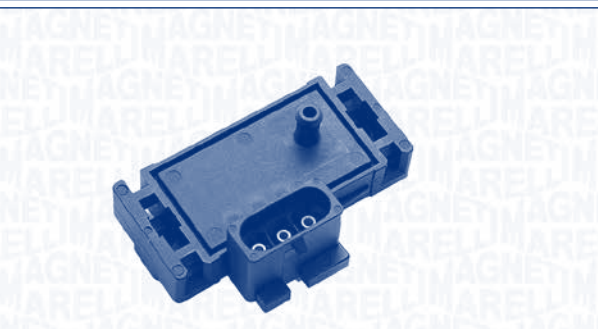

ALFA ROMEO

145 (930)

1.6 i.e.	Petrol	76	10/94 → 12/96
----------	--------	----	---------------

146 (930)

1.6 i.e.	Petrol	76	12/94 → 12/96
----------	--------	----	---------------

CITROËN

BX (XB-_)

19 E	Petrol	80	06/88 → 02/93
------	--------	----	---------------

BX Break (XB-_)

19	Petrol	80	06/88 → 12/94
----	--------	----	---------------

APS45



CITROËN

XANTIA (X2)

1.8 i 16V	Petrol	81	01/98 → 04/03
-----------	--------	----	---------------

XANTIA Break (X2)

1.8 i 16V	Petrol	81	01/98 → 04/03
-----------	--------	----	---------------

XM (Y3)

3.0 V6	Petrol	123	05/89 → 06/94
--------	--------	-----	---------------

3.0 V6 24V	Petrol	147	07/90 → 06/94
------------	--------	-----	---------------

XM (Y4)

3.0 V6	Petrol	123	05/94 → 10/00
--------	--------	-----	---------------

3.0 V6 24V	Petrol	147	05/94 → 10/00
------------	--------	-----	---------------

XM Break (Y3)

3.0 V6	Petrol	123	11/91 → 04/94
--------	--------	-----	---------------

XM Break (Y4)

3.0 V6	Petrol	123	05/94 → 10/00
--------	--------	-----	---------------

XSARA (N1)

1.8 i 16V	Petrol	81	04/97 → 09/00
-----------	--------	----	---------------

XSARA Break (N2)

1.8 i 16V	Petrol	81	10/97 → 09/00
-----------	--------	----	---------------

DAEWOO

LANOS (KLAT)

1.4	Petrol	55	05/97 →
-----	--------	----	---------

1.5	Petrol	63	05/97 →
-----	--------	----	---------

1.6 16V	Petrol	78	05/97 →
---------	--------	----	---------

LANOS Tre volumi (KLAT)

1.4	Petrol	55	05/97 →
-----	--------	----	---------

1.5	Petrol	63	05/97 →
-----	--------	----	---------

1.6 16V	Petrol	78	05/97 →
---------	--------	----	---------

FIAT

PUNTO (176)

1.6	Petrol	65	01/94 → 04/97
-----	--------	----	---------------

PUNTO Cabriolet (176C)

90 1.6	Petrol	65	04/94 → 04/97
--------	--------	----	---------------

TEMPRA (159)

1.6 i.e. (159.AJ)	Petrol	63	06/94 → 08/96
-------------------	--------	----	---------------

1.6 i.e. (159.AJ)	Petrol	66	06/94 → 08/96
-------------------	--------	----	---------------

TEMPRA S.W. (159)

1.6 i.e. (159.AJ)	Petrol	66	06/94 → 08/96
-------------------	--------	----	---------------

HYUNDAI

ACCENT I (X-3)

1.3	Petrol	44	10/94 → 04/97
-----	--------	----	---------------

1.3	Petrol	55	10/94 → 04/97
-----	--------	----	---------------

1.3 i 12V	Petrol	62	10/94 → 04/97
-----------	--------	----	---------------

1.5 i 12V	Petrol	65	10/94 → 04/97
-----------	--------	----	---------------

APS45

HYUNDAI
ACCENT Tre volumi (X-3)

1.3	Petrol	44	10/94 → 04/97
1.3	Petrol	55	10/94 → 04/97
1.3 i 12V	Petrol	62	10/94 → 04/97
1.5 i 12V	Petrol	65	10/94 → 04/97

COUPE (RD)

1.6 i 16V	Petrol	84	12/96 → 04/97
-----------	--------	----	---------------

LANTRA I (J-1)

1.5 i.e.	Petrol	63	10/90 → 11/95
1.6 i.e. 16V	Petrol	78	10/90 → 11/95
1.6 i.e. 16V	Petrol	84	10/90 → 11/95
1.8 i.e. 16V	Petrol	93	10/90 → 11/95

LANTRA II (J-2)

1.5 12V	Petrol	65	12/96 → 04/97
1.6 16V	Petrol	84	11/95 → 04/97
1.6 i	Petrol	66	11/95 → 04/97
1.8 16V	Petrol	94	11/95 → 04/97

LANTRA II Wagon (J-2)

2.0 16V	Petrol	102	12/96 → 04/97
---------	--------	-----	---------------

PONY (X-2)

1.5 i	Petrol	61	07/92 → 01/95
1.5 i	Petrol	62	07/92 → 01/95

PONY / EXCEL Tre volumi (X-2)

1.5 i	Petrol	61	07/92 → 01/95
1.5 i	Petrol	62	07/92 → 01/95

S COUPE (SLC)

1.5 i	Petrol	62	02/90 → 05/96
1.5 i	Petrol	65	04/92 → 05/96

JEEP
CHEROKEE (XJ)

2.5 i 4x4	Petrol	90	12/91 → 12/95
4.0 i	Petrol	135	12/91 → 12/95
4.0 i	Petrol	136	01/88 → 12/95

WRANGLER I (YJ, SJ_)

2.5	Petrol	89	12/91 → 12/95
4.0	Petrol	131	12/91 → 12/95

KIA
SHUMA (FB)

1.5 i 16V	Petrol	65	10/97 → 03/01
1.8 i 16V	Petrol	81	10/97 → 03/01
1.8	Petrol	84	04/03 → 08/04

SHUMA Tre volumi (FB)

1.5	Petrol	59	03/96 → 12/98
1.5 i 16V	Petrol	65	10/97 → 10/01

APS45

LANCIA
DEDRA (835)

1.6 16V (835EI)	Petrol	76	01/96 → 07/99
1.6 LE (835EB) Cat.	Petrol	66	07/94 → 07/99

DEDRA SW (835)

1.6 (835EB)	Petrol	66	10/94 → 07/99
1.6 16V (835EI)	Petrol	76	01/96 → 07/99

DELTA I (831AB0)

1.6 GT i.e. (831AB.010)	Petrol	66	05/87 → 08/92
1.6 HF Turbo (831AB.020S)	Petrol	97	04/87 → 03/89

OPEL
ASTRA F (56_, 57_)

1.4 i	Petrol	44	09/91 → 09/98
1.4 i 16V	Petrol	66	02/96 → 09/98
1.4 Si	Petrol	60	03/92 → 09/98
1.6	Petrol	55	09/95 → 09/98
1.6 i	Petrol	52	05/93 → 07/96
1.6 i	Petrol	55	03/92 → 09/98
1.6 i 16V	Petrol	74	08/94 → 09/98
1.6 Si	Petrol	74	05/92 → 12/94
1.8 i	Petrol	66	03/92 → 09/98
1.8 i 16V	Petrol	92	06/93 → 10/94

ASTRA F 2 volumi /Coda spiovente (53_, 54_, 58_, 59_)

1.4 i	Petrol	44	03/92 → 01/98
1.4 i 16V	Petrol	66	01/96 → 01/98
1.4 Si	Petrol	60	03/92 → 01/98
1.6	Petrol	55	09/95 → 01/98
1.6 i	Petrol	52	05/93 → 07/96
1.6 i	Petrol	55	09/91 → 01/98
1.6 i 16V	Petrol	74	08/94 → 01/98
1.6 Si	Petrol	74	03/92 → 12/94
1.8 i	Petrol	66	09/91 → 01/98
1.8 i 16V	Petrol	92	06/93 → 08/94

ASTRA F Cabriolet (53_B)

1.4 i 16V	Petrol	66	01/96 → 03/01
1.4 Si	Petrol	60	05/93 → 03/01
1.6 i	Petrol	52	03/93 → 08/96
1.6 i	Petrol	55	01/96 → 03/01

ASTRA F CLASSIC 2 volumi /Coda spiovente

1.4 i	Petrol	44	01/98 → 08/02
1.6 i	Petrol	55	01/98 → 08/02
1.6 i 16V	Petrol	74	01/98 → 08/02

APS45



KW



OPEL

ASTRA F CLASSIC Station wagon

1.4 i	Petrol	44	01/98 → 01/05
1.6 i	Petrol	55	01/98 → 01/05
1.6 i 16V	Petrol	74	01/98 → 01/05

ASTRA F CLASSIC Tre volumi

1.4 i	Petrol	44	01/98 → 08/02
1.6 i	Petrol	55	01/98 → 08/02
1.6 i 16V	Petrol	74	01/98 → 08/02

ASTRA F Station wagon (51_, 52_)

1.4 i	Petrol	44	09/91 → 01/98
1.4 i 16V	Petrol	66	02/96 → 01/98
1.4 Si	Petrol	60	03/92 → 01/98
1.6	Petrol	55	09/95 → 01/98
1.6 i	Petrol	52	05/93 → 07/96
1.6 i	Petrol	55	09/91 → 01/98
1.6 i 16V	Petrol	74	08/94 → 01/98
1.6 Si	Petrol	74	03/92 → 12/94
1.8 i	Petrol	66	09/91 → 01/98
1.8 i 16V	Petrol	92	06/93 → 01/98

ASTRA F Van (55_)

1.4 i	Petrol	44	10/91 → 01/99
1.6 i	Petrol	52	02/93 → 07/96
1.6 i	Petrol	55	10/91 → 04/93

ASTRA G 2 volumi /Coda spiovente (F48_, F08_)

1.4 16V	Petrol	66	02/98 → 01/05
1.6	Petrol	55	02/98 → 09/00
1.6 16V	Petrol	74	02/98 → 01/05

ASTRA G Furgonato (F70)

1.6	Petrol	55	01/99 → 09/00
-----	--------	----	---------------

ASTRA G Station wagon (F35_)

1.4 16V	Petrol	66	06/98 → 07/04
1.6	Petrol	55	02/98 → 09/00
1.6 16V	Petrol	74	02/98 → 07/04

ASTRA G Tre volumi (F69_)

1.4 16V	Petrol	66	09/98 → 01/05
1.6	Petrol	55	09/98 → 09/00
1.6 16V	Petrol	74	09/98 → 01/05

COMBO (71_)

1.4	Petrol	44	07/94 → 10/01
1.4	Petrol	60	07/94 → 10/01
1.4 16V	Petrol	66	08/99 → 10/01

CORSA B (73_, 78_, 79_)

1.2 i	Petrol	33	03/93 → 09/00
1.2 i	Petrol	33	03/93 → 09/00
1.4 i	Petrol	44	03/93 → 09/00

APS45



KW



OPEL

CORSA B (73_, 78_, 79_)

1.4 i 16V	Petrol	66	09/94 → 09/00
1.4 Si	Petrol	60	03/93 → 09/00
1.6 i 16V	Petrol	74	08/97 → 09/00
1.6 i 16V	Petrol	78	09/94 → 09/00

CORSA B Furgonato (73_)

1.4 i	Petrol	44	08/99 → 09/00
-------	--------	----	---------------

TIGRA (95_)

1.4 16V	Petrol	63	08/97 → 12/00
1.4 16V	Petrol	66	07/94 → 12/00
1.6 16V	Petrol	74	08/97 → 08/98
1.6 16V	Petrol	78	07/94 → 08/98

VECTRA A (86_, 87_)

1.6 i	Petrol	52	09/93 → 11/95
1.6 i	Petrol	55	09/88 → 11/95
1.6 i	Petrol	55	09/93 → 11/95
1.8 i Cat.	Petrol	66	03/90 → 11/95

VECTRA A 2 volumi /Coda spiovente (88_, 89_)

1.6 i	Petrol	55	09/93 → 11/95
1.6 i Cat.	Petrol	55	09/88 → 11/95
1.8 i Cat.	Petrol	66	03/90 → 11/95

VECTRA B (36_)

1.6 i	Petrol	55	10/95 → 04/02
1.6 i	Petrol	55	10/95 → 04/02

VECTRA B 2 volumi /Coda spiovente (38_)

1.6 i	Petrol	55	10/95 → 07/03
1.6 i	Petrol	55	10/95 → 07/03

VECTRA B Station wagon (31_)

1.6 i	Petrol	55	11/96 → 06/00
-------	--------	----	---------------

PEUGEOT

406 (8B)

1.8 16V	Petrol	81	04/99 → 10/00
---------	--------	----	---------------

605 (6B)

3.0 SV 24	Petrol	147	08/89 → 09/99
-----------	--------	-----	---------------

RENAULT

19 II (B/C53_)

1.4 (B/C532)	Petrol	43	04/92 → 12/95
1.4 (B/C535)	Petrol	55	01/92 → 12/95
1.7 (B/C53B)	Petrol	54	04/92 → 12/95
1.7 (B/C53C)	Petrol	66	04/92 → 12/95
1.8 (5/353A)	Petrol	66	04/92 → 12/95
1.8 (5/353F, B/C538)	Petrol	79	05/94 → 12/95
1.8 (B/C538)	Petrol	81	04/92 → 05/94
1.8 (B/C53Y)	Petrol	65	04/92 → 12/95

APS45

RENAULT
19 II (B/C53_)

1.8 16V (B/C53D) Petrol 99 04/92 → 12/95

19 II Cabriolet (D53_, 853_)

1.7 (D53C) Petrol 66 04/92 → 09/93

1.8 (D53V, 853F, D53C) Petrol 79 07/94 → 06/96

1.8 (D53Y) Petrol 65 04/92 → 06/96

1.8 16V (D53D) Petrol 99 04/92 → 06/96

19 II Chamade (L53_)

1.4 (532) Petrol 43 04/92 → 12/95

1.4 (L535) Petrol 55 11/93 → 12/95

1.7 (L53B) Petrol 54 04/92 → 12/95

1.8 (453A/F) Petrol 66 04/92 → 12/95

1.8 (L538) Petrol 81 04/92 → 05/94

1.8 (L53V, L538) Petrol 79 05/94 → 12/95

1.8 (L53Y) Petrol 65 04/92 → 12/95

1.8 16V (L53D) Petrol 99 04/92 → 12/95

21 (B48_)

1.7 (B48E) Petrol 66 09/89 → 06/94

1.7 (B48F) Petrol 54 09/89 → 10/92

2.0 (B48C) Petrol 88 09/89 → 12/93

2.0 (B48R/Y) Petrol 99 02/90 → 10/92

2.2 (B48K) Petrol 79 09/89 → 06/94

21 Station wagon (K48_)

1.7 (K48E) Petrol 66 10/89 → 12/93

1.7 (K48E) Petrol 69 06/86 → 12/89

1.7 (K48F) Cat. Petrol 54 05/88 → 06/93

2.0 (K483) Petrol 85 06/86 → 12/88

2.0 (K48C) Petrol 88 03/86 → 12/93

2.0 4x4 Petrol 88 03/89 → 12/93

2.2 (K48K) Petrol 79 06/86 → 11/93

21 Tre volumi (L48_)

1.7 (L48E) Petrol 66 09/89 → 02/94

1.7 (L48E) Petrol 69 03/86 → 02/94

1.7 (L48M, L48F) Petrol 54 07/86 → 02/94

2.0 (L483) Petrol 85 03/86 → 12/88

2.0 (L48C) Petrol 88 03/86 → 12/93

2.2 (L48K) Petrol 79 07/86 → 02/94

CLIO I (B/C57_, 5/357_)

1.2 (5/357Y, 5/357K) Petrol 40 01/96 → 09/98

1.2 (B/C/S577) Petrol 40 01/96 → 12/96

1.2 (B/C/S57A, B/C57S, 5/357F, 5/357J, 5/357L, 5/357R) Petrol 43 05/90 → 09/98

APS45

RENAULT
CLIO I (B/C57_, 5/357_)

1.2 (B/C57R) Petrol 40 01/91 → 06/96

1.4 (B/C57T, B/C57Y) Petrol 58 01/91 → 09/98

1.4 (B57J, C57J) Petrol 55 01/91 → 09/98

1.8 (B/C578) Petrol 66 08/94 → 09/98

1.8 (B/C57C, B/C57U) Petrol 65 01/91 → 09/98

1.8 16V (C57D) Petrol 99 01/91 → 03/96

1.8 Rsi (B/C579) Petrol 80 01/93 → 08/95

1.8 Rsi (B/C57H) Petrol 79 08/95 → 09/98

Williams (B/C57M) Petrol 108 01/94 → 09/98

CLIO I Furgonato (S57_)

1.2 Petrol 40 01/91 → 09/98

1.2 Petrol 44 01/91 → 09/98

CLIO II (BB0/1/2_, CB0/1/2_)

1.2 (BB0A, BB0F, BB10, BB1K, BB28, BB2D, BB2H, CB0A...) Petrol 43 09/98 → 09/99

1.4 (B/CB0C) Petrol 55 09/98 → 05/05

1.6 (B/CB0D) Petrol 66 09/98 → 05/05

CLIO II Furgonato (SB0/1/2_)

1.1 (SB0A, SB0F, SB1K, SB2D) Petrol 43 09/98 → 09/99

ESPACE II (J/S63_)

2.0 (J636) Petrol 76 01/91 → 10/96

2.2 (J/S637, J63G) Petrol 79 01/91 → 10/96

2.8 V6 (J638, J63J) Petrol 110 01/91 → 10/96

KANGOO (KC0/1_)

1.2 (KC0A, KC0K, KC0F, KC01) Petrol 43 08/97 → 09/99

1.4 (KC0C, KC0H, KC0B, KC0M) Petrol 55 08/97 →

KANGOO Express (FC0/1_)

1.2 (FC01, FC0A, FC0F) Petrol 43 08/97 → 09/99

1.4 (FC0C, FC0B, FC0H, FC0M) Petrol 55 08/97 →

APS45

KW

RENAULT
LAGUNA I (B56_, 556_)

1.8 (B56A/B)	Petrol	66	11/93 → 03/01
1.8 (B56S/T/0)	Petrol	66	08/95 → 03/01
1.8 (B56Z)	Petrol	69	08/95 → 03/01
2.0 (B56C/H/N)	Petrol	83	11/93 → 03/01
2.0 16V (B56D/M)	Petrol	102	06/95 → 03/01
3.0 (B56E/R, B565)	Petrol	123	11/93 → 03/01

LAGUNA I Grandtour (K56_)

1.8 (K56S/T/0)	Petrol	66	09/95 → 03/01
1.8 (K56Z)	Petrol	69	09/95 → 03/01
2.0 (K56C/H)	Petrol	83	09/95 → 03/01
2.0 16V (K56D/M)	Petrol	102	09/95 → 03/01

MASTER I Autobus (T__)

30 2,2	Petrol	67	08/80 → 07/98
--------	--------	----	---------------

MASTER I Furgonato (T__)

30 2,2	Petrol	67	08/80 → 07/98
--------	--------	----	---------------

MEGANE I (BA0/1_)

1.4 e (BA0E, BA0V)	Petrol	55	01/96 → 08/03
1.6 e (BA0F, BA0S)	Petrol	66	01/96 → 03/99
1.6 i (BA0L)	Petrol	55	01/96 → 03/99
2.0 i (BA0G)	Petrol	84	01/96 → 08/03

MEGANE I Cabriolet (EA0/1_)

2.0 (EA0G)	Petrol	84	04/97 → 08/03
------------	--------	----	---------------

MEGANE I Coach (DA0/1_)

1.6 e (DA0F)	Petrol	66	03/96 → 03/99
2.0 16V (DA0H)	Petrol	108	03/96 → 11/99
2.0 i (DA0G)	Petrol	84	03/96 → 08/03

RAPID Furgonato (F40_, G40_)

1.2 (F406, G40A)	Petrol	40	09/91 → 03/98
1.4 (F407) Cat.	Petrol	43	08/88 → 03/98
1.4 (F40D)	Petrol	58	01/94 → 03/98
1.4 (F40U, F40V)	Petrol	55	09/91 → 03/98

SAFRANE I (B54_)

2.0 (B540)	Petrol	77	11/92 → 07/96
2.0 12V (B542, B54E)	Petrol	97	04/92 → 07/96
2.2 (B541)	Petrol	79	04/92 → 07/96
2.2 (B543)	Petrol	101	04/92 → 07/96
3.0 V6 (B54B, B544)	Petrol	123	12/92 → 07/96

APS45

KW

RENAULT
SAFRANE I (B54_)

3.0 V6 (B54M)	Petrol	123	07/96 → 12/00
---------------	--------	-----	---------------

SUPER 5 (B/C40_)

1.7 (B/C408)	Petrol	54	10/86 → 03/95
1.7 i (C409)	Petrol	69	10/86 → 08/91

TRAFIC Autobus (TXW)

2.2	Petrol	70	05/89 → 06/94
2.2	Petrol	74	06/94 → 10/97
2.2 4x4	Petrol	70	05/89 → 06/94
2.2 4x4	Petrol	74	06/94 → 10/97

TRAFIC Furgonato (TXX)

2.2 4x4	Petrol	70	05/89 → 06/94
2.2 4x4	Petrol	74	06/94 → 10/97

TWINGO I (C06_)

1.2 (C063, C064)	Petrol	40	03/93 → 10/96
------------------	--------	----	---------------

TWINGO I Furgonato (S06_)

1.2 (S063, S064)	Petrol	40	03/93 → 05/96
1.2 (S066, S068)	Petrol	43	05/96 → 12/99

VOLVO
440 K (445)

1.7	Petrol	75	08/89 → 12/96
1.7	Petrol	78	09/88 → 12/96
1.8	Petrol	66	08/91 → 07/96
2.0	Petrol	80	08/93 → 07/96
2.0	Petrol	81	08/92 → 07/95

460 L (464)

1.7	Petrol	75	08/89 → 07/92
1.8	Petrol	66	08/91 → 07/96
2.0	Petrol	80	08/93 → 07/96
2.0	Petrol	81	08/92 → 07/95

480 E

1.7	Petrol	75	08/89 → 07/96
1.7	Petrol	78	04/86 → 07/89
1.7	Petrol	80	08/86 → 07/88
2.0	Petrol	81	08/92 → 09/95

850 (LS)

2.0	Petrol	93	08/94 → 12/96
2.5	Petrol	106	08/94 → 12/96
2.5	Petrol	103	06/91 → 07/94

850 Station wagon (LW)

2.0	Petrol	93	08/94 → 12/96
2.5	Petrol	103	08/92 → 07/94

S40 I (VS)

1.8	Petrol	85	07/95 → 08/99
-----	--------	----	---------------

APS45

VOLVO
S70 (LS)

2.5 Bifuel	Petrol/ CNG	106	10/98 → 11/00
------------	----------------	-----	---------------

V40 Station wagon (VW)

1.6	Petrol	80	03/99 → 06/04
1.8	Petrol	85	07/95 → 08/99
1.8	Petrol	90	03/99 → 06/04

V70 I (LV)

2.5 Bifuel	BiFuel	106	10/98 → 08/99
------------	--------	-----	---------------

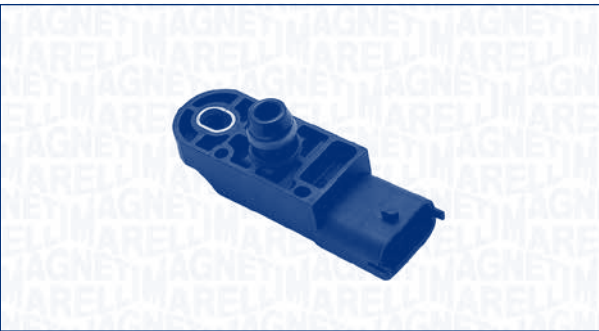
APS46
**SENSORE PRESSIONE ASSOLUTA
MAP SENSOR**

RENAULT
GRAND SCÉNIC II (JM0/1_)

2.0 dCi (JM1K)	Diesel	110	09/05 →
----------------	--------	-----	---------

LAGUNA Coupé (DT0/1)

2.0 dCi	Diesel	127	09/08 →
---------	--------	-----	---------

2.0 dCi (DT01, DT09, DT12, DT1D)	Diesel	110	09/08 →
--	--------	-----	---------

2.0 dCi GT (DT11, DT1E, DT1N)	Diesel	131	09/08 →
-------------------------------------	--------	-----	---------

3.0 dCi	Diesel	177	01/12 →
---------	--------	-----	---------

LAGUNA II (BG0/1_)

2.0 dCi (BG14, BG1S)	Diesel	127	01/06 →
-------------------------	--------	-----	---------

2.0 dCi (BG1T)	Diesel	110	08/05 →
----------------	--------	-----	---------

LAGUNA II Grandtour (KG0/1_)

2.0 dCi (KG1S)	Diesel	127	01/06 →
----------------	--------	-----	---------

2.0 dCi (KG1T)	Diesel	110	08/05 →
----------------	--------	-----	---------

APS46

RENAULT
LAGUNA III (BT0/1)

2.0 dCi (BT01, BT09, BT12, BT1S)	Diesel	110	10/07 →
--	--------	-----	---------

2.0 dCi (BT08, BT0K, BT0J, BT14, BT1A, BT1D)	Diesel	96	10/07 →
---	--------	----	---------

2.0 dCi (BT0M, BT0N, BT19)	Diesel	127	01/08 →
-------------------------------	--------	-----	---------

2.0 dCi GT (BT1E, BT1N)	Diesel	131	03/08 →
----------------------------	--------	-----	---------

3.0 dCi (BT03, BT13)	Diesel	173	09/08 →
-------------------------	--------	-----	---------

LAGUNA III Sportour (KT0/1)

2.0 dCi (KT01, KT08, KT0K, KT0J, KT1A, KT1D)	Diesel	96	10/07 →
---	--------	----	---------

2.0 dCi (KT01, KT09, KT12, KT1S)	Diesel	110	10/07 →
--	--------	-----	---------

2.0 dCi (KT0M, KT0N, KT19)	Diesel	127	01/08 →
-------------------------------	--------	-----	---------

2.0 dCi GT (KT11, KT1E, KT1N)	Diesel	131	03/08 →
-------------------------------------	--------	-----	---------

3.0 dCi (KT03, KT13)	Diesel	173	09/08 →
-------------------------	--------	-----	---------

MEGANE II (BM0/1_, CM0/1_)

2.0 dCi	Diesel	127	01/07 →
---------	--------	-----	---------

2.0 dCi (BM1K, CM1K)	Diesel	110	09/05 →
-------------------------	--------	-----	---------

MEGANE II Coupé-Cabriolet (EM0/1_)

2.0 dCi	Diesel	110	09/05 →
---------	--------	-----	---------

MEGANE II Station wagon (KM0/1_)

2.0 dCi	Diesel	110	09/05 →
---------	--------	-----	---------

SCÉNIC II (JM0/1_)

2.0 dCi (JM1K)	Diesel	110	09/05 →
----------------	--------	-----	---------

VEL SATIS (BJ0_)

2.0 dCi (BJ03)	Diesel	110	08/05 →
----------------	--------	-----	---------

2.0 dCi (BJ03, BJ0B)	Diesel	127	01/06 →
-------------------------	--------	-----	---------

APS47

**SENSORE PRESSIONE ASSOLUTA
MAP SENSOR**



CITROËN

C4 Coupé (LA_)

1.6 THP 150 Petrol 110 07/08 →

C4 Grand Picasso I (UA_)

1.6 16V Petrol 103 07/08 →

1.6 16V Petrol 110 10/08 →

C4 I (LC_)

1.6 THP 140 Petrol 103 07/08 →

1.6 THP 150 Petrol 110 07/08 →

C4 Picasso I (UD_)

1.6 16V Petrol 110 07/08 →

1.6 THP 140 Petrol 103 07/08 →

C5 III (RD_)

1.6 THP 155 Petrol 115 04/09 →

C5 III Break (TD_)

1.6 THP 155 Petrol 115 04/09 →

DS3

1.6 Racing Petrol 149 02/11 →

1.6 Racing Petrol 152 02/11 →

1.6 THP 155 Petrol 115 04/10 →

MINI

MINI (R56)

Cooper S Petrol 128 10/06 →

MINI Cabriolet (R57)

Cooper S Petrol 128 03/09 →

MINI CLUBMAN (R55)

Cooper S Petrol 128 10/07 →

PEUGEOT

207 (WA_, WC_)

1.6 16V RC Petrol 128 02/07 →

1.6 16V Turbo Petrol 110 02/06 →

1.6 16V Turbo Petrol 115 10/09 →

207 CC (WD_)

1.6 16V Turbo Petrol 110 02/07 →

1.6 16V Turbo Petrol 115 10/09 →

APS47



PEUGEOT

207 SW (WK_)

1.6 16V RC Petrol 128 02/07 →

3008

1.6 THP Petrol 110 06/09 →

1.6 THP Petrol 115 06/09 →

308 (4A_, 4C_)

1.6 16V Petrol 103 09/07 →

1.6 16V Petrol 110 09/07 →

1.6 16V Petrol 128 03/08 →

308 CC

1.6 16V Petrol 103 06/09 →

1.6 16V Petrol 110 06/09 →

308 SW

1.6 16V Petrol 103 09/07 →

1.6 16V Petrol 110 09/07 →

1.6 16V Petrol 128 03/08 →

5008

1.6 16V Petrol 115 09/09 →

RCZ

1.6 16V Petrol 115 03/10 →

APS48

**SENSORE PRESSIONE ASSOLUTA
MAP SENSOR**

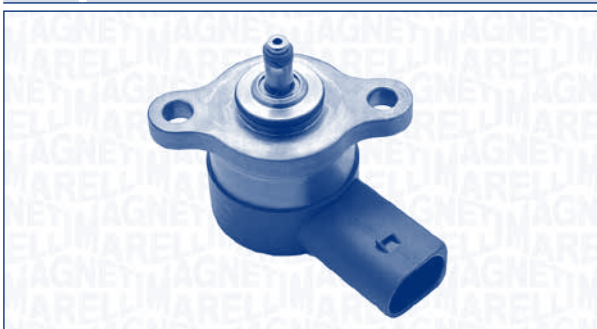

MERCEDES-BENZ

SPRINTER 2-t Autobus (901, 902)

208 CDI Diesel 60 04/00 → 05/06 ENGINE: → 835761

211 CDI Diesel 80 04/00 → 05/06 ENGINE: → 835761

213 CDI Diesel 95 04/00 → 05/06 ENGINE: → 835761

SPRINTER 2-t Furgonato (901, 902)

208 CDI Diesel 60 04/00 → 05/06 ENGINE: → 835761

211 CDI Diesel 80 04/00 → 05/06 ENGINE: → 835761

APS48

MERCEDES-BENZ
SPRINTER 2-t Pianale piatto/Telaio (901, 902)

208 CDI	Diesel	60	04/00 → 05/06	ENGINE: → 835761
211 CDI	Diesel	80	04/00 → 05/06	ENGINE: → 835761
213 CDI	Diesel	95	04/00 → 05/06	ENGINE: → 835761

SPRINTER 3-t Autobus (903)

308 CDI	Diesel	60	04/00 → 05/06	ENGINE: → 835761
311 CDI	Diesel	80	04/00 → 05/06	ENGINE: → 835761
311 CDI 4x4	Diesel	80	08/02 → 05/06	ENGINE: → 835761
313 CDI	Diesel	95	04/00 → 05/06	ENGINE: → 835761
313 CDI 4x4	Diesel	95	08/02 → 05/06	ENGINE: → 835761

SPRINTER 3-t Furgonato (903)

308 CDI	Diesel	60	04/00 → 05/06	ENGINE: → 835761
311 CDI	Diesel	80	04/00 → 05/06	ENGINE: → 835761
311 CDI 4x4	Diesel	80	08/02 → 05/06	ENGINE: → 835761
313 CDI	Diesel	95	04/00 → 05/06	ENGINE: → 835761
313 CDI 4x4	Diesel	95	08/02 → 05/06	ENGINE: → 835761

SPRINTER 3-t Pianale piatto/Telaio (903)

308 CDI	Diesel	60	04/00 → 05/06	ENGINE: → 835761
311 CDI	Diesel	80	04/00 → 05/06	ENGINE: → 835761
311 CDI 4x4	Diesel	80	08/02 → 05/06	ENGINE: → 835761
313 CDI	Diesel	95	04/00 → 05/06	ENGINE: → 835761
313 CDI 4x4	Diesel	95	08/02 → 05/06	ENGINE: → 835761

SPRINTER 4-t Autobus (904)

408 CDI	Diesel	60	04/00 → 05/06	ENGINE: → 835761
411 CDI	Diesel	80	04/00 → 05/06	ENGINE: → 835761
413 CDI	Diesel	95	04/00 → 05/06	ENGINE: → 835761

SPRINTER 4-t Furgonato (904)

408 CDI	Diesel	60	04/00 → 05/06	ENGINE: → 835761
411 CDI	Diesel	80	04/00 → 05/06	ENGINE: → 835761
411 CDI 4x4	Diesel	80	04/00 → 05/06	ENGINE: → 835761
413 CDI	Diesel	95	04/00 → 05/06	ENGINE: → 835761
413 CDI 4x4	Diesel	95	04/00 → 05/06	ENGINE: → 835761

SPRINTER 4-t Pianale piatto/Telaio (904)

408 CDI	Diesel	60	04/00 → 05/06	ENGINE: → 835761
411 CDI	Diesel	80	04/00 → 05/06	ENGINE: → 835761
411 CDI 4x4	Diesel	80	04/00 → 05/06	ENGINE: → 835761
413 CDI	Diesel	95	04/00 → 05/06	ENGINE: → 835761
413 CDI 4x4	Diesel	95	04/00 → 05/06	ENGINE: → 835761

APS49
**SENSORE PRESSIONE ASSOLUTA
MAP SENSOR**

OPEL
ASTRA GTC J

2.0 CDTi	Diesel	121	10/11 →	
----------	--------	-----	---------	--

ASTRA J

1.3 CDTi	Diesel	70	12/09 →	
2.0 CDTi	Diesel	118	12/09 →	
2.0 CDTi	Diesel	121	06/11 →	

ASTRA J Sports Tourer

1.3 CDTi	Diesel	70	10/10 →	
2.0 CDTi	Diesel	118	10/10 →	
2.0 CDTi	Diesel	121	08/11 →	

CORSA D

1.3 CDTi	Diesel	70	06/10 →	
----------	--------	----	---------	--

CORSA D Van

1.3 CDTi	Diesel	70	06/10 →	
----------	--------	----	---------	--

INSIGNIA

2.0 CDTi	Diesel	118	07/08 →	
2.0 CDTi	Diesel	81	07/08 →	
2.0 CDTi	Diesel	96	07/08 →	
2.0 CDTi 4x4	Diesel	118	06/10 →	

INSIGNIA Sports Tourer

2.0 CDTi	Diesel	118	07/08 →	
2.0 CDTi	Diesel	81	07/08 →	
2.0 CDTi	Diesel	96	07/08 →	
2.0 CDTi 4x4	Diesel	118	06/10 →	

INSIGNIA Tre volumi

2.0 CDTi	Diesel	118	07/08 →	
2.0 CDTi	Diesel	81	07/08 →	
2.0 CDTi	Diesel	96	07/08 →	
2.0 CDTi 4x4	Diesel	118	06/10 →	

MERIVA B

1.3 CDTi	Diesel	70	06/10 →	
----------	--------	----	---------	--

SAAB
9-5 (YS3G)

2.0 TiD	Diesel	118	05/10 →	
---------	--------	-----	---------	--

APS50

**SENSORE PRESSIONE ASSOLUTA
MAP SENSOR**



KW



FIAT

DUCATO Autobus (244, Z_)

2.8 JTD	Diesel	94	04/02 →
2.8 JTD 4x4	Diesel	94	07/02 →

DUCATO Furgonato (244)

2.3 JTD	Diesel	81	04/02 →
2.8 JTD	Diesel	94	04/02 →
2.8 JTD 4x4	Diesel	94	07/02 →
2.8 JTD Power	Diesel	107	05/04 →

DUCATO Pianale piatto/Telaio (244)

2.3 JTD	Diesel	81	04/02 → 07/06
2.8 JTD	Diesel	94	04/02 → 07/06
2.8 JTD 4x4	Diesel	94	10/02 → 07/06
2.8 JTD Power	Diesel	107	05/04 → 07/06

IVECO

DAILY III Cassone / Furgonato / Promiscuo

29 L 10 V (ALJA43A2, ALJA42A2, ALJA41A2)	Diesel	70	09/02 →
29 L 12 V (ALKA41A2, ALLA52A2, ALKA42A2)	Diesel	85	09/02 →
29 L 13	Diesel	92	05/01 →
29 L 14	Diesel	100	01/05 → 04/06
29 L 9 V	Diesel	66	11/01 → 04/06
35 C 12 V, 35 S 12 V (AGKA43A2, AGKB43A2, AGKB46A2...)	Diesel	85	09/02 →
35 C 14, 35 S 14	Diesel	100	01/05 → 04/06

APS50



KW



IVECO

DAILY III Cassone / Furgonato / Promiscuo

35 S 10 (ANJA41A1, ANJA42A2, ANJA42AB, ANJA43A, ANJAV1A...)	Diesel	70	09/02 →
35 S 13 V,35 C 13 V	Diesel	92	05/99 →
35 S 15 V, 35 C 15 V (A6HCV3B2, A6HBV4B2, A6HC41B2...)	Diesel	107	11/02 →
35 S 9 V	Diesel	66	11/01 → 04/06
40 C 13	Diesel	92	05/99 → 04/06
40 C 15	Diesel	107	11/01 → 04/06
50 C 13	Diesel	92	05/99 →
50 C 15	Diesel	107	01/01 → 04/06
65 C 15	Diesel	107	11/01 → 04/06

DAILY III Pianale piatto/Telaio

29 L 10 (ALJAV1A1, ALJA41AA, ALJA41A1, AHJA64A1...)	Diesel	70	09/02 →
29 L 12 (ALKA41A1, AHKA64A1, ALLA51A1)	Diesel	85	09/02 →
29 L 13	Diesel	92	11/01 →
29 L 14 (AHRA11C1B1, AHRA14C1B1, AHRA64C1B1)	Diesel	100	11/05 →
29 L 9	Diesel	66	11/01 → 04/06
35 C 10 V, 35 S 10 V (AMJA11A1, AMJA14A1, AMJA64A1...)	Diesel	70	09/02 →
35 C 12, 35 S 12 (AEKA14A1, AEKA14AA, AEKA64A1...)	Diesel	85	09/02 →
35 C 14, 35 S 14	Diesel	100	01/05 → 04/06
35 C 15	Diesel	107	11/01 →
35 C 9, 35 S 9	Diesel	66	11/01 → 04/06
35 S 13,35 C 13	Diesel	92	05/99 →

APS50

KW

IVECO
DAILY III Pianale piatto/Telaio

40 C 13	Diesel	92	05/99 → 04/06
40 C 15	Diesel	107	11/01 → 04/06
50 C 13	Diesel	92	05/99 →
50 C 15	Diesel	107	01/01 →
65 C 15	Diesel	107	11/01 →

APS51
**SENSORE PRESSIONE ASSOLUTA
MAP SENSOR**

KW

RENAULT
CLIO II (BB0/1/2_, CB0/1/2_)

1.5 dCi	Diesel	74	01/04 →
---------	--------	----	---------

GRAND SCÉNIC II (JM0/1_)

1.5 dCi (JM02, JM13)	Diesel	74	04/04 →
----------------------	--------	----	---------

MASTER II Autobus (JD)

2.5 dCi 100 (JDCV)	Diesel	73	10/03 → 10/06
--------------------	--------	----	---------------

MASTER II Furgonato (FD)

2.5 dCi 100 (FD0U, FD0V)	Diesel	73	10/03 → 10/06
--------------------------	--------	----	---------------

MASTER II Pianale piatto/Telaio (ED/HD/UD)

2.5 dCi 100 (ED4V, ED8V)	Diesel	73	10/03 → 10/06
--------------------------	--------	----	---------------

MEGANE II (BM0/1_, CM0/1_)

1.5 dCi (BM0F, CM0F)	Diesel	60	11/02 →
----------------------	--------	----	---------

MEGANE II Station wagon (KM0/1_)

1.5 dCi	Diesel	60	08/03 →
---------	--------	----	---------

MEGANE II Tre volumi (LM0/1_)

1.5 dCi	Diesel	60	09/03 →
---------	--------	----	---------

APS51

KW

RENAULT
SCÉNIC II (JM0/1_)

1.5 dCi (JM02, JM13)	Diesel	74	11/03 →
1.5 dCi (JM0F)	Diesel	60	06/03 → 12/06
1.5 dCi (JM1E)	Diesel	78	05/05 →
1.5 dCi (JM1F)	Diesel	63	05/05 → 12/06

APS53
**SENSORE PRESSIONE ASSOLUTA
MAP SENSOR**

KW

OPEL
ASTRA G 2 volumi /Coda spiovente (F48_, F08_)

1.7 CDTI	Diesel	59	04/03 → 01/04	ENGINE: Z17DTL
----------	--------	----	---------------	----------------

ASTRA G Station wagon (F35_)

1.7 CDTI	Diesel	59	04/03 → 07/09	ENGINE: Z17DTL
----------	--------	----	---------------	----------------

ASTRA G Tre volumi (F69_)

1.7 CDTI	Diesel	59	04/03 → 01/04	ENGINE: Z17DTL
----------	--------	----	---------------	----------------

ASTRA H (L48)

1.7 CDTI	Diesel	59	03/04 → 09/05	ENGINE: Z17DTL
----------	--------	----	---------------	----------------

1.7 CDTI	Diesel	74	03/04 → 08/07	ENGINE: Z17DTH
----------	--------	----	---------------	----------------

ASTRA H GTC (L08)

1.7 CDTI	Diesel	59	03/05 → 03/07	ENGINE: Z17DTL
----------	--------	----	---------------	----------------

1.7 CDTI	Diesel	74	09/05 → 05/07	ENGINE: Z17DTH
----------	--------	----	---------------	----------------

ASTRA H Station wagon (L35)

1.7 CDTI	Diesel	59	08/04 → 09/05	ENGINE: Z17DTL
----------	--------	----	---------------	----------------

1.7 CDTI	Diesel	74	08/04 → 03/07	ENGINE: Z17DTH
----------	--------	----	---------------	----------------

ASTRA H Van (L70)

1.7 CDTI	Diesel	74	08/04 → 03/07	ENGINE: Z17DTH
----------	--------	----	---------------	----------------

COMBO Cassone / Furgonato / Promiscuo

1.7 CDTI 16V	Diesel	74	12/04 → 01/11	ENGINE: Z17DTH
--------------	--------	----	---------------	----------------

COMBO Tour

1.7 CDTI 16V	Diesel	74	12/04 → 01/11	ENGINE: Z17DTH
--------------	--------	----	---------------	----------------

CORSA C (F08, F68)

1.7 CDTI	Diesel	74	09/03 → 09/06	ENGINE: Z17DTH
----------	--------	----	---------------	----------------

APS53



OPEL

CORSA C Furgonato (F08, W5L)

1.7 CDTI Diesel 74 09/03 → 09/06 ENGINE: Z17DTH

MERIVA

1.7 CDTI Diesel 74 09/03 → 09/09 ENGINE: Z17DTH,Z17DT

VAUXHALL

ASTRA Mk IV (G) 2 volumi /Coda spiovente

1.7 CDTI 16V Diesel 59 04/03 → 05/05 ENGINE: Z17DTL

ASTRA Mk IV (G) Station wagon

1.7 CDTI 16V Diesel 59 04/03 → 05/05 ENGINE: Z17DTL

ASTRA Mk IV (G) Tre volumi

1.7 CDTI 16V Diesel 59 04/03 → 05/05 ENGINE: Z17DTL

ASTRA Mk V (H) 2 volumi /Coda spiovente

1.7 CDTI Diesel 59 03/04 → 03/07 ENGINE: Z17DTL

1.7 CDTI Diesel 74 03/04 → 03/07 ENGINE: Z17DTH

ASTRA Mk V (H) Sport Hatch

1.7 CDTI Diesel 74 06/05 → 03/07 ENGINE: Z17DTH

ASTRA Mk V (H) Station wagon

1.7 CDTI Diesel 74 08/04 → 03/07 ENGINE: Z17DTH

ASTRAVAN Mk IV (G)

1.7 CDTI Diesel 59 04/04 → 08/05 ENGINE: Z17DTL

ASTRAVAN Mk V (H)

1.7 CDTI Diesel 59 03/05 → 07/06 ENGINE: Z17DTL

1.7 CDTI Diesel 74 03/05 → 03/07 ENGINE: Z17DTH

COMBO Mk II (C) Cassone / Furgonato / Promiscuo (F25)

1.7 CDTI 16V Diesel 74 12/04 → 11/11 ENGINE: Z17DTH

COMBO TOUR Mk II (C) (F25)

1.7 CDTI 16V Diesel 74 12/04 → 09/10 ENGINE: Z17DTH

CORSA Mk II (C) (W5L, F08)

1.7 CDTI 16V Diesel 74 09/03 → 08/05 ENGINE: Z17DTH

MERIVA Mk I (A)

1.7 CDTI 16V Diesel 74 09/03 → 08/05 ENGINE: Z17DTH

APS54

**SENSORE PRESSIONE ASSOLUTA
MAP SENSOR**



HYUNDAI

ACCENT I (X-3)

1.5 i 16V Petrol 73 12/95 → 01/00

ACCENT Tre volumi (X-3)

1.5 i 16V Petrol 73 10/95 → 01/00

APS55

**SENSORE PRESSIONE ASSOLUTA
MAP SENSOR**



ALFA ROMEO

156 (932)

2.0 JTS (932AXA) Petrol 122 03/02 → 09/05

156 Sportwagon (932)

2.0 JTS (932BXA) Petrol 122 03/02 → 05/06

LANCIA

THESIS (841AX)

2.0 Turbo (841AXA1B03) Petrol 136 07/02 → 07/09

APS56
**SENSORE PRESSIONE ASSOLUTA
MAP SENSOR**

KIA
RIO Tre volumi (DC_)

1.3	Petrol	55	09/00 → 02/05
1.5 16V	Petrol	72	09/00 → 02/05

SHUMA II (FB)

1.6	Petrol	75	05/01 → 08/04
-----	--------	----	---------------

SHUMA II Tre volumi (FB)

1.6	Petrol	75	05/01 → 05/04
-----	--------	----	---------------

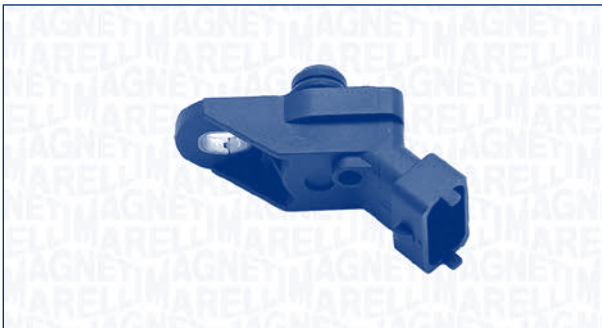
APS57
**SENSORE PRESSIONE ASSOLUTA
MAP SENSOR**

LAND ROVER
RANGE ROVER III (LM)

3.0 TD 6 4x4	Diesel	130	03/02 → 08/12
--------------	--------	-----	---------------

APS58
**SENSORE PRESSIONE ASSOLUTA
MAP SENSOR**

FIAT
ULYSSE (179AX)

2.2 D Multijet	Diesel	125	03/08 → 06/11
----------------	--------	-----	---------------

FORD
GALAXY (WA6)

2.2 TDCi	Diesel	129	03/08 →
----------	--------	-----	---------

MONDEO IV (BA7)

2.2 TDCi	Diesel	129	03/08 →
----------	--------	-----	---------

MONDEO IV Tre volumi (BA7)

2.2 TDCi	Diesel	129	03/08 →
----------	--------	-----	---------

MONDEO IV Turnier (BA7)

2.2 TDCi	Diesel	129	03/08 →
----------	--------	-----	---------

S-MAX (WA6)

2.2 TDCi	Diesel	129	03/08 →
----------	--------	-----	---------

LANCIA
PHEDRA (179)

2.2 D Multijet	Diesel	125	03/08 → 11/10
----------------	--------	-----	---------------

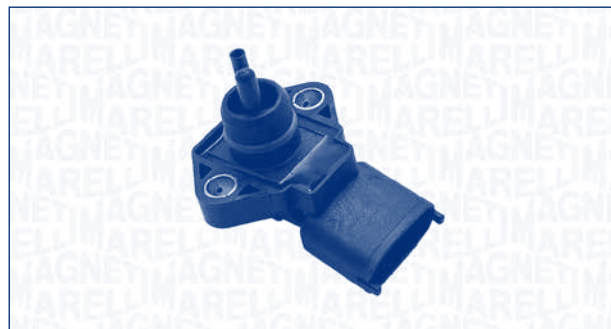
APS59
**SENSORE PRESSIONE ASSOLUTA
MAP SENSOR**

FIAT
BRAVA (182)

1.2 16V 80	Petrol	60	12/98 → 12/02
------------	--------	----	---------------

APS59



FIAT

BRAVO I (182)

1.2 16V 80 Petrol 60 12/98 → 10/00

MAREA (185)

1.2 16V Petrol 60 03/99 → 05/02

MAREA Weekend (185)

1.2 16V Petrol 60 03/99 → 05/02

APS60

**SENSORE PRESSIONE ASSOLUTA
MAP SENSOR**



MERCEDES-BENZ

CLASSE C (W203)

C 32 AMG Kompressor (203.065) Petrol 260 02/01 → 02/07

CLASSE C T-Model (S203)

C 32 AMG Kompressor (203.265) Petrol 260 03/01 → 08/07

CLASSE S Coupé (C215)

CL 55 AMG Kompressor (215.374) Petrol 368 06/02 → 03/06

SL (R230)

55 AMG (230.474) Petrol 350 10/01 → 06/02

55 AMG Kompressor (230.474) Petrol 368 06/02 → 01/12

600 (230.476) Petrol 368 04/03 → 01/12

APS60



MERCEDES-BENZ

SLK (R170)

200 Kompressor (170.444) Petrol 120 03/00 → 04/04

230 Kompressor (170.449) Petrol 145 03/00 → 04/04

32 AMG Kompressor (170.466) Petrol 260 03/01 → 04/04

APS61

**SENSORE PRESSIONE ASSOLUTA
MAP SENSOR**



MINI

MINI (R50, R53)

Cooper S Petrol 120 03/02 → 09/06

Works Petrol 155 11/03 → 09/06

MINI Cabriolet (R52)

Cooper Petrol 85 07/04 → 11/07

Cooper S Petrol 125 07/04 → 11/07

John Cooper Works Petrol 155 07/04 → 11/07

One Petrol 66 07/04 → 11/07

ROVER

75 (RJ)

1.8 Turbo Petrol 110 05/03 → 05/05

75 Tourer (RJ)

1.8 Turbo Petrol 110 05/03 → 05/05

APS62
**SENSORE PRESSIONE ASSOLUTA
MAP SENSOR**

CITROËN
C4 Coupé (LA_)

2.0 16V Petrol 100 11/04 →

C4 I (LC_)

2.0 16V Petrol 100 11/04 →

C5 I (DC_)

2.0 16V HPi (DCRLZB) Petrol 103 03/01 → 08/04

3.0 V6 (DCXFXC, DCXFXF) Petrol 152 03/01 → 08/04

C5 I Break (DE_)

2.0 16V HPi (DERLZB) Petrol 103 06/01 → 08/04

3.0 V6 (DEXFXC, DEXFXF) Petrol 152 06/01 → 08/04

C5 II (RC_)

3.0 V6 (RCXFUF) Petrol 152 09/04 →

C5 II Break (RE_)

3.0 V6 (REXFUF) Petrol 152 09/04 →

C6 (TD_)

3.0 V6 Petrol 155 11/05 →

C8 (EA_, EB_)

2.0 Petrol 100 07/02 →

3.0 V6 Petrol 150 10/02 →

XSARA PICASSO (N68)

2.0 16V Petrol 100 01/03 →

FIAT
ULYSSE (179AX)

2.0 Petrol 100 08/02 → 06/11

3.0 Petrol 150 08/02 → 06/11

LANCIA
PHEDRA (179)

2.0 (179AXA11) Petrol 100 09/02 → 11/10

3.0 V6 Petrol 150 09/02 → 11/10

APS62

PEUGEOT
307 CC (3B)

2.0 16V Petrol 100 10/03 → 05/05

406 (8B)

3.0 V6 Petrol 152 03/00 → 05/04

406 Break (8E/F)

3.0 V6 Petrol 152 03/00 → 06/04

406 Coupé (8C)

3.0 V6 Petrol 152 03/00 → 12/04

407 (6D_)

3.0 Petrol 155 05/04 →

407 Coupé (6C_)

3.0 V6 Petrol 155 10/05 →

407 SW (6E_)

3.0 Petrol 155 05/04 →

607 (9D, 9U)

3.0 V6 24V Petrol 152 02/00 → 11/04

3.0 V6 24V Petrol 155 12/04 →

807 (E)

2.0 Petrol 100 06/02 →

3.0 V6 Petrol 150 06/02 →

RENAULT
AVANTIME (DE0_)

3.0 V6 (DE04, DE0T) Petrol 152 09/01 → 05/03

CLIO II (BB0/1/2_, CB0/1/2_)

3.0 V6 Sport (CB1A) Petrol 166 11/00 → 12/02

3.0 V6 Sport (CB1H, CB1U, CB2S) Petrol 187 12/02 →

LAGUNA II (BG0/1_)

3.0 V6 24V (BG01, BG02, BG0D, BG0Y) Petrol 152 03/01 →

LAGUNA II Grandtour (KG0/1_)

3.0 V6 24V (KG0D) Petrol 152 03/01 →

APS63

**SENSORE PRESSIONE ASSOLUTA
MAP SENSOR**



ALFA ROMEO

GIULIETTA (940)

1.6 JTDM	Diesel	77	04/10 →
2.0 JTDM	Diesel	125	04/10 →

FIAT

DOBLO Cassone / Furgonato / Promiscuo (263)

1.6 D Multijet	Diesel	74	02/10 →
2.0 D Multijet	Diesel	99	02/10 →

DOBLO Combi (152, 263)

1.6 D Multijet	Diesel	77	02/10 →
2.0 D Multijet	Diesel	99	02/10 →

PUNTO EVO (199)

1.3 D Multijet	Diesel	55	10/09 → 02/12
1.3 D Multijet	Diesel	66	10/09 → 02/12
1.6 D Multijet	Diesel	88	10/09 → 02/12

APS64

**SENSORE PRESSIONE ASSOLUTA
MAP SENSOR**



CHRYSLER

VOYAGER III (GS)

2.5 TD	Diesel	85	01/95 → 03/01
--------	--------	----	---------------

APS64



DODGE

CARAVAN

2.5 TD	Diesel	85	01/95 → 03/01
--------	--------	----	---------------

LAND ROVER

DEFENDER Cabrio (LD)

2.5 Td5 4x4	Diesel	90	06/98 →
-------------	--------	----	---------

DEFENDER Pick-up (LD_)

2.5 Td5 4x4	Diesel	90	06/98 →
-------------	--------	----	---------

DEFENDER Station Wagon (LD)

2.5 Td5 4x4	Diesel	90	06/98 →
-------------	--------	----	---------

DISCOVERY II (LJ, LT)

2.5 Td5 4x4	Diesel	102	01/99 → 06/04
-------------	--------	-----	---------------

APS65

**SENSORE PRESSIONE ASSOLUTA
MAP SENSOR**

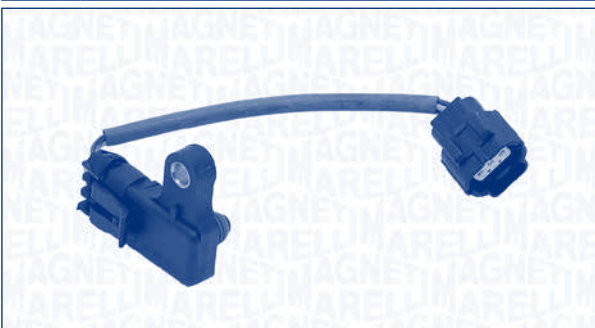

CHEVROLET

CAPTIVA (C100, C140)

2.0 D	Diesel	110	09/07 →
-------	--------	-----	---------

EPICA (KL1_)

2.0	Petrol	94	01/05 → 12/06
2.0	Petrol	98	01/05 → 12/06

EVANDA

2.0	Petrol	96	03/05 →
-----	--------	----	---------

LACETTI (J200)

1.4 16V	Petrol	70	03/05 →
1.6	Petrol	80	03/05 →
1.8	Petrol	89	08/05 →
1.8	Petrol	90	03/05 →
2.0 D	Diesel	89	01/07 →

NUBIRA Tre volumi

1.6	Petrol	80	03/05 →
1.8	Petrol	90	03/05 →

APS67
**SENSORE PRESSIONE ASSOLUTA
MAP SENSOR**

RENAULT
GRAND SCÉNIC II (JM0/1_)

1.9 dCi (JM14) Diesel 96 05/05 →

LAGUNA II (BG0/1_)

1.9 dCi (BG1A, BG1V) Diesel 96 05/05 →

LAGUNA II Grandtour (KG0/1_)

1.9 dCi (KG1V) Diesel 96 05/05 →

MEGANE II (BM0/1_, CM0/1_)

1.9 dCi Diesel 81 05/05 →

1.9 dCi Diesel 96 05/05 →

MEGANE II Coupé-Cabriolet (EM0/1_)

1.9 dCi Diesel 81 05/05 →

1.9 dCi Diesel 96 05/05 →

MEGANE II Station wagon (KM0/1_)

1.9 dCi Diesel 81 05/05 →

1.9 dCi Diesel 96 05/05 →

MEGANE II Tre volumi (LM0/1_)

1.9 dCi Diesel 96 05/05 →

1.9 dCi (LM14, LM1D) Diesel 81 05/05 →

SCÉNIC II (JM0/1_)

1.9 dCi (JM14) Diesel 96 05/05 →

1.9 dCi (JM15) Diesel 81 05/05 →

SUZUKI
GRAND VITARA II (JT)

1.9 DDiS Diesel 95 10/05 →

APS69
**SENSORE PRESSIONE ASSOLUTA
MAP SENSOR**

LAND ROVER
FREELANDER (LN)

1.8 16V 4x4 Petrol 86 11/00 → 10/06

FREELANDER Soft Top

1.8 i 16V 4x4 Petrol 88 02/98 → 10/06

MG
MG TF

115 Petrol 85 03/02 →

120 Petrol 88 03/02 →

135 Petrol 100 03/02 →

160 Petrol 118 03/02 →

MG ZR

105 Petrol 76 06/01 → 04/05

120 Petrol 86 06/01 → 04/05

MG ZS

120 Petrol 86 07/01 → 04/05

180 Petrol 130 07/01 → 04/05

MG ZS Hatchback

120 Petrol 86 07/01 → 10/05

180 Petrol 130 07/01 → 10/05

MG ZT

160 Petrol 118 06/01 → 07/05

190 Petrol 140 06/01 → 07/05

MG ZT- T

160 Petrol 118 10/01 → 07/05

190 Petrol 140 10/01 → 07/05

MGF (RD)

1.8 i VVC Petrol 118 10/01 → 03/02

1.8 i 16V Petrol 88 03/95 → 03/02

1.8 i VVC Petrol 107 03/95 → 03/02

MINI
MINI (R50, R53)

Cooper Petrol 85 06/01 → 09/06

One Petrol 66 06/01 → 09/06

APS70

**SENSORE PRESSIONE ASSOLUTA
MAP SENSOR**



AUDI

A3 (8P1)

1.4 TFSI	Petrol	92	09/07 → 08/12
1.6	Petrol	75	05/03 → 08/12
1.6 FSI	Petrol	85	08/03 → 09/07
1.8 TFSI	Petrol	118	11/06 → 08/12
2.0 FSI	Petrol	110	05/03 → 06/08
2.0 TFSI	Petrol	147	09/04 → 08/12
2.0 TFSI quattro	Petrol	147	09/04 → 08/12
3.2 V6 quattro	Petrol	184	07/03 → 05/09

A3 Sportback (8PA)

1.4 TFSI	Petrol	92	09/07 → 03/13
1.6	Petrol	75	09/04 → 03/13
1.6 FSI	Petrol	85	09/04 → 09/07
1.8 TFSI	Petrol	118	11/06 → 03/13
2.0 FSI	Petrol	110	09/04 → 06/08
2.0 TFSI	Petrol	147	09/04 → 03/13
2.0 TFSI quattro	Petrol	147	09/04 → 03/13
3.2 V6 quattro	Petrol	184	09/04 → 05/09

VOLKSWAGEN

GOLF VI Variant (AJ5)

1.2 TSI	Petrol	77	08/09 → 07/13
1.4 TSI	Petrol	90	07/09 → 07/13

JETTA III (1K2)

2.0 FSI	Petrol	110	08/05 → 10/10
---------	--------	-----	---------------

MULTIVAN V (7HM, 7HN, 7HF, 7EF, 7EM, 7EN)

2.0 BiTDI	Diesel	132	09/09 →
2.0 BiTDI 4motion	Diesel	132	09/09 →
2.0 TDi	Diesel	103	09/09 →
2.0 TDi	Diesel	62	09/09 →
2.0 TDi	Diesel	75	09/09 →
2.0 TDi 4motion	Diesel	103	09/09 →

NEW BEETLE (9C1, 1C1)

2.5	Petrol	110	07/05 → 09/10
-----	--------	-----	---------------

APS70



VOLKSWAGEN

NEW BEETLE Cabriolet (1Y7)

2.5	Petrol	110	07/05 → 09/10
-----	--------	-----	---------------

PASSAT (3C2)

2.0 FSI 4motion	Petrol	110	09/05 → 07/10
2.0 TDI 16V 4motion	Diesel	103	03/05 → 08/10
2.0 TDI 4motion	Diesel	103	03/05 → 05/09
3.2 FSI 4motion	Petrol	184	11/05 → 07/10
3.6 R36 4motion	Petrol	220	04/07 → 07/10

PASSAT Variant (3C5)

2.0 FSI 4motion	Petrol	110	09/05 → 11/10
2.0 TDI 16V 4motion	Diesel	103	08/05 → 11/10
2.0 TDI 4motion	Diesel	103	08/05 → 05/09
3.2 FSI 4motion	Petrol	184	11/05 → 11/10
3.6 R36 4motion	Petrol	220	04/07 → 11/10

SCIROCCO (137, 138)

1.4 TSI	Petrol	118	05/08 →
2.0 R	Petrol	195	11/09 →
2.0 TDi	Diesel	103	08/08 →
2.0 TDi	Diesel	125	05/09 →
2.0 TSI	Petrol	147	05/08 → 11/09
2.0 TSI	Petrol	155	11/09 → 05/11

TRANSPORTER V Autobus (7HB, 7HJ, 7EB, 7EJ, 7EF)

2.0 BiTDI	Diesel	132	09/09 →
2.0 BiTDI 4motion	Diesel	132	09/09 →
2.0 TDi	Diesel	103	09/09 →
2.0 TDi	Diesel	62	09/09 →
2.0 TDi	Diesel	75	09/09 →
2.0 TDi 4motion	Diesel	103	09/09 →

TRANSPORTER V Furgonato (7HA, 7HH, 7EA, 7EH)

2.0 BiTDI	Diesel	132	09/09 →
2.0 BiTDI 4motion	Diesel	132	09/09 →
2.0 TDi	Diesel	103	09/09 →
2.0 TDi	Diesel	62	09/09 →
2.0 TDi	Diesel	75	09/09 →
2.0 TDi 4motion	Diesel	103	09/09 →

TRANSPORTER V Pianale piatto/Telaio (7JD, 7JE, 7JL, 7JY, 7JZ)

2.0 BiTDI	Diesel	132	09/09 →
2.0 BiTDI 4motion	Diesel	132	09/09 →
2.0 TDi	Diesel	103	09/09 →

APS70

VOLKSWAGEN
TRANSPORTER V Pianale piatto/Telaio (7JD, 7JE, 7JL, 7JY, 7JZ)

2.0 TDi	Diesel	62	09/09 →
2.0 TDi	Diesel	75	09/09 →
2.0 TDi 4motion	Diesel	103	09/09 →

APS71
**SENSORE PRESSIONE ASSOLUTA
MAP SENSOR**

CITROËN
BERLINGO (B9)

1.6 VTi 120	Petrol	88	11/09 →
-------------	--------	----	---------

C3 Picasso

1.4 VTi 95	Petrol	70	02/09 →
------------	--------	----	---------

1.6 VTi 120	Petrol	88	02/09 →
-------------	--------	----	---------

C4 Coupé (LA_)

1.6 VTi 120	Petrol	88	07/08 →
-------------	--------	----	---------

C4 Grand Picasso I (UA_)

1.6 VTi 120	Petrol	88	07/08 →
-------------	--------	----	---------

C4 I (LC_)

1.6 VTi 120	Petrol	88	07/08 →
-------------	--------	----	---------

C4 Picasso I (UD_)

1.6 VTi 120	Petrol	88	07/08 →
-------------	--------	----	---------

DS3

1.4 VTi 95	Petrol	70	04/10 →
------------	--------	----	---------

1.6 VTi 120	Petrol	88	04/10 →
-------------	--------	----	---------

MINI
MINI (R56)

Cooper	Petrol	88	10/06 →
--------	--------	----	---------

One	Petrol	55	03/09 →
-----	--------	----	---------

One	Petrol	70	03/07 →
-----	--------	----	---------

MINI Cabriolet (R57)

Cooper	Petrol	88	03/09 →
--------	--------	----	---------

APS71

MINI
MINI CLUBMAN (R55)

Cooper	Petrol	88	10/07 →
--------	--------	----	---------

PEUGEOT
207 (WA_, WC_)

1.4 16V	Petrol	70	06/07 →
---------	--------	----	---------

1.6 16V VTi	Petrol	88	02/07 →
-------------	--------	----	---------

207 CC (WD_)

1.6 16V	Petrol	88	02/07 →
---------	--------	----	---------

207 SW (WK_)

1.4 16V	Petrol	70	06/07 →
---------	--------	----	---------

1.6 16V	Petrol	88	06/07 →
---------	--------	----	---------

3008

1.6 VTi	Petrol	88	06/09 →
---------	--------	----	---------

308 (4A_, 4C_)

1.4 16V	Petrol	70	09/07 →
---------	--------	----	---------

1.4 16V	Petrol	72	12/09 →
---------	--------	----	---------

1.6 16V	Petrol	88	09/07 →
---------	--------	----	---------

308 CC

1.6 16V	Petrol	88	06/09 →
---------	--------	----	---------

308 SW

1.4 16V	Petrol	70	09/07 →
---------	--------	----	---------

1.4 16V	Petrol	72	12/09 →
---------	--------	----	---------

1.6 16V	Petrol	88	09/07 →
---------	--------	----	---------

5008

1.6 16V	Petrol	88	09/09 →
---------	--------	----	---------

RANCH

1.6	Petrol	88	04/10 →
-----	--------	----	---------

APS73
**SENSORE PRESSIONE ASSOLUTA
MAP SENSOR**

HONDA
ACCORD IV Coupé (CC1)

2.0 i 16V	Petrol	98	01/92 → 09/93
-----------	--------	----	---------------

APS73

KW

HONDA
ACCORD V (CE, CF)

2.2 i VTEC (CE9) Petrol 110 02/96 → 10/98

ACCORD V Aerodeck (CE)

2.0 i LS 16V (CE2) Petrol 100 09/93 → 02/98

2.2 i ES (CE1) Petrol 110 09/93 → 02/98

ACCORD V Coupé (CD7, CD9)

2.2 i ES (CD7) Petrol 110 09/93 → 02/98

ACCORD VI (CG, CK)

1.8 i Petrol 100 10/98 → 12/02

2.0 i Petrol 108 10/98 → 01/01

2.2 Type-R Petrol 156 02/99 → 12/02

2.3 (CK2) Petrol 113 01/01 → 06/03

ACCORD VI Coupé (CG)

2.0 i 16V Petrol 108 02/98 → 06/03

3.0 V6 24V Petrol 147 02/98 → 06/03

ACCORD VI Hatchback (CH)

1.8 i (CH6) Petrol 100 12/99 → 12/02

2.0 (CH7) Petrol 108 12/99 → 12/02

2.3 (CL4) Petrol 113 11/00 → 12/02

CIVIC IV Hatchback (EC, ED, EE)

1.5 i 16V Petrol 66 10/88 → 09/91

1.5 i 16V (ED6) Petrol 69 10/88 → 09/91

CIVIC IV Tre volumi (ED)

1.5 i 16V Petrol 66 10/87 → 09/91

1.5 i 16V (ED3) Petrol 69 10/87 → 09/91

CIVIC V Coupé (EJ)

1.5 i LSi (EJ2) Petrol 74 08/93 → 11/95

1.6 i (EJ6) Petrol 77 01/94 → 11/95

1.6 i Vtec (EJ1) Petrol 92 01/94 → 03/96

CIVIC V Hatchback (EG)

1.5 i 16V (EG4) Petrol 66 10/91 → 11/95

1.5 i 16V (EG4) Petrol 69 10/91 → 11/95

1.6 16V Vtec (EG5) Petrol 92 10/91 → 11/95

1.6 VTi 16V (EG6) Petrol 118 10/91 → 11/95

CIVIC V Tre volumi (EG, EH)

1.5 i 16V (EG8) Petrol 69 10/91 → 11/95

1.6 16V Vtec (EH9) Petrol 92 10/91 → 11/95

1.6 VTi (EG9) Petrol 118 10/91 → 11/95

APS73

KW

HONDA
CIVIC VI Aerodeck (MB, MC)

1.4 16V (MB8) Petrol 55 04/98 → 02/01

1.4 16V (MB8) Petrol 66 04/98 → 02/01

1.5 16V (MB9) Petrol 84 04/98 → 02/01

1.6 16V (MC1) Petrol 85 04/98 → 02/01

1.8 16V (MC2) Petrol 124 04/98 → 02/01

CIVIC VI Coupé (EJ, EM1)

1.6 i Petrol 77 03/96 → 03/00

1.6 i Vtec Petrol 92 03/96 → 03/00

CIVIC VI Fastback (MA, MB)

1.4 i (MA8, MB2) Petrol 55 09/95 → 02/01

1.4 i (MA8, MB2) Petrol 66 09/94 → 02/01

1.5 i Vtec-E (MA9) Petrol 66 09/94 → 01/97

1.6 i (MB1) Petrol 83 09/94 → 01/97

1.6 i Vtec (MB1) Petrol 93 09/94 → 01/97

1.6 VTi Petrol 118 01/97 → 02/01

CIVIC VI Hatchback (EJ, EK)

1.4 i (EJ9) Petrol 55 11/95 → 02/01

1.4 i S (EJ9) Petrol 66 11/95 → 02/01

1.5 i (EK3) Petrol 84 11/95 → 02/01

1.6 i (EK1) Petrol 84 11/95 → 02/01

1.6 VTi (EK4) Petrol 118 11/95 → 02/01

CIVIC VI Tre volumi (EJ, EK)

1.4 i (EJ9) Petrol 66 11/95 → 02/01

1.5 i (EK3) Petrol 84 11/95 → 02/01

1.6 i Vtec Petrol 92 11/95 → 02/01

1.6 VTi (EK4) Petrol 118 11/95 → 02/01

CR-V I (RD)

2.0 16V (RD1, RD3) Petrol 108 01/99 → 02/02

CRX II (ED, EE)

1.6 i 16V (ED9) Petrol 91 10/87 → 02/92

CRX III (EH, EG)

1.6 ESi (EH6) Petrol 92 03/92 → 12/98

1.6 i VTi (EG2) Petrol 118 03/92 → 12/98

HR-V (GH)

1.6 16V Petrol 77 03/99 →

1.6 16V 4WD Petrol 77 03/99 →

1.6 16V 4WD Petrol 91 10/99 →

INTEGRA Coupé (DC2, DC4)

1.8 Type-R Petrol 140 11/97 → 10/01

LOGO (GA3)

1.3 Petrol 48 03/99 → 03/02

APS73

KW

HONDA
PRELUDE IV (BB)

2.0 i 16V (BB3)	Petrol	98	02/92 → 09/96
2.2 16V	Petrol	147	10/96 → 10/00

S2000 (AP)

2.0	Petrol	177	06/99 →
-----	--------	-----	---------

SHUTTLE (RA)

2.2 16V	Petrol	110	10/94 → 02/98
2.3 16V	Petrol	110	10/97 → 06/04

ROVER
400 2 volumi /Coda spiovente (RT)

416 Si	Petrol	83	06/95 → 03/00
--------	--------	----	---------------

APS74
**SENSORE PRESSIONE ASSOLUTA
MAP SENSOR**

KW

HONDA
ACCORD VII (CL)

2.0 (CL7)	Petrol	114	02/03 →
2.0 Trazione integrale (CL8)	Petrol	114	02/03 →
2.4 (CL9)	Petrol	140	02/03 →

ACCORD VII Tourer (CM)

2.0 (CM1)	Petrol	114	04/03 →
2.4 (CM2)	Petrol	140	04/03 →

CIVIC VII Coupé (EM2)

1.6 i	Petrol	81	02/01 → 12/05
1.7 i	Petrol	88	05/01 → 12/05
1.7 i VTEC	Petrol	92	05/01 → 12/05

CIVIC VII Hatchback (EU, EP, EV)

1.4 i	Petrol	55	02/01 → 09/05
1.4 iS (EP1)	Petrol	66	02/01 → 09/05
1.6 i	Petrol	81	02/01 → 09/05
2.0 Type-R	Petrol	147	09/01 → 09/05

APS74

KW

HONDA
CIVIC VII Tre volumi (ES)

1.3 IMA	Petrol	61	01/04 → 09/05
1.4 (ES4)	Petrol	66	12/00 → 09/05
1.6	Petrol	81	02/01 → 09/05
1.7 (EU3)	Petrol	85	02/01 → 09/05

CR-V II (RD_)

2.0	Petrol	110	07/02 → 09/06
-----	--------	-----	---------------

FR-V (BE)

1.7	Petrol	92	08/04 →
-----	--------	----	---------

JAZZ II (GD)

1.2	Petrol	57	03/02 → 07/08
1.4	Petrol	61	03/02 → 07/08

STREAM (RN)

1.7 16V	Petrol	92	05/01 →
2.0 16V	Petrol	115	05/01 →

APS75
**SENSORE PRESSIONE ASSOLUTA
MAP SENSOR**

KW

CITROËN
C1 (PM_, PN_)

1.0	Petrol	50	06/05 →
-----	--------	----	---------

PEUGEOT
107

1.0	Petrol	50	06/05 →
-----	--------	----	---------

TOYOTA
AYGO (WNB1_, KGB1_)

1.0 (KGB10)	Petrol	50	07/05 →
-------------	--------	----	---------

YARIS (SCP9_, NSP9_, KSP9_, NCP9_, ZSP9_)

1.0 VVT-i	Petrol	51	08/05 →
-----------	--------	----	---------

APS76

**SENSORE PRESSIONE ASSOLUTA
MAP SENSOR**



CITROËN

BERLINGO (MF)

1.8 i (MFLFX) Petrol 66 05/97 → 12/98

1.8 i 4WD (MFLFX) Petrol 66 04/97 → 12/98

EVASION (22, U6)

2.0 16V Petrol 97 05/98 → 12/98

XANTIA (X1)

1.8 i Petrol 66 04/97 → 01/98

1.8 i 16V Petrol 81 06/95 → 01/98

XANTIA (X2)

1.8 i Petrol 66 01/98 → 12/98

1.8 i 16V Petrol 81 01/98 → 12/98

2.0 i 16V Petrol 97 01/98 → 12/98

3.0 V6 Petrol 140 01/98 → 01/99

XANTIA Break (X1)

1.8 i Petrol 66 04/97 → 01/98

1.8 i 16V Petrol 81 06/95 → 04/97

XANTIA Break (X2)

1.8 i Petrol 66 01/98 → 12/98

1.8 i 16V Petrol 81 01/98 → 12/98

2.0 i 16V Petrol 97 01/98 → 12/98

3.0 V6 Petrol 140 01/98 → 01/99

XM (Y4)

2.0 i 16V Petrol 97 02/97 → 12/98

3.0 V6 Petrol 140 09/97 → 12/98

XM Break (Y4)

2.0 i 16V Petrol 97 02/97 → 12/98

3.0 V6 Petrol 140 09/97 → 12/98

XSARA (N1)

1.4 i Petrol 55 07/97 → 12/98

1.6 i Petrol 65 07/98 → 12/98

1.8 i Petrol 66 07/97 → 09/00

1.8 i 16V Petrol 81 07/97 → 09/00

2.0 16V Petrol 120 07/97 → 09/00

APS76



CITROËN

XSARA (N1)

2.0 16V Petrol 97 07/98 → 09/00

XSARA Break (N2)

1.4 i Petrol 55 04/98 → 12/98

1.6 i Petrol 65 07/98 → 12/98

1.8 i Petrol 66 04/98 → 09/00

1.8 i 16V Petrol 81 04/98 → 09/00

2.0 16V Petrol 97 07/98 → 09/00

XSARA Coupé (N0)

1.4 i Petrol 55 03/98 → 12/98

1.8 i Petrol 66 02/98 → 09/00

1.8 i 16V Petrol 81 02/98 → 09/00

2.0 i 16V Petrol 120 02/98 → 08/00

ZX (N2)

1.8 i 16V Petrol 81 01/96 → 06/97

ZX Break (N2)

1.8 i 16V Petrol 81 01/96 → 02/98

FIAT

ULYSSE (220)

2.0 16V Petrol 97 05/98 → 12/98

LANCIA

ZETA (220)

2.0 16V (220AL5) Petrol 97 06/99 → 07/00

PEUGEOT

206 2 volumi /Coda spiovente (2A/C)

1.1 i Petrol 44 09/98 → 11/98

1.4 i Petrol 55 09/98 → 11/98

1.6 i Petrol 65 09/98 → 11/98

306 (7B, N3, N5)

1.4 SL Petrol 55 06/94 → 12/98

1.6 SR Petrol 65 06/98 → 02/99

1.8 16V Petrol 81 03/97 → 11/98

2.0 Petrol 97 03/97 → 12/98

306 2 volumi /Coda spiovente (7A, 7C, N3, N5)

1.4 Petrol 55 05/93 → 12/98

1.6 Petrol 65 06/98 → 02/99

1.8 16V Petrol 81 03/97 → 11/98

2.0 16V Petrol 97 03/97 → 12/98

306 Break (7E, N3, N5)

1.4 Petrol 55 03/97 → 12/98

1.6 Petrol 65 06/98 → 02/99

1.8 16V Petrol 81 03/97 → 11/98

2.0 Petrol 97 03/97 → 12/98

306 Cabriolet (7D, N3, N5)

2.0 16V Petrol 97 03/97 → 12/98

APS76

KW

CITROËN
406 (8B)

1.8	Petrol	66	09/97 → 11/98
1.8 16V	Petrol	81	11/95 → 11/98
2.0 16V	Petrol	97	01/97 → 03/99

406 Break (8E/F)

1.8	Petrol	66	09/97 → 11/98
-----	--------	----	---------------

406 Coupé (8C)

2.0 16V	Petrol	97	03/97 → 03/99
3.0 V6 24V	Petrol	140	03/97 → 11/98

605 (6B)

2.0 16V	Petrol	97	01/97 → 12/98
3.0 V6	Petrol	140	04/97 → 05/99

806 (221)

2.0 16V	Petrol	97	05/98 → 12/98
---------	--------	----	---------------

RANCH MPV / Space wagon (5F)

1.4	Petrol	55	06/96 → 12/98
1.8	Petrol	66	05/97 → 12/98

RENAULT
ESPACE III (JE0_)

3.0 V6 24V (JE0G, JE0R)	Petrol	140	10/98 → 12/98
----------------------------	--------	-----	---------------

LAGUNA I Grandtour (K56_)

3.0 24V (K56V)	Petrol	140	03/97 → 12/98
----------------	--------	-----	---------------

APS77
**SENSORE PRESSIONE ASSOLUTA
MAP SENSOR**

KW

CITROËN
BERLINGO (MF)

1.4 i bivalent (MFKFW)	BiFuel	55	04/03 →
1.6 16V (MFNFU)	Petrol	80	10/00 → 11/02

APS77

KW

CITROËN
BERLINGO Furgonato (M_)

1.4 i bivalent (MBKFW)	BiFuel	55	04/03 →
1.6 16V (MBNFU)	Petrol	80	10/00 → 11/02

C2 (JM_)

1.1	Petrol	44	09/03 →
1.4	Petrol	54	09/03 →
1.6	Petrol	80	09/03 →
1.6 VTS	Petrol	90	01/05 →

C3 I (FC_)

1.1 i	Petrol	44	02/02 → 08/05
1.4 16V	Petrol	65	12/03 → 08/05
1.4 i Bivalent	Petrol/ CNG	54	02/02 → 08/05
1.6 16V	Petrol	80	02/02 → 08/05

C3 Pluriel (HB_)

1.4	Petrol	54	05/03 →
1.6	Petrol	80	05/03 →

C4 Coupé (LA_)

1.4 16V	Petrol	65	11/04 →
1.6 16V	Petrol	80	11/04 →
2.0 16V	Petrol	130	11/04 →

C4 I (LC_)

1.4 16V	Petrol	65	11/04 →
1.6 16V	Petrol	80	11/04 →
2.0 16V	Petrol	103	11/04 →

C5 II (RC_)

1.8 16V (RC6FZB)	Petrol	85	09/04 →
2.0 16V (RCRFJB, RCRFJC)	Petrol	103	09/04 →

C5 II Break (RE_)

1.8 16V (RE6FZB)	Petrol	85	09/04 →
2.0 16V (RERFJB, RERFJC)	Petrol	103	09/04 →

C8 (EA_, EB_)

2.0 16V	Petrol	103	09/05 →
---------	--------	-----	---------

SAXO (S0, S1)

1.1 X,SX	Petrol	44	03/00 → 05/03
1.6 VTS	Petrol	72	09/00 → 08/03

APS77



KW



CITROËN

XSARA (N1)

1.4 i	Petrol	55	09/00 → 03/05
1.6 16V	Petrol	80	09/00 → 03/05

XSARA Break (N2)

1.4 i	Petrol	55	09/00 → 08/05
1.6 16V	Petrol	80	09/00 → 08/05

XSARA Coupé (N0)

1.4 i	Petrol	55	09/00 → 03/05
1.6 16V	Petrol	80	09/00 → 03/05

XSARA PICASSO (N68)

1.6	Petrol	70	12/99 →
1.6 16V	Petrol	80	09/05 →

FIAT

FIORINO Cassone / Furgonato / Promiscuo (225)

1.4	Petrol	54	11/07 →
-----	--------	----	---------

QUBO (225)

1.4	Petrol	54	02/08 →
-----	--------	----	---------

PEUGEOT

1007 (KM_)

1.4	Petrol	54	04/05 →
1.4 16V	Petrol	65	10/05 →
1.6 16V	Petrol	80	04/05 →

206 2 volumi /Coda spiovente (2A/C)

1.1 i	Petrol	44	03/00 →
1.4 16V	Petrol	65	10/03 →
1.4 i	Petrol	55	03/00 →
1.6 16V	Petrol	80	12/00 →
2.0 RC	Petrol	130	07/03 →

206 CC (2D)

1.6 16V	Petrol	80	09/00 →
---------	--------	----	---------

206 SW (2E/K)

1.1	Petrol	44	07/02 →
1.4	Petrol	55	07/02 →
1.4 16V	Petrol	65	10/03 →
1.6 16V	Petrol	80	07/02 →

306 (7B, N3, N5)

1.4 SL	Petrol	55	10/00 → 05/01
1.6	Petrol	72	10/00 → 05/01

306 2 volumi /Coda spiovente (7A, 7C, N3, N5)

1.4	Petrol	55	10/00 → 05/01
1.6	Petrol	72	10/00 → 05/01

306 Break (7E, N3, N5)

1.4	Petrol	55	10/00 → 03/02
1.6	Petrol	72	10/00 → 03/02

APS77



KW



PEUGEOT

306 Cabriolet (7D, N3, N5)

1.6	Petrol	72	10/00 → 04/02
-----	--------	----	---------------

307 (3A/C)

1.4	Petrol	55	08/00 → 05/05
1.4 16V	Petrol	65	11/03 →
1.6 16V	Petrol	80	08/00 →
2.0 16V	Petrol	103	03/05 →
2.0 16V	Petrol	130	06/05 →

307 Break (3E)

1.4 16V	Petrol	65	11/03 →
1.6 16V	Petrol	80	03/02 →
2.0 16V	Petrol	103	03/05 →
2.0 16V	Petrol	130	06/05 →

307 CC (3B)

1.6 16V	Petrol	80	02/05 →
2.0 16V	Petrol	103	03/05 →
2.0 16V	Petrol	130	10/03 →

307 SW (3H)

1.4 16V	Petrol	65	11/03 →
1.6 16V	Petrol	80	03/02 →
2.0 16V	Petrol	103	03/05 →

407 (6D_)

1.8	Petrol	85	05/04 →
1.8 16V	Petrol	92	09/05 →
2.0 16V	Petrol	103	09/05 →
2.2 16V	Petrol	120	09/05 →

407 Coupé (6C_)

2.2 16V	Petrol	120	10/05 →
---------	--------	-----	---------

407 SW (6E_)

1.8	Petrol	85	05/04 →
1.8 16V	Petrol	92	09/05 →
2.0 16V	Petrol	103	09/05 →
2.2 16V	Petrol	120	09/05 →

607 (9D, 9U)

2.2 16V	Petrol	120	09/05 →
---------	--------	-----	---------

807 (E)

2.0 16V	Petrol	103	09/05 →
---------	--------	-----	---------

RANCH Furgonato (5)

1.4 BiFuel	Petrol/ CNG	55	04/03 →
------------	----------------	----	---------

RANCH MPV / Space wagon (5F)

1.1	Petrol	44	09/00 →
1.4	Petrol	55	09/00 →
1.6 16V	Petrol	80	07/01 →

APS78
**SENSORE PRESSIONE ASSOLUTA
MAP SENSOR**

FORD
C-MAX (DM2)

1.8 TDCi Diesel 85 02/07 →

FOCUS C-MAX

1.8 TDCi Diesel 85 01/05 → 03/07

FOCUS II (DA_)

1.8 TDCi Diesel 85 01/05 →

FOCUS II Station wagon (DA_)

1.8 TDCi Diesel 85 11/04 →

FOCUS II Tre volumi (DA_)

1.8 TDCi Diesel 85 04/05 →

GALAXY (WA6)

1.8 TDCi Diesel 74 05/06 →

1.8 TDCi Diesel 92 05/06 →

MONDEO IV (BA7)

1.8 TDCi Diesel 74 03/07 →

MONDEO IV Tre volumi (BA7)

1.8 TDCi Diesel 74 03/07 →

MONDEO IV Turnier (BA7)

1.8 TDCi Diesel 74 03/07 →

S-MAX (WA6)

1.8 TDCi Diesel 92 05/06 →

APS79
**SENSORE PRESSIONE ASSOLUTA
MAP SENSOR**

FORD
FIESTA VI

1.25 Petrol 44 06/08 →

1.25 Petrol 60 06/08 →

KITLDF6T
**SENSORE PRESSIONE ASSOLUTA
MAP SENSOR**

FIAT
500 (312)

1.2 Petrol 51 10/07 →

BRAVA (182)

1.2 16V 80 Petrol 59 10/00 → 10/01

BRAVO I (182)

1.2 16V 80 Petrol 59 10/00 → 10/01

DOBLO (119)

1.4 Petrol 57 10/05 →

DOBLO Cargo (223)

1.4 Petrol 57 10/05 →

IDEA

1.2 16V Petrol 59 01/04 →

1.4 16V Petrol 70 01/04 →

LINEA (323)

1.4 Petrol 57 06/07 →

KITLDF6T



KW



FIAT

PANDA (169)

1.1	Petrol	40	09/03 →
1.2	Petrol	44	09/03 →
1.2 4x4	Petrol	44	10/04 →

PUNTO (188)

1.2 16V 80 (188.233, .235, .253, .255, .333, .353, .639...)	Petrol	59	09/99 →
--	--------	----	---------

1.2 60 (188.030, .050, .130, .150, .230, .250)	Petrol	44	07/03 →
--	--------	----	---------

1.4	Petrol	70	09/03 →
-----	--------	----	---------

PUNTO / GRANDE PUNTO (199)

1.2	Petrol	48	10/05 →
1.4	Petrol	57	10/05 →

PUNTO Van (188AX)

1.2 60	Petrol	44	07/03 → 10/09
--------	--------	----	---------------

STILO (192)

1.2 16V (192_XA1B)	Petrol	59	02/02 → 12/03
1.4 16V	Petrol	66	03/05 → 11/06
1.4 16V	Petrol	70	01/04 → 11/06

STILO Multi Wagon (192)

1.4 16V	Petrol	66	03/05 → 08/08
1.4 16V	Petrol	70	01/04 → 08/08

KITTPRT05/2

**SENSORE PRESSIONE ASSOLUTA
MAP SENSOR**



KW



FIAT

DOBLO (119)

1.2 (223AXA1A)	Petrol	48	03/01 → 12/04
----------------	--------	----	---------------

KITTPRT05/2



KW



FIAT

DOBLO (119)

1.6 16V (223AXD1A)	Petrol	76	10/01 → 12/04
-----------------------	--------	----	---------------

DOBLO Cargo (223)

1.2 (223ZX1A)	Petrol	48	03/01 → 12/04
1.6 16V (223ZXD1A)	Petrol	76	10/01 → 12/04

MULTIPLA (186)

1.6 100 16V (186AXA1A)	Petrol	76	04/99 → 06/10
1.6 16V Bipower (186AMB1A)	Petrol/ CNG	76	04/99 → 06/10
1.6 16V Blupower (186AMA1A)	Bifuel	70	04/99 → 06/10

PALIO (178BX)

1.2	Petrol	54	01/01 → 12/04
1.6 16V	Petrol	74	01/99 → 12/00

PALIO Weekend (178DX)

1.2 (178DYA1A)	Petrol	44	02/01 →
1.6 16V (178DX. D1A)	Petrol	74	01/99 → 02/01
1.6 16V (178DYC1A06)	Petrol	76	02/01 → 12/04

PANDA (141A_)

1100	Petrol	40	01/01 → 09/03
1100 4x4	Petrol	40	01/01 → 09/03

PUNTO (176)

1.2 16V	Petrol	63	04/97 → 09/99
---------	--------	----	---------------

PUNTO (188)

1.2 60 (188.030, .050, .130, .150, .230, .250)	Petrol	44	09/99 → 06/03
--	--------	----	---------------

PUNTO Cabriolet (176C)

85 16V 1.2	Petrol	63	04/97 → 06/00
------------	--------	----	---------------

SEICENTO (187)

1.1 (187AXB, 187AXB1A)	Petrol	40	01/01 → 01/10
---------------------------	--------	----	---------------

SIENA (178_)

1.2	Petrol	54	09/98 → 12/04
1.6 16V	Petrol	78	01/01 → 12/04

STILO (192)

1.6 16V (192_XB1A)	Petrol	76	10/01 → 11/06
-----------------------	--------	----	---------------

STILO Multi Wagon (192)

1.6 16V	Petrol	76	01/03 → 08/08
---------	--------	----	---------------

KITTPRT05/2

FIAT
STRADA Pick-up (178E)

1.2	Petrol	44	04/03 → 12/04
1.2	Petrol	54	06/99 → 03/03

LANCIA
DEDRA (835)

1.6 16V (835EI)	Petrol	76	01/96 → 07/99
-----------------	--------	----	---------------

DEDRA SW (835)

1.6 16V (835EI)	Petrol	76	01/96 → 07/99
-----------------	--------	----	---------------

LYBRA (839AX)

1.6 16V (839AXA1A)	Petrol	76	07/99 → 10/05
--------------------	--------	----	---------------

LYBRA SW (839BX)

1.6 16V (839BXA1A)	Petrol	76	07/99 → 10/05
--------------------	--------	----	---------------

Y (840A)

1.2 (840AA, 840AF1A)	Petrol	44	01/01 → 09/03
1.2 16V (840AD)	Petrol	63	04/97 → 09/03

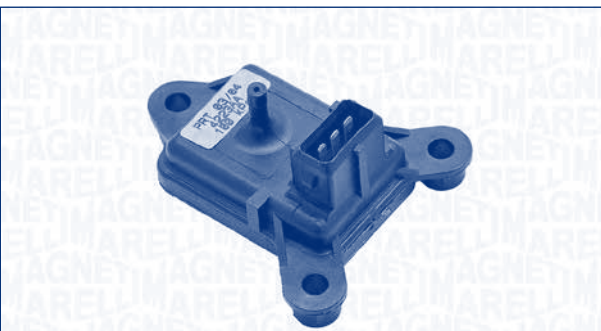
PRT03/04
**SENSORE PRESSIONE ASSOLUTA
MAP SENSOR**

ALFA ROMEO
33 (907A)

1.4 i.e. (907.A3A, 907.A3B)	Petrol	65	01/92 → 09/94
1.4 i.e. (907.A3A, 907.A3B)	Petrol	66	01/92 → 09/94

33 Sportwagon (907B)

1.4 i.e.	Petrol	65	01/92 → 09/94
1.4 i.e.	Petrol	66	01/92 → 09/94
1.4 i.e. 4x4	Petrol	66	01/92 → 09/94

PRT03/04

CITROËN
AX (ZA-)

10	Petrol	37	07/92 → 12/98	ENGINE: TU1ML3
11	Petrol	44	10/89 → 12/97	ENGINE: TU1MZ

BX (XB-)

16 E	Petrol	65	05/89 → 02/93	ENGINE: XU5M2Z
------	--------	----	---------------	----------------

JUMPER Autobus (230P)

2.0	Petrol	80	02/94 → 04/02	ENGINE: XU10J2U
-----	--------	----	---------------	-----------------

JUMPER Furgonato (230L)

2.0	Petrol	80	03/94 → 04/02	ENGINE: XU10J2U
-----	--------	----	---------------	-----------------

XANTIA (X1)

2.0 i	Petrol	89	03/93 → 01/98	ENGINE: XU10J2CK
-------	--------	----	---------------	------------------

XM (Y3)

2.0 i	Petrol	89	05/89 → 06/94	ENGINE: XU10J2K
-------	--------	----	---------------	-----------------

XSARA (N1)

1.8 i Aut.	Petrol	74	04/97 → 09/00	ENGINE: XU7JP,L3
------------	--------	----	---------------	------------------

ZX (N2)

1.4 i	Petrol	55	03/91 → 06/97	ENGINE: TU3MC
1.6 i	Petrol	65	03/91 → 06/97	ENGINE: XU5M3K
2.0 i	Petrol	89	07/92 → 06/97	ENGINE: XU10J2CK

FIAT
ARGENTA (132A)

2000 i.e.	Petrol	90	06/81 → 07/86
-----------	--------	----	---------------

BRAVA (182)

1.6 16V (182.BH)	Petrol	66	10/95 → 10/01
------------------	--------	----	---------------

BRAVO I (182)

1.6 16V (182.AH)	Petrol	66	10/95 → 10/01
------------------	--------	----	---------------

CINQUECENTO (170)

0.9 i.e. S (170AF, 170CF)	Petrol	29	07/91 → 01/98
---------------------------	--------	----	---------------

1.1 Sporting (170AH)	Petrol	40	10/94 → 01/98
----------------------	--------	----	---------------

COUPE (FA/175)

2.0 16V	Petrol	102	11/93 → 08/96
---------	--------	-----	---------------

CROMA (154)

2000 i.e. (154.AD)	Petrol	88	03/87 → 09/92
--------------------	--------	----	---------------

2000 i.e. (154.AM, 154.LM)	Petrol	85	01/92 → 08/96
----------------------------	--------	----	---------------

DUCATO Autobus (230)

2.0 Panorama/ Combinato	Petrol	80	03/94 → 04/02	ENGINE: XU10J2U
-------------------------	--------	----	---------------	-----------------

DUCATO Furgonato (230L)

2.0	Petrol	80	03/94 → 04/02	ENGINE: XU10J2U
-----	--------	----	---------------	-----------------

DUCATO Pianale piatto/Telaio (230)

2.0	Petrol	80	06/98 → 04/02	ENGINE: XU10J2U
-----	--------	----	---------------	-----------------

PRT03/04



KW



FIAT

PALIO Weekend (178DX)

1.2 (178DX.G1A) Petrol 54 04/96 → 02/01

1.6 16V (178DX.D1A) Petrol 74 04/96 → 02/01

PANDA (141A_)

900 Petrol 29 04/92 → 12/96

1100 Petrol 37 05/91 → 12/99

1100 Petrol 40 02/95 → 08/00

1000 i.e. Cat. Petrol 33 10/87 → 08/98

1100 4x4 Petrol 40 02/95 → 07/04

1100 Trekking 4x4 Petrol 37 10/91 → 07/04

PUNTO (176)

55 1.1 Petrol 40 09/93 → 09/99

60 1.2 Petrol 44 03/94 → 09/99

75 1.2 Petrol 54 01/94 → 09/99

PUNTO Cabriolet (176C)

60 1.2 Petrol 44 05/95 → 06/00

PUNTO Van (176L)

1.1 Petrol 40 04/96 → 02/00

SEICENTO (187)

0.9 (187AXA, 187AXA1A) Petrol 29 01/98 → 01/10

1.1 (187AXB, 187AXB1A) Petrol 40 01/98 → 01/10

TEMPRA (159)

1.8 i.e. (159.AN) Petrol 77 03/92 → 08/92

1.8 i.e. (159.AN) Petrol 81 01/92 → 08/96

1.8 i.e. (159.AV) Petrol 76 09/93 → 08/96

1.8 i.e. (159.BY) Petrol 74 10/94 → 08/96

2.0 i.e. (159.AP) Petrol 83 01/92 → 08/96

TEMPRA S.W. (159)

1.8 i.e. (159.AN) Petrol 77 03/92 → 12/92

1.8 i.e. (159.AN) Petrol 81 01/92 → 08/96

1.8 i.e. (159.AV) Petrol 76 09/93 → 08/96

1.8 i.e. (159.BY) Petrol 74 10/94 → 08/96

2.0 i.e. 4x4 (159.AP) Petrol 83 03/92 → 03/92

TIPO (160)

1.8 i.e. Petrol 66 09/93 → 04/95

1.8 i.e. (160.ED) Petrol 76 04/93 → 04/93

1.8 i.e. (160.EQ, 160.AM) Petrol 74 10/94 → 04/95

2.0 16V (160.AV) Petrol 107 07/91 → 04/95

PRT03/04



KW



FIAT

TIPO (160)

2.0 i.e. (160.AT, 160.AJ) Petrol 83 01/92 → 04/95

2.0 i.e. 16V Sport (160.EF) Petrol 102 03/93 → 04/93

LANCIA

DEDRA (835)

1.8 i.e. (835BD, 835AD) Petrol 77 09/89 → 07/99

1.8 i.e. (835FA) Petrol 74 07/94 → 07/99

2.0 16V (835ED) Petrol 102 07/94 → 07/99

2.0 i.e. (835AL) Petrol 83 09/89 → 07/99

DEDRA SW (835)

1.8 i.e. (835FA) Petrol 74 07/94 → 07/99

2.0 16V (835ED) Petrol 102 07/94 → 07/99

2.0 Integrale (835ED) Petrol 102 07/94 → 07/99

DELTA II (836)

1.8 i.e. (836AE) Petrol 76 06/93 → 08/99

1.8 i.e. (836AG, 836AL) Petrol 66 07/94 → 08/99

2.0 16V (836AA, 836CA) Petrol 102 06/93 → 08/99

PRISMA (831AB0)

2.0 i.e. Trazione integrale Petrol 85 04/86 → 12/89

Y (840A)

1.1 (840AE) Petrol 40 11/95 → 09/03

1.2 (840AA, 840AF1A) Petrol 44 03/96 → 09/03

PEUGEOT

106 I (1A, 1C)

1.1 Petrol 44 09/91 → 04/96 ENGINE: TU1MZ

205 II (20A/C)

1.1 Petrol 44 01/97 → 09/98 ENGINE: TU1ML3

1.6 Aut. Petrol 65 01/91 → 09/98 ENGINE: XU5M3Z

306 (7B, N3, N5)

1.1 Petrol 44 06/94 → 05/01 ENGINE: TU1MZ

1.4 SL Petrol 55 06/94 → 05/01 ENGINE: TU3MC

1.8 16V Petrol 81 03/97 → 05/01 ENGINE: XU7JP,K

1.8 ST Petrol 74 06/94 → 05/01 ENGINE: XU7JP,L3

2.0 ST Petrol 89 07/94 → 05/01 ENGINE: XU10J2CK

306 Break (7E, N3, N5)

1.4 Petrol 55 03/97 → 04/02 ENGINE: TU3MC

1.8 Petrol 74 03/97 → 04/02 ENGINE: XU7JP,L3

PRT03/04

PEUGEOT
309 II (3C, 3A)

1.6	Petrol	65	07/89 → 12/93	ENGINE: XU5M2Z
-----	--------	----	---------------	----------------

405 I (15B)

1.6	Petrol	65	07/87 → 12/92	ENGINE: XU5M3Z
-----	--------	----	---------------	----------------

1.6	Petrol	66	10/89 → 12/92	ENGINE: XU5MZ
-----	--------	----	---------------	---------------

405 II (4B)

1.6	Petrol	65	08/92 → 10/95	ENGINE: XU5M3K
-----	--------	----	---------------	----------------

605 (6B)

2.0	Petrol	84	06/89 → 09/99	ENGINE: XU10MZ
-----	--------	----	---------------	----------------

2.0	Petrol	89	06/89 → 09/99	ENGINE: XU10J2K
-----	--------	----	---------------	-----------------

BOXER Autobus (230P)

2.0 i	Petrol	80	03/94 → 04/02	ENGINE: XU10J2U
-------	--------	----	---------------	-----------------

BOXER Furgonato (230L)

2.0 i	Petrol	80	06/94 → 04/02	ENGINE: XU10J2U
-------	--------	----	---------------	-----------------

BOXER Pianale piatto/Telaio (ZCT_)

2.0 i	Petrol	80	06/94 → 04/02	ENGINE: XU10J2U
-------	--------	----	---------------	-----------------

PRT03E/04
**SENSORE PRESSIONE ASSOLUTA
MAP SENSOR**

CITROËN
EVASION (22, U6)

1.8	Petrol	73	05/97 → 07/02
-----	--------	----	---------------

2.0	Petrol	89	06/94 → 07/02
-----	--------	----	---------------

XANTIA (X1)

1.6 i	Petrol	65	03/93 → 01/98
-------	--------	----	---------------

1.8 i	Petrol	74	03/93 → 01/98
-------	--------	----	---------------

2.0 i	Petrol	89	03/93 → 01/98
-------	--------	----	---------------

XANTIA Break (X1)

1.8 i	Petrol	74	06/95 → 01/98
-------	--------	----	---------------

2.0 i	Petrol	89	06/95 → 01/98
-------	--------	----	---------------

PRT03/04

CITROËN
ZX (N2)

1.8 i	Petrol	74	07/92 → 06/97
-------	--------	----	---------------

2.0 i	Petrol	89	07/92 → 06/97
-------	--------	----	---------------

ZX Break (N2)

1.6 i	Petrol	65	10/93 → 10/97
-------	--------	----	---------------

1.8 i	Petrol	74	10/93 → 10/97
-------	--------	----	---------------

FIAT
ULYSSE (220)

1.8 (220.BB5)	Petrol	73	05/97 → 08/02
---------------	--------	----	---------------

2.0 (220.AC5)	Petrol	89	06/94 → 08/02
---------------	--------	----	---------------

PEUGEOT
106 I (1A, 1C)

1.3	Petrol	72	10/93 → 04/96
-----	--------	----	---------------

306 (7B, N3, N5)

1.4 SL	Petrol	55	06/94 → 05/01
--------	--------	----	---------------

1.8 ST	Petrol	74	06/94 → 05/01
--------	--------	----	---------------

306 2 volumi /Coda spiovente (7A, 7C, N3, N5)

1.4	Petrol	55	05/93 → 05/01
-----	--------	----	---------------

1.8	Petrol	74	05/93 → 05/01
-----	--------	----	---------------

306 Break (7E, N3, N5)

1.4	Petrol	55	03/97 → 04/02
-----	--------	----	---------------

1.8	Petrol	74	03/97 → 04/02
-----	--------	----	---------------

306 Cabriolet (7D, N3, N5)

1.8	Petrol	74	03/94 → 04/02
-----	--------	----	---------------

2.0	Petrol	89	03/94 → 04/02
-----	--------	----	---------------

405 II (4B)

1.6	Petrol	65	08/92 → 10/95
-----	--------	----	---------------

1.8	Petrol	74	08/92 → 10/95
-----	--------	----	---------------

2.0	Petrol	89	08/92 → 10/95
-----	--------	----	---------------

2.0 X4	Petrol	89	08/92 → 10/95
--------	--------	----	---------------

405 II Break (4E)

1.6	Petrol	65	08/92 → 10/96
-----	--------	----	---------------

1.8	Petrol	74	08/92 → 10/96
-----	--------	----	---------------

2.0	Petrol	89	08/92 → 10/96
-----	--------	----	---------------

2.0 4x4	Petrol	89	08/92 → 10/96
---------	--------	----	---------------

406 (8B)

1.6	Petrol	65	11/95 → 05/04
-----	--------	----	---------------

1.8	Petrol	66	05/97 → 05/04
-----	--------	----	---------------

SPS001

**SENSORE PRESSIONE SCARICO
EXHAUST PRESSURE SENSOR**



OPEL

AGILA (B) (H08)

1.3 CDTI	Diesel	55	04/08 →
----------	--------	----	---------

SUZUKI

SPLASH

1.3 CDTI	Diesel	55	01/08 →
----------	--------	----	---------

SWIFT III (MZ, EZ)

1.3 DDiS	Diesel	51	08/05 →
----------	--------	----	---------

1.3 DDiS	Diesel	55	08/05 →
----------	--------	----	---------

SPS004

**SENSORE PRESSIONE SCARICO
EXHAUST PRESSURE SENSOR**



AUDI

A1 (8X1, 8XF)

1.6 TDI	Diesel	66	03/11 →
---------	--------	----	---------

1.6 TDI	Diesel	77	05/10 →
---------	--------	----	---------

2.0 TDi	Diesel	105	09/11 →
---------	--------	-----	---------

A1 Sportback (8XA, 8XK)

1.6 TDI	Diesel	66	11/11 →
---------	--------	----	---------

1.6 TDI	Diesel	77	11/11 →
---------	--------	----	---------

2.0 TDi	Diesel	105	09/11 →
---------	--------	-----	---------

SPS004



AUDI

A3 (8P1)

2.0 TDi	Diesel	100	05/03 → 08/12
---------	--------	-----	---------------

2.0 TDI 16V	Diesel	103	05/03 → 08/12
-------------	--------	-----	---------------

2.0 TDI 16V quattro	Diesel	103	08/04 → 08/12
---------------------	--------	-----	---------------

A3 Sportback (8PA)

2.0 TDI 16V	Diesel	103	09/04 → 03/13
-------------	--------	-----	---------------

2.0 TDI 16V quattro	Diesel	103	11/05 → 03/13
---------------------	--------	-----	---------------

A4 (8K2, B8)

2.0 TDi	Diesel	100	11/07 →
---------	--------	-----	---------

2.0 TDi	Diesel	105	11/07 →
---------	--------	-----	---------

2.0 TDi	Diesel	120	08/08 →
---------	--------	-----	---------

2.0 TDi	Diesel	130	11/11 →
---------	--------	-----	---------

2.0 TDi	Diesel	88	06/08 →
---------	--------	----	---------

2.0 TDI quattro	Diesel	105	11/08 →
-----------------	--------	-----	---------

2.0 TDI quattro	Diesel	130	11/11 →
-----------------	--------	-----	---------

A4 Allroad (8KH, B8)

2.0 TDI quattro	Diesel	100	09/09 →
-----------------	--------	-----	---------

2.0 TDI quattro	Diesel	105	09/09 →
-----------------	--------	-----	---------

2.0 TDI quattro	Diesel	120	04/09 →
-----------------	--------	-----	---------

2.0 TDI quattro	Diesel	130	11/11 →
-----------------	--------	-----	---------

A4 Avant (8K5, B8)

2.0 TDi	Diesel	100	04/08 →
---------	--------	-----	---------

2.0 TDi	Diesel	105	04/08 →
---------	--------	-----	---------

2.0 TDi	Diesel	120	08/08 →
---------	--------	-----	---------

2.0 TDi	Diesel	130	11/11 →
---------	--------	-----	---------

2.0 TDi	Diesel	88	06/08 →
---------	--------	----	---------

2.0 TDI quattro	Diesel	105	04/08 →
-----------------	--------	-----	---------

2.0 TDI quattro	Diesel	130	11/11 →
-----------------	--------	-----	---------

A5 (8T3)

2.0 TDI quattro	Diesel	130	12/11 →
-----------------	--------	-----	---------

A5 Cabriolet (8F7)

2.0 TDi	Diesel	105	10/11 →
---------	--------	-----	---------

2.0 TDi	Diesel	130	10/11 →
---------	--------	-----	---------

2.0 TDI quattro	Diesel	130	01/12 →
-----------------	--------	-----	---------

A5 Sportback (8TA)

2.0 TDi	Diesel	130	10/11 →
---------	--------	-----	---------

2.0 TDI quattro	Diesel	130	12/11 →
-----------------	--------	-----	---------

A6 (4G2, C7, 4GC)

2.0 TDi	Diesel	120	03/11 →
---------	--------	-----	---------

A6 Avant (4G5, C7, 4GD)

2.0 TDi	Diesel	120	05/11 →
---------	--------	-----	---------

2.0 TDi	Diesel	130	05/11 →
---------	--------	-----	---------

SPS004

KW

AUDI
Q5 (8R)

2.0 TDi	Diesel	100	11/10 →
2.0 TDi	Diesel	105	11/10 →
2.0 TDi quattro	Diesel	105	08/09 →
2.0 TDi quattro	Diesel	125	11/08 →

SEAT
ALTEA (5P1)

2.0 TDi 16V	Diesel	103	03/04 →
-------------	--------	-----	---------

ALTEA XL (5P5, 5P8)

2.0 TDi 16V	Diesel	103	10/06 →
2.0 TDi 4x4	Diesel	125	06/07 →

EXEO (3R2)

2.0 TDi	Diesel	88	12/08 →
---------	--------	----	---------

IBIZA V (6J5)

1.2 TDi	Diesel	55	05/10 →
1.6 TDi	Diesel	66	05/09 →
1.6 TDi	Diesel	77	05/09 →
2.0 TDi	Diesel	105	01/10 →

IBIZA V SPORTCOUPE (6J1)

1.6 TDi	Diesel	66	05/09 →
1.6 TDi	Diesel	77	05/09 →
2.0 TDi	Diesel	105	01/10 →

IBIZA V ST (6J8)

1.2 TDi	Diesel	55	04/10 →
1.6 TDi	Diesel	66	03/10 →
1.6 TDi	Diesel	77	03/10 →

LEON (1P1)

2.0 TDi	Diesel	125	05/06 →
2.0 TDi 16V	Diesel	103	07/05 →

SKODA
FABIA

1.4 TDi	Diesel	59	01/07 →
1.6 TDi	Diesel	55	04/10 →
1.6 TDi	Diesel	66	03/10 →
1.6 TDi	Diesel	77	03/10 →
1.9 TDi	Diesel	77	04/07 →

FABIA Combi

1.4 TDi	Diesel	59	10/07 →
1.6 TDi	Diesel	55	04/10 →
1.6 TDi	Diesel	66	03/10 →
1.6 TDi	Diesel	77	03/10 →
1.9 TDi	Diesel	77	10/07 →

OCTAVIA (1Z3)

2.0 TDi 16V	Diesel	103	02/04 →
-------------	--------	-----	---------

SPS004

KW

SKODA
OCTAVIA Combi (1Z5)

2.0 TDi 16V	Diesel	103	02/04 →
2.0 TDi 4x4	Diesel	81	05/11 →

ROOMSTER (5J)

1.6 TDi	Diesel	66	03/10 →
1.6 TDi	Diesel	77	03/10 →

ROOMSTER Praktik (5J)

1.2 TDi	Diesel	55	03/10 →
1.6 TDi	Diesel	66	03/10 →

SUPERB (3T4)

2.0 TDi	Diesel	125	07/08 →
2.0 TDi 4x4	Diesel	125	09/08 →

SUPERB Station wagon (3T5)

2.0 TDi	Diesel	125	10/09 →
2.0 TDi 4x4	Diesel	125	10/09 →

VOLKSWAGEN
CADDY III Furgonato (2KA, 2KH, 2CA, 2CH)

2.0 TDi	Diesel	62	11/10 →
2.0 TDi 16V	Diesel	103	11/10 →
2.0 TDi 16V 4motion	Diesel	103	11/10 →

2.0 TDi 4motion	Diesel	62	12/10 →
2.0 TDi 4motion	Diesel	81	08/10 →

2.0 TDi 16V	Diesel	103	11/10 →
-------------	--------	-----	---------

2.0 TDi 16V 4motion	Diesel	103	11/10 →
---------------------	--------	-----	---------

CADDY III Station wagon (2KB, 2KJ, 2CB, 2CJ)

2.0 TDi 4motion	Diesel	81	08/10 →
-----------------	--------	----	---------

EOS (1F7, 1F8)

2.0 TDi	Diesel	100	11/10 →
2.0 TDi 16V	Diesel	103	05/08 →

GOLF PLUS (5M1, 521)

2.0 TDi	Diesel	100	05/05 →
2.0 TDi 16V	Diesel	103	01/05 →

GOLF VI (5K1)

2.0 TDi	Diesel	100	10/08 → 11/12
2.0 TDi	Diesel	103	10/08 → 05/13
2.0 TDi	Diesel	125	04/09 → 11/12
2.0 TDi 4motion	Diesel	103	05/09 → 11/12

GOLF VI Cabriolet (517)

2.0 TDi	Diesel	103	11/11 →
---------	--------	-----	---------

GOLF VI Variant (AJ5)

2.0 TDi 16V	Diesel	103	07/09 → 07/13
-------------	--------	-----	---------------

SPS004



VOLKSWAGEN

POLO (6R, 6C)

1.2 TDI	Diesel	55	10/09 →
1.6 TDI	Diesel	55	06/09 →
1.6 TDI	Diesel	66	06/09 →
1.6 TDI	Diesel	77	06/09 →

SCIROCCO (137, 138)

2.0 TDi	Diesel	100	11/10 →
2.0 TDi	Diesel	103	08/08 →
2.0 TDi	Diesel	125	05/09 →

GRUPPO E - GROUP E

DPR04

**REGOLATORE PRESSIONE CARBURANTE
FUEL PRESSURE REGULATOR**



VOLVO

S40 I (VS)

1.6	Petrol	80	03/99 → 12/03	ENGINE: B4164S2
1.8	Petrol	90	03/99 → 12/03	ENGINE: B4184S2
1.8	Petrol/ CNG	85	06/01 → 08/03	ENGINE: B4184S2
1.9 T4	Petrol	147	05/97 → 07/00	ENGINE: B4194T,B4194T2
2.0 T	Petrol	118	10/97 → 12/03	ENGINE: B4204T

V40 Station wagon (VW)

1.6	Petrol	80	03/99 → 06/04	ENGINE: B4164S2
1.8	Petrol	90	03/99 → 06/04	ENGINE: B4184S2
1.9 T4	Petrol	147	05/97 → 07/00	ENGINE: B4194T
2.0 T	Petrol	118	10/97 → 07/00	ENGINE: B4204T
2.0 T4	Petrol	147	07/00 → 06/04	ENGINE: B4204T5

RP01A

**REGOLATORE PRESSIONE CARBURANTE
FUEL PRESSURE REGULATOR**



MERCEDES-BENZ

CLASSE C (W202)

C 180 (202.018)	Petrol	89	09/95 → 04/00
C 180 (202.018)	Petrol	90	03/93 → 04/00
C 200 (202.020)	Petrol	100	01/94 → 04/00
C 220 (202.022)	Petrol	110	03/93 → 09/96
C 280 (202.028)	Petrol	142	05/93 → 05/97
C 36 AMG (202.028)	Petrol	206	05/94 → 04/97

CLASSE C Station wagon (S202)

C 180 T (202.078)	Petrol	90	06/96 → 09/00
C 200 T (202.080)	Petrol	100	06/96 → 02/01

CLASSE E (W124)

E 200 (124.019)	Petrol	100	07/93 → 06/95
E 220 (124.022)	Petrol	110	07/93 → 06/95
E 280 (124.028)	Petrol	145	07/93 → 06/95
E 280 (124.029)	Petrol	142	07/93 → 06/95
E 320 (124.032)	Petrol	162	07/93 → 06/95
E 420 (124.034)	Petrol	205	07/93 → 06/95
E 500 (124.036)	Petrol	235	07/93 → 06/95
E 60 AMG (124.036)	Petrol	280	05/94 → 06/95

CLASSE E (W210)

E 200 (210.035)	Petrol	100	06/95 → 08/00
E 200 Kompressor (210.045)	Petrol	137	09/97 → 08/00
E 230 (210.037)	Petrol	110	06/95 → 06/97
E 280 (210.053)	Petrol	142	01/96 → 02/97
E 320 (210.055)	Petrol	162	06/95 → 02/97
E 420 (210.072)	Petrol	205	01/96 → 06/97
E 50 AMG (210.072)	Petrol	255	02/96 → 08/97

RP01A

MERCEDES-BENZ
CLASSE E Cabriolet (A124)

E 320 (124.066) Petrol 162 06/93 → 03/98

E 36 AMG (124.066) Petrol 200 05/94 → 03/98

CLASSE E Coupé (C124)

E 220 (124.042) Petrol 110 07/93 → 06/97

E 320 (124.052) Petrol 162 07/93 → 06/97

E 36 AMG (124.052) Petrol 195 06/93 → 02/94

E 36 AMG (124.052) Petrol 200 05/94 → 06/96

CLASSE E Station wagon (S124)

E 200 T (124.079) Petrol 100 07/93 → 05/96

E 220 T (124.082) Petrol 110 07/93 → 05/96

E 280 T (124.088) Petrol 142 07/93 → 05/96

E 280 T (124.088) Petrol 145 07/93 → 05/96

E 320 T (124.092) Petrol 162 07/93 → 05/96

E 36 T AMG (124.092) Petrol 200 05/94 → 05/96

CLASSE E Station wagon (S210)

E 200 T (210.235) Petrol 100 06/96 → 08/00

E 200 T Kompressor (210.245) Petrol 137 09/97 → 01/03

E 230 T (210.237) Petrol 110 06/96 → 06/97

E 420 T (210.272) Petrol 205 06/96 → 06/97

CLASSE G (W463)

G 320 (463.230, 463.231) Petrol 155 09/94 → 11/97

CLASSE G Cabrio (W463)

320 GE (463.208) Petrol 155 09/94 → 11/97

CLASSE M (W163)

ML 230 (163.136) Petrol 110 03/98 → 06/00

CLASSE S (W140)

300 SE 2.8 (140.028) Petrol 145 01/93 → 05/93

300 SE,SEL/ S320 (140.032, 140.033) Petrol 170 03/91 → 09/98

400 SE,SEL/ S420 (140.042, 140.043) Petrol 210 02/91 → 09/98

500 SE,SEL (140.050, 140.051) Petrol 240 02/91 → 05/93

RP01A

MERCEDES-BENZ
CLASSE S (W140)

600 SE,SEL (140.056, 140.057) Petrol 300 04/91 → 12/92

S 280 (140.028) Petrol 142 06/93 → 09/98

S 420 (140.042) Petrol 205 06/93 → 09/98

S 500 (140.050, 140.051) Petrol 235 06/93 → 09/98

S 600 (140.056, 140.057) Petrol 290 06/93 → 09/98

CLASSE S Coupé (C140)

SEC/CL 420 (140.063) Petrol 205 10/94 → 02/99

SEC/CL 500 (140.070) Petrol 235 10/92 → 02/99

SEC/CL 600 (140.076) Petrol 290 09/92 → 05/96

CLASSE V (638/2)

V 200 (638.214, 638.294) Petrol 95 02/97 → 06/03

CLK (C208)

200 (208.335) Petrol 100 06/97 → 06/00

COUPE (C124)

220 CE (124.042) Petrol 110 10/92 → 05/93

320 CE (124.052) Petrol 162 10/92 → 05/93

KOMBI Station wagon (S124)

200 TE (124.079) Petrol 100 05/86 → 06/93

220 TE (124.082) Petrol 110 10/92 → 05/93

280 TE (124.088) Petrol 145 10/92 → 06/93

320 TE (124.092) Petrol 162 10/92 → 06/93

SL (R129)

280 (129.058) Petrol 142 08/93 → 05/98

320 (129.063) Petrol 170 09/93 → 05/98

500 (129.067) Petrol 235 09/92 → 09/95

60 AMG (129.067) Petrol 280 05/97 → 08/01

600 (129.076) Petrol 290 07/92 → 05/98

SPRINTER 2-t Autobus (901, 902)

214 Petrol 105 02/95 → 03/00

SPRINTER 2-t Furgonato (901, 902)

214 Petrol 105 02/95 → 03/00

SPRINTER 2-t Pianale piatto/Telaio (901, 902)

214 Petrol 105 02/95 → 03/00

RP01A



KW



MERCEDES-BENZ

SPRINTER 3-t Autobus (903)

314	Petrol	105	02/95 → 08/02
314 4x4	Petrol	105	08/02 → 05/06

SPRINTER 3-t Furgonato (903)

314	Petrol	105	02/95 → 08/02
314 4x4	Petrol	105	08/02 → 05/06

SPRINTER 4-t Autobus (904)

414	Petrol	105	02/96 → 03/00
-----	--------	-----	---------------

SPRINTER 4-t Furgonato (904)

414	Petrol	105	02/96 → 04/00
414 4x4	Petrol	105	05/97 → 03/00

Tre volumi (W124)

200 E (124.019)	Petrol	100	10/92 → 06/93
220 E (124.022)	Petrol	110	10/92 → 06/93
280 E (124.028)	Petrol	145	10/92 → 06/93
320 E (124.032)	Petrol	162	10/92 → 06/93
400 E 4.2 (124.034)	Petrol	205	10/92 → 06/93
500 E (124.036)	Petrol	240	01/91 → 06/93
500 E AMG 6.0	Petrol	275	01/92 → 06/93

VITO Autobus (638)

113 2.0 (638.114, 638.194)	Petrol	95	02/96 → 06/03
----------------------------	--------	----	---------------

VITO Furgonato (638)

113 2.0 (638.014, 638.094)	Petrol	95	03/97 → 06/03
114 2.3 (638.034, 638.094)	Petrol	105	03/97 → 06/03

SMART

CABRIO (450)

0.6 (450.400, S1OLD2)	Petrol	45	01/01 → 01/04
0.6 (450.432)	Petrol	52	06/02 → 01/04
0.6 (450.433, S1OLA1)	Petrol	40	03/00 → 01/04
0.7 (450.400)	Petrol	45	01/03 → 01/04
0.7 (450.414)	Petrol	55	01/03 → 01/04

CITY-COUPÉ (450)

0.6 (450.330, 450.332)	Petrol	52	06/02 → 01/04
0.6 (450.333, 450.335)	Petrol	45	01/01 → 12/02
0.6 (450.341, S1CLA1)	Petrol	40	07/98 → 01/04

RP01A



KW



SMART

CITY-COUPÉ (450)

0.6 (450.342, S1CLB1)	Petrol	33	07/98 → 01/04
0.7 (450.314)	Petrol	55	01/03 → 01/04
0.7 (450.336, 450.352, 450.353)	Petrol	45	01/03 → 01/04
0.7 (450.347)	Petrol	37	01/03 → 01/04

FORTWO Coupé (450)

0.7 (450.314)	Petrol	55	02/04 → 01/07
0.7 (450.331)	Petrol	37	02/04 → 01/07
0.7 (450.335, 450.336, 450.341, 450.342, 450.343...)	Petrol	45	02/04 → 01/07

ROADSTER (452)

0.7 (452.432)	Petrol	45	08/03 → 11/05
0.7 (452.434)	Petrol	60	04/03 → 11/05
0.7 Brabus (452.437)	Petrol	74	12/03 → 11/05

ROADSTER Coupé (452)

0.7 (452.334)	Petrol	60	04/03 → 11/05
0.7 Brabus (452.337)	Petrol	74	12/03 → 11/05

SSANGYONG

KORANDO (KJ)

2.0	Petrol	94	05/97 → 12/05
2.3	Petrol	103	05/97 → 12/05
2.3	Petrol	105	01/99 → 12/05

KORANDO Cabrio (KJ)

2.3	Petrol	103	11/97 → 12/05
2.3	Petrol	105	02/99 → 12/05

MUSSO (FJ)

2.3	Petrol	110	04/03 → 12/05
-----	--------	-----	---------------

RP02A
**REGOLATORE PRESSIONE CARBURANTE
FUEL PRESSURE REGULATOR**

KW

AUDI
100 (4A, C4)

2.6	Petrol	110	04/92 → 06/94
2.6 quattro	Petrol	110	04/92 → 06/94
2.8 E	Petrol	128	12/90 → 06/94
2.8 E quattro	Petrol	128	12/90 → 06/94
S4 Turbo quattro	Petrol	169	07/92 → 06/94

100 Avant (4A, C4)

2.6	Petrol	110	07/92 → 06/94
2.6 quattro	Petrol	110	07/92 → 06/94
2.8 E	Petrol	128	09/91 → 06/94
2.8 E quattro	Petrol	128	09/91 → 06/94

80 (8C, B4)

1.6 E	Petrol	74	06/93 → 12/94
2.6	Petrol	110	07/92 → 12/94
2.6 quattro	Petrol	110	07/92 → 12/94
2.8	Petrol	128	09/91 → 12/94
2.8 quattro	Petrol	128	09/91 → 12/94
S2 quattro	Petrol	169	02/93 → 12/94

80 Avant (8C, B4)

1.6 E	Petrol	74	06/93 → 07/95
2.6	Petrol	110	08/92 → 05/95
2.6 quattro	Petrol	110	08/92 → 07/95
2.8 quattro	Petrol	128	08/92 → 07/95
S2 quattro	Petrol	169	07/94 → 07/95

A4 (8D2, B5)

1.6	Petrol	74	11/94 → 06/00
1.6	Petrol	75	07/00 → 10/00
1.8	Petrol	92	01/95 → 10/00
1.8 quattro	Petrol	92	01/95 → 10/00
1.8 T	Petrol	132	12/97 → 12/98
1.8 T quattro	Petrol	132	12/97 → 10/00
2.4	Petrol	120	08/97 → 10/00
2.4 quattro	Petrol	120	02/99 → 06/00
2.6	Petrol	110	01/95 → 07/98

RP02A

KW

AUDI
A4 (8D2, B5)

2.6 quattro	Petrol	110	01/95 → 07/98
2.8	Petrol	128	09/95 → 07/97
2.8	Petrol	142	10/96 → 06/00
2.8 quattro	Petrol	128	01/95 → 07/97
S4 quattro	Petrol	195	10/97 → 10/00

A4 (8E2, B6)

1.6	Petrol	75	11/00 → 12/04
1.8 T	Petrol	125	07/01 → 12/04
2.0	Petrol	96	11/00 → 12/04
3.0	Petrol	160	04/01 → 12/04
3.0	Petrol	162	12/00 → 12/04
3.0 quattro	Petrol	160	04/01 → 12/04
3.0 quattro	Petrol	162	11/00 → 12/04
S4 quattro	Petrol	253	03/03 → 12/04

A4 (8EC, B7)

1.6	Petrol	75	11/04 → 06/08
2.0	Petrol	96	11/04 → 06/08

A4 Avant (8D5, B5)

1.6	Petrol	74	11/94 → 09/01
1.6	Petrol	75	07/00 → 09/01
1.8 quattro	Petrol	92	01/96 → 09/01
1.8 T	Petrol	110	03/96 → 09/01
1.8 T	Petrol	132	12/97 → 09/01
1.8 T quattro	Petrol	132	12/97 → 09/01
2.4	Petrol	120	08/98 → 09/01
2.4	Petrol	121	08/97 → 09/01
2.4 quattro	Petrol	120	08/98 → 06/00
2.4 quattro	Petrol	121	08/97 → 09/01
2.6	Petrol	110	02/96 → 07/98
2.6 quattro	Petrol	110	01/96 → 07/98
2.8 quattro	Petrol	142	10/96 → 09/01
RS4 quattro	Petrol	280	05/00 → 09/01
S4 quattro	Petrol	195	10/97 → 09/01

A4 Avant (8E5, B6)

1.6	Petrol	75	09/01 → 12/04
2.0	Petrol	96	09/01 → 12/04
2.4	Petrol	125	09/01 → 12/04
3.0	Petrol	162	09/01 → 12/04
3.0	Petrol	160	09/01 → 12/04
3.0 quattro	Petrol	162	09/01 → 12/04
3.0 quattro	Petrol	160	09/01 → 12/04
S4 quattro	Petrol	253	03/03 → 12/04

RP02A



AUDI

A4 Avant (8ED, B7)

1.6	Petrol	75	11/04 → 06/08
2.0	Petrol	96	11/04 → 06/08

A4 Cabriolet (8H7, B6, 8HE, B7)

2.0	Petrol	96	09/04 → 11/05
2.4	Petrol	125	04/02 → 11/05
3.0	Petrol	162	04/02 → 11/05
3.0 quattro	Petrol	162	06/03 → 11/05
S4 quattro	Petrol	253	03/04 → 03/09

A6 (4A, C4)

1.8	Petrol	92	12/95 → 10/97
1.8 quattro	Petrol	92	12/95 → 10/97
2.6	Petrol	110	06/94 → 10/97
2.6 quattro	Petrol	110	06/94 → 10/97
2.8	Petrol	128	06/94 → 10/97
2.8	Petrol	142	12/95 → 10/97
2.8 quattro	Petrol	128	06/94 → 10/97
2.8 quattro	Petrol	142	12/95 → 10/97
S6 Turbo quattro	Petrol	169	06/94 → 10/97

A6 (4B2, C5)

1.8	Petrol	92	12/97 → 04/01
1.8 T	Petrol	132	12/97 → 10/00
1.8 T quattro	Petrol	132	12/97 → 10/00
1.8 T quattro	Petrol	110	04/97 → 05/04
2.0	Petrol	96	08/01 → 05/04
2.4	Petrol	115	04/98 → 04/01
2.4	Petrol	121	04/97 → 01/05
2.4	Petrol	125	08/01 → 05/04
2.4 quattro	Petrol	115	08/98 → 07/99
2.4 quattro	Petrol	120	06/97 → 05/00
2.4 quattro	Petrol	125	08/01 → 05/04
2.7 T	Petrol	169	02/99 → 05/01
2.7 T quattro	Petrol	169	12/97 → 08/00
2.7 T quattro	Petrol	184	08/01 → 05/04
2.8	Petrol	132	10/97 → 05/00
2.8	Petrol	140	07/99 → 04/01
2.8	Petrol	142	04/97 → 04/01
2.8 quattro	Petrol	142	04/97 → 05/01
3.0	Petrol	162	08/01 → 05/04
3.0 quattro	Petrol	162	08/01 → 05/04
RS6 quattro	Petrol	331	07/02 → 04/04
S6 quattro	Petrol	250	09/99 → 05/04

RP02A



AUDI

A6 (4F2, C6)

2.4	Petrol	130	05/04 → 10/08
2.4 quattro	Petrol	130	01/05 → 10/08
3.2 FSI	Petrol	188	05/04 → 05/09

A6 Avant (4A, C4)

1.8	Petrol	92	12/95 → 10/97
1.8 quattro	Petrol	92	07/96 → 10/97
2.6	Petrol	110	06/94 → 06/96
2.8	Petrol	128	06/94 → 07/96
2.8 quattro	Petrol	128	07/96 → 10/97
S6 Turbo quattro	Petrol	169	06/94 → 07/97

A6 Avant (4B5, C5)

1.8	Petrol	92	02/98 → 04/01
1.8 T	Petrol	132	04/99 → 10/00
1.8 T	Petrol	110	02/98 → 04/01
1.8 T quattro	Petrol	110	02/98 → 01/05
1.8 T quattro	Petrol	132	02/98 → 10/00
2.0	Petrol	96	08/01 → 01/05
2.4	Petrol	125	08/01 → 01/05
2.4	Petrol	121	12/97 → 04/01
2.4 quattro	Petrol	125	08/01 → 01/05
2.4 quattro	Petrol	115	08/98 → 05/01
2.4 quattro	Petrol	120	12/97 → 05/01
2.4 quattro	Petrol	121	12/97 → 05/01
2.7 T	Petrol	169	02/99 → 05/01
2.7 T quattro	Petrol	184	08/01 → 01/05
2.8	Petrol	132	02/98 → 05/00
2.8	Petrol	140	07/99 → 04/01
2.8	Petrol	142	02/98 → 04/01
2.8 quattro	Petrol	142	02/98 → 05/01
3.0	Petrol	162	08/01 → 01/05
4.2 quattro	Petrol	220	04/99 → 01/05
RS6 plus quattro	Petrol	353	04/04 → 09/04
RS6 quattro	Petrol	331	07/02 → 04/04
S6 quattro	Petrol	250	09/99 → 01/05

A6 Avant (4F5, C6)

2.4	Petrol	130	03/05 → 10/08
3.2 FSI	Petrol	188	03/05 → 10/08

A8 (4D2, 4D8)

2.8	Petrol	120	07/95 → 03/96
2.8	Petrol	128	06/94 → 03/96
2.8 quattro	Petrol	120	07/95 → 03/96
2.8 quattro	Petrol	128	09/94 → 03/96
3.7	Petrol	169	07/95 → 12/98

RP02A

AUDI
A8 (4D2, 4D8)

3.7	Petrol	191	11/98 → 02/01
3.7 quattro	Petrol	169	10/95 → 11/98
3.7 quattro	Petrol	191	11/98 → 09/02
4.2 quattro	Petrol	180	06/94 → 07/96
4.2 quattro	Petrol	220	06/94 → 11/98
6.0 W12 quattro	Petrol	309	03/01 → 08/02
S 8 quattro	Petrol	265	06/99 → 09/02

A8 (4E_)

3.0	Petrol	160	07/03 → 05/06
3.0	Petrol	162	07/03 → 05/05
3.7 quattro	Petrol	206	11/02 → 05/06
4.2 quattro	Petrol	246	11/02 → 07/10
6.0 W12 quattro	Petrol	331	02/04 → 07/10

ALLROAD (4BH, C5)

2.7 T quattro	Petrol	184	05/00 → 08/05
4.2 V8 quattro	Petrol	220	07/02 → 08/05

RP03A
**REGOLATORE PRESSIONE CARBURANTE
FUEL PRESSURE REGULATOR**

AUDI
200 (44, 44Q)

2.2 20V Turbo quattro	Petrol	162	03/89 → 12/90
-----------------------	--------	-----	---------------

200 Avant (44, 44Q)

2.2 20V Turbo quattro	Petrol	162	07/89 → 11/90
-----------------------	--------	-----	---------------

COUPE (89, 8B)

S2 quattro	Petrol	162	09/90 → 09/92
------------	--------	-----	---------------

QUATTRO (85)

2.2 20V Turbo	Petrol	162	08/89 → 07/91
---------------	--------	-----	---------------

RP03A

JAGUAR
XJ (XJ 40, 81)

6 2.9	Petrol	108	10/86 → 08/90
6 2.9	Petrol	117	10/86 → 08/90
6 2.9	Petrol	123	10/86 → 08/90

RENAULT
25 (B29_)

2.8 V6 Injection (B29F)	Petrol	110	06/87 → 12/92
-------------------------	--------	-----	---------------

ESPACE II (J/S63_)

2.8 V6 (J638, J63J)	Petrol	110	01/91 → 09/96
---------------------	--------	-----	---------------

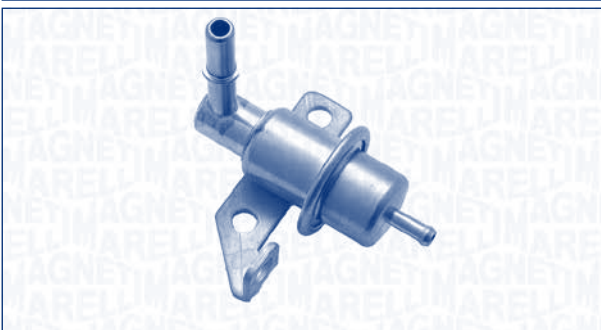
RP04A
**REGOLATORE PRESSIONE CARBURANTE
FUEL PRESSURE REGULATOR**

FORD
COUGAR (EC_)

2.0 16V	Petrol	96	08/98 → 12/00
---------	--------	----	---------------

FOCUS (DAW, DBW)

1.8 16V	Petrol	85	10/98 → 11/04
2.0 16V	Petrol	96	10/98 → 11/04

FOCUS Station wagon (DNW)

1.8 16V	Petrol	85	02/99 → 11/04
2.0 16V	Petrol	96	02/99 → 11/04

FOCUS Tre volumi (DFW)

1.8 16V	Petrol	85	02/99 → 11/04
2.0 16V	Petrol	96	02/99 → 11/04

TOURNEO CONNECT

1.8 16V	Petrol	85	06/02 →
---------	--------	----	---------

TRANSIT CONNECT (P65_, P70_, P80_)

1.8 16V	Petrol	85	06/02 →
---------	--------	----	---------

RP05A

REGOLATORE PRESSIONE CARBURANTE
FUEL PRESSURE REGULATOR

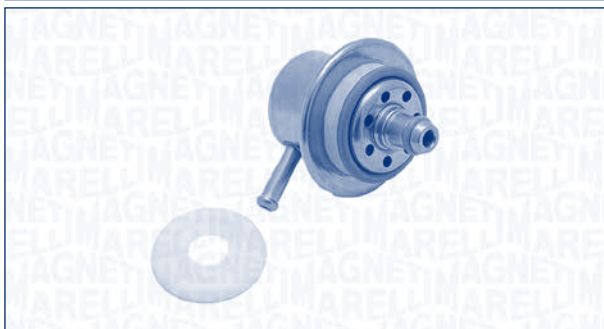

KW



BMW

3 Cabriolet (E36)

325 i Petrol 141 03/93 → 03/95

5 (E34)

525 i 24V Petrol 141 09/89 → 09/95

525 iX 24V Petrol 141 10/91 → 09/95

530 i V8 Petrol 160 09/92 → 09/95

540 i V8 Petrol 210 09/92 → 09/95

5 (E39)

540 i Petrol 210 04/96 → 09/98

5 Touring (E34)

525 i Petrol 141 11/91 → 12/96

525 ix Petrol 141 02/92 → 12/96

530 i V8 Petrol 160 09/92 → 12/96

540 i Petrol 210 10/93 → 12/96

7 (E32)

730 i,iL V8 Petrol 160 04/92 → 09/94

740 i,iL V8 Petrol 210 04/92 → 09/94

7 (E38)

730 i,iL Petrol 155 10/94 → 12/96

730 i,iL Petrol 160 10/94 → 12/96

735 i,iL Petrol 173 01/96 → 09/98

740 i,iL Petrol 210 01/96 → 06/96

740 i,iL Petrol 210 10/94 → 09/98

8 (E31)

840 Ci Petrol 210 01/96 → 12/99

840 i Petrol 210 02/93 → 02/96

RP06A

REGOLATORE PRESSIONE CARBURANTE
FUEL PRESSURE REGULATOR



KW



BMW

3 (E30)

318 is Petrol 100 09/89 → 08/91

316 i Petrol 73 09/90 → 09/93

316 i Petrol 75 09/90 → 09/93

318 i Petrol 83 12/90 → 10/93

320 i Petrol 110 09/90 → 02/98

3 Cabriolet (E36)

320 i Petrol 110 12/93 → 12/95

3 Compact (E36)

318 ti Petrol 103 07/95 → 08/00

3 Coupé (E36)

320 i Petrol 110 03/92 → 12/95

5 (E34)

520 i 24V Petrol 110 09/89 → 09/95

5 Touring (E34)

520 i Petrol 110 11/91 → 12/96

7 (E32)

750 i,iL V12 Petrol 220 01/92 → 09/94

8 (E31)

850 CSi Petrol 280 04/93 → 10/96

850 i,Ci Petrol 220 01/92 → 10/94

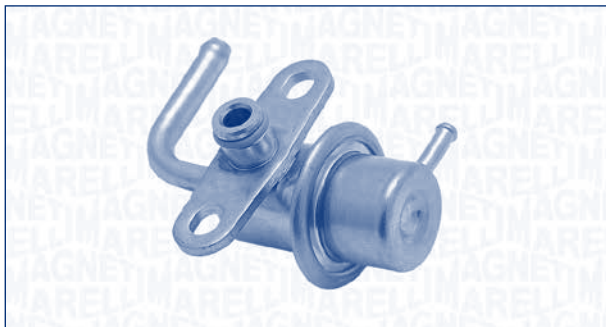
RP07A
**REGOLATORE PRESSIONE CARBURANTE
FUEL PRESSURE REGULATOR**

SUZUKI
BALENO (EG)

1.3 i 16V	Petrol	63	07/95 → 05/02
1.6 i 16V	Petrol	72	07/95 → 05/02
1.6 i 16V 4x4	Petrol	72	07/95 → 05/02

BALENO 2 volumi /Coda spiovente (EG)

1.3 i 16V	Petrol	63	07/95 → 05/02
1.6 i 16V	Petrol	72	07/95 → 05/02
1.6 i 16V 4x4	Petrol	72	07/95 → 05/02

BALENO Station wagon (EG)

1.3 16V	Petrol	63	03/97 → 05/02
---------	--------	----	---------------

SWIFT II 2 volumi /Coda spiovente (EA, MA)

1.3	Petrol	63	06/01 → 12/03
1.3 (SF413, AB35)	Petrol	50	06/96 → 05/01

SWIFT II Tre volumi (AH, AJ)

1.3 (SF413, AH35, MA)	Petrol	50	06/96 → 05/01
-----------------------	--------	----	---------------

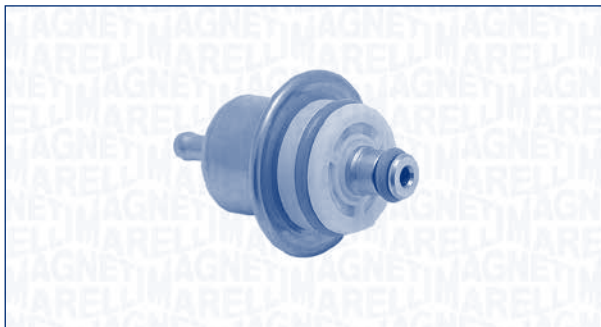
RP08A
**REGOLATORE PRESSIONE CARBURANTE
FUEL PRESSURE REGULATOR**

FORD
FIESTA IV (JA_, JB_)

1.25 i 16V	Petrol	55	11/95 → 12/99
------------	--------	----	---------------

PUMA (EC_)

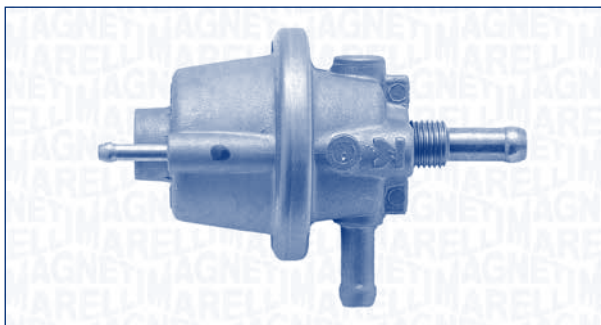
1.4 16V	Petrol	66	01/98 → 10/00
---------	--------	----	---------------

RP7/01
**REGOLATORE PRESSIONE CARBURANTE
FUEL PRESSURE REGULATOR**

ALFA ROMEO
155 (167)

2.0 16V Turbo Q4	Petrol	140	01/92 → 12/97
2.0 16V Turbo Q4 (167.A2B, 167.A2C, 167.A2E)	Petrol	137	01/92 → 12/97

LANCIA
DELTA I (831AB0)

1.6 HF Turbo	Petrol	122	08/86 → 05/93
1.6 HF Turbo (831AB.020S)	Petrol	97	04/87 → 03/89
2.0 16V HF Evo Integrale (831AB.027)	Petrol	155	06/93 → 01/94

RP7/01



LANCIA

DELTA I (831AB0)

2.0 16V HF Integrale (831AB.026)	Petrol	144	03/89 → 09/91
----------------------------------	--------	-----	---------------

2.0 HF Integrale (831AB.024)	Petrol	133	10/87 → 02/89
------------------------------	--------	-----	---------------

RPM36

**REGOLATORE PRESSIONE CARBURANTE
FUEL PRESSURE REGULATOR**



CITROËN

EVASION (22, U6)

1.8	Petrol	73	05/97 → 07/02	ENGINE: XU7JP
-----	--------	----	---------------	---------------

2.0	Petrol	89	06/94 → 07/02	ENGINE: XU10J2CZ
-----	--------	----	---------------	------------------

JUMPER Autobus (230P)

2.0	Petrol	80	02/94 → 04/02	ENGINE: XU10J2U
-----	--------	----	---------------	-----------------

JUMPER Furgonato (230L)

2.0	Petrol	80	03/94 → 04/02	ENGINE: XU10J2U
-----	--------	----	---------------	-----------------

XANTIA (X1)

1.6 i	Petrol	65	01/97 → 01/98	ENGINE: XU5JPZ
-------	--------	----	---------------	----------------

1.8 i	Petrol	74	03/93 → 01/98	ENGINE: XU7JPZ
-------	--------	----	---------------	----------------

2.0 i	Petrol	89	03/93 → 01/98	ENGINE: XU10J2CK
-------	--------	----	---------------	------------------

XSARA (N1)

1.8 i Aut.	Petrol	74	04/97 → 09/00	ENGINE: XU7JPL3
------------	--------	----	---------------	-----------------

ZX (N2)

1.6 i	Petrol	65	03/91 → 06/97	ENGINE: XU5JPZ
-------	--------	----	---------------	----------------

1.8 i	Petrol	74	07/92 → 06/97	ENGINE: XU7JPK,TR
-------	--------	----	---------------	-------------------

2.0 i	Petrol	89	07/92 → 06/97	ENGINE: XU10J2CK
-------	--------	----	---------------	------------------

FIAT

COUPE (FA/175)

2.0 16V Turbo	Petrol	140	11/93 → 08/96
---------------	--------	-----	---------------

RPM36



FIAT

DUCATO Autobus (230)

2.0 Panorama/ Combinato	Petrol	80	03/94 → 04/02	ENGINE: XU10J2U
-------------------------	--------	----	---------------	-----------------

DUCATO Furgonato (230L)

2.0	Petrol	80	03/94 → 04/02	ENGINE: XU10J2U
-----	--------	----	---------------	-----------------

DUCATO Pianale piatto/Telaio (230)

2.0	Petrol	80	06/98 → 04/02	ENGINE: XU10J2U
-----	--------	----	---------------	-----------------

PALIO Weekend (178DX)

1.2 (178DX.G1A)	Petrol	54	04/96 → 02/01
-----------------	--------	----	---------------

PUNTO (176)

75 1.2	Petrol	54	01/94 → 12/97
--------	--------	----	---------------

TEMPRA (159)

1.8 i.e. (159.AV)	Petrol	76	09/93 → 08/96
-------------------	--------	----	---------------

1.8 i.e. (159.BY)	Petrol	74	10/94 → 08/96
-------------------	--------	----	---------------

TEMPRA S.W. (159)

1.8 i.e. (159.AV)	Petrol	76	09/93 → 08/96
-------------------	--------	----	---------------

1.8 i.e. (159.BY)	Petrol	74	10/94 → 08/96
-------------------	--------	----	---------------

TIPO (160)

1.8 i.e.	Petrol	66	09/93 → 04/95
----------	--------	----	---------------

1.8 i.e. (160.ED)	Petrol	76	04/93 → 04/95
-------------------	--------	----	---------------

1.8 i.e. (160.EQ, 160.AM)	Petrol	74	10/94 → 04/95
---------------------------	--------	----	---------------

ULYSSE (220)

1.8 (220.BB5)	Petrol	73	05/97 → 08/02	ENGINE: XU7JP
---------------	--------	----	---------------	---------------

2.0 (220.AC5)	Petrol	89	06/94 → 08/02	ENGINE: XU10J2CZ
---------------	--------	----	---------------	------------------

LANCIA

DEDRA (835)

1.8 i.e. (835FA)	Petrol	74	07/94 → 12/97
------------------	--------	----	---------------

DEDRA SW (835)

1.8 i.e. (835FA)	Petrol	74	07/94 → 12/97
------------------	--------	----	---------------

DELTA II (836)

1.8 i.e. (836AE)	Petrol	76	06/93 → 12/97
------------------	--------	----	---------------

1.8 i.e. (836AG, 836AL)	Petrol	66	07/94 → 12/97
-------------------------	--------	----	---------------

2.0 16V Turbo (836AB)	Petrol	137	06/93 → 12/97
-----------------------	--------	-----	---------------

PEUGEOT

106 I (1A, 1C)

1.3	Petrol	72	10/93 → 04/96	ENGINE: TU2J2
-----	--------	----	---------------	---------------

306 (7B, N3, N5)

1.8 16V	Petrol	81	03/97 → 05/01	ENGINE: XU7JP,K
---------	--------	----	---------------	-----------------

1.8 ST	Petrol	74	06/94 → 05/01	ENGINE: XU7JP,L3
--------	--------	----	---------------	------------------

2.0 ST	Petrol	89	07/94 → 05/01	ENGINE: XU10J2CK
--------	--------	----	---------------	------------------

306 Break (7E, N3, N5)

1.8	Petrol	74	03/97 → 04/02	ENGINE: XU7JP,L3
-----	--------	----	---------------	------------------

RPM36

PEUGEOT
405 II (4B)

1.6	Petrol	65	08/92 → 10/95	ENGINE: XU5JPZ
1.8	Petrol	74	08/92 → 10/95	ENGINE: XU7JPK,TR
2.0	Petrol	89	08/92 → 10/95	ENGINE: XU10J2CZ
2.0 X4	Petrol	89	08/92 → 10/95	ENGINE: XU10J2CZ

406 (8B)

1.6	Petrol	65	11/95 → 12/97	ENGINE: XU5JPZ
-----	--------	----	---------------	----------------

806 (221)

2.0	Petrol	89	06/94 → 08/02	ENGINE: XU10J2CZ
-----	--------	----	---------------	------------------

BOXER Autobus (230P)

2.0 i	Petrol	80	03/94 → 04/02	ENGINE: XU10J2U
-------	--------	----	---------------	-----------------

BOXER Furgonato (230L)

2.0 i	Petrol	80	06/94 → 04/02	ENGINE: XU10J2U
-------	--------	----	---------------	-----------------

BOXER Pianale piatto/Telaio (ZCT_)

2.0 i	Petrol	80	06/94 → 04/02	ENGINE: XU10J2U
-------	--------	----	---------------	-----------------

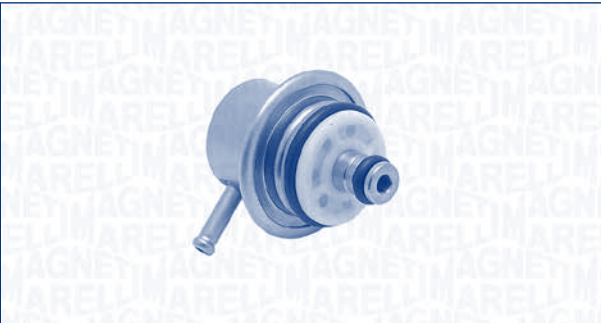
RPM40
**REGOLATORE PRESSIONE CARBURANTE
FUEL PRESSURE REGULATOR**

CITROËN
BERLINGO (MF)

1.8 i (MFLFX)	Petrol	66	05/97 →	ENGINE: XU7JB
---------------	--------	----	---------	---------------

XANTIA (X1)

1.8 i	Petrol	66	04/97 → 01/98	ENGINE: XU7JB
-------	--------	----	---------------	---------------

XSARA (N1)

1.4 i	Petrol	55	04/97 → 03/05	ENGINE: TU3JPL,3
-------	--------	----	---------------	------------------

1.8 i	Petrol	66	04/97 → 09/00	ENGINE: XU7JB
-------	--------	----	---------------	---------------

2.0 16V	Petrol	120	04/97 → 09/00	ENGINE: XU10J4RS
---------	--------	-----	---------------	------------------

XSARA Coupé (N0)

2.0 i 16V	Petrol	120	02/98 → 03/05	ENGINE: XU10J4RS
-----------	--------	-----	---------------	------------------

ZX (N2)

1.4 i	Petrol	55	03/91 → 06/97	ENGINE: TU3JPL,3
-------	--------	----	---------------	------------------

RPM40

FIAT
BRAVA (182)

1.6 16V (182.BH)	Petrol	66	10/95 → 12/97	
------------------	--------	----	---------------	--

BRAVO I (182)

1.6 16V (182.AH)	Petrol	66	10/95 → 12/97	
------------------	--------	----	---------------	--

COUPE (FA/175)

2.0 16V	Petrol	102	11/93 → 08/96	
---------	--------	-----	---------------	--

PUNTO (176)

1.2 16V	Petrol	63	04/97 → 09/99	
---------	--------	----	---------------	--

PUNTO Cabriolet (176C)

85 16V 1.2	Petrol	63	04/97 → 06/00	
------------	--------	----	---------------	--

TEMPRA (159)

2.0 i.e. (159.AP)	Petrol	83	01/93 → 08/96	
-------------------	--------	----	---------------	--

TIPO (160)

2.0 i.e. (160.AT, 160.AJ)	Petrol	83	01/93 → 04/95	
---------------------------	--------	----	---------------	--

2.0 i.e. 16V Sport (160.EF)	Petrol	102	03/93 → 04/95	
-----------------------------	--------	-----	---------------	--

LANCIA
DEDRA (835)

2.0 16V (835ED)	Petrol	102	07/94 → 07/99	
-----------------	--------	-----	---------------	--

2.0 i.e. (835AL)	Petrol	83	09/89 → 12/97	
------------------	--------	----	---------------	--

DEDRA SW (835)

2.0 16V (835ED)	Petrol	102	07/94 → 07/99	
-----------------	--------	-----	---------------	--

2.0 Integrale (835ED)	Petrol	102	07/94 → 12/97	
-----------------------	--------	-----	---------------	--

DELTA II (836)

2.0 16V (836AA, 836CA)	Petrol	102	06/93 → 12/97	
------------------------	--------	-----	---------------	--

Y (840A)

1.2 16V (840AD)	Petrol	63	04/97 → 09/03	
-----------------	--------	----	---------------	--

MASERATI
3200 GT

3.2 Biturbo V8 32V	Petrol	271	10/98 → 03/02	
--------------------	--------	-----	---------------	--

PEUGEOT
106 I (1A, 1C)

1.6	Petrol	76	01/94 → 04/96	ENGINE: TU5J2
-----	--------	----	---------------	---------------

306 (7B, N3, N5)

1.4 SL	Petrol	55	06/94 → 05/01	ENGINE: TU3JPL,3
--------	--------	----	---------------	------------------

2.0 S16	Petrol	110	06/94 → 05/01	ENGINE: XU10J4RS
---------	--------	-----	---------------	------------------

2.0 S16	Petrol	112	06/94 → 05/01	ENGINE: XU10J4RS
---------	--------	-----	---------------	------------------

306 Break (7E, N3, N5)

1.4	Petrol	55	03/97 → 04/02	ENGINE: TU3JPL,3
-----	--------	----	---------------	------------------

405 II (4B)

2.0 T 16 X4	Petrol	144	08/92 → 10/95	ENGINE: XU10J4TEZ
-------------	--------	-----	---------------	-------------------

RPM40



PEUGEOT

406 (8B)

1.8	Petrol	66	05/97 → 05/04	ENGINE: XU7JB
1.8	Petrol	66	05/97 → 05/04	ENGINE: XU7JPK,TR

RANCH MPV / Space wagon (5F)

1.4	Petrol	55	06/96 →	ENGINE: TU3JPL,3
1.8	Petrol	66	05/97 →	ENGINE: XU7JB

RPM58

**REGOLATORE PRESSIONE CARBURANTE
FUEL PRESSURE REGULATOR**



PEUGEOT

206 2 volumi /Coda spiovente (2A/C)

1.1 i	Petrol	44	09/98 →	
1.4 i	Petrol	55	09/98 →	
2.0 S16	Petrol	100	06/99 →	

206 CC (2D)

2.0 S16	Petrol	100	09/00 →	
---------	--------	-----	---------	--

206 SW (2E/K)

1.1	Petrol	44	07/02 →	
1.4	Petrol	55	07/02 →	
1.4 16V	Petrol	65	10/03 →	
2.0 16V	Petrol	100	07/02 →	

307 (3A/C)

2.0 16V	Petrol	100	08/00 →	
---------	--------	-----	---------	--

307 Break (3E)

2.0	Petrol	100	03/02 →	
-----	--------	-----	---------	--

406 (8B)

2.0 16V	Petrol	100	08/00 → 05/04	
---------	--------	-----	---------------	--

406 Break (8E/F)

2.0 16V	Petrol	100	10/00 → 10/04	
---------	--------	-----	---------------	--

406 Coupé (8C)

2.0 16V	Petrol	100	10/00 → 12/04	
---------	--------	-----	---------------	--

607 (9D, 9U)

2.0	Petrol	100	02/00 →	
-----	--------	-----	---------	--

RPM67

**REGOLATORE PRESSIONE CARBURANTE
FUEL PRESSURE REGULATOR**



FIAT

PALIO Weekend (178DX)

1.6 16V (178DX, D1A)	Petrol	74	04/96 → 02/01	
----------------------	--------	----	---------------	--

KITRPM36

**REGOLATORE PRESSIONE CARBURANTE KIT
FUEL PRESSURE REGULATOR KIT**



CITROËN

EVASION (22, U6)

1.8	Petrol	73	05/97 → 07/02	ENGINE: XU7JP
2.0	Petrol	89	06/94 → 07/02	ENGINE: XU10J2CZ

JUMPER Autobus (230P)

2.0	Petrol	80	02/94 → 04/02	ENGINE: XU10J2U
-----	--------	----	---------------	-----------------

JUMPER Furgonato (230L)

2.0	Petrol	80	03/94 → 04/02	ENGINE: XU10J2U
-----	--------	----	---------------	-----------------

XANTIA (X1)

1.6 i	Petrol	65	01/97 → 01/98	ENGINE: XU5JPZ
1.8 i	Petrol	74	03/93 → 01/98	ENGINE: XU7JPZ

XANTIA (X1)

2.0 i	Petrol	89	03/93 → 01/98	ENGINE: XU10J2CK
-------	--------	----	---------------	------------------

XSARA (N1)

1.8 i Aut.	Petrol	74	04/97 → 09/00	ENGINE: XU7JP, L3
------------	--------	----	---------------	-------------------

KITRPM36

CITROËN
ZX (N2)

1.6 i	Petrol	65	03/91 → 06/97	ENGINE: XU5JPZ
1.8 i	Petrol	74	07/92 → 06/97	ENGINE: XU7JPK,TR
2.0 i	Petrol	89	07/92 → 06/97	ENGINE: XU10J2CK

FIAT
COUPE (FA/175)

2.0 16V Turbo	Petrol	140	11/93 → 08/96	
---------------	--------	-----	---------------	--

DUCATO Autobus (230)

2.0 Panorama/ Combinato	Petrol	80	03/94 → 04/02	ENGINE: XU10J2U
----------------------------	--------	----	---------------	-----------------

DUCATO Furgonato (230L)

2.0	Petrol	80	03/94 → 04/02	ENGINE: XU10J2U
-----	--------	----	---------------	-----------------

DUCATO Pianale piatto/Telaio (230)

2.0	Petrol	80	06/98 → 04/02	ENGINE: XU10J2U
-----	--------	----	---------------	-----------------

PALIO Weekend (178DX)

1.2 (178DX.G1A)	Petrol	54	04/96 → 02/01	
-----------------	--------	----	---------------	--

PUNTO (176)

75 1.2	Petrol	54	01/94 → 12/97	
--------	--------	----	---------------	--

TEMPRA (159)

1.8 i.e. (159.AV)	Petrol	76	09/93 → 08/96	
-------------------	--------	----	---------------	--

1.8 i.e. (159.BY)	Petrol	74	10/94 → 08/96	
-------------------	--------	----	---------------	--

TEMPRA S.W. (159)

1.8 i.e. (159.AV)	Petrol	76	09/93 → 08/96	
-------------------	--------	----	---------------	--

1.8 i.e. (159.BY)	Petrol	74	10/94 → 08/96	
-------------------	--------	----	---------------	--

TIPO (160)

1.8 i.e.	Petrol	66	09/93 → 04/95	
----------	--------	----	---------------	--

1.8 i.e. (160.ED)	Petrol	76	04/93 → 04/95	
-------------------	--------	----	---------------	--

1.8 i.e. (160.EQ, 160.AM)	Petrol	74	10/94 → 04/95	
------------------------------	--------	----	---------------	--

ULYSSE (220)

1.8 (220.BB5)	Petrol	73	05/97 → 08/02	ENGINE: XU7JP
---------------	--------	----	---------------	---------------

2.0 (220.AC5)	Petrol	89	06/94 → 08/02	ENGINE: XU10J2CZ
---------------	--------	----	---------------	------------------

LANCIA
DEDRA (835)

1.8 i.e. (835FA)	Petrol	74	07/94 → 12/97	
------------------	--------	----	---------------	--

DEDRA SW (835)

1.8 i.e. (835FA)	Petrol	74	07/94 → 12/97	
------------------	--------	----	---------------	--

DELTA II (836)

1.8 i.e. (836AE)	Petrol	76	06/93 → 12/97	
------------------	--------	----	---------------	--

1.8 i.e. (836AG, 836AL)	Petrol	66	07/94 → 12/97	
----------------------------	--------	----	---------------	--

2.0 16V Turbo (836AB)	Petrol	137	06/93 → 12/97	
--------------------------	--------	-----	---------------	--

KITRPM36

PEUGEOT
106 I (1A, 1C)

1.3	Petrol	72	10/93 → 04/96	ENGINE: TU2J2
-----	--------	----	---------------	---------------

306 (7B, N3, N5)

1.8 16V	Petrol	81	03/97 → 05/01	ENGINE: XU7JP,K
---------	--------	----	---------------	-----------------

1.8 ST	Petrol	74	06/94 → 05/01	ENGINE: XU7JP,L3
--------	--------	----	---------------	------------------

2.0 ST	Petrol	89	07/94 → 05/01	ENGINE: XU10J2CK
--------	--------	----	---------------	------------------

306 Break (7E, N3, N5)

1.8	Petrol	74	03/97 → 04/02	ENGINE: XU7JP,L3
-----	--------	----	---------------	------------------

405 II (4B)

1.6	Petrol	65	08/92 → 10/95	ENGINE: XU5JPZ
-----	--------	----	---------------	----------------

1.8	Petrol	74	08/92 → 10/95	ENGINE: XU7JPK,TR
-----	--------	----	---------------	-------------------

2.0	Petrol	89	08/92 → 10/95	ENGINE: XU10J2CZ
-----	--------	----	---------------	------------------

2.0 X4	Petrol	89	08/92 → 10/95	ENGINE: XU10J2CZ
--------	--------	----	---------------	------------------

406 (8B)

1.6	Petrol	65	11/95 → 12/97	ENGINE: XU5JPZ
-----	--------	----	---------------	----------------

806 (221)

2.0	Petrol	89	06/94 → 08/02	ENGINE: XU10J2CZ
-----	--------	----	---------------	------------------

BOXER Autobus (230P)

2.0 i	Petrol	80	03/94 → 04/02	ENGINE: XU10J2U
-------	--------	----	---------------	-----------------

BOXER Furgonato (230L)

2.0 i	Petrol	80	06/94 → 04/02	ENGINE: XU10J2U
-------	--------	----	---------------	-----------------

BOXER Pianale piatto/Telaio (ZCT_)

2.0 i	Petrol	80	06/94 → 04/02	ENGINE: XU10J2U
-------	--------	----	---------------	-----------------

KITRPM40
**REGOLATORE PRESSIONE CARBURANTE KIT
FUEL PRESSURE REGULATOR KIT**

CITROËN
BERLINGO (MF)

1.8 i (MFLFX)	Petrol	66	05/97 →	ENGINE: XU7JB
---------------	--------	----	---------	---------------

XANTIA (X1)

1.8 i	Petrol	66	04/97 → 01/98	ENGINE: XU7JB
-------	--------	----	---------------	---------------

KITRPM40



CITROËN

XSARA (N1)

1.4 i	Petrol	55	04/97 → 03/05	ENGINE: TU3JPL3
1.8 i	Petrol	66	04/97 → 09/00	ENGINE: XU7JB
2.0 16V	Petrol	120	04/97 → 09/00	ENGINE: XU10J4RS

XSARA Coupé (N0)

2.0 i 16V	Petrol	120	02/98 → 03/05	ENGINE: XU10J4RS
-----------	--------	-----	---------------	------------------

ZX (N2)

1.4 i	Petrol	55	03/91 → 06/97	ENGINE: TU3JPL,3
-------	--------	----	---------------	------------------

FIAT

BRAVA (182)

1.6 16V (182.BH)	Petrol	66	10/95 → 12/97	
------------------	--------	----	---------------	--

BRAVO I (182)

1.6 16V (182.AH)	Petrol	66	10/95 → 12/97	
------------------	--------	----	---------------	--

COUPE (FA/175)

2.0 16V	Petrol	102	11/93 → 08/96	
---------	--------	-----	---------------	--

PUNTO (176)

1.2 16V	Petrol	63	04/97 → 09/99	
---------	--------	----	---------------	--

PUNTO Cabriolet (176C)

85 16V 1.2	Petrol	63	04/97 → 06/00	
------------	--------	----	---------------	--

TEMPRA (159)

2.0 i.e. (159.AP)	Petrol	83	01/93 → 08/96	
-------------------	--------	----	---------------	--

TIPO (160)

2.0 i.e. (160.AT, 160.AJ)	Petrol	83	01/93 → 04/95	
---------------------------	--------	----	---------------	--

2.0 i.e. 16V Sport (160.EF)	Petrol	102	03/93 → 04/95	
-----------------------------	--------	-----	---------------	--

LANCIA

DEDRA (835)

2.0 16V (835ED)	Petrol	102	07/94 → 07/99	
-----------------	--------	-----	---------------	--

2.0 i.e. (835AL)	Petrol	83	09/89 → 12/97	
------------------	--------	----	---------------	--

DEDRA SW (835)

2.0 16V (835ED)	Petrol	102	07/94 → 07/99	
-----------------	--------	-----	---------------	--

2.0 Integrale (835ED)	Petrol	102	07/94 → 12/97	
-----------------------	--------	-----	---------------	--

DELTA II (836)

2.0 16V (836AA, 836CA)	Petrol	102	06/93 → 12/97	
------------------------	--------	-----	---------------	--

Y (840A)

1.2 16V (840AD)	Petrol	63	04/97 → 09/03	
-----------------	--------	----	---------------	--

MASERATI

3200 GT

3.2 Biturbo V8 32V	Petrol	271	10/98 → 03/02	
--------------------	--------	-----	---------------	--

KITRPM40



PEUGEOT

106 I (1A, 1C)

1.6	Petrol	76	01/94 → 04/96	ENGINE: TU5J2
-----	--------	----	---------------	---------------

306 (7B, N3, N5)

1.4 SL	Petrol	55	06/94 → 05/01	ENGINE: TU3JPL,3
--------	--------	----	---------------	------------------

2.0 S16	Petrol	110	06/94 → 05/01	ENGINE: XU10J4RS
---------	--------	-----	---------------	------------------

2.0 S16	Petrol	112	06/94 → 05/01	ENGINE: XU10J4RS
---------	--------	-----	---------------	------------------

306 Break (7E, N3, N5)

1.4	Petrol	55	03/97 → 04/02	ENGINE: TU3JPL,3
-----	--------	----	---------------	------------------

405 II (4B)

2.0 T 16 X4	Petrol	144	08/92 → 10/95	ENGINE: XU10J4TEZ
-------------	--------	-----	---------------	-------------------

406 (8B)

1.8	Petrol	66	05/97 → 05/04	ENGINE: XU7JB
-----	--------	----	---------------	---------------

1.8	Petrol	66	05/97 → 05/04	ENGINE: XU7JPK,TR
-----	--------	----	---------------	-------------------

RANCH MPV / Space wagon (5F)

1.4	Petrol	55	06/96 →	ENGINE: TU3JPL,3
-----	--------	----	---------	------------------

1.8	Petrol	66	05/97 →	ENGINE: XU7JB
-----	--------	----	---------	---------------

GRUPPO F - GROUP F

816001633701

**F1 KIT SENSORE TEMPERATURA ACQUA
WATER TEMPERATURE SENSOR KIT**



FIAT

DOBLO (119)

1.2 (223AXA1A)	Petrol	48	03/01 → 01/02	
----------------	--------	----	---------------	--

DOBLO Cargo (223)

1.2 (223ZX1A)	Petrol	48	03/01 → 01/02	
---------------	--------	----	---------------	--

PANDA (141A_)

1100	Petrol	40	01/01 → 01/02	
------	--------	----	---------------	--

PUNTO (188)

1.2 60 (188.030, .050, .130, .150, .230, .250)	Petrol	44	09/99 → 01/02	
--	--------	----	---------------	--

816001633701

FIAT
PUNTO Van (188AX)

1.2 60	Petrol	44	02/00 → 01/02
--------	--------	----	---------------

SEICENTO (187)

1.1 (187AXB, 187AXB1A)	Petrol	40	01/01 → 01/02
------------------------	--------	----	---------------

SEICENTO Van (187)

1.1 (187CXB/C)	Petrol	40	01/01 → 01/02
----------------	--------	----	---------------

SZA101
F1 **SENSORE TEMPERATURA ACQUA**
WATER TEMPERATURE SENSOR

CITROËN
BERLINGO (MF)

1.8 i (MFLFX)	Petrol	66	05/97 →	ENGINE: XU7JB
---------------	--------	----	---------	---------------

EVASION (22, U6)

1.8	Petrol	73	05/97 → 07/02	ENGINE: XU7JP
2.0	Petrol	89	06/94 → 07/02	ENGINE: XU10J2CZ

JUMPER Autobus (230P)

2.0	Petrol	80	02/94 → 04/02	ENGINE: XU10J2U
-----	--------	----	---------------	-----------------

JUMPER Furgonato (230L)

2.0	Petrol	80	03/94 → 04/02	ENGINE: XU10J2U
-----	--------	----	---------------	-----------------

XANTIA (X1)

1.6 i	Petrol	65	03/93 → 01/98	ENGINE: XU5JPZ
1.8 i	Petrol	66	04/97 → 01/98	ENGINE: XU7JB
1.8 i	Petrol	74	03/93 → 01/98	ENGINE: XU7JPK,TR
2.0 i	Petrol	89	03/93 → 01/98	ENGINE: XU10J2CK

XSARA (N1)

1.4 i	Petrol	55	04/97 → 03/05	ENGINE: TU3JPL3
1.8 i	Petrol	66	04/97 → 09/00	ENGINE: XU7JB
1.8 i Aut.	Petrol	74	04/97 → 09/00	ENGINE: XU7JPL3
2.0 16V	Petrol	120	04/97 → 09/00	ENGINE: XU10J4RS

XSARA Coupé (N0)

2.0 i 16V	Petrol	120	02/98 → 03/05	ENGINE: XU10J4RS
-----------	--------	-----	---------------	------------------

SZA101

CITROËN
ZX (N2)

1.4 i	Petrol	55	03/91 → 06/97	ENGINE: TU3JPL,3
1.6 i	Petrol	65	03/91 → 06/97	ENGINE: XU5JPZ
1.8 i	Petrol	74	07/92 → 06/97	ENGINE: XU7JPK,TR
2.0 i	Petrol	89	07/92 → 06/97	ENGINE: XU10J2CK

FIAT
DUCATO Autobus (230)

2.0 Panorama/ Combinato	Petrol	80	03/94 → 04/02	ENGINE: XU10J2U
-------------------------	--------	----	---------------	-----------------

DUCATO Furgonato (230L)

2.0	Petrol	80	03/94 → 04/02	ENGINE: XU10J2U
-----	--------	----	---------------	-----------------

DUCATO Pianale piatto/Telaio (230)

2.0	Petrol	80	06/98 → 04/02	ENGINE: XU10J2U
-----	--------	----	---------------	-----------------

ULYSSE (220)

1.8 (220.BB5)	Petrol	73	05/97 → 08/02	ENGINE: XU7JP
2.0 (220.AC5)	Petrol	89	06/94 → 08/02	ENGINE: XU10J2CZ

PEUGEOT
106 I (1A, 1C)

1.3	Petrol	72	10/93 → 04/96	ENGINE: TU2J2
-----	--------	----	---------------	---------------

306 (7B, N3, N5)

1.4 SL	Petrol	55	06/94 → 05/01	ENGINE: TU3JPL,3
1.8 16V	Petrol	81	03/97 → 05/01	ENGINE: XU7JP,K
1.8 ST	Petrol	74	06/94 → 05/01	ENGINE: XU7JPL,3
2.0 S16	Petrol	110	06/94 → 05/01	ENGINE: XU10J4RS
2.0 S16	Petrol	112	06/94 → 05/01	ENGINE: XU10J4RS
2.0 ST	Petrol	89	07/94 → 05/01	ENGINE: XU10J2CK

306 Break (7E, N3, N5)

1.4	Petrol	55	03/97 → 04/02	ENGINE: TU3JPL,3
1.8	Petrol	74	03/97 → 04/02	ENGINE: XU7JP,L3

405 II (4B)

1.6	Petrol	65	08/92 → 10/95	ENGINE: XU5JPZ
1.8	Petrol	74	08/92 → 10/95	ENGINE: XU7JPK,TR
2.0	Petrol	89	08/92 → 10/95	ENGINE: XU10J2CZ
2.0 T 16 X4	Petrol	144	08/92 → 10/95	ENGINE: XU10J4TEZ
2.0 X4	Petrol	89	08/92 → 10/95	ENGINE: XU10J2CZ

406 (8B)

1.6	Petrol	65	11/95 → 05/04	ENGINE: XU5JPZ
1.8	Petrol	66	05/97 → 05/04	ENGINE: XU7JPK,TR

806 (221)

2.0	Petrol	89	06/94 → 08/02	ENGINE: XU10J2CZ
-----	--------	----	---------------	------------------

BOXER Autobus (230P)

2.0 i	Petrol	80	03/94 → 04/02	ENGINE: XU10J2U
-------	--------	----	---------------	-----------------

BOXER Furgonato (230L)

2.0 i	Petrol	80	06/94 → 04/02	ENGINE: XU10J2U
-------	--------	----	---------------	-----------------

SZA101



PEUGEOT

BOXER Pianale piatto/Telaio (ZCT_)

2.0 i Petrol 80 06/94 → 04/02 ENGINE: XU10J2U

RANCH MPV / Space wagon (5F)

1.4 Petrol 55 06/96 → ENGINE: TU3JPL,3

1.8 Petrol 66 05/97 → ENGINE: XU7JB

SZA102

F1 **SENSORE TEMPERATURA ACQUA**
WATER TEMPERATURE SENSOR



CITROËN

AX (ZA-_)

10 Petrol 37 07/92 → 12/98 ENGINE: TU1ML3

11 Petrol 44 10/89 → 12/97 ENGINE: TU1MZ

BX (XB-_)

16 E Petrol 65 01/91 → 02/93 ENGINE: XU5MZ

XM (Y3)

2.0 i Petrol 89 05/89 → 06/94 ENGINE: XU10J2K

ZX (N2)

1.4 i Petrol 55 03/91 → 06/97 ENGINE: TU3MC

1.6 i Petrol 65 03/91 → 06/97 ENGINE: XU5M3K

PEUGEOT

106 I (1A, 1C)

1.1 Petrol 44 09/91 → 04/96 ENGINE: TU1MZ

205 II (20A/C)

1.1 Petrol 44 01/92 → 09/98 ENGINE: TU1ML3

1.6 Aut. Petrol 65 01/91 → 09/98 ENGINE: XU5M3Z

306 (7B, N3, N5)

1.1 Petrol 44 06/94 → 05/01 ENGINE: TU1MZ

1.4 SL Petrol 55 06/94 → 05/01 ENGINE: TU3MC

306 Break (7E, N3, N5)

1.4 Petrol 55 03/97 → 04/02 ENGINE: TU3MC

SZA102



PEUGEOT

309 II (3C, 3A)

1.6 Petrol 65 01/91 → 12/93 ENGINE: XU5MZ

405 I (15B)

1.6 Petrol 66 10/89 → 12/92 ENGINE: XU5MZ

1.6 Petrol 65 01/91 → 12/92 ENGINE: XU5M2Z

605 (6B)

2.0 Petrol 84 06/89 → 09/99 ENGINE: XU10MZ

2.0 Petrol 89 06/89 → 09/99 ENGINE: XU10J2K

SZA103

F1 **SENSORE TEMPERATURA ACQUA**
WATER TEMPERATURE SENSOR



ALFA ROMEO

155 (167)

2.0 16V Turbo Q4 Petrol 140 01/92 → 12/97

2.0 16V Turbo Q4 (167.A2B, 167.A2C, 167.A2E) Petrol 137 01/92 → 12/97

FIAT

CINQUECENTO (170)

0.9 i.e. S (170AF, 170CF) Petrol 29 07/91 → 01/98

1.1 Sporting (170AH) Petrol 40 10/94 → 01/98

COUPE (FA/175)

2.0 16V Petrol 102 11/93 → 08/96

2.0 16V Turbo Petrol 140 11/93 → 08/96

CROMA (154)

2000 i.e. (154.AM, 154.LM) Petrol 85 01/91 → 01/92

SZA103

KW

FIAT
PANDA (141A_)

900	Petrol	29	04/92 → 12/96
1100	Petrol	40	02/95 → 08/00
1100	Petrol	37	05/91 → 12/99
1000 i.e. Cat.	Petrol	33	10/87 → 08/98
1100 4x4	Petrol	40	02/95 → 07/04
1100 Trekking 4x4	Petrol	37	10/91 → 07/04

PUNTO (176)

1.2 16V	Petrol	63	04/97 → 09/99
55 1.1	Petrol	40	09/93 → 09/99
60 1.2	Petrol	44	03/94 → 09/99

PUNTO Cabriolet (176C)

60 1.2	Petrol	44	05/95 → 06/00
85 16V 1.2	Petrol	63	04/97 → 12/99

PUNTO Van (176L)

1.1	Petrol	40	04/96 → 02/00
-----	--------	----	---------------

TEMPRA (159)

1.8 i.e. (159.AN)	Petrol	77	03/92 → 08/96
1.8 i.e. (159.AN)	Petrol	81	01/92 → 08/96
1.8 i.e. (159.AV)	Petrol	76	09/93 → 08/96
1.8 i.e. (159.BY)	Petrol	74	10/94 → 08/96
2.0 i.e. (159.AP)	Petrol	83	01/93 → 08/96

TEMPRA S.W. (159)

1.8 i.e. (159.AN)	Petrol	77	03/92 → 12/93
1.8 i.e. (159.AN)	Petrol	81	01/92 → 08/96
1.8 i.e. (159.AV)	Petrol	76	09/93 → 08/96
1.8 i.e. (159.BY)	Petrol	74	10/94 → 08/96
2.0 i.e. 4x4 (159.AP)	Petrol	83	03/92 → 03/95

TIPO (160)

1.8 i.e.	Petrol	66	09/93 → 04/95
1.8 i.e. (160.ED)	Petrol	76	04/93 → 04/95
1.8 i.e. (160.EQ, 160.AM)	Petrol	74	10/94 → 04/95
2.0 16V (160.AV)	Petrol	107	07/91 → 04/95
2.0 i.e. (160.AT, 160.AJ)	Petrol	83	01/93 → 04/95
2.0 i.e. 16V Sport (160.EF)	Petrol	102	03/93 → 04/95

FORD
ESCORT VII (GAL, AAL, ABL)

RS Cosworth 4x4	Petrol	162	02/95 → 10/98
-----------------	--------	-----	---------------

SZA103

KW

LANCIA
DEDRA (835)

1.6 i.e. (835AB)	Petrol	57	08/89 → 03/93
1.8 i.e. (835BD, 835AD)	Petrol	77	09/89 → 07/99
1.8 i.e. (835FA)	Petrol	74	07/94 → 07/99
2.0 16V (835ED)	Petrol	102	07/94 → 07/99
2.0 HF Integrale (835AP)	Petrol	124	11/90 → 12/92
2.0 i.e. (835AL)	Petrol	83	09/89 → 07/99
2.0 i.e. Turbo (835AR)	Petrol	119	04/91 → 12/92

DEDRA SW (835)

1.8 i.e. (835FA)	Petrol	74	07/94 → 07/99
2.0 16V (835ED)	Petrol	102	07/94 → 07/99
2.0 Integrale (835ED)	Petrol	102	07/94 → 07/99

DELTA I (831AB0)

2.0 16V HF Evo Integrale (831AB.027)	Petrol	155	06/93 → 01/94
2.0 16V HF Integrale (831AB.026)	Petrol	144	03/89 → 09/91
2.0 HF Integrale (831AB.024)	Petrol	133	10/87 → 02/89
2.0 HF Integrale (831AB.024S, 831AB.028)	Petrol	130	01/87 → 12/92

DELTA II (836)

1.8 i.e. (836AE)	Petrol	76	06/93 → 08/99
1.8 i.e. (836AG, 836AL)	Petrol	66	07/94 → 08/99
2.0 16V (836AA, 836CA)	Petrol	102	06/93 → 08/99
2.0 16V Turbo (836AB)	Petrol	137	06/93 → 08/99

PRISMA (831AB0)

2.0 i.e. Trazione integrale	Petrol	85	01/88 → 12/89
-----------------------------	--------	----	---------------

Y (840A)

1.1 (840AE)	Petrol	40	11/95 → 09/03
1.2 (840AA, 840AF-1A)	Petrol	44	03/96 → 09/03
1.2 16V (840AD)	Petrol	63	04/97 → 09/03

SZA103



MASERATI

228

2.8 i Petrol 184 01/88 → 12/90

420/430 (69, 78, AF3)

420 i Petrol 138 01/87 → 12/88

BITURBO (70, 77)

2.24V Petrol 180 03/89 → 12/92

4.24V Petrol 180 04/90 → 12/92

BITURBO Coupé

2.0 Petrol 136 01/86 → 04/87

Si 2.0 Petrol 151 09/87 → 12/88

BITURBO Spider

2.0 Petrol 136 01/86 → 04/87

GHIBLI II

2.0 24V Biturbo Petrol 225 01/93 →

QUATTROPORTE IV

2.0 Biturbo Petrol 211 01/97 →

2.8 Biturbo Petrol 209 01/97 →

SHAMAL

3.2 Petrol 240 12/89 → 11/95

SZA104

F1 **SENSORE TEMPERATURA ACQUA**
WATER TEMPERATURE SENSOR

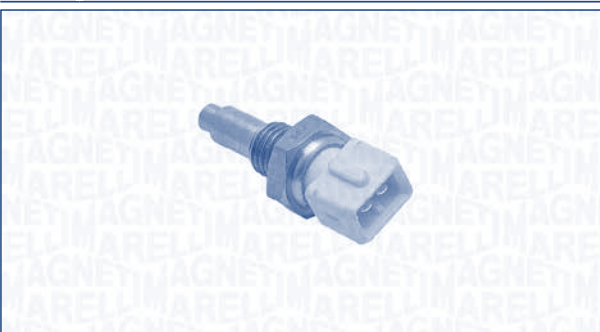

FIAT

BRAVA (182)

1.6 16V (182.BH) Petrol 66 10/95 → 10/01

BRAVO I (182)

1.6 16V (182.AH) Petrol 66 10/95 → 10/01

PALIO Weekend (178DX)

1.6 16V (178DX.D1A) Petrol 74 04/96 → 02/01

SZA105

F1 **SENSORE TEMPERATURA ACQUA**
WATER TEMPERATURE SENSOR

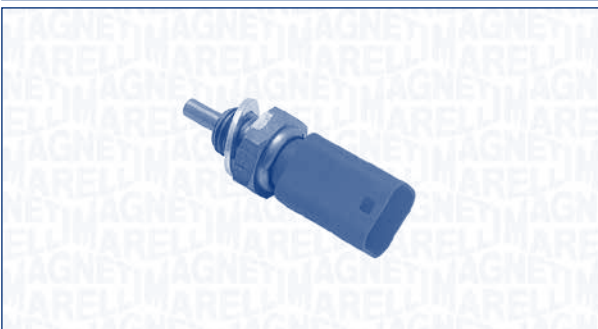

FIAT

BRAVA (182)

1.6 16V (182.BH) Petrol 66 01/01 → 10/01

BRAVO I (182)

1.6 16V (182.AH) Petrol 66 01/01 → 10/01

MULTIPLA (186)

1.6 100 16V (186AXA1A) Petrol 76 01/01 → 06/10

PALIO (178BX)

1.2 Petrol 54 01/01 →

1.6 16V Petrol 74 01/01 →

PALIO Weekend (178DX)

1.2 (178DYA1A) Petrol 44 02/01 →

1.6 16V (178DYC1A06) Petrol 76 02/01 →

PANDA (141A_)

1100 Petrol 40 01/01 → 09/03

1100 4x4 Petrol 40 01/01 → 09/03

1100 Trekking 4x4 Petrol 37 01/01 → 09/03

SIENA (178_)

1.2 Petrol 54 01/01 →

1.6 16V Petrol 78 01/01 →

STRADA Pick-up (178E)

1.2 Petrol 44 04/03 →

1.2 Petrol 54 01/01 →

LANCIA

LYBRA (839AX)

1.6 16V (839AXA1A) Petrol 76 01/01 → 10/05

LYBRA SW (839BX)

1.6 16V (839BXA1A) Petrol 76 01/01 → 10/05

SZA105

LANCIA
Y (840A)

1.2 (840AA, 840AF1A)	Petrol	44	01/01 → 09/03
----------------------	--------	----	---------------

SZA106
F1 **SENSORE TEMPERATURA ACQUA**
WATER TEMPERATURE SENSOR

FIAT
PALIO (178BX)

1.2	Petrol	54	06/98 →
-----	--------	----	---------

PALIO Weekend (178DX)

1.2 (178DX.G1A)	Petrol	54	04/96 → 02/01
-----------------	--------	----	---------------

SIENA (178_)

1.2	Petrol	54	09/98 →
-----	--------	----	---------

STRADA Pick-up (178E)

1.2	Petrol	54	06/99 →
-----	--------	----	---------

SZA107
F1 **SENSORE TEMPERATURA ACQUA**
WATER TEMPERATURE SENSOR

ALFA ROMEO
145 (930)

1.4 i.e.	Petrol	66	07/94 → 12/96
----------	--------	----	---------------

1.4 i.e.	Petrol	66	12/94 → 12/96
----------	--------	----	---------------

33 (907A)

1.4 i.e. (907.A3A, 907.A3B)	Petrol	65	01/92 → 09/94
-----------------------------	--------	----	---------------

1.4 i.e. (907.A3A, 907.A3B)	Petrol	66	01/92 → 09/94
-----------------------------	--------	----	---------------

33 Sportwagon (907B)

1.4 i.e.	Petrol	65	01/92 → 09/94
----------	--------	----	---------------

1.4 i.e.	Petrol	66	01/92 → 09/94
----------	--------	----	---------------

1.4 i.e. 4x4	Petrol	66	01/92 → 09/94
--------------	--------	----	---------------

FIAT
PUNTO (176)

75 1.2	Petrol	54	01/94 → 09/99
--------	--------	----	---------------

SZA108
F1 **SENSORE TEMPERATURA ACQUA**
WATER TEMPERATURE SENSOR

FIAT
PUNTO (176)

75 1.2	Petrol	54	02/98 → 09/98
--------	--------	----	---------------

WTS05-1

F1 **SENSORE TEMPERATURA ACQUA**
WATER TEMPERATURE SENSOR

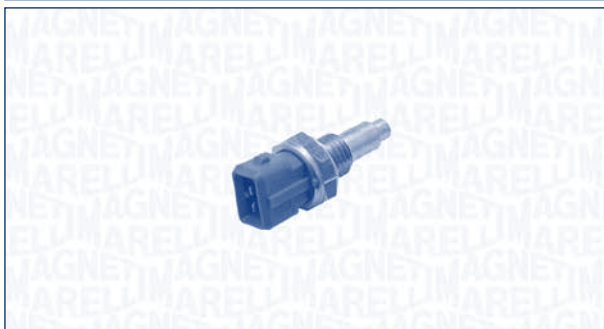

ALFA ROMEO

155 (167)

2.0 16V Turbo Q4 Petrol 140 01/92 → 12/97

2.0 16V Turbo Q4 (167.A2B, 167.A2C, 167.A2E) Petrol 137 01/92 → 12/97

FIAT

CINQUECENTO (170)

0.9 i.e. S (170AF, 170CF) Petrol 29 07/91 → 01/98

1.1 Sporting (170AH) Petrol 40 10/94 → 01/98

COUPE (FA/175)

2.0 16V Petrol 102 11/93 → 08/96

2.0 16V Turbo Petrol 140 11/93 → 08/96

CROMA (154)

2000 i.e. (154.AM, 154.LM) Petrol 85 01/91 → 01/92

PANDA (141A_)

900 Petrol 29 04/92 → 12/96

1100 Petrol 37 05/91 → 12/99

1100 Petrol 40 02/95 → 08/00

1000 i.e. Cat. Petrol 33 10/87 → 08/98

1100 4x4 Petrol 40 02/95 → 07/04

1100 Trekking 4x4 Petrol 37 10/91 → 07/04

PUNTO (176)

1.2 16V Petrol 63 04/97 → 09/99

55 1.1 Petrol 40 09/93 → 09/99

60 1.2 Petrol 44 03/94 → 09/99

PUNTO Cabriolet (176C)

60 1.2 Petrol 44 05/95 → 06/00

85 16V 1.2 Petrol 63 04/97 → 12/99

PUNTO Van (176L)

1.1 Petrol 40 04/96 → 02/00

WTS05-1



FIAT

TEMPRA (159)

1.8 i.e. (159.AN) Petrol 77 03/92 → 08/96

1.8 i.e. (159.AN) Petrol 81 01/92 → 08/96

1.8 i.e. (159.AV) Petrol 76 09/93 → 08/96

1.8 i.e. (159.BY) Petrol 74 10/94 → 08/96

2.0 i.e. (159.AP) Petrol 83 01/93 → 08/96

TEMPRA S.W. (159)

1.8 i.e. (159.AN) Petrol 77 03/92 → 12/93

1.8 i.e. (159.AN) Petrol 81 01/92 → 08/96

1.8 i.e. (159.AV) Petrol 76 09/93 → 08/96

1.8 i.e. (159.BY) Petrol 74 10/94 → 08/96

TEMPRA S.W. (159)

2.0 i.e. 4x4 (159.AP) Petrol 83 03/92 → 03/95

TIPO (160)

1.8 i.e. Petrol 66 09/93 → 04/95

1.8 i.e. (160.ED) Petrol 76 04/93 → 04/95

1.8 i.e. (160.EQ, 160.AM) Petrol 74 10/94 → 04/95

2.0 16V (160.AV) Petrol 107 07/91 → 04/95

2.0 i.e. (160.AT, 160.AJ) Petrol 83 01/93 → 04/95

2.0 i.e. 16V Sport (160.EF) Petrol 102 03/93 → 04/95

FORD

ESCORT VII (GAL, AAL, ABL)

RS Cosworth 4x4 Petrol 162 02/95 → 10/98

LANCIA

DEDRA (835)

1.6 i.e. (835AB) Petrol 57 08/89 → 03/93

1.8 i.e. (835BD, 835AD) Petrol 77 09/89 → 07/99

1.8 i.e. (835FA) Petrol 74 07/94 → 07/99

2.0 16V (835ED) Petrol 102 07/94 → 07/99

2.0 HF Integrale (835AP) Petrol 124 11/90 → 12/92

2.0 i.e. (835AL) Petrol 83 09/89 → 07/99

2.0 i.e. Turbo (835AR) Petrol 119 04/91 → 12/92

DEDRA SW (835)

1.8 i.e. (835FA) Petrol 74 07/94 → 07/99

2.0 16V (835ED) Petrol 102 07/94 → 07/99

2.0 Integrale (835ED) Petrol 102 07/94 → 07/99

WTS05-1

LANCIA
DELTA I (831AB0)

2.0 16V HF Evo Integrale (831AB.027)	Petrol	155	06/93 → 01/94
--	--------	-----	---------------

2.0 16V HF Integrale (831AB.026)	Petrol	144	03/89 → 09/91
--	--------	-----	---------------

2.0 HF Integrale (831AB.024)	Petrol	133	10/87 → 02/89
---------------------------------	--------	-----	---------------

2.0 HF Integrale (831AB.024S, 831AB.028)	Petrol	130	01/87 → 12/92
--	--------	-----	---------------

DELTA II (836)

1.8 i.e. (836AE)	Petrol	76	06/93 → 08/99
------------------	--------	----	---------------

1.8 i.e. (836AG, 836AL)	Petrol	66	07/94 → 08/99
----------------------------	--------	----	---------------

2.0 16V (836AA, 836CA)	Petrol	102	06/93 → 08/99
---------------------------	--------	-----	---------------

2.0 16V Turbo (836AB)	Petrol	137	06/93 → 08/99
--------------------------	--------	-----	---------------

PRISMA (831AB0)

2.0 i.e. Trazione integrale	Petrol	85	01/88 → 12/89
--------------------------------	--------	----	---------------

Y (840A)

1.1 (840AE)	Petrol	40	11/95 → 09/03
-------------	--------	----	---------------

1.2 (840AA, 840AF1A)	Petrol	44	03/96 → 09/03
-------------------------	--------	----	---------------

1.2 16V (840AD)	Petrol	63	04/97 → 09/03
-----------------	--------	----	---------------

MASERATI
228

2.8 i	Petrol	184	01/88 → 12/90
-------	--------	-----	---------------

420/430 (69, 78, AF3)

420 i	Petrol	138	01/87 → 12/88
-------	--------	-----	---------------

BITURBO (70, 77)

2.24V	Petrol	180	03/89 → 12/92
-------	--------	-----	---------------

4.24V	Petrol	180	04/90 → 12/92
-------	--------	-----	---------------

BITURBO Coupé

2.0	Petrol	136	01/86 → 04/87
-----	--------	-----	---------------

Si 2.0	Petrol	151	09/87 → 12/88
--------	--------	-----	---------------

BITURBO Spider

2.0	Petrol	136	01/86 → 04/87
-----	--------	-----	---------------

GHIBLI II

2.0 24V Biturbo	Petrol	225	01/93 →
-----------------	--------	-----	---------

WTS05-1

MASERATI
QUATTROPORTE IV

2.0 Biturbo	Petrol	211	01/97 →
-------------	--------	-----	---------

2.8 Biturbo	Petrol	209	01/97 →
-------------	--------	-----	---------

SHAMAL

3.2	Petrol	240	12/89 → 11/95
-----	--------	-----	---------------

ATS04-1
**F2 SENSORE TEMPERATURA ARIA
AIR TEMPERATURE SENSOR**

ALFA ROMEO
155 (167)

2.0 16V Turbo Q4	Petrol	140	01/92 → 12/97
------------------	--------	-----	---------------

2.0 16V Turbo Q4 (167.A2B, 167. A2C, 167.A2E)	Petrol	137	01/92 → 12/97
---	--------	-----	---------------

FERRARI
F40

3.0	Petrol	352	01/90 → 06/92
-----	--------	-----	---------------

FIAT
BRAVA (182)

1.6 16V (182.BH)	Petrol	66	10/95 → 10/95
------------------	--------	----	---------------

BRAVO I (182)

1.6 16V (182.AH)	Petrol	66	10/95 → 10/95
------------------	--------	----	---------------

COUPE (FA/175)

2.0 16V	Petrol	102	11/93 → 08/96
---------	--------	-----	---------------

2.0 16V Turbo	Petrol	140	11/93 → 08/96
---------------	--------	-----	---------------

CROMA (154)

2000 i.e. (154.AD)	Petrol	88	01/88 → 09/92
-----------------------	--------	----	---------------

2000 i.e. (154.AM, 154.LM)	Petrol	85	01/91 → 08/96
-------------------------------	--------	----	---------------

PALIO Weekend (178DX)

1.6 16V (178DX. D1A)	Petrol	74	04/96 → 02/01
-------------------------	--------	----	---------------

ATS04-1



KW



FIAT

TEMPRA (159)

1.8 i.e. (159.AN)	Petrol	77	03/92 → 08/92
1.8 i.e. (159.AN)	Petrol	81	01/92 → 08/96
1.8 i.e. (159.AV)	Petrol	76	09/93 → 08/96
1.8 i.e. (159.BY)	Petrol	74	10/94 → 08/96
2.0 i.e. (159.AP)	Petrol	83	01/92 → 08/96

TEMPRA S.W. (159)

1.8 i.e. (159.AN)	Petrol	77	03/92 → 12/92
1.8 i.e. (159.AN)	Petrol	81	01/92 → 08/96
1.8 i.e. (159.AV)	Petrol	76	09/93 → 08/96

TEMPRA S.W. (159)

1.8 i.e. (159.BY)	Petrol	74	10/94 → 08/96
-------------------	--------	----	---------------

2.0 i.e. 4x4
(159.AP)

Petrol	83	03/92 → 03/92
--------	----	---------------

TIPO (160)

1.8 i.e.	Petrol	66	09/93 → 04/95
1.8 i.e. (160.ED)	Petrol	76	04/93 → 04/93
1.8 i.e. (160.EQ, 160.AM)	Petrol	74	10/94 → 04/95
2.0 16V (160.AV)	Petrol	107	07/91 → 04/95
2.0 i.e. (160.AT, 160.AJ)	Petrol	83	01/92 → 04/95
2.0 i.e. 16V Sport (160.EF)	Petrol	102	03/93 → 04/93

FORD

ESCORT VII (GAL, AAL, ABL)

RS Cosworth 4x4	Petrol	162	02/95 → 10/98
-----------------	--------	-----	---------------

LANCIA

DEDRA (835)

1.8 i.e. (835BD, 835AD)	Petrol	77	09/89 → 07/99
1.8 i.e. (835FA)	Petrol	74	07/94 → 07/94
2.0 16V (835ED)	Petrol	102	07/94 → 07/94
2.0 HF Integrale (835AP)	Petrol	124	11/90 → 07/94
2.0 i.e. (835AL)	Petrol	83	09/89 → 07/99
2.0 i.e. Turbo (835AR)	Petrol	119	04/91 → 07/91

DEDRA SW (835)

1.8 i.e. (835FA)	Petrol	74	07/94 → 07/94
2.0 16V (835ED)	Petrol	102	07/94 → 07/94
2.0 Integrale (835ED)	Petrol	102	07/94 → 07/94

ATS04-1



KW



LANCIA

DELTA I (831AB0)

2.0 16V HF Evo Integrale (831AB.027)	Petrol	155	06/93 → 01/94
--	--------	-----	---------------

2.0 16V HF Integrale (831AB.026)	Petrol	144	03/89 → 09/89
--	--------	-----	---------------

2.0 HF Integrale (831AB.024)	Petrol	133	10/87 → 02/89
---------------------------------	--------	-----	---------------

2.0 HF Integrale (831AB.024S, 831AB.028)	Petrol	130	01/87 → 12/92
--	--------	-----	---------------

DELTA II (836)

1.8 i.e. (836AE)	Petrol	76	06/93 → 08/93
------------------	--------	----	---------------

1.8 i.e. (836AG, 836AL)	Petrol	66	07/94 → 08/94
----------------------------	--------	----	---------------

2.0 16V (836AA, 836CA)	Petrol	102	06/93 → 08/93
---------------------------	--------	-----	---------------

2.0 16V Turbo (836AB)	Petrol	137	06/93 → 08/93
--------------------------	--------	-----	---------------

PRISMA (831AB0)

2.0 i.e. Trazione integrale	Petrol	85	01/88 → 12/89
--------------------------------	--------	----	---------------

MASERATI

228

2.8 i	Petrol	184	01/88 → 12/90
-------	--------	-----	---------------

420/430 (69, 78, AF3)

420 i	Petrol	138	01/87 → 12/88
-------	--------	-----	---------------

BITURBO (70, 77)

2.24V	Petrol	180	03/89 → 12/94
-------	--------	-----	---------------

4.24V	Petrol	180	04/90 → 12/94
-------	--------	-----	---------------

425 i	Petrol	138	09/87 → 12/88
-------	--------	-----	---------------

BITURBO Coupé

2.0	Petrol	136	01/86 → 04/87
-----	--------	-----	---------------

Si 2.0	Petrol	151	09/87 → 12/88
--------	--------	-----	---------------

BITURBO Spider

2.0	Petrol	136	01/86 → 04/87
-----	--------	-----	---------------

GHIBLI II

2.0 24V Biturbo	Petrol	225	01/93 →
-----------------	--------	-----	---------

QUATTROPORTE IV

2.0 Biturbo	Petrol	211	01/97 →
-------------	--------	-----	---------

2.8 Biturbo	Petrol	209	01/97 →
-------------	--------	-----	---------

SHAMAL

3.2	Petrol	240	12/89 → 11/95
-----	--------	-----	---------------

ATS08
F2 **SENSORE TEMPERATURA ARIA**
AIR TEMPERATURE SENSOR

AUDI
80 (8C, B4)

2.6 quattro Petrol 110 06/92 → 12/94

80 Avant (8C, B4)

2.6 quattro Petrol 110 07/92 → 07/95

A6 (4A, C4)

2.6 Petrol 110 06/94 → 10/97

2.6 quattro Petrol 110 06/94 → 10/97

2.8 Petrol 142 12/95 → 10/97

2.8 quattro Petrol 142 12/95 → 10/97

A6 (4B2, C5)

RS6 quattro Petrol 331 07/02 → 04/04

A6 Avant (4A, C4)

2.6 Petrol 110 06/94 → 06/96

2.8 Petrol 142 12/95 → 12/97

2.8 quattro Petrol 142 07/96 → 12/97

A6 Avant (4B5, C5)

RS6 plus quattro Petrol 353 04/04 → 09/04

RS6 quattro Petrol 331 07/02 → 04/04

A8 (4D2, 4D8)

3.7 Petrol 169 07/95 → 12/98

3.7 quattro Petrol 169 10/95 → 11/98

4.2 quattro Petrol 180 06/94 → 07/96

4.2 quattro Petrol 220 06/94 → 11/98

CABRIOLET (8G7, B4)

2.6 Petrol 110 01/94 → 08/00

COUPE (89, 8B)

2.6 Petrol 110 08/92 → 12/95

2.6 quattro Petrol 110 08/92 → 12/95

BMW
3 Coupé (E36)

M3 3.0 Petrol 210 10/92 → 01/95

M3 3.0 Petrol 217 01/95 → 10/95

7 (E32)

750 i,iL V12 Petrol 220 09/87 → 09/94

ATS08

FIAT
PUNTO (176)

1.4 GT Turbo Petrol 98 01/94 → 09/96

LANCIA
KAPPA (838A)

2.0 16V Turbo (838AB1AA) Petrol 151 02/95 → 06/98

2.0 20V Turbo (838AM1AA) Petrol 162 06/98 → 12/00

KAPPA Coupé (838)

2.0 20V Turbo (838CM) Petrol 162 06/98 → 03/01

KAPPA SW (838B)

2.0 20V Turbo (838BM1AA) Petrol 162 06/98 → 12/00

ATS09
F2 **SENSORE TEMPERATURA ARIA**
AIR TEMPERATURE SENSOR

BMW
3 (E36)

320 i Petrol 110 10/92 → 02/98

3 Cabriolet (E36)

320 i Petrol 110 12/93 → 12/95

3 Coupé (E36)

320 i Petrol 110 10/92 → 04/99

5 (E34)

520 i 24V Petrol 110 10/92 → 09/95

5 Touring (E34)

520 i Petrol 110 10/92 → 01/97

8 (E31)

840 Ci Petrol 210 01/96 → 12/99

ATS10

F2 **SENSORE TEMPERATURA ARIA**
AIR TEMPERATURE SENSOR



LANCIA

THEISIS (841AX)

2.0 Turbo (841AXA1B03)	Petrol	136	07/02 → 07/09
---------------------------	--------	-----	---------------

OPEL

ASTRA G 2 volumi /Coda spiovente (F48_, F08_)

2.0 OPC	Petrol	141	09/02 → 01/05
2.0 OPC	Petrol	147	11/02 → 01/05

ASTRA G Cabriolet (F67)

2.0 16V Turbo	Petrol	147	11/02 → 10/05
2.0 OPC	Petrol	141	03/02 → 10/05

ASTRA G Coupé (F07_)

2.0 16V Turbo	Petrol	141	08/01 → 05/05
2.0 16V Turbo	Petrol	147	11/02 → 05/05

ASTRA G Station wagon (F35_)

2.0 OPC	Petrol	141	09/02 → 07/04
2.0 OPC	Petrol	147	11/02 → 07/04

ASTRA H (L48)

2.0 Turbo	Petrol	125	03/04 →
2.0 Turbo	Petrol	147	09/04 →
2.0 Turbo	Petrol	177	03/05 →

ASTRA H GTC (L08)

1.9 CDTI	Diesel	110	03/05 →
1.9 CDTI 16V	Diesel	88	03/05 →
2.0 Turbo	Petrol	125	03/05 →
2.0 Turbo	Petrol	147	03/05 →

ASTRA H Station wagon (L35)

2.0 Turbo	Petrol	125	08/04 →
2.0 Turbo	Petrol	147	09/04 →

ASTRA H TwinTop (L67)

1.9 CDTI	Diesel	110	09/05 →
2.0 Turbo	Petrol	125	09/05 →
2.0 Turbo	Petrol	147	09/05 →

ATS10



OPEL

SIGNUM

2.8 V6 Turbo	Petrol	169	09/05 →
--------------	--------	-----	---------

SPEEDSTER

2.0 Turbo	Petrol	147	04/03 →
-----------	--------	-----	---------

VECTRA C

2.8 V6 Turbo	Petrol	169	08/05 →
2.8 V6 Turbo	Petrol	188	08/05 →

VECTRA C GTS

2.8 V6 Turbo	Petrol	169	08/05 →
2.8 V6 Turbo	Petrol	188	08/05 →

VECTRA C Station wagon

2.8 V6 Turbo	Petrol	169	08/05 →
2.8 V6 Turbo	Petrol	188	08/05 →

ZAFIRA A (F75_)

2.0 OPC	Petrol	141	09/01 → 06/05
2.0 OPC	Petrol	147	11/02 → 06/05

ZAFIRA B (A05)

1.9 CDTI	Diesel	110	07/05 →
2.0	Petrol	147	07/05 →
2.0	Petrol	177	01/06 →

PORSCHE

911 (996)

3.6 GT2	Petrol	340	04/01 → 08/05
3.6 GT2	Petrol	355	10/03 → 08/05
3.6 Turbo 4	Petrol	309	06/00 → 08/05
3.6 Turbo 4S	Petrol	331	02/03 → 08/05

911 Cabriolet (996)

3.6 Turbo 4	Petrol	309	10/03 → 08/05
3.6 Turbo 4S	Petrol	331	10/03 → 08/05

CAYENNE (955)

Turbo 4.5	Petrol	331	09/02 → 09/07
-----------	--------	-----	---------------

SAAB

9-3 Cabriolet (YS3F)

1.9 TiD	Diesel	110	01/06 →
---------	--------	-----	---------

9-3 Station wagon

1.9 TiD	Diesel	110	03/05 →
---------	--------	-----	---------

9-5 (YS3E)

1.9 TiD	Diesel	110	01/06 →
---------	--------	-----	---------

9-5 Station wagon (YS3E)

1.9 TiD	Diesel	110	01/06 →
---------	--------	-----	---------

VAUXHALL

ASTRA Mk IV (G) 2 volumi /Coda spiovente

2.0 SRI Turbo	Petrol	141	07/02 → 05/05
---------------	--------	-----	---------------

ASTRA Mk IV (G) Cabriolet

2.0 Turbo	Petrol	141	03/02 → 10/05
-----------	--------	-----	---------------

ATS10

VAUXHALL
ASTRA Mk IV (G) Coupé (F67)

2.0 16V Turbo Petrol 140 09/00 → 08/05

ASTRA Mk V (H) 2 volumi /Coda spiovente

2.0 Turbo Petrol 125 01/04 → 05/09

2.0 Turbo Petrol 147 01/04 → 05/09

2.0 Turbo Petrol 177 01/04 → 05/09

ASTRA Mk V (H) Sport Hatch

1.9 CDTI Diesel 110 02/05 → 11/10

2.0 Turbo Petrol 125 02/05 → 11/10

ASTRA Mk V (H) Station wagon

2.0 Turbo Petrol 125 08/04 → 10/10

2.0 Turbo Petrol 147 08/04 → 10/10

SIGNUM

2.8 V6 Turbo Petrol 169 04/02 → 05/08

VX220

2.0 i Turbo Petrol 147 03/01 → 07/05

ZAFIRA Mk I (A) (F75)

2.0 GSI Turbo Petrol 141 09/01 → 06/05

ATS11
F2 **SENSORE TEMPERATURA ARIA**
AIR TEMPERATURE SENSOR

BMW
3 (E36)

320 i Petrol 110 09/90 → 09/92

M3 3.0 Petrol 210 08/94 → 09/95

M3 3.2 Petrol 236 09/95 → 02/98

3 Cabriolet (E36)

325 i Petrol 141 03/93 → 03/95

M3 3.0 Petrol 210 01/94 → 10/95

M3 3.2 Petrol 236 10/95 → 04/99

3 Coupé (E36)

320 i Petrol 110 03/92 → 09/92

M3 3.2 Petrol 236 10/95 → 04/99

ATS11

BMW
5 (E34)

520 i 24V Petrol 110 09/89 → 09/92

525 i 24V Petrol 141 09/89 → 09/95

525 iX 24V Petrol 141 10/91 → 09/95

530 i V8 Petrol 160 09/92 → 09/95

540 i V8 Petrol 210 09/92 → 09/95

M 3.6 Petrol 232 10/88 → 05/92

M 3.6 Cat. Petrol 232 10/88 → 05/92

M 3.8 Petrol 250 03/92 → 09/95

5 Touring (E34)

520 i Petrol 110 11/91 → 09/92

525 i Petrol 141 11/91 → 01/97

525 ix Petrol 141 02/92 → 01/97

530 i V8 Petrol 160 09/92 → 01/97

540 i Petrol 210 09/93 → 01/97

M 3.8 Petrol 250 09/94 → 01/97

7 (E38)

730 i,iL Petrol 155 10/94 → 11/01

730 i,iL Petrol 160 10/94 → 11/01

740 i,iL Petrol 210 10/94 → 11/01

8 (E31)

840 i Petrol 210 02/93 → 02/96

850 CSi Petrol 280 04/93 → 12/96

850 i,Ci Petrol 220 04/90 → 10/94

Z3 Coupé (E36)

M Petrol 236 02/98 → 06/01

ATS12
F2 **SENSORE TEMPERATURA ARIA**
AIR TEMPERATURE SENSOR

OPEL
ASTRA F (56_, 57_)

1.8 i 16V Petrol 85 11/94 → 09/98

2.0 i 16V Petrol 100 02/95 → 09/98

ATS12



kw



OPEL

ASTRA F 2 volumi /Coda spiovente (53_, 54_, 58_, 59_)

1.8 i 16V Petrol 85 09/94 → 01/98

OPEL

ASTRA F Cabriolet (53_B)

1.8 i 16V Petrol 85 11/94 → 03/01

ASTRA F Station wagon (51_, 52_)

1.8 i 16V Petrol 85 07/94 → 01/98

2.0 i 16V Petrol 100 02/95 → 01/98

ASTRA G 2 volumi /Coda spiovente (F48_, F08_)

2.0 16V Petrol 100 02/98 → 01/05

ASTRA G Station wagon (F35_)

2.0 16V Petrol 100 02/98 → 07/04

ASTRA G Tre volumi (F69_)

2.0 16V Petrol 100 09/98 → 01/05

CALIBRA A (85_)

2.0 i 16V Petrol 100 02/94 → 07/97

2.0 i 16V 4x4 Petrol 100 02/94 → 07/97

OMEGA B (25_, 26_, 27_)

2.0 16V Petrol 100 03/94 → 09/99

OMEGA B Station wagon (21_, 22_, 23_)

2.0 16V Petrol 100 03/94 → 09/99

VECTRA A (86_, 87_)

2.0 i 16V Petrol 100 06/94 → 11/95

2.0 i 16V 4x4 Petrol 100 06/94 → 11/95

VECTRA A 2 volumi /Coda spiovente (88_, 89_)

2.0 i 16V Petrol 100 06/94 → 11/95

VECTRA B (36_)

1.8 i 16V Petrol 85 10/95 → 09/00

2.0 i 16V Petrol 100 10/95 → 09/00

VECTRA B 2 volumi /Coda spiovente (38_)

1.8 i 16V Petrol 85 10/95 → 09/00

2.0 i 16V Petrol 100 10/95 → 09/00

ATS13

F2

**SENSORE TEMPERATURA ARIA
AIR TEMPERATURE SENSOR**



kw



AUDI

A3 (8P1)

1.6 FSI Petrol 85 08/03 → 09/07

2.0 FSI Petrol 110 05/03 → 06/08

A3 Sportback (8PA)

1.6 FSI Petrol 85 09/04 → 09/07

2.0 FSI Petrol 110 09/04 → 06/08

SEAT

ALTEA (5P1)

2.0 FSI Petrol 110 05/04 → 03/09

IBIZA IV (6L1)

1.8 T Cupra R Petrol 132 01/04 → 02/08

1.8 T FR Petrol 110 12/03 → 05/08

TOLEDO III (5P2)

2.0 FSI Petrol 110 10/04 → 05/09

SKODA

OCTAVIA (1U2)

1.8 T Petrol 110 10/02 → 12/10

1.8 T 4x4 Petrol 110 10/02 → 05/06

RS 1.8 T Petrol 132 10/02 → 01/06

OCTAVIA (1Z3)

1.6 FSI Petrol 85 02/04 → 08/04

OCTAVIA Combi (1U5)

1.8 T Petrol 110 10/02 → 12/10

1.8 T 4x4 Petrol 110 10/02 → 05/06

RS 1.8 T Petrol 132 10/02 → 01/06

OCTAVIA Combi (1Z5)

1.6 FSI Petrol 85 02/04 → 10/08

SUPERB (3U4)

1.8 T Petrol 110 12/01 → 03/08

2.8 V6 Petrol 142 12/01 → 03/08

ATS13

VOLKSWAGEN
GOLF V (1K1)

1.4 16V	Petrol	55	10/03 → 05/06
1.4 FSI	Petrol	66	11/04 → 05/05
1.6 FSI	Petrol	85	10/03 → 07/08

GOLF V (1K1)

2.0 FSI	Petrol	110	01/04 → 11/08
2.0 FSI 4motion	Petrol	110	08/04 → 11/08

NEW BEETLE (9C1, 1C1)

1.8 T	Petrol	110	10/02 → 11/04
-------	--------	-----	---------------

PASSAT (3B3)

2.0	Petrol	96	11/01 → 05/05
-----	--------	----	---------------

PASSAT Variant (3B6)

2.0	Petrol	96	11/01 → 05/05
-----	--------	----	---------------

POLO (9N_)

1.4 FSI	Petrol	63	02/02 → 07/06
---------	--------	----	---------------

TOURAN (1T1, 1T2)

1.6 FSI	Petrol	85	02/03 → 01/07
2.0 FSI	Petrol	110	10/03 → 05/05

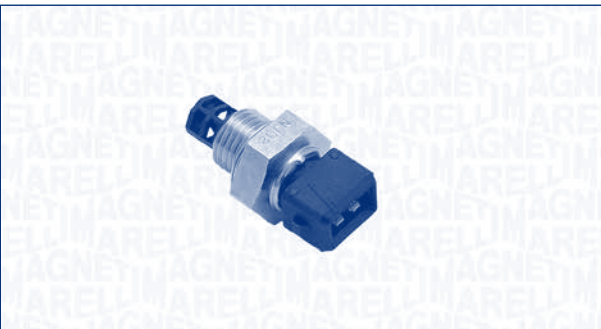
ATS14
F2 **SENSORE TEMPERATURA ARIA**
AIR TEMPERATURE SENSOR

RENAULT
19 I (B/C53_)

1.4 (B/C532) Cat.	Petrol	43	01/89 → 04/92
1.8 16V (B/C53D)	Petrol	99	06/89 → 04/92

19 I Chamade (L53_)

1.4 (L532, L53P)	Petrol	43	07/88 → 04/92
1.8 16V (L53D)	Petrol	99	10/89 → 04/92

19 II (B/C53_)

1.4 (B/C532)	Petrol	43	04/92 → 12/95
1.4 (B/C535)	Petrol	55	01/92 → 12/95
1.8 16V (B/C53D)	Petrol	99	04/92 → 12/95

ATS14

RENAULT
19 II Cabriolet (D53_, 853_)

1.8 16V (D53D)	Petrol	99	04/92 → 06/96
----------------	--------	----	---------------

19 II Chamade (L53_)

1.4 (532)	Petrol	43	04/92 → 12/95
1.4 (L535)	Petrol	55	11/93 → 12/95
1.8 16V (L53D)	Petrol	99	04/92 → 12/95

21 (B48_)

2.0 (B48R/Y)	Petrol	99	02/90 → 10/92
--------------	--------	----	---------------

21 Tre volumi (L48_)

2.0 Turbo (L485)	Petrol	129	04/87 → 03/90
2.0 Turbo 4x4	Petrol	129	08/89 → 10/93

25 (B29_)

2.0 (B297)	Petrol	74	04/84 → 12/92
2.8 V6 Injection (B29F)	Petrol	110	06/87 → 12/92

CLIO I (B/C57_, 5/357_)

1.2 (B/C/S57A, B/C57S, 5/357F, 5/357J, 5/357L, 5/357R)	Petrol	43	05/90 → 09/98
--	--------	----	---------------

1.4	Petrol	59	01/91 → 09/98
-----	--------	----	---------------

1.4 (B/C57T, B/C57Y)	Petrol	58	01/91 → 09/98
----------------------	--------	----	---------------

1.8 16V (C57D)	Petrol	99	01/91 → 03/96
----------------	--------	----	---------------

Williams (B/C57M)	Petrol	108	01/94 → 09/98
-------------------	--------	-----	---------------

LAGUNA I (B56_, 556_)

3.0 (B56E/R, B565)	Petrol	123	11/93 → 03/01
--------------------	--------	-----	---------------

MASTER I Autobus (T_)

28-35 2.0	Petrol	58	10/86 → 07/98
-----------	--------	----	---------------

MASTER I Furgonato (T_)

28-35 2.0	Petrol	58	10/86 → 07/98
-----------	--------	----	---------------

MASTER I Pianale piatto/Telaio (P_)

28-35 2.0	Petrol	58	10/86 → 07/98
-----------	--------	----	---------------

MEGANE I (BA0/1_)

1.6 e (BA0F, BA0S)	Petrol	66	01/96 → 03/99
--------------------	--------	----	---------------

1.6 i (BA0L)	Petrol	55	01/96 → 03/99
--------------	--------	----	---------------

MEGANE I Coach (DA0/1_)

1.6 e (DA0F)	Petrol	66	03/96 → 03/99
--------------	--------	----	---------------

ATS14



KW



RENAULT

SAFRANE I (B54_)

2.0 12V (B542, B54E)	Petrol	97	04/92 → 07/96
2.2 (B541)	Petrol	79	04/92 → 07/96
2.2 (B543)	Petrol	101	04/92 → 07/96
3.0 V6 (B54B, B544)	Petrol	123	12/92 → 07/96

ATS15

F2

**SENSORE TEMPERATURA ARIA
AIR TEMPERATURE SENSOR**

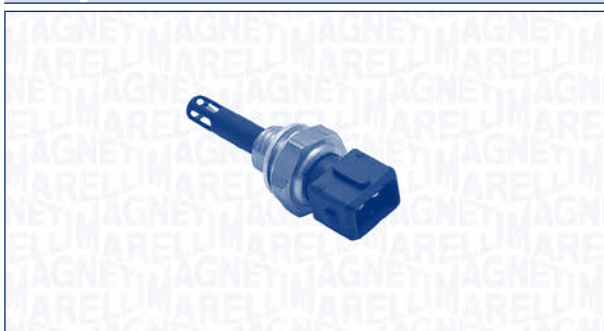

KW



BMW

3 (E46)

318 d	Diesel	85	03/03 → 02/05
320 d	Diesel	110	09/01 → 02/05
330 d	Diesel	150	03/03 → 02/05
330 xd	Diesel	150	03/03 → 02/05

3 Cabriolet (E46)

320 Cd	Diesel	110	02/05 →
330 Cd	Diesel	150	08/05 →
318 td	Diesel	85	03/03 → 02/05
320 td	Diesel	110	09/01 → 02/05

3 Coupé (E46)

320 Cd	Diesel	110	11/03 →
330 Cd	Diesel	150	03/03 →

3 Touring (E36)

325 tds	Diesel	105	01/95 → 10/99
318 d	Diesel	85	03/03 → 02/05
320 d	Diesel	110	09/01 → 02/05
330 d	Diesel	150	03/03 → 02/05

3 Touring (E46)

330 xd	Diesel	150	03/03 → 02/05
--------	--------	-----	---------------

ATS15



KW



BMW

5 (E34)

525 tds	Diesel	105	09/91 → 09/95
---------	--------	-----	---------------

5 (E60)

530 d	Diesel	160	07/03 → 03/10
-------	--------	-----	---------------

5 Touring (E34)

525 td	Diesel	85	03/93 → 01/97
525 tds	Diesel	105	12/91 → 01/97

5 Touring (E61)

530 d	Diesel	160	06/04 →
-------	--------	-----	---------

7 (E65, E66, E67)

730 d	Diesel	160	10/02 →
740 d	Diesel	190	10/02 →

X3 (E83)

2.0 D	Diesel	110	10/04 →
3.0 d	Diesel	150	01/04 →

X5 (E53)

3.0 d	Diesel	160	12/03 →
-------	--------	-----	---------

LAND ROVER

FREELANDER (LN)

2.0 Td4 4x4	Diesel	80	03/01 → 10/06
2.0 Td4 4x4	Diesel	82	11/00 → 10/06

RANGE ROVER II (LP)

2.5 TD 4x4	Diesel	100	07/94 → 03/02 ENGINE: 31428933 →
------------	--------	-----	----------------------------------

MG

MG ZS

2.0 TD	Diesel	83	01/04 → 04/05
--------	--------	----	---------------

MG ZS Hatchback

2.0 TD	Diesel	83	01/04 → 10/05
--------	--------	----	---------------

MG ZT

2.0 CDTi	Diesel	85	06/02 → 09/03
----------	--------	----	---------------

ROVER

75 (RJ)

2.0 CDT	Diesel	85	02/99 → 05/05
---------	--------	----	---------------

75 Tourer (RJ)

2.0 CDT	Diesel	85	08/01 → 05/05
---------	--------	----	---------------

ATS16
F2 **SENSORE TEMPERATURA ARIA**
AIR TEMPERATURE SENSOR

KW

AUDI
A3 (8P1)

2.0 TDI 16V Diesel 103 05/03 → 08/12

A3 Cabriolet (8P7)

2.0 TDi Diesel 103 04/08 → 05/13

A3 Sportback (8PA)

2.0 TDi Diesel 125 03/06 → 03/13

2.0 TDI 16V Diesel 103 09/04 → 03/13

2.0 TDI 16V quattro Diesel 103 11/05 → 03/13

2.0 TDI quattro Diesel 125 03/06 → 03/13

A7 Sportback (4GA, 4GF)

3.0 TDI Diesel 150 11/10 →

3.0 TDI quattro Diesel 180 10/10 →

Q7 (4L)

4.2 TDI Diesel 250 05/09 →

SEAT
ALHAMBRA (710)

1.4 TSI Petrol 110 06/10 →

2.0 TDi Diesel 103 06/10 →

2.0 TDi Diesel 125 06/10 →

IBIZA V (6J5)

1.2 TDI Diesel 55 05/10 →

1.4 TSI Petrol 110 06/09 →

1.6 TDI Diesel 66 05/09 →

1.6 TDI Diesel 77 05/09 →

2.0 TDi Diesel 105 01/10 →

IBIZA V SPORTCOUPE (6J1)

1.4 TSI Petrol 110 06/09 →

1.4 TSI Cupra Petrol 132 06/09 →

1.6 TDI Diesel 66 05/09 →

1.6 TDI Diesel 77 05/09 →

2.0 TDi Diesel 105 01/10 →

ATS16

KW

SEAT
IBIZA V ST (6J8)

1.2 TDI Diesel 55 04/10 →

1.6 TDI Diesel 66 03/10 →

SKODA
FABIA

1.4 TSI RS Petrol 132 05/10 →

1.6 TDI Diesel 66 03/10 →

1.6 TDI Diesel 77 03/10 →

FABIA Combi

1.4 TSI RS Petrol 132 05/10 →

1.6 TDI Diesel 66 03/10 →

1.6 TDI Diesel 77 03/10 →

SUPERB (3T4)

2.0 TDi Diesel 125 07/08 →

2.0 TDI 16V Diesel 103 01/09 →

2.0 TDI 4x4 Diesel 125 09/08 →

SUPERB Station wagon (3T5)

2.0 TDi Diesel 125 10/09 →

2.0 TDI 16V Diesel 103 10/09 →

2.0 TDI 4x4 Diesel 125 10/09 →

YETI (5L)

2.0 TDI 4x4 Diesel 103 05/09 →

2.0 TDI 4x4 Diesel 125 11/09 →

2.0 TDI 4x4 Diesel 81 11/09 →

VOLKSWAGEN
EOS (1F7, 1F8)

1.4 TSI Petrol 118 05/08 →

GOLF PLUS (5M1, 521)

1.6 TDI Diesel 66 02/09 →

1.6 TDI Diesel 77 03/09 →

GOLF VI (5K1)

1.4 TSI Petrol 118 10/08 → 11/12

MULTIVAN V (7HM, 7HN, 7HF, 7EF, 7EM, 7EN)

2.0 TDi Diesel 103 09/09 →

2.0 TDi Diesel 62 09/09 →

2.0 TDi Diesel 75 09/09 →

2.0 TDI 4motion Diesel 103 09/09 →

POLO (6R, 6C)

1.2 TDI Diesel 55 10/09 →

1.2 TSI Petrol 77 11/09 →

SCIROCCO (137, 138)

1.4 TSI Petrol 118 05/08 →

TIGUAN (5N_)

1.4 TSI Petrol 110 05/08 →

1.4 TSI 4motion Petrol 110 09/07 →

ATS16



VOLKSWAGEN

TOURAN (1T1, 1T2)

1.4 FSI	Petrol	125	11/06 → 05/10
1.4 TSI	Petrol	103	02/06 → 05/10
1.4 TSI EcoFuel	Petrol/ CNG	110	05/09 → 05/10

TRANSPORTER V Autobus (7HB, 7HJ, 7EB, 7EJ, 7EF)

2.0 TDi	Diesel	103	09/09 →
2.0 TDi	Diesel	62	09/09 →
2.0 TDi	Diesel	75	09/09 →
2.0 TDI 4motion	Diesel	103	09/09 →

TRANSPORTER V Furgonato (7HA, 7HH, 7EA, 7EH)

2.0 TDi	Diesel	103	09/09 →
2.0 TDi	Diesel	62	09/09 →
2.0 TDi	Diesel	75	09/09 →
2.0 TDI 4motion	Diesel	103	09/09 →

TRANSPORTER V Pianale piatto/Telaio (7JD, 7JE, 7JL, 7JY, 7JZ)

2.0 TDi	Diesel	103	09/09 →
2.0 TDi	Diesel	62	09/09 →
2.0 TDi	Diesel	75	09/09 →
2.0 TDI 4motion	Diesel	103	09/09 →

ATS17

F2 SENSORE TEMPERATURA ARIA
AIR TEMPERATURE SENSOR

OPEL

ASTRA F (56_, 57_)

1.4 i 16V	Petrol	66	02/96 → 09/98
1.6 i 16V	Petrol	74	08/94 → 09/98

ASTRA F 2 volumi /Coda spiovente (53_, 54_, 58_, 59_)

1.4 i 16V	Petrol	66	01/96 → 01/98
1.6 i 16V	Petrol	74	08/94 → 01/98

ASTRA F Cabriolet (53_B)

1.4 i 16V	Petrol	66	01/96 → 03/01
-----------	--------	----	---------------

ATS17



OPEL

ASTRA F CLASSIC 2 volumi /Coda spiovente

1.6 i 16V	Petrol	74	01/98 → 08/02
-----------	--------	----	---------------

ASTRA F CLASSIC Station wagon

1.6 i 16V	Petrol	74	01/98 → 01/05
-----------	--------	----	---------------

ASTRA F CLASSIC Tre volumi

1.6 i 16V	Petrol	74	01/98 → 08/02
-----------	--------	----	---------------

ASTRA F Station wagon (51_, 52_)

1.4 i 16V	Petrol	66	02/96 → 01/98
1.6 i 16V	Petrol	74	08/94 → 01/98

ASTRA G 2 volumi /Coda spiovente (F48_, F08_)

1.4 16V	Petrol	66	02/98 → 01/05
1.6	Petrol	62	09/00 → 01/05
1.6 16V	Petrol	74	02/98 → 01/05

ASTRA G Cabriolet (F67)

1.6 16V	Petrol	74	03/01 → 10/05
---------	--------	----	---------------

ASTRA G Furgonato (F70)

1.6	Petrol	62	09/00 → 04/05
-----	--------	----	---------------

ASTRA G Station wagon (F35_)

1.4 16V	Petrol	66	06/98 → 07/04
1.6	Petrol	62	09/00 → 07/04
1.6 16V	Petrol	74	02/98 → 07/04

1.6 CNG	Petrol/ CNG	71	03/03 → 07/04
---------	----------------	----	---------------

ASTRA G Tre volumi (F69_)

1.4 16V	Petrol	66	09/98 → 01/05
1.6	Petrol	62	09/00 → 01/05
1.6 16V	Petrol	74	09/98 → 01/05

COMBO (71_)

1.4 16V	Petrol	66	08/99 → 10/01
---------	--------	----	---------------

COMBO Cassone / Furgonato / Promiscuo

1.4 16V	Petrol	66	08/05 →
1.6	Petrol	64	10/01 →

COMBO Tour

1.6	Petrol	64	04/05 →
-----	--------	----	---------

CORSA B (73_, 78_, 79_)

1.4 i 16V	Petrol	66	09/94 → 09/00
1.6 i 16V	Petrol	74	08/97 → 09/00
1.6 i 16V	Petrol	78	09/94 → 09/00

CORSA C (F08, F68)

1.4	Petrol	66	09/00 → 12/09
-----	--------	----	---------------

MERIVA

1.6	Petrol	64	05/03 → 05/10
1.6 16V	Petrol	74	05/03 → 01/06

ATS17

OPEL
TIGRA (95_)

1.4 16V	Petrol	63	08/97 → 12/00
1.4 16V	Petrol	66	07/94 → 12/00
1.6 16V	Petrol	74	08/97 → 08/98
1.6 16V	Petrol	78	07/94 → 08/98

VECTRA B (36_)

1.6 i 16V	Petrol	74	10/95 → 04/02
-----------	--------	----	---------------

VECTRA B 2 volumi /Coda spiovente (38_)

1.6 i 16V	Petrol	74	10/95 → 07/02
-----------	--------	----	---------------

VECTRA C

1.6 16V	Petrol	74	06/04 →
---------	--------	----	---------

VECTRA C GTS

1.6	Petrol	74	08/05 →
-----	--------	----	---------

VECTRA C Station wagon

1.6 16V	Petrol	74	06/04 →
---------	--------	----	---------

ZAFIRA A (F75_)

1.6 16V	Petrol	74	04/99 → 06/05
1.6 CNG	Petrol/ CNG	71	09/01 → 06/05

ATS18
F2 **SENSORE TEMPERATURA ARIA**
AIR TEMPERATURE SENSOR

AUDI
A4 (8D2, B5)

1.9 TDI	Diesel	55	12/95 → 07/97
1.9 TDI	Diesel	66	01/95 → 07/97
1.9 TDI	Diesel	81	10/95 → 07/97

FORD
GALAXY (WGR)

1.9 TDI	Diesel	66	03/95 → 05/06
1.9 TDI	Diesel	81	08/97 → 04/00
2.8 i V6	Petrol	128	11/95 → 04/00
2.8 i V6 4x4	Petrol	128	04/96 → 04/00

ATS18

SEAT
AROSA (6H)

1.7 SDI	Diesel	44	08/97 → 06/04
---------	--------	----	---------------

CORDOBA (6K1, 6K2)

1.8 i 16V	Petrol	95	10/93 → 08/96
1.9 TDI	Diesel	81	03/97 → 06/99
2.0 i	Petrol	85	02/93 → 06/99

CORDOBA (6K2)

1.9 SDI	Diesel	50	06/99 → 10/02
1.9 SDI	Diesel	47	09/02 → 11/09

CORDOBA Vario (6K5)

1.9 SDI	Diesel	47	09/96 → 06/99
1.9 SDI	Diesel	50	06/99 → 12/02
1.9 TDI	Diesel	81	07/97 → 06/99
1.9 TDI	Diesel	66	08/96 → 06/99

IBIZA II (6K1)

1.8 i 16V	Petrol	95	11/93 → 08/96
1.9 SDI	Diesel	47	08/96 → 08/99
2.0 i	Petrol	85	03/93 → 08/99

IBIZA III (6K1)

1.9 SDI	Diesel	50	08/99 → 02/02
---------	--------	----	---------------

IBIZA IV (6L1)

1.9 SDI	Diesel	47	02/02 → 12/05
---------	--------	----	---------------

LEON (1M1)

1.9 SDI	Diesel	50	11/99 → 06/06
---------	--------	----	---------------

TOLEDO I (1L)

1.9 TDI	Diesel	66	08/95 → 03/99
2.0 i	Petrol	85	05/91 → 03/99
2.0 i 16V	Petrol	110	11/93 → 03/99

SKODA
FABIA (6Y2)

1.9 SDI	Diesel	47	12/99 → 03/08
---------	--------	----	---------------

FABIA Combi (6Y5)

1.9 SDI	Diesel	47	04/00 → 12/07
---------	--------	----	---------------

FABIA Praktik

1.9 SDI	Diesel	47	07/01 → 12/07
---------	--------	----	---------------

FABIA Tre volumi (6Y3)

1.9 SDI	Diesel	47	11/99 → 12/07
---------	--------	----	---------------

OCTAVIA (1U2)

1.9 SDI	Diesel	50	06/97 → 12/03
---------	--------	----	---------------

OCTAVIA Combi (1U5)

1.9 SDI	Diesel	50	07/98 → 12/03
---------	--------	----	---------------

VOLKSWAGEN
BORA (1J2)

1.9 SDI	Diesel	50	10/98 → 05/05
---------	--------	----	---------------

ATS18



KW



VOLKSWAGEN

CADDY II Furgonato (9K9A)

1.9 SDI Diesel 47 09/00 → 01/04

CADDY II Station wagon (9K9B)

1.9 SDI Diesel 47 09/00 → 01/04

1.9 TDI Diesel 66 10/96 → 01/04

CORRADO (53I)

2.0 i Petrol 85 04/93 → 12/95

GOLF III (1H1)

1.9 TDI Diesel 66 09/93 → 08/97

1.9 TDI Syncro (1HX1) Diesel 66 08/95 → 08/97

2.0 Petrol 85 11/91 → 08/97

2.0 GTI 16V Petrol 110 08/92 → 08/97

2.0 Syncro (1HX1) Petrol 85 08/95 → 08/97

GOLF III Cabriolet (1E7)

1.9 TDI Diesel 66 08/95 → 05/98

2.0 Petrol 85 07/93 → 05/98

GOLF III Variant (1H5)

1.9 TDI Diesel 66 03/94 → 04/99

1.9 TDI Syncro Diesel 66 07/95 → 04/99

2.0 Petrol 85 07/93 → 04/99

2.0 Syncro Petrol 85 08/95 → 04/99

GOLF IV (1J1)

1.9 SDI Diesel 50 08/97 → 06/05

GOLF IV Cabriolet (1E7)

1.9 TDI Diesel 66 06/98 → 06/02

1.9 TDI Diesel 81 06/98 → 06/02

2.0 Petrol 85 06/98 → 06/02

GOLF IV Variant (1J5)

1.9 SDI Diesel 50 05/99 → 06/06

LT 28-35 II Autobus (2DB, 2DE, 2DK)

2.5 SDI Diesel 55 07/96 → 07/06

LT 28-46 II Furgonato (2DA, 2DD, 2DH)

2.5 SDI Diesel 55 09/96 → 07/06

LT 28-46 II Pianale piatto/Telaio (2DC, 2DF, 2DG, 2DL, 2DM)

2.5 SDI Diesel 55 09/96 → 07/06

LUPO (6X1, 6E1)

1.7 SDI Diesel 44 09/98 → 07/05

PASSAT (3A2, 35I)

2.0 Petrol 79 03/95 → 08/96

2.0 Petrol 85 02/90 → 08/96

2.0 16V Petrol 110 01/94 → 08/96

ATS18



KW



VOLKSWAGEN

PASSAT Variant (3A5, 35I)

2.0 Petrol 79 03/95 → 08/96

2.0 Petrol 85 02/90 → 05/97

2.0 16V Petrol 110 01/94 → 05/97

POLO (6N2)

1.7 SDI Diesel 44 10/99 → 09/01

1.9 SDI Diesel 47 10/99 → 09/01

POLO (9N_)

1.9 SDI Diesel 47 10/01 → 11/09

POLO CLASSIC (6KV2)

110 1.9 TDI Diesel 81 06/98 → 01/02

57 1.7 SDI Diesel 42 07/97 → 09/01

64 1.9 SDI Diesel 47 12/95 → 08/99

68 1.9 SDI Diesel 50 08/99 → 01/02

POLO Furgonato (6NF)

1.7 SDI Diesel 44 10/99 → 12/99

1.9 SDI Diesel 47 10/99 → 12/99

POLO Tre volumi (9A4)

1.9 SDI Diesel 47 09/02 →

POLO Variant (6KV5)

1.7 SDI Diesel 42 08/97 → 09/01

1.9 SDI Diesel 47 06/97 → 09/01

1.9 SDI Diesel 50 08/99 → 09/01

1.9 TDI Diesel 66 05/97 → 09/01

1.9 TDI Diesel 81 06/98 → 09/01

SHARAN (7M8, 7M9, 7M6)

1.9 TDI Diesel 66 09/95 → 02/00

TRANSPORTER IV Autobus (70XB, 70XC, 7DB, 7DW)

2.5 Petrol 81 11/90 → 04/03 CHASSIS: 70T200001 →

2.5 Syncro Petrol 81 11/92 → 04/03 CHASSIS: 70T200001 →

2.5 TDI Diesel 111 05/98 → 04/03

2.5 TDI Diesel 75 05/99 → 04/03

TRANSPORTER IV Furgonato (70XA)

2.5 TDI Diesel 75 05/99 → 04/03

2.5 TDI Syncro Diesel 75 03/98 → 04/03

TRANSPORTER IV Pianale piatto/Telaio (70XD)

2.0 Petrol 62 07/90 → 04/03 CHASSIS: 70T200001 →

2.5 Petrol 81 11/90 → 04/03 CHASSIS: 70T200001 →

2.5 Syncro Petrol 81 10/92 → 04/03 CHASSIS: 70T200001 →

ATS18

VOLKSWAGEN
TRANSPORTER IV Pianale piatto/Telaio (70XD)

2.5 TDI	Diesel	75	05/99 → 04/03
2.5 TDI Syncro	Diesel	75	05/98 → 04/03

ATS19
F2 **SENSORE TEMPERATURA ARIA**
AIR TEMPERATURE SENSOR

AUDI
A3 (8L1)

1.8 T	Petrol	132	12/98 → 05/03
1.8 T quattro	Petrol	110	08/97 → 05/03
1.8 T quattro	Petrol	132	10/98 → 05/03
S3 quattro	Petrol	154	03/99 → 04/02
S3 quattro	Petrol	165	10/01 → 05/03

A4 (8D2, B5)

1.6	Petrol	74	11/94 → 07/99
1.8	Petrol	92	01/95 → 10/00
1.8	Petrol	85	04/95 → 06/00
1.8 quattro	Petrol	85	07/95 → 11/00
1.8 quattro	Petrol	92	01/95 → 06/00
1.8 T	Petrol	132	12/97 → 12/98
1.8 T	Petrol	110	01/95 → 10/00
1.8 T quattro	Petrol	132	12/97 → 10/00
1.8 T quattro	Petrol	110	01/95 → 10/00
2.4	Petrol	120	08/97 → 10/00
2.4	Petrol	121	08/97 → 11/00
2.4 quattro	Petrol	120	02/99 → 06/00
2.4 quattro	Petrol	121	08/97 → 11/00
2.8	Petrol	142	10/96 → 06/00
2.8 quattro	Petrol	142	10/96 → 06/00
S4 quattro	Petrol	195	09/97 → 09/01

ATS19

AUDI
A4 (8E2, B6)

1.8 T	Petrol	110	11/00 → 04/01
1.8 T	Petrol	120	07/02 → 12/04
1.8 T	Petrol	140	11/02 → 12/04
1.8 T quattro	Petrol	110	11/00 → 04/01
1.8 T quattro	Petrol	120	07/02 → 12/04
1.8 T quattro	Petrol	140	11/02 → 12/04

A4 Avant (8D5, B5)

1.6	Petrol	74	11/94 → 07/99
1.8	Petrol	85	07/95 → 12/98
1.8	Petrol	92	02/96 → 09/01
1.8 quattro	Petrol	85	07/95 → 09/01
1.8 quattro	Petrol	92	01/96 → 09/01
1.8 T	Petrol	110	03/96 → 09/01
1.8 T	Petrol	132	12/97 → 09/01
1.8 T quattro	Petrol	132	12/97 → 09/01
1.8 T quattro	Petrol	110	01/96 → 09/01
2.4	Petrol	120	08/98 → 09/01
2.4	Petrol	121	08/97 → 09/01
2.4 quattro	Petrol	120	08/98 → 06/00
2.4 quattro	Petrol	121	08/97 → 09/01
2.8	Petrol	142	10/96 → 07/99
2.8 quattro	Petrol	142	10/96 → 09/01
RS4 quattro	Petrol	280	05/00 → 09/01

A4 Avant (8E5, B6)

1.8 T	Petrol	120	07/02 → 12/04
1.8 T	Petrol	140	11/02 → 12/04
1.8 T quattro	Petrol	120	07/02 → 12/04
1.8 T quattro	Petrol	140	11/02 → 12/04

A4 Cabriolet (8H7, B6, 8HE, B7)

1.8 T	Petrol	120	07/02 → 12/05
1.8 T quattro	Petrol	120	05/03 → 12/05

A6 (4A, C4)

1.8	Petrol	92	12/95 → 10/97
-----	--------	----	---------------

A6 (4B2, C5)

1.8	Petrol	85	05/97 → 05/00
1.8	Petrol	92	12/97 → 04/01
1.8 T	Petrol	132	12/97 → 10/00
1.8 T quattro	Petrol	132	12/97 → 10/00
1.8 T quattro	Petrol	110	04/97 → 05/04
2.4	Petrol	115	04/98 → 04/01
2.4	Petrol	121	04/97 → 01/05
2.4	Petrol	125	08/01 → 05/04
2.4	Petrol	100	07/98 → 05/04

ATS19



KW



AUDI

A6 (4B2, C5)

2.4 quattro	Petrol	115	08/98 → 07/99
2.4 quattro	Petrol	120	06/97 → 05/00
2.4 quattro	Petrol	125	08/01 → 05/04
2.4 quattro	Petrol	121	04/97 → 05/01
2.7 T	Petrol	169	02/99 → 05/01
2.7 T quattro	Petrol	169	12/97 → 08/00
2.7 T quattro	Petrol	184	08/01 → 05/04
2.8	Petrol	132	10/97 → 05/00
2.8	Petrol	140	07/99 → 04/01
2.8	Petrol	142	04/97 → 04/01
2.8 quattro	Petrol	142	04/97 → 05/01

A6 Avant (4A, C4)

1.8	Petrol	92	12/95 → 10/97
-----	--------	----	---------------

A6 Avant (4B5, C5)

1.8	Petrol	85	02/98 → 05/00
1.8	Petrol	92	02/98 → 04/01
1.8 T	Petrol	132	04/99 → 10/00
1.8 T	Petrol	110	02/98 → 04/01
1.8 T quattro	Petrol	110	02/98 → 01/05
1.8 T quattro	Petrol	132	02/98 → 10/00
2.4	Petrol	125	08/01 → 01/05
2.4	Petrol	121	12/97 → 04/01
2.4	Petrol	100	07/98 → 01/05
2.4	Petrol	115	04/98 → 07/98
2.4	Petrol	120	02/98 → 04/01
2.4 quattro	Petrol	125	08/01 → 01/05
2.4 quattro	Petrol	115	08/98 → 05/01
2.4 quattro	Petrol	120	12/97 → 05/01
2.4 quattro	Petrol	121	12/97 → 05/01
2.7 T	Petrol	169	02/99 → 05/01
2.7 T quattro	Petrol	184	08/01 → 01/05
2.7 T quattro	Petrol	169	02/99 → 05/01
2.8	Petrol	132	02/98 → 05/00
2.8	Petrol	140	07/99 → 04/01
2.8	Petrol	142	02/98 → 04/01
2.8 quattro	Petrol	142	02/98 → 05/01

A8 (4D2, 4D8)

2.8	Petrol	142	10/97 → 09/02
2.8 quattro	Petrol	142	01/99 → 09/02

ALLROAD (4BH, C5)

2.7 T quattro	Petrol	184	05/00 → 06/02
---------------	--------	-----	---------------

ATS19



KW



AUDI

TT (8N3)

1.8 T	Petrol	110	09/02 → 06/06
1.8 T	Petrol	132	10/98 → 06/06
1.8 T quattro	Petrol	132	10/98 → 06/06
1.8 T quattro	Petrol	165	10/98 → 06/06

TT Roadster (8N9)

1.8 T	Petrol	110	01/01 → 06/06
1.8 T	Petrol	132	10/99 → 06/06
1.8 T quattro	Petrol	132	02/00 → 06/06
1.8 T quattro	Petrol	165	10/99 → 06/06

PORSCHE

911 (993)

3.6 Turbo 4	Petrol	300	03/95 → 09/97
-------------	--------	-----	---------------

SEAT

ALHAMBRA (7V8, 7V9)

1.8 T 20V	Petrol	110	05/98 → 03/10
-----------	--------	-----	---------------

CORDOBA (6K2)

1.8 T 20V Cupra	Petrol	115	07/00 → 10/02
-----------------	--------	-----	---------------

IBIZA III (6K1)

1.8 T 20V Cupra	Petrol	115	07/00 → 02/02
-----------------	--------	-----	---------------

LEON (1M1)

1.8 20V T	Petrol	132	11/99 → 04/04
1.8 20V T 4	Petrol	132	03/00 → 04/04
1.8 T Cupra R	Petrol	154	05/02 → 05/03
1.8 T Cupra R	Petrol	165	07/03 → 06/06

TOLEDO II (1M2)

1.8 20VT	Petrol	132	05/01 → 05/02
2.3 V5	Petrol	110	04/99 → 11/00

SKODA

OCTAVIA (1U2)

1.8 T	Petrol	110	03/98 → 09/02
1.8 T 4x4	Petrol	110	05/01 → 09/02
RS 1.8 T	Petrol	132	05/01 → 09/02

OCTAVIA Combi (1U5)

1.8 20V	Petrol	92	07/98 → 04/99
1.8 T	Petrol	110	07/98 → 09/02
1.8 T 4x4	Petrol	110	05/01 → 09/02

VOLKSWAGEN

BORA (1J2)

1.8 T	Petrol	110	05/00 → 09/02
1.8 T	Petrol	132	05/02 → 09/02
2.3 V5	Petrol	110	10/98 → 10/00
2.3 V5 4motion	Petrol	110	12/98 → 10/00

ATS19

AUDI
BORA Station wagon (1J6)

1.8 T	Petrol	110	05/00 → 09/02
1.8 T	Petrol	132	05/02 → 09/02
2.3 V5	Petrol	110	05/99 → 10/00
2.3 V5 4motion	Petrol	110	05/00 → 10/00

GOLF IV (1J1)

1.6 16V	Petrol	77	02/00 → 11/01
1.8	Petrol	92	10/97 → 10/00
1.8 4motion	Petrol	92	07/98 → 10/00
1.8 T	Petrol	110	10/97 → 09/02
1.8 T GTI	Petrol	132	08/01 → 09/02
2.3 V5	Petrol	110	10/97 → 10/00
2.3 V5 4motion	Petrol	110	12/98 → 10/00

GOLF IV Variant (1J5)

1.6 16V	Petrol	77	02/00 → 11/01
1.8 4motion	Petrol	92	05/99 → 10/00
1.8 T	Petrol	110	05/00 → 09/02
2.3 V5	Petrol	110	05/99 → 02/01
2.3 V5 4motion	Petrol	110	05/99 → 02/01

NEW BEETLE (9C1, 1C1)

1.8 T	Petrol	110	10/99 → 09/02
-------	--------	-----	---------------

PASSAT (3B2)

1.8	Petrol	85	01/97 → 11/00
1.8 Syncro/4motion	Petrol	92	06/97 → 11/00
2.3 VR5 Syncro/4motion	Petrol	110	09/98 → 11/00
2.8 V6	Petrol	132	05/97 → 09/99

PASSAT (3B3)

1.8 T	Petrol	125	02/01 → 05/05
1.8 T 20V	Petrol	110	11/00 → 05/05
2.8 4motion	Petrol	142	11/00 → 05/05

PASSAT Variant (3B5)

1.8	Petrol	85	06/97 → 11/00
1.8 Syncro/4motion	Petrol	92	08/97 → 11/00
2.3 VR5 Syncro/4motion	Petrol	110	09/98 → 11/00
2.8 V6 Syncro/4motion	Petrol	142	06/97 → 11/00

PASSAT Variant (3B6)

1.8 T 20V	Petrol	110	11/00 → 05/05
2.8 4motion	Petrol	142	11/00 → 05/05

SHARAN (7M8, 7M9, 7M6)

1.8 T 20V	Petrol	110	09/97 → 05/00
-----------	--------	-----	---------------

ATS20
F2 **SENSORE TEMPERATURA ARIA**
AIR TEMPERATURE SENSOR

ALFA ROMEO
147 (937)

1.9 JTD 16V	Diesel	100	10/04 → 03/10
1.9 JTD 16V	Diesel	103	11/02 → 03/10
1.9 JTD 16V	Diesel	93	09/03 → 09/04
1.9 JTDM	Diesel	85	10/04 → 03/10
1.9 JTDM 16V	Diesel	110	09/04 → 03/10
1.9 JTDM 8V	Diesel	88	07/05 → 03/10

159 (939)

1.9 JTDM 16V	Diesel	110	09/05 → 11/11
1.9 JTDM 8V	Diesel	88	09/05 → 11/11
2.4 JTDM	Diesel	147	09/05 → 11/11

BRERA

2.4 JTDM 20V	Diesel	147	01/06 →
2.4 JTDM 20V	Diesel	154	05/07 →

GT (937)

1.9 JTD	Diesel	110	11/03 → 09/10
---------	--------	-----	---------------

SPIDER (939)

2.4 JTDM	Diesel	147	04/07 →
2.4 JTDM	Diesel	154	03/08 →

FIAT
CROMA (194)

1.9 D Multijet	Diesel	110	06/05 →
1.9 D Multijet	Diesel	88	06/05 →
2.4 D Multijet	Diesel	147	06/05 →

DOBLO (119)

1.9 D Multijet	Diesel	88	10/05 →
----------------	--------	----	---------

DOBLO Cargo (223)

1.3 D Multijet	Diesel	55	10/05 → 01/10
----------------	--------	----	---------------

DUCATO Autobus (250)

120 Multijet 2,3 D	Diesel	88	07/06 →
160 Multijet 3,0 D	Diesel	116	07/06 →

IDEA

1.3 D Multijet	Diesel	66	10/05 →
1.9 JTD	Diesel	74	01/04 →

ATS20



KW



FIAT

MULTIPLA (186)

1.9 JTD (186AXE1A)	Diesel	88	04/02 → 06/10
-----------------------	--------	----	---------------

PUNTO (188)

1.9 JTD	Diesel	74	06/03 →
---------	--------	----	---------

PUNTO / GRANDE PUNTO (199)

1.3 D Multijet	Diesel	66	10/05 →
----------------	--------	----	---------

1.9 D Multijet	Diesel	88	10/05 →
----------------	--------	----	---------

SEDICI

1.9 D Multijet 4x4	Diesel	88	06/06 →
--------------------	--------	----	---------

STILO (192)

1.9 D Multijet	Diesel	110	09/05 → 11/06
----------------	--------	-----	---------------

1.9 D Multijet	Diesel	88	09/05 → 11/06
----------------	--------	----	---------------

1.9 JTD	Diesel	100	04/04 → 11/06
---------	--------	-----	---------------

1.9 JTD	Diesel	103	01/04 → 11/06
---------	--------	-----	---------------

1.9 JTD	Diesel	93	09/03 → 11/06
---------	--------	----	---------------

STILO Multi Wagon (192)

1.9 D Multijet	Diesel	110	09/05 → 08/08
----------------	--------	-----	---------------

1.9 D Multijet	Diesel	88	09/05 → 08/08
----------------	--------	----	---------------

1.9 JTD	Diesel	103	01/04 → 08/08
---------	--------	-----	---------------

1.9 JTD	Diesel	100	04/04 → 08/08
---------	--------	-----	---------------

1.9 JTD	Diesel	93	09/03 → 08/08
---------	--------	----	---------------

STRADA Pick-up (178E)

1.3 D Multijet	Diesel	62	05/06 →
----------------	--------	----	---------

LANCIA

MUSA (350)

1.9 D Multijet	Diesel	74	10/04 →
----------------	--------	----	---------

YPSILON (843)

1.3 D Multijet	Diesel	66	09/06 → 12/11
----------------	--------	----	---------------

OPEL

ASTRA G 2 volumi /Coda spiovente (F48_, F08_)

2.2 DTI	Diesel	92	09/02 → 01/04
---------	--------	----	---------------

ASTRA G Cabriolet (F67)

2.2 DTI	Diesel	92	09/02 → 08/05
---------	--------	----	---------------

ASTRA G Coupé (F07_)

2.2 DTI	Diesel	92	09/02 → 02/05
---------	--------	----	---------------

ASTRA G Station wagon (F35_)

2.2 DTI	Diesel	92	09/02 → 06/04
---------	--------	----	---------------

ASTRA G Tre volumi (F69_)

2.2 DTI	Diesel	92	09/02 → 01/04
---------	--------	----	---------------

ASTRA H (L48)

1.3 CDTI	Diesel	66	08/05 →
----------	--------	----	---------

1.9 CDTI	Diesel	110	09/04 →
----------	--------	-----	---------

1.9 CDTI	Diesel	88	06/04 →
----------	--------	----	---------

1.9 CDTI 16V	Diesel	88	04/04 →
--------------	--------	----	---------

ATS20



KW



OPEL

ASTRA H GTC (L08)

1.3 CDTI	Diesel	66	04/05 →
----------	--------	----	---------

1.9 CDTI	Diesel	88	09/05 →
----------	--------	----	---------

ASTRA H Station wagon (L35)

1.3 CDTI	Diesel	66	08/05 →
----------	--------	----	---------

1.9 CDTI	Diesel	110	09/04 →
----------	--------	-----	---------

1.9 CDTI	Diesel	88	09/05 →
----------	--------	----	---------

1.9 CDTI 16V	Diesel	88	08/04 →
--------------	--------	----	---------

SIGNUM

1.9 CDTI	Diesel	110	04/04 →
----------	--------	-----	---------

1.9 CDTI	Diesel	88	04/04 →
----------	--------	----	---------

VECTRA C

1.9 CDTI	Diesel	110	04/04 →
----------	--------	-----	---------

1.9 CDTI	Diesel	74	10/05 →
----------	--------	----	---------

1.9 CDTI	Diesel	88	04/04 →
----------	--------	----	---------

VECTRA C GTS

1.9 CDTI	Diesel	110	04/04 →
----------	--------	-----	---------

1.9 CDTI	Diesel	74	10/05 →
----------	--------	----	---------

1.9 CDTI	Diesel	88	04/04 →
----------	--------	----	---------

VECTRA C Station wagon

1.9 CDTI	Diesel	110	04/04 →
----------	--------	-----	---------

1.9 CDTI	Diesel	74	10/05 →
----------	--------	----	---------

1.9 CDTI	Diesel	88	04/04 →
----------	--------	----	---------

ZAFIRA A (F75_)

2.2 DTI 16V	Diesel	92	01/02 → 06/05
-------------	--------	----	---------------

ZAFIRA B (A05)

1.9 CDTI	Diesel	74	07/05 →
----------	--------	----	---------

1.9 CDTI	Diesel	88	07/05 →
----------	--------	----	---------

SAAB

9-3 (YS3F)

1.9 TiD	Diesel	110	09/04 →
---------	--------	-----	---------

1.9 TiD	Diesel	88	09/04 →
---------	--------	----	---------

9-3 Station wagon

1.9 TiD	Diesel	88	03/05 →
---------	--------	----	---------

VAUXHALL

ASTRA Mk V (H) 2 volumi /Coda spiovente

1.3 CDTI	Diesel	66	01/04 → 05/09
----------	--------	----	---------------

1.9 CDTI	Diesel	110	01/04 → 05/09
----------	--------	-----	---------------

1.9 CDTI	Diesel	88	01/04 → 05/09
----------	--------	----	---------------

1.9 CDTI 16V	Diesel	88	01/04 → 05/09
--------------	--------	----	---------------

ASTRA Mk V (H) Sport Hatch

1.9 CDTI	Diesel	88	02/05 → 11/10
----------	--------	----	---------------

ATS20

KW

VAUXHALL
ASTRA Mk V (H) Station wagon

1.3 CDTI	Diesel	66	08/04 → 03/09
1.9 CDTI	Diesel	110	08/04 → 03/09
1.9 CDTI	Diesel	88	08/04 → 03/09
1.9 CDTI	Diesel	88	08/04 → 03/09

SIGNUM

1.9 CDTI	Diesel	88	04/04 → 03/08
1.9 CDTI 16V	Diesel	110	04/04 → 03/08
2.2 DTI	Diesel	92	05/03 → 05/08

VECTRA Mk II (C)

1.9 CDTI	Diesel	88	04/02 → 09/08
1.9 CDTI 16V	Diesel	110	04/04 → 08/08
2.2 DTI 16V	Diesel	92	04/02 → 10/08

VECTRA Mk II (C) GTS

1.9 CDTI	Diesel	88	08/02 → 07/08
1.9 CDTI 16V	Diesel	110	04/04 → 07/08
2.2 DTI 16V	Diesel	92	08/02 → 07/08

VECTRA Mk II (C) Station wagon

1.9 CDTI	Diesel	88	04/04 → 07/08
1.9 CDTI 16V	Diesel	110	04/04 → 07/08
2.2 DTI 16V	Diesel	92	10/03 → 07/08

ZAFIRA Mk II (B) (M75)

1.9 CDTI	Diesel	88	07/05 →
----------	--------	----	---------

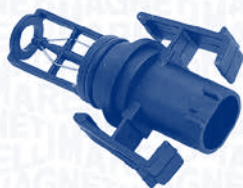
ATS21
F2
**SENSORE TEMPERATURA ARIA
AIR TEMPERATURE SENSOR**

KW

DAEWOO
KORANDO (KJ)

2.3	Petrol	105	01/99 →
3.2 4x4	Petrol	156	01/99 →

KORANDO Cabrio (KJ)

2.3	Petrol	105	02/99 →
-----	--------	-----	---------

ATS21

KW

DAEWOO
MUSSO (FJ)

2.3	Petrol	103	01/99 →
3.2 4x4	Petrol	162	01/99 →

MERCEDES-BENZ
CLASSE A (W168)

A 140 (168.031, 168.131)	Petrol	60	01/01 → 08/04
A 140 (168.031, 168.131)	Petrol	60	07/97 → 08/04
A 160 (168.033, 168.133)	Petrol	75	07/97 → 08/04
A 160 CDI (168.006)	Diesel	55	02/01 → 08/04
A 160 CDI (168.007)	Diesel	44	07/98 → 02/01
A 170 CDI (168.008)	Diesel	66	07/98 → 02/01
A 170 CDI (168.009, 168.109)	Diesel	70	02/01 → 08/04
A 190 (168.032, 168.132)	Petrol	92	03/99 → 08/04
A 210 (168.035, 168.135)	Petrol	103	03/02 → 08/04

CLASSE A (W169)

A 160 CDI (169.006, 169.306)	Diesel	60	09/04 → 06/12
A 180 CDI (169.007, 169.307)	Diesel	80	09/04 → 06/12
A 200 CDI (169.008, 169.308)	Diesel	103	09/04 → 06/12

CLASSE C (W202)

C 180 (202.018)	Petrol	90	03/93 → 05/00
C 200 (202.020)	Petrol	100	01/94 → 05/00
C 200 CDI (202.134)	Diesel	75	03/98 → 05/00
C 200 Kompressor (202.025)	Petrol	132	10/95 → 05/00
C 220 (202.022)	Petrol	110	03/93 → 05/00
C 220 CDI (202.133)	Diesel	92	09/97 → 05/00

ATS21



KW



MERCEDES-BENZ

CLASSE C (W202)

C 220 D	Diesel	55	07/96 → 05/00
C 220 D (202.121)	Diesel	70	08/93 → 05/00
C 230 Kompressor (202.024)	Petrol	142	10/95 → 05/00
C 250 D (202.125)	Diesel	83	05/93 → 05/00
C 250 Turbo-D (202.128)	Diesel	110	10/95 → 05/00

CLASSE C (W203)

C 180 Kompressor (203.046)	Petrol	105	05/02 → 02/07
C 200 CDI	Diesel	75	02/01 → 02/07
C 200 CDI (203.004)	Diesel	85	09/00 → 02/07
C 200 CDI (203.007)	Diesel	90	04/03 → 02/07
C 200 CGI Kompressor (203.043)	Petrol	125	07/03 → 02/07
C 200 Kompressor (203.042)	Petrol	120	05/02 → 02/07
C 220 CDI (203.006)	Diesel	105	05/00 → 02/07
C 220 CDI (203.008)	Diesel	110	02/03 → 02/07
C 230 Kompressor (203.040)	Petrol	141	02/04 → 02/07
C 270 CDI (203.016)	Diesel	125	12/00 → 02/07
C 30 CDI AMG (203.018)	Diesel	170	01/03 → 02/07
C 32 AMG Kompressor (203.065)	Petrol	260	02/01 → 02/07

CLASSE C Sportcoupe (CL203)

C 180 Kompressor (203.746)	Petrol	105	05/02 → 05/08
----------------------------------	--------	-----	---------------

ATS21



KW



MERCEDES-BENZ

CLASSE C Sportcoupe (CL203)

C 200 CGI Kompressor (203.743)	Petrol	125	03/03 → 05/08
C 200 Kompressor (203.742)	Petrol	120	05/02 → 05/08
C 220 CDI (203.706)	Diesel	105	03/01 → 05/08
C 30 CDI AMG (203.718)	Diesel	170	09/02 → 05/08

CLASSE C Station wagon (S202)

C 180 T (202.078)	Petrol	90	06/96 → 09/00
C 200 T (202.080)	Petrol	100	06/96 → 03/01
C 200 T CDI (202.194)	Diesel	75	03/98 → 03/01
C 200 T Kompressor (202.082)	Petrol	141	11/96 → 03/01
C 220 T CDI (202.193)	Diesel	92	09/97 → 03/01
C 220 T D	Diesel	55	06/96 → 03/01
C 220 T D (202.182)	Diesel	70	06/96 → 09/98
C 230 T Kompressor (202.085)	Petrol	142	06/97 → 09/00
C 250 T Turbo-D (202.188)	Diesel	110	06/96 → 03/01

CLASSE C T-Model (S203)

C 180 Kompressor (203.246)	Petrol	105	05/02 → 08/07
C 200 CDI (203.204)	Diesel	85	03/01 → 08/07
C 200 CDI (203.204, 203.207)	Diesel	75	03/01 → 08/07
C 200 CDI (203.207)	Diesel	90	04/03 → 08/07
C 200 CGI Kompressor (203.243)	Petrol	125	07/03 → 08/07

ATS21

MERCEDES-BENZ
CLASSE C T-Model (S203)

C 220 CDI (203.206)	Diesel	105	03/01 → 08/07	
C 220 CDI (203.208)	Diesel	110	02/04 → 08/07	
C 270 CDI (203.216)	Diesel	125	03/01 → 08/07	
C 30 CDI AMG (203.218)	Diesel	170	01/03 → 08/07	
C 32 AMG Kompressor (203.265)	Petrol	260	03/01 → 08/07	

CLASSE E (W124)

E 200 (124.019)	Petrol	100	06/93 → 06/95	ENGINE: 055902 →
E 220 (124.022)	Petrol	110	06/93 → 06/95	ENGINE: 080037 →
E 280 (124.028)	Petrol	145	06/93 → 06/95	ENGINE: 005790 →
E 280 (124.029)	Petrol	142	06/93 → 06/95	ENGINE: 005790 →
E 320 (124.032)	Petrol	162	06/93 → 06/95	ENGINE: 004357 →

CLASSE E (W210)

E 200 (210.035)	Petrol	100	06/95 → 08/00	
E 200 CDI (210.007)	Diesel	75	06/98 → 03/02	
E 200 D (210.003)	Diesel	65	01/96 → 03/02	
E 200 Kompressor (210.048)	Petrol	120	08/00 → 03/02	
E 220 CDI (210.006)	Diesel	92	06/98 → 07/99	
E 220 D (210.004)	Diesel	70	06/95 → 07/99	
E 230 (210.037)	Petrol	110	06/95 → 06/97	
E 250 D (210.010)	Diesel	83	06/95 → 07/99	
E 250 Turbo-D (210.015)	Diesel	110	06/97 → 07/99	
E 270 CDI (210.016)	Diesel	125	07/99 → 03/02	
E 280 (210.053)	Petrol	142	01/96 → 06/97	
E 290 Turbo-D (210.017)	Diesel	95	03/96 → 07/99	
E 300 D (210.020)	Diesel	100	06/95 → 06/97	

ATS21

MERCEDES-BENZ
CLASSE E (W210)

E 320 CDI (210.026)	Diesel	145	07/99 → 03/02	
E 420 (210.072)	Petrol	205	01/96 → 06/97	
E 50 AMG (210.072)	Petrol	255	02/96 → 08/97	
E 55 AMG 4-matic (210.074)	Petrol	260	03/01 → 03/02	

CLASSE E (W211)

E 200 CDI (211.004)	Diesel	75	07/02 → 12/08	
E 200 CDI (211.004)	Diesel	90	07/02 → 12/08	
E 200 Kompressor (211.042)	Petrol	120	11/02 → 12/08	
E 220 CDI (211.006)	Diesel	110	03/02 → 12/08	
E 270 CDI (211.016)	Diesel	130	03/02 → 12/08	
E 320 CDI (211.026)	Diesel	150	11/02 → 12/08	
E 400 CDI (211.028)	Diesel	191	02/03 → 12/08	
E 55 AMG Kompressor (211.076)	Petrol	350	10/02 → 12/08	

CLASSE E Cabriolet (A124)

E 320 (124.066)	Petrol	162	06/93 → 03/98	ENGINE: 004357 →
E 36 AMG (124.066)	Petrol	200	05/94 → 03/98	ENGINE: 004357 →

CLASSE E Coupé (C124)

E 320 (124.052)	Petrol	162	06/93 → 06/97	ENGINE: 004357 →
E 36 AMG (124.052)	Petrol	200	05/94 → 06/97	ENGINE: 004357 →

CLASSE E Station wagon (S124)

E 200 T (124.079)	Petrol	100	06/93 → 06/96	ENGINE: 028683 →
E 220 T (124.082)	Petrol	110	06/93 → 06/96	ENGINE: 079784 →
E 280 T (124.088)	Petrol	142	06/93 → 06/96	ENGINE: 048697 →
E 280 T (124.088)	Petrol	145	06/93 → 06/96	ENGINE: 048697 →
E 320 T (124.092)	Petrol	162	06/93 → 06/96	ENGINE: 072237 →
E 36 T AMG (124.092)	Petrol	200	05/94 → 06/96	ENGINE: 072237 →

ATS21



KW



MERCEDES-BENZ

CLASSE E Station wagon (S210)

E 200 T (210.235) Petrol 100 06/96 → 08/00

E 200 T
Kompressor
(210.248) Petrol 120 08/00 → 03/03E 220 T CDI
(210.206) Diesel 92 06/98 → 07/99E 230 T
(210.237) Petrol 110 06/96 → 06/97E 250 T Turbo-D
(210.215) Diesel 110 06/97 → 07/99E 270 T CDI
(210.216) Diesel 125 07/99 → 03/03E 290 T Turbo-D
(210.217) Diesel 95 06/96 → 07/99E 320 T CDI
(210.226) Diesel 145 07/99 → 03/03E 420 T
(210.272) Petrol 205 06/96 → 06/97

CLASSE E T-Model (S211)

E 200 T
Kompressor
(211.242) Petrol 120 03/03 → 07/09E 220 T CDI
(211.206) Diesel 110 03/03 → 07/09E 270 T CDI
(211.216) Diesel 130 03/03 → 07/09E 320 T CDI
(211.226) Diesel 150 03/03 → 07/09E 55 T AMG
Kompressor
(211.276) Petrol 350 07/03 → 07/09

CLASSE G (W461)

G 290 TD
(461.335,
461.336) Diesel 88 07/97 →

CLASSE G (W463)

G 270 CDI
(463.322,
463.323) Diesel 115 10/01 →G 320 (463.230,
463.231) Petrol 155 09/94 → 12/97 CHASSIS: 001163 →G 400 CDI
(463.332,
463.333) Diesel 184 12/00 →

ATS21



KW



MERCEDES-BENZ

CLASSE G Cabrio (W463)

320 GE (463.208) Petrol 155 09/94 → 11/97 CHASSIS: 001163 →

G 400 CDI
(463.309) Diesel 184 12/00 →

CLASSE M (W163)

ML 400 CDI
(163.128) Diesel 184 09/01 → 06/05

CLASSE S (W140)

300 SE 2.8
(140.028) Petrol 145 01/93 → 10/98 ENGINE: 000781 →,
→ 001151300 SE,SEL/
S320 (140.032,
140.033) Petrol 170 03/91 → 10/98 ENGINE: 036701 →,
→ 073222S 280 (140.028) Petrol 142 02/93 → 10/98 ENGINE: 000781 →,
→ 001151

CLASSE S (W220)

S 320 CDI
(220.025,
220.125) Diesel 150 09/02 → 08/05S 320 CDI
(220.026,
220.126) Diesel 145 08/99 → 09/02S 400 CDI
(220.028,
220.128) Diesel 184 06/00 → 08/05

S 600 (220.176) Petrol 368 09/02 → 08/05

CLASSE S Coupé (C215)

CL 55 AMG
Kompressor
(215.374) Petrol 368 06/02 → 03/06

CL 600 (215.376) Petrol 368 09/02 → 03/06

CLASSE V (638/2)

V 200 CDI
(638.294) Diesel 75 03/99 → 07/03V 220 CDI
(638.294) Diesel 90 03/99 → 07/03

CLK (C208)

200 Kompressor
(208.345) Petrol 141 06/97 → 06/00230 Kompressor
(208.347) Petrol 142 06/97 → 06/00

ATS21

MERCEDES-BENZ
CLK (C209)

200 CGI (209.343)	Petrol	125	07/03 → 05/09	
200 Kompressor (209.342)	Petrol	120	09/02 → 05/09	
270 CDI (209.316)	Diesel	125	10/02 → 05/09	

CLK Cabriolet (A208)

200 Kompressor (208.445)	Petrol	141	03/98 → 06/00	
230 Kompressor (208.447)	Petrol	142	03/98 → 06/00	

CLK Cabriolet (A209)

CLK 200 CGI (209.443)	Petrol	125	07/03 → 03/10	
CLK 200 Kompressor (209.442)	Petrol	120	02/03 → 03/10	

COUPE (C124)

220 CE (124.042)	Petrol	110	10/92 → 05/93	ENGINE: 080037 →
320 CE (124.052)	Petrol	162	10/92 → 05/93	ENGINE: 004357 →

KOMBI Station wagon (S124)

200 TE (124.079)	Petrol	100	05/86 → 06/93	ENGINE: 028683 →
220 TE (124.082)	Petrol	110	10/92 → 05/93	ENGINE: 079784 →
280 TE (124.088)	Petrol	145	10/92 → 06/93	ENGINE: 048697 →
320 TE (124.092)	Petrol	162	10/92 → 06/93	ENGINE: 072237 →

SL (R129)

280 (129.058)	Petrol	142	08/93 → 10/01	ENGINE: 000949 → ENGINE: → 001545
320 (129.063)	Petrol	170	09/93 → 10/01	ENGINE: 011342 → ENGINE: → 022858
600 (129.076)	Petrol	290	07/92 → 10/01	

SL (R230)

55 AMG (230.474)	Petrol	350	10/01 → 06/02	
55 AMG Kompressor (230.474)	Petrol	368	06/02 → 01/12	
600 (230.476)	Petrol	368	04/03 → 01/12	

SLK (R170)

32 AMG Kompressor (170.466)	Petrol	260	03/01 → 04/04	
-----------------------------	--------	-----	---------------	--

ATS21

MERCEDES-BENZ
SPRINTER 2-t Autobus (901, 902)

214	Petrol	105	02/95 → 05/06	CHASSIS: P516380 →
208 CDI	Diesel	60	04/00 → 05/06	
208 D	Diesel	58	02/95 → 04/00	CHASSIS: P516380 →
210 D	Diesel	75	03/97 → 04/00	CHASSIS: P516380 →
211 CDI	Diesel	80	04/00 → 05/06	
212 D	Diesel	90	02/95 → 04/00	CHASSIS: P516380 →
213 CDI	Diesel	95	04/00 → 05/06	
216 CDI	Diesel	115	04/00 → 05/06	

SPRINTER 2-t Furgonato (901, 902)

214	Petrol	105	02/95 → 05/06	CHASSIS: P516380 →
208 CDI	Diesel	60	04/00 → 05/06	
208 D	Diesel	58	02/95 → 04/00	
210 D	Diesel	75	01/97 → 04/00	
211 CDI	Diesel	80	04/00 → 05/06	
212 D	Diesel	90	02/95 → 04/00	
213 CDI	Diesel	95	04/00 → 05/06	
216 CDI	Diesel	115	04/00 → 05/06	

SPRINTER 2-t Pianale piatto/Telaio (901, 902)

214	Petrol	105	02/95 → 05/06	CHASSIS: P516380 →
208 CDI	Diesel	60	04/00 → 05/06	
208 D	Diesel	58	01/95 → 04/00	
210 D	Diesel	75	01/97 → 04/00	
211 CDI	Diesel	80	04/00 → 05/06	
212 D	Diesel	90	02/95 → 04/00	
213 CDI	Diesel	95	04/00 → 05/06	
216 CDI	Diesel	115	04/00 → 05/06	

SPRINTER 3-t Autobus (903)

314	Petrol	105	02/95 → 05/06	CHASSIS: P516380 →
308 CDI	Diesel	60	04/00 → 05/06	
308 D	Diesel	58	02/95 → 04/00	
310 D 4x4	Diesel	75	05/97 → 08/02	
311 CDI	Diesel	80	04/00 → 05/06	
311 CDI 4x4	Diesel	80	08/02 → 05/06	
312 D 2.9	Diesel	90	02/95 → 04/00	
312 D 2.9 4x4	Diesel	90	05/97 → 08/02	
313 CDI 4x4	Diesel	95	08/02 → 05/06	
314 4x4	Petrol	105	08/02 → 05/06	CHASSIS: R000001 →
316 CDI	Diesel	115	04/00 → 05/06	
316 CDI 4x4	Diesel	115	08/02 → 05/06	

SPRINTER 3-t Furgonato (903)

314	Petrol	105	02/95 → 05/06	CHASSIS: P516380 →
308 CDI	Diesel	60	04/00 → 05/06	
308 D 2.3	Diesel	58	02/95 → 04/00	
310 D 2.9	Diesel	75	02/95 → 04/00	

ATS21



KW



MERCEDES-BENZ

SPRINTER 3-t Furgonato (903)

311 CDI	Diesel	80	04/00 → 05/06	
311 CDI 4x4	Diesel	80	08/02 → 05/06	
312 D 2.9	Diesel	90	02/95 → 04/00	
313 CDI	Diesel	95	04/00 → 05/06	
313 CDI 4x4	Diesel	95	08/02 → 05/06	
314 4x4	Petrol	105	08/02 → 05/06	CHASSIS: R000001 →
316 CDI	Diesel	115	04/00 → 05/06	
316 CDI 4x4	Diesel	115	08/02 → 05/06	

SPRINTER 3-t Pianale piatto/Telaio (903)

314	Petrol	105	02/95 → 05/06	CHASSIS: P516380 →
308 CDI	Diesel	60	04/00 → 05/06	
308 D 2.3	Diesel	58	02/95 → 04/00	
310 D 2.9	Diesel	75	01/97 → 04/00	
311 CDI	Diesel	80	04/00 → 05/06	
311 CDI 4x4	Diesel	80	08/02 → 05/06	
312 D 2.9	Diesel	90	02/95 → 04/00	
313 CDI	Diesel	95	04/00 → 05/06	
314 4x4	Petrol	105	08/02 → 05/06	CHASSIS: R000001 →
316 CDI	Diesel	115	04/00 → 05/06	
316 CDI 4x4	Diesel	115	08/02 → 05/06	

SPRINTER 4-t Autobus (904)

414	Petrol	105	02/96 → 05/06	CHASSIS: P516380 →
408 CDI	Diesel	60	04/00 → 05/06	
411 CDI	Diesel	80	04/00 → 05/06	
413 CDI	Diesel	95	04/00 → 05/06	
416 CDI	Diesel	115	04/00 → 05/06	

SPRINTER 4-t Furgonato (904)

414	Petrol	105	02/96 → 05/06	CHASSIS: P516380 →
408 CDI	Diesel	60	04/00 → 05/06	
408 D	Diesel	58	02/96 → 05/06	
410 D	Diesel	75	02/96 → 05/06	
410 D 4x4	Diesel	75	05/97 → 05/06	
411 CDI	Diesel	80	04/00 → 05/06	
411 CDI 4x4	Diesel	80	04/00 → 05/06	
412 D	Diesel	90	02/96 → 05/06	
412 D 4x4	Diesel	90	05/97 → 05/06	
413 CDI	Diesel	95	04/00 → 05/06	
414 4x4	Petrol	105	05/97 → 05/06	CHASSIS: R000001 →
416 CDI	Diesel	115	04/00 → 05/06	
416 CDI 4x4	Diesel	115	04/00 → 05/06	

ATS21



KW



MERCEDES-BENZ

SPRINTER 4-t Pianale piatto/Telaio (904)

414	Petrol	105	02/96 → 05/06	CHASSIS: P516380 →
408 CDI	Diesel	60	04/00 → 05/06	
408 D	Diesel	58	02/96 → 05/06	
410 D	Diesel	75	02/96 → 05/06	
410 D 4x4	Diesel	75	05/97 → 05/06	
411 CDI	Diesel	80	04/00 → 05/06	
411 CDI 4x4	Diesel	80	04/00 → 05/06	
412 D	Diesel	90	02/96 → 05/06	
412 D 4x4	Diesel	90	05/97 → 05/06	
413 CDI	Diesel	95	04/00 → 05/06	
414 4x4	Petrol	105	05/97 → 05/06	CHASSIS: R000001 →
416 CDI	Diesel	115	04/00 → 05/06	
416 CDI 4x4	Diesel	115	04/00 → 05/06	

Tre volumi (W124)

200 E (124.019)	Petrol	100	10/92 → 06/93	ENGINE: 055902 →
220 E (124.022)	Petrol	110	10/92 → 06/93	ENGINE: 080037 →
280 E (124.028)	Petrol	145	10/92 → 06/93	ENGINE: 005790 →
320 E (124.032)	Petrol	162	10/92 → 06/93	ENGINE: 004357 →

VANEO (414)

1.6 (414.700)	Petrol	60	02/02 → 07/05	
1.6 (414.700)	Petrol	75	02/02 → 07/05	
1.7 CDI (414.700)	Diesel	55	02/02 → 07/05	
1.9 (414.700)	Petrol	92	02/02 → 07/05	

VITO Autobus (638)

108 CDI 2.2 (638.194)	Diesel	60	03/99 → 07/03	
110 CDI 2.2 (638.194)	Diesel	75	03/99 → 07/03	
112 CDI 2.2 (638.194)	Diesel	90	03/99 → 07/03	
108 CDI 2.2 (638.094)	Diesel	60	03/99 → 07/03	

VITO Furgonato (638)

110 CDI 2.2 (638.094)	Diesel	75	03/99 → 07/03	
112 CDI 2.2 (638.094)	Diesel	90	03/99 → 07/03	

SMART

CABRIO (450)

0.6 (450.400, S1OLD2)	Petrol	45	01/01 → 01/04	
0.6 (450.432)	Petrol	52	06/02 → 01/04	
0.6 (450.433, S1OLA1)	Petrol	40	03/00 → 01/04	

ATS21

SMART
CABRIO (450)

0.7 (450.400)	Petrol	45	01/03 → 01/04
0.7 (450.414)	Petrol	55	01/03 → 01/04
0.8 CDI (450.401, 450.402, 450.403, S1OLC1)	Diesel	30	03/01 → 01/04

CITY-COUPÉ (450)

0.6 (450.330, 450.332)	Petrol	52	06/02 → 01/04
0.6 (450.333, 450.335)	Petrol	45	01/01 → 01/04
0.6 (450.341, S1CLA1)	Petrol	40	07/98 → 01/04
0.6 (450.342, S1CLB1)	Petrol	33	07/98 → 01/04
0.7 (450.314)	Petrol	55	01/03 → 01/04
0.7 (450.336, 450.352, 450.353)	Petrol	45	01/03 → 01/04
0.7 (450.347)	Petrol	37	01/03 → 01/04
0.8 CDI (450.300, 450.301, 450.302, 450.303, 450.306...)	Diesel	30	11/99 → 01/04

FORFOUR (454)

1.5 CDI (454.000)	Diesel	50	09/04 → 06/06
1.5 CDI (454.001)	Diesel	70	09/04 → 06/06

FORTWO Cabrio (450)

0.7 (450.414, 450.441, 450.442, 450.443, 450.452)	Petrol	45	01/04 → 01/07
0.7 (450.452)	Petrol	55	01/04 → 01/07
0.8 CDI (450.401, 450.402, 450.403)	Diesel	30	01/04 → 01/07

FORTWO Coupé (450)

0.7 (450.314)	Petrol	55	01/04 → 01/07
0.7 (450.331)	Petrol	37	01/04 → 01/07
0.7 (450.335, 450.336, 450.341, 450.342, 450.343...)	Petrol	45	01/04 → 01/07

ATS21

SMART
FORTWO Coupé (450)

0.8 CDI (450.300, 450.301, 450.302, 450.303, 450.306)	Diesel	30	01/04 → 01/07
---	--------	----	---------------

ROADSTER (452)

0.7 (452.432)	Petrol	45	04/03 → 11/05
0.7 (452.434)	Petrol	60	04/03 → 11/05
0.7 Brabus (452.437)	Petrol	74	12/03 → 11/05

ROADSTER Coupé (452)

0.7 (452.334)	Petrol	60	04/03 → 11/05
0.7 Brabus (452.337)	Petrol	74	12/03 → 11/05

SSANGYONG
KORANDO (KJ)

2.3	Petrol	105	01/99 →
3.2	Petrol	156	01/99 →

KORANDO Cabrio (KJ)

2.3	Petrol	105	02/99 →
3.2	Petrol	156	01/99 →

VOLKSWAGEN
LT 28-35 II Autobus (2DB, 2DE, 2DK)

2.3	Petrol	105	05/96 → 07/06
-----	--------	-----	---------------

LT 28-46 II Furgonato (2DA, 2DD, 2DH)

2.3	Petrol	105	05/96 → 07/06
-----	--------	-----	---------------

LT 28-46 II Pianale piatto/Telaio (2DC, 2DF, 2DG, 2DL, 2DM)

2.3	Petrol	105	06/96 → 07/06
-----	--------	-----	---------------

ATS22

F2 **SENSORE TEMPERATURA ARIA**
AIR TEMPERATURE SENSOR



CITROËN

BERLINGO (B9)

1.6 HDi 110	Diesel	80	04/08 →
1.6 HDi 75	Diesel	55	04/08 →
1.6 HDi 90	Diesel	66	04/08 →

BERLINGO (MF)

1.6 HDi 75 (MF9HW)	Diesel	55	07/05 →
1.6 HDi 90 (MF9HX)	Diesel	66	07/05 →

BERLINGO Furgonato (B9)

1.6 HDi 110	Diesel	80	04/08 →
1.6 HDi 75	Diesel	55	04/08 →
1.6 HDi 90	Diesel	66	04/08 →

BERLINGO Furgonato (M_)

1.6 HDi 75 (MB9HW)	Diesel	55	07/05 →
1.6 HDi 90 (MB9HX, MC9HX)	Diesel	66	07/05 →

C1 (PM_, PN_)

1.4 HDi	Diesel	40	06/05 →
---------	--------	----	---------

C2 (JM_)

1.4 HDi	Diesel	50	09/03 →
1.6 HDi	Diesel	80	09/05 →

C3 I (FC_)

1.4 HDi	Diesel	50	02/02 →
1.6 16V HDi	Diesel	66	10/05 →
1.6 16V HDi	Diesel	80	09/05 →

C3 Pluriel (HB_)

1.4 HDi	Diesel	50	04/04 →
---------	--------	----	---------

C4 Coupé (LA_)

1.6 HDi	Diesel	66	11/04 →
1.6 HDi	Diesel	80	11/04 →
2.0 HDi	Diesel	100	11/04 →

ATS22



CITROËN

C4 Grand Picasso I (UA_)

1.6 HDi	Diesel	80	10/06 →
2.0 HDi 138	Diesel	100	10/06 →

C4 I (LC_)

1.6 HDi	Diesel	66	11/04 →
1.6 HDi	Diesel	80	11/04 →
2.0 HDi	Diesel	100	11/04 →

C4 Picasso I (UD_)

1.6 HDi	Diesel	80	02/07 →
2.0 HDi 138	Diesel	100	02/07 →

C5 II (RC_)

1.6 HDi (RC8HZB)	Diesel	80	09/04 →
2.0 HDi (RCRHRH)	Diesel	100	09/04 →

C5 II Break (RE_)

1.6 HDi (RE8HZB)	Diesel	80	09/04 →
2.0 HDi (RERHRH)	Diesel	100	09/04 →

C5 III (RD_)

1.6 HDi	Diesel	80	02/08 →
2.0 HDi	Diesel	100	02/08 →
2.2 HDi	Diesel	125	02/08 →

C5 III Break (TD_)

1.6 HDi	Diesel	80	02/08 →
2.0 HDi	Diesel	100	02/08 →
2.2 HDi	Diesel	125	02/08 →

C6 (TD_)

2.2 HDi	Diesel	125	06/06 →
---------	--------	-----	---------

C8 (EA_, EB_)

2.0 HDi	Diesel	88	02/07 →
2.0 HDi 135	Diesel	100	03/06 →
2.2 HDi	Diesel	125	06/06 →

C-CROSSER (EP_)

2.2 HDi	Diesel	115	02/07 →
---------	--------	-----	---------

JUMPY

1.6 HDi 90 16V	Diesel	66	01/07 →
2.0 HDi 120	Diesel	88	01/07 →
2.0 HDi 140	Diesel	100	01/07 →

JUMPY Furgonato

2.0 HDi 120	Diesel	88	01/07 →
2.0 HDi 140	Diesel	100	01/07 →

ATS22

CITROËN
NEMO Furgonato (AA_)

1.4 HDi Diesel 50 02/08 →

XSARA PICASSO (N68)

1.6 HDi Diesel 66 09/05 →

1.6 HDi Diesel 80 05/04 →

FIAT
SCUDO (270_)

1.6 D Multijet Diesel 66 01/07 →

2.0 D Multijet Diesel 100 01/07 →

2.0 D Multijet Diesel 88 01/07 →

SCUDO Furgonato (270_)

1.6 D Multijet Diesel 66 01/07 →

2.0 D Multijet Diesel 100 01/07 →

2.0 D Multijet Diesel 88 01/07 →

ULYSSE (179AX)

2.0 D Multijet Diesel 100 05/06 → 06/11

FORD
C-MAX (DM2)

1.6 TDCi Diesel 66 02/07 →

1.6 TDCi Diesel 80 02/07 →

1.8 TDCi Diesel 85 02/07 →

2.0 TDCi Diesel 100 02/07 →

2.0 TDCi Diesel 81 02/08 →

FIESTA V (JH_, JD_)

1.4 TDCi Diesel 50 11/01 → 06/08

1.6 TDCi Diesel 66 11/04 → 06/08

FIESTA Van

1.4 TDCi Diesel 50 10/03 →

FIESTA VI

1.6 TDCi Diesel 66 06/08 →

FOCUS C-MAX

1.6 TDCi Diesel 66 02/05 → 03/07

1.6 TDCi Diesel 80 10/03 → 03/07

1.8 TDCi Diesel 85 01/05 → 03/07

2.0 TDCi Diesel 100 10/03 → 03/07

FOCUS II (DA_)

1.6 TDCi Diesel 80 11/04 →

1.6 TDCi Diesel 66 01/05 →

1.8 TDCi Diesel 85 01/05 →

2.0 TDCi Diesel 100 11/04 →

FOCUS II Cabriolet

2.0 TDCi Diesel 100 10/06 →

ATS22

FORD
FOCUS II Station wagon (DA_)

1.6 TDCi Diesel 66 11/04 →

1.6 TDCi Diesel 80 11/04 →

1.8 TDCi Diesel 85 11/04 →

2.0 TDCi Diesel 100 11/04 →

FOCUS II Tre volumi (DA_)

1.6 TDCi Diesel 66 04/05 →

1.6 TDCi Diesel 80 04/05 →

1.8 TDCi Diesel 85 04/05 →

2.0 TDCi Diesel 100 04/05 →

FUSION (JU_)

1.4 TDCi Diesel 50 08/02 →

1.6 TDCi Diesel 66 11/04 →

GALAXY (WA6)

1.8 TDCi Diesel 74 05/06 →

1.8 TDCi Diesel 92 05/06 →

2.0 TDCi Diesel 103 05/06 →

2.0 TDCi Diesel 85 11/07 →

2.0 TDCi Diesel 96 05/06 →

2.2 TDCi Diesel 129 03/08 →

KUGA I

2.0 TDCi Diesel 100 03/08 →

2.0 TDCi 4x4 Diesel 100 03/08 →

MONDEO IV (BA7)

1.8 TDCi Diesel 74 03/07 →

2.0 TDCi Diesel 103 03/07 →

2.0 TDCi Diesel 85 11/07 →

2.0 TDCi Diesel 96 03/07 →

2.2 TDCi Diesel 129 03/08 →

MONDEO IV Tre volumi (BA7)

2.0 TDCi Diesel 103 03/07 →

2.0 TDCi Diesel 85 11/07 →

2.0 TDCi Diesel 96 03/07 →

2.2 TDCi Diesel 129 03/08 →

MONDEO IV Turnier (BA7)

1.8 TDCi Diesel 74 03/07 →

2.0 TDCi Diesel 103 03/07 →

2.0 TDCi Diesel 85 11/07 →

2.0 TDCi Diesel 96 03/07 →

2.2 TDCi Diesel 129 03/08 →

S-MAX (WA6)

1.8 TDCi Diesel 92 05/06 →

2.0 TDCi Diesel 103 05/06 →

2.0 TDCi Diesel 85 11/07 →

2.0 TDCi Diesel 96 05/06 →

ATS22



KW



FORD

S-MAX (WA6)

2.2 TDCi Diesel 129 03/08 →

LANCIA

PHEDRA (179)

2.0 D Multijet Diesel 100 07/06 → 11/10

2.2 D Multijet Diesel 125 03/08 → 11/10

PEUGEOT

1007 (KM_)

1.4 HDi Diesel 50 04/05 →

1.6 HDi Diesel 80 06/07 →

107

1.4 HDi Diesel 40 06/05 →

206 2 volumi /Coda spiovente (2A/C)

1.4 HDi eco 70 Diesel 50 09/01 →

1.6 HDi 110 Diesel 80 05/04 →

206 CC (2D)

1.6 HDi 110 Diesel 80 04/05 →

206 SW (2E/K)

1.4 HDi Diesel 50 07/02 →

1.6 HDi 110 Diesel 80 05/04 →

207 (WA_, WC_)

1.4 HDi Diesel 50 02/06 →

1.6 HDi Diesel 66 02/06 →

1.6 HDi Diesel 80 02/06 →

207 CC (WD_)

1.6 HDi Diesel 80 02/07 →

207 SW (WK_)

1.6 HDi Diesel 80 06/07 →

307 (3A/C)

1.6 HDi Diesel 66 04/05 →

1.6 HDi 110 Diesel 80 02/04 →

2.0 HDi 135 Diesel 100 10/03 →

307 Break (3E)

1.6 HDi Diesel 66 04/05 →

1.6 HDi 110 Diesel 80 02/04 →

2.0 HDi 135 Diesel 100 02/04 →

307 CC (3B)

2.0 HDi 135 Diesel 100 06/05 →

307 SW (3H)

1.6 HDi 110 Diesel 80 02/04 →

2.0 HDi 135 Diesel 100 02/04 →

308 (4A_, 4C_)

1.6 HDi Diesel 66 09/07 →

1.6 HDi Diesel 80 09/07 →

2.0 HDi Diesel 100 09/07 →

ATS22



KW



PEUGEOT

308 SW

1.6 HDi Diesel 66 09/07 →

1.6 HDi Diesel 80 09/07 →

2.0 HDi Diesel 100 09/07 →

4007 (GP_)

2.2 HDi Diesel 115 02/07 →

407 (6D_)

1.6 HDi 110 Diesel 80 05/04 →

2.0 HDi 135 Diesel 100 05/04 →

2.2 HDi 170 Diesel 125 05/06 →

407 Coupé (6C_)

2.0 HDi Diesel 100 10/05 →

407 SW (6E_)

1.6 HDi 110 Diesel 80 05/04 →

2.0 HDi 135 Diesel 100 05/04 →

2.2 HDi 170 Diesel 125 05/06 →

607 (9D, 9U)

2.0 HDi Diesel 100 09/05 →

2.2 HDi Diesel 125 05/06 →

807 (E)

2.0 HDi Diesel 79 06/02 →

2.0 HDi Diesel 100 06/06 →

2.2 HDi Diesel 125 06/06 →

BIPPER (AA_)

1.4 HDi Diesel 50 02/08 →

EXPERT Furgonato (VF3A_, VF3U_, VF3X_)

1.6 HDi 90 16V Diesel 66 01/07 →

2.0 HDi 120 Diesel 88 01/07 →

2.0 HDi 140 Diesel 100 01/07 →

EXPERT Pianale piatto/Telaio

1.6 HDi 90 Diesel 66 01/07 →

2.0 HDi 120 Diesel 88 01/07 →

2.0 HDi 140 Diesel 100 01/07 →

EXPERT Tepee (VF3V_)

1.6 HDi 90 16V Diesel 66 01/07 →

2.0 HDi 120 Diesel 88 01/07 →

2.0 HDi 140 Diesel 100 01/07 →

RANCH

1.6 HDi Diesel 55 04/08 →

1.6 HDi Diesel 66 04/08 →

1.6 HDi Diesel 80 04/08 →

RANCH Furgonato

1.6 HDi Diesel 55 04/08 →

1.6 HDi Diesel 66 04/08 →

1.6 HDi Diesel 80 04/08 →

ATS22

KW

PEUGEOT
RANCH Furgonato (5)

1.6 HDi 75	Diesel	55	02/06 →
1.6 HDi 90	Diesel	66	02/06 →

RANCH MPV / Space wagon (5F)

1.6 HDi 75	Diesel	55	02/06 →
1.6 HDi 90	Diesel	66	02/06 →

TOYOTA
AYGO (WNB1_, KGB1_)

1.4 HDi (WNB10)	Diesel	40	07/05 → 08/10
-----------------	--------	----	---------------

VOLVO
C30

1.6 D	Diesel	80	10/06 → 12/12
2.0 D	Diesel	100	10/06 → 12/12

C70 II Cabriolet

2.0 D	Diesel	100	01/08 →
-------	--------	-----	---------

S40 II (MS)

1.6 D	Diesel	81	01/05 →
2.0 D	Diesel	100	01/04 →

V50 (MW)

1.6 D	Diesel	81	01/05 →
2.0 D	Diesel	100	04/04 →

V70 III (BW)

2.0 D	Diesel	100	10/07 →
-------	--------	-----	---------

ATS23
F2
**SENSORE TEMPERATURA ARIA
AIR TEMPERATURE SENSOR**

KW

SEAT
ALHAMBRA (7V8, 7V9)

1.8 T 20V	Petrol	110	10/97 → 03/10
1.9 TDI	Diesel	110	05/05 → 05/07
1.9 TDI	Diesel	96	11/02 → 11/08
1.9 TDI	Diesel	85	06/00 → 03/10
1.9 TDI 4motion	Diesel	85	06/00 → 03/10

ATS23

KW

SEAT
ALHAMBRA (7V8, 7V9)

2.8 V6	Petrol	150	06/00 → 03/10
2.8 V6 4motion	Petrol	150	06/00 → 03/10

AROSA (6H)

1.4 16V	Petrol	74	01/00 → 06/04
1.4 TDI	Diesel	55	01/00 → 06/04

CORDOBA (6L2)

1.2	Petrol	47	10/02 → 06/06
1.4 16V	Petrol	55	09/02 → 12/07
1.4 16V	Petrol	74	10/02 → 11/09
1.4 TDI	Diesel	55	10/02 → 12/05
1.6	Petrol	74	04/03 → 11/09
1.9 TDI	Diesel	96	10/02 → 11/09
1.9 TDI	Diesel	74	09/02 → 11/09
2.0	Petrol	85	09/02 → 11/09

IBIZA IV (6L1)

1.2	Petrol	47	02/02 → 06/06
1.4 16V	Petrol	55	02/02 → 12/07
1.4 16V	Petrol	74	02/02 → 11/09
1.4 TDI	Diesel	55	05/02 → 12/05
1.6	Petrol	74	02/03 → 11/09
1.9 TDI	Diesel	96	02/02 → 11/09
1.9 TDI	Diesel	74	02/02 → 11/09
1.9 TDI Cupra R	Diesel	118	03/04 → 02/08

LEON (1M1)

1.4 16V	Petrol	55	11/99 → 06/06
1.6	Petrol	74	11/99 → 06/06
1.6 16 V	Petrol	77	09/00 → 06/06
1.8 20V	Petrol	92	11/99 → 06/06
1.8 20V T	Petrol	132	11/99 → 06/06
1.8 20V T 4	Petrol	132	11/99 → 06/06
1.8 T Cupra R	Petrol	154	02/02 → 06/06
1.9 TDI	Diesel	110	02/01 → 06/06
1.9 TDI	Diesel	96	05/03 → 06/06
1.9 TDI	Diesel	66	11/99 → 06/06
1.9 TDI	Diesel	81	11/99 → 06/06
1.9 TDI Syncro	Diesel	110	05/02 → 06/06
2.8 Cupra 4	Petrol	150	02/01 → 06/06

LEON (1P1)

1.6	Petrol	75	07/05 →
1.9 TDI	Diesel	77	07/05 →
2.0 FSI	Petrol	110	07/05 → 05/10
2.0 TDI 16V	Diesel	103	07/05 →
2.0 TFSI	Petrol	136	09/05 → 05/06

ATS23



KW



SEAT

TOLEDO II (1M2)

1.4 16V	Petrol	55	07/99 → 05/06
1.6	Petrol	74	04/99 → 09/00
1.6 16V	Petrol	77	09/00 → 05/06
1.8 20V	Petrol	92	04/99 → 05/06
1.8 20VT	Petrol	132	05/01 → 05/06
1.9 SDI	Diesel	50	11/99 → 06/04
1.9 TDI	Diesel	96	05/03 → 05/06
1.9 TDI	Diesel	110	10/00 → 05/06
1.9 TDI	Diesel	66	04/99 → 05/06
1.9 TDI	Diesel	81	04/99 → 05/06
2.3 V5	Petrol	110	04/99 → 05/01
2.3 V5 20V	Petrol	125	05/01 → 05/06

SKODA

FABIA (6Y2)

1.0	Petrol	37	12/99 → 08/02
1.2	Petrol	40	08/02 → 03/08
1.2	Petrol	47	01/03 → 03/08
1.4	Petrol	44	08/00 → 08/02
1.4	Petrol	50	08/99 → 05/03
1.4 16V	Petrol	55	12/99 → 03/08
1.4 16V	Petrol	74	12/99 → 03/08
1.4 TDI	Diesel	55	04/03 → 03/08
1.9 TDI	Diesel	74	01/00 → 03/08
1.9 TDI RS	Diesel	96	06/03 → 03/08
2.0	Petrol	85	12/99 → 03/08

FABIA Combi (6Y5)

1.2	Petrol	40	07/01 → 12/07
1.2	Petrol	47	01/03 → 12/07
1.4	Petrol	44	04/00 → 03/03
1.4	Petrol	50	04/00 → 05/03
1.4 16V	Petrol	55	05/00 → 12/07
1.4 16V	Petrol	74	04/00 → 12/07
1.4 TDI	Diesel	55	04/03 → 12/07
1.9 TDI	Diesel	74	04/00 → 12/07
2.0	Petrol	85	04/00 → 12/07

FABIA Praktik

1.2	Petrol	47	01/03 → 12/07
-----	--------	----	---------------

FABIA Tre volumi (6Y3)

1.2	Petrol	40	07/01 → 12/07
1.2	Petrol	47	01/03 → 12/07
1.4	Petrol	44	04/00 → 08/02
1.4	Petrol	50	07/01 → 05/03
1.4 16V	Petrol	55	10/99 → 12/07
1.4 16V	Petrol	74	12/99 → 12/07

ATS23



KW



SKODA

FABIA Tre volumi (6Y3)

1.4 TDI	Diesel	55	04/03 → 12/07
1.9 TDI	Diesel	74	01/00 → 12/07
2.0	Petrol	85	12/99 → 12/07

OCTAVIA (1U2)

1.4	Petrol	44	04/99 → 03/01	
1.4 16V	Petrol	55	09/00 → 12/10	
1.6	Petrol	75	11/00 → 12/10	
1.8 T	Petrol	110	08/97 → 12/10	CHASSIS: F1UX228001 →
1.8 T 4x4	Petrol	110	05/01 → 05/06	
1.9 TDI	Diesel	81	08/97 → 01/06	CHASSIS: F1UX228001 →
1.9 TDI	Diesel	96	09/02 → 09/04	
2.0	Petrol	85	04/99 → 05/07	
RS 1.8 T	Petrol	132	05/01 → 01/06	

OCTAVIA (1Z3)

1.4	Petrol	55	05/04 → 05/06
1.6	Petrol	75	06/04 →
1.6 FSI	Petrol	85	02/04 → 10/08
1.9 TDI	Diesel	77	06/04 → 12/10
2.0 FSI	Petrol	110	11/04 →
2.0 TDI 16V	Diesel	103	02/04 →

OCTAVIA Combi (1U5)

1.4 16V	Petrol	55	08/00 → 12/10
1.6	Petrol	74	07/98 → 12/07
1.6	Petrol	55	07/98 → 09/04
1.6	Petrol	75	09/00 → 12/10
1.8 20V	Petrol	92	07/98 → 07/00
1.8 T	Petrol	110	07/98 → 12/10
1.8 T 4x4	Petrol	110	05/01 → 05/06
1.9 TDI	Diesel	66	07/98 → 03/10
1.9 TDI	Diesel	81	07/98 → 01/06
1.9 TDI	Diesel	96	09/02 → 09/04
1.9 Tdi 4x4	Diesel	66	11/99 → 02/06
1.9 Tdi 4x4	Diesel	74	09/00 → 01/06
2.0	Petrol	85	04/99 → 05/07
2.0 4x4	Petrol	85	08/00 → 09/04
2.0 4x4	Petrol	88	01/00 → 12/10
RS 1.8 T	Petrol	132	08/02 → 01/06

OCTAVIA Combi (1Z5)

1.6	Petrol	75	09/04 →
1.9 TDI	Diesel	77	09/04 → 12/10
1.9 Tdi 4x4	Diesel	77	11/04 → 12/10
2.0 FSI	Petrol	110	11/04 →

ATS23

SKODA
OCTAVIA Combi (1Z5)

2.0 FSI 4x4	Petrol	110	11/04 →
2.0 TDI 16V	Diesel	103	02/04 →

VOLKSWAGEN
BORA (1J2)

1.4 16V	Petrol	55	03/00 → 05/05
1.6	Petrol	75	08/00 → 05/05
1.6	Petrol	74	10/98 → 05/05
1.6 16V	Petrol	77	05/00 → 05/05
1.6 FSI	Petrol	81	01/02 → 05/05
1.8	Petrol	92	10/98 → 05/05
1.8 4motion	Petrol	92	02/99 → 05/05
1.8 T	Petrol	110	05/00 → 05/05
1.8 T	Petrol	132	03/02 → 05/05
1.9 TDI	Diesel	110	05/00 → 05/05
1.9 TDI	Diesel	96	11/00 → 05/05
1.9 TDI	Diesel	66	10/98 → 06/01
1.9 TDI	Diesel	81	10/98 → 06/01
1.9 TDI	Diesel	85	12/98 → 01/02
1.9 TDI	Diesel	74	09/00 → 05/05
1.9 TDI 4motion	Diesel	110	05/00 → 05/05
1.9 TDI 4motion	Diesel	96	11/00 → 05/05
1.9 TDI 4motion	Diesel	66	02/99 → 06/01
1.9 TDI 4motion	Diesel	85	02/99 → 06/01
1.9 TDI 4motion	Diesel	74	09/00 → 05/05
2.0	Petrol	85	10/98 → 05/05
2.0 4motion	Petrol	85	04/00 → 05/05
2.3 V5	Petrol	125	10/00 → 05/05
2.3 V5 4motion	Petrol	125	10/00 → 05/05
2.8 V6 4motion	Petrol	150	03/99 → 05/05

BORA Station wagon (1J6)

1.4 16V	Petrol	55	09/01 → 05/05
1.6	Petrol	75	08/00 → 05/05
1.6	Petrol	74	05/99 → 05/05
1.6 16V	Petrol	77	02/00 → 05/05
1.6 FSI	Petrol	81	01/02 → 05/05
1.8 4motion	Petrol	92	05/99 → 05/05
1.8 T	Petrol	110	05/00 → 05/05
1.8 T	Petrol	132	05/02 → 05/05
1.9 TDI	Diesel	110	05/01 → 05/05
1.9 TDI	Diesel	96	11/00 → 05/05
1.9 TDI	Diesel	66	07/04 → 05/05
1.9 TDI	Diesel	81	05/99 → 06/01
1.9 TDI	Diesel	85	05/99 → 06/01
1.9 TDI	Diesel	74	09/00 → 05/05

ATS23

VOLKSWAGEN
BORA Station wagon (1J6)

1.9 TDI 4motion	Diesel	110	05/01 → 05/05
1.9 TDI 4motion	Diesel	96	11/00 → 05/05
1.9 TDI 4motion	Diesel	85	05/99 → 06/01
1.9 TDI 4motion	Diesel	74	09/00 → 05/05
2.0	Petrol	85	05/99 → 05/05
2.0 4motion	Petrol	85	04/00 → 05/05
2.3 V5	Petrol	125	10/00 → 05/05
2.3 V5 4motion	Petrol	110	05/99 → 10/00
2.3 V5 4motion	Petrol	125	10/00 → 05/05
2.8 V6 4motion	Petrol	150	05/99 → 05/05

CADDY III Furgonato (2KA, 2KH, 2CA, 2CH)

1.4	Petrol	55	03/04 → 05/06
1.6	Petrol	75	04/04 →
1.9 TDI	Diesel	77	04/04 → 08/10
2.0 SDI	Diesel	51	03/04 → 08/10

FOX (5Z1, 5Z3)

1.2	Petrol	40	04/05 →
1.4	Petrol	55	04/05 →
1.4 TDI	Diesel	51	04/05 →

GOLF IV (1J1)

1.4 16V	Petrol	55	08/97 → 06/05
1.6	Petrol	75	08/00 → 06/05
1.6	Petrol	74	08/97 → 05/04
1.6 16V	Petrol	77	02/00 → 06/05
1.6 FSI	Petrol	81	01/02 → 06/05
1.8	Petrol	92	08/97 → 06/05
1.8 4motion	Petrol	92	05/98 → 06/05
1.8 T	Petrol	110	08/97 → 06/05
1.8 T GTI	Petrol	132	08/01 → 06/05
1.9 TDI	Diesel	110	05/00 → 06/05
1.9 TDI	Diesel	96	11/00 → 06/05
1.9 TDI	Diesel	66	10/97 → 05/04
1.9 TDI	Diesel	74	09/00 → 06/05
1.9 TDI	Diesel	81	08/97 → 05/04
1.9 TDI	Diesel	85	12/98 → 06/01
1.9 TDI 4motion	Diesel	110	02/00 → 06/05
1.9 TDI 4motion	Diesel	96	11/00 → 06/05
1.9 TDI 4motion	Diesel	66	07/98 → 04/02
1.9 TDI 4motion	Diesel	85	09/99 → 06/01
1.9 TDI 4motion	Diesel	74	09/00 → 06/05
2.0	Petrol	85	07/98 → 05/04
2.0 4motion	Petrol	85	10/00 → 06/05
2.3 V5	Petrol	110	08/97 → 10/00
2.3 V5	Petrol	125	10/00 → 06/05

ATS23



KW



VOLKSWAGEN

GOLF IV (1J1)

2.3 V5 4motion	Petrol	125	10/00 → 06/05
2.8 V6 4motion	Petrol	150	03/99 → 06/05
3.2 R32 4motion	Petrol	177	09/02 → 06/05

GOLF IV Variant (1J5)

1.4 16V	Petrol	55	05/99 → 06/06
1.6	Petrol	75	08/00 → 06/06
1.6	Petrol	74	05/99 → 04/02
1.6 16V	Petrol	77	02/00 → 06/06
1.6 FSI	Petrol	81	01/02 → 06/06
1.8 4motion	Petrol	92	05/99 → 06/06
1.8 T	Petrol	110	05/00 → 06/06
1.9 TDI	Diesel	96	11/00 → 06/06
1.9 TDI	Diesel	66	05/99 → 05/06
1.9 TDI	Diesel	81	05/99 → 06/01
1.9 TDI	Diesel	85	08/99 → 06/01
1.9 TDI	Diesel	74	09/00 → 06/06
1.9 TDI 4motion	Diesel	96	11/00 → 06/06
1.9 TDI 4motion	Diesel	66	05/99 → 04/02
1.9 TDI 4motion	Diesel	85	05/99 → 06/01
1.9 TDI 4motion	Diesel	74	09/00 → 06/06
2.0	Petrol	85	05/99 → 06/06
2.0 4motion	Petrol	85	10/00 → 06/06
2.0 Bi-Fuel	BiFuel	85	02/02 → 06/06
2.3 V5	Petrol	110	05/99 → 06/06
2.3 V5	Petrol	125	10/00 → 06/06
2.3 V5 4motion	Petrol	110	05/99 → 06/06
2.3 V5 4motion	Petrol	125	10/00 → 06/06
2.8 V6 4motion	Petrol	150	05/99 → 06/06

LUPO (6X1, 6E1)

1.0	Petrol	37	09/98 → 07/05
1.2 TDI 3L	Diesel	45	07/99 → 07/05
1.4	Petrol	44	10/00 → 07/05
1.4 16V	Petrol	55	09/98 → 07/05
1.4 16V	Petrol	74	08/99 → 07/05
1.4 FSI	Petrol	77	02/01 → 07/05
1.4 TDI	Diesel	55	01/99 → 07/05
1.6 GTI	Petrol	92	09/00 → 07/05

NEW BEETLE (9C1, 1C1)

1.4	Petrol	55	11/01 → 09/10
1.6	Petrol	75	06/00 → 09/10
1.6	Petrol	74	10/99 → 09/00
1.8 T	Petrol	110	10/99 → 09/10
1.9 TDI	Diesel	66	01/98 → 06/04
1.9 TDI	Diesel	74	02/01 → 09/10

ATS23



KW



VOLKSWAGEN

NEW BEETLE (9C1, 1C1)

2.0	Petrol	85	01/98 → 09/10
2.3 V5	Petrol	125	10/00 → 09/10
RSI 3.2 4motion (1C9)	Petrol	165	04/00 → 05/01

NEW BEETLE Cabriolet (1Y7)

1.4	Petrol	55	01/03 → 09/10
1.6	Petrol	75	01/03 → 09/10
1.8 T	Petrol	110	01/03 → 09/10
1.9 TDI	Diesel	74	06/03 → 09/10
2.0	Petrol	85	09/02 → 10/10

PHAETON (3D_)

3.0 V6 TDI 4motion	Diesel	165	09/04 →
3.2 V6	Petrol	177	04/02 →
3.2 V6 4motion	Petrol	177	02/04 →
4.2 V8 4motion	Petrol	246	05/03 →
5.0 V10 TDI 4motion	Diesel	230	11/02 →
6.0 W12 4motion	Petrol	309	04/02 →

POLO (6N2)

1.0	Petrol	37	10/99 → 09/01
1.4	Petrol	40	10/99 → 09/01
1.4	Petrol	44	10/99 → 09/01
1.4 16V	Petrol	55	10/99 → 09/01
1.4 16V	Petrol	74	10/99 → 09/01
1.4 TDI	Diesel	55	10/99 → 09/01
1.6 16V GTI	Petrol	92	10/99 → 09/01
1.9 D	Diesel	47	10/99 → 09/01

POLO (9N_)

1.2	Petrol	40	01/02 → 05/07
1.2 12V	Petrol	47	10/01 → 07/07
1.4 16V	Petrol	55	10/01 → 05/08
1.4 16V	Petrol	74	10/01 → 05/08
1.4 TDI	Diesel	51	04/05 → 11/09
1.4 TDI	Diesel	59	04/05 → 11/09
1.4 TDI	Diesel	55	10/01 → 06/05
1.8 GTI	Petrol	110	09/05 → 11/09
1.9 TDI	Diesel	74	10/01 → 11/09

POLO Tre volumi (9A4)

1.4	Petrol	55	07/03 →
1.4	Petrol	74	11/03 →
1.4 TDI	Diesel	55	07/03 →

ATS23

VOLKSWAGEN
SHARAN (7M8, 7M9, 7M6)

1.8 T 20V	Petrol	110	01/01 → 03/10
1.9 TDI	Diesel	110	06/05 → 03/10
1.9 TDI	Diesel	96	11/02 → 03/10
1.9 TDI	Diesel	66	01/01 → 03/10
1.9 TDI	Diesel	85	01/01 → 03/10
1.9 TDI 4motion	Diesel	85	01/01 → 03/10
2.0	Petrol	85	01/01 → 03/10
2.8 V6 24V	Petrol	150	01/01 → 03/10
2.8 V6 24V 4motion	Petrol	150	01/01 → 03/10

TOUAREG (7LA, 7L6, 7L7)

2.5 R5 TDI	Diesel	128	01/03 → 05/10
3.0 V6 TDI	Diesel	165	11/04 → 05/10
3.2 V6	Petrol	162	10/02 → 11/06
3.2 V6	Petrol	177	11/04 → 11/06
4.2 V8	Petrol	228	12/02 → 11/06
5.0 V10 TDI	Diesel	230	10/02 → 05/10
6.0 W12	Petrol	331	08/04 → 05/10

TOURAN (1T1, 1T2)

1.6	Petrol	75	07/03 → 05/10
1.9 TDI	Diesel	74	02/03 → 05/04
1.9 TDI	Diesel	77	08/03 → 05/10
1.9 TDI	Diesel	66	11/04 → 05/10
2.0 FSI	Petrol	110	10/03 → 11/05
2.0 TDi	Diesel	100	02/03 → 05/10
2.0 TDI 16V	Diesel	103	08/03 → 05/10

TRANSPORTER V Autobus (7HB, 7HJ, 7EB, 7EJ, 7EF)

1.9 TDI	Diesel	63	04/03 → 11/09
1.9 TDI	Diesel	77	04/03 → 11/09
2.0	Petrol	85	11/03 →
2.5 TDI	Diesel	128	04/03 → 11/09
2.5 TDI	Diesel	96	04/03 → 11/09
2.5 TDI 4motion	Diesel	128	07/04 → 11/09
2.5 TDI 4motion	Diesel	96	07/04 → 11/09
3.2 V6	Petrol	170	02/04 → 06/04
3.2 V6	Petrol	173	02/04 → 11/09

TRANSPORTER V Furgonato (7HA, 7HH, 7EA, 7EH)

1.9 TDI	Diesel	63	04/03 → 11/09
1.9 TDI	Diesel	77	04/03 → 11/09
2.0	Petrol	85	11/03 →
2.5 TDI	Diesel	128	04/03 → 11/09
2.5 TDI	Diesel	96	04/03 → 11/09
2.5 TDI 4motion	Diesel	128	07/04 → 11/09
2.5 TDI 4motion	Diesel	96	07/04 → 11/09

ATS23

VOLKSWAGEN
TRANSPORTER V Furgonato (7HA, 7HH, 7EA, 7EH)

3.2 V6	Petrol	170	04/03 → 06/04
3.2 V6	Petrol	173	02/04 → 11/09

TRANSPORTER V Pianale piatto/Telaio (7JD, 7JE, 7JL, 7JY, 7JZ)

1.9 TDI	Diesel	63	04/03 → 11/09
1.9 TDI	Diesel	77	04/03 → 11/09
2.0	Petrol	85	11/03 →
2.5 TDI	Diesel	128	04/03 → 11/09
2.5 TDI	Diesel	96	04/03 → 11/09
2.5 TDI 4motion	Diesel	96	07/04 → 11/09
3.2 V6	Petrol	170	02/04 → 11/09
3.2 V6	Petrol	173	08/03 → 05/06

ATS24
F2 **SENSORE TEMPERATURA ARIA**
AIR TEMPERATURE SENSOR

FORD
COUGAR (EC_)

2.0 16V	Petrol	96	08/98 → 12/01
2.5 ST 200	Petrol	151	01/00 → 12/01
2.5 V6 24V	Petrol	125	06/00 → 12/01
2.5 V6 24V	Petrol	125	08/98 → 12/01

ESCORT CLASSIC (AAL, ABL)

1.6 16V	Petrol	66	10/98 → 07/00
1.8 TD	Diesel	66	10/98 → 07/00

ESCORT CLASSIC Turnier (ANL)

1.6 16V	Petrol	66	02/99 → 07/00
1.8 TD	Diesel	66	02/99 → 07/00

ESCORT V (GAL)

1.3	Petrol	44	07/90 → 09/92
1.4	Petrol	52	07/90 → 09/92
1.6	Petrol	77	07/90 → 12/92
1.8 16V XR3i	Petrol	77	02/92 → 12/92

ATS24



KW



FORD

ESCORT V (GAL)

1.8 16V XR3i	Petrol	96	02/92 → 12/92
1.8 D	Diesel	44	07/90 → 12/92
RS 2000	Petrol	110	05/91 → 12/92

ESCORT V Cabriolet (ALL)

1.4	Petrol	52	07/90 → 12/92
1.6	Petrol	77	07/90 → 12/92
1.8 16V XR3i	Petrol	77	02/92 → 12/92
1.8 16V XR3i	Petrol	96	02/92 → 12/92

ESCORT V Station wagon (GAL, AVL)

1.3	Petrol	44	09/91 → 09/92
1.4	Petrol	52	07/90 → 09/92
1.6	Petrol	77	07/90 → 09/92
1.8 16V	Petrol	77	02/92 → 12/92
1.8 D	Diesel	44	07/90 → 12/92
1.8 TD	Diesel	55	05/91 → 12/92

ESCORT VI (GAL)

1.3	Petrol	44	09/92 → 01/95
1.4	Petrol	55	01/94 → 01/95
1.4	Petrol	52	09/92 → 01/95
1.6 i 16V	Petrol	65	01/94 → 01/95
1.6 i 16V	Petrol	66	09/92 → 01/95
1.8 16V XR3i	Petrol	96	09/92 → 01/95
1.8 D	Diesel	44	09/92 → 01/95
1.8 i 16V	Petrol	77	09/92 → 01/95
1.8 TD	Diesel	66	02/93 → 01/95
1.8 XR3i 16V 4x4	Petrol	77	08/93 → 01/95
1.8 XR3i 16V 4x4	Petrol	96	08/93 → 01/95
RS 2000	Petrol	110	09/92 → 01/95
RS 2000 4x4	Petrol	110	08/93 → 01/95
RS Cosworth 4x4	Petrol	162	09/92 → 01/95

ESCORT VI Cabriolet (ALL)

1.4	Petrol	52	12/92 → 04/94
1.4 i	Petrol	55	07/93 → 01/95
1.6 16V XR3i	Petrol	66	12/92 → 01/95
1.6 i 16V	Petrol	65	02/94 → 01/95
1.8 16V XR3i	Petrol	77	12/92 → 01/95
1.8 16V XR3i	Petrol	96	12/92 → 01/95

ESCORT VI Station wagon (GAL)

1.3	Petrol	44	09/92 → 01/95
1.4	Petrol	55	01/94 → 01/95
1.4	Petrol	52	09/92 → 01/95
1.6 i 16V	Petrol	65	01/94 → 01/95
1.6 i 16V	Petrol	66	09/92 → 01/95
1.8 D	Diesel	44	09/92 → 01/95

ATS24



KW



FORD

ESCORT VI Station wagon (GAL)

1.8 i 16V	Petrol	77	01/93 → 01/95
1.8 i 16V	Petrol	96	02/93 → 01/95
1.8 TD	Diesel	66	02/93 → 01/95

ESCORT VI Tre volumi (GAL)

1.3	Petrol	44	08/93 → 01/95
1.4	Petrol	52	08/93 → 04/94
1.4	Petrol	55	08/93 → 01/95
1.6 i 16V	Petrol	65	01/94 → 01/95
1.6 i 16V	Petrol	66	08/93 → 01/95
1.8 D	Diesel	44	08/93 → 01/95
1.8 i 16V	Petrol	77	08/93 → 01/95
1.8 TD	Diesel	66	08/93 → 01/95

ESCORT VII (GAL, AAL, ABL)

1.3	Petrol	44	01/95 → 10/98
1.4	Petrol	55	01/95 → 10/98
1.6 16V	Petrol	66	01/95 → 10/98
1.6 16V 4x4	Petrol	66	01/95 → 10/98
1.6 i 16V	Petrol	65	01/95 → 08/95
1.8 16V	Petrol	77	01/95 → 08/95
1.8 16V	Petrol	85	01/95 → 10/98
1.8 D	Diesel	44	01/95 → 12/96
1.8 TD	Diesel	66	01/95 → 10/98
1.8 Turbo D	Diesel	51	12/95 → 10/98
RS 2000	Petrol	110	02/95 → 02/98
RS 2000 4x4	Petrol	110	02/95 → 10/98
RS Cosworth 4x4	Petrol	162	02/95 → 10/98

ESCORT VII Cabriolet (ALL)

1.4	Petrol	55	02/95 → 08/98
1.6 16V XR3i	Petrol	65	02/95 → 12/96
1.6 16V XR3i	Petrol	66	02/95 → 09/99
1.8 16V XR3i	Petrol	77	02/95 → 08/98
1.8 16V XR3i	Petrol	85	10/95 → 08/98
1.8 16V XR3i	Petrol	96	02/95 → 08/00
1.8 TD	Diesel	66	09/95 → 08/98

ESCORT VII Station wagon (GAL, ANL)

1.3	Petrol	44	01/95 → 01/99
1.4	Petrol	55	01/95 → 02/99
1.6 16V	Petrol	66	01/95 → 02/99
1.6 i 16V	Petrol	65	01/95 → 08/95
1.8 16V	Petrol	77	01/95 → 08/95
1.8 16V	Petrol	85	01/95 → 02/99
1.8 D	Diesel	44	01/95 → 02/99
1.8 TD	Diesel	66	01/95 → 02/99
1.8 Turbo D	Diesel	51	12/95 → 02/99

ATS24

FORD
ESCORT VII Tre volumi (GAL, AFL)

1.3	Petrol	44	01/95 → 02/99
1.4	Petrol	55	01/95 → 02/99
1.6 i 16V	Petrol	65	01/95 → 08/95
1.6 i 16V	Petrol	66	01/95 → 02/99
1.8 16V	Petrol	77	01/95 → 08/95
1.8 16V	Petrol	85	01/95 → 02/99
1.8 D	Diesel	44	01/95 → 12/96
1.8 TD	Diesel	66	01/95 → 02/99
1.8 Turbo D	Diesel	51	12/95 → 02/99

FIESTA III (GFJ)

1.0	Petrol	33	03/89 → 12/95
1.1	Petrol	37	03/89 → 12/95
1.1	Petrol	40	03/89 → 12/95
1.3	Petrol	44	03/89 → 12/92
1.3	Petrol	44	03/89 → 12/95
1.3 Cat.	Petrol	44	05/91 → 01/97
1.4	Petrol	54	03/89 → 12/95
1.4	Petrol	52	03/89 → 12/95
1.4	Petrol	55	11/92 → 12/96
1.4 Cat.	Petrol	54	03/89 → 12/95
1.6	Petrol	65	01/89 → 01/94
1.6	Petrol	66	03/89 → 12/92
1.6 i 16V	Petrol	65	01/94 → 12/95
1.6 XR2i	Petrol	76	03/89 → 03/93
1.6 XR2i	Petrol	81	03/89 → 01/94
1.8 16V	Petrol	77	02/92 → 12/95
1.8 D	Diesel	44	03/89 → 12/95
1.8 TD	Diesel	55	03/93 → 12/95
1.8 XR2i 16V	Petrol	96	02/92 → 12/95

FIESTA IV (JA_, JB_)

1.0 i	Petrol	38	02/97 → 09/99
1.0 i	Petrol	48	09/99 → 01/02
1.1	Petrol	37	09/95 → 12/96
1.25 i 16V	Petrol	55	08/95 → 01/02
1.3	Petrol	42	04/96 → 08/99
1.3 i	Petrol	37	08/95 → 01/02
1.3 i	Petrol	44	04/96 → 08/99
1.3 i	Petrol	44	08/95 → 01/02
1.6 16V Sport	Petrol	76	02/00 → 01/02
1.8 D	Diesel	44	08/95 → 04/00
1.8 Di	Diesel	55	04/00 → 01/02

ATS24

FORD
FOCUS (DAW, DBW)

1.4 16V	Petrol	55	10/98 → 11/04
1.6 16V	Petrol	74	10/98 → 11/04
1.6 16V Flexifuel	Petrol/ Ethanol	75	01/02 → 11/04
1.8 16V	Petrol	85	10/98 → 11/04
1.8 DI / TDDi	Diesel	55	08/99 → 11/04
1.8 TDCi	Diesel	74	08/02 → 11/04
1.8 TDCi	Diesel	85	03/01 → 11/04
1.8 Turbo DI/TDDi	Diesel	66	10/98 → 11/04
2.0 16V	Petrol	96	10/98 → 11/04
RS	Petrol	158	10/02 → 11/04
ST170	Petrol	127	03/02 → 11/04

FOCUS Station wagon (DNW)

1.4 16V	Petrol	55	02/99 → 11/04
1.6 16V	Petrol	74	02/99 → 11/04
1.6 16V Flexifuel	Petrol/ Ethanol	75	01/02 → 11/04
1.8 16V	Petrol	85	02/99 → 11/04
1.8 BiFuel	Petrol/ LPG	82	02/03 → 01/05
1.8 DI / TDDi	Diesel	55	08/99 → 11/04
1.8 TDCi	Diesel	74	08/02 → 11/04
1.8 TDCi	Diesel	85	03/01 → 11/04
1.8 Turbo DI/TDDi	Diesel	66	02/99 → 11/04
2.0 16V	Petrol	96	02/99 → 11/04
ST170	Petrol	127	08/02 → 11/04

FOCUS Tre volumi (DFW)

1.4 16V	Petrol	55	02/99 → 11/04
1.6 16V	Petrol	74	02/99 → 11/04
1.8 16V	Petrol	85	02/99 → 11/04
1.8 TDCi	Diesel	74	08/02 → 11/04
1.8 TDCi	Diesel	85	03/01 → 11/04
1.8 Turbo DI/TDDi	Diesel	66	02/99 → 11/04
1.8 Turbo DI/TDDi	Diesel	55	08/01 → 03/05
2.0 16V	Petrol	96	02/99 → 11/04

FUSION (JU_)

1.25	Petrol	55	08/04 →
1.4	Petrol	59	08/02 →
1.6	Petrol	74	08/02 →

GALAXY (WGR)

1.9 TDI	Diesel	110	05/05 → 05/06
1.9 TDI	Diesel	96	02/03 → 05/06
1.9 TDI	Diesel	85	04/00 → 05/06
2.0 i	Petrol	85	11/95 → 05/06

ATS24



kW



FORD

GALAXY (WGR)

2.3 16V	Petrol	103	09/01 → 05/06
2.3 4x4	Petrol	107	09/96 → 04/00
2.8 V6	Petrol	150	04/00 → 05/06

KA (RB_)

1.0 i	Petrol	38	07/97 → 09/99
1.0 i	Petrol	48	09/99 → 11/08
1.3 i	Petrol	51	08/02 → 11/08
1.3 i	Petrol	36	06/98 → 11/08
1.6	Petrol	68	10/06 → 12/07
1.6 i	Petrol	70	07/03 → 11/08

KA Van (RB)

1.3 i	Petrol	44	05/02 → 05/05
-------	--------	----	---------------

MONDEO I (GBP)

1.6 i 16V	Petrol	65	07/94 → 08/96
1.6 i 16V	Petrol	66	02/93 → 08/96
1.8 i 16V	Petrol	82	07/94 → 08/96
1.8 i 16V	Petrol	85	02/93 → 08/96
1.8 i 16V 4x4	Petrol	85	02/93 → 08/96
1.8 TD	Diesel	65	06/93 → 08/96
1.8 TD	Diesel	66	10/95 → 08/96
2.0 i 16V	Petrol	100	02/93 → 08/96
2.0 i 16V	Petrol	97	12/94 → 08/96
2.0 i 16V 4x4	Petrol	97	12/94 → 08/96
2.5 i 24V	Petrol	125	07/94 → 08/96

MONDEO I Station wagon (BNP)

1.6 i 16V	Petrol	65	07/94 → 08/96
1.6 i 16V	Petrol	66	04/93 → 08/96
1.8 i 16V	Petrol	82	07/94 → 08/96
1.8 i 16V	Petrol	85	04/93 → 08/96
1.8 i 16V 4x4	Petrol	85	04/93 → 08/96
1.8 TD	Diesel	65	06/93 → 08/96
1.8 TD	Diesel	66	11/95 → 08/96
2.0 i 16V	Petrol	100	04/93 → 08/96
2.0 i 16V	Petrol	97	01/93 → 08/96
2.0 i 16V 4x4	Petrol	100	04/93 → 08/96
2.0 i 16V 4x4	Petrol	97	12/94 → 08/96
2.5 i 24V	Petrol	125	07/94 → 08/96

MONDEO I Tre volumi (GBP)

1.6 i 16V	Petrol	65	07/94 → 08/96
1.6 i 16V	Petrol	66	02/93 → 08/96
1.8 4x4	Petrol	85	02/93 → 08/96
1.8 i 16V	Petrol	82	01/94 → 08/96
1.8 i 16V	Petrol	85	02/93 → 08/96
1.8 TD	Diesel	65	06/93 → 08/96

ATS24



kW



FORD

MONDEO I Tre volumi (GBP)

1.8 TD	Diesel	66	10/95 → 08/96
2.0 i 16V	Petrol	100	02/93 → 08/96
2.0 i 16V 4x4	Petrol	97	12/94 → 08/96
2.5 i 24V	Petrol	125	07/94 → 08/96

MONDEO II (BAP)

1.6 i 16V	Petrol	70	05/98 → 11/00
2.5 24V	Petrol	125	06/00 → 11/00
2.5 ST 200	Petrol	151	05/99 → 11/00

MONDEO II Station wagon (BNP)

1.6 i 16V	Petrol	70	05/98 → 11/00
2.5 24V	Petrol	125	10/99 → 11/00
2.5 ST 200	Petrol	151	05/99 → 11/00

MONDEO II Tre volumi (BFP)

1.6 i 16V	Petrol	70	05/98 → 11/00
2.5 24V	Petrol	125	06/00 → 11/00
2.5 ST 200	Petrol	151	05/99 → 11/00

MONDEO III (B5Y)

1.8 16V	Petrol	81	11/00 → 08/07
1.8 16V	Petrol	92	11/00 → 08/07
1.8 SCi	Petrol	96	06/03 → 08/07
2.0 16V	Petrol	107	11/00 → 08/07
2.0 16V DI / TDDi / TDCi	Diesel	66	11/00 → 08/07
2.0 16V TDDi / TDCi	Diesel	85	11/00 → 08/07
2.0 TDCi	Diesel	92	02/03 → 06/05
2.0 TDCi	Diesel	96	10/01 → 08/07
2.2 TDCi	Diesel	110	09/04 → 08/07
2.2 TDCi	Diesel	114	09/04 → 08/07
2.5 V6 24V	Petrol	125	11/00 → 08/07
3.0 V6 24V	Petrol	150	09/04 → 08/07
ST220	Petrol	166	04/02 → 08/07

MONDEO III Station wagon (BWY)

1.8 16V	Petrol	81	11/00 → 08/07
1.8 16V	Petrol	92	11/00 → 08/07
1.8 SCi	Petrol	96	06/03 → 08/07
2.0 16V	Petrol	107	11/00 → 08/07
2.0 16V DI / TDDi / TDCi	Diesel	66	11/00 → 08/07
2.0 16V TDDi / TDCi	Diesel	85	11/00 → 08/07
2.0 TDCi	Diesel	96	10/01 → 08/07
2.2 TDCi	Diesel	110	09/04 → 08/07
2.2 TDCi	Diesel	114	09/04 → 08/07

ATS24

FORD
MONDEO III Station wagon (BWY)

2.5 V6 24V	Petrol	125	11/00 → 08/07
3.0 V6 24V	Petrol	150	09/04 → 08/07
ST220	Petrol	166	04/02 → 08/07

MONDEO III Tre volumi (B4Y)

1.8 16V	Petrol	81	11/00 → 08/07
1.8 16V	Petrol	92	11/00 → 08/07
1.8 SCi	Petrol	96	06/03 → 08/07
2.0 16V	Petrol	107	11/00 → 08/07
2.0 16V DI / TDDi / TDCi	Diesel	66	11/00 → 08/07
2.0 16V TDDi / TDCi	Diesel	85	11/00 → 08/07
2.0 TDCi	Diesel	92	02/03 → 06/05
2.0 TDCi	Diesel	96	10/01 → 08/07
2.2 TDCi	Diesel	110	09/04 → 08/07
2.2 TDCi	Diesel	114	09/04 → 08/07
2.5 V6 24V	Petrol	125	11/00 → 08/07
3.0 V6 24V	Petrol	150	09/04 → 08/07
ST220	Petrol	166	04/02 → 08/07

ORION III (GAL)

1.3	Petrol	44	07/90 → 12/93
1.3	Petrol	44	09/90 → 08/92
1.4	Petrol	52	07/90 → 12/93
1.4	Petrol	54	07/90 → 12/93
1.6	Petrol	66	07/90 → 12/92
1.6 i	Petrol	77	07/90 → 09/92
1.6 i 16V	Petrol	66	07/92 → 12/93
1.8 D	Diesel	44	11/90 → 12/93
1.8 i 16V	Petrol	77	02/92 → 12/93
1.8 TD	Diesel	66	03/92 → 12/93

SCORPIO I (GAE, GGE)

1.8	Petrol	66	04/85 → 02/92
2.0	Petrol	77	04/85 → 08/89
2.0	Petrol	80	11/88 → 10/92
2.0 i	Petrol	74	10/85 → 12/90
2.0 i	Petrol	85	02/92 → 09/94
2.0 i	Petrol	85	04/85 → 02/92
2.0 i	Petrol	88	05/89 → 09/94
2.4 i	Petrol	92	10/88 → 02/92
2.4 i	Petrol	96	09/86 → 09/88
2.4 i Cat.	Petrol	92	10/88 → 09/94
2.5 D	Diesel	51	12/85 → 02/92
2.5 TD	Diesel	68	06/88 → 07/93
2.5 TD	Diesel	85	08/93 → 09/94

ATS24

FORD
SCORPIO I (GAE, GGE)

2.8 i	Petrol	110	04/85 → 11/86
2.8 i 4x4	Petrol	110	10/85 → 11/86
2.9 i	Petrol	107	09/86 → 09/94
2.9 i	Petrol	110	09/86 → 09/94
2.9 i 24V	Petrol	143	04/91 → 09/94
2.9 i 4x4	Petrol	107	05/88 → 02/93
2.9 i 4x4	Petrol	110	09/86 → 09/94
2.9 i Cat.	Petrol	107	10/87 → 09/94

SCORPIO I Station wagon (GGE)

2.0 i	Petrol	85	09/91 → 09/94
2.0 i	Petrol	88	09/91 → 09/94
2.4 i	Petrol	92	09/91 → 09/94
2.5 D	Diesel	51	10/90 → 08/92
2.5 TD	Diesel	68	09/91 → 07/93
2.5 TD	Diesel	85	08/93 → 09/94
2.9 24V	Petrol	143	08/93 → 09/94
2.9 i	Petrol	107	09/91 → 09/94
2.9 i 4x4	Petrol	107	05/88 → 02/93

SCORPIO I Tre volumi (GGE)

1.8	Petrol	66	01/86 → 10/88
1.9	Petrol	85	11/92 → 09/93
2.0	Petrol	77	03/90 → 08/92
2.0	Petrol	80	06/89 → 03/93
2.0 i	Petrol	85	02/92 → 09/94
2.0 i	Petrol	88	05/89 → 09/94
2.0 i	Petrol	92	05/89 → 02/92
2.4 i	Petrol	92	10/88 → 10/94
2.5 D	Diesel	51	12/89 → 12/94
2.5 TD	Diesel	68	06/88 → 07/93
2.5 TD	Diesel	85	08/93 → 09/94
2.9	Petrol	107	09/92 → 09/94
2.9 i 24V	Petrol	143	04/91 → 09/94
2.9 i 4x4	Petrol	107	12/89 → 10/94

SCORPIO II (GFR, GGR)

2.0 i	Petrol	85	10/94 → 08/98
2.0 i 16V	Petrol	100	10/94 → 08/98
2.5 TD	Diesel	85	10/94 → 08/98
2.9 i	Petrol	110	02/95 → 08/98
2.9 i 24V	Petrol	152	10/94 → 08/98

SCORPIO II Station wagon (GMR, GGR)

2.0 i	Petrol	85	10/94 → 08/98
2.0 i 16V	Petrol	100	10/94 → 08/98
2.5 TD	Diesel	85	10/94 → 08/98
2.9 i	Petrol	110	02/95 → 08/98

ATS24



FORD

SCORPIO II Station wagon (GNR, GGR)

2.9 i 24V Petrol 152 10/94 → 08/98

STREET KA (RL2)

1.6 Petrol 70 05/03 → 07/05

IATS04

F2 **SENSORE TEMPERATURA ARIA**
AIR TEMPERATURE SENSOR



CITROËN

C5 I (DC_)

2.0 16V (DCRFNC, DCRFNF) Petrol 100 03/01 → 08/04

C5 I Break (DE_)

2.0 16V (DERFNF, DERFNC, RERFNC) Petrol 100 06/01 → 08/04

XSARA (N1)

1.4 i Petrol 55 04/97 → 03/05

2.0 16V Petrol 120 04/97 → 09/00

XSARA Break (N2)

1.4 i Petrol 55 10/97 → 08/05

XSARA Coupé (N0)

1.4 i Petrol 55 03/98 → 03/05

2.0 i 16V Petrol 120 02/98 → 03/05

ZX (N2)

1.4 i Petrol 55 01/93 → 06/97

ZX Break (N2)

1.4 i Petrol 55 10/93 → 10/97

PEUGEOT

306 (7B, N3, N5)

1.4 SL Petrol 55 01/96 → 05/01

IATS04



PEUGEOT

306 2 volumi /Coda spiovente (7A, 7C, N3, N5)

1.4 Petrol 55 01/96 → 05/01

306 Break (7E, N3, N5)

1.4 Petrol 55 03/97 → 04/02

RANCH MPV / Space wagon (5F)

1.4 Petrol 55 06/96 →

IATS04/01

F2 **SENSORE TEMPERATURA ARIA**
AIR TEMPERATURE SENSOR



CITROËN

XSARA (N1)

2.0 16V Petrol 100 09/00 → 03/05

XSARA Break (N2)

2.0 16V Petrol 100 09/00 → 08/05

XSARA Coupé (N0)

2.0 16V Petrol 100 09/00 → 03/05

XSARA PICASSO (N68)

2.0 16V Petrol 100 01/03 →

PEUGEOT

206 2 volumi /Coda spiovente (2A/C)

2.0 S16 Petrol 100 06/99 →

206 CC (2D)

2.0 S16 Petrol 100 09/00 →

206 SW (2E/K)

2.0 16V Petrol 100 07/02 →

307 (3A/C)

2.0 16V Petrol 100 08/00 →

307 Break (3E)

2.0 Petrol 100 03/02 →

307 CC (3B)

2.0 16V Petrol 100 10/03 →

307 SW (3H)

2.0 16V Petrol 100 03/02 →

IATS04/01

PEUGEOT
406 (8B)

2.0 16V Petrol 100 08/00 → 05/04

406 Break (8E/F)

2.0 16V Petrol 100 10/00 → 10/04

406 Coupé (8C)

2.0 16V Petrol 100 10/00 → 12/04

607 (9D, 9U)

2.0 Petrol 100 02/00 →

KITATS05
F2 **SENSORE TEMPERATURA ARIA**
AIR TEMPERATURE SENSOR

CITROËN
ZX (N2)

1.4 i Petrol 55 03/91 → 06/97

ZX Break (N2)

1.4 i Petrol 55 10/93 → 10/97

FIAT
CINQUECENTO (170)

0.9 i.e. (170AC) Petrol 30 07/91 → 12/93

0.9 i.e. S (170AF, 170CF) Petrol 29 07/91 → 01/98

1.1 Sporting (170AH) Petrol 40 10/94 → 01/98

PALIO (178BX)

1.2 Petrol 54 06/98 →

PALIO Weekend (178DX)

1.2 (178DX.G1A) Petrol 54 04/96 → 02/01

1.2 (178DYA1A) Petrol 44 02/01 →

PANDA (141A_)

900 Petrol 29 04/92 → 12/96

900 Petrol 33 10/80 → 06/94

1000 i.e. Cat. Petrol 33 10/87 → 08/98

KITATS05

FIAT
PUNTO (176)

55 1.1 Petrol 40 09/93 → 09/99

60 1.2 Petrol 43 01/94 → 09/99

60 1.2 Petrol 44 03/94 → 09/99

75 1.2 Petrol 54 12/93 → 09/99

PUNTO Cabriolet (176C)

60 1.2 Petrol 43 04/94 → 06/00

60 1.2 Petrol 44 05/95 → 06/00

PUNTO Van (176L)

1.1 Petrol 40 04/96 → 02/00

SEICENTO (187)

0.9 (187AXA, 187AXA1A) Petrol 29 01/98 → 01/10

1.1 (187AXB, 187AXB1A) Petrol 40 01/98 → 01/10

SEICENTO Van (187)

0.9 (187AXA) Petrol 29 01/98 → 01/10

1.1 (187CXB/C) Petrol 40 01/98 → 01/10

SIENA (178_)

1.2 Petrol 54 09/98 →

STRADA Pick-up (178E)

1.2 Petrol 44 04/03 →

1.2 Petrol 54 06/99 →

UNO (146A/E)

55 1.0 Petrol 41 03/94 → 08/00

LANCIA
DEDRA (835)

1.6 i.e. (835AN) Petrol 55 04/93 → 07/99

Y (840A)

1.1 (840AE) Petrol 40 11/95 → 09/03

1.2 (840AA, 840AF1A) Petrol 44 03/96 → 09/03

PEUGEOT
106 I (1A, 1C)

1.1 Petrol 44 09/91 → 04/96

205 II (20A/C)

1.1 Petrol 44 07/89 → 09/98

1.1 Petrol 36 10/87 → 10/90

306 (7B, N3, N5)

1.1 Petrol 44 06/94 → 05/01

1.4 SL Petrol 55 06/94 → 05/01

306 2 volumi /Coda spiovente (7A, 7C, N3, N5)

1.1 Petrol 44 05/93 → 05/01

1.4 Petrol 55 05/93 → 05/01

KITATS05



RENAULT

CLIO I (B/C57_, 5/357_)

1.2 (B/C57R) Petrol 40 01/91 → 06/96

CLIO I Furgonato (S57_)

1.2 Petrol 40 01/91 → 09/98

1.2 Petrol 44 01/91 → 09/98

TWINGO I (C06_)

1.2 (C063, C064) Petrol 40 03/93 → 10/96

SGA113

F3 **SENSORE TEMPERATURA OLIO**
OIL TEMPERATURE SENSOR



BMW

3 (E46)

316 i Petrol 77 04/00 → 02/05

316 i Petrol 77 09/98 → 02/05

316 i Petrol 85 02/02 → 02/05

318 d Diesel 85 09/01 → 03/03

318 i Petrol 105 09/01 → 02/05

318 i Petrol 87 02/98 → 09/01

320 d Diesel 100 04/98 → 09/01

320 d Diesel 110 09/01 → 02/05

320 i Petrol 110 03/98 → 09/00

320 i Petrol 125 09/00 → 02/05

323 i Petrol 125 03/98 → 09/00

325 i Petrol 141 09/00 → 02/05

325.xi Petrol 141 09/00 → 02/05

328 i Petrol 142 02/98 → 06/00

330 d Diesel 135 10/99 → 02/05

330 d Diesel 150 03/03 → 02/05

330 i Petrol 170 06/00 → 02/05

330 xd Diesel 135 06/00 → 02/05

330 xd Diesel 150 03/03 → 02/05

330 xi Petrol 170 06/00 → 02/05

SGA113



BMW

3 Cabriolet (E46)

318 Ci Petrol 105 09/01 →

320 Ci Petrol 125 09/00 →

323 Ci Petrol 125 04/00 → 09/00

325 Ci Petrol 141 09/00 →

330 Ci Petrol 170 06/00 →

M3 3.2 Petrol 252 04/01 →

3 Compact (E36)

316 i Petrol 77 12/98 → 08/00

3 Compact (E46)

316 ti Petrol 85 06/01 → 02/05

318 td Diesel 85 03/03 → 02/05

318 ti Petrol 105 09/01 → 02/05

320 td Diesel 110 09/01 → 02/05

325 ti Petrol 141 06/01 → 02/05

3 Coupé (E46)

316 Ci Petrol 77 04/00 →

318 Ci Petrol 105 09/01 →

318 Ci Petrol 87 11/99 → 09/01

320 Cd Diesel 110 11/03 →

320 Ci Petrol 110 08/99 → 09/00

320 Ci Petrol 125 09/00 →

323 Ci Petrol 125 04/99 → 09/00

325 Ci Petrol 141 09/00 →

328 Ci Petrol 142 04/99 → 06/00

330 Cd Diesel 150 03/03 →

330 xi Petrol 170 06/00 →

M3 3.2 Petrol 252 06/00 →

M3 CSL Petrol 265 06/03 →

3 Touring (E46)

316 i Petrol 85 03/02 → 02/05

318 d Diesel 85 03/02 → 02/05

318 d Diesel 85 03/03 → 02/05

318 i Petrol 105 09/01 → 02/05

318 i Petrol 87 10/99 → 09/01

320 d Diesel 100 03/00 → 09/01

320 d Diesel 110 09/01 → 02/05

320 i Petrol 110 10/99 → 09/00

320 i Petrol 125 09/00 → 02/05

325 i Petrol 141 09/00 → 02/05

325.xi Petrol 141 09/00 → 02/05

328 i Petrol 142 10/99 → 06/00

330 d Diesel 135 10/99 → 02/05

330 d Diesel 150 03/03 → 02/05

330 i Petrol 170 06/00 → 02/05

SGA113

BMW
3 Touring (E46)

330 xd	Diesel	135	06/00 → 02/05
330 xd	Diesel	150	03/03 → 02/05
330 xi	Petrol	170	06/00 → 02/05

5 (E39)

520 d	Diesel	100	02/00 → 06/03
520 i	Petrol	110	10/98 → 09/00
520 i	Petrol	125	09/00 → 06/03

5 (E60)

520 i	Petrol	125	07/03 → 03/10
525 d	Diesel	130	06/04 → 03/10
525 i	Petrol	141	09/03 → 03/10
530 d	Diesel	160	07/03 → 03/10
530 d	Diesel	170	07/03 → 03/10
530 i	Petrol	170	07/03 → 03/10
530 xd	Diesel	170	07/05 → 03/10
535 d	Diesel	200	09/04 → 03/10
545 i	Petrol	245	09/03 → 03/10

5 Touring (E39)

520 d	Diesel	100	02/00 → 09/03
520 i	Petrol	125	09/00 → 05/04

5 Touring (E61)

525 d	Diesel	130	06/04 →
530 d	Diesel	160	06/04 →
530 d	Diesel	170	07/05 →
530 xd	Diesel	170	07/05 →
535 d	Diesel	200	09/04 →

7 (E38)

728 i,iL	Petrol	142	08/95 → 11/01
----------	--------	-----	---------------

7 (E65, E66, E67)

730 d	Diesel	160	10/02 →
730 i,Li	Petrol	170	03/03 →
730 Ld	Diesel	170	07/05 →
735 i,Li	Petrol	200	11/01 →
745 i,Li	Petrol	245	11/01 →
760 i,Li	Petrol	327	01/03 →

X3 (E83)

2.0 D	Diesel	110	10/04 →
3.0 d	Diesel	150	01/04 →
3.0 d	Diesel	160	01/04 →
3.0 i xDrive	Petrol	170	01/04 →

X5 (E53)

3.0 i	Petrol	163	05/00 →
3.0 i	Petrol	170	05/00 →
4.4 i	Petrol	235	12/03 →

SGA113

BMW
Z3 (E36)

1.9	Petrol	87	07/98 → 01/03
2.0	Petrol	110	04/99 → 01/03
2.2	Petrol	125	08/00 → 01/03
3.0	Petrol	170	06/00 → 01/03
M 3.2	Petrol	239	06/01 → 01/03

Z3 Coupé (E36)

2.8	Petrol	141	09/98 → 06/00
3.0	Petrol	170	06/00 → 06/03
M	Petrol	239	06/01 → 06/03

Z4 (E85)

2.2 i	Petrol	125	10/03 →
2.5 i	Petrol	141	02/03 →
3.0 i	Petrol	170	02/03 →

LAND ROVER
FREELANDER (LN)

1.8 16V 4x4	Petrol	86	11/00 → 10/06	CHASSIS: 1A000001 →
1.8 i 16V 4x4	Petrol	88	02/98 → 11/00	CHASSIS: 1A000001 →

FREELANDER Soft Top

1.8 i 16V 4x4	Petrol	88	02/98 → 10/06	CHASSIS: 1A000001 →
---------------	--------	----	---------------	------------------------

MG
MG TF

115	Petrol	85	03/02 →	
120	Petrol	88	03/02 →	CHASSIS: YD522573 →
135	Petrol	100	03/02 →	CHASSIS: YD522573 →
160	Petrol	118	03/02 →	CHASSIS: YD522573 →

MG ZR

120	Petrol	86	06/01 → 04/05	CHASSIS: YD471565 →
160	Petrol	118	06/01 → 04/05	CHASSIS: YD471565 →

MG ZS

120	Petrol	86	07/01 → 04/05
-----	--------	----	---------------

MG ZS Hatchback

120	Petrol	86	07/01 → 10/05
-----	--------	----	---------------

SGA113



KW



MG

MG ZT

160	Petrol	118	06/01 → 07/05
190	Petrol	140	06/01 → 07/05
1.8 16V	Petrol	88	01/03 → 07/05
1.8 T 16V	Petrol	118	01/03 → 07/05
2.0 CDTi	Diesel	96	11/02 → 07/05
2.0 CDTi	Diesel	85	06/02 → 09/03

MG ZT- T

160	Petrol	118	10/01 → 07/05
190	Petrol	140	10/01 → 07/05
1.8 16V	Petrol	88	01/03 → 07/05
1.8 T 16V	Petrol	118	01/03 → 07/05
2.0 CDTi	Diesel	85	06/02 → 09/03
2.0 CDTi	Diesel	96	11/02 → 07/05

MGF (RD)

1.8 i 16V	Petrol	88	03/95 → 03/02	CHASSIS: YD522573 →
1.8 i VVC	Petrol	107	03/95 → 03/02	CHASSIS: YD522573 →

ROVER

200 (RF)

211	Petrol	44	01/98 → 03/00	CHASSIS: YD471565 →
214 i	Petrol	55	11/95 → 03/00	CHASSIS: YD471565 →
214 Si	Petrol	76	11/95 → 03/00	CHASSIS: YD471565 →
216 Si	Petrol	82	11/95 → 03/00	CHASSIS: YD471565 →
218 K Vi	Petrol	107	11/95 → 03/00	CHASSIS: YD471565 →

25 (RF)

1.4 16V	Petrol	62	10/99 → 05/05	CHASSIS: YD471565 →
1.4 16V	Petrol	76	10/99 → 05/05	CHASSIS: YD471565 →
1.6 16V	Petrol	80	10/99 → 05/05	CHASSIS: YD471565 →
1.8 16V	Petrol	107	02/00 → 05/05	CHASSIS: YD471565 →
1.8 16V	Petrol	85	10/99 → 05/05	CHASSIS: YD471565 →

400 2 volumi /Coda spiovente (RT)

414 Si	Petrol	76	05/95 → 03/00	CHASSIS: YD471064 →
--------	--------	----	---------------	------------------------

SGA113



KW



ROVER

400 2 volumi /Coda spiovente (RT)

416 Si	Petrol	82	05/95 → 03/00
--------	--------	----	---------------

45 (RT)

1.4	Petrol	76	02/00 → 05/05
1.6	Petrol	80	02/00 → 05/05
1.8	Petrol	86	02/00 → 05/05

45 Tre volumi (RT)

1.4	Petrol	76	02/00 → 05/05
1.6	Petrol	80	02/00 → 05/05
1.8	Petrol	86	02/00 → 05/05

75 (RJ)

1.8	Petrol	88	02/99 → 05/05
1.8 Turbo	Petrol	110	05/03 → 05/05
2.0 CDT	Diesel	85	02/99 → 05/05
2.0 CDTi	Diesel	96	02/03 → 05/05
2.0 V6	Petrol	110	02/99 → 05/05
2.5 V6	Petrol	129	02/99 → 10/01
2.5 V6	Petrol	130	10/01 → 05/05

75 Tourer (RJ)

1.8	Petrol	88	08/01 → 05/05
1.8 Turbo	Petrol	110	05/03 → 05/05
2.0 CDT	Diesel	85	08/01 → 05/05
2.0 CDTi	Diesel	96	02/03 → 05/05
2.0 V6	Petrol	110	08/01 → 05/05
2.5 V6	Petrol	130	08/01 → 05/05

SGA114

F3

SENSORE TEMPERATURA OLIO
OIL TEMPERATURE SENSOR

KW



JAGUAR

XJ (X300)

6 3.2	Petrol	155	11/94 → 07/97
6 Sovereign 4.0	Petrol	177	11/94 → 07/97

SGA114

MG
MGF (RD)

1.6	Petrol	82	02/00 → 03/02
-----	--------	----	---------------

ROVER
400 Tourer (XW)

1.6 i	Petrol	82	05/94 → 11/98
-------	--------	----	---------------

MINI

1300	Petrol	46	01/92 → 11/00	CHASSIS: BD134455 →
------	--------	----	---------------	------------------------

MINI Cabriolet (XN)

1300	Petrol	46	09/92 → 04/95	CHASSIS: BD134455 →
------	--------	----	---------------	------------------------

SGA115
F3 **SENSORE TEMPERATURA OLIO**
OIL TEMPERATURE SENSOR

AUDI
A4 (8D2, B5)

2.5 TDI	Diesel	110	09/97 → 11/00
---------	--------	-----	---------------

2.5 TDI quattro	Diesel	110	09/97 → 11/00
-----------------	--------	-----	---------------

A4 (8E2, B6)

2.5 TDI	Diesel	114	08/01 → 07/02
---------	--------	-----	---------------

2.5 TDI	Diesel	120	07/02 → 12/04
---------	--------	-----	---------------

2.5 TDI quattro	Diesel	132	11/00 → 12/04
-----------------	--------	-----	---------------

A4 Avant (8D5, B5)

2.5 TDI	Diesel	110	09/97 → 09/01
---------	--------	-----	---------------

2.5 TDI quattro	Diesel	110	09/97 → 09/01
-----------------	--------	-----	---------------

A4 Avant (8E5, B6)

2.5 TDI	Diesel	114	09/01 → 07/02
---------	--------	-----	---------------

2.5 TDI	Diesel	120	07/02 → 12/04
---------	--------	-----	---------------

2.5 TDI quattro	Diesel	132	09/01 → 12/04
-----------------	--------	-----	---------------

A4 Cabriolet (8H7, B6, 8HE, B7)

2.5 TDI	Diesel	120	08/02 → 12/05
---------	--------	-----	---------------

SGA115

AUDI
A6 (4B2, C5)

2.5 TDI	Diesel	114	08/01 → 01/05
---------	--------	-----	---------------

2.5 TDI	Diesel	120	07/02 → 01/05
---------	--------	-----	---------------

2.5 TDI	Diesel	132	02/00 → 01/05
---------	--------	-----	---------------

2.5 TDI	Diesel	110	07/97 → 01/05
---------	--------	-----	---------------

2.5 TDI quattro	Diesel	132	02/00 → 01/05
-----------------	--------	-----	---------------

2.5 TDI quattro	Diesel	110	07/97 → 01/05
-----------------	--------	-----	---------------

A6 Avant (4B5, C5)

2.5 TDI	Diesel	114	08/01 → 01/05
---------	--------	-----	---------------

2.5 TDI	Diesel	120	07/02 → 01/05
---------	--------	-----	---------------

2.5 TDI	Diesel	132	02/00 → 01/05
---------	--------	-----	---------------

2.5 TDI	Diesel	110	12/97 → 01/05
---------	--------	-----	---------------

2.5 TDI quattro	Diesel	132	02/00 → 01/05
-----------------	--------	-----	---------------

2.5 TDI quattro	Diesel	110	12/97 → 01/05
-----------------	--------	-----	---------------

A8 (4D2, 4D8)

2.5 TDI quattro	Diesel	110	07/97 → 04/00
-----------------	--------	-----	---------------

ALLROAD (4BH, C5)

2.5 TDI quattro	Diesel	120	05/03 → 08/05
-----------------	--------	-----	---------------

2.5 TDI quattro	Diesel	132	05/00 → 08/05
-----------------	--------	-----	---------------

SKODA
SUPERB (3U4)

2.5 TDI	Diesel	114	12/01 → 08/03
---------	--------	-----	---------------

VOLKSWAGEN
PASSAT (3B2)

2.5 TDI	Diesel	110	07/98 → 11/00
---------	--------	-----	---------------

2.5 TDI Syncro/4motion	Diesel	110	12/98 → 11/00
------------------------	--------	-----	---------------

PASSAT (3B3)

2.5 TDI	Diesel	110	11/00 → 05/05
---------	--------	-----	---------------

2.5 TDI 4motion	Diesel	110	11/00 → 05/05
-----------------	--------	-----	---------------

PASSAT Variant (3B5)

2.5 TDI	Diesel	110	07/98 → 11/00
---------	--------	-----	---------------

2.5 TDI Syncro/4motion	Diesel	110	12/98 → 11/00
------------------------	--------	-----	---------------

PASSAT Variant (3B6)

2.5 TDI	Diesel	110	11/00 → 05/05
---------	--------	-----	---------------

2.5 TDI 4motion	Diesel	110	11/00 → 05/05
-----------------	--------	-----	---------------

SGA116

F3 **SENSORE TEMPERATURA OLIO**
OIL TEMPERATURE SENSOR



NISSAN

200 SX (S14)

2.0 i 16V Turbo	Petrol	147	08/96 → 12/99
-----------------	--------	-----	---------------

350 Z (Z33)

3.5	Petrol	206	01/05 →
-----	--------	-----	---------

3.5	Petrol	221	09/02 →
-----	--------	-----	---------

350 Z Roadster (Z33)

3.5	Petrol	206	03/05 →
-----	--------	-----	---------

3.5	Petrol	221	04/06 →
-----	--------	-----	---------

ALMERA I (N15)

1.4	Petrol	64	09/95 → 07/00
-----	--------	----	---------------

1.4 GX,LX	Petrol	55	09/95 → 07/00
-----------	--------	----	---------------

1.6	Petrol	73	09/95 → 07/00
-----	--------	----	---------------

1.6 SLX	Petrol	66	09/95 → 07/00
---------	--------	----	---------------

2.0 D	Diesel	55	11/95 → 07/00
-------	--------	----	---------------

ALMERA I Hatchback (N15)

1.4	Petrol	64	09/95 → 03/00
-----	--------	----	---------------

1.4 S,GX,LX	Petrol	55	09/95 → 03/00
-------------	--------	----	---------------

1.6	Petrol	73	09/95 → 03/00
-----	--------	----	---------------

1.6 SR,SLX	Petrol	66	09/95 → 03/00
------------	--------	----	---------------

2.0 D	Diesel	55	11/95 → 03/00
-------	--------	----	---------------

ALMERA II (N16)

1.5	Petrol	66	07/00 →
-----	--------	----	---------

1.5	Petrol	72	10/02 →
-----	--------	----	---------

1.8	Petrol	84	03/01 → 07/02
-----	--------	----	---------------

1.8	Petrol	85	10/02 →
-----	--------	----	---------

2.2 dCi	Diesel	100	09/03 →
---------	--------	-----	---------

2.2 dCi	Diesel	82	09/03 →
---------	--------	----	---------

2.2 Di	Diesel	81	07/00 → 02/03
--------	--------	----	---------------

ALMERA II Hatchback (N16)

1.5	Petrol	66	03/00 → 07/02
-----	--------	----	---------------

1.5	Petrol	72	10/02 →
-----	--------	----	---------

1.8	Petrol	84	01/00 → 07/02
-----	--------	----	---------------

1.8	Petrol	85	10/02 →
-----	--------	----	---------

2.2 dCi	Diesel	100	09/03 →
---------	--------	-----	---------

SGA116



NISSAN

ALMERA II Hatchback (N16)

2.2 dCi	Diesel	82	09/03 →
---------	--------	----	---------

2.2 Di	Diesel	81	03/00 → 02/03
--------	--------	----	---------------

ALMERA TINO (V10)

1.8	Petrol	84	08/00 →
-----	--------	----	---------

1.8	Petrol	85	12/02 →
-----	--------	----	---------

2.0	Petrol	100	08/00 → 01/03
-----	--------	-----	---------------

2.2 dCi	Diesel	100	09/03 →
---------	--------	-----	---------

2.2 dCi	Diesel	82	09/03 →
---------	--------	----	---------

2.2 Di	Diesel	84	08/00 →
--------	--------	----	---------

INTERSTAR Autobus (X70)

dCi 140	Diesel	100	11/03 →
---------	--------	-----	---------

INTERSTAR Furgonato (X70)

dCi 140	Diesel	100	11/03 →
---------	--------	-----	---------

INTERSTAR Pianale piatto/Telaio

dCi 140	Diesel	100	11/03 →
---------	--------	-----	---------

MAXIMA QX (A32)

2.0	Petrol	103	02/95 → 08/00
-----	--------	-----	---------------

MAXIMA QX (A33)

2.0 V6 24V	Petrol	103	03/00 → 11/03
------------	--------	-----	---------------

3.0 V6 24V	Petrol	147	03/00 → 11/03
------------	--------	-----	---------------

MAXIMA Station Wagon

2.0 QX	Petrol	103	10/97 →
--------	--------	-----	---------

3.0 QX	Petrol	142	10/97 →
--------	--------	-----	---------

MICRA C+C (K12)

1.4 16V	Petrol	65	08/05 →
---------	--------	----	---------

1.6 160 SR	Petrol	81	08/05 →
------------	--------	----	---------

MICRA II (K11)

1.0 i 16V	Petrol	40	01/96 → 09/00
-----------	--------	----	---------------

1.0 i 16V	Petrol	44	09/00 → 02/03
-----------	--------	----	---------------

1.3 i 16V	Petrol	55	01/96 → 02/98
-----------	--------	----	---------------

1.4 i 16V	Petrol	60	09/00 → 10/02
-----------	--------	----	---------------

MICRA III (K12)

1.0 16V	Petrol	48	01/03 → 05/05
---------	--------	----	---------------

1.2 16V	Petrol	48	01/03 → 05/05
---------	--------	----	---------------

1.2 16V	Petrol	59	01/03 → 05/05
---------	--------	----	---------------

1.4 16V	Petrol	65	01/03 → 05/05
---------	--------	----	---------------

160 SR	Petrol	81	05/05 → 06/10
--------	--------	----	---------------

NAVARA (D40)

2.5 dCi 4WD	Diesel	128	07/05 →
-------------	--------	-----	---------

NOTE (E11)

1.4	Petrol	65	03/06 →
-----	--------	----	---------

1.6	Petrol	81	03/06 →
-----	--------	----	---------

SGA116

NISSAN
PATHFINDER (R50)

3.3 V6 4WD	Petrol	110	03/98 → 07/00
3.3 V6 4WD	Petrol	125	09/97 → 07/00
3.5 V6 4WD	Petrol	162	11/00 → 12/04

PATHFINDER (R51)

2.5 dCi 4WD	Diesel	128	03/05 →
-------------	--------	-----	---------

PATROL GR II Wagon (Y61)

2.8 TD	Diesel	95	06/97 → 05/00
--------	--------	----	---------------

PICK UP (D22)

2.4 i	Petrol	88	02/98 → 11/01
2.4 i 4WD	Petrol	88	02/98 → 11/01
2.5 D	Diesel	61	02/98 → 11/01
2.5 D 4WD	Diesel	61	02/98 → 11/01
2.5 TD 4WD	Diesel	76	05/98 → 11/01

PRIMERA (P11)

1.6 16V	Petrol	78	06/96 → 12/01
1.8 16V	Petrol	84	08/99 → 12/01
2.0 16V	Petrol	103	08/99 → 12/01

PRIMERA (P12)

1.6	Petrol	78	03/02 →
1.6	Petrol	80	01/02 →
1.8	Petrol	85	03/02 →
2.0	Petrol	103	03/02 →

PRIMERA Hatchback (P11)

1.6 16V	Petrol	78	09/00 → 12/01
1.8 16V	Petrol	84	08/99 → 12/01
2.0 16V	Petrol	103	08/99 → 12/01

PRIMERA Hatchback (P12)

1.6	Petrol	78	07/02 →
1.6	Petrol	80	07/02 →
1.8	Petrol	85	07/02 →
2.0	Petrol	103	07/02 →

PRIMERA Station wagon (WP12)

1.6 Visia	Petrol	80	01/02 →
1.8	Petrol	85	03/02 →
2.0	Petrol	103	03/02 →

PRIMERA Traveller (WP11)

1.6 16V	Petrol	66	04/98 → 06/99
1.6 16V	Petrol	73	04/98 → 12/01
1.8 16V	Petrol	84	08/99 → 12/01
2.0 16V	Petrol	103	12/01 → 12/01
2.0 16V	Petrol	85	06/96 → 06/99
2.0 16V	Petrol	96	04/98 → 06/99
2.0 TD	Diesel	66	04/98 → 12/01

SGA116

NISSAN
TERRANO II (R20)

3.0 Di 4WD	Diesel	113	05/02 →
------------	--------	-----	---------

TIIDA 2 volumi /Coda spiovente (C11X)

1.6	Petrol	81	09/07 →
-----	--------	----	---------

TIIDA Tre volumi (SC11X)

1.6	Petrol	81	09/07 →
-----	--------	----	---------

URVAN Autobus (V2_)

3.0 Di	Diesel	77	02/02 →
--------	--------	----	---------

URVAN Furgonato (E25)

3.0 d	Diesel	77	02/02 → 01/12
-------	--------	----	---------------

VANETTE CARGO Autobus (HC 23)

1.6 i	Petrol	72	01/96 → 11/01
-------	--------	----	---------------

VANETTE CARGO Furgonato (HC 23)

1.6 i	Petrol	71	01/95 → 11/01
-------	--------	----	---------------

X-TRAIL (T30)

2.0	Petrol	103	07/01 →
2.0 4x4	Petrol	103	07/01 →
2.2 dCi	Diesel	100	12/03 →
2.2 dCi 4x4	Diesel	100	12/03 →
2.2 Di 4x4	Diesel	84	07/01 →
2.5 4x4	Petrol	121	09/02 →

RENAULT
ESPACE IV (JK0/1_)

3.5 V6 (JK00, JK0F, JK0P, JK0S, JK0W)	Petrol	177	11/02 →
---------------------------------------	--------	-----	---------

VEL SATIS (BJ0_)

3.5 V6 (BJ0R, BJ0V, BJ0U)	Petrol	177	06/02 →
---------------------------	--------	-----	---------

SPA101

F1 **SENSORE TEMPERATURA REFRIGERANTE**
COOLANT TEMPERATURE SENSOR



ALFA ROMEO

156 (932)

1.9 JTD (932B2)	Diesel	77	09/97 → 10/00
2.4 JTD (932B1)	Diesel	100	09/97 → 10/00

156 Sportwagon (932)

1.9 JTD (932B2)	Diesel	77	05/00 → 10/00
2.4 JTD (932B1)	Diesel	100	05/00 → 10/00

FIAT

126

650	Petrol	17	07/77 → 09/87
700	Petrol	19	09/87 → 06/96

127

0.9	Petrol	33	06/71 → 05/83
1.3 Diesel	Diesel	33	04/81 → 12/86

127 Panorama

1.3 D	Diesel	33	06/81 → 12/86
-------	--------	----	---------------

131

1.3 Mirafiori	Petrol	40	10/74 → 09/81
---------------	--------	----	---------------

132

2.0	Petrol	82	05/77 → 06/81
-----	--------	----	---------------

ARGENTA (132A)

2000 i.e.	Petrol	90	06/81 → 07/86
2500 Diesel	Diesel	53	06/81 → 11/85

BARCETTA (183)

1.8 16V	Petrol	96	04/95 → 05/05
---------	--------	----	---------------

BRAVA (182)

1.4 (182.BG)	Petrol	55	10/95 → 10/01
1.6 16V (182.BH)	Petrol	66	10/95 → 10/01
1.8 GT 16V (182.BC)	Petrol	83	10/95 → 10/01
1.9 D	Diesel	48	10/95 → 10/01

BRAVO I (182)

1.4 (182.AG)	Petrol	55	10/95 → 10/01
1.6 16V (182.AH)	Petrol	66	10/95 → 10/01
1.8 GT (182.AC)	Petrol	83	10/95 → 10/01

SPA101



FIAT

BRAVO I (182)

1.9 D	Diesel	48	10/95 → 10/01
2.0 HGT 20V (182.AD)	Petrol	108	10/95 → 07/98

CINQUECENTO (170)

0.9 (170AB)	Petrol	30	07/91 → 12/93
0.9 i.e. (170AC)	Petrol	30	07/91 → 12/93
0.9 i.e. S (170AF, 170CF)	Petrol	29	07/91 → 01/98

1.1 Sporting (170AH)	Petrol	40	10/94 → 01/98
----------------------	--------	----	---------------

COUPE (FA/175)

2.0 16V	Petrol	102	11/93 → 08/96
2.0 16V Turbo	Petrol	140	11/93 → 08/96

DOBLO (119)

1.6 16V (223AXD1A)	Petrol	76	10/01 →
1.6 Natural Power	BiFuel	76	09/02 →

DOBLO Cargo (223)

1.6 16V (223XD1A)	Petrol	76	10/01 →
1.6 Natural Power	BiFuel	76	09/02 →

DUCATO Furgonato (290)

2.5 D 4x4	Diesel	55	07/90 → 03/94
2.5 TD	Diesel	70	07/90 → 03/94

DUCATO Panorama (280)

1.9 D	Diesel	52	02/87 → 08/90
-------	--------	----	---------------

DUCATO Pianale piatto/Telaio (280)

1.9 D	Diesel	52	01/88 → 08/90
-------	--------	----	---------------

DUNA (146 B)

1.7 DS	Diesel	44	01/87 → 12/91
60 1.1	Petrol	43	01/87 → 12/91
70 1.3	Petrol	49	01/87 → 12/91

DUNA Weekend (146 B)

1.7 DS	Diesel	44	01/87 → 12/91
60 1.1	Petrol	43	01/87 → 12/91
70 1.3	Petrol	49	01/87 → 12/91

FIORINO (147)

1.3 D	Diesel	33	03/82 → 12/87
1.5	Petrol	55	01/88 → 08/93

FIORINO Furgonato (146)

75 i.e. 1.6	Petrol	55	10/93 → 05/01
-------------	--------	----	---------------

FIORINO Pick up (146)

1.7 TD	Diesel	46	01/97 → 05/01
--------	--------	----	---------------

SPA101

FIAT
MAREA (185)

1.6 100 16V Bipower	Petrol/CNG	76	04/99 → 05/02
---------------------	------------	----	---------------

PALIO (178BX)

1.2	Petrol	54	06/98 →
1.4	Petrol	51	04/96 →
1.4 Cat.	Petrol	51	04/96 →
1.6 16V	Petrol	74	04/96 →

PALIO Weekend (178DX)

1.2 (178DX.G1A)	Petrol	54	04/96 → 02/01
1.6 16V (178DX.D1A)	Petrol	74	04/96 → 02/01

PANDA (141A_)

900	Petrol	29	04/92 → 12/96
950	Petrol	35	09/82 → 08/83
1100	Petrol	37	05/91 → 12/99
1100	Petrol	40	02/95 → 09/03
1000 i.e. Cat.	Petrol	33	10/87 → 08/98
750 (141AA)	Petrol	25	01/86 → 01/95
750 (141AI)	Petrol	25	01/86 → 01/95
750 (141AM) Cat.	Petrol	25	01/95 → 10/03
950 4x4	Petrol	35	09/83 → 12/86

PANDA Van (141_)

750	Petrol	25	01/86 → 07/92
1000 i.e.	Petrol	33	08/92 → 02/04

PUNTO (176)

1.2 16V	Petrol	63	04/97 → 09/99
1.4 GT Turbo	Petrol	98	01/94 → 09/96
1.6	Petrol	65	01/94 → 04/97
1.7 D	Diesel	42	04/94 → 09/97
1.7 TD	Diesel	51	01/94 → 09/99
1.7 TD	Diesel	52	01/94 → 09/99
55 1.1	Petrol	40	09/93 → 09/99
60 1.2	Petrol	43	01/94 → 09/99
60 1.2	Petrol	44	03/94 → 09/99
75 1.2	Petrol	54	12/93 → 09/99

PUNTO Cabriolet (176C)

60 1.2	Petrol	44	05/95 → 06/00
85 16V 1.2	Petrol	63	04/97 → 06/00
90 1.6	Petrol	65	04/94 → 04/97

PUNTO Van (176L)

1.7 D	Diesel	42	04/96 → 02/00
1.7 TD	Diesel	52	04/96 → 02/00

SPA101

FIAT
REGATA (138)

100 Super 1.6	Petrol	74	10/83 → 12/90
65 Diesel 1.9	Diesel	48	04/84 → 07/89
70 1.3	Petrol	50	09/83 → 07/86
80 Turbo Diesel 1.9	Diesel	59	05/86 → 07/89
85 1.5	Petrol	58	05/85 → 12/87

REGATA Weekend

65 Diesel 1.9	Diesel	48	04/84 → 07/89
70 1.3	Petrol	50	01/84 → 07/89
80 Turbo Diesel 1.9	Diesel	59	05/86 → 07/89

RITMO I (138A)

70 1.3	Petrol	48	11/83 → 08/85
75 i.e. 1.5	Petrol	55	10/85 → 05/87

RITMO II (138A)

100 1.6	Petrol	74	01/83 → 12/87
105 1.6	Petrol	77	01/83 → 12/87
60 1.1	Petrol	43	04/85 → 12/87
60 Diesel 1.7	Diesel	43	10/82 → 10/85
75 1.5	Petrol	55	09/85 → 12/88

SEICENTO (187)

0.9 (187AXA, 187AXA1A)	Petrol	29	01/98 → 01/10
------------------------	--------	----	---------------

SEICENTO Van (187)

0.9 (187AXA)	Petrol	29	01/98 → 01/10
--------------	--------	----	---------------

SIENA (178_)

1.2	Petrol	54	09/98 →
1.4	Petrol	51	04/96 →
1.4 Cat.	Petrol	51	04/96 →

TEMPRA (159)

1.4 i.e. (159.AC)	Petrol	57	03/91 → 08/96
1.4 i.e. (159.AC, 159.AX)	Petrol	51	03/92 → 08/96
1.6	Petrol	63	03/90 → 04/93
1.6 i.e. (159.AE)	Petrol	57	06/90 → 07/92
1.6 i.e. (159.AS, 159.AT)	Petrol	55	06/92 → 08/96
1.8 i.e. (159.AN)	Petrol	77	03/92 → 08/96
1.8 i.e. (159.AV)	Petrol	76	09/93 → 08/96
1.8 i.e. (159.AZ)	Petrol	66	09/93 → 08/96
1.8 i.e. (159.BY)	Petrol	74	10/94 → 08/96
1.9 D (159.AG)	Diesel	48	07/91 → 08/96
1.9 TD (159.AQ)	Diesel	59	07/92 → 08/96

SPA101



KW



FIAT

TEMPRA (159)

1.9 TD (159.CU, 159.AU, 159.AI, 159.BI)	Diesel	66	05/90 → 08/96
---	--------	----	---------------

2.0 i.e. (159.AP)	Petrol	83	10/90 → 08/96
-------------------	--------	----	---------------

TEMPRA S.W. (159)

1.4 i.e. (159.AC)	Petrol	57	03/91 → 08/96
-------------------	--------	----	---------------

1.4 i.e. (159.AC, 159.AX)	Petrol	51	10/92 → 08/96
---------------------------	--------	----	---------------

1.6	Petrol	63	12/90 → 04/93
-----	--------	----	---------------

1.6 i.e. (159.AE)	Petrol	57	10/90 → 08/96
-------------------	--------	----	---------------

1.6 i.e. (159.AS, 159.AT)	Petrol	55	10/92 → 08/96
---------------------------	--------	----	---------------

1.8 i.e. (159.AN)	Petrol	77	03/92 → 12/93
-------------------	--------	----	---------------

1.8 i.e. (159.AV)	Petrol	76	09/93 → 08/96
-------------------	--------	----	---------------

1.8 i.e. (159.AZ)	Petrol	66	09/93 → 08/96
-------------------	--------	----	---------------

1.8 i.e. (159.BY)	Petrol	74	10/94 → 08/96
-------------------	--------	----	---------------

1.9 D (159.AG)	Diesel	48	07/91 → 08/96
----------------	--------	----	---------------

1.9 TD (159.AI, 159.BI, 159.CU, 159.AU)	Diesel	66	07/91 → 02/95
---	--------	----	---------------

1.9 TD (159.AQ)	Diesel	59	03/92 → 06/93
-----------------	--------	----	---------------

2.0 i.e. (159.AP)	Petrol	83	01/91 → 03/95
-------------------	--------	----	---------------

2.0 i.e. 4x4 (159.AP)	Petrol	83	03/92 → 03/95
-----------------------	--------	----	---------------

TIPO (160)

1.4 (160.AC)	Petrol	52	07/87 → 12/89
--------------	--------	----	---------------

1.4 i.e. (160.AP, 160.AD, 160.EA)	Petrol	51	05/89 → 04/95
-----------------------------------	--------	----	---------------

1.6 i.e. (160.A1, 160.EC, 160.EB)	Petrol	55	10/92 → 04/95
-----------------------------------	--------	----	---------------

1.6 i.e. (160.AF)	Petrol	57	07/90 → 01/93
-------------------	--------	----	---------------

1.8 i.e.	Petrol	66	09/93 → 04/95
----------	--------	----	---------------

1.8 i.e. (160.ED)	Petrol	76	04/93 → 04/95
-------------------	--------	----	---------------

1.8 i.e. 16V Sport	Petrol	100	11/89 → 06/92
--------------------	--------	-----	---------------

1.9 D	Diesel	48	07/91 → 08/96
-------	--------	----	---------------

1.9 TD (160.AW)	Diesel	59	03/92 → 06/93
-----------------	--------	----	---------------

1.9 TD (160.EL, 160.GL, 160.AQ, 160.EI, 160.AR)	Diesel	66	09/90 → 04/95
---	--------	----	---------------

2.0 16V (160.AV)	Petrol	107	07/91 → 04/95
------------------	--------	-----	---------------

2.0 i.e. (160.AJ)	Petrol	80	06/90 → 03/92
-------------------	--------	----	---------------

2.0 i.e. (160.AT, 160.AJ)	Petrol	83	03/90 → 04/95
---------------------------	--------	----	---------------

SPA101



KW



FIAT

TIPO (160)

2.0 i.e. 16V Sport (160.EF)	Petrol	102	03/93 → 04/95
-----------------------------	--------	-----	---------------

UNO (146A/E)

1.3 Super Diesel	Diesel	33	06/83 → 03/92
------------------	--------	----	---------------

1.4 Turbo i.e.	Petrol	82	09/89 → 09/93
----------------	--------	----	---------------

1.4 Turbo i.e.	Petrol	87	12/89 → 12/96
----------------	--------	----	---------------

1.9 D	Diesel	44	09/89 → 03/94
-------	--------	----	---------------

45 0.9	Petrol	33	03/83 → 09/92
--------	--------	----	---------------

45 1.0 (146A.ED)	Petrol	32	06/86 → 12/93
------------------	--------	----	---------------

45 i.e. 1.0	Petrol	33	04/84 → 12/94
-------------	--------	----	---------------

50 1.1	Petrol	37	01/90 → 12/93
--------	--------	----	---------------

50 i.e. 1.1	Petrol	36	06/92 → 12/93
-------------	--------	----	---------------

55 1.1	Petrol	40	01/83 → 08/89
--------	--------	----	---------------

60 1.1	Petrol	42	04/89 → 12/92
--------	--------	----	---------------

60 1.1 (146A.EG)	Petrol	43	05/85 → 08/89
------------------	--------	----	---------------

60 Diesel 1.7	Diesel	42	09/89 → 12/93
---------------	--------	----	---------------

60 Diesel 1.7	Diesel	44	07/86 → 08/89
---------------	--------	----	---------------

70 i.e. 1.4	Petrol	51	09/89 → 12/93
-------------	--------	----	---------------

70 S 1.4	Petrol	52	09/89 → 10/92
----------	--------	----	---------------

75 i.e. 1.5	Petrol	55	10/85 → 12/93
-------------	--------	----	---------------

X 1/9 (128 AS)

1.3	Petrol	54	10/75 → 06/78
-----	--------	----	---------------

INNOCENTI

ELBA (146)

1.3 (146CW)	Petrol	49	08/91 → 12/96
-------------	--------	----	---------------

1.4 i.e. (146EN, 146EQ)	Petrol	49	09/94 → 12/96
-------------------------	--------	----	---------------

1.5 i.e. (146C9)	Petrol	55	08/92 → 09/94
------------------	--------	----	---------------

1.6 i.e. (146EO, 146ER)	Petrol	55	09/94 → 12/96
-------------------------	--------	----	---------------

1.7 D (146DI, 146EI)	Diesel	42	08/91 → 12/96
----------------------	--------	----	---------------

IVECO

DAILY I Cassone / Furgonato / Promiscuo

30-8 (10014131, 10014132, 10014137, 10014231, 10014232...)	Diesel	53	01/78 → 12/89
--	--------	----	---------------

35-10 (10314204, 10314211, 10314212, 10314217, 10314411...)	Diesel	68	01/85 → 12/89
---	--------	----	---------------

SPA101

IVECO
DAILY I Cassone / Furgonato / Promiscuo

35-8 (10034131, 10034132, 10034137, 10034224, 10034231...)	Diesel	53	01/78 → 12/89
40-8 V	Diesel	53	01/83 → 06/89
45-10 V (10334204, 10334211, 10334212, 10334217, 10334404)	Diesel	68	01/85 → 12/89
49-10 V (10354204, 10354211, 10354212, 10354217...)	Diesel	68	01/85 → 12/89

DAILY I Pianale piatto/Telaio

30-8 (10011131, 10011132, 10011231, 10011232, 10011237...)	Diesel	53	01/78 → 12/89
35-10 (10310311, 10311111, 10311112, 10311117, 10311211...)	Diesel	68	01/85 → 12/89
35-8 (10031131, 10031132, 10031137, 10031224, 10031231...)	Diesel	53	01/78 → 12/89
40-8	Diesel	53	01/83 → 06/89
45-10 (10331211, 10331212, 10331217, 10331304, 10331311...)	Diesel	68	01/85 → 12/89
49-10 (10350211, 10350304, 10350311, 10350404, 10350411...)	Diesel	68	01/85 → 12/89

DAILY II Autobus

A 40-10 (94139111, 94139131, 94139311, 94139315...)	Diesel	76	01/91 → 12/96
---	--------	----	---------------

DAILY II Cassone / Furgonato / Promiscuo

40-10 V	Diesel	76	01/90 → 04/96
---------	--------	----	---------------

SPA101

LADA
NIVA (2121)

1600	Petrol	56	04/80 → 12/87
1600	Petrol	56	12/76 → 05/87

SAMARA (2108, 2109, 2115)

1100	Petrol	39	02/88 → 12/94
1300	Petrol	48	01/86 → 12/94
1500	Petrol	53	01/88 →

LANCIA
A 112

0.9 Junior (A112B/2)	Petrol	29	03/81 → 06/86
1.0 Abarth (A112B2/5)	Petrol	51	03/78 → 02/84

PRISMA (831AB0)

1.5	Petrol	63	01/83 → 04/86
-----	--------	----	---------------

SEAT
FURA (025A)

0.9	Petrol	33	01/82 → 06/86
-----	--------	----	---------------

RONDA (022A)

1.7 Diesel	Diesel	40	06/82 → 12/86
------------	--------	----	---------------

ZASTAVA
101 (1100)

1.1	Petrol	40	06/73 → 01/90
-----	--------	----	---------------

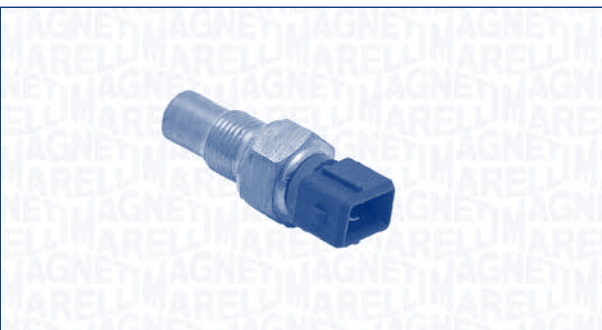
SPA102
**F1 SENSORE TEMPERATURA REFRIGERANTE
COOLANT TEMPERATURE SENSOR**

CITROËN
EVASION (22, U6)

1.9 TD	Diesel	66	11/94 → 07/02
2.0	Petrol	89	06/94 → 07/02

JUMPER Autobus (230P)

1.9 TD	Diesel	66	08/94 → 04/02
--------	--------	----	---------------

SPA102



CITROËN

JUMPER Furgonato (230L)

1.9 TD Diesel 66 03/94 → 04/02

JUMPER Pianale piatto/Telaio (230)

1.9 TD Diesel 66 03/94 → 04/02

XM (Y3)

2.0 Petrol 84 05/89 → 04/94

2.0 i Petrol 79 05/89 → 04/94

2.0 i Petrol 89 05/89 → 06/94

3.0 Petrol 123 05/89 → 05/94

3.0 Petrol 147 05/89 → 06/94

3.0 V6 Petrol 123 05/89 → 06/94

3.0 V6 24V Petrol 147 07/90 → 06/94

XM Break (Y3)

2.0 i Petrol 89 11/91 → 04/94

2.0 i (Y3A) Petrol 79 11/91 → 04/94

3.0 Pallas Petrol 147 01/90 → 07/94

3.0 Pullman Petrol 147 05/89 → 07/94

3.0 V6 Petrol 123 11/91 → 04/94

FIAT

ULYSSE (220)

1.9 TD (220AH5) Diesel 66 02/95 → 08/02

2.0 (220.AC5) Petrol 89 06/94 → 08/02

PEUGEOT

106 I (1A, 1C)

1.4 Petrol 55 09/91 → 04/96

1.6 Petrol 65 06/93 → 04/96

306 (7B, N3, N5)

1.4 SL Petrol 55 06/94 → 05/01

1.6 SR Petrol 65 06/94 → 10/00

2.0 ST Petrol 89 07/94 → 05/01

306 2 volumi /Coda spiovente (7A, 7C, N3, N5)

1.4 Petrol 55 05/93 → 05/01

1.6 Petrol 65 05/93 → 10/00

1.8 Petrol 74 05/93 → 05/01

1.8 D Diesel 43 05/93 → 05/01

1.9 DT Diesel 66 05/93 → 05/01

2.0 XSi Petrol 89 05/93 → 05/01

306 Break (7E, N3, N5)

1.4 Petrol 55 03/97 → 04/02

1.6 Petrol 65 03/97 → 10/00

1.8 Petrol 74 03/97 → 04/02

306 Cabriolet (7D, N3, N5)

1.8 Petrol 74 03/94 → 04/02

309 I (10C, 10A)

1.9 D Diesel 47 06/86 → 07/89

SPA102



CITROËN

405 II (4B)

1.6 Petrol 65 08/92 → 10/95

1.8 Petrol 74 08/92 → 10/95

1.9 D Diesel 47 08/92 → 10/95

1.9 D Diesel 50 06/94 → 10/95

2.0 Petrol 89 08/92 → 10/95

405 II Break (4E)

1.6 Petrol 65 08/92 → 10/96

1.8 Petrol 74 08/92 → 10/96

1.9 D Diesel 47 08/92 → 10/96

1.9 D Diesel 50 06/94 → 10/96

2.0 Petrol 89 08/92 → 10/96

605 (6B)

2.0 Turbo Petrol 108 07/91 → 09/99

2.1 TD 12V Diesel 80 08/94 → 09/99

2.1 Turbo Diesel Diesel 80 06/89 → 09/99

3.0 Petrol 123 08/89 → 06/94

3.0 Petrol 123 10/89 → 09/99

806 (221)

1.9 TD Diesel 66 07/95 → 08/02

2.0 Petrol 89 06/94 → 08/02

BOXER Autobus (230P)

1.9 TD Diesel 66 08/94 → 04/02

BOXER Furgonato (230L)

1.9 TD Diesel 66 07/99 → 04/02

SPA103

F1 **SENSORE TEMPERATURA REFRIGERANTE**
COOLANT TEMPERATURE SENSOR

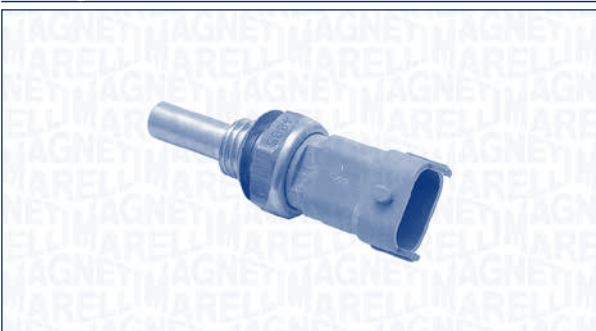

ALFA ROMEO

145 (930)

1.9 JTD Diesel 77 02/99 → 01/01

1.9 TD Diesel 66 05/98 → 02/99

SPA103

ALFA ROMEO
146 (930)

1.9 JTD	Diesel	77	02/99 → 01/01	
1.9 TD	Diesel	66	05/98 → 02/99	

156 (932)

1.8 16V T.SPARK (932A3)	Petrol	106	09/97 → 10/00	
1.8 16V T.SPARK (932A31__)	Petrol	103	10/00 → 12/01	
1.9 JTD (932A2B, 932A2C)	Diesel	85	05/01 → 12/01	
1.9 JTD (932A2B__)	Diesel	81	10/00 → 05/01	
1.9 JTD (932B2)	Diesel	77	09/97 → 10/00	ENGINE: → 1415540
2.4 JTD (932A1B__)	Diesel	103	10/00 → 12/01	
2.4 JTD (932B1)	Diesel	100	09/97 → 09/03	ENGINE: → 1283804

156 Sportwagon (932)

1.8 16V T.SPARK (932A3)	Petrol	106	05/00 → 10/00	
1.8 16V T.SPARK (932B31__)	Petrol	103	10/00 → 12/01	
1.9 JTD (932B2)	Diesel	77	05/00 → 10/00	ENGINE: → 1415540
1.9 JTD (932B2B, 932B2C)	Diesel	85	05/01 → 12/01	
1.9 JTD (932B2B__)	Diesel	81	10/00 → 05/01	
2.4 JTD (932B1)	Diesel	100	05/00 → 09/03	ENGINE: → 1283804
2.4 JTD (932B1B__)	Diesel	103	10/00 → 12/01	

166 (936)

2.4 JTD	Diesel	110	04/02 → 06/07	
2.4 JTD (936A2A__)	Diesel	100	09/98 → 10/00	
2.4 JTD (936A2B__)	Diesel	103	10/00 → 06/07	

CITROËN
JUMPER Autobus (230P)

2.8 HDi	Diesel	94	09/00 → 04/02	
2.8 HDi 4x4	Diesel	94	09/00 → 04/02	

JUMPER Autobus (244, Z_)

2.8 HDi	Diesel	94	04/02 →	
---------	--------	----	---------	--

JUMPER Furgonato (230L)

2.8 HDi	Diesel	94	09/00 → 04/02	
2.8 HDi 4x4	Diesel	94	09/00 → 04/02	

SPA103

CITROËN
JUMPER Furgonato (244)

2.8 HDi	Diesel	107	05/04 →	
2.8 HDi	Diesel	94	04/02 →	
2.8 HDi 4x4	Diesel	94	04/02 →	

JUMPER Pianale piatto/Telaio (230)

2.8 HDi	Diesel	94	09/00 → 04/02	
---------	--------	----	---------------	--

JUMPER Pianale piatto/Telaio (244)

2.8 HDi	Diesel	107	05/04 →	
2.8 HDi	Diesel	94	04/02 →	

FERRARI
360 (F131)

3.6 Modena	Petrol	294	03/99 → 03/05	
------------	--------	-----	---------------	--

360 Spider (F131)

3.6	Petrol	294	02/00 → 03/05	
-----	--------	-----	---------------	--

FIAT
BRAVA (182)

1.9 JTD 105	Diesel	77	12/98 → 10/01	
-------------	--------	----	---------------	--

BRAVO I (182)

1.9 JTD 105	Diesel	77	12/98 → 10/01	
-------------	--------	----	---------------	--

DUCATO Autobus (230)

2.8 JTD	Diesel	94	11/00 → 04/02	
2.8 JTD 4x4	Diesel	94	11/00 → 04/02	

DUCATO Autobus (244, Z_)

2.3 JTD	Diesel	81	04/02 →	
---------	--------	----	---------	--

DUCATO Autobus (244, Z_)

2.8 JTD	Diesel	94	04/02 →	
2.8 JTD 4x4	Diesel	94	07/02 →	

DUCATO Furgonato (230L)

2.8 JTD	Diesel	94	11/00 → 04/02	
2.8 JTD 4x4	Diesel	94	11/00 → 04/02	

DUCATO Furgonato (244)

2.3 JTD	Diesel	81	04/02 →	
2.8 JTD	Diesel	94	04/02 →	
2.8 JTD 4x4	Diesel	94	07/02 →	

DUCATO Pianale piatto/Telaio (230)

2.8 JTD	Diesel	94	11/00 → 04/02	
2.3 JTD	Diesel	81	04/02 → 07/06	
2.8 JTD	Diesel	94	04/02 → 07/06	
2.8 JTD 4x4	Diesel	94	10/02 → 07/06	

MAREA (185)

1.9 JTD 105	Diesel	77	04/99 → 01/01	
2.4 JTD 130	Diesel	96	04/99 → 05/02	

MAREA Weekend (185)

1.9 JTD 105	Diesel	77	04/99 → 05/02	
2.4 JTD 130	Diesel	96	04/99 → 05/02	

SPA103



KW



FIAT

MULTIPLA (186)

1.9 JTD 105 (186AXB1A)	Diesel	77	04/99 → 12/00
---------------------------	--------	----	---------------

HONDA

ACCORD VII (CL)

2.2 i-CTDi	Diesel	103	01/04 →
------------	--------	-----	---------

ACCORD VII Tourer (CM)

2.2 i-CTDi	Diesel	103	01/04 →
------------	--------	-----	---------

LANCIA

KAPPA (838A)

2.4 JTD (838AL1AA)	Diesel	100	06/98 → 10/01
-----------------------	--------	-----	---------------

KAPPA SW (838B)

2.4 JTD (838BL1AA)	Diesel	100	06/98 → 10/01
-----------------------	--------	-----	---------------

LYBRA (839AX)

1.9 JTD	Diesel	85	05/01 → 10/05
---------	--------	----	---------------

1.9 JTD (839AXD1A)	Diesel	77	07/99 → 09/00
-----------------------	--------	----	---------------

1.9 JTD (839AXI1A)	Diesel	81	09/00 → 05/01
-----------------------	--------	----	---------------

2.4 JTD	Diesel	110	05/02 → 10/05
---------	--------	-----	---------------

2.4 JTD (839AXE1A)	Diesel	99	07/99 → 02/01
-----------------------	--------	----	---------------

2.4 JTD (839AXL1A)	Diesel	103	09/00 → 05/02
-----------------------	--------	-----	---------------

LYBRA SW (839BX)

1.9 JTD	Diesel	85	05/01 → 10/05
---------	--------	----	---------------

1.9 JTD (839BXD1A)	Diesel	77	07/99 → 09/00
-----------------------	--------	----	---------------

1.9 JTD (839BXI1A)	Diesel	81	09/00 → 05/01
-----------------------	--------	----	---------------

2.4 JTD	Diesel	110	05/02 → 10/05
---------	--------	-----	---------------

10	Diesel	99	10/99 → 09/00
----	--------	----	---------------

2.4 JTD (839BXL1A)	Diesel	103	09/00 → 10/05
-----------------------	--------	-----	---------------

OPEL

AGILA (A) (H00)

1.0 12V	Petrol	43	09/00 → 08/03
---------	--------	----	---------------

1.2 16V	Petrol	55	09/00 → 06/04
---------	--------	----	---------------

ASTRA G 2 volumi /Coda spiovente (F48_, F08_)

1.2 16V	Petrol	48	02/98 → 09/00
---------	--------	----	---------------

1.2 16V	Petrol	55	09/00 → 09/03
---------	--------	----	---------------

1.4 16V	Petrol	66	02/98 → 09/00
---------	--------	----	---------------

SPA103



KW



OPEL

ASTRA G 2 volumi /Coda spiovente (F48_, F08_)

1.6	Petrol	55	02/98 → 09/00
-----	--------	----	---------------

1.6 16V	Petrol	74	02/98 → 08/00
---------	--------	----	---------------

2.0 DI	Diesel	60	03/98 → 08/00
--------	--------	----	---------------

2.0 DTI 16V	Diesel	74	09/00 → 01/04
-------------	--------	----	---------------

2.0 OPC	Petrol	141	09/02 → 01/04
---------	--------	-----	---------------

2.0 OPC	Petrol	147	11/02 → 01/04
---------	--------	-----	---------------

2.2 DTI	Diesel	92	09/02 → 01/04
---------	--------	----	---------------

ASTRA G Cabriolet (F67)

2.0 16V Turbo	Petrol	147	11/02 → 08/05
---------------	--------	-----	---------------

2.0 OPC	Petrol	141	03/02 → 08/05
---------	--------	-----	---------------

2.2 DTI	Diesel	92	09/02 → 08/05
---------	--------	----	---------------

ASTRA G Coupé (F07_)

2.0 16V Turbo	Petrol	140	09/00 → 08/01
---------------	--------	-----	---------------

2.0 16V Turbo	Petrol	141	08/01 → 02/05
---------------	--------	-----	---------------

2.0 16V Turbo	Petrol	147	11/02 → 02/05
---------------	--------	-----	---------------

2.2 DTI	Diesel	92	09/02 → 02/05
---------	--------	----	---------------

ASTRA G Furgonato (F70)

1.6	Petrol	55	01/99 → 09/00
-----	--------	----	---------------

2.0 DI	Diesel	60	01/99 → 08/00
--------	--------	----	---------------

ASTRA G Station wagon (F35_)

1.2 16V	Petrol	48	02/98 → 09/00
---------	--------	----	---------------

1.2 16V	Petrol	55	09/00 → 09/03
---------	--------	----	---------------

1.4 16V	Petrol	66	06/98 → 09/00
---------	--------	----	---------------

1.6	Petrol	55	02/98 → 09/00
-----	--------	----	---------------

1.6 16V	Petrol	74	02/98 → 08/00
---------	--------	----	---------------

2.0 DI	Diesel	60	02/98 → 08/00
--------	--------	----	---------------

2.0 DTI 16V	Diesel	74	09/00 → 06/04
-------------	--------	----	---------------

2.0 OPC	Petrol	141	09/02 → 06/04
---------	--------	-----	---------------

2.0 OPC	Petrol	147	11/02 → 06/04
---------	--------	-----	---------------

2.2 DTI	Diesel	92	09/02 → 06/04
---------	--------	----	---------------

ASTRA G Tre volumi (F69_)

1.2 16V	Petrol	48	09/98 → 09/00
---------	--------	----	---------------

1.2 16V	Petrol	55	09/00 → 09/03
---------	--------	----	---------------

1.4 16V	Petrol	66	09/98 → 09/00
---------	--------	----	---------------

1.6	Petrol	55	09/98 → 09/00
-----	--------	----	---------------

1.6 16V	Petrol	74	09/98 → 08/00
---------	--------	----	---------------

2.0 DI	Diesel	60	09/98 → 08/00
--------	--------	----	---------------

2.0 DTI 16V	Diesel	74	09/00 → 01/04
-------------	--------	----	---------------

2.2 DTI	Diesel	92	09/02 → 01/04
---------	--------	----	---------------

ASTRA H (L48)

1.4	Petrol	66	03/04 →
-----	--------	----	---------

2.0 Turbo	Petrol	125	03/04 →
-----------	--------	-----	---------

2.0 Turbo	Petrol	147	09/04 →
-----------	--------	-----	---------

2.0 Turbo	Petrol	177	09/05 →
-----------	--------	-----	---------

SPA103

OPEL
ASTRA H GTC (L08)

1.4	Petrol	66	03/05 →
2.0 Turbo	Petrol	125	03/05 →
2.0 Turbo	Petrol	147	03/05 →

ASTRA H Station wagon (L35)

1.4	Petrol	66	08/04 →
2.0 Turbo	Petrol	125	08/04 →
2.0 Turbo	Petrol	147	09/04 →

ASTRA H TwinTop (L67)

2.0 Turbo	Petrol	125	09/05 →
2.0 Turbo	Petrol	147	09/05 →

COMBO Cassone / Furgonato / Promiscuo

1.4 16V	Petrol	66	08/05 →
---------	--------	----	---------

COMBO Tour

1.4	Petrol	66	10/04 →
-----	--------	----	---------

CORSA B (73_, 78_, 79_)

1.2 i 16V	Petrol	48	03/98 → 09/00
-----------	--------	----	---------------

CORSA C (F08, F68)

1.0	Petrol	43	09/00 → 08/03
1.0	Petrol	44	09/03 → 08/05
1.2	Petrol	55	09/00 → 06/04
1.2 Twinport	Petrol	59	07/04 → 12/09
1.4 Twinport	Petrol	66	09/03 → 08/05

CORSA C Furgonato (F08, W5L)

1.2 16V	Petrol	55	09/00 → 06/04
---------	--------	----	---------------

FRONTERA B (6B_)

2.2 DTI	Diesel	88	09/02 → 09/04	ENGINE: 3V500001 →
2.2 DTI (6B_ZC, 6B_VF, 6B_66, 6B_76)	Diesel	85	10/98 → 09/02	ENGINE: 3V500001 →

MERIVA

1.4 16V Twinport	Petrol	66	09/04 → 05/10
------------------	--------	----	---------------

SPEEDSTER

2.0 Turbo	Petrol	147	04/03 → 09/05
-----------	--------	-----	---------------

TIGRA TwinTop

1.4	Petrol	66	09/04 →
-----	--------	----	---------

VECTRA B (36_)

2.0 DTI 16V	Diesel	74	09/97 → 08/00
2.2 DTI 16V	Diesel	92	09/00 → 04/02
2.6 i V6	Petrol	125	09/00 → 04/02

VECTRA B 2 volumi /Coda spiovente (38_)

2.0 DTI 16V	Diesel	74	09/97 → 08/00
2.2 DTI 16V	Diesel	92	09/00 → 09/02
2.6 i V6	Petrol	125	09/00 → 09/02

SPA103

OPEL
VECTRA B Station wagon (31_)

2.0 DTI 16V	Diesel	74	09/97 → 08/00
2.2 DTI 16V	Diesel	92	09/00 → 09/02
2.6 i V6	Petrol	125	09/00 → 09/02

VECTRA C

2.0 DTI 16V	Diesel	74	04/02 →
2.2 DTI 16V	Diesel	92	04/02 →
3.2 V6	Petrol	155	08/02 → 09/05

VECTRA C GTS

2.0 DTI 16V	Diesel	74	08/02 →
2.2 DTI 16V	Diesel	92	08/02 →
3.2 V6	Petrol	155	08/02 → 09/05

VECTRA C Station wagon

2.0 DTI	Diesel	74	10/03 →
2.2 DTI	Diesel	92	10/03 →
3.2 V6	Petrol	155	10/03 → 09/05

ZAFIRA A (F75_)

1.6 16V	Petrol	74	04/99 → 08/99
2.0 DI 16V	Diesel	60	10/99 → 08/00
2.0 DTI 16V	Diesel	74	09/00 → 06/05
2.0 OPC	Petrol	141	09/01 → 06/05
2.0 OPC	Petrol	147	11/02 → 06/05
2.2 DTI 16V	Diesel	92	03/02 → 06/05

ZAFIRA B (A05)

2.0	Petrol	147	07/05 →
-----	--------	-----	---------

PEUGEOT
BOXER Autobus (230P)

2.8 HDi	Diesel	94	11/00 → 04/02
---------	--------	----	---------------

BOXER Autobus (244, Z_)

2.8 HDi	Diesel	94	04/02 →
2.8 HDi 4x4	Diesel	94	04/02 →

BOXER Furgonato (230L)

2.8 HDi	Diesel	94	11/00 → 04/02
---------	--------	----	---------------

BOXER Furgonato (244)

2.8 HDi	Diesel	94	04/02 →
2.8 HDi 4x4	Diesel	94	04/02 →

BOXER Pianale piatto/Telaio (244)

2.8 HDi	Diesel	94	04/02 →
2.8 HDi 4x4	Diesel	94	04/02 →

BOXER Pianale piatto/Telaio (ZCT_)

2.8 HDi	Diesel	94	11/00 → 04/02
---------	--------	----	---------------

SAAB
900 II

2.0 -16 Turbo	Petrol	136	09/95 → 02/98
2.0 i	Petrol	96	09/95 → 02/98

SPA103



KW



SAAB

900 II

2.3 -16 Petrol 110 09/95 → 02/98

900 II Cabriolet

2.0 -16 Turbo Petrol 136 09/95 → 02/98

2.0 i Petrol 96 09/95 → 02/98

2.3 -16 Petrol 110 09/95 → 02/98

9-3 (YS3D)

2.0 i Petrol 96 02/98 → 09/02

2.0 SE Turbo Petrol 147 02/98 → 09/02

2.0 Turbo Petrol 110 01/01 → 09/02

2.0 Turbo Petrol 151 10/99 → 09/02

2.0 Turbo Petrol 113 10/98 → 09/02

2.0 Turbo Petrol 136 02/98 → 09/02

2.2 TiD Diesel 85 02/98 → 11/00

2.3 i Petrol 110 02/98 → 09/02

2.3 Turbo Petrol 165 10/98 → 09/02

9-3 Cabriolet (YS3D)

2.0 i Petrol 96 02/98 → 08/03

2.0 SE Turbo Petrol 147 02/98 → 08/03

2.0 Turbo Petrol 136 02/98 → 08/03

2.0 Turbo Petrol 110 01/01 → 08/03

2.0 Turbo Petrol 113 10/98 → 08/03

2.0 Turbo Petrol 151 10/99 → 08/03

2.3 i Petrol 110 02/98 → 08/03

2.3 Turbo Petrol 165 10/99 → 08/03

9-5 (YS3E)

2.0 T Petrol 110 09/97 →

2.2 TiD Diesel 88 03/02 →

2.3 t Petrol 125 09/97 →

2.3 t Petrol 136 01/01 →

2.3 Turbo Petrol 169 10/99 → 09/01

2.3 Turbo Petrol 184 09/01 →

3.0 V6t Petrol 147 01/98 →

9-5 Station wagon (YS3E)

2.0 T Petrol 110 10/98 →

2.2 TiD Diesel 88 03/02 →

2.3 t Petrol 125 10/98 →

2.3 t Petrol 136 01/01 →

2.3 Turbo Petrol 169 10/99 → 09/01

2.3 Turbo Petrol 184 09/01 →

3.0 V6t Petrol 147 10/98 →

VAUXHALL

AGILA Mk I (A)

1.0 12V Petrol 43 09/00 → 08/03

1.2 16V Petrol 55 09/00 → 06/04

SPA103



KW



VAUXHALL

ASTRA Mk IV (G) 2 volumi /Coda spiovente

1.2 16V Petrol 48 02/98 → 09/00

1.2 16V Petrol 55 09/00 → 05/05

1.4 16V Petrol 66 02/98 → 08/00

1.6 Petrol 55 02/98 → 09/00

1.6 16V Petrol 74 02/98 → 05/05

2.0 DI Diesel 60 02/98 → 08/00

2.0 DTI 16V Diesel 74 09/00 → 05/05

2.0 SRI Turbo Petrol 141 07/02 → 05/05

ASTRA Mk IV (G) Cabriolet

2.0 Turbo Petrol 141 03/02 → 08/05

ASTRA Mk IV (G) Coupé (F67)

2.0 16V Turbo Petrol 140 09/00 → 08/05

ASTRA Mk IV (G) Station wagon

1.2 16V Petrol 48 02/98 → 09/00

1.2 16V Petrol 55 09/00 → 05/05

1.4 16V Petrol 66 02/98 → 08/00

1.6 Petrol 55 03/98 → 04/04

1.6 16V Petrol 74 03/98 → 08/00

2.0 DI Diesel 60 03/98 → 08/00

2.0 DTI 16V Diesel 74 09/00 → 04/04

ASTRA Mk IV (G) Tre volumi

1.2 16V Petrol 48 09/98 → 09/00

1.2 16V Petrol 55 09/00 → 05/05

1.4 16V Petrol 66 09/98 → 08/00

1.6 Petrol 55 09/98 → 09/00

1.6 16V Petrol 74 09/98 → 05/05

2.0 DI Diesel 60 02/98 → 07/04

2.0 DTI 16V Diesel 74 09/00 → 07/04

ASTRA Mk V (H) 2 volumi /Coda spiovente

1.4 Petrol 66 01/04 → 05/09

2.0 Turbo Petrol 147 01/04 → 05/09

2.0 Turbo Petrol 177 01/04 → 09/05

ASTRA Mk V (H) Station wagon

1.4 Petrol 66 08/04 → 03/09

2.0 Turbo Petrol 125 08/04 → 10/10

2.0 Turbo Petrol 147 08/04 → 10/10

ASTRAVAN Mk IV (G)

1.6 i Petrol 55 08/98 → 09/00

2.0 DI Diesel 60 08/98 → 08/00

2.0 DTI Diesel 74 04/04 → 08/05

COMBO Mk II (C) Cassone / Furgonato / Promiscuo (F25)

1.4 i 16V Petrol 66 09/04 → 11/11

CORSA Mk I (B)

1.2 i 16V Petrol 48 03/98 → 09/00

SPA103

KW

VAUXHALL
CORSA Mk II (C) (W5L, F08)

1.0 12V	Petrol	43	09/00 → 08/03
1.2 16V	Petrol	55	09/00 → 06/04
1.2 16V Dualfuel	Petrol/ LPG	55	08/01 → 06/04

CORSAVAN Mk II (C)

1.2 16V	Petrol	55	09/00 → 08/04
1.2 16V Dualfuel	Petrol/ LPG	55	08/01 → 08/04

FRONTERA Mk II (B)

2.2 DTI	Diesel	85	10/98 → 09/04	ENGINE: 3V500001 →
---------	--------	----	---------------	--------------------

OMEGA (B)

2.0 DTI 16V	Diesel	74	01/98 → 08/00
-------------	--------	----	---------------

OMEGA (B) Station wagon

2.0 DTI 16V	Diesel	74	01/98 → 08/00
-------------	--------	----	---------------

SINTRA

2.2 i 16 V	Petrol	104	11/96 → 04/99
3.0 i 24V	Petrol	148	11/96 → 04/99

TIGRA TwinTop

1.4	Petrol	66	06/04 → 08/09
-----	--------	----	---------------

VECTRA (B)

2.0 DI 16V	Diesel	60	08/95 → 07/00
------------	--------	----	---------------

VECTRA (B)

2.0 DTI 16V	Diesel	74	09/97 → 08/01
2.2 DTI 16V	Diesel	92	08/95 → 08/01
2.6 i V6	Petrol	125	09/00 → 08/01

VECTRA (B) 2 volumi /Coda spiovente

2.0 DI 16V	Diesel	60	08/95 → 07/00
2.0 DTI 16V	Diesel	74	09/97 → 08/01
2.2 DTI 16V	Diesel	92	08/95 → 08/01
2.6 i V6	Petrol	125	09/00 → 08/01

VECTRA (B) Station wagon

2.0 DI 16V	Diesel	60	08/95 → 07/00
2.0 DTI 16V	Diesel	74	09/97 → 08/00
2.2 DTI 16V	Diesel	92	08/95 → 08/01
2.6 i V6	Petrol	125	09/00 → 08/01

VECTRA Mk II (C) Station wagon

3.2 V6	Petrol	155	10/03 → 08/05
--------	--------	-----	---------------

VX220

2.0 i Turbo	Petrol	147	03/01 → 07/05
-------------	--------	-----	---------------

ZAFIRA Mk I (A) (F75)

1.6 16V	Petrol	74	04/99 → 08/99
2.0 DI 16V	Diesel	60	10/99 → 08/00
2.0 DTI 16V	Diesel	74	04/99 → 06/05
2.0 GSI Turbo	Petrol	141	09/01 → 05/05

SPA104
F1
**SENSORE TEMPERATURA REFRIGERANTE
COOLANT TEMPERATURE SENSOR**

KW

ALFA ROMEO
145 (930)

1.6 i.e.	Petrol	76	10/94 → 12/96	ENGINE: → D16Y3-E199999
1.7 i.e. 16V	Petrol	95	10/94 → 12/96	

146 (930)

1.6 i.e.	Petrol	76	12/94 → 12/96	ENGINE: → D16Y3-E199999
1.7 i.e. 16V	Petrol	95	12/94 → 12/96	

155 (167)

1.7 T.S. (167.A4D, 167.A4H)	Petrol	85	04/93 → 04/96	
1.8 T.S.	Petrol	95	02/92 → 06/93	
1.8 T.S. Sport (167.A4A, 167.A4C, 167.A4E)	Petrol	93	01/92 → 12/96	
2.0 T.S. (167.A2)	Petrol	106	02/92 → 04/93	
2.0 T.S. (167.A2A)	Petrol	104	01/93 → 02/95	
2.0 T.S. 16V (167.A2G)	Petrol	110	03/95 → 12/96	

164 (164)

2.0 T.S. (164.H3)	Petrol	106	09/92 → 09/98	
2.0 Turbo	Petrol	128	10/87 → 12/92	
3.0 24V (164.K1)	Petrol	155	09/92 → 09/98	
3.0 24V Q4 (164.K1M, 164.K1C)	Petrol	170	02/94 → 09/98	
3.0 i.e. QV (164.AG)	Petrol	147	09/90 → 09/92	
3.0 V6 (164.A)	Petrol	141	06/87 → 09/92	
3.0 V6 (164.AD, 164.AH, 164.AB)	Petrol	135	06/87 → 09/92	

SPA104



KW



ALFA ROMEO

33 (907A)

1.4 i.e. (907.A3A,
907.A3B) Petrol 65 06/91 → 09/941.4 i.e. (907.A3A,
907.A3B) Petrol 66 06/91 → 09/94

1.5 i.e. Petrol 71 01/90 → 09/94

1.5 i.e. (907A2A) Petrol 74 07/90 → 08/91

1.7 16V
(907.A1B) Petrol 101 01/90 → 03/921.7 16V
(907.A1C) Petrol 95 01/90 → 09/941.7 16V
(907.A1C) Petrol 97 01/90 → 03/921.7 16V 4x4
(907.A1G) Petrol 97 01/90 → 09/941.7 16V 4x4
(907A1F) Petrol 101 01/90 → 09/94

1.7 i.e. (907.A1A) Petrol 77 04/92 → 09/94

1.7 i.e. (907.A1A) Petrol 79 01/90 → 09/94

1.7 i.e. 4x4 Petrol 79 01/90 → 03/92

33 Sportwagon (907B)

1.4 i.e. Petrol 65 06/91 → 09/94

1.4 i.e. Petrol 66 06/91 → 09/94

1.4 i.e. 4x4 Petrol 66 06/91 → 09/94

1.5 i.e. Petrol 71 01/90 → 09/94

1.7 16V Petrol 101 01/90 → 03/92

1.7 16V (907.
B1G) Petrol 95 01/90 → 09/941.7 16V (907.
B1G) Petrol 97 01/90 → 09/941.7 16V 4x4
(907.B1H) Petrol 95 01/90 → 09/94

33 Sportwagon (907B)

1.7 16V 4x4
(907.B1H) Petrol 97 01/90 → 03/92

1.7 i.e. (907.B1A) Petrol 77 04/92 → 09/94

33 Sportwagon (907B)

1.7 i.e. (907.B1A) Petrol 79 01/90 → 03/92

1.7 i.e. 4x4
(907.B1E) Petrol 79 01/90 → 03/92

75 (162B)

2.0 T.S. (162.B4A)
Cat. Petrol 109 01/88 → 02/922.0 T.S. (162.4CB,
162.B4, 162.B4A) Petrol 107 01/88 → 02/92

SPA104



KW



ALFA ROMEO

75 (162B)

2.0 T.S. (162.B4A) Petrol 109 01/88 → 12/88

3.0 V6 (162.B6A) Petrol 136 01/88 → 12/90

3.0 V6 (162.B6A)
Cat. Petrol 136 01/88 → 12/91

3.0 V6 (162.B6C) Petrol 141 02/90 → 12/91

GTV (916C_)

2.0 T.SPARK
16V (916.C2_,
916C2C00) Petrol 110 06/95 → 10/05

RZ

3.0 V6 Zagato Petrol 152 01/92 → 12/93

SPIDER (115)

2000 Petrol 88 01/90 → 12/93

SPIDER (916S_)

2.0 T.SPARK
16V (916S2C00) Petrol 110 06/95 → 04/05

3.0 V6 (916S1) Petrol 141 06/95 → 04/05

SZ

3.0 V6 Zagato Petrol 152 01/89 → 12/91

BMW

3 (E30)

316 (Ecotronic) Petrol 66 09/83 → 12/90

316 i Petrol 73 09/87 → 06/91

316 i Petrol 75 07/88 → 06/91

318 i Petrol 83 09/87 → 06/91

318 i Petrol 85 09/87 → 06/91

318 i Petrol 75 12/84 → 08/88

318 i Petrol 77 09/82 → 08/87

320 i Petrol 110 12/85 → 06/90

320 i Petrol 92 09/82 → 12/85

320 i Petrol 95 12/85 → 06/91

323 i Petrol 110 09/84 → 08/86

325 e 2.7 Petrol 90 12/86 → 12/88

325 e 2.7 Petrol 95 12/86 → 08/87

325 i Petrol 125 12/86 → 06/91

325 i Petrol 126 12/86 → 11/89

325 i X Petrol 125 12/86 → 08/91

325 i X Petrol 126 03/86 → 12/87

M3 2.3 Petrol 143 07/86 → 06/91

M3 2.3 Petrol 147 02/87 → 05/89

M3 2.3 Petrol 158 06/89 → 06/91

SPA104

BMW
3 (E36)

316 i	Petrol	73	09/90 → 09/93
316 i	Petrol	75	09/90 → 09/93
316 i	Petrol	75	07/93 → 09/95
318 i	Petrol	83	12/90 → 10/93
318 i	Petrol	85	10/93 → 09/95
318 is	Petrol	103	03/93 → 02/98
320 i	Petrol	110	09/90 → 09/95
M3 3.0	Petrol	210	08/94 → 09/95

3 Cabriolet (E30)

318 i	Petrol	83	09/90 → 10/93
320 i	Petrol	95	04/86 → 10/93
325 i	Petrol	125	09/87 → 10/93
325 i	Petrol	126	12/86 → 12/87

3 Cabriolet (E36)

318 i	Petrol	85	01/94 → 09/95
325 i	Petrol	141	03/93 → 03/95

3 Compact (E36)

316 i	Petrol	75	03/94 → 09/95
318 ti	Petrol	103	11/94 → 08/95

3 Coupé (E36)

316 i	Petrol	75	09/93 → 09/95
318 is	Petrol	103	03/92 → 10/95
320 i	Petrol	110	03/92 → 09/95
M3 3.0	Petrol	210	10/92 → 01/95
M3 3.0	Petrol	217	01/95 → 10/95

3 Touring (E30)

316 i	Petrol	73	09/91 → 06/94
316 i	Petrol	75	09/91 → 06/94
318 i	Petrol	83	04/89 → 06/94
318 i	Petrol	85	09/87 → 06/91
320 i	Petrol	95	01/88 → 12/91
325 i	Petrol	125	07/87 → 03/93
325 i X	Petrol	125	06/88 → 10/93

3 Touring (E36)

318 i	Petrol	85	07/95 → 09/95
-------	--------	----	---------------

5 (E28)

518	Petrol	66	06/81 → 08/84
520 i	Petrol	110	12/86 → 12/87
520 i	Petrol	92	06/81 → 12/87
520 i	Petrol	95	08/85 → 12/87
525 e	Petrol	90	09/81 → 12/87
525 e	Petrol	92	05/83 → 12/87
525 e	Petrol	95	12/84 → 12/87
535 i, M 535 i	Petrol	136	01/85 → 12/87

SPA104

BMW
5 (E28)

535 i, M 535 i	Petrol	141	01/85 → 12/87
535 i, M 535 i	Petrol	160	01/85 → 12/87

5 (E34)

518 i	Petrol	83	08/89 → 09/95
518 i	Petrol	85	08/89 → 09/95
520 i	Petrol	95	01/88 → 08/91
520 i 24V	Petrol	110	09/89 → 09/95
525 i	Petrol	125	01/88 → 08/91
525 i 24V	Petrol	141	09/89 → 09/95
525 iX 24V	Petrol	141	10/91 → 09/95
530 i	Petrol	138	01/88 → 08/91
535 i	Petrol	155	01/88 → 09/95
M 3.6	Petrol	232	10/88 → 05/92
M 3.6 Cat.	Petrol	232	10/88 → 05/92

5 Touring (E34)

518 g	BiFuel	85	11/95 → 06/96
518 i	Petrol	83	03/93 → 09/94
518 i	Petrol	85	09/94 → 01/97
520 i	Petrol	110	11/91 → 09/95
525 i	Petrol	141	11/91 → 09/95
525 ix	Petrol	141	02/92 → 09/95
M 3.8	Petrol	250	09/94 → 01/97

6 (E24)

635 CSi	Petrol	136	01/85 → 05/89
635 CSi	Petrol	155	08/87 → 05/89
635 CSi	Petrol	160	01/85 → 08/88
M 635 CSi	Petrol	211	03/84 → 05/89

7 (E23)

735 i	Petrol	136	01/85 → 08/86
735 i	Petrol	160	09/79 → 08/86

7 (E32)

730 i,iL	Petrol	138	12/86 → 09/94
730 i,iL	Petrol	145	12/86 → 09/94
735 i,iL	Petrol	155	09/86 → 09/92

7 (E32)

735 i,iL	Petrol	162	09/86 → 12/87
----------	--------	-----	---------------

Z1

2.5	Petrol	125	06/88 → 06/91
-----	--------	-----	---------------

CITROËN
AX (ZA-_)

10	Petrol	33	01/93 → 12/98
10	Petrol	37	01/93 → 12/98
11	Petrol	44	01/93 → 12/97
14	Petrol	55	01/93 → 04/97

SPA104



KW



CITROËN

AX (ZA-_)

14 4x4 Petrol 55 01/93 → 12/96

BX (XB-_)

19 Petrol 70 09/86 → 11/89

16 E Petrol 65 05/89 → 02/93

19 GTi 16V Petrol 108 03/88 → 02/93

BX Break (XB-_)

16 Petrol 65 05/89 → 12/93

C15 (VD-_)

1.4 i Petrol 55 05/91 → 12/96

JUMPY Furgonato (BS_, BT_, BY_, BZ_)

1.6 i Petrol 58 10/95 →

XM (Y3)

2.0 i Petrol 89 05/89 → 06/94

3.0 V6 Petrol 123 05/89 → 06/94

3.0 V6 24V Petrol 147 07/90 → 06/94

ZX (N2)

1.1 Petrol 44 09/95 → 06/97

1.4 i Petrol 55 09/95 → 06/97

1.9 i Petrol 88 03/91 → 06/97

ZX Break (N2)

1.4 i Petrol 55 09/95 → 10/97

FIAT

BRAVO I (182)

2.0 HGT 20V (182AQ) Petrol 113 07/98 → 10/01

CROMA (154)

2000 i.e. (154.AD) Petrol 88 01/91 → 09/92

2000 i.e. (154.AM) Petrol 83 03/86 → 09/90

2000 i.e. (154.AM, 154.LM) Petrol 85 01/91 → 08/96

2000 i.e. Turbo (154.AM) Petrol 114 12/85 → 06/90

2000 i.e. Turbo (154.AM, 154.LM) Petrol 110 01/91 → 08/96

FIORINO Pick up (146)

1.4 Petrol 49 05/94 → 05/01

1.6 Petrol 55 01/94 → 05/01

MAREA (185)

2.0 155 20V Petrol 113 04/99 → 01/01

MAREA Weekend (185)

2.0 155 20V Petrol 113 04/99 → 02/03

SPA104



KW



FIAT

PANDA (141A_)

1000 Petrol 32 01/86 → 12/91

1000 Petrol 37 01/85 → 12/91

1100 Petrol 37 05/91 → 12/99

1000 4x4 Petrol 37 01/91 → 12/92

1000 i.e. Cat. Petrol 33 10/87 → 12/91

1100 Trekking 4x4 Petrol 37 10/91 → 12/95

PANDA Van (141_)

1000 Petrol 32 01/91 → 12/91

SCUDO Furgonato (220L)

1.6 Petrol 58 02/96 → 12/06

TIPO (160)

1.4 i.e. Petrol 57 05/89 → 12/93 ENGINE: → 1125932

1.4 i.e. (160.AP, 160.AD, 160.EA) Petrol 51 05/89 → 04/95 ENGINE: → 1125932

1.6 i.e. (160.AF) Petrol 57 07/90 → 01/93 ENGINE: → 1125932

UNO (146A/E)

1.3 Turbo i.e. Petrol 74 09/89 → 03/91

1.4 Turbo i.e. Petrol 82 09/89 → 09/93

75 i.e. 1.5 Petrol 55 01/89 → 12/92

HYUNDAI

S COUPE (SLC)

1.5 i Petrol 65 04/92 → 05/96

ISUZU

TROOPER Fuoristrada aperto (UBS)

2.6 i (UBS17) Petrol 85 10/87 → 12/91

IVECO

DAILY II Cassone / Furgonato / Promiscuo

35-10 (12974212, 12974217, 13014111, 13014131, 13014204...) Diesel 76 06/96 → 08/98

35-10 (12974212, 12974217, 13014111, 13014131, 13014204...) Diesel 80 06/96 → 08/98

DAILY II Pianale piatto/Telaio

35-10 (12971112, 12971212, 12971312, 12971317, 12976112...) Diesel 68 07/92 → 12/96

SPA104

IVECO
DAILY II Pianale piatto/Telaio

35-10 (12971112, 12971212, 12971312, 12971317, 12976112...)	Diesel	76	07/92 → 12/96
--	--------	----	---------------

LANCIA
KAPPA (838A)

2.0 16V Turbo (838AB1AA)	Petrol	151	02/95 → 10/01
2.0 20V (838AA1AA)	Petrol	107	10/94 → 12/96
2.4 20V (838AC1AA, 838AC11A)	Petrol	129	08/94 → 10/01
3.0 24V (838AD1AA, 838AD11A, 838XD1AA, 838ZD1AA)	Petrol	150	08/94 → 10/01

THEMA (834)

2000 i.e. (834AB)	Petrol	86	09/88 → 05/92
2000 i.e. (834BV)	Petrol	85	09/87 → 05/92
2000 i.e. 16V (834AA)	Petrol	108	05/88 → 08/92
2000 i.e. 16V (834AI)	Petrol	104	02/89 → 05/92
2000 i.e. 16V Turbo (834AL)	Petrol	130	04/89 → 05/92
2000 i.e. Turbo (834CV)	Petrol	110	01/88 → 05/90
2500 Turbo DS (834AE)	Diesel	85	06/88 → 05/92
2500 Turbo DS (834AM)	Diesel	77	05/88 → 07/92
3000 V6 (834GD, 834FD)	Petrol	126	08/92 → 07/94

THEMA SW (834)

2000 16V (834FA)	Petrol	112	05/92 → 07/94
2000 i.e. 16V (834AA)	Petrol	108	05/89 → 08/92
2000 i.e. 16V (834AI)	Petrol	104	02/89 → 05/92
2000 i.e. 16V Turbo (834AC)	Petrol	133	12/88 → 06/90

SPA104

LANCIA
THEMA SW (834)

2000 i.e. 16V Turbo (834AL)	Petrol	130	04/89 → 03/93
2000 Turbo	Petrol	110	01/89 → 03/92
2500 Turbo DS (834AE)	Diesel	85	06/88 → 05/92
2500 Turbo DS (834AM)	Diesel	77	05/88 → 07/92
3000 V6 (834GD, 834FD)	Petrol	126	09/92 → 07/94

Y (840A)

1.4 12V (840AC)	Petrol	55	03/96 → 09/03
-----------------	--------	----	---------------

Y10 (156)

1.0 Fire	Petrol	37	03/85 → 02/90
1.0 Fire (156AA)	Petrol	33	03/85 → 06/89
1.0 Fire (156AE) Cat.	Petrol	33	10/87 → 02/92
1.0 Fire (156B, 156AD)	Petrol	32	06/85 → 06/91
1.0 Fire (156C)	Petrol	41	03/85 → 07/89
1.0 Fire Trazione integrale	Petrol	37	12/87 → 02/90
1.0 Fire Trazione integrale (156AE)	Petrol	33	12/87 → 02/92
1.1 i.e. Fire (156AG)	Petrol	37	07/89 → 09/95

LAND ROVER
DISCOVERY I (LJ, LG)

2.5 TDI 4x4	Diesel	83	10/89 → 10/98
-------------	--------	----	---------------

DISCOVERY II (LJ, LT)

2.5 Td5 4x4	Diesel	102	01/99 → 06/04
-------------	--------	-----	---------------

OPEL
ASCONA C (81_, 86_, 87_, 88_)

1.8	Petrol	62	09/87 → 08/88
1.8 E	Petrol	74	01/85 → 08/86
1.8 i	Petrol	85	09/82 → 08/86
2.0 i	Petrol	85	09/86 → 08/88
2.0 i GT	Petrol	95	03/87 → 08/88

ASCONA C 2 volumi /Coda spiovente (84_, 89_)

1.8	Petrol	62	09/87 → 08/88
1.8 E	Petrol	74	01/85 → 08/86
1.8 i	Petrol	85	09/82 → 08/86
2.0 i	Petrol	85	09/86 → 08/88
2.0 i GT	Petrol	95	03/87 → 08/88

SPA104



KW



OPEL

ASTRA F (56_, 57_)

1.4	Petrol	60	09/92 → 09/98
1.4 i	Petrol	44	09/91 → 09/98
1.4 i 16V	Petrol	66	02/96 → 09/98
1.4 Si	Petrol	60	03/92 → 09/98
1.6	Petrol	55	09/95 → 09/98
1.6 i	Petrol	52	05/93 → 07/96
1.6 i	Petrol	55	03/92 → 09/98
1.6 i 16V	Petrol	74	08/94 → 09/98
1.6 Si	Petrol	74	05/92 → 12/94
1.8 i	Petrol	66	03/92 → 09/98
2.0 i	Petrol	85	03/92 → 09/98

ASTRA F 2 volumi /Coda spiovente (53_, 54_, 58_, 59_)

1.4	Petrol	60	09/92 → 01/98
1.4 i	Petrol	44	03/92 → 01/98
1.4 i 16V	Petrol	66	01/96 → 01/98
1.4 Si	Petrol	60	03/92 → 01/98
1.6	Petrol	55	09/95 → 01/98
1.6 i	Petrol	52	05/93 → 07/96
1.6 i	Petrol	55	09/91 → 01/98
1.6 i 16V	Petrol	74	08/94 → 01/98
1.6 Si	Petrol	74	03/92 → 12/94
1.8 i	Petrol	66	09/91 → 01/98
2.0 GSI 16V	Petrol	110	09/91 → 01/98
2.0 i	Petrol	85	09/91 → 01/98

ASTRA F Cabriolet (53_B)

1.4 i 16V	Petrol	66	01/96 → 03/01
1.6 i	Petrol	52	03/93 → 08/96
1.6 i	Petrol	55	01/96 → 03/01
2.0 i	Petrol	85	03/93 → 12/93

ASTRA F Station wagon (51_, 52_)

1.4	Petrol	60	09/92 → 01/98
1.4 i	Petrol	44	09/91 → 01/98
1.4 i 16V	Petrol	66	02/96 → 01/98
1.4 Si	Petrol	60	03/92 → 01/98
1.6	Petrol	55	09/95 → 01/98
1.6 i	Petrol	52	05/93 → 07/96
1.6 i	Petrol	55	09/91 → 01/98
1.6 i 16V	Petrol	74	08/94 → 01/98
1.6 Si	Petrol	74	03/92 → 12/94
1.8 i	Petrol	66	09/91 → 01/98
2.0 i	Petrol	85	09/91 → 07/94
2.0 i 16V	Petrol	110	03/93 → 01/98

SPA104



KW



OPEL

ASTRA F Van (55_)

1.4 i	Petrol	44	10/91 → 01/99
1.6 i	Petrol	52	02/93 → 07/96
1.6 i	Petrol	55	10/91 → 04/93

CALIBRA A (85_)

2.0 i	Petrol	85	06/90 → 07/97
2.0 i 16V	Petrol	100	02/94 → 07/97
2.0 i 16V	Petrol	110	06/90 → 02/94
2.0 i 16V 4x4	Petrol	100	02/94 → 07/97
2.0 i 16V 4x4	Petrol	110	06/90 → 02/94
2.0 i 4x4	Petrol	85	06/90 → 07/97
2.0 i Turbo 4x4	Petrol	150	03/92 → 07/97
2.5 i V6	Petrol	125	04/93 → 07/97

CORSA B (73_, 78_, 79_)

1.2 i	Petrol	33	03/93 → 09/00	CHASSIS: →V6999999
1.2 i	Petrol	33	03/93 → 09/00	CHASSIS: →V6999999
1.4 i	Petrol	44	03/93 → 09/00	CHASSIS: →V6999999
1.4 i 16V	Petrol	66	09/94 → 09/00	CHASSIS: →V6999999
1.4 Si	Petrol	60	03/93 → 09/00	CHASSIS: →V6999999
1.6 GSI 16V	Petrol	80	03/93 → 09/00	CHASSIS: →V6999999
1.6 i 16V	Petrol	78	09/94 → 09/00	CHASSIS: →V6999999

FRONTERA A (5_MWL4)

2.4 i (53MWL4)	Petrol	92	03/92 → 10/98
----------------	--------	----	---------------

FRONTERA A Sport (5_SUD2)

2.0 i (52SUD2, 55SUD2)	Petrol	85	03/92 → 10/98
------------------------	--------	----	---------------

KADETT E 2 volumi /Coda spiovente (33_, 34_, 43_, 44_)

2.0 GSI 16V	Petrol	115	12/87 → 08/91
-------------	--------	-----	---------------

KADETT E Cabriolet (43B_)

1.4 i	Petrol	44	01/90 → 08/91
-------	--------	----	---------------

KADETT E Furgonato (37_, 47_)

1.4 i	Petrol	44	01/90 → 08/91
1.6 i	Petrol	55	08/89 → 12/91

OMEGA A (16_, 17_, 19_)

1.8	Petrol	85	09/86 → 03/94
1.8	Petrol	65	09/87 → 03/94
1.8 N	Petrol	60	09/86 → 08/87
1.8 S	Petrol	66	09/86 → 03/94
2.0	Petrol	90	09/86 → 03/94
2.0 i	Petrol	85	09/86 → 03/94
2.4 i	Petrol	92	09/88 → 03/94
2.6 i	Petrol	110	09/90 → 03/94
3.0 (3000)	Petrol	115	03/87 → 12/87
3.0 (3000)	Petrol	130	03/87 → 09/90
3.0 24V (3000)	Petrol	150	09/89 → 03/94

SPA104

OPEL
OMEGA A Station wagon (66_, 67_)

1.8	Petrol	85	09/86 → 03/94
1.8	Petrol	65	09/87 → 03/94
1.8 N	Petrol	60	09/86 → 08/87
1.8 S	Petrol	66	09/86 → 03/94
2.0	Petrol	90	09/86 → 03/94
2.0 i	Petrol	85	09/86 → 03/94
2.4 i	Petrol	92	09/88 → 03/94
2.6 i	Petrol	110	09/90 → 03/94
3.0	Petrol	115	03/87 → 12/88
3.0	Petrol	130	03/87 → 09/90
3.0 Cat.	Petrol	130	03/87 → 12/90

OMEGA B (25_, 26_, 27_)

2.0	Petrol	85	03/94 → 09/99
2.0	Petrol	85	03/94 → 12/00
2.5 V6	Petrol	125	03/94 → 09/00
3.0 V6	Petrol	155	04/94 → 02/01

OMEGA B Station wagon (21_, 22_, 23_)

2.0	Petrol	85	03/94 → 09/99
2.5 V6	Petrol	125	03/94 → 09/00
3.0 V6	Petrol	155	04/94 → 02/01

SENATOR B (29_)

2.5 i	Petrol	103	09/90 → 09/93
2.6 i	Petrol	110	09/90 → 09/93
3.0	Petrol	115	09/87 → 09/93
3.0	Petrol	130	01/88 → 09/90
3.0 24V	Petrol	150	09/89 → 09/93

TIGRA (95_)

1.4 16V	Petrol	66	07/94 → 12/00	CHASSIS: →V6999999
1.6 16V	Petrol	78	07/94 → 08/98	CHASSIS: →V6999999

VECTRA A (86_, 87_)

1.6 i	Petrol	55	01/95 → 11/95
-------	--------	----	---------------

VECTRA B (36_)

1.6 i	Petrol	55	10/95 → 04/02
1.6 i 16V	Petrol	74	10/95 → 04/02
2.5 i V6	Petrol	125	10/95 → 09/00

VECTRA B 2 volumi /Coda spiovente (38_)

1.6 i	Petrol	55	10/95 → 07/03
1.6 i 16V	Petrol	74	10/95 → 07/02
2.5 i V6	Petrol	125	10/95 → 09/00

PEUGEOT
106 I (1A, 1C)

1.0	Petrol	33	09/91 → 04/96
1.0	Petrol	37	09/91 → 04/96
1.1	Petrol	44	09/91 → 12/92

SPA104

PEUGEOT
106 I (1A, 1C)

1.4	Petrol	55	01/92 → 04/96
1.6	Petrol	76	01/94 → 04/96
1.6	Petrol	65	06/93 → 04/96

205 I Cabriolet (741B, 20D)

1.1 CJ	Petrol	44	10/89 → 12/90
--------	--------	----	---------------

205 II (20A/C)

1.1	Petrol	44	07/89 → 12/90
1.4	Petrol	55	07/88 → 12/90

306 (7B, N3, N5)

1.1	Petrol	44	06/94 → 12/97
1.4 SL	Petrol	55	06/94 → 12/97
1.6 SR	Petrol	65	06/94 → 12/97

306 2 volumi /Coda spiovente (7A, 7C, N3, N5)

1.1	Petrol	44	05/93 → 12/97
1.4	Petrol	55	05/93 → 12/97
1.6	Petrol	65	05/93 → 12/97

306 Break (7E, N3, N5)

1.6	Petrol	65	03/97 → 12/97
-----	--------	----	---------------

309 I (10C, 10A)

1.4	Petrol	55	03/89 → 07/89
1.6	Petrol	76	11/85 → 09/88
1.9	Petrol	72	03/86 → 07/89
1.9	Petrol	80	07/88 → 07/89
1.9 GTI	Petrol	88	07/88 → 07/89
1.9 GTI	Petrol	94	10/86 → 07/89

309 II (3C, 3A)

1.1	Petrol	44	08/90 → 12/93
1.4	Petrol	55	07/89 → 12/93
1.6	Petrol	65	07/89 → 12/93
1.9	Petrol	72	08/89 → 12/93
1.9	Petrol	80	10/90 → 12/93
1.9 GTI	Petrol	88	07/89 → 12/93
1.9 GTI 16V	Petrol	116	08/89 → 07/90

405 I (15B)

1.4	Petrol	47	01/87 → 07/92
1.9	Petrol	88	07/88 → 12/92
1.9	Petrol	80	07/88 → 12/92
1.9 4x4	Petrol	80	07/88 → 12/92
1.9 Injection	Petrol	77	07/87 → 12/92
1.9 Sport MI-16	Petrol	108	04/88 → 12/92
1.9 Sport MI-16	Petrol	116	07/87 → 11/91
1.9 SPort MI-16 4x4	Petrol	108	04/88 → 12/92

SPA104



KW



PEUGEOT

405 I Break (15E)

1.9	Petrol	77	10/88 → 08/92
1.9	Petrol	88	10/88 → 08/92
1.9	Petrol	80	10/88 → 08/92
1.9 4x4	Petrol	80	10/88 → 08/92

ROVER

200 (RF)

220 SDi	Diesel	77	11/95 → 03/00
---------	--------	----	---------------

400 2 volumi /Coda spiovente (RT)

420 Di	Diesel	77	05/95 → 03/00
--------	--------	----	---------------

600 (RH)

620 Sdi	Diesel	77	12/94 → 02/99
---------	--------	----	---------------

SAAB

9000

2.0 -16 CD	Petrol	96	09/93 → 12/98
2.0 -16 CD	Petrol	110	09/93 → 12/98
2.0 -16 Turbo	Petrol	118	05/88 → 08/93
2.0 -16 Turbo CD	Petrol	108	09/92 → 12/98
2.0 -16 Turbo CD	Petrol	120	09/88 → 08/93
2.0 -16 Turbo CD	Petrol	136	09/89 → 12/98
2.3 -16 CD	Petrol	107	01/90 → 12/98
2.3 -16 CD Turbo	Petrol	147	07/90 → 12/98
2.3 -16 CDE	Petrol	108	09/93 → 12/98
2.3 -16 CDE Eco-Power	Petrol	125	09/93 → 12/98
2.3 -16 Turbo	Petrol	143	09/90 → 08/93

9000 2 volumi /Coda spiovente

2.0 -16	Petrol	94	12/85 → 08/88
2.0 -16	Petrol	92	12/85 → 12/88
2.0 -16 CS	Petrol	96	09/93 → 12/98
2.0 -16 CS	Petrol	94	01/89 → 12/98
2.0 -16 ND Turbo	Petrol	110	09/93 → 12/98
2.0 -16 Turbo	Petrol	118	09/84 → 08/93
2.0 -16 Turbo	Petrol	120	05/88 → 08/93
2.0 -16 Turbo	Petrol	129	09/84 → 12/91
2.0 -16 Turbo CS	Petrol	136	09/88 → 12/98
2.3 -16 Aero CS	Petrol	162	02/93 → 12/98
2.3 -16 Aero CS	Petrol	165	02/93 → 12/98
2.3 -16 CS	Petrol	107	01/90 → 12/98
2.3 -16 CSE	Petrol	108	09/93 → 12/98
2.3 -16 CSE Eco Power	Petrol	125	09/93 → 12/98
2.3 -16 Turbo	Petrol	143	09/90 → 12/98
2.3 -16 Turbo CSE	Petrol	147	09/93 → 12/98

SPA104



KW



SEAT

TOLEDO I (1L)

1.9 TDI	Diesel	66	08/95 → 03/99
---------	--------	----	---------------

SKODA

FAVORIT (781)

1.3 (781)	Petrol	50	01/94 → 09/94
1.3 135 (781)	Petrol	42	12/91 → 09/94
1.3 135 (781)	Petrol	43	12/91 → 09/94
1.3 135 (781)	Petrol	44	10/90 → 09/94
1.3 135 X,LX,GLX (781)	Petrol	40	01/90 → 09/94
1.3 135L (781)	Petrol	43	05/89 → 09/94
1.3 136 (781)	Petrol	45	10/90 → 09/94

FAVORIT Forman (785)

1.3	Petrol	50	01/94 → 06/95
1.3 (135 E)	Petrol	40	09/91 → 06/95
1.3 (135)	Petrol	44	12/91 → 06/95
1.3 (136)	Petrol	45	01/93 → 06/95

FELICIA I (6U1)

1.3	Petrol	40	10/94 → 03/98
1.3	Petrol	43	10/94 → 03/98
1.3	Petrol	50	10/94 → 03/98
1.6 LX	Petrol	55	08/95 → 03/98

FELICIA I Fun (797)

1.3	Petrol	40	06/97 → 04/02
1.3	Petrol	50	06/97 → 04/02
1.6	Petrol	55	06/97 → 04/02

FELICIA I Station wagon (6U5)

1.3	Petrol	43	08/95 → 03/98
1.3 LX	Petrol	40	08/95 → 03/98
1.3 LXI	Petrol	50	08/95 → 03/98
1.6 GLX	Petrol	55	08/95 → 03/98

VAUXHALL

ASTRA Mk II Belmont

1.4 i	Petrol	44	01/90 → 12/91
1.6 S	Petrol	60	01/89 → 12/91
1.8	Petrol	82	01/86 → 12/90

ASTRA Mk III (F)

1.4 i	Petrol	44	04/92 → 09/98
1.4 i	Petrol	60	04/92 → 09/98
1.6 i	Petrol	55	03/92 → 09/98
1.6 i	Petrol	74	05/92 → 12/94
1.8 i	Petrol	66	03/92 → 09/98
2.0 i	Petrol	85	03/92 → 09/98

SPA104

VAUXHALL
ASTRA Mk III (F) 2 volumi /Coda spiovente

1.4 i	Petrol	44	09/91 → 02/98
1.4 i	Petrol	60	03/92 → 02/98
1.6 i	Petrol	55	09/91 → 02/98
1.6 i	Petrol	74	03/92 → 02/98
1.8 i	Petrol	66	09/91 → 02/98
2.0 i	Petrol	85	09/91 → 02/98
2.0 i 16V	Petrol	110	09/91 → 02/98

ASTRA Mk III (F) Cabriolet

1.4 i	Petrol	60	05/93 → 03/01
2.0 i	Petrol	85	03/93 → 10/94

ASTRA Mk III (F) Station wagon

1.4 i	Petrol	44	09/91 → 02/98
1.4 i	Petrol	60	03/91 → 02/98
1.6 i	Petrol	55	09/91 → 02/98
1.6 Si	Petrol	74	03/91 → 12/94
1.8 i	Petrol	66	09/91 → 02/98
2.0 i	Petrol	85	09/91 → 02/98

ASTRAVAN Mk III (F)

1.4 i	Petrol	44	01/91 → 10/94
1.6 i	Petrol	55	01/91 → 08/98

CARLTON Mk III

1.8	Petrol	65	09/87 → 03/94
1.8 i	Petrol	85	01/87 → 03/94
2.0 i	Petrol	90	01/87 → 03/94
3.0 3000	Petrol	130	03/87 → 09/90
3.0 3000 24V	Petrol	150	09/89 → 03/94

CARLTON Mk III Station wagon

1.8	Petrol	65	09/87 → 03/94
1.8 i	Petrol	85	01/87 → 03/94
2.0 i	Petrol	90	01/87 → 03/94

FRONTERA Mk I (A)

2.4 i	Petrol	92	03/92 → 10/98
-------	--------	----	---------------

FRONTERA Mk I (A) Sport

2.0 i	Petrol	85	03/92 → 10/98
-------	--------	----	---------------

SENATOR Mk II (B)

2.5 i	Petrol	103	09/87 → 10/90
2.6 i	Petrol	110	09/90 → 09/93
3.0	Petrol	115	09/87 → 09/93
3.0	Petrol	130	01/88 → 09/90
3.0 24V	Petrol	150	09/89 → 09/93
3.0 i Cat.	Petrol	130	01/88 → 09/93

TIGRA Mk I (F07)

1.4 16V	Petrol	66	07/94 → 12/00	CHASSIS: →V6999999
1.6 16V	Petrol	78	07/94 → 12/00	CHASSIS: →V6999999

SPA104

VOLKSWAGEN
GOLF III (1H1)

1.9 TDI	Diesel	66	09/93 → 08/97
---------	--------	----	---------------

VOLVO
740 (744)

2.3	Petrol	83	09/85 → 12/89
2.3	Petrol	84	08/84 → 07/90
2.3	Petrol	85	08/87 → 12/90

740 Kombi (745)

2.3	Petrol	83	08/85 → 12/89
2.3	Petrol	85	08/87 → 12/90
2.3 Turbo	Petrol	115	08/86 → 07/89
2.3 Turbo	Petrol	121	08/89 → 07/90

SPA105
F1 **SENSORE TEMPERATURA REFRIGERANTE**
COOLANT TEMPERATURE SENSOR

AUDI
80 (8C, B4)

1.9 TD	Diesel	55	09/91 → 12/94
1.9 TDI	Diesel	66	09/91 → 12/94

80 Avant (8C, B4)

1.9 TDI	Diesel	66	07/92 → 12/94
---------	--------	----	---------------

FORD
GALAXY (WGR)

2.8 i V6	Petrol	128	11/95 → 04/00
2.8 i V6 4x4	Petrol	128	04/96 → 04/00
2.8 V6	Petrol	150	04/00 → 05/06

SEAT
IBIZA II (6K1)

1.3 i	Petrol	40	03/93 → 12/96
-------	--------	----	---------------

SPA105



KW



SEAT

TOLEDO I (1L)

1.6 i	Petrol	52	05/91 → 12/93
1.6 i	Petrol	54	05/91 → 03/99
1.8 16V	Petrol	92	05/91 → 12/94
1.8 16V	Petrol	98	05/91 → 12/93
1.8 i	Petrol	65	05/91 → 12/94
1.8 i	Petrol	66	11/93 → 12/94
2.0 i	Petrol	85	01/93 → 03/99

VOLKSWAGEN

CADDY I (14)

1.5	Petrol	51	08/82 → 07/83
1.6	Petrol	55	01/83 → 07/92
1.6	Petrol	55	10/82 → 10/83
1.6 D	Diesel	40	08/82 → 07/92
1.8	Petrol	70	08/85 → 07/92

CORRADO (53I)

1.8 G60	Petrol	118	09/88 → 09/93
---------	--------	-----	---------------

GOLF II (19E, 1G1)

1.0	Petrol	37	01/89 → 10/91
1.6	Petrol	51	01/89 → 12/92
1.6	Petrol	53	01/89 → 10/91
1.6	Petrol	55	01/89 → 07/92
1.6 D	Diesel	37	01/89 → 10/91

GOLF II (19E, 1G1)

1.6 D	Diesel	40	01/89 → 10/91
1.6 TD	Diesel	51	01/89 → 10/91
1.8	Petrol	62	01/89 → 01/90
1.8 GTI 16V	Petrol	95	01/89 → 10/91
1.8 GTI Cat.	Petrol	79	01/89 → 10/91
1.8 GTI G60	Petrol	118	04/90 → 07/91
1.8 GTI G60 Syncro	Petrol	118	01/89 → 12/91
1.8 Syncro	Petrol	66	01/89 → 07/91

GOLF III (1H1)

1.8 Syncro (1HX1)	Petrol	66	01/94 → 08/97
1.9 TD, GTD	Diesel	55	11/91 → 08/97
2.0	Petrol	85	07/94 → 08/97

GOLF III Cabriolet (1E7)

1.9 TDI	Diesel	66	08/95 → 05/98
2.0	Petrol	85	07/94 → 05/98

GOLF III Variant (1H5)

1.8	Petrol	66	01/94 → 04/99
1.9 TD	Diesel	55	07/93 → 04/99
1.9 TDI	Diesel	66	03/94 → 04/99
2.0	Petrol	85	07/94 → 04/99

SPA105



KW



VOLKSWAGEN

JETTA II (19E, 1G2, 165)

1.6	Petrol	51	01/89 → 10/91
1.6	Petrol	53	01/89 → 10/91
1.6	Petrol	55	01/89 → 07/92
1.6 D	Diesel	40	01/89 → 10/91
1.6 TD	Diesel	51	01/89 → 10/91
1.6 TD	Diesel	59	04/89 → 10/91
1.8	Petrol	62	01/89 → 01/90
1.8 16V	Petrol	95	01/89 → 10/91
1.8 Cat.	Petrol	79	01/89 → 10/91

LT 28-35 I Furgonato (281-363)

2.4 i	Petrol	69	03/94 → 06/96	CHASSIS: 21P000001 →
-------	--------	----	---------------	-------------------------

LT 28-35 I Pianale piatto/Telaio (281-363)

2.4 i	Petrol	69	03/94 → 06/96	CHASSIS: 21P000001 →
-------	--------	----	---------------	-------------------------

LT 40-55 I Furgonato (291-512)

2.4 i	Petrol	69	01/93 → 06/96	CHASSIS: 21P000001 →
-------	--------	----	---------------	-------------------------

LT 40-55 I Pianale piatto/Telaio (293-909)

2.4 i	Petrol	69	03/94 → 06/96	CHASSIS: 21P000001 →
-------	--------	----	---------------	-------------------------

PASSAT (32B)

1.6	Petrol	51	08/87 → 03/88	CHASSIS: 32J000001 →
1.6	Petrol	53	01/88 → 03/88	CHASSIS: 32J000001 →
1.6	Petrol	55	01/86 → 03/88	CHASSIS: 32J000001 →
1.6 D	Diesel	40	01/86 → 03/88	CHASSIS: 32J000001 →
1.6 TD	Diesel	51	01/86 → 03/88	CHASSIS: 32J000001 →
1.8	Petrol	66	01/86 → 03/88	CHASSIS: 32J000001 →

PASSAT (3A2, 35I)

1.6	Petrol	53	02/88 → 09/91
1.6	Petrol	55	02/88 → 12/88
1.6	Petrol	74	10/94 → 08/96
1.6 TD	Diesel	59	08/88 → 09/93
1.8	Petrol	55	08/90 → 08/96
1.8	Petrol	66	02/88 → 08/96
1.8	Petrol	79	04/88 → 07/93
1.8	Petrol	82	04/88 → 07/92
1.9 D	Diesel	50	05/89 → 10/93

SPA105

VOLKSWAGEN
PASSAT (3A2, 35I)

1.9 TD	Diesel	55	03/91 → 08/96
1.9 TDI	Diesel	66	10/93 → 08/96
1.9 TDI	Diesel	81	03/96 → 08/96
2.0	Petrol	79	03/95 → 08/96
2.0	Petrol	85	02/90 → 08/96
2.0 16V	Petrol	110	01/94 → 08/96
2.8 VR6	Petrol	128	06/91 → 08/96

PASSAT Tre volumi (32B)

1.6	Petrol	53	01/88 → 03/88	CHASSIS: 32J000001 →
1.6	Petrol	55	01/86 → 03/88	CHASSIS: 32J000001 →
1.6 TD	Diesel	51	01/86 → 03/88	CHASSIS: 32J000001 →
1.8	Petrol	66	01/86 → 03/88	CHASSIS: 32J000001 →

PASSAT Variant (32B)

1.6	Petrol	51	08/87 → 03/88	CHASSIS: 32J000001 →
1.6	Petrol	53	02/86 → 03/88	CHASSIS: 32J000001 →
1.6	Petrol	55	08/80 → 03/88	CHASSIS: 32J000001 →
1.6 D	Diesel	40	01/86 → 03/88	CHASSIS: 32J000001 →
1.6 TD	Diesel	51	01/86 → 03/88	CHASSIS: 32J000001 →
1.8	Petrol	66	01/86 → 03/88	CHASSIS: 32J000001 →
1.8 Syncro	Petrol	66	01/86 → 03/88	CHASSIS: 32J000001 →

PASSAT Variant (3A5, 35I)

1.6	Petrol	74	07/94 → 12/95
1.6	Petrol	53	04/88 → 09/91
1.6	Petrol	55	04/88 → 12/88
1.6 TD	Diesel	59	08/88 → 09/93
1.8	Petrol	55	08/90 → 05/97
1.8	Petrol	66	02/88 → 05/97
1.8	Petrol	79	04/88 → 07/90
1.8	Petrol	82	04/88 → 07/92
1.9 D	Diesel	50	05/89 → 10/93
1.9 TD	Diesel	55	03/91 → 05/97
1.9 TDI	Diesel	66	10/93 → 05/97
1.9 TDI	Diesel	81	03/96 → 05/97

SPA105

VOLKSWAGEN
PASSAT Variant (3A5, 35I)

2.0	Petrol	79	03/95 → 08/96
2.0	Petrol	85	02/90 → 05/97
2.0 16V	Petrol	110	01/94 → 05/97
2.8 VR6	Petrol	128	06/91 → 05/97

POLO (6N1)

45 1.0	Petrol	33	01/95 → 09/96
--------	--------	----	---------------

POLO (86C, 80)

1.0 Cat.	Petrol	33	08/89 → 09/94	
1.1	Petrol	37	10/81 → 09/89	CHASSIS: K000001 →
1.3 Cat.	Petrol	40	07/87 → 09/94	CHASSIS: K000001 →
1.3 Cat.	Petrol	55	10/89 → 03/91	
1.3 D	Diesel	33	08/86 → 07/90	CHASSIS: K000001 →
1.4 D	Diesel	35	01/91 → 09/94	

POLO CLASSIC (86C, 80)

1.0	Petrol	29	01/85 → 10/86	CHASSIS: K000001 →
1.0	Petrol	33	01/85 → 09/94	CHASSIS: K000001 →
1.3 Cat.	Petrol	40	07/87 → 09/94	CHASSIS: K000001 →
1.3 D	Diesel	33	08/86 → 12/88	CHASSIS: K000001 →

POLO Coupé (86C, 80)

1.0 Cat.	Petrol	33	08/89 → 09/94	CHASSIS: K000001 →
1.3	Petrol	57	03/91 → 09/94	
1.3 Cat.	Petrol	40	07/87 → 08/94	CHASSIS: K000001 →
1.3 Cat.	Petrol	55	01/90 → 12/90	CHASSIS: K000001 →
1.3 D	Diesel	33	08/86 → 08/90	CHASSIS: K000001 →
1.3 G40	Petrol	83	08/90 → 09/94	
1.3 G40	Petrol	85	01/87 → 08/90	CHASSIS: K000001 →
1.4 D	Diesel	35	01/91 → 09/94	

POLO Furgonato (86CF)

1.0	Petrol	33	08/92 → 07/94
1.3	Petrol	40	08/92 → 07/94
1.4 D	Diesel	35	08/92 → 07/94

SCIROCCO (53B)

1.6	Petrol	53	04/86 → 07/90
1.6	Petrol	55	01/83 → 12/89
1.8	Petrol	66	08/83 → 07/92
1.8	Petrol	70	11/85 → 07/92
1.8	Petrol	82	08/82 → 01/83
1.8 16V	Petrol	102	10/85 → 07/89
1.8 16V	Petrol	95	03/86 → 07/92

SHARAN (7M8, 7M9, 7M6)

1.8 T 20V	Petrol	110	09/97 → 03/10
1.9 TDI	Diesel	110	06/05 → 03/10
1.9 TDI	Diesel	66	09/95 → 03/10
1.9 TDI	Diesel	85	04/00 → 03/10

SPA105



VOLKSWAGEN

SHARAN (7M8, 7M9, 7M6)

1.9 TDI	Diesel	96	11/02 → 03/10
1.9 TDI 4motion	Diesel	85	04/00 → 03/10
2.0	Petrol	85	09/95 → 03/10
2.0 TDi	Diesel	103	11/05 → 03/10
2.8 V6 24V	Petrol	150	04/00 → 03/10
2.8 V6 24V 4motion	Petrol	150	04/00 → 03/10
2.8 VR6	Petrol	128	09/95 → 05/97

TRANSPORTER III Autobus

1.9	Petrol	44	08/82 → 07/92
1.9	Petrol	57	08/82 → 07/92
1.9 Syncro	Petrol	57	02/85 → 07/92
2.1	Petrol	64	10/86 → 07/92
2.1	Petrol	70	08/85 → 07/92
2.1	Petrol	82	08/84 → 07/92
2.1 Cat.	Petrol	70	06/89 → 07/92
2.1 i	Petrol	68	07/89 → 07/92
2.1 Syncro	Petrol	64	10/86 → 07/92
2.1 Syncro	Petrol	70	08/85 → 07/92
2.1 Syncro	Petrol	82	01/86 → 07/92

TRANSPORTER III Furgonato

1.9	Petrol	44	10/82 → 07/92
2.1	Petrol	70	08/85 → 07/92
2.1	Petrol	82	03/86 → 07/92
2.1 i	Petrol	68	07/89 → 07/92
2.1 Syncro	Petrol	70	08/85 → 07/92

TRANSPORTER III Pianale piatto/Telaio

1.9	Petrol	44	09/82 → 07/92
1.9	Petrol	57	08/82 → 07/92
2.1	Petrol	82	03/86 → 07/92
2.1 i	Petrol	68	07/89 → 07/92

TRANSPORTER IV Autobus (70XB, 70XC, 7DB, 7DW)

1.9 D	Diesel	44	09/90 → 12/95
1.9 TD	Diesel	50	10/92 → 04/03
2.0	Petrol	62	09/90 → 04/03
2.4 D	Diesel	55	08/97 → 04/03
2.4 D	Diesel	57	09/90 → 04/98
2.4 D Syncro	Diesel	57	10/92 → 09/98
2.5	Petrol	81	11/90 → 04/03
2.5 Syncro	Petrol	81	11/92 → 04/03
2.5 TDI	Diesel	111	05/98 → 04/03
2.5 TDI	Diesel	65	05/98 → 04/03
2.5 TDI	Diesel	75	09/95 → 04/03
2.8 VR 6	Petrol	103	11/95 → 04/00

SPA105



VOLKSWAGEN

TRANSPORTER IV Autobus (70XB, 70XC, 7DB, 7DW)

2.8 VR6	Petrol	150	04/00 → 04/03
2.8 VR6 Syncro	Petrol	103	01/96 → 04/96

TRANSPORTER IV Pianale piatto/Telaio (70XD)

2.4 D Syncro	Diesel	57	10/92 → 09/98
2.8	Petrol	103	05/96 → 05/00

VENTO (1H2)

1.8	Petrol	66	01/94 → 09/98
1.9 TD	Diesel	55	11/91 → 09/98
1.9 TDI	Diesel	66	09/93 → 09/98
2.0	Petrol	85	07/94 → 09/98

SPA106

F1 **SENSORE TEMPERATURA REFRIGERANTE**
COOLANT TEMPERATURE SENSOR



AUDI

100 (4A, C4)

2.0	Petrol	74	12/90 → 06/94
2.0 E	Petrol	85	12/90 → 06/94
2.0 E quattro	Petrol	85	12/90 → 07/92

100 Avant (4A, C4)

2.0 E	Petrol	74	09/91 → 06/94
2.0 E	Petrol	85	09/91 → 06/94
2.0 E quattro	Petrol	85	12/90 → 07/92

80 (89, 89Q, 8A, B3)

1.8 S	Petrol	66	09/86 → 10/91
-------	--------	----	---------------

80 (8C, B4)

1.6	Petrol	52	09/91 → 12/94
2.0	Petrol	66	09/91 → 12/94
2.0 E	Petrol	85	09/91 → 12/94
2.0 E quattro	Petrol	85	09/91 → 12/94

SPA106

KW

AUDI
80 Avant (8C, B4)

1.9 TDI	Diesel	66	07/92 → 01/96
2.0	Petrol	66	07/92 → 01/96
2.0 E	Petrol	85	07/92 → 01/96

A4 (8D2, B5)

1.6	Petrol	74	11/94 → 12/98
1.8	Petrol	92	01/95 → 12/98
1.8 quattro	Petrol	92	01/95 → 12/98
1.8 T	Petrol	110	01/95 → 12/98
1.9 TDI	Diesel	66	01/95 → 12/98
1.9 TDI	Diesel	81	10/95 → 12/98

A4 Avant (8D5, B5)

1.6	Petrol	74	11/94 → 12/98
1.8	Petrol	92	02/96 → 12/98
1.8 quattro	Petrol	85	07/95 → 12/98
1.8 quattro	Petrol	92	01/96 → 12/98
1.8 T	Petrol	110	03/96 → 12/98
1.8 T quattro	Petrol	110	01/96 → 12/98
1.9 TDI	Diesel	66	02/96 → 12/98
1.9 TDI	Diesel	81	02/96 → 12/98

A6 (4A, C4)

1.9 TDI	Diesel	66	06/94 → 10/97
2.0	Petrol	74	06/94 → 10/97
2.0	Petrol	85	06/94 → 10/97

A6 Avant (4A, C4)

1.9 TDI	Diesel	66	06/94 → 12/97
2.0	Petrol	74	06/94 → 12/97
2.0	Petrol	85	06/94 → 12/97

CABRIOLET (8G7, B4)

2.0 E	Petrol	85	01/93 → 07/98
-------	--------	----	---------------

SEAT
CORDOBA (6K1, 6K2)

1.4 i	Petrol	44	06/94 → 06/99
1.6 i	Petrol	55	02/93 → 06/99
1.8 i	Petrol	66	02/93 → 06/99
1.8 i 16V	Petrol	95	10/93 → 08/96
2.0 i	Petrol	85	02/93 → 06/99

CORDOBA Vario (6K5)

1.4 i	Petrol	44	09/96 → 06/99
1.6 i	Petrol	55	09/96 → 06/99
1.6 i	Petrol	74	09/96 → 06/99

IBIZA II (6K1)

1.0	Petrol	33	03/93 → 09/96
1.0 i	Petrol	37	09/96 → 08/99
1.3 i	Petrol	40	03/93 → 08/99

SPA106

KW

SEAT
IBIZA II (6K1)

1.4 i	Petrol	44	09/93 → 08/99
1.6 i	Petrol	55	03/93 → 08/99
1.8 i	Petrol	66	03/93 → 08/99
1.8 i 16V	Petrol	95	11/93 → 08/96
1.9 SDI	Diesel	47	08/96 → 08/99
2.0 i	Petrol	85	03/93 → 08/99

TOLEDO I (1L)

1.6 i	Petrol	55	01/93 → 03/99
1.8 16V	Petrol	92	05/91 → 03/99
1.8 16V	Petrol	98	05/91 → 01/93
1.8 i	Petrol	65	05/91 → 12/96
1.8 i	Petrol	66	11/93 → 12/96

VOLKSWAGEN
CORRADO (53I)

2.9 VR6	Petrol	140	08/91 → 12/95
---------	--------	-----	---------------

GOLF II (19E, 1G1)

1.0	Petrol	37	08/85 → 10/91
1.6 TD	Diesel	59	04/89 → 10/91
1.8 i Cat.	Petrol	66	08/87 → 10/91

GOLF III (1H1)

2.8 VR6	Petrol	128	01/92 → 08/97
2.9 VR6 Syncro (1HX1)	Petrol	140	10/94 → 08/97

GOLF III Variant (1H5)

1.9 SDI	Diesel	47	07/95 → 04/99
---------	--------	----	---------------

JETTA II (19E, 1G2, 165)

1.6 TD	Diesel	51	01/84 → 10/91
--------	--------	----	---------------

PASSAT (3A2, 35I)

1.8	Petrol	55	08/90 → 12/91
1.8	Petrol	66	02/88 → 12/93
2.0	Petrol	85	02/90 → 12/93
2.0 16V	Petrol	100	08/88 → 12/91

PASSAT Variant (3A5, 35I)

1.8	Petrol	55	08/90 → 12/93
1.8	Petrol	66	02/88 → 12/93
2.0	Petrol	85	02/90 → 12/93
2.0 16V	Petrol	100	08/88 → 12/91

POLO (6N1)

45 1.0	Petrol	33	10/94 → 09/96
--------	--------	----	---------------

POLO Coupé (86C, 80)

1.3 Cat.	Petrol	55	10/89 → 09/94
----------	--------	----	---------------

POLO Furgonato (6NF)

1.0	Petrol	33	10/94 → 12/99
-----	--------	----	---------------

SPA106



SEAT

SCIROCCO (53B)

1.6	Petrol	63	08/80 → 04/84
1.6	Petrol	81	08/80 → 07/82
1.8	Petrol	82	08/82 → 12/89

TRANSPORTER IV Furgonato (70XA)

2.5	Petrol	85	08/96 → 04/03
-----	--------	----	---------------

TRANSPORTER IV Pianale piatto/Telaio (70XD)

2.0	Petrol	62	07/90 → 04/03
2.5	Petrol	81	11/90 → 04/03
2.5	Petrol	85	08/96 → 04/03

VENTO (1H2)

1.9 SDI	Diesel	47	04/97 → 09/98
2.8 VR6	Petrol	128	01/92 → 09/98

SPA107

F1 **SENSORE TEMPERATURA REFRIGERANTE**
COOLANT TEMPERATURE SENSOR

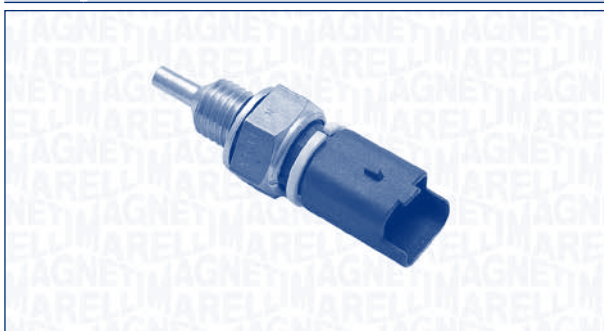

CITROËN

BERLINGO (MF)

1.4 bivalent	Petrol/ CNG	48	11/02 →
1.4 Hybrid	Hybrid	54	05/05 → 05/08
1.4 i bivalent (MFKFW)	BiFuel	55	04/03 →
1.6 16V (MFNFU)	Petrol	80	10/00 →
1.6 16V (MFNFU)	Petrol	81	11/02 → 08/05
1.9 D (MFWJZ)	Diesel	51	07/98 →

BERLINGO Furgonato (M_)

1.4 bivalent	Petrol/ CNG	48	11/02 →
1.4 i bivalent (MBKFW)	BiFuel	55	04/03 →

SPA107



CITROËN

BERLINGO Furgonato (M_)

1.6 16V (MBNFU)	Petrol	80	10/00 →
1.9 D 70 (MBWJZ, MCWJZ)	Diesel	51	04/99 →

C2 (JM_)

1.1	Petrol	44	09/03 →
1.4	Petrol	54	09/03 →
1.4	Petrol	55	10/06 →
1.6	Petrol	80	09/03 →
1.6 VTS	Petrol	90	01/05 → 04/05

C3 I (FC_)

1.1 i	Petrol	44	02/02 →
1.4 16V	Petrol	65	12/03 →
1.4 i Bivalent	Petrol/ CNG	54	02/02 →
1.6 16V	Petrol	80	02/02 →

C3 Pluriel (HB_)

1.4	Petrol	54	05/03 →
1.4 Hybrid	Petrol	54	05/05 →
1.6	Petrol	80	05/03 →

C4 Coupé (LA_)

1.4 16V	Petrol	65	11/04 →
1.6 16V	Petrol	80	11/04 →
2.0 16V	Petrol	100	11/04 →
2.0 16V	Petrol	130	11/04 →

C4 I (LC_)

1.4 16V	Petrol	65	11/04 →
1.6 16V	Petrol	80	11/04 →
1.6 16V Bio-Flex	BiFuel	80	09/07 →
2.0 16V	Petrol	100	11/04 →
2.0 16V	Petrol	130	02/05 →

C4 Tre volumi

1.6 16V	Petrol	80	04/07 →
---------	--------	----	---------

C5 I (DC_)

1.8 16V (DC6FZB, DC6FZE)	Petrol	85	03/01 → 08/04
2.0 16V (DCRFNC, DCRFNF)	Petrol	100	03/01 → 08/04
2.0 16V HPi (DCRLZB)	Petrol	103	03/01 → 08/04

SPA107

KW

CITROËN
C5 I (DC_)

3.0 V6 (DCXFXC, DCXFXF)	Petrol	152	03/01 → 08/04
-------------------------------	--------	-----	---------------

C5 I Break (DE_)

1.8 16V (DE6FZB, DE6FZE)	Petrol	85	06/01 → 08/04
--------------------------------	--------	----	---------------

2.0 16V (DERFNF, DERFNC, RERFNC)	Petrol	100	06/01 → 08/04
---	--------	-----	---------------

2.0 16V HPi (DERLZB)	Petrol	103	06/01 → 08/04
-------------------------	--------	-----	---------------

3.0 Carlsson	Petrol	173	09/03 → 08/04
--------------	--------	-----	---------------

3.0 V6 (DEXFXC, DEXFXF)	Petrol	152	06/01 → 08/04
-------------------------------	--------	-----	---------------

C5 II (RC_)

1.8 16V (RC6FZB)	Petrol	85	09/04 →
---------------------	--------	----	---------

3.0 V6 (RCXFUF)	Petrol	152	09/04 →
--------------------	--------	-----	---------

C5 II Break (RE_)

1.8 16V (RE6FZB)	Petrol	85	09/04 →
---------------------	--------	----	---------

3.0	Petrol	173	09/04 →
-----	--------	-----	---------

3.0 V6 (REXFUF)	Petrol	152	09/04 →
--------------------	--------	-----	---------

C5 III (RD_)

1.8 16V	Petrol	92	02/08 →
---------	--------	----	---------

2.0 16V	Petrol	103	02/08 →
---------	--------	-----	---------

2.0 16V BioFlex	BiFuel	103	02/08 →
-----------------	--------	-----	---------

3.0 V6	Petrol	155	02/08 →
--------	--------	-----	---------

C5 III Break (TD_)

1.8 16V	Petrol	92	02/08 →
---------	--------	----	---------

2.0 16V	Petrol	103	02/08 →
---------	--------	-----	---------

2.0 16V BioFlex	BiFuel	103	02/08 →
-----------------	--------	-----	---------

3.0 V6	Petrol	155	02/08 →
--------	--------	-----	---------

C6 (TD_)

3.0 V6	Petrol	155	09/05 →
--------	--------	-----	---------

C8 (EA_, EB_)

2.0	Petrol	100	07/02 →
-----	--------	-----	---------

2.0 16V	Petrol	103	09/05 →
---------	--------	-----	---------

2.2	Petrol	116	07/02 →
-----	--------	-----	---------

SPA107

KW

CITROËN
C8 (EA_, EB_)

3.0 V6	Petrol	150	07/02 →
--------	--------	-----	---------

EVASION (22, U6)

2.0 16V	Petrol	100	05/00 → 07/02
---------	--------	-----	---------------

2.0 HDi	Diesel	80	08/99 → 07/02
---------	--------	----	---------------

2.0 HDi 16V	Diesel	80	09/99 → 07/02
-------------	--------	----	---------------

JUMPY

2.0 i	Petrol	103	01/07 →
-------	--------	-----	---------

JUMPY (U6U)

1.9 D 70	Diesel	51	04/98 →
----------	--------	----	---------

2.0	Petrol	100	04/00 → 12/06
-----	--------	-----	---------------

2.0 HDi 110	Diesel	80	03/00 →
-------------	--------	----	---------

2.0 HDi 95	Diesel	69	10/99 →
------------	--------	----	---------

2.0 i 16V	Petrol	102	03/00 →
-----------	--------	-----	---------

JUMPY Furgonato

2.0 i	Petrol	103	01/07 →
-------	--------	-----	---------

JUMPY Furgonato (BS_, BT_, BY_, BZ_)

1.9 D 70	Diesel	51	04/98 →
----------	--------	----	---------

2.0 HDi 110	Diesel	80	01/02 →
-------------	--------	----	---------

2.0 HDi 95	Diesel	69	10/99 →
------------	--------	----	---------

2.0 i 16V	Petrol	102	03/00 →
-----------	--------	-----	---------

JUMPY Pianale piatto/Telaio (BU_, BV_, BW_, BX_)

2.0	Petrol	100	12/03 → 10/06
-----	--------	-----	---------------

2.0 HDi 110 16V	Diesel	80	12/03 → 10/06
-----------------	--------	----	---------------

2.0 HDi 95	Diesel	69	10/99 →
------------	--------	----	---------

NEMO Furgonato (AA_)

1.4	Petrol	54	02/08 →
-----	--------	----	---------

NEMO Station wagon

1.4	Petrol	54	04/09 →
-----	--------	----	---------

SAXO (S0, S1)

1.1 X,SX	Petrol	44	05/96 → 09/03
----------	--------	----	---------------

1.6	Petrol	88	02/96 → 04/04
-----	--------	----	---------------

XSARA (N1)

1.4 i	Petrol	55	04/97 → 03/05
-------	--------	----	---------------

1.6 16V	Petrol	80	09/00 → 03/05
---------	--------	----	---------------

1.9 D	Diesel	51	07/98 → 03/05
-------	--------	----	---------------

2.0 16V	Petrol	100	09/00 → 03/05
---------	--------	-----	---------------

2.0 16V	Petrol	120	04/97 → 09/00
---------	--------	-----	---------------

XSARA Break (N2)

1.4 i	Petrol	55	10/97 → 08/05
-------	--------	----	---------------

1.6 16V	Petrol	80	09/00 → 08/05
---------	--------	----	---------------

1.9 D	Diesel	51	07/98 → 08/05
-------	--------	----	---------------

2.0 16V	Petrol	100	09/00 → 08/05
---------	--------	-----	---------------

SPA107



KW



CITROËN

XSARA Coupé (N0)

1.4 i	Petrol	55	03/98 → 03/05
1.6 16V	Petrol	80	09/00 → 03/05
1.9 D	Diesel	51	02/99 → 03/05
2.0 16V	Petrol	100	09/00 → 03/05
2.0 i 16V	Petrol	120	02/98 → 03/05

XSARA PICASSO (N68)

1.6	Petrol	70	11/02 →
1.6 16V	Petrol	80	09/05 →
1.6 Chrono	Petrol	74	11/02 → 10/04
1.8 16V	Petrol	85	02/00 →
2.0 16V	Petrol	100	01/03 →

FIAT

FIORINO Cassone / Furgonato / Promiscuo (225)

1.4	Petrol	54	11/07 →
-----	--------	----	---------

QUBO (225)

1.4	Petrol	54	02/08 →
-----	--------	----	---------

SCUDO Combinato (220P)

1.9 D	Diesel	51	04/98 → 12/06
-------	--------	----	---------------

SCUDO Combinato (220P)

2.0 16V	Petrol	100	06/00 → 12/06
2.0 JTD	Diesel	80	12/99 → 12/06
2.0 JTD	Diesel	69	01/04 → 12/06

SCUDO Furgonato (220L)

1.9 D	Diesel	51	04/98 → 12/06
2.0	Petrol	100	05/00 → 12/06
2.0 JTD	Diesel	69	12/99 → 12/06
2.0 JTD	Diesel	80	12/02 → 12/06

ULYSSE (179AX)

2.0	Petrol	100	08/02 → 06/11
3.0	Petrol	150	08/02 → 06/11

ULYSSE (220)

2.0 16V	Petrol	100	09/00 → 08/02
2.0 JTD	Diesel	80	10/99 → 08/02

LANCIA

PHEDRA (179)

2.0 (179AXA11)	Petrol	100	09/02 → 11/10
2.0 JTD	Diesel	79	07/03 → 11/10
2.0 JTD (179AXB1A)	Diesel	80	09/02 → 11/10
3.0 V6	Petrol	150	09/02 → 11/10

ZETA (220)

2.0 16V (220AQ5)	Petrol	100	07/00 → 09/02
------------------	--------	-----	---------------

SPA107



KW



LANCIA

ZETA (220)

2.0 JTD (220AN5)	Diesel	80	09/99 → 09/02
------------------	--------	----	---------------

PEUGEOT

1007 (KM_)

1.4	Petrol	54	04/05 →
1.6 16V	Petrol	80	04/05 →

206 2 volumi /Coda spiovente (2A/C)

1.1 i	Petrol	44	09/98 →
1.4 16V	Petrol	65	10/03 →
1.4 i	Petrol	55	09/98 →
1.4 LPG	Petrol/ LPG	55	05/06 → 09/07
1.6 16V	Petrol	80	12/00 →
1.9 D	Diesel	51	09/98 → 11/01
2.0 RC	Petrol	130	07/03 →
2.0 S16	Petrol	100	06/99 →
2.0 S16	Petrol	99	04/99 → 10/00

206 CC (2D)

1.6 16V	Petrol	80	09/00 →
2.0 S16	Petrol	100	09/00 →

206 SW (2E/K)

1.1	Petrol	44	07/02 →
1.4	Petrol	55	07/02 →
1.4 16V	Petrol	65	10/03 →
1.6 16V	Petrol	80	07/02 →
2.0 16V	Petrol	100	07/02 →

206 Van

1.9 D	Diesel	51	09/01 → 05/07
-------	--------	----	---------------

206+ (T3E)

1.4 i	Petrol	54	09/10 →
-------	--------	----	---------

207 Tre volumi

1.4	Petrol	54	12/07 →
-----	--------	----	---------

307 (3A/C)

1.4	Petrol	55	08/00 →
1.4 16V	Petrol	65	11/03 →
1.6 16V	Petrol	80	08/00 →
2.0 16V	Petrol	130	06/05 →
2.0 16V	Petrol	100	08/00 →

307 Break (3E)

1.4 16V	Petrol	65	11/03 →
1.6 16V	Petrol	80	03/02 →
2.0	Petrol	100	03/02 →
2.0 16V	Petrol	130	06/05 →

SPA107

PEUGEOT
307 CC (3B)

1.6 16V	Petrol	80	02/05 →	
2.0 16V	Petrol	130	10/03 →	
2.0 16V	Petrol	100	10/03 →	

307 SW (3H)

1.4 16V	Petrol	65	11/03 →	
1.6 16V	Petrol	80	03/02 →	
2.0 16V	Petrol	100	03/02 →	

406 (8B)

1.8 16V	Petrol	85	10/00 → 05/04	
2.0 16V	Petrol	100	08/00 → 06/04	
2.0 16V	Petrol	99	01/99 → 03/99	
2.0 16V HPi	Petrol	103	05/01 → 05/04	
2.0 HDi 110	Diesel	80	06/98 → 08/01	
2.0 HDi 110	Diesel	79	08/01 → 05/04	
2.0 HDi 90	Diesel	66	02/99 → 05/04	
2.2	Petrol	116	07/00 → 05/04	
3.0 V6	Petrol	152	03/00 → 05/04	

406 Break (8E/F)

1.8 16V	Petrol	85	10/00 → 10/04	
2.0 16V	Petrol	100	10/00 → 10/04	
2.0 16V	Petrol	99	01/99 → 03/99	
2.0 16V HPi	Petrol	103	05/01 → 10/04	
2.0 HDi 110	Diesel	80	02/99 → 04/04	
2.0 HDi 110	Diesel	79	08/01 → 10/04	
2.0 HDi 90	Diesel	66	02/99 → 10/04	
2.2	Petrol	116	07/00 → 10/04	
3.0 V6	Petrol	152	03/00 → 10/04	

406 Coupé (8C)

2.0 16V	Petrol	100	10/00 → 12/04	
2.0 16V	Petrol	99	01/99 → 03/99	
2.2	Petrol	116	03/02 → 12/04	
3.0 V6	Petrol	152	03/00 → 12/04	

407 (6D_)

1.8	Petrol	85	05/04 →	
2.0	Petrol	100	05/04 →	
2.0 Bioflex	Petrol/ Ethanol	103	01/09 →	
2.7 HDi	Diesel	150	10/05 →	
3.0	Petrol	155	05/04 →	

407 Coupé (6C_)

2.7 HDi	Diesel	150	10/05 →	
3.0 V6	Petrol	155	10/05 →	

SPA107

PEUGEOT
407 SW (6E_)

1.8	Petrol	85	05/04 →	
2.0	Petrol	100	05/04 →	
2.7 HDi	Diesel	150	10/05 →	
3.0	Petrol	155	05/04 →	

607 (9D, 9U)

2.0	Petrol	100	02/00 →	
2.2 16V	Petrol	116	02/00 →	ENGINE: → 941438
3.0 V6 24V	Petrol	152	02/00 →	
3.0 V6 24V	Petrol	155	08/04 →	

806 (221)

2.0 16V	Petrol	100	09/00 → 08/02	
2.0 HDi	Diesel	80	08/99 → 08/02	
2.0 HDi 16V	Diesel	80	08/99 → 08/02	

807 (E)

2.0	Petrol	100	06/02 →	
2.0 16V	Petrol	103	09/05 →	
2.2	Petrol	116	06/02 →	
2.2 HDi	Diesel	94	06/02 →	
3.0 V6	Petrol	150	06/02 →	

BIPPER (AA_)

1.4	Petrol	54	01/10 →	
-----	--------	----	---------	--

BIPPER Tepee

1.4	Petrol	54	04/08 →	
-----	--------	----	---------	--

EXPERT (224)

1.9 D	Diesel	51	12/03 → 10/06	
2.0	Petrol	100	07/00 →	
2.0 HDi	Diesel	69	10/00 → 11/03	
2.0 HDi	Diesel	80	07/00 → 10/06	

EXPERT Furgonato (222)

1.9 D 70	Diesel	51	12/98 →	
2.0	Petrol	100	09/02 →	
2.0 HDi	Diesel	69	07/00 →	
2.0 HDi	Diesel	80	07/00 → 10/06	

EXPERT Furgonato (VF3A_, VF3U_, VF3X_)

2.0 16V	Petrol	103	01/07 →	
---------	--------	-----	---------	--

EXPERT Pianale piatto/Telaio (223)

1.9 D	Diesel	51	06/98 → 11/03	
2.0 HDi	Diesel	80	10/00 → 10/06	

EXPERT Tepee (VF3V_)

2.0 16V	Petrol	103	01/07 →	
---------	--------	-----	---------	--

RANCH Furgonato (5)

1.4 BiFuel	Petrol/ CNG	55	04/03 →	
1.6	Petrol	80	09/00 → 10/02	

SPA107



CITROËN

RANCH Furgonato (5)

1.9 D	Diesel	51	06/96 →
1.9 D 4x4	Diesel	51	04/04 →

RANCH MPV / Space wagon (5F)

1.1	Petrol	44	06/96 →
1.4	Petrol	54	11/02 → 10/06
1.4	Petrol	55	06/96 →
1.6 16V	Petrol	80	07/01 →
1.9 D	Diesel	51	12/98 →
1.9 D 4x4	Diesel	51	04/04 → 08/05

TOYOTA

COROLLA (_E11_)

1.9 D (WZE110_)	Diesel	51	02/00 → 09/01
-----------------	--------	----	---------------

COROLLA Compact (_E11_)

1.9 D (WZE110_)	Diesel	51	02/00 → 09/01
-----------------	--------	----	---------------

COROLLA Liftback (_E11_)

1.9 D (WZE110_)	Diesel	51	02/00 → 09/01
-----------------	--------	----	---------------

COROLLA Wagon (_E11_)

1.9 D (WZE110_)	Diesel	51	02/00 → 09/01
-----------------	--------	----	---------------

SPA108

F1 **SENSORE TEMPERATURA REFRIGERANTE**
COOLANT TEMPERATURE SENSOR



DACIA

DUSTER

1.6 16V	Petrol	77	04/10 →
1.6 16V 4x4	Petrol	77	06/10 →
1.6 16V LPG	Petrol/ LPG	77	04/11 →

SPA108



DACIA

LOGAN (LS_)

1.4 (LSOA, LSOC, LSOE, LSOG)	Petrol	55	09/04 →
1.4 MPI LPG (LSOC)	Petrol/ LPG	55	02/06 →
1.6 (LSOB, LSOD, LSOF, LSOH)	Petrol	64	09/04 → 12/11
1.6 16V (LSOM)	Petrol	77	02/06 →

LOGAN EXPRESS (FS_)

1.4	Petrol	55	03/09 →
1.6	Petrol	64	03/09 →
1.6 Bifuel	BiFuel	62	05/10 →

LOGAN MCV (KS_)

1.4	Petrol	55	02/07 →
1.6	Petrol	64	02/07 →
1.6 16V	Petrol	77	02/07 →
1.6 Bifuel	BiFuel	64	11/08 →

LOGAN Pick-up (US_)

1.6	Petrol	64	03/08 →
1.6 Bifuel	BiFuel	62	05/10 →

SANDERO

1.2 16V	Petrol	55	11/08 →
1.2 16V LPG	Petrol/ LPG	55	01/11 →
1.4	Petrol	55	06/08 →
1.6	Petrol	64	06/08 →
1.6 16V Bifuel	BiFuel	77	01/11 →

NISSAN

KUBISTAR (X76)

1.2	Petrol	44	08/03 →
1.2 16V	Petrol	55	04/06 →
1.6 16V	Petrol	70	08/03 →

KUBISTAR Furgonato (X80)

1.2	Petrol	44	08/03 →
1.2 16V	Petrol	55	04/06 →
1.6 16V	Petrol	70	08/03 →

OPEL

VIVARO Combi (J7)

2.0 16V	Petrol	88	08/01 →
2.0 ECOTEC	Petrol	86	08/06 →

VIVARO Furgonato (F7)

2.0 16V	Petrol	88	08/01 →
2.0 ECOTEC	Petrol	86	08/06 →

SPA108

OPEL
VIVARO Pianale piatto/Telaio (E7)

2.0 16V	Petrol	88	08/06 →
2.0 ECOTEC	Petrol	86	08/06 →

RENAULT
AVANTIME (DE0_)

2.0 16V Turbo (DE0U, DE0V)	Petrol	120	11/01 → 05/03
----------------------------	--------	-----	---------------

CLIO II (BB0/1/2_, CB0/1/2_)

1.2 (BB0A, BB0F, BB10, BB1K, BB28, BB2D, BB2H, CB0A...)	Petrol	43	09/98 →
---	--------	----	---------

1.2 (BB0A, CB0A)	Petrol	44	03/99 → 05/01
------------------	--------	----	---------------

1.2 16V (BB05, BB0W, BB11, BB27, BB2T, BB2U, BB2V, CB05...)	Petrol	55	06/01 →
---	--------	----	---------

1.4 (B/CB0C)	Petrol	55	09/98 → 05/05
--------------	--------	----	---------------

1.4 16V (B/CB0L)	Petrol	70	10/99 → 09/04
------------------	--------	----	---------------

1.4 16V (B/CB0P)	Petrol	72	08/00 →
------------------	--------	----	---------

1.5 dCi	Diesel	74	01/04 → 01/05
---------	--------	----	---------------

1.5 dCi (B/C2J)	Diesel	50	08/04 → 01/05
-----------------	--------	----	---------------

1.5 dCi (B/CB07)	Diesel	48	06/01 → 01/05
------------------	--------	----	---------------

1.5 dCi (B/CB08)	Diesel	60	06/01 → 01/05
------------------	--------	----	---------------

1.6 (B/CB0D)	Petrol	66	09/98 → 01/02
--------------	--------	----	---------------

1.6 16V (BB01, BB0H, BB0T, BB14, BB1D, BB1R, BB2KL...)	Petrol	79	09/98 →
--	--------	----	---------

1.6 Hi-Flex (CB0H)	BiFuel	86	01/05 → 02/10
--------------------	--------	----	---------------

1.9 D (B/CB0J)	Diesel	48	02/00 → 05/01
----------------	--------	----	---------------

1.9 dTi (B/CB0U)	Diesel	59	12/99 → 01/05
------------------	--------	----	---------------

2.0 16V Sport	Petrol	132	01/04 →
---------------	--------	-----	---------

2.0 16V Sport (CB0M)	Petrol	124	02/00 →
----------------------	--------	-----	---------

CLIO II Furgonato (SB0/1/2_)

1.1 (SB0A, SB0F, SB1K, SB2D)	Petrol	43	09/98 →
------------------------------	--------	----	---------

1.2 (SB0A, SB0F, SB10)	Petrol	44	03/99 → 10/03
------------------------	--------	----	---------------

SPA108

RENAULT
CLIO II Furgonato (SB0/1/2_)

1.5 dCi	Diesel	59	06/01 → 10/04
---------	--------	----	---------------

1.5 dCi	Diesel	60	11/03 → 01/05
---------	--------	----	---------------

1.5 dCi (SB07)	Diesel	48	06/01 → 01/05
----------------	--------	----	---------------

1.9 D (SB0J)	Diesel	48	02/00 → 05/01
--------------	--------	----	---------------

1.9 DTi (SB0U)	Diesel	59	02/00 → 05/01
----------------	--------	----	---------------

CLIO III (BR0/1, CR0/1)

1.2 16V	Petrol	58	06/05 →
---------	--------	----	---------

1.2 16V (BR02, BR0J, BR11, CR02, CR0J, CR11)	Petrol	55	06/05 → 06/07
--	--------	----	---------------

1.2 16V (BR0P, CR0P)	Petrol	74	05/07 → 06/07
----------------------	--------	----	---------------

1.2 16V (BR0R, BR1D, BR1L, CR0R)	Petrol	48	06/05 → 06/07
----------------------------------	--------	----	---------------

1.6 Hi-Flex	BiFuel	86	05/05 → 02/10
-------------	--------	----	---------------

ESPACE III (JE0_)

2.0	Petrol	102	09/01 → 10/02
-----	--------	-----	---------------

2.0 16V (JE0N, JE0L, JE02)	Petrol	103	10/98 → 10/02
----------------------------	--------	-----	---------------

ESPACE IV (JK0/1_)

1.9 dCi (JK0U)	Diesel	85	04/03 → 02/05
----------------	--------	----	---------------

1.9 dCi (JK0U, JK0G)	Diesel	88	04/03 → 01/05
----------------------	--------	----	---------------

2.0 (JK09)	Petrol	100	11/02 →
------------	--------	-----	---------

2.0 (JK0K)	Petrol	98	11/02 → 02/05
------------	--------	----	---------------

2.0 (JK0N, JK1D)	Petrol	125	04/05 →
------------------	--------	-----	---------

2.0 Turbo (JK0B, JK0N)	Petrol	120	11/02 →
------------------------	--------	-----	---------

2.2 dCi (JK0H)	Diesel	110	11/02 → 01/05
----------------	--------	-----	---------------

GRAND SCÉNIC II (JM0/1_)

1.5 dCi (JM02, JM13)	Diesel	74	04/04 → 01/05
----------------------	--------	----	---------------

1.6	Petrol	83	04/04 → 01/05
-----	--------	----	---------------

1.9 dCi (JM0G, JM12, JM1G, JM2C)	Diesel	88	04/04 → 01/05
----------------------------------	--------	----	---------------

2.0	Petrol	120	04/04 →
-----	--------	-----	---------

2.0	Petrol	99	04/04 →
-----	--------	----	---------

SPA108



KW



RENAULT

KANGOO (KC0/1_)

1.2 (KC0A, KC0K, KC0F, KC01)	Petrol	43	08/97 →
1.2 16V (KC03, KC05, KC06, KC0T, KC0W)	Petrol	55	06/01 →
1.4 (KC0C, KC0H, KC0B, KC0M)	Petrol	55	08/97 →
1.5 dCi	Diesel	42	07/03 →
1.5 dCi (KC08, KC09)	Diesel	60	07/02 → 01/05
1.6	Petrol	66	09/99 → 06/01
1.6 16V	Petrol	70	06/01 →
1.6 16V 4x4 (KC0P, KC0S, KC0L)	Petrol	70	10/01 →
1.9 dCi 4x4	Diesel	62	10/03 → 01/05

KANGOO Express (FC0/1_)

1.2 (FC01, FC0A, FC0F)	Petrol	43	08/97 →
1.2 (FC1A)	Petrol	44	07/98 → 07/01
1.2 16V (FC05)	Petrol	55	10/01 →
1.4 (FC0C, FC0B, FC0H, FC0M)	Petrol	55	08/97 →
1.5 dCi (FC07, FC1R)	Diesel	48	12/01 → 01/05
1.5 dCi (FC08, FC09)	Diesel	60	04/03 → 01/05
1.5 dCi (FC1R)	Diesel	42	12/02 → 01/05
1.6 16V	Petrol	70	10/01 →
1.6 16V 4x4 (FC0L, FC0P, FC0S)	Petrol	70	10/01 →
1.6 16V bivalent	Petrol/ CNG	60	06/05 → 12/06
1.9 dCi (FC0V)	Diesel	62	07/03 → 01/05
1.9 dCi 4x4 (FC0V)	Diesel	59	10/01 → 01/05
1.9 dCi 4x4 (FC0V)	Diesel	62	07/03 → 01/05

SPA108



KW



RENAULT

LAGUNA I (B56_, 556_)

1.6 16V (B568, B561)	Petrol	79	11/97 → 03/01
1.8 16V (B563, B564)	Petrol	88	04/98 → 03/01
2.0 16V (556A/B)	Petrol	103	09/99 → 03/01

LAGUNA I Grandtour (K56_)

1.6 16V (K568)	Petrol	79	11/97 → 03/01
1.8 16V (K563, K564)	Petrol	88	04/98 → 03/01

LAGUNA II (BG0/1_)

1.6 16V (BG0A, BG0L)	Petrol	79	03/01 →
1.8 16V (BG06, BG0J, BG0M)	Petrol	85	03/01 →
1.8 16V (BG0B, BG0C, BG0J, BG0M, BG0V)	Petrol	89	03/01 →
1.8 16V (BG0B, BG0M)	Petrol	88	03/01 →
1.9 dCi (BG05)	Diesel	68	03/04 → 01/05
1.9 dCi (BG0E)	Diesel	77	06/01 → 01/05
1.9 dCi (BG0R)	Diesel	74	10/01 → 01/05
2.0 16V	Petrol	125	01/05 →
2.0 16V	Petrol	150	01/05 →
2.0 16V	Petrol	98	08/02 →
2.0 16V (BG00, BG0K, BG0P, BG0W)	Petrol	99	08/02 →
2.0 16V IDE (BG0N)	Petrol	103	04/01 →
2.0 16V Turbo (BG0S, BG0Z, BG1L, BG1M)	Petrol	120	09/03 →
2.2 dCi (BG09)	Diesel	85	04/04 → 01/05
2.2 dCi (BG0F)	Diesel	110	10/01 → 01/05

LAGUNA II Grandtour (KG0/1_)

1.6 16V (KG0A, KG0L)	Petrol	79	03/01 →
1.8 16V	Petrol	89	03/01 →
1.8 16V (KG0B, KG0M)	Petrol	88	03/01 →
1.8 16V (KG0J)	Petrol	85	03/01 →
1.9 dCi (KG05)	Diesel	68	03/04 → 01/05

SPA108

RENAULT
LAGUNA II Grandtour (KG0/1_)

1.9 dCi (KG0E)	Diesel	77	06/01 → 01/05
1.9 dCi (KG0E, KG0R)	Diesel	74	10/01 → 01/05
1.9 dCi (KG0G)	Diesel	88	03/01 →
2.0 16V	Petrol	125	01/05 →
2.0 16V	Petrol	150	01/05 →
2.0 16V (KG00, KG0K, KG0W)	Petrol	99	08/02 →
2.0 16V IDE (KG0N)	Petrol	103	04/01 →
2.0 16V Turbo (KG0S, KG0Z, KG1L, KG1M)	Petrol	120	09/03 →
2.2 dCi (KG09)	Diesel	85	04/04 → 01/05
2.2 dCi (KG0F)	Diesel	110	10/01 → 01/05

LOGAN (LS_)

1.4	Petrol	55	09/04 →
1.6	Petrol	64	09/04 →
1.6	Petrol	77	04/07 →

LOGAN Station wagon (KS_)

1.4	Petrol	55	10/07 →
1.6	Petrol	64	04/07 →
1.6	Petrol	77	04/07 →

MASTER II Autobus (JD)

1.9 dCi 80	Diesel	60	11/01 → 01/05
2.2 dCi 90	Diesel	66	09/00 → 01/05
2.5 dCi	Diesel	84	01/04 → 01/05
2.5 dCi 120	Diesel	84	10/01 → 01/05
2.8 dTi	Diesel	84	08/00 → 10/01

MASTER II Furgonato (FD)

1.9 dCi 80	Diesel	60	11/01 → 01/05
2.2 dCi 90	Diesel	66	09/00 → 01/05
2.5 dCi	Diesel	84	01/04 → 01/05
2.5 dCi 120	Diesel	84	10/01 → 01/05
2.8 dTi	Diesel	84	07/98 → 10/01

MASTER II Pianale piatto/Telaio (ED/HD/UD)

2.2 dCi 90	Diesel	66	09/00 → 01/05
2.5 dCi	Diesel	84	01/04 → 01/05
2.5 dCi 120	Diesel	84	10/01 → 01/05
2.8 dTi	Diesel	84	07/98 → 10/01

MEGANE I (BA0/1_)

1.4 16V (BA0D, BA1H, BA0W, BA10)	Petrol	70	03/99 → 08/03
----------------------------------	--------	----	---------------

SPA108

RENAULT
MEGANE I (BA0/1_)

1.4 e (BA0E, BA0V)	Petrol	55	01/96 → 08/03
1.6 16V (BA11, BA04, BA0B, BA1J)	Petrol	79	03/99 → 08/03
1.6 i (BA0L)	Petrol	55	01/96 → 03/99
1.8 16V (BA06, BA12, BA1A, BA1M, BA1R)	Petrol	85	01/01 → 08/03

MEGANE I Cabriolet (EA0/1_)

1.4 16V (EA0D, EA1H, EA0W, EA10)	Petrol	70	03/99 → 08/03
1.6 16V (EA0B, EA04, EA11)	Petrol	79	03/99 → 08/03
2.0 16V	Petrol	102	01/02 → 08/03
2.0 16V IDE (EA03, EA0P, EA14)	Petrol	103	11/99 → 08/03

MEGANE I Classic (LA0/1_)

1.4 16V (LA0D, LA1H, IA0W, LA10)	Petrol	70	03/99 → 08/03
1.6 16V (La04, LA11, LA0B, LA1C, LA1J)	Petrol	79	03/99 → 08/03
1.8 16V (LA06, LA12, LA1A, LA1M, LA1R)	Petrol	85	01/01 → 08/03

MEGANE I Coach (DA0/1_)

1.4 16V (DA0D, DA1H, DA0W, DA10)	Petrol	70	03/99 → 08/03
1.6 16V (DA0B, DA04, DA11)	Petrol	79	03/99 → 08/03
2.0 16V	Petrol	102	01/02 → 08/03
2.0 16V IDE (DA03, DA0P, DA14)	Petrol	103	11/99 → 08/03

MEGANE I Grandtour (KA0/1_)

1.4 16V (KA0D, KA1H, KA0W, KA10)	Petrol	70	03/99 → 08/03
1.4 e (KA0V)	Petrol	55	03/99 → 08/03

SPA108



KW



RENAULT

MEGANE I Grandtour (KA0/1_)

1.6 16V (KA0B, KA04, KA11) Petrol 79 03/99 → 08/03

1.8 16V (KA0S, KA12, KA1A, KA1M, KA1R) Petrol 85 01/01 → 08/03

MEGANE II (BM0/1_, CM0/1_)

1.4 16V Petrol 60 10/03 → 01/05

1.4 16V (BM0B, CM0B) Petrol 72 11/02 →

1.5 dCi Diesel 74 10/03 → 01/05

1.6 16V (BM0C, CM0C) Petrol 83 11/02 →

1.6 Flex-Fuel BiFuel 77 01/07 →

2.0 Petrol 169 08/06 → 11/07

2.0 16V (BM0U, CM0U) Petrol 99 11/02 →

2.0 16V Turbo Petrol 120 08/04 → 11/07

2.0 Renault Sport Petrol 165 05/04 → 11/07

MEGANE II Coupé-Cabriolet (EM0/1_)

1.6 Petrol 83 09/03 → 01/05

2.0 Petrol 99 09/03 →

2.0 16V Turbo Petrol 120 05/04 → 11/07

MEGANE II Station wagon (KM0/1_)

1.4 Petrol 72 08/03 → 01/05

1.5 dCi Diesel 74 02/04 → 01/05

1.6 Petrol 83 08/03 → 01/05

1.6 16V Hi-Flex BiFuel 77 02/08 →

2.0 Petrol 99 08/03 → 11/07

MEGANE II Tre volumi (LM0/1_)

1.4 Petrol 60 09/03 → 01/05

1.4 Petrol 72 09/03 → 01/05

1.6 Petrol 77 05/05 →

1.6 Petrol 83 09/03 → 01/05

2.0 Petrol 99 09/03 → 11/07

MEGANE Scenic (JA0/1_)

1.6 16V (JA0B, JA04, JA11) Petrol 79 04/98 → 10/99

MODUS / GRAND MODUS (F/JP0_)

1.2 (FP0C, FP0K, FP0P) Petrol 48 05/05 → 06/07

1.2 (JP0C, JP0K, FP0C, FP0K, FP0P, JP0P, JP0T) Petrol 55 12/04 → 06/07

SPA108



KW



RENAULT

MODUS / GRAND MODUS (F/JP0_)

1.5 dCi (FP0D, JP0D) Diesel 60 09/04 → 01/05

1.5 dCi (FP0E, JP0E) Diesel 48 12/04 → 01/05

1.5 dCi (FP0G, JP0G) Diesel 50 12/04 → 01/05

1.6 (JP03, JP0B, JP0U, JP0Y, JP1G) Petrol 82 12/04 → 01/05

SANDERO/STEPWAY

1.4 Petrol 55 02/09 →

1.6 Petrol 62 11/10 →

1.6 Petrol 75 12/07 →

1.6 Petrol 76 12/07 →

SCÉNIC I (JA0/1_)

1.4 16V (JA0D, JA1H, JA0W, JA10) Petrol 70 09/99 → 08/03

1.6 Petrol 75 03/01 → 08/03

1.8 16V (JA12, JA1R, JA1M, JA1A) Petrol 85 01/01 → 08/03

1.8 4x4 Petrol 85 07/00 → 04/01

2.0 16V Petrol 103 09/99 → 08/03

2.0 16V (JA1B, JA1D) Petrol 102 07/00 → 08/03

2.0 16V RX4 Petrol 102 06/00 → 08/03

SCÉNIC II (JM0/1_)

1.4 (JM0B, JM0H, JM1A) Petrol 72 06/03 → 01/05

1.5 dCi (JM02, JM13) Diesel 74 11/03 → 01/05

1.5 dCi (JM0F) Diesel 60 06/03 → 01/05

1.6 (JM0C, JM0J, JM1B) Petrol 83 06/03 → 01/05

1.9 dCi (JM0G, JM12, JM1G, JM2C) Diesel 88 06/03 → 01/05

2.0 (JM05, JM0U, JM1N, JM1U, JM2V) Petrol 99 06/03 →

2.0 16V Turbo (JM0W) Petrol 120 05/04 →

SPA108

KW

RENAULT
THALIA I (LB0/1/2_)

1.2 16V	Petrol	55	04/02 →
1.4	Petrol	55	08/00 →
1.4 16V	Petrol	72	08/00 →
1.5 dCi	Diesel	60	02/03 → 01/05
1.6 16V	Petrol	79	04/02 →

THALIA II (LU1/2_)

1.2 16V (LU2V)	Petrol	55	09/08 →
----------------	--------	----	---------

TRAFIC II Autobus (JL)

1.9 dCi 100 (JLOC)	Diesel	74	03/01 → 01/05
1.9 dCi 80 (JLOB)	Diesel	60	03/01 → 01/05
2.0 (JLOA)	Petrol	88	03/01 →
2.0 16V	Petrol	86	08/06 →
2.5 dCi 135 (JLOD)	Diesel	99	05/03 → 01/05

TRAFIC II Furgonato (FL)

1.9 dCi 100 (FLOC)	Diesel	74	03/01 → 01/05
1.9 dCi 80 (FLOB)	Diesel	60	03/01 → 01/05
2.0 (FLOA)	Petrol	88	03/01 →
2.0 16V	Petrol	86	08/06 →
2.5 dCi 135 (FLOD)	Diesel	99	05/03 → 01/05
2.5 DTi	Diesel	99	03/03 → 07/03

TRAFIC II Pianale piatto/Telaio (EL)

1.9 dCi 100 (ELOC)	Diesel	74	09/01 → 01/05
1.9 dCi 80 (ELOB)	Diesel	60	08/03 → 01/05
2.0 (ELOA)	Petrol	88	09/01 → 07/06
2.5 dCi 135 (ELOD)	Diesel	99	03/03 → 01/05

TWINGO I (C06_)

1.2 16V (C06C, C06D, C06K)	Petrol	55	01/01 →
----------------------------	--------	----	---------

TWINGO I Furgonato (S06_)

1.2 (S066, S068)	Petrol	43	03/97 →
------------------	--------	----	---------

TWINGO II (CN0_)

1.2 (CN0D)	Petrol	43	03/07 → 04/09
1.2 16V (CN04, CN0A, CN0B)	Petrol	55	03/07 → 06/07

SPA108

KW

RENAULT
VEL SATIS (BJ0_)

2.0 16 V Turbo	Petrol	125	04/04 →
2.0 16V Turbo (BJ0K)	Petrol	120	06/02 →
2.0 Turbo	Petrol	108	04/05 →
2.2 dCi	Diesel	83	12/04 → 01/05
2.2 dCi (BJ0E, BJ0F)	Diesel	110	06/02 → 01/05
2.2 dCi (BJ0E, BJ0F, BJ0G, BJ0H)	Diesel	102	09/04 → 01/05
2.2 dCi (BJ0H)	Diesel	85	04/04 → 01/05

VAUXHALL
VIVARO Combi (J7)

2.0 16V	Petrol	88	08/01 → 12/06
2.0 ECOTEC	Petrol	86	08/06 → 07/14

VIVARO Furgonato (F7)

2.0 16V	Petrol	88	03/02 → 12/06
2.0 ECOTEC	Petrol	86	08/06 → 07/14

VIVARO Pianale piatto/Telaio (E7)

2.0 16V	Petrol	88	04/03 → 07/06
2.0 ECOTEC	Petrol	86	08/06 → 07/14

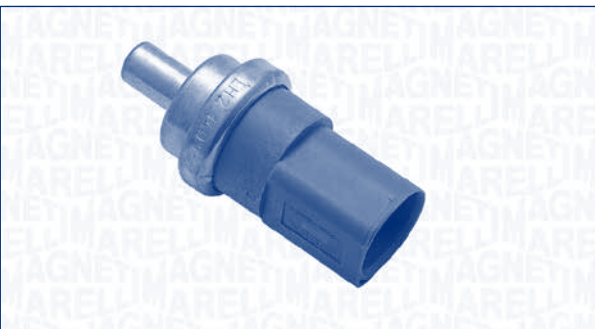
SPA109
F1 **SENSORE TEMPERATURA REFRIGERANTE**
COOLANT TEMPERATURE SENSOR

KW

AUDI
A2 (8Z0)

1.2 TDI	Diesel	45	03/01 → 08/05
1.4	Petrol	55	02/00 → 08/05
1.4 TDI	Diesel	55	02/00 → 08/05
1.4 TDI	Diesel	66	11/03 → 08/05
1.6 FSI	Petrol	81	05/02 → 08/05

SPA109



KW



AUDI

A3 (8L1)

1.6	Petrol	75	08/00 → 05/03	
1.8 T	Petrol	132	12/98 → 05/03	CHASSIS: 8LX035001 →
1.8 T quattro	Petrol	110	12/96 → 05/03	CHASSIS: 8LX035001 →
1.8 T quattro	Petrol	132	10/98 → 05/03	CHASSIS: 8LX035001 →
1.9 TDI	Diesel	96	08/00 → 05/03	
1.9 TDI	Diesel	74	10/00 → 05/03	
1.9 TDI quattro	Diesel	96	08/00 → 05/03	
S3 quattro	Petrol	154	03/99 → 04/02	CHASSIS: 8LX035001 →
S3 quattro	Petrol	165	10/01 → 05/03	

A4 (8D2, B5)

1.6	Petrol	74	11/94 → 10/00	CHASSIS: 8DY000001 →
1.6	Petrol	75	07/00 → 11/00	CHASSIS: 8DY000001 →
1.8	Petrol	85	04/95 → 11/00	CHASSIS: 8DY000001 →
1.8	Petrol	92	01/95 → 11/00	CHASSIS: 8DY000001 →
1.8	Petrol	95	07/99 → 11/00	CHASSIS: 8DY000001 →
1.8 quattro	Petrol	85	07/95 → 11/00	CHASSIS: 8DY000001 →
1.8 quattro	Petrol	92	01/95 → 11/00	CHASSIS: 8DY000001 →
1.8 T	Petrol	110	01/95 → 11/00	CHASSIS: 8DY000001 →
1.8 T	Petrol	132	12/97 → 11/00	CHASSIS: 8DY000001 →
1.8 T quattro	Petrol	110	01/95 → 11/00	CHASSIS: 8DY000001 →
1.8 T quattro	Petrol	132	12/97 → 11/00	CHASSIS: 8DY000001 →
1.9 TDI	Diesel	55	12/95 → 11/00	CHASSIS: 8DY000001 →
1.9 TDI	Diesel	66	01/95 → 11/00	CHASSIS: 8DY000001 →
1.9 TDI	Diesel	81	10/95 → 11/00	CHASSIS: 8DY000001 →
1.9 TDI	Diesel	85	03/00 → 11/00	CHASSIS: 8DY000001 →

SPA109



KW



AUDI

A4 (8D2, B5)

1.9 TDI quattro	Diesel	85	03/00 → 11/00	CHASSIS: 8DY000001 →
2.4	Petrol	120	08/97 → 11/00	CHASSIS: 8DY000001 →
2.4	Petrol	121	03/97 → 11/00	CHASSIS: 8DY000001 →
2.4 quattro	Petrol	120	08/97 → 11/00	CHASSIS: 8DY000001 →
2.4 quattro	Petrol	121	03/97 → 11/00	CHASSIS: 8DY000001 →
2.5 TDI	Diesel	110	09/97 → 11/00	CHASSIS: 8DW240001 →
2.5 TDI quattro	Diesel	110	09/97 → 11/00	CHASSIS: 8DW240001 →
2.8	Petrol	142	10/96 → 11/00	CHASSIS: 8DY000001 →
2.8 quattro	Petrol	142	10/96 → 08/01	CHASSIS: 8DY000001 →
S4 quattro	Petrol	195	09/97 → 09/01	CHASSIS: 8DY000001 →

A4 (8E2, B6)

1.6	Petrol	75	11/00 → 12/04	
1.8 T	Petrol	110	11/00 → 07/02	
1.8 T	Petrol	120	07/02 → 12/04	
1.8 T	Petrol	140	11/02 → 12/04	
1.8 T quattro	Petrol	110	11/00 → 07/02	
1.8 T quattro	Petrol	120	07/02 → 12/04	
1.8 T quattro	Petrol	140	11/02 → 12/04	
1.9 TDI	Diesel	85	06/04 → 12/04	
1.9 TDI	Diesel	96	11/00 → 12/04	
1.9 TDI	Diesel	74	05/01 → 12/04	
1.9 TDI quattro	Diesel	96	11/01 → 12/04	
2.0	Petrol	96	11/00 → 12/04	
2.0 FSI	Petrol	110	07/02 → 12/04	
2.4	Petrol	125	09/01 → 12/04	
2.4	Petrol	120	09/01 → 12/04	
2.5 TDI	Diesel	114	08/01 → 07/02	
2.5 TDI	Diesel	120	07/02 → 12/04	
2.5 TDI quattro	Diesel	132	11/00 → 12/04	
3.0	Petrol	160	04/01 → 12/04	
3.0	Petrol	162	11/00 → 12/04	
3.0 quattro	Petrol	160	04/01 → 12/04	
3.0 quattro	Petrol	162	11/00 → 12/04	
S4 quattro	Petrol	253	03/03 → 12/04	

SPA109

AUDI
A4 (8EC, B7)

1.6	Petrol	75	11/04 → 06/08	
1.8 T	Petrol	120	11/04 → 06/08	
1.8 T quattro	Petrol	120	11/04 → 06/08	
1.9 TDI	Diesel	85	11/04 → 06/08	
2.0	Petrol	96	11/04 → 06/08	
2.0 TDI quattro	Diesel	120	06/06 → 06/08	
2.0 TDI quattro	Diesel	125	06/06 → 06/08	
2.0 TDI quattro	Diesel	103	06/06 → 06/08	
2.0 TFSI	Petrol	125	03/07 → 06/08	
2.0 TFSI	Petrol	147	11/04 → 06/08	
2.0 TFSI	Petrol	162	06/05 → 06/08	
2.0 TFSI quattro	Petrol	147	11/04 → 06/08	
2.0 TFSI quattro	Petrol	162	06/05 → 06/08	
2.5 TDI	Diesel	120	11/04 → 05/06	
3.0	Petrol	160	11/04 → 05/06	
3.0 quattro	Petrol	160	11/04 → 07/06	
3.0 TDI quattro	Diesel	150	11/04 → 06/08	
3.0 TDI quattro	Diesel	171	01/06 → 06/08	
3.2 FSI quattro	Petrol	188	01/05 → 06/08	
S4 quattro	Petrol	253	11/04 → 06/08	

A4 Avant (8D5, B5)

1.6	Petrol	74	11/94 → 09/01	CHASSIS: 8DY000001 →
1.6	Petrol	75	07/00 → 09/01	CHASSIS: 8DY000001 →
1.8	Petrol	85	07/95 → 09/01	CHASSIS: 8DY000001 →
1.8	Petrol	92	02/96 → 09/01	CHASSIS: 8DY000001 →
1.8 quattro	Petrol	85	07/95 → 09/01	CHASSIS: 8DY000001 →
1.8 quattro	Petrol	92	01/96 → 09/01	CHASSIS: 8DY000001 →
1.8 T	Petrol	110	03/96 → 09/01	CHASSIS: 8DY000001 →
1.8 T	Petrol	132	12/97 → 09/01	CHASSIS: 8DY000001 →
1.8 T quattro	Petrol	110	01/96 → 09/01	CHASSIS: 8DY000001 →
1.8 T quattro	Petrol	132	12/97 → 09/01	CHASSIS: 8DY000001 →
1.9 DUO	Diesel	66	07/99 → 09/01	CHASSIS: 8DY000001 →

SPA109

AUDI
A4 Avant (8D5, B5)

1.9 TDI	Diesel	55	03/96 → 09/01	CHASSIS: 8DY000001 →
1.9 TDI	Diesel	66	02/96 → 09/01	CHASSIS: 8DY000001 →
1.9 TDI	Diesel	81	02/96 → 09/01	CHASSIS: 8DY000001 →
1.9 TDI	Diesel	85	03/00 → 09/01	CHASSIS: 8DY000001 →
1.9 TDI quattro	Diesel	85	03/00 → 09/01	CHASSIS: 8DY000001 →
2.4	Petrol	120	08/97 → 09/01	CHASSIS: 8DY000001 →
2.4	Petrol	121	03/97 → 09/01	CHASSIS: 8DY000001 →
2.4 quattro	Petrol	120	08/97 → 09/01	CHASSIS: 8DY000001 →
2.4 quattro	Petrol	121	03/97 → 09/01	CHASSIS: 8DY000001 →
2.5 TDI	Diesel	110	09/97 → 09/01	CHASSIS: 8DW240001 →
2.5 TDI quattro	Diesel	110	09/97 → 09/01	CHASSIS: 8DW240001 →
2.8	Petrol	142	10/96 → 09/01	CHASSIS: 8DY000001 →
2.8 quattro	Petrol	142	10/96 → 09/01	CHASSIS: 8DY000001 →
RS4 quattro	Petrol	280	05/00 → 09/01	
S4 quattro	Petrol	195	09/97 → 09/01	CHASSIS: 8DY000001 →

A4 Avant (8E5, B6)

1.6	Petrol	75	09/01 → 12/04	
1.8 T	Petrol	110	09/01 → 07/02	
1.8 T	Petrol	120	07/02 → 12/04	
1.8 T	Petrol	140	11/02 → 12/04	
1.8 T quattro	Petrol	110	09/01 → 07/02	
1.8 T quattro	Petrol	120	07/02 → 12/04	
1.8 T quattro	Petrol	140	11/02 → 12/04	
1.9 TDI	Diesel	85	06/04 → 12/04	
1.9 TDI	Diesel	96	09/01 → 12/04	
1.9 TDI	Diesel	74	11/01 → 12/04	
1.9 TDI quattro	Diesel	96	11/01 → 12/04	
2.0	Petrol	96	09/01 → 12/04	
2.0 FSI	Petrol	110	07/02 → 12/04	
2.4	Petrol	125	09/01 → 12/04	

SPA109



AUDI

A4 Avant (8E5, B6)

2.4	Petrol	120	09/01 → 12/04
2.5 TDI	Diesel	114	09/01 → 07/02
2.5 TDI	Diesel	120	07/02 → 12/04
2.5 TDI quattro	Diesel	132	09/01 → 12/04
3.0	Petrol	160	04/01 → 12/04
3.0	Petrol	162	09/01 → 12/04
3.0 quattro	Petrol	160	04/01 → 12/04
3.0 quattro	Petrol	162	09/01 → 12/04
S4 quattro	Petrol	253	03/03 → 12/04

A4 Avant (8ED, B7)

1.6	Petrol	75	11/04 → 06/08
1.8 T	Petrol	120	11/04 → 06/08
1.8 T quattro	Petrol	120	11/04 → 06/08
1.9 TDI	Diesel	85	11/04 → 06/08
2.0	Petrol	96	11/04 → 06/08
2.0 TDI quattro	Diesel	120	06/06 → 06/08
2.0 TDI quattro	Diesel	125	06/06 → 06/08
2.0 TDI quattro	Diesel	103	06/06 → 06/08
2.0 TFSI	Petrol	125	03/07 → 06/08
2.0 TFSI	Petrol	147	11/04 → 06/08
2.0 TFSI	Petrol	162	02/06 → 06/08
2.0 TFSI quattro	Petrol	147	11/04 → 06/08
2.0 TFSI quattro	Petrol	162	02/06 → 06/08
2.5 TDI	Diesel	120	11/04 → 05/06
3.0	Petrol	160	11/04 → 05/06
3.0 quattro	Petrol	160	11/04 → 07/06
3.0 TDI quattro	Diesel	150	11/04 → 06/08
3.0 TDI quattro	Diesel	171	01/06 → 06/08
3.2 FSI quattro	Petrol	188	01/05 → 06/08
S4 quattro	Petrol	253	11/04 → 06/08

A4 Cabriolet (8H7, B6, 8HE, B7)

1.8 T	Petrol	120	07/02 → 03/09
1.8 T quattro	Petrol	120	05/03 → 03/09
2.0	Petrol	96	09/04 → 12/05
2.4	Petrol	120	04/02 → 12/05
2.4	Petrol	125	04/02 → 12/05
2.5 TDI	Diesel	120	08/02 → 12/05
3.0	Petrol	162	04/02 → 12/05
3.0 quattro	Petrol	162	05/03 → 12/05
S4 quattro	Petrol	253	03/04 → 03/09

SPA109



AUDI

A6 (4B2, C5)

1.8	Petrol	85	05/97 → 01/05	CHASSIS: 4BY000001 →
1.8	Petrol	92	07/97 → 01/05	CHASSIS: 4BY000001 →
1.8 T	Petrol	132	12/97 → 01/05	CHASSIS: 4BY000001 →
1.8 T quattro	Petrol	110	02/97 → 01/05	CHASSIS: 4BY000001 →
1.8 T quattro	Petrol	132	12/97 → 01/05	CHASSIS: 4BY000001 →
1.9 TDI	Diesel	96	08/01 → 01/05	
1.9 TDI	Diesel	81	04/97 → 10/00	CHASSIS: 4BY000001 →
1.9 TDI	Diesel	85	07/00 → 01/05	CHASSIS: 4BY000001 →
2.0	Petrol	96	08/01 → 01/05	
2.4	Petrol	125	08/01 → 01/05	
2.4	Petrol	100	07/98 → 01/05	CHASSIS: 4BY000001 →
2.4	Petrol	115	02/97 → 01/05	CHASSIS: 4BY000001 →
2.4	Petrol	120	02/97 → 01/05	CHASSIS: 4BY000001 →
2.4	Petrol	121	02/97 → 01/05	CHASSIS: 4BY000001 →
2.4 quattro	Petrol	125	08/01 → 01/05	
2.4 quattro	Petrol	115	08/98 → 07/99	CHASSIS: 4BY000001 →
2.4 quattro	Petrol	120	02/97 → 01/05	CHASSIS: 4BY000001 →
2.4 quattro	Petrol	121	02/97 → 01/05	CHASSIS: 4BY000001 →
2.5 TDI	Diesel	110	07/97 → 01/05	CHASSIS: 4BY000001 →
2.5 TDI	Diesel	114	08/01 → 01/05	
2.5 TDI	Diesel	120	07/02 → 01/05	
2.5 TDI	Diesel	132	02/00 → 01/05	CHASSIS: 4BY000001 →
2.5 TDI quattro	Diesel	110	07/97 → 01/05	CHASSIS: 4BY000001 →
2.5 TDI quattro	Diesel	132	02/00 → 01/05	CHASSIS: 4BY000001 →
2.7 T	Petrol	169	02/99 → 01/05	CHASSIS: 4BY000001 →

SPA109

AUDI
A6 (4B2, C5)

2.7 T quattro	Petrol	169	12/97 → 01/05	CHASSIS: 4BY000001 →
2.7 T quattro	Petrol	184	08/01 → 01/05	
2.8	Petrol	132	10/97 → 05/00	CHASSIS: 4BY000001 →
2.8	Petrol	140	07/99 → 01/05	CHASSIS: 4BY000001 →
2.8	Petrol	142	02/97 → 01/05	CHASSIS: 4BY000001 →
2.8 quattro	Petrol	140	07/99 → 05/01	
2.8 quattro	Petrol	142	02/97 → 01/05	CHASSIS: 4BY000001 →
3.0	Petrol	162	08/01 → 01/05	
3.0 quattro	Petrol	160	06/01 → 07/04	
3.0 quattro	Petrol	162	08/01 → 01/05	
4.2 quattro	Petrol	220	11/98 → 01/05	
RS6 quattro	Petrol	331	07/02 → 01/05	
S6 quattro	Petrol	250	09/99 → 01/05	

A6 (4F2, C6)

3.0	Petrol	160	08/04 → 05/06	
3.0 quattro	Petrol	160	05/04 → 05/06	

A6 Avant (4B5, C5)

1.8	Petrol	85	02/98 → 01/05	CHASSIS: 4BY000001 →
1.8	Petrol	92	12/97 → 01/05	CHASSIS: 4BY000001 →
1.8 T	Petrol	110	12/97 → 01/05	CHASSIS: 4BY000001 →
1.8 T	Petrol	132	04/99 → 01/05	CHASSIS: 4BY000001 →
1.8 T quattro	Petrol	110	12/97 → 01/05	CHASSIS: 4BY200001 →
1.8 T quattro	Petrol	132	12/97 → 01/05	CHASSIS: 4BY000001 →
1.9 TDI	Diesel	96	08/01 → 01/05	
1.9 TDI	Diesel	81	02/98 → 04/01	CHASSIS: 4BY000001 →
1.9 TDI	Diesel	85	07/00 → 01/05	CHASSIS: 4BY000001 →
2.0	Petrol	96	08/01 → 01/05	
2.4	Petrol	125	08/01 → 01/05	
2.4	Petrol	100	07/98 → 01/05	CHASSIS: 4BY000001 →

SPA109

AUDI
A6 Avant (4B5, C5)

2.4	Petrol	115	12/97 → 01/05	CHASSIS: 4BY000001 →
2.4	Petrol	120	12/97 → 01/05	CHASSIS: 4BY000001 →
2.4	Petrol	121	12/97 → 01/05	CHASSIS: 4BY000001 →
2.4 quattro	Petrol	125	08/01 → 01/05	
2.4 quattro	Petrol	115	08/98 → 05/01	CHASSIS: 4BY000001 →
2.4 quattro	Petrol	120	12/97 → 01/05	CHASSIS: 4BY000001 →
2.4 quattro	Petrol	121	12/97 → 01/05	CHASSIS: 4BY000001 →
2.5 TDI	Diesel	110	12/97 → 01/05	CHASSIS: 4BY000001 →
2.5 TDI	Diesel	114	08/01 → 01/05	
2.5 TDI	Diesel	120	07/02 → 01/05	
2.5 TDI	Diesel	132	02/00 → 01/05	CHASSIS: 4BY000001 →
2.5 TDI quattro	Diesel	110	12/97 → 01/05	CHASSIS: 4BY000001 →
2.5 TDI quattro	Diesel	132	02/00 → 01/05	CHASSIS: 4BY000001 →
2.7 T	Petrol	169	02/99 → 01/05	CHASSIS: 4BY000001 →
2.7 T quattro	Petrol	169	12/97 → 01/05	CHASSIS: 4BY000001 →
2.7 T quattro	Petrol	184	08/01 → 01/05	
2.8	Petrol	132	12/97 → 05/00	CHASSIS: 4BY000001 →
2.8	Petrol	140	07/99 → 01/05	CHASSIS: 4BY000001 →
2.8	Petrol	142	12/97 → 01/05	CHASSIS: 4BY000001 →
2.8 quattro	Petrol	142	12/97 → 01/05	CHASSIS: 4BY000001 →
3.0	Petrol	162	08/01 → 01/05	
3.0 quattro	Petrol	162	08/01 → 01/05	
4.2 quattro	Petrol	220	11/98 → 01/05	
RS6 plus quattro	Petrol	353	04/04 → 09/04	
RS6 quattro	Petrol	331	07/02 → 09/04	
S6 quattro	Petrol	250	09/99 → 01/05	

SPA109



KW



AUDI

A6 Avant (4F5, C6)

3.0	Petrol	160	03/05 → 05/06
3.0 quattro	Petrol	160	03/05 → 05/06

A8 (4D2, 4D8)

2.5 TDI quattro	Diesel	110	07/97 → 04/00
3.3 TDI quattro	Diesel	165	06/00 → 09/02
3.7	Petrol	191	11/98 → 09/02
3.7 quattro	Petrol	191	11/98 → 09/02
4.2 quattro	Petrol	175	02/99 → 04/00
4.2 quattro	Petrol	228	11/98 → 09/02
6.0 W12 quattro	Petrol	309	01/01 → 09/02
S 8 quattro	Petrol	265	06/99 → 09/02

A8 (4E_)

3.0	Petrol	160	07/03 → 05/06
3.0	Petrol	162	07/03 → 05/05
3.0 quattro	Petrol	162	08/03 → 05/05

ALLROAD (4BH, C5)

2.5 TDI quattro	Diesel	120	05/03 → 08/05
2.5 TDI quattro	Diesel	132	05/00 → 08/05
2.7 T quattro	Petrol	184	05/00 → 08/05
4.2 V8 quattro	Petrol	220	04/03 → 08/05

TT (8N3)

1.8 T	Petrol	110	09/02 → 06/06
1.8 T	Petrol	120	09/05 → 06/06
1.8 T	Petrol	132	10/98 → 06/06 CHASSIS: 8NY000001 →
1.8 T	Petrol	140	09/05 → 06/06
1.8 T quattro	Petrol	132	10/98 → 06/06 CHASSIS: 8NY000001 →
1.8 T quattro	Petrol	140	09/05 → 06/06
1.8 T quattro	Petrol	165	10/98 → 06/06 CHASSIS: 8NY000001 →
1.8 T quattro	Petrol	176	03/05 → 06/06
3.2 VR6 quattro	Petrol	184	07/03 → 06/06

TT Roadster (8N9)

1.8 T	Petrol	110	01/01 → 06/06
1.8 T	Petrol	120	09/05 → 06/06
1.8 T	Petrol	132	10/99 → 06/06 CHASSIS: 8NY000001 →
1.8 T	Petrol	140	09/05 → 06/06
1.8 T quattro	Petrol	132	02/00 → 06/06 CHASSIS: 8NY000001 →
1.8 T quattro	Petrol	140	09/05 → 06/06
1.8 T quattro	Petrol	165	10/99 → 06/06 CHASSIS: 8NY000001 →

SPA109



KW



AUDI

TT Roadster (8N9)

3.2 VR6 quattro	Petrol	184	07/03 → 06/06
-----------------	--------	-----	---------------

FORD

GALAXY (WGR)

1.9 TDI	Diesel	66	09/99 → 09/00
1.9 TDI	Diesel	85	04/00 → 05/06

SEAT

ALHAMBRA (7V8, 7V9)

1.9 TDI	Diesel	85	06/00 → 03/10
1.9 TDI 4motion	Diesel	85	06/00 → 03/10

AROSA (6H)

1.4 16V	Petrol	74	01/00 → 06/04
---------	--------	----	---------------

CORDOBA (6K2)

1.4 16V	Petrol	55	05/00 → 10/02
1.4 16V	Petrol	74	02/00 → 10/02
1.6	Petrol	55	06/99 → 10/02

CORDOBA Vario (6K5)

1.4 16V	Petrol	55	06/99 → 12/02
1.6	Petrol	55	06/99 → 12/02

EXEO (3R2)

1.6	Petrol	75	03/09 → 09/10
1.8 T	Petrol	110	12/08 → 05/10

EXEO ST (3R5)

1.6	Petrol	75	06/09 → 09/10
1.8 T	Petrol	110	06/09 → 05/10

IBIZA III (6K1)

1.4	Petrol	44	08/99 → 02/02
1.4 16V	Petrol	55	05/00 → 02/02
1.4 16V	Petrol	74	08/99 → 02/02
1.6	Petrol	55	08/99 → 02/02

INCA (6K9)

1.4 16V	Petrol	55	09/00 → 06/03
---------	--------	----	---------------

LEON (1M1)

1.4 16V	Petrol	55	11/99 → 06/06
1.6	Petrol	74	11/99 → 06/06
1.6 16 V	Petrol	77	09/00 → 06/06
1.8 20V	Petrol	92	11/99 → 06/06
1.8 20V T	Petrol	132	11/99 → 06/06
1.8 20V T 4	Petrol	132	11/99 → 06/06
1.8 T Cupra R	Petrol	154	02/02 → 06/06
1.8 T Cupra R	Petrol	165	07/03 → 06/06
1.9 SDI	Diesel	50	11/99 → 06/06
1.9 TDI	Diesel	74	10/05 → 06/06
1.9 TDI	Diesel	110	02/01 → 06/06
1.9 TDI	Diesel	66	11/99 → 06/06

SPA109

SEAT
LEON (1M1)

1.9 TDI	Diesel	81	11/99 → 06/06
1.9 TDI	Diesel	96	05/03 → 06/06
1.9 TDI Syncro	Diesel	110	05/02 → 06/06
2.8	Petrol	150	05/02 → 06/04
2.8 Cupra 4	Petrol	150	02/01 → 06/06

TOLEDO II (1M2)

1.4 16V	Petrol	55	07/99 → 05/06
1.6	Petrol	74	04/99 → 09/00
1.6 16V	Petrol	77	09/00 → 05/06
1.8 20V	Petrol	92	04/99 → 05/06
1.8 20VT	Petrol	132	05/01 → 05/06
1.9 SDI	Diesel	50	06/00 → 06/04
1.9 TDI	Diesel	110	10/00 → 05/06
1.9 TDI	Diesel	66	04/99 → 05/06
1.9 TDI	Diesel	81	04/99 → 05/06
1.9 TDI	Diesel	96	05/03 → 05/06
2.3 V5	Petrol	110	04/99 → 05/01
2.3 V5 20V	Petrol	125	05/01 → 05/06

SKODA
OCTAVIA (1U2)

1.4	Petrol	44	04/99 → 03/01	CHASSIS: 1UX134201 →
1.4 16V	Petrol	55	09/00 → 12/10	
1.6	Petrol	75	11/00 → 12/10	
1.8 T	Petrol	110	08/97 → 12/10	CHASSIS: 1UX134201 →
1.8 T 4x4	Petrol	110	05/01 → 05/06	
1.9 SDI	Diesel	50	06/97 → 12/03	CHASSIS: 1UX134201 →
1.9 TDI	Diesel	74	10/05 → 12/10	
1.9 TDI	Diesel	81	08/97 → 01/06	CHASSIS: 1UX134201 →
1.9 TDI	Diesel	96	09/02 → 09/04	
2.0	Petrol	85	04/99 → 05/07	CHASSIS: 1UX134201 →
RS 1.8 T	Petrol	132	05/01 → 01/06	

OCTAVIA Combi (1U5)

1.4 16V	Petrol	55	08/00 → 12/10	
1.6	Petrol	55	07/98 → 09/04	
1.6	Petrol	74	08/00 → 12/07	CHASSIS: 1UX134201 →
1.6	Petrol	75	09/00 → 12/10	
1.8 20V	Petrol	92	07/98 → 07/00	CHASSIS: 1UX134201 →

SPA109

SKODA
OCTAVIA Combi (1U5)

1.8 T	Petrol	110	07/98 → 12/10	CHASSIS: 1UX134201 →
1.8 T 4x4	Petrol	110	05/01 → 05/06	
1.9 SDI	Diesel	50	07/98 → 12/03	CHASSIS: 1UX134201 →
1.9 TDI	Diesel	66	07/98 → 03/10	CHASSIS: 1UX134201 →
1.9 TDI	Diesel	74	08/00 → 12/10	
1.9 TDI	Diesel	81	07/98 → 01/06	CHASSIS: 1UX134201 →
1.9 TDI	Diesel	96	09/02 → 09/04	
1.9 Tdi 4x4	Diesel	66	11/99 → 02/06	
1.9 Tdi 4x4	Diesel	74	09/00 → 01/06	
2.0	Petrol	85	04/99 → 05/07	CHASSIS: 1UX134201 →
2.0 4x4	Petrol	85	08/00 → 09/04	
2.0 4x4	Petrol	88	01/00 → 12/10	
RS 1.8 T	Petrol	132	08/02 → 01/06	

SUPERB (3U4)

1.8 T	Petrol	110	12/01 → 03/08	
1.9 TDI	Diesel	77	10/05 → 05/07	
1.9 TDI	Diesel	85	01/07 → 03/08	
1.9 TDI	Diesel	74	08/02 → 10/05	
1.9 TDI	Diesel	96	12/01 → 03/08	
2.0	Petrol	85	12/01 → 03/08	
2.0 TDi	Diesel	103	10/05 → 03/08	
2.5 TDI	Diesel	120	06/03 → 03/08	
2.5 TDI	Diesel	114	12/01 → 08/03	
2.8 V6	Petrol	142	12/01 → 03/08	

VOLKSWAGEN
BORA (1J2)

1.4 16V	Petrol	55	03/00 → 05/05	
1.6	Petrol	74	10/98 → 05/05	
1.6	Petrol	75	08/00 → 05/05	
1.6 16V	Petrol	77	05/00 → 05/05	
1.6 FSI	Petrol	81	01/02 → 05/05	
1.8	Petrol	92	10/98 → 05/05	
1.8 4motion	Petrol	92	02/99 → 05/05	
1.8 T	Petrol	110	05/00 → 05/05	
1.8 T	Petrol	132	03/02 → 05/05	
1.9 SDI	Diesel	50	05/99 → 05/05	CHASSIS: 1JY000001 →
1.9 TDI	Diesel	96	11/00 → 05/05	
1.9 TDI	Diesel	110	09/00 → 05/05	

SPA109



KW



VOLKSWAGEN

BORA (1J2)

1.9 TDI	Diesel	66	05/99 → 06/01	CHASSIS: 1JY000001 →
1.9 TDI	Diesel	74	09/00 → 05/05	
1.9 TDI	Diesel	81	10/98 → 06/01	
1.9 TDI	Diesel	85	12/98 → 01/02	
1.9 TDI 4motion	Diesel	96	11/00 → 05/05	
1.9 TDI 4motion	Diesel	110	09/00 → 05/05	
1.9 TDI 4motion	Diesel	66	05/99 → 06/01	CHASSIS: 1JY000001 →
1.9 TDI 4motion	Diesel	74	09/00 → 05/05	
1.9 TDI 4motion	Diesel	85	02/99 → 06/01	
2.0	Petrol	85	10/98 → 05/05	
2.0 4motion	Petrol	85	04/00 → 05/05	
2.3 V5	Petrol	110	10/98 → 10/00	CHASSIS: 1JY000001 →
2.3 V5	Petrol	125	10/00 → 05/05	CHASSIS: 1JY000001 →
2.3 V5 4motion	Petrol	110	12/98 → 10/00	CHASSIS: 1JY000001 →
2.3 V5 4motion	Petrol	125	10/00 → 05/05	CHASSIS: 1JY000001 →
2.8 V6 4motion	Petrol	150	03/99 → 05/05	CHASSIS: 1JY000001 →

BORA Station wagon (1J6)

1.4 16V	Petrol	55	09/01 → 05/05	
1.6	Petrol	74	05/99 → 05/05	
1.6	Petrol	75	08/00 → 05/05	
1.6 16V	Petrol	77	02/00 → 05/05	
1.6 FSI	Petrol	81	01/02 → 05/05	
1.8 4motion	Petrol	92	05/99 → 05/05	
1.8 T	Petrol	110	05/00 → 05/05	
1.8 T	Petrol	132	05/02 → 05/05	
1.9 TDI	Diesel	96	11/00 → 05/05	
1.9 TDI	Diesel	110	05/01 → 05/05	
1.9 TDI	Diesel	66	07/04 → 05/05	
1.9 TDI	Diesel	74	09/00 → 05/05	
1.9 TDI	Diesel	81	05/99 → 06/01	
1.9 TDI	Diesel	85	05/99 → 06/01	
1.9 TDI 4motion	Diesel	96	11/00 → 05/05	
1.9 TDI 4motion	Diesel	110	05/01 → 05/05	
1.9 TDI 4motion	Diesel	74	09/00 → 05/05	
1.9 TDI 4motion	Diesel	85	05/99 → 06/01	
2.0	Petrol	85	05/99 → 05/05	
2.0 4motion	Petrol	85	04/00 → 05/05	

SPA109



KW



VOLKSWAGEN

BORA Station wagon (1J6)

2.3 V5	Petrol	110	05/99 → 10/00	CHASSIS: 1JY000001 →
2.3 V5	Petrol	125	10/00 → 05/05	CHASSIS: 1JY000001 →
2.3 V5 4motion	Petrol	110	05/99 → 10/00	CHASSIS: 1JY000001 →
2.3 V5 4motion	Petrol	125	10/00 → 05/05	CHASSIS: 1JY000001 →
2.8 V6 4motion	Petrol	150	05/99 → 05/05	CHASSIS: 1JY000001 →

CADDY II Furgonato (9K9A)

1.4	Petrol	55	08/00 → 01/04	
1.9 D	Diesel	47	11/95 → 01/04	
1.9 SDI	Diesel	47	11/95 → 01/04	
60 1.4	Petrol	44	11/95 → 01/04	

CADDY II Station wagon (9K9B)

1.4	Petrol	44	11/95 → 01/04	
1.4 16V	Petrol	55	08/00 → 01/04	
1.9 D	Diesel	47	11/95 → 01/04	
1.9 SDI	Diesel	47	11/95 → 01/04	
1.9 TDI	Diesel	66	10/96 → 01/04	

GOLF IV (1J1)

1.4 16V	Petrol	55	08/97 → 06/05	CHASSIS: 1JX250001 →
1.6	Petrol	74	08/97 → 05/04	CHASSIS: 1JX250001 →
1.6	Petrol	75	08/00 → 06/05	CHASSIS: 1JX250001 →
1.6 16V	Petrol	77	02/00 → 06/05	CHASSIS: 1JX250001 →
1.6 FSI	Petrol	81	01/02 → 06/05	
1.8	Petrol	92	08/97 → 06/05	
1.8 4motion	Petrol	92	05/98 → 06/05	
1.8 T	Petrol	110	08/97 → 06/05	CHASSIS: 1JX250001 →
1.8 T GTI	Petrol	132	08/01 → 06/05	
1.9 SDI	Diesel	50	08/97 → 06/05	CHASSIS: 1JX250001 →
1.9 TDI	Diesel	110	05/00 → 06/05	CHASSIS: 1JX250001 →
1.9 TDI	Diesel	66	10/97 → 05/04	CHASSIS: 1JX250001 →
1.9 TDI	Diesel	74	09/00 → 06/05	

SPA109

VOLKSWAGEN
GOLF IV (1J1)

1.9 TDI	Diesel	81	08/97 → 05/04	CHASSIS: 1JX250001 →
1.9 TDI	Diesel	85	12/98 → 06/01	CHASSIS: 1JX250001 →
1.9 TDI	Diesel	96	11/00 → 06/05	CHASSIS: 1JX250001 →
1.9 TDI 4motion	Diesel	110	02/00 → 06/05	CHASSIS: 1JX250001 →
1.9 TDI 4motion	Diesel	66	07/98 → 04/02	CHASSIS: 1JX250001 →
1.9 TDI 4motion	Diesel	74	09/00 → 06/05	
1.9 TDI 4motion	Diesel	85	09/99 → 06/01	CHASSIS: 1JX250001 →
1.9 TDI 4motion	Diesel	96	11/00 → 06/05	CHASSIS: 1JX250001 →
2.0	Petrol	85	07/98 → 05/04	CHASSIS: 1JX250001 →
2.0 4motion	Petrol	85	10/00 → 06/05	CHASSIS: 1JX250001 →
2.3 V5	Petrol	110	08/97 → 10/00	CHASSIS: 1JY000001
2.3 V5	Petrol	125	10/00 → 06/05	CHASSIS: 1JY000001
2.3 V5 4motion	Petrol	110	12/98 → 10/00	CHASSIS: 1JY000001
2.3 V5 4motion	Petrol	125	10/00 → 06/05	CHASSIS: 1JY000001
2.8 V6 4motion	Petrol	150	03/99 → 06/05	CHASSIS: 1JX250001 →
3.2 R32 4motion	Petrol	177	09/02 → 06/05	

GOLF IV Variant (1J5)

1.4 16V	Petrol	55	05/99 → 06/06	CHASSIS: 1JX250001 →
1.6	Petrol	74	05/99 → 04/02	CHASSIS: 1JX250001 →
1.6	Petrol	75	08/00 → 06/06	CHASSIS: 1JX250001 →
1.6 16V	Petrol	77	02/00 → 06/06	CHASSIS: 1JX250001 →
1.6 FSI	Petrol	81	01/02 → 06/06	
1.8 4motion	Petrol	92	05/99 → 06/06	
1.8 T	Petrol	110	05/00 → 06/06	CHASSIS: 1JX250001 →

SPA109

VOLKSWAGEN
GOLF IV Variant (1J5)

1.9 SDI	Diesel	50	05/99 → 06/06	CHASSIS: 1JX250001 →
1.9 TDI	Diesel	66	05/99 → 05/06	CHASSIS: 1JX250001 →
1.9 TDI	Diesel	74	09/00 → 06/06	
1.9 TDI	Diesel	81	05/99 → 06/01	CHASSIS: 1JX250001 →
1.9 TDI	Diesel	85	08/99 → 06/01	CHASSIS: 1JX250001 →
1.9 TDI	Diesel	96	11/00 → 06/06	CHASSIS: 1JX250001 →
1.9 TDI 4motion	Diesel	66	05/99 → 04/02	CHASSIS: 1JX250001 →
1.9 TDI 4motion	Diesel	74	09/00 → 06/06	
1.9 TDI 4motion	Diesel	85	05/99 → 06/01	CHASSIS: 1JX250001 →
1.9 TDI 4motion	Diesel	96	11/00 → 06/06	CHASSIS: 1JX250001 →
2.0	Petrol	85	05/99 → 06/06	CHASSIS: 1JX250001 →
2.0 4motion	Petrol	85	10/00 → 06/06	10
2.0 Bi-Fuel	BiFuel	85	02/02 → 06/06	
2.3 V5	Petrol	110	05/99 → 06/06	CHASSIS: 1JY000001 →
2.3 V5	Petrol	125	10/00 → 06/06	CHASSIS: 1JY000001 →
2.3 V5 4motion	Petrol	110	05/99 → 06/06	CHASSIS: 1JY000001 →
2.3 V5 4motion	Petrol	125	10/00 → 06/06	CHASSIS: 1JY000001 →
2.8 V6 4motion	Petrol	150	05/99 → 06/06	CHASSIS: 1JY000001 →

GOLF V (1K1)

1.4 FSI	Petrol	66	10/03 → 07/06	
1.6	Petrol	75	01/04 → 11/08	

LUPO (6X1, 6E1)

1.0	Petrol	37	09/98 → 07/05	CHASSIS: 6XY000001 →
1.2 TDI 3L	Diesel	45	07/99 → 07/05	
1.4	Petrol	44	10/00 → 07/05	
1.4 16V	Petrol	55	09/98 → 07/05	CHASSIS: 6XY000001 →
1.4 16V	Petrol	74	08/99 → 07/05	

SPA109



VOLKSWAGEN

LUPO (6X1, 6E1)

1.4 FSI	Petrol	77	02/01 → 07/05
1.4 TDI	Diesel	55	01/99 → 07/05
1.6 GTI	Petrol	92	09/00 → 07/05

NEW BEETLE (9C1, 1C1)

1.4	Petrol	55	11/01 → 09/10
1.6	Petrol	74	10/99 → 09/00 CHASSIS: 9CX919700 →
1.6	Petrol	75	06/00 → 09/10
1.8 T	Petrol	110	10/99 → 09/10 CHASSIS: 9CX919700 →
1.8 T	Petrol	132	11/01 → 06/05
1.9 TDI	Diesel	77	07/05 → 09/10
1.9 TDI	Diesel	66	01/98 → 06/04 CHASSIS: 9CX919700 →
1.9 TDI	Diesel	74	02/01 → 09/10
2.0	Petrol	85	01/98 → 09/10 CHASSIS: 9CX919700 →
2.3 V5	Petrol	125	10/00 → 09/10
2.5	Petrol	110	07/05 → 12/05
RSI 3.2 4motion (1C9)	Petrol	165	07/00 → 05/01

NEW BEETLE Cabriolet (1Y7)

1.4	Petrol	55	01/03 → 09/10
1.6	Petrol	75	01/03 → 09/10
1.8 T	Petrol	110	01/03 → 09/10
1.9 TDI	Diesel	77	07/05 → 09/10
1.9 TDI	Diesel	74	06/03 → 09/10
2.0	Petrol	85	09/02 → 10/10
2.5	Petrol	110	07/05 → 12/05

PASSAT (3B2)

1.8	Petrol	85	01/97 → 11/00 CHASSIS: 3BY000001 →
1.8 Syncro/4motion	Petrol	92	10/96 → 11/00 CHASSIS: 3BY000001 →
1.8 T Syncro	Petrol	110	11/96 → 08/00 CHASSIS: 3BY000001 →
1.9 TDI	Diesel	74	02/00 → 11/00
1.9 TDI	Diesel	85	05/99 → 11/00 CHASSIS: 3BY000001 →
1.9 TDI 4motion	Diesel	85	08/99 → 11/00
2.0	Petrol	88	04/00 → 11/00 CHASSIS: 3BY000001 →
2.0 4motion	Petrol	88	04/00 → 11/00 CHASSIS: 3BY000001 →

SPA109



VOLKSWAGEN

PASSAT (3B2)

2.3 VR5 Syncro/4motion	Petrol	110	05/99 → 11/00 CHASSIS: 3BY000001 →
2.5 TDI	Diesel	110	07/98 → 11/00 CHASSIS: 3BY000001 →
2.5 TDI Syncro/4motion	Diesel	110	12/98 → 11/00 CHASSIS: 3BY000001 →
2.8 V6	Petrol	132	05/99 → 09/99
2.8 V6	Petrol	140	09/99 → 11/00

PASSAT (3B3)

1.6	Petrol	75	11/00 → 05/05
1.8	Petrol	92	03/03 → 03/05
1.8 T	Petrol	125	02/01 → 05/05
1.8 T 20V	Petrol	110	11/00 → 05/05
1.9 TDI	Diesel	96	11/00 → 05/05
1.9 TDI	Diesel	74	11/00 → 05/05
1.9 TDI 4motion	Diesel	96	11/00 → 05/05
2.0	Petrol	85	11/00 → 05/05
2.0	Petrol	96	11/01 → 05/05
2.0 4motion	Petrol	85	11/00 → 05/05
2.0 TDi	Diesel	100	12/03 → 05/05
2.3 V5	Petrol	125	11/00 → 05/05
2.3 V5 4motion	Petrol	125	11/00 → 05/05
2.5 TDI	Diesel	120	05/03 → 05/05
2.5 TDI	Diesel	110	11/00 → 05/05 CHASSIS: 3BY000001 →
2.5 TDI 4motion	Diesel	132	01/03 → 05/05
2.5 TDI 4motion	Diesel	110	11/00 → 05/05 CHASSIS: 3BY000001 →
2.8 4motion	Petrol	142	11/00 → 05/05

PASSAT Variant (3B5)

1.8	Petrol	85	06/97 → 11/00 FRM CHASSIS: 3BY000001 →
1.8 Syncro/4motion	Petrol	92	06/97 → 11/00 CHASSIS: 3BY000001 →
1.9 TDI	Diesel	74	02/00 → 11/00
1.9 TDI	Diesel	85	01/99 → 11/00
1.9 TDI 4motion	Diesel	85	08/99 → 08/00
1.9 TDI Syncro/4motion	Diesel	81	05/99 → 11/00 CHASSIS: 3BY000001 →
2.0	Petrol	88	04/00 → 11/00 CHASSIS: 3BY000001 →
2.0 4motion	Petrol	88	04/00 → 11/00 CHASSIS: 3BY000001 →

SPA109

VOLKSWAGEN
PASSAT Variant (3B5)

2.3 VR5 Syncro/4motion	Petrol	110	05/99 → 11/00	CHASSIS: 3BY000001 →
2.5 TDI	Diesel	110	07/98 → 11/00	CHASSIS: 3BY000001 →
2.5 TDI Syncro/4motion	Diesel	110	12/98 → 11/00	CHASSIS: 3BY000001 →
2.8 V6	Petrol	132	05/99 → 09/99	
2.8 V6	Petrol	140	09/99 → 08/00	
2.8 V6 Syncro/4motion	Petrol	142	05/99 → 11/00	CHASSIS: 3BY000001 →

PASSAT Variant (3B6)

1.6	Petrol	75	11/00 → 05/05	
1.8 T	Petrol	125	05/02 → 08/05	
1.8 T 20V	Petrol	110	11/00 → 05/05	
1.9 TDI	Diesel	96	11/00 → 05/05	
1.9 TDI	Diesel	74	11/00 → 05/05	
1.9 TDI 4motion	Diesel	96	11/00 → 05/05	
2.0	Petrol	85	11/00 → 05/05	
2.0	Petrol	96	11/01 → 05/05	
2.0 4motion	Petrol	85	11/00 → 05/05	
2.0 TDi	Diesel	100	12/03 → 05/05	
2.3 VR5	Petrol	125	11/00 → 05/05	
2.3 VR5 4motion	Petrol	125	11/00 → 05/05	
2.5 TDI	Diesel	120	05/03 → 05/05	
2.5 TDI	Diesel	110	11/00 → 05/05	CHASSIS: 3BY000001 →
2.5 TDI 4motion	Diesel	132	01/03 → 05/05	
2.5 TDI 4motion	Diesel	110	11/00 → 05/05	CHASSIS: 3BY000001 →
2.8 4motion	Petrol	142	11/00 → 05/05	

POLO (6N1)

100 1.4 16V	Petrol	74	04/96 → 10/99	
55 1.4	Petrol	40	01/98 → 10/99	
60 1.4	Petrol	44	07/95 → 10/99	

POLO (6N2)

1.0	Petrol	37	10/99 → 09/01	
1.4	Petrol	40	10/99 → 09/01	
1.4	Petrol	44	10/99 → 09/01	
1.4 16V	Petrol	55	10/99 → 09/01	
1.4 16V	Petrol	74	10/99 → 09/01	
1.4 TDI	Diesel	55	10/99 → 09/01	
1.6 16V GTI	Petrol	92	10/99 → 09/01	

SPA109

VOLKSWAGEN
POLO CLASSIC (6KV2)

100 1.6	Petrol	74	12/95 → 09/01	CHASSIS: 6KY503401 →
110 1.9 TDI	Diesel	81	06/98 → 01/02	CHASSIS: 6KY503401 →
68 1.9 SDI	Diesel	50	08/99 → 01/02	CHASSIS: 6KY503401 →
75 1.4 16V	Petrol	55	10/99 → 09/01	
75 1.6	Petrol	55	11/95 → 09/01	

POLO Variant (6KV5)

1.4	Petrol	40	12/98 → 09/01	
1.4 16V	Petrol	55	10/99 → 09/01	
1.6	Petrol	55	05/97 → 09/01	
1.6	Petrol	74	05/97 → 09/01	CHASSIS: 6KY503401 →
1.9 SDI	Diesel	50	08/99 → 09/01	CHASSIS: 6KY503401 →
1.9 TDI	Diesel	66	05/97 → 09/01	CHASSIS: 6KY503401 →
1.9 TDI	Diesel	81	06/98 → 09/01	CHASSIS: 6KY503401 →

SHARAN (7M8, 7M9, 7M6)

1.8 T 20V	Petrol	110	05/99 → 03/10	CHASSIS: 7MY000001 →
-----------	--------	-----	---------------	----------------------

TOUAREG (7LA, 7L6, 7L7)

3.0 V6 TDI	Diesel	165	11/04 → 05/10	
------------	--------	-----	---------------	--

TRANSPORTER IV Furgonato (70XA)

2.5 Syncro	Petrol	85	08/96 → 04/03	CHASSIS: 70X053925 →
2.5 TDI	Diesel	111	09/00 → 04/03	CHASSIS: 70X053925 →
2.5 TDI	Diesel	65	12/98 → 04/03	CHASSIS: 70X053925 →
2.5 TDI	Diesel	75	09/95 → 04/03	CHASSIS: 70X053925 →
2.5 TDI Syncro	Diesel	75	09/95 → 04/03	
2.8 VR6	Petrol	103	05/96 → 05/00	CHASSIS: 70X053925 →
2.8 VR6	Petrol	150	06/00 → 04/03	CHASSIS: 70X053925 →

TRANSPORTER IV Pianale piatto/Telaio (70XD)

2.5 Syncro	Petrol	81	10/92 → 04/03	CHASSIS: 70X053925 →
2.5 Syncro	Petrol	85	08/96 → 04/03	CHASSIS: 70X053925 →

SPA109



KW



VOLKSWAGEN

TRANSPORTER IV Pianale piatto/Telaio (70XD)

2.5 TDI	Diesel	65	05/98 → 04/03	CHASSIS: 70X053925 →
2.5 TDI	Diesel	75	09/95 → 04/03	CHASSIS: 70X053925 →
2.5 TDI Syncro	Diesel	75	05/98 → 04/03	CHASSIS: 70X053925 →
2.8 VR6	Petrol	150	06/00 → 04/03	CHASSIS: 70X053925 →

SPA110

F1

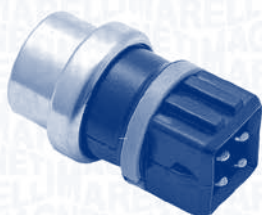
SENSORE TEMPERATURA REFRIGERANTE
COOLANT TEMPERATURE SENSOR

KW



FORD

GALAXY (WGR)

1.9 TDI	Diesel	66	03/95 → 05/06
1.9 TDI	Diesel	81	08/97 → 04/00

SEAT

AROSA (6H)

1.7 SDI	Diesel	44	08/97 → 06/04
---------	--------	----	---------------

CORDOBA (6K2)

1.6	Petrol	55	06/99 → 10/02
-----	--------	----	---------------

CORDOBA Vario (6K5)

1.6	Petrol	55	06/99 → 12/02
-----	--------	----	---------------

IBIZA III (6K1)

1.0	Petrol	37	08/99 → 02/02
1.0 16V	Petrol	51	10/99 → 02/02
1.4	Petrol	44	08/99 → 02/02
1.4 16V	Petrol	55	05/00 → 02/02
1.4 16V	Petrol	74	08/99 → 02/02
1.6	Petrol	55	08/99 → 02/02

SPA110



KW



SEAT

INCA (6K9)

1.4 16V	Petrol	55	09/00 → 06/03
1.6 i	Petrol	55	06/97 → 09/00
1.7 D	Diesel	42	09/96 → 09/00

TOLEDO I (1L)

2.0 i	Petrol	85	05/91 → 03/99
-------	--------	----	---------------

SKODA

FABIA (6Y2)

1.4	Petrol	50	08/99 → 05/03
-----	--------	----	---------------

FABIA Combi (6Y5)

1.4	Petrol	50	04/00 → 05/03
-----	--------	----	---------------

FABIA Tre volumi (6Y3)

1.4	Petrol	50	07/01 → 05/03
-----	--------	----	---------------

FELICIA I (6U1)

1.3	Petrol	43	02/96 → 03/98
-----	--------	----	---------------

FELICIA II (6U1)

1.3	Petrol	40	01/98 → 06/01
1.3	Petrol	43	01/98 → 06/01
1.3	Petrol	50	01/98 → 06/01
1.6	Petrol	55	01/98 → 06/01

FELICIA II Station wagon (6U5)

1.3	Petrol	50	01/98 → 06/01
1.6	Petrol	55	01/98 → 06/01

VOLKSWAGEN

CADDY II Furgonato (9K9A)

1.4	Petrol	55	08/00 → 01/04
75 1.6	Petrol	55	11/95 → 09/00
75 1.6	Petrol	55	11/95 → 05/97

CADDY II Pick-up (9U7)

1.6	Petrol	55	06/96 → 12/00
-----	--------	----	---------------

CADDY II Station wagon (9K9B)

1.4	Petrol	44	11/95 → 01/04
1.6	Petrol	55	06/97 → 09/00
1.6	Petrol	55	11/95 → 05/97

CORRADO (53I)

2.0 i	Petrol	85	04/93 → 12/95
-------	--------	----	---------------

GOLF III (1H1)

1.4	Petrol	44	10/91 → 08/97
1.4	Petrol	40	11/91 → 08/97
1.6	Petrol	55	09/92 → 08/97
1.6	Petrol	74	07/95 → 08/97
1.8	Petrol	55	11/91 → 08/97
1.8	Petrol	66	11/91 → 08/97
1.8 Syncro (1HX1)	Petrol	66	01/93 → 08/97

SPA110

VOLKSWAGEN
GOLF III (1H1)

1.9 SDI	Diesel	47	07/95 → 08/97
1.9 TDI Syncro (1HX1)	Diesel	66	08/95 → 08/97
2.0	Petrol	85	11/91 → 08/97
2.0 Syncro (1HX1)	Petrol	85	08/95 → 08/97

GOLF III Cabriolet (1E7)

1.6	Petrol	74	10/94 → 05/98
1.8	Petrol	55	07/93 → 05/98
1.8	Petrol	66	07/93 → 05/98
2.0	Petrol	85	07/93 → 05/98

GOLF III Variant (1H5)

1.4	Petrol	44	07/93 → 04/99
1.4	Petrol	40	07/93 → 04/99
1.6	Petrol	55	07/93 → 12/97
1.6	Petrol	74	07/94 → 04/99
1.8	Petrol	55	07/93 → 04/99
1.8	Petrol	66	07/93 → 04/99
1.9 TDI Syncro	Diesel	66	07/95 → 04/99
2.0	Petrol	85	07/93 → 04/99
2.0 Syncro	Petrol	85	08/95 → 04/99

GOLF IV Cabriolet (1E7)

1.6	Petrol	74	06/98 → 06/02
1.8	Petrol	55	06/98 → 06/02
1.9 TDI	Diesel	66	06/98 → 06/02

LUPO (6X1, 6E1)

1.0	Petrol	37	10/98 → 05/00
1.7 SDI	Diesel	44	09/98 → 07/05

PASSAT (3A2, 35I)

1.6 TD	Diesel	59	08/92 → 09/93
1.8	Petrol	55	08/92 → 08/96
1.9 D	Diesel	50	08/92 → 10/93
1.9 TD	Diesel	55	08/92 → 09/93
2.0 16V	Petrol	100	08/92 → 09/93

PASSAT Variant (3A5, 35I)

1.6 TD	Diesel	59	08/92 → 09/93
1.8	Petrol	55	08/92 → 05/97
1.9 D	Diesel	50	08/92 → 10/93
1.9 TD	Diesel	55	08/92 → 09/93
2.0 16V	Petrol	100	08/92 → 09/93

POLO (6N1)

1.7 SDI	Diesel	42	04/97 → 10/99
100 1.4 16V	Petrol	74	04/96 → 10/99
55 1.3	Petrol	40	10/94 → 07/95

SPA110

VOLKSWAGEN
POLO (6N1)

55 1.4	Petrol	40	08/95 → 10/99
60 1.7 SDI	Diesel	44	08/97 → 10/99
64 1.9 D	Diesel	47	10/94 → 10/99
64 1.9 SDI	Diesel	47	07/96 → 10/99
75 1.6	Petrol	55	10/94 → 10/99

POLO (6N2)

1.7 SDI	Diesel	44	10/99 → 09/01
1.9 D	Diesel	47	10/99 → 09/01
1.9 SDI	Diesel	47	10/99 → 09/01

POLO CLASSIC (6KV2)

110 1.9 TDI	Diesel	81	09/99 → 01/02
54 1.4	Petrol	40	01/98 → 08/99
57 1.7 SDI	Diesel	42	07/97 → 09/01
60 1.4	Petrol	44	12/95 → 09/01
64 1.9 SDI	Diesel	47	12/95 → 08/99
68 1.9 SDI	Diesel	50	10/99 → 01/02
75 1.6	Petrol	55	11/95 → 09/97
90 1.8	Petrol	66	01/97 → 09/01

POLO Furgonato (6NF)

1.4	Petrol	44	05/98 → 12/99
1.7 SDI	Diesel	44	08/97 → 12/99
1.9 D	Diesel	47	10/94 → 12/99
1.9 SDI	Diesel	47	07/96 → 12/99

POLO Variant (6KV5)

1.4	Petrol	44	05/97 → 09/01
1.7 SDI	Diesel	42	08/97 → 09/01
1.9 SDI	Diesel	47	06/97 → 09/01

SHARAN (7M8, 7M9, 7M6)

2.0 LPG	Petrol/ LPG	85	05/08 → 03/10
---------	----------------	----	---------------

TRANSPORTER IV Furgonato (70XA)

2.5 TDI	Diesel	65	12/98 → 04/03
2.5 TDI Syncro	Diesel	75	09/95 → 04/03

TRANSPORTER IV Pianale piatto/Telaio (70XD)

2.5 TDI	Diesel	65	05/98 → 04/03
---------	--------	----	---------------

VENTO (1H2)

1.4	Petrol	44	11/91 → 09/98
1.6	Petrol	55	09/92 → 09/98
1.6	Petrol	74	10/94 → 09/98
1.8	Petrol	55	11/91 → 09/98
1.8	Petrol	66	11/91 → 09/98
2.0	Petrol	85	11/91 → 09/98

SPA111

F1 **SENSORE TEMPERATURA REFRIGERANTE**
COOLANT TEMPERATURE SENSOR



AUDI

A1 (8X1, 8XF)

1.2 TFSI	Petrol	63	05/10 →
1.4 TFSI	Petrol	136	01/11 →
1.4 TFSI	Petrol	90	05/10 →
1.6 TDI	Diesel	66	03/11 →
1.6 TDI	Diesel	77	05/10 →
2.0 TDi	Diesel	105	09/11 →
2.0 TDi	Diesel	100	05/12 →
2.0 TFSI quattro	Petrol	188	03/12 →

A1 Sportback (8XA, 8XK)

1.2 TFSI	Petrol	63	01/12 →
1.4 TFSI	Petrol	136	11/11 →
1.4 TFSI	Petrol	90	11/11 →

A1 Sportback (8XA, 8XK)

1.6 TDI	Diesel	66	11/11 →
1.6 TDI	Diesel	77	11/11 →
2.0 TDi	Diesel	105	09/11 →
2.0 TDi	Diesel	100	05/12 →

A3 (8P1)

1.4 TFSI	Petrol	92	09/07 → 08/12
1.6	Petrol	75	05/03 → 08/12
1.6 FSI	Petrol	85	08/03 → 09/07
1.6 TDI	Diesel	66	05/09 → 08/12
1.6 TDI	Diesel	77	05/09 → 08/12
1.8 TFSI	Petrol	118	11/06 → 08/12
1.8 TFSI quattro	Petrol	118	07/08 → 08/12
1.9 TDI	Diesel	77	05/03 → 05/10
2.0 FSI	Petrol	110	05/03 → 06/08
2.0 TDi	Diesel	100	05/03 → 08/12
2.0 TDi	Diesel	103	06/05 → 06/08
2.0 TDi	Diesel	125	03/06 → 08/12
2.0 TDi	Diesel	120	06/06 → 06/08
2.0 TDi 16V	Diesel	103	05/03 → 08/12

SPA111



AUDI

A3 (8P1)

2.0 TDI 16V quattro	Diesel	103	08/04 → 08/12
2.0 TDI quattro	Diesel	103	01/06 → 06/08
2.0 TDI quattro	Diesel	125	03/06 → 08/12
2.0 TFSI	Petrol	147	09/04 → 08/12
2.0 TFSI quattro	Petrol	147	09/04 → 08/12
3.2 V6 quattro	Petrol	184	07/03 → 05/09
S3 quattro	Petrol	188	02/07 → 08/12
S3 quattro	Petrol	195	11/06 → 08/12

A3 (8V1)

1.8 TFSI	Petrol	132	04/12 →
----------	--------	-----	---------

A3 Cabriolet (8P7)

1.4 TFSI	Petrol	92	02/11 → 05/13
1.6	Petrol	75	09/08 → 05/10
1.6 TDI	Diesel	77	05/09 → 05/13
1.8 TFSI	Petrol	118	04/08 → 05/13
1.9 TDI	Diesel	77	04/08 → 10/09
2.0 TDi	Diesel	100	04/08 → 05/13
2.0 TDi	Diesel	103	04/08 → 05/13
2.0 TFSI	Petrol	147	04/08 → 05/13

A3 Sportback (8PA)

1.4 TFSI	Petrol	92	09/07 → 03/13
1.6	Petrol	75	09/04 → 03/13
1.6 FSI	Petrol	85	09/04 → 09/07
1.6 TDI	Diesel	66	05/09 → 03/13
1.6 TDI	Diesel	77	05/09 → 03/13
1.8 TFSI	Petrol	118	11/06 → 03/13
1.8 TFSI quattro	Petrol	118	07/08 → 03/13
1.9 TDI	Diesel	77	09/04 → 05/10
2.0 FSI	Petrol	110	09/04 → 06/08
2.0 TDi	Diesel	100	09/04 → 03/13
2.0 TDi	Diesel	103	06/05 → 06/08
2.0 TDi	Diesel	120	06/06 → 06/08
2.0 TDi	Diesel	125	03/06 → 03/13
2.0 TDi 16V	Diesel	103	09/04 → 03/13
2.0 TDi 16V quattro	Diesel	103	11/05 → 03/13
2.0 TDI quattro	Diesel	103	01/06 → 06/08
2.0 TDI quattro	Diesel	125	03/06 → 03/13
2.0 TFSI	Petrol	147	09/04 → 03/13
2.0 TFSI quattro	Petrol	147	09/04 → 03/13
3.2 V6 quattro	Petrol	184	09/04 → 05/09
RS3 quattro	Petrol	250	01/11 → 12/12
S3 quattro	Petrol	188	07/08 → 03/13

SPA111

AUDI
A3 Sportback (8PA)

S3 quattro	Petrol	195	06/08 → 03/13
------------	--------	-----	---------------

A4 (8EC, B7)

2.0 TDi	Diesel	100	11/04 → 06/08
---------	--------	-----	---------------

2.0 TDi	Diesel	103	11/04 → 06/08
---------	--------	-----	---------------

2.0 TDi	Diesel	120	06/06 → 06/08
---------	--------	-----	---------------

2.0 TDi	Diesel	125	06/06 → 06/08
---------	--------	-----	---------------

2.0 TDi	Diesel	89	09/05 → 09/06
---------	--------	----	---------------

2.0 TDi	Diesel	93	11/05 → 11/06
---------	--------	----	---------------

2.0 TDi 16V	Diesel	103	11/04 → 06/08
-------------	--------	-----	---------------

2.0 TDi quattro	Diesel	103	01/06 → 06/08
-----------------	--------	-----	---------------

2.0 TFSI	Petrol	125	10/06 → 06/08
----------	--------	-----	---------------

2.0 TFSI quattro	Petrol	147	11/04 → 10/07
------------------	--------	-----	---------------

2.7 TDi	Diesel	120	11/05 → 06/08
---------	--------	-----	---------------

2.7 TDi	Diesel	132	01/06 → 06/08
---------	--------	-----	---------------

3.2 FSI	Petrol	188	01/05 → 06/08
---------	--------	-----	---------------

RS4 quattro	Petrol	309	09/05 → 06/08
-------------	--------	-----	---------------

A4 (8K2, B8)

1.8 TFSI	Petrol	118	11/07 →
----------	--------	-----	---------

1.8 TFSI	Petrol	125	11/11 →
----------	--------	-----	---------

1.8 TFSI	Petrol	88	01/08 →
----------	--------	----	---------

1.8 TFSI quattro	Petrol	118	09/08 →
------------------	--------	-----	---------

1.8 TFSI quattro	Petrol	125	11/11 →
------------------	--------	-----	---------

2.0 TDi	Diesel	100	11/07 →
---------	--------	-----	---------

2.0 TDi	Diesel	105	11/07 →
---------	--------	-----	---------

2.0 TDi	Diesel	120	08/08 →
---------	--------	-----	---------

2.0 TDi	Diesel	130	11/11 →
---------	--------	-----	---------

2.0 TDi	Diesel	88	06/08 →
---------	--------	----	---------

2.0 TDi	Diesel	125	01/08 →
---------	--------	-----	---------

2.0 TDi quattro	Diesel	105	11/08 →
-----------------	--------	-----	---------

2.0 TDi quattro	Diesel	130	11/11 →
-----------------	--------	-----	---------

2.0 TDi quattro	Diesel	125	08/08 →
-----------------	--------	-----	---------

2.0 TFSI	Petrol	132	06/08 →
----------	--------	-----	---------

2.0 TFSI	Petrol	155	06/08 →
----------	--------	-----	---------

2.0 TFSI flexible fuel	Petrol/ Ethanol	132	01/10 →
------------------------	--------------------	-----	---------

2.0 TFSI flexible fuel quattro	Petrol/ Ethanol	132	01/10 →
--------------------------------	--------------------	-----	---------

2.0 TFSI quattro	Petrol	155	06/08 →
------------------	--------	-----	---------

2.7 TDi	Diesel	120	11/07 →
---------	--------	-----	---------

2.7 TDi	Diesel	140	11/07 →
---------	--------	-----	---------

3.0 TDi	Diesel	150	11/11 →
---------	--------	-----	---------

3.0 TDi quattro	Diesel	180	11/11 →
-----------------	--------	-----	---------

3.0 TFSI quattro	Petrol	200	02/12 →
------------------	--------	-----	---------

3.2 FSI	Petrol	195	09/08 →
---------	--------	-----	---------

SPA111

AUDI
A4 (8K2, B8)

3.2 FSI quattro	Petrol	195	11/07 →
-----------------	--------	-----	---------

S4 quattro	Petrol	245	03/09 →
------------	--------	-----	---------

A4 Allroad (8KH, B8)

2.0 TDi quattro	Diesel	100	09/09 →
-----------------	--------	-----	---------

2.0 TDi quattro	Diesel	105	09/09 →
-----------------	--------	-----	---------

2.0 TDi quattro	Diesel	120	04/09 →
-----------------	--------	-----	---------

2.0 TDi quattro	Diesel	130	11/11 →
-----------------	--------	-----	---------

2.0 TDi quattro	Diesel	125	04/09 →
-----------------	--------	-----	---------

2.0 TFSI quattro	Petrol	155	04/09 →
------------------	--------	-----	---------

3.0 TDi quattro	Diesel	176	04/09 →
-----------------	--------	-----	---------

3.0 TDi quattro	Diesel	180	01/12 →
-----------------	--------	-----	---------

A4 Avant (8ED, B7)

2.0 TDi	Diesel	100	11/04 → 06/08
---------	--------	-----	---------------

2.0 TDi	Diesel	103	11/04 → 06/08
---------	--------	-----	---------------

2.0 TDi	Diesel	120	06/06 → 06/08
---------	--------	-----	---------------

2.0 TDi	Diesel	125	06/06 → 06/08
---------	--------	-----	---------------

2.0 TDi	Diesel	89	09/05 → 09/06
---------	--------	----	---------------

2.0 TDi	Diesel	93	11/05 → 11/06
---------	--------	----	---------------

2.0 TDi 16V	Diesel	103	11/04 → 06/08
-------------	--------	-----	---------------

2.0 TDi quattro	Diesel	103	01/06 → 06/08
-----------------	--------	-----	---------------

2.0 TFSI	Petrol	125	10/06 → 06/08
----------	--------	-----	---------------

2.0 TFSI quattro	Petrol	147	11/04 → 03/08
------------------	--------	-----	---------------

2.7 TDi	Diesel	120	11/05 → 03/08
---------	--------	-----	---------------

2.7 TDi	Diesel	132	01/06 → 06/08
---------	--------	-----	---------------

3.2 FSI	Petrol	188	01/05 → 06/08
---------	--------	-----	---------------

RS4 quattro	Petrol	309	09/05 → 06/08
-------------	--------	-----	---------------

A4 Avant (8K5, B8)

1.8 TFSI	Petrol	118	11/07 →
----------	--------	-----	---------

1.8 TFSI	Petrol	125	11/11 →
----------	--------	-----	---------

1.8 TFSI	Petrol	88	04/08 →
----------	--------	----	---------

1.8 TFSI quattro	Petrol	118	09/08 →
------------------	--------	-----	---------

1.8 TFSI quattro	Petrol	125	11/11 →
------------------	--------	-----	---------

2.0 TDi	Diesel	100	04/08 →
---------	--------	-----	---------

2.0 TDi	Diesel	105	04/08 →
---------	--------	-----	---------

2.0 TDi	Diesel	120	08/08 →
---------	--------	-----	---------

2.0 TDi	Diesel	130	11/11 →
---------	--------	-----	---------

2.0 TDi	Diesel	88	06/08 →
---------	--------	----	---------

2.0 TDi	Diesel	125	04/08 →
---------	--------	-----	---------

2.0 TDi quattro	Diesel	130	11/11 →
-----------------	--------	-----	---------

2.0 TDi quattro	Diesel	105	11/08 →
-----------------	--------	-----	---------

2.0 TDi quattro	Diesel	125	08/08 →
-----------------	--------	-----	---------

2.0 TFSI	Petrol	132	06/08 →
----------	--------	-----	---------

2.0 TFSI	Petrol	155	06/08 →
----------	--------	-----	---------

SPA111



AUDI

A4 Avant (8K5, B8)

2.0 TFSI flexible fuel	Petrol/Ethanol	132	11/09 →	
2.0 TFSI flexible fuel quattro	Petrol/Ethanol	132	01/10 →	
2.0 TFSI quattro	Petrol	155	06/08 →	
2.7 TDI	Diesel	120	06/08 →	
2.7 TDI	Diesel	140	04/08 →	
3.0 TDI	Diesel	150	11/11 →	
3.0 TDI quattro	Diesel	180	11/11 →	
3.0 TFSI quattro	Petrol	200	02/12 →	
3.2 FSI	Petrol	195	09/08 →	
3.2 FSI quattro	Petrol	195	04/08 →	
S4 quattro	Petrol	245	03/09 →	

A4 Cabriolet (8H7, B6, 8HE, B7)

2.0	Petrol	147	11/05 → 03/09	
2.0 TDi	Diesel	100	01/06 → 03/09	
2.0 TDi	Diesel	103	01/06 → 03/09	
2.0 TFSI 16V	Petrol	147	01/06 → 03/09	
2.7 TDI	Diesel	132	06/06 → 03/09	
3.0 TDI quattro	Diesel	150	01/06 → 03/09	
3.0 TDI quattro	Diesel	171	01/06 → 03/09	
3.2 FSI	Petrol	188	01/06 → 03/09	
3.2 FSI quattro	Petrol	188	01/06 → 03/09	
RS4 quattro	Petrol	309	06/06 → 03/09	

A5 (8T3)

1.8 TFSI	Petrol	118	05/09 →	
1.8 TFSI	Petrol	125	10/07 →	
2.0 TDi	Diesel	120	08/08 →	
2.0 TDi	Diesel	125	08/08 →	

A5 (8T3)

2.0 TDi	Diesel	130	10/11 →	
2.0 TDI quattro	Diesel	130	12/11 →	
2.0 TDI quattro	Diesel	125	08/08 →	
2.0 TFSI	Petrol	132	11/08 →	
2.0 TFSI	Petrol	155	06/08 →	
2.0 TFSI quattro	Petrol	155	06/08 →	
2.7 TDI	Diesel	120	09/07 →	
2.7 TDI	Diesel	140	07/07 →	
3.0 TDI	Diesel	150	10/11 →	
3.0 TDI quattro	Diesel	155	03/08 → 05/10	
3.0 TDI quattro	Diesel	176	06/07 →	
3.0 TDI quattro	Diesel	180	10/11 →	
3.0 TFSI quattro	Petrol	200	12/11 →	
3.2 FSI	Petrol	195	06/07 →	

SPA111



AUDI

A5 (8T3)

3.2 FSI quattro	Petrol	195	06/07 →	
S5 quattro	Petrol	245	10/11 →	
S5 quattro	Petrol	260	06/07 →	

A5 Cabriolet (8F7)

1.8 TFSI	Petrol	118	09/09 →	
1.8 TFSI	Petrol	125	10/11 →	
2.0 TDi	Diesel	105	10/11 →	
2.0 TDi	Diesel	130	10/11 →	
2.0 TDi	Diesel	120	05/09 →	
2.0 TDi	Diesel	125	05/09 →	
2.0 TDI quattro	Diesel	130	01/12 →	
2.0 TFSI	Petrol	132	03/09 →	
2.0 TFSI	Petrol	155	03/09 →	
2.0 TFSI quattro	Petrol	155	03/09 →	
2.7 TDI	Diesel	120	05/09 →	
2.7 TDI	Diesel	140	03/09 →	
3.0 TDI	Diesel	150	10/11 →	
3.0 TDI quattro	Diesel	176	03/09 →	
3.0 TDI quattro	Diesel	180	10/11 →	
3.0 TFSI quattro	Petrol	200	12/11 →	
3.2 FSI	Petrol	195	03/09 →	
3.2 FSI quattro	Petrol	195	03/09 →	
S5 quattro	Petrol	245	06/09 →	

A5 Sportback (8TA)

1.8 TFSI	Petrol	118	11/09 →	
1.8 TFSI	Petrol	125	08/11 →	
2.0 TDi	Diesel	130	10/11 →	
2.0 TDi	Diesel	100	09/09 →	
2.0 TDi	Diesel	105	09/09 →	
2.0 TDi	Diesel	120	09/09 →	
2.0 TDi	Diesel	125	09/09 →	
2.0 TDI quattro	Diesel	130	12/11 →	
2.0 TDI quattro	Diesel	125	09/09 →	
2.0 TFSI	Petrol	132	09/09 →	
2.0 TFSI	Petrol	155	09/09 →	
2.0 TFSI quattro	Petrol	155	09/09 →	
2.7 TDI	Diesel	120	09/09 →	
2.7 TDI	Diesel	140	09/09 →	
3.0 TDI	Diesel	150	10/11 →	
3.0 TDI quattro	Diesel	176	09/09 →	
3.0 TDI quattro	Diesel	180	10/11 →	
3.0 TFSI quattro	Petrol	200	12/11 →	
3.2 FSI quattro	Petrol	195	09/09 →	
S5 quattro	Petrol	245	01/10 →	

SPA111

AUDI
A6 (4F2, C6)

2.0 TDi	Diesel	103	07/04 → 10/08
2.0 TDi	Diesel	89	09/05 → 06/06
2.0 TDi	Diesel	100	07/04 → 07/09
2.0 TDi	Diesel	120	04/09 → 07/09
2.0 TDi	Diesel	125	11/08 → 07/09
2.0 TFSI	Petrol	125	06/05 → 03/11
2.4	Petrol	130	05/04 → 10/08
2.4 quattro	Petrol	130	01/05 → 10/08
2.7 TDi	Diesel	120	11/04 → 07/09
2.7 TDi	Diesel	132	11/04 → 10/08
2.7 TDi quattro	Diesel	120	06/05 → 07/09
2.7 TDi quattro	Diesel	132	11/04 → 10/08
2.8 FSI	Petrol	140	10/08 → 03/11
2.8 FSI	Petrol	154	11/06 → 10/08
2.8 FSI	Petrol	162	10/08 → 03/11
2.8 FSI quattro	Petrol	140	10/08 → 03/11
2.8 FSI quattro	Petrol	154	06/07 → 10/08
2.8 FSI quattro	Petrol	162	10/08 → 03/11
3.0 TDi	Diesel	171	06/06 → 03/11
3.0 TDi quattro	Diesel	155	05/04 → 03/11
3.0 TDi quattro	Diesel	165	05/04 → 05/06
3.0 TDi quattro	Diesel	171	06/06 → 10/08
3.0 TFSI quattro	Petrol	213	10/08 → 03/11
3.0 TFSI quattro	Petrol	220	10/08 → 03/11
3.2 FSI	Petrol	188	05/04 → 05/09
3.2 FSI quattro	Petrol	183	09/06 → 10/08
3.2 FSI quattro	Petrol	188	05/04 → 10/08
4.2 FSI quattro	Petrol	257	06/06 → 03/11
4.2 quattro	Petrol	246	05/04 → 05/06
S6 quattro	Petrol	320	03/06 → 03/11

A6 (4G2, C7, 4GC)

2.0 TDi	Diesel	120	03/11 →
2.0 TDi	Diesel	100	01/12 →
2.0 TFSI	Petrol	132	05/11 →
2.0 TFSI	Petrol	155	03/11 → 05/13
2.0 TFSI hybrid	Hybrid	155	11/11 →
3.0 TDi quattro	Diesel	230	11/11 →
3.0 TFSI quattro	Petrol	228	03/11 →
S6 quattro	Petrol	309	04/12 →

A6 Allroad (4FH, C6)

2.7 TDi quattro	Diesel	120	05/06 → 08/11
2.7 TDi quattro	Diesel	132	05/06 → 10/08
2.7 TDi quattro	Diesel	140	10/08 → 08/11
3.0 TDi quattro	Diesel	155	05/06 → 08/11

SPA111

AUDI
A6 Allroad (4FH, C6)

3.0 TDi quattro	Diesel	171	05/06 → 10/08
3.0 TDi quattro	Diesel	176	10/08 → 08/11
3.0 TFSI quattro	Petrol	213	10/08 → 08/11
3.2 FSI quattro	Petrol	188	05/06 → 10/08
4.2 FSI quattro	Petrol	257	05/06 → 12/10

A6 Allroad (4GH, 4GJ)

3.0 TDi quattro	Diesel	150	01/12 →
3.0 TDi quattro	Diesel	180	01/12 →
3.0 TDi quattro	Diesel	230	01/12 →
3.0 TFSI quattro	Petrol	228	01/12 →

A6 Avant (4F5, C6)

2.0 TDi	Diesel	103	06/05 → 10/08
2.0 TDi	Diesel	89	09/05 → 06/06
2.0 TDi	Diesel	100	06/05 → 07/09
2.0 TDi	Diesel	120	04/09 → 07/09
2.0 TDi	Diesel	125	10/08 → 07/09
2.0 TFSI	Petrol	125	06/05 → 08/11
2.4	Petrol	130	03/05 → 10/08
2.4 quattro	Petrol	130	03/05 → 10/08
2.7 TDi	Diesel	120	03/05 → 07/09
2.7 TDi	Diesel	132	03/05 → 10/08
2.7 TDi quattro	Diesel	120	06/05 → 07/09
2.7 TDi quattro	Diesel	132	03/05 → 10/08
2.8 FSI	Petrol	140	10/08 → 08/11
2.8 FSI	Petrol	154	11/06 → 10/08
2.8 FSI	Petrol	162	10/08 → 08/11
2.8 FSI quattro	Petrol	140	10/08 → 08/11
2.8 FSI quattro	Petrol	154	06/07 → 10/08
2.8 FSI quattro	Petrol	162	10/08 → 08/11
3.0 TDi quattro	Diesel	155	03/05 → 08/11
3.0 TDi quattro	Diesel	165	03/05 → 05/06
3.0 TDi quattro	Diesel	171	06/06 → 10/08
3.0 TFSI quattro	Petrol	213	10/08 → 08/11
3.0 TFSI quattro	Petrol	220	10/08 → 08/11
3.2 FSI	Petrol	188	03/05 → 10/08
3.2 FSI quattro	Petrol	188	03/05 → 10/08
4.2 FSI quattro	Petrol	257	06/06 → 08/11
4.2 quattro	Petrol	246	03/05 → 05/06
S6 quattro	Petrol	320	03/06 → 08/11

A6 Avant (4G5, C7, 4GD)

2.0 TDi	Diesel	120	05/11 →
2.0 TDi	Diesel	130	05/11 →
2.0 TDi	Diesel	100	01/12 →
2.0 TFSI	Petrol	132	06/11 →

SPA111



KW



AUDI

A6 Avant (4G5, C7, 4GD)

2.8 FSI	Petrol	150	05/11 →
2.8 FSI quattro	Petrol	150	05/11 →
3.0 TDI	Diesel	150	05/11 →
3.0 TDI quattro	Diesel	180	05/11 →
3.0 TDI quattro	Diesel	230	11/11 →
3.0 TFSI quattro	Petrol	220	05/11 → 05/12
3.0 TFSI quattro	Petrol	228	11/11 →
S6 quattro	Petrol	309	04/12 →
2.8 FSI	Petrol	150	02/11 →
2.8 FSI quattro	Petrol	150	10/10 →
3.0 TDI	Diesel	150	11/10 →
3.0 TDI quattro	Diesel	180	10/10 →
3.0 TDI quattro	Diesel	230	11/11 →
3.0 TFSI quattro	Petrol	220	10/10 →
3.0 TFSI quattro	Petrol	228	11/11 →
S7 quattro	Petrol	309	02/12 →

A8 (4E_)

2.8 FSI	Petrol	154	08/07 → 07/10
3.0 TDI quattro	Diesel	155	11/03 → 07/10
3.0 TDI quattro	Diesel	171	08/03 → 07/10
3.2 FSI	Petrol	191	06/05 → 07/10
3.2 FSI quattro	Petrol	191	06/05 → 07/10
3.7 quattro	Petrol	206	10/02 → 05/06
4.0 TDI quattro	Diesel	202	05/03 → 07/05
4.2 FSI quattro	Petrol	257	06/06 → 07/10
4.2 quattro	Petrol	246	10/02 → 07/10
4.2 TDI quattro	Diesel	235	01/05 → 06/05
4.2 TDI quattro	Diesel	240	07/05 → 07/10
6.0 W12 quattro	Petrol	331	12/03 → 07/10
S8 quattro	Petrol	331	06/06 → 07/10

A8 (4H_)

2.0 TFSI hybrid	Hybrid	155	02/12 →
3.0 TDI quattro	Diesel	184	07/10 →
3.0 TFSI quattro	Petrol	213	07/10 →
3.0 TFSI quattro	Petrol	228	11/11 →
3.0 TFSI quattro	Petrol	245	06/10 →
4.0 TFSI quattro	Petrol	309	03/12 →
4.2 FSI quattro	Petrol	273	11/09 →
4.2 TDI quattro	Diesel	258	11/09 →
S8 quattro	Petrol	382	04/12 →

Q3 (8U)

2.0 TDi	Diesel	100	09/11 →
2.0 TDi	Diesel	103	09/11 →
2.0 TDI quattro	Diesel	103	01/12 →

SPA111



KW



AUDI

Q3 (8U)

2.0 TDI quattro	Diesel	120	06/11 →
2.0 TDI quattro	Diesel	130	06/11 →
2.0 TFSI quattro	Petrol	125	06/11 →
2.0 TFSI quattro	Petrol	155	06/11 →

Q5 (8R)

2.0 TDi	Diesel	100	11/10 →
2.0 TDi	Diesel	105	11/10 →
2.0 TDI quattro	Diesel	105	08/09 →
2.0 TDI quattro	Diesel	125	11/08 →
2.0 TDI quattro	Diesel	100	08/09 →
2.0 TDI quattro	Diesel	120	11/08 →
2.0 TFSI hybrid quattro	Hybrid	155	06/11 →
2.0 TFSI quattro	Petrol	132	08/09 →
2.0 TFSI quattro	Petrol	155	11/08 →
3.2 FSI quattro	Petrol	199	11/08 →

Q7 (4L)

3.0 TDI	Diesel	150	05/10 →
3.0 TDI	Diesel	155	03/06 → 05/10
3.0 TDI	Diesel	165	06/09 → 05/12
3.0 TDI	Diesel	171	03/06 → 05/08
3.0 TDI	Diesel	176	11/07 →
3.0 TFSI	Petrol	200	05/10 →
3.0 TFSI	Petrol	206	05/11 →
3.0 TFSI	Petrol	245	05/10 →
3.6 FSI	Petrol	206	08/06 → 05/10
4.2 FSI	Petrol	257	03/06 → 05/10
4.2 TDI	Diesel	240	03/07 → 06/09
4.2 TDI	Diesel	250	06/09 →

R8

4.2 FSI quattro	Petrol	309	04/07 → 09/10
4.2 FSI quattro	Petrol	316	09/10 →

R8 Spyder

4.2 FSI quattro	Petrol	316	09/10 →
-----------------	--------	-----	---------

TT (8J3)

1.8 TFSI	Petrol	118	06/08 →
2.0 quattro	Petrol	195	05/08 →
2.0 TDI quattro	Diesel	125	06/08 →
2.0 TFSI	Petrol	147	08/06 → 06/10
2.0 TFSI quattro	Petrol	147	06/08 → 06/10
2.0 TFSI quattro	Petrol	200	05/08 →
2.5 TFSI RS quattro	Petrol	250	07/09 →

SPA111

KW

AUDI
TT (8J3)

2.5 TFSI RS quattro	Petrol	265	05/11 →	
3.2 V6 quattro	Petrol	184	08/06 → 06/10	

TT Roadster (8J9)

1.8 TFSI	Petrol	118	06/08 →	
2.0 quattro	Petrol	195	05/08 →	
2.0 TDI quattro	Diesel	125	06/08 →	
2.0 TFSI	Petrol	147	03/07 → 06/10	
2.0 TFSI quattro	Petrol	147	06/08 → 06/10	
2.0 TFSI quattro	Petrol	200	05/08 →	
2.5 TFSI quattro	Petrol	265	03/12 →	
2.5 TFSI RS quattro	Petrol	250	07/09 →	
3.2 V6 quattro	Petrol	184	03/07 → 06/10	

FORD
GALAXY (WGR)

1.9 TDI	Diesel	110	05/05 → 05/06	
1.9 TDI	Diesel	85	05/00 → 05/06	
1.9 TDI	Diesel	96	02/03 → 05/06	
2.8 V6	Petrol	150	05/00 → 05/06	

MERCEDES-BENZ
CLASSE V (638/2)

V 280 (638.244, 638.294)	Petrol	128	08/97 → 07/03	ENGINE: 004196 →
--------------------------	--------	-----	---------------	------------------

MITSUBISHI
GRANDIS (NA_W)

2.0 DI-D	Diesel	100	09/05 →	
2.0 DI-D	Diesel	103	02/07 → 03/10	

LANCER SPORTBACK (CX_A)

2.0 DI-D	Diesel	103	06/08 →	
----------	--------	-----	---------	--

LANCER Tre volumi (CY/IZ_A)

2.0 DI-D	Diesel	103	01/08 →	
----------	--------	-----	---------	--

OUTLANDER II (CW_W)

2.0 DI-D	Diesel	103	02/07 → 06/10	
----------	--------	-----	---------------	--

OUTLANDER II Van (CW_W)

2.0 DI-D	Diesel	103	12/06 → 06/10	
----------	--------	-----	---------------	--

PORSCHE
BOXSTER (987)

2.7	Petrol	176	11/04 → 12/06	
2.7	Petrol	180	07/06 → 12/09	
S 3.2	Petrol	206	11/04 → 12/06	
S 3.4	Petrol	217	07/06 → 12/09	
S 3.4	Petrol	223	08/08 → 12/09	

SPA111

KW

PORSCHE
CAYENNE

3.0 d	Diesel	155	10/10 →	
3.0 Diesel	Diesel	176	06/10 →	
3.0 S E-Hybrid	Hybrid	245	06/10 →	
3.6	Petrol	220	06/10 →	
4.8 S	Petrol	294	06/10 →	

CAYENNE (955)

3.0 TDI	Diesel	176	02/09 → 09/10	
3.2	Petrol	184	10/03 → 09/07	
3.6	Petrol	213	02/07 → 09/10	

CAYMAN (987)

2.7	Petrol	180	07/06 → 12/09	
S 3.4	Petrol	217	11/05 → 12/09	

PANAMERA

3.0 S Hybrid	Hybrid	245	03/11 →	
--------------	--------	-----	---------	--

SEAT
ALHAMBRA (710)

1.4 TSI	Petrol	110	06/10 →	
2.0 TDi	Diesel	100	06/10 → 05/11	
2.0 TDi	Diesel	103	06/10 →	
2.0 TDi	Diesel	125	06/10 →	
2.0 TDi	Diesel	85	05/11 →	
2.0 TDi 4Drive	Diesel	103	05/11 →	

ALHAMBRA (7V8, 7V9)

1.8 T 20V	Petrol	110	10/97 → 03/10	
1.9 TDI	Diesel	110	05/05 → 05/07	
1.9 TDI	Diesel	96	11/02 → 11/08	
1.9 Tdi 4x4	Diesel	96	06/05 → 11/08	
2.0 TDi	Diesel	103	11/05 → 03/10	
2.8 V6	Petrol	150	06/00 → 03/10	
2.8 V6 4motion	Petrol	150	06/00 → 03/10	

ALTEA (5P1)

1.2 TSI	Petrol	77	04/10 →	
1.4 16V	Petrol	63	05/06 →	
1.4 TSI	Petrol	92	11/07 →	
1.6	Petrol	75	03/04 →	
1.6 LPG	Petrol/ LPG	75	12/09 →	
1.6 TDI	Diesel	66	11/10 →	
1.6 TDI	Diesel	77	11/09 →	
1.8 TFSI	Petrol	118	01/07 →	
1.9 TDI	Diesel	77	04/04 →	
1.9 TDI	Diesel	66	11/09 →	
2.0 FSI	Petrol	110	05/04 → 03/09	
2.0 TDi	Diesel	100	03/04 → 05/09	

SPA111



KW



SEAT

ALTEA (5P1)

2.0 TDi	Diesel	103	11/05 →
2.0 TDi	Diesel	125	03/06 →
2.0 TDi 16V	Diesel	103	03/04 →
2.0 TFSI	Petrol	147	04/06 → 05/09

ALTEA XL (5P5, 5P8)

1.2 TSI	Petrol	77	05/10 →
1.4 16V	Petrol	63	10/06 →
1.4 TSI	Petrol	92	11/07 →
1.6	Petrol	75	10/06 →
1.6 LPG	Petrol/ LPG	75	09/09 →
1.6 Multifuel	Petrol/ Ethanol	75	10/06 →
1.6 TDI	Diesel	66	11/10 →
1.6 TDI	Diesel	77	02/10 →
1.8 TFSI	Petrol	118	01/07 →
1.9 TDI	Diesel	66	08/09 →
1.9 TDI	Diesel	77	10/06 →
2.0 FSI	Petrol	110	10/06 → 03/09
2.0 TDi	Diesel	100	11/06 → 03/09
2.0 TDi	Diesel	103	10/06 →
2.0 TDi	Diesel	125	06/07 →
2.0 TDi 16V	Diesel	103	10/06 →
2.0 TDi 4x4	Diesel	103	06/07 →
2.0 TDi 4x4	Diesel	125	06/07 →
2.0 TFSI 4x4	Petrol	147	06/07 → 05/09
2.0 TFSI 4x4	Petrol	155	05/09 →

CORDOBA (6L2)

1.2	Petrol	47	10/02 → 06/06
1.2 12V	Petrol	51	05/06 → 11/09
1.4 16V	Petrol	55	09/02 → 12/07
1.4 16V	Petrol	63	05/06 → 11/09
1.4 16V	Petrol	74	10/02 → 11/09
1.4 TDI	Diesel	51	05/05 → 11/09
1.4 TDI	Diesel	59	06/05 → 11/09
1.4 TDI	Diesel	55	10/02 → 12/05
1.6	Petrol	74	04/03 → 11/09
1.6 16V	Petrol	77	11/06 → 11/09
1.9 SDI	Diesel	47	09/02 → 11/09
1.9 TDI	Diesel	74	09/02 → 11/09
1.9 TDI	Diesel	96	10/02 → 11/09
2.0	Petrol	85	09/02 → 11/09

SPA111



KW



SEAT

EXEO (3R2)

1.8 TSI	Petrol	118	05/10 →
1.8 TSI	Petrol	88	09/10 →
2.0 TDi	Diesel	88	12/08 →
2.0 TDi	Diesel	105	12/08 →
2.0 TDi	Diesel	125	02/09 →
2.0 TFSI	Petrol	147	03/09 →
2.0 TFSI	Petrol	155	05/10 →

EXEO ST (3R5)

1.8 TSI	Petrol	118	05/10 →
1.8 TSI	Petrol	88	09/10 →
2.0 TDi	Diesel	105	05/09 →
2.0 TDi	Diesel	125	05/09 →
2.0 TDi	Diesel	88	09/09 →
2.0 TFSI	Petrol	147	06/09 →
2.0 TFSI	Petrol	155	05/10 →

IBIZA IV (6L1)

1.2	Petrol	44	06/07 → 05/08
1.2	Petrol	47	02/02 → 06/06
1.2 12V	Petrol	51	05/06 → 11/09
1.4 16V	Petrol	55	02/02 → 12/07
1.4 16V	Petrol	63	05/06 → 11/09
1.4 16V	Petrol	74	02/02 → 11/09
1.4 TDI	Diesel	51	05/05 → 11/09
1.4 TDI	Diesel	59	06/05 → 11/09
1.4 TDI	Diesel	55	05/02 → 12/05
1.6	Petrol	74	02/03 → 11/09
1.6 16V	Petrol	77	11/06 → 11/09
1.8 T Cupra R	Petrol	132	01/04 → 02/08
1.8 T FR	Petrol	110	12/03 → 05/08
1.9 SDI	Diesel	47	02/02 → 12/05
1.9 TDI	Diesel	74	02/02 → 11/09
1.9 TDI	Diesel	96	02/02 → 11/09
1.9 TDI Cupra R	Diesel	118	03/04 → 02/08
2.0	Petrol	85	04/02 → 11/09

IBIZA V (6J5)

1.2	Petrol	44	07/09 →
1.2	Petrol	51	03/08 →
1.2 TDI	Diesel	55	06/10 →
1.2 TSI	Petrol	77	09/10 →
1.4	Petrol	63	03/08 →
1.4 TDI	Diesel	59	07/08 → 06/10
1.4 TSI	Petrol	110	06/09 →
1.6	Petrol	77	05/08 →

SPA111

SEAT
IBIZA V (6J5)

1.6 LPG	Petrol/ LPG	60	05/11 →
1.6 TDI	Diesel	66	05/09 → 05/11
1.6 TDI	Diesel	77	05/09 →
1.9 TDI	Diesel	66	07/08 → 06/10
1.9 TDI	Diesel	77	03/08 → 06/10
2.0 TDi	Diesel	105	01/10 →

IBIZA V SPORTCOUPE (6J1)

1.2	Petrol	44	07/09 →
1.2	Petrol	51	07/08 → 05/11
1.2 TSI	Petrol	77	09/10 →
1.4	Petrol	63	07/08 →
1.4 TDI	Diesel	59	07/08 → 06/10
1.4 TSI	Petrol	110	06/09 →
1.4 TSI Cupra	Petrol	132	06/09 →
1.6	Petrol	77	07/08 →
1.6 LPG	Petrol/ LPG	60	05/11 →
1.6 TDI	Diesel	66	05/09 → 05/11
1.6 TDI	Diesel	77	05/09 →
1.9 TDI	Diesel	66	07/08 → 06/10
1.9 TDI	Diesel	77	07/08 → 06/10
2.0 TDi	Diesel	105	01/10 →

IBIZA V ST (6J8)

1.2	Petrol	44	05/10 →
1.2	Petrol	51	05/10 →
1.2 TDI	Diesel	55	04/10 →
1.2 TSI	Petrol	77	09/10 →
1.4	Petrol	63	03/10 →
1.6	Petrol	77	02/12 →
1.6 TDI	Diesel	77	03/10 →
1.6 TDI	Diesel	66	03/10 →

LEON (1M1)

1.6	Petrol	75	10/05 → 06/06
-----	--------	----	---------------

LEON (1P1)

1.4 16V	Petrol	63	06/06 →
1.4 TSI	Petrol	92	11/07 →
1.6	Petrol	75	07/05 →
1.6 LPG	Petrol/ LPG	75	12/09 →
1.6 Multifuel	Petrol/ Ethanol	75	11/10 →
1.8 TSI	Petrol	118	06/07 →
1.9 TDI	Diesel	66	06/07 →

SPA111

SEAT
LEON (1P1)

1.9 TDI	Diesel	77	07/05 →
2.0 Cupra R	Petrol	195	09/09 →
2.0 FSI	Petrol	110	07/05 → 05/10
2.0 TDi	Diesel	103	10/05 →
2.0 TDi	Diesel	125	05/06 →
2.0 TDi	Diesel	100	07/05 → 05/10
2.0 TDI 16V	Diesel	103	07/05 →
2.0 TFSI	Petrol	136	09/05 → 05/06
2.0 TFSI	Petrol	147	05/05 → 03/09
2.0 TFSI	Petrol	155	06/09 →
2.0 TFSI	Petrol	177	11/06 →

TOLEDO III (5P2)

1.6	Petrol	75	10/04 → 05/09
1.8 TFSI	Petrol	118	01/07 → 05/09
1.9 TDI	Diesel	77	10/04 → 05/09
2.0 FSI	Petrol	110	10/04 → 05/09
2.0 TDi	Diesel	100	09/04 → 05/09
2.0 TDi	Diesel	125	01/06 → 05/09
2.0 TDi	Diesel	103	11/05 → 05/09
2.0 TDI 16V	Diesel	103	04/04 → 05/09
2.0 TFSI	Petrol	147	11/05 → 05/09

SKODA
FABIA

1.2	Petrol	44	12/06 → 03/10
1.2	Petrol	51	01/07 → 03/10
1.2 12V	Petrol	44	11/11 →
1.2 TDI	Diesel	55	05/10 →
1.4	Petrol	63	01/07 →
1.4 TDI	Diesel	51	02/07 → 03/10
1.4 TSI RS	Petrol	132	05/10 →
1.6	Petrol	77	04/07 →
1.6 TDI	Diesel	55	04/10 →
1.6 TDI	Diesel	66	03/10 →
1.6 TDI	Diesel	77	03/10 →
1.9 TDI	Diesel	77	04/07 → 03/10

FABIA (6Y2)

1.0	Petrol	37	12/99 → 08/02
1.2	Petrol	40	08/02 → 03/08
1.2	Petrol	47	01/03 → 03/08
1.4	Petrol	44	08/00 → 08/02
1.4 16V	Petrol	55	12/99 → 03/08
1.4 16V	Petrol	74	12/99 → 04/07
1.4 TDI	Diesel	55	04/03 → 03/08
1.4 TDI	Diesel	59	10/05 → 03/08

SPA111



KW



SKODA

FABIA (6Y2)

1.9 SDI	Diesel	47	12/99 → 03/08
1.9 TDI	Diesel	74	01/00 → 03/08
1.9 TDI RS	Diesel	96	06/03 → 03/08
2.0	Petrol	85	12/99 → 04/07

FABIA Combi

1.2	Petrol	44	10/07 → 03/10
1.2	Petrol	51	10/07 → 03/10
1.2 12V	Petrol	44	11/11 →
1.2 TDI	Diesel	55	05/10 →
1.4	Petrol	63	10/07 →
1.4 TDI	Diesel	51	10/07 → 03/10
1.4 TSI RS	Petrol	132	05/10 →
1.6	Petrol	77	10/07 →
1.6 TDI	Diesel	55	04/10 →
1.6 TDI	Diesel	66	03/10 →
1.6 TDI	Diesel	77	03/10 →
1.9 TDI	Diesel	77	10/07 → 03/10

FABIA Combi (6Y5)

1.2	Petrol	40	07/01 → 12/07
1.2	Petrol	47	01/03 → 12/07
1.4	Petrol	44	04/00 → 03/03
1.4 16V	Petrol	55	05/00 → 12/07
1.4 16V	Petrol	59	04/06 → 12/07
1.4 16V	Petrol	74	04/00 → 12/07
1.4 TDI	Diesel	55	04/03 → 12/07
1.4 TDI	Diesel	59	10/05 → 12/07
1.9 SDI	Diesel	47	04/00 → 12/07
1.9 TDI	Diesel	74	04/00 → 12/07
2.0	Petrol	85	04/00 → 12/07

FABIA Praktik

1.2	Petrol	40	07/01 → 12/07
1.2	Petrol	47	01/03 → 12/07
1.4	Petrol	50	07/01 → 05/03
1.9 SDI	Diesel	47	07/01 → 12/07

FABIA Tre volumi (6Y3)

1.2	Petrol	40	07/01 → 12/07
1.2	Petrol	47	01/03 → 12/07
1.4	Petrol	44	04/00 → 08/02
1.4 16V	Petrol	55	10/99 → 12/07
1.4 16V	Petrol	59	04/06 → 12/07
1.4 16V	Petrol	74	05/02 → 12/07
1.4 TDI	Diesel	55	04/03 → 12/07
1.4 TDI	Diesel	59	10/05 → 12/07
1.9 SDI	Diesel	47	11/99 → 12/07

SPA111



KW



SKODA

FABIA Tre volumi (6Y3)

1.9 TDI	Diesel	74	01/00 → 12/07
2.0	Petrol	85	12/99 → 04/07

OCTAVIA (1Z3)

1.4	Petrol	59	06/04 →
1.4	Petrol	55	05/04 → 05/06
1.4 TSI	Petrol	90	11/08 →
1.6	Petrol	75	06/04 →
1.6 FSI	Petrol	85	02/04 → 10/08
1.6 LPG	Petrol/ LPG	75	08/09 →
1.6 Multifuel	Petrol/ Ethanol	75	01/08 → 05/10
1.6 TDI	Diesel	77	06/09 →
1.8 TSI	Petrol	118	06/07 →
1.9 TDI	Diesel	77	06/04 → 12/10
2.0 FSI	Petrol	110	11/04 →
2.0 RS	Petrol	147	10/05 →
2.0 TDi	Diesel	100	02/04 → 05/10
2.0 TDi	Diesel	103	11/05 →
2.0 TDI 16V	Diesel	103	02/04 →
2.0 TDI RS	Diesel	125	04/06 →

OCTAVIA Combi (1Z5)

1.4	Petrol	59	05/06 →
1.4 TSI	Petrol	90	11/08 →
1.6	Petrol	75	09/04 →
1.6 FSI	Petrol	85	02/04 → 10/08
1.6 LPG	Petrol/ LPG	75	08/09 →
1.6 Multifuel	Petrol/ Ethanol	75	01/08 → 05/10
1.6 TDI	Diesel	77	06/09 →
1.6 TDI 4x4	Diesel	77	06/09 →
1.8 TSI	Petrol	118	06/07 →
1.8 TSI 4x4	Petrol	118	11/08 →
1.9 TDI	Diesel	77	09/04 → 12/10
1.9 Tdi 4x4	Diesel	77	11/04 → 12/10
2.0 FSI	Petrol	110	11/04 →
2.0 FSI 4x4	Petrol	110	11/04 →
2.0 RS	Petrol	147	10/05 →
2.0 TDi	Diesel	103	11/05 →
2.0 TDI 16V	Diesel	100	02/04 → 05/10
2.0 TDI 16V	Diesel	103	02/04 →
2.0 TDI 4x4	Diesel	103	07/06 →
2.0 TDI 4x4	Diesel	81	05/11 →

SPA111

KW

SKODA
OCTAVIA Combi (1Z5)

2.0 TDI RS Diesel 125 04/06 →

ROOMSTER (5J)

1.2 Petrol 47 05/06 → 01/07

1.2 Petrol 51 01/07 →

1.4 Petrol 63 09/06 →

1.4 TDI Diesel 51 07/06 → 03/10

1.4 TDI Diesel 59 09/06 → 03/10

1.6 Petrol 77 09/06 →

1.6 TDI Diesel 66 03/10 →

1.6 TDI Diesel 77 03/10 →

1.9 TDI Diesel 74 03/06 → 05/06

1.9 TDI Diesel 77 09/06 → 03/10

ROOMSTER Praktik (5J)

1.2 Petrol 51 03/07 →

1.2 TDI Diesel 55 03/10 →

1.4 Petrol 63 03/07 →

1.4 TDI Diesel 51 03/07 → 03/10

1.4 TDI Diesel 59 03/07 → 03/10

1.6 TDI Diesel 66 03/10 →

SUPERB (3T4)

1.4 TSI Petrol 92 07/08 →

1.8 TSI Petrol 118 03/08 →

1.8 TSI 4x4 Petrol 118 11/08 →

1.9 TDI Diesel 77 03/08 →

2.0 TDi Diesel 103 03/08 → 03/10

2.0 TDi Diesel 125 07/08 →

2.0 TDI 16V Diesel 103 01/09 →

2.0 TDI 16V 4x4 Diesel 103 11/10 →

2.0 TDI 4x4 Diesel 125 09/08 →

3.6 V6 4x4 Petrol 191 11/08 →

SUPERB Station wagon (3T5)

1.4 TSI Petrol 92 10/09 →

1.8 TSI Petrol 118 10/09 →

1.8 TSI 4x4 Petrol 118 10/09 →

1.9 TDI Diesel 77 10/09 → 11/10

2.0 TDi Diesel 103 10/09 → 03/10

2.0 TDi Diesel 125 10/09 →

2.0 TDI 16V Diesel 103 10/09 →

2.0 TDI 16V 4x4 Diesel 103 11/10 →

2.0 TDI 4x4 Diesel 125 10/09 →

3.6 V6 4x4 Petrol 191 10/09 →

SPA111

KW

SKODA
YETI (5L)

1.2 TSI Petrol 77 09/09 →

1.4 TSI Petrol 90 06/10 →

1.8 TSI 4x4 Petrol 112 11/09 →

1.8 TSI 4x4 Petrol 118 05/09 →

2.0 TDi Diesel 103 11/11 →

2.0 TDi Diesel 81 11/09 →

2.0 TDI 4x4 Diesel 103 05/09 →

2.0 TDI 4x4 Diesel 125 11/09 →

2.0 TDI 4x4 Diesel 81 11/09 →

VOLKSWAGEN
AMAROK (2H_, S1B)

2.0 BiTDI Diesel 120 09/10 →

2.0 BiTDI 4motion Diesel 120 09/10 →

2.0 TDi Diesel 90 09/10 →

2.0 TDI 4motion Diesel 132 11/11 →

2.0 TDI 4motion Diesel 90 09/10 →

2.0 TSI Petrol 118 12/10 →

BEETLE (5C1)

1.4 TSI Petrol 118 04/11 →

1.6 TDI Diesel 77 10/11 →

2.0 TDi Diesel 103 04/11 →

2.0 TSI Petrol 147 04/11 →

BORA (1J2)

1.9 SDI Diesel 50 11/98 → 05/05

1.9 TDI Diesel 66 10/98 → 06/01

1.9 TDI Diesel 96 04/01 → 05/05

1.9 TDI 4motion Diesel 66 02/99 → 06/01

1.9 TDI 4motion Diesel 74 05/01 → 05/05

1.9 TDI 4motion Diesel 96 04/01 → 05/05

2.8 V6 4motion Petrol 150 05/99 → 05/05

BORA Station wagon (1J6)

1.6 Petrol 75 09/00 → 05/05

1.9 TDI 4motion Diesel 96 04/01 → 05/05

CADDY III Furgonato (2KA, 2KH, 2CA, 2CH)

1.2 TSI Petrol 63 09/10 →

1.2 TSI Petrol 77 09/10 →

1.4 Petrol 55 03/04 → 05/06

1.4 16V Petrol 59 05/06 → 08/10

1.6 Petrol 75 04/04 →

 1.6 Bifuel Petrol/
LPG 75 05/11 →

1.6 TDI Diesel 55 08/10 →

1.6 TDI Diesel 75 08/10 →

SPA111



KW



VOLKSWAGEN

CADDY III Furgonato (2KA, 2KH, 2CA, 2CH)

1.9 TDI	Diesel	55	09/05 → 08/10
1.9 TDI	Diesel	77	04/04 → 08/10
1.9 TDI 4motion	Diesel	77	11/08 → 08/10
2.0 EcoFuel	Petrol/ CNG	80	04/06 →
2.0 SDI	Diesel	51	03/04 → 08/10
2.0 TDi	Diesel	103	09/07 → 08/10
2.0 TDi	Diesel	62	11/10 →
2.0 TDi	Diesel	125	05/12 →
2.0 TDi	Diesel	81	08/10 →
2.0 TDI 16V	Diesel	103	11/10 →
2.0 TDI 16V 4motion	Diesel	103	11/10 →
2.0 TDI 4motion	Diesel	62	12/10 →
2.0 TDI 4motion	Diesel	81	08/10 →

CADDY III Station wagon (2KB, 2KJ, 2CB, 2CJ)

1.2 TSI	Petrol	63	09/10 →
1.2 TSI	Petrol	77	09/10 →
1.4	Petrol	55	03/04 → 05/06
1.4 16V	Petrol	59	05/06 → 08/10
1.6	Petrol	75	04/04 →
1.6 Bifuel	Petrol/ LPG	75	05/11 →
1.6 TDI	Diesel	55	08/10 →
1.6 TDI	Diesel	75	08/10 →
1.9 TDI	Diesel	55	09/05 → 08/10
1.9 TDI	Diesel	77	04/04 → 08/10
1.9 TDI 4motion	Diesel	77	05/08 → 08/10
2.0 EcoFuel	Petrol/ CNG	80	04/06 →
2.0 SDI	Diesel	51	03/04 → 08/10
2.0 TDi	Diesel	103	09/07 → 08/10
2.0 TDi	Diesel	125	05/12 →
2.0 TDi	Diesel	81	08/10 →
2.0 TDI 16V	Diesel	103	11/10 →
2.0 TDI 16V 4motion	Diesel	103	11/10 →
2.0 TDI 4motion	Diesel	81	08/10 →

CC (358)

1.8 TSI	Petrol	118	11/11 →
2.0 TDi	Diesel	103	11/11 →
2.0 TDi	Diesel	125	11/11 →
2.0 TSI	Petrol	155	11/11 →
3.6 FSI 4motion	Petrol	220	11/11 →

SPA111



KW



VOLKSWAGEN

CRAFTER 30-35 Autobus (2E_)

2.0 TDi	Diesel	100	05/11 →
2.0 TDi	Diesel	120	07/11 →
2.0 TDi	Diesel	80	05/11 →
2.0 TDI 4motion	Diesel	120	11/11 →
2.5 TDI	Diesel	100	04/06 → 07/11
2.5 TDI	Diesel	120	04/06 → 07/11
2.5 TDI	Diesel	65	04/06 → 07/11
2.5 TDI	Diesel	80	04/06 → 07/11

CRAFTER 30-50 Furgonato (2E_)

2.0 TDi	Diesel	100	05/11 →
2.0 TDi	Diesel	105	10/11 →
2.0 TDi	Diesel	120	07/11 →
2.0 TDi	Diesel	80	05/11 →
2.0 TDI 4motion	Diesel	120	11/11 →
2.5 TDI	Diesel	100	04/06 → 07/11
2.5 TDI	Diesel	120	04/06 → 07/11
2.5 TDI	Diesel	65	04/06 → 07/11
2.5 TDI	Diesel	80	04/06 → 07/11

CRAFTER 30-50 Pianale piatto/Telaio (2F_)

2.0 TDi	Diesel	100	05/11 →
2.0 TDi	Diesel	105	10/11 →
2.0 TDi	Diesel	120	07/11 →
2.0 TDi	Diesel	80	05/11 →
2.0 TDI 4motion	Diesel	120	11/11 →
2.5 TDI	Diesel	100	04/06 → 07/11
2.5 TDI	Diesel	120	04/06 → 07/11
2.5 TDI	Diesel	65	04/06 → 07/11
2.5 TDI	Diesel	80	04/06 → 07/11

EOS (1F7, 1F8)

1.4 TSI	Petrol	118	05/08 → 11/10
1.4 TSI	Petrol	90	11/07 → 11/10
1.6 FSI	Petrol	85	06/06 → 05/08
2.0 FSI	Petrol	110	03/06 → 05/08
2.0 TDi	Diesel	103	06/06 → 05/08
2.0 TDi	Diesel	100	11/10 →
2.0 TDI 16V	Diesel	103	05/08 → 11/10
2.0 TFSI	Petrol	147	05/06 → 11/10
2.0 TSI	Petrol	155	11/09 → 11/10
3.2 V6	Petrol	184	06/06 → 05/09
3.6 V6	Petrol	191	05/09 → 11/10

FOX (5Z1, 5Z3)

1.2	Petrol	40	04/05 →
1.2	Petrol	44	09/10 →
1.4	Petrol	55	04/05 →

SPA111

VOLKSWAGEN
FOX (5Z1, 5Z3)

1.4 TDI	Diesel	51	04/05 →
---------	--------	----	---------

GOLF PLUS (5M1, 521)

1.4 16V	Petrol	55	01/05 →
---------	--------	----	---------

1.4 16V	Petrol	59	05/06 →
---------	--------	----	---------

1.4 FSI	Petrol	66	07/05 →
---------	--------	----	---------

1.4 TSI	Petrol	103	05/06 → 06/08
---------	--------	-----	---------------

1.4 TSI	Petrol	118	06/08 →
---------	--------	-----	---------

1.4 TSI	Petrol	125	05/06 → 06/08
---------	--------	-----	---------------

1.4 TSI	Petrol	90	06/07 →
---------	--------	----	---------

1.6	Petrol	75	05/05 →
-----	--------	----	---------

1.6 Bifuel	Petrol/ LPG	75	05/09 →
------------	----------------	----	---------

1.6 FSI	Petrol	85	01/05 → 05/08
---------	--------	----	---------------

1.6 Multifuel	Petrol/ Ethanol	75	11/07 →
---------------	--------------------	----	---------

1.6 TDI	Diesel	66	02/09 →
---------	--------	----	---------

1.6 TDI	Diesel	77	03/09 →
---------	--------	----	---------

1.9 TDI	Diesel	66	05/05 → 12/08
---------	--------	----	---------------

1.9 TDI	Diesel	77	01/05 → 01/09
---------	--------	----	---------------

2.0 FSI	Petrol	110	05/05 → 06/08
---------	--------	-----	---------------

2.0 TDi	Diesel	100	05/05 →
---------	--------	-----	---------

2.0 TDi	Diesel	103	12/05 → 05/09
---------	--------	-----	---------------

2.0 TDi	Diesel	81	01/09 →
---------	--------	----	---------

2.0 TDi	Diesel	96	05/05 → 05/07
---------	--------	----	---------------

2.0 TDI 16V	Diesel	103	01/05 →
-------------	--------	-----	---------

GOLF V (1K1)

1.4 16V	Petrol	55	10/03 → 05/06
---------	--------	----	---------------

1.4 16V	Petrol	59	05/06 → 11/08
---------	--------	----	---------------

1.4 TSI	Petrol	103	05/06 → 11/08
---------	--------	-----	---------------

1.4 TSI	Petrol	90	05/07 → 11/08
---------	--------	----	---------------

1.6 FSI	Petrol	85	10/03 → 07/08
---------	--------	----	---------------

1.6 Multifuel	Petrol/ Ethanol	75	10/07 → 11/08
---------------	--------------------	----	---------------

1.9 TDI	Diesel	66	05/04 → 11/08
---------	--------	----	---------------

1.9 TDI	Diesel	77	10/03 → 11/08
---------	--------	----	---------------

1.9 TDI 4motion	Diesel	77	08/04 → 11/08
-----------------	--------	----	---------------

2.0 FSI	Petrol	110	01/04 → 11/08
---------	--------	-----	---------------

2.0 FSI 4motion	Petrol	110	08/04 → 11/08
-----------------	--------	-----	---------------

2.0 GTI	Petrol	147	10/04 → 02/09
---------	--------	-----	---------------

2.0 GTI	Petrol	169	09/06 → 12/08
---------	--------	-----	---------------

2.0 SDI	Diesel	55	01/04 → 11/08
---------	--------	----	---------------

2.0 TDi	Diesel	100	10/03 → 11/08
---------	--------	-----	---------------

2.0 TDi	Diesel	103	12/04 → 11/08
---------	--------	-----	---------------

2.0 TDi	Diesel	125	11/05 → 11/08
---------	--------	-----	---------------

SPA111

VOLKSWAGEN
GOLF V (1K1)

2.0 TDI 16V	Diesel	103	10/03 → 11/08
-------------	--------	-----	---------------

2.0 TDI 16V 4motion	Diesel	103	08/04 → 11/08
------------------------	--------	-----	---------------

2.0 TDI 4motion	Diesel	103	08/04 → 11/08
-----------------	--------	-----	---------------

3.2	Petrol	184	09/05 → 11/08
-----	--------	-----	---------------

3.2 R32 4motion	Petrol	184	11/05 → 11/08
-----------------	--------	-----	---------------

GOLF V Variant (1K5)

1.4 TSI	Petrol	103	06/07 → 07/09
---------	--------	-----	---------------

1.4 TSI	Petrol	125	06/07 → 07/09
---------	--------	-----	---------------

2.0 TDi	Diesel	103	06/07 → 07/09
---------	--------	-----	---------------

GOLF VI (5K1)

1.2 TSI	Petrol	63	05/10 → 11/12
---------	--------	----	---------------

1.2 TSI	Petrol	77	05/09 → 11/12
---------	--------	----	---------------

1.4	Petrol	59	10/08 → 11/12
-----	--------	----	---------------

1.4 TSI	Petrol	118	10/08 → 11/12
---------	--------	-----	---------------

1.4 TSI	Petrol	90	10/08 → 11/12
---------	--------	----	---------------

1.6	Petrol	75	10/08 → 11/12
-----	--------	----	---------------

1.6 Bifuel	Petrol/ LPG	75	03/09 → 11/12
------------	----------------	----	---------------

1.6 Multifuel	Petrol/ Ethanol	75	05/10 → 11/12
---------------	--------------------	----	---------------

1.6 TDI	Diesel	66	02/09 → 11/12
---------	--------	----	---------------

1.6 TDI	Diesel	77	02/09 → 11/12
---------	--------	----	---------------

1.8 TSI	Petrol	118	06/09 → 01/11
---------	--------	-----	---------------

2.0 GTI	Petrol	155	04/09 → 11/12
---------	--------	-----	---------------

2.0 R 4motion	Petrol	188	11/09 → 11/13
---------------	--------	-----	---------------

2.0 R 4motion	Petrol	195	11/09 → 05/11
---------------	--------	-----	---------------

2.0 R 4motion	Petrol	199	11/09 → 11/12
---------------	--------	-----	---------------

2.0 TDi	Diesel	100	10/08 → 11/12
---------	--------	-----	---------------

2.0 TDi	Diesel	103	10/08 → 05/13
---------	--------	-----	---------------

2.0 TDi	Diesel	125	04/09 → 11/12
---------	--------	-----	---------------

2.0 TDi	Diesel	81	10/08 → 11/12
---------	--------	----	---------------

2.0 TDI 4motion	Diesel	103	05/09 → 11/12
-----------------	--------	-----	---------------

GOLF VI Cabriolet (517)

1.2 TSI	Petrol	77	03/11 → 11/13
---------	--------	----	---------------

1.4 TSI	Petrol	118	03/11 →
---------	--------	-----	---------

1.4 TSI	Petrol	90	11/11 →
---------	--------	----	---------

1.6 TDI	Diesel	77	03/11 →
---------	--------	----	---------

2.0 GTI	Petrol	155	11/11 →
---------	--------	-----	---------

GOLF VI Variant (AJ5)

1.4 TSI	Petrol	90	07/09 → 07/13
---------	--------	----	---------------

1.4 TSI	Petrol	118	07/09 → 07/13
---------	--------	-----	---------------

SPA111



VOLKSWAGEN

JETTA III (1K2)

1.4 TSI	Petrol	103	07/06 → 10/10
1.4 TSI	Petrol	118	07/08 → 10/10
1.4 TSI	Petrol	125	07/06 → 10/10
1.4 TSI	Petrol	90	05/07 → 10/10
1.6	Petrol	75	10/05 → 10/10
1.6 FSI	Petrol	85	09/05 → 10/10
1.6 Multifuel	Petrol/ Ethanol	75	01/08 → 10/10
1.6 TDI	Diesel	66	12/09 → 10/10
1.6 TDI	Diesel	77	06/09 → 10/10
1.9 TDI	Diesel	77	08/05 → 10/10
2.0 FSI	Petrol	110	08/05 → 10/10
2.0 TDi	Diesel	100	09/05 → 10/10
2.0 TDi	Diesel	103	10/05 → 10/10
2.0 TDi	Diesel	125	10/06 → 10/10
2.0 TDi 16V	Diesel	103	08/05 → 10/10
2.0 TFSI	Petrol	147	10/05 → 10/10
2.5 FSI	Petrol	110	01/06 → 10/10
2.5 FSI	Petrol	125	07/08 → 10/10

JETTA IV (162, 163)

1.4 TSI	Petrol	118	04/11 →
1.4 TSI	Petrol	90	07/11 →
2.0 TSI	Petrol	147	12/10 →

MULTIVAN V (7HM, 7HN, 7HF, 7EF, 7EM, 7EN)

1.9 TDI	Diesel	77	04/03 → 11/09
1.9 TDI	Diesel	62	01/06 → 11/09
1.9 TDI	Diesel	63	06/05 → 11/09
1.9 TDI	Diesel	75	06/06 → 11/09
2.0	Petrol	85	11/03 →
2.0 BiTDI	Diesel	132	09/09 →
2.0 BiTDI 4motion	Diesel	132	09/09 →
2.0 TDi	Diesel	100	05/10 →
2.0 TDi	Diesel	103	09/09 →
2.0 TDi	Diesel	62	09/09 →
2.0 TDi	Diesel	75	09/09 →
2.0 TDi	Diesel	84	05/11 →
2.0 TDi 4motion	Diesel	100	05/10 →
2.0 TDi 4motion	Diesel	103	09/09 →
2.0 TSI	Petrol	150	05/11 →
2.0 TSI 4motion	Petrol	150	07/11 →
2.5 TDI	Diesel	120	11/03 → 11/09
3.2 V6	Petrol	170	02/04 → 06/04
3.2 V6	Petrol	173	02/04 → 11/09

SPA111



VOLKSWAGEN

MULTIVAN V (7HM, 7HN, 7HF, 7EF, 7EM, 7EN)

3.2 V6 4motion	Petrol	173	07/04 → 11/09
----------------	--------	-----	---------------

NEW BEETLE (9C1, 1C1)

2.0	Petrol	85	01/06 → 09/10
2.5	Petrol	110	01/06 → 09/10

NEW BEETLE Cabriolet (1Y7)

2.5	Petrol	110	01/06 → 09/10
-----	--------	-----	---------------

PASSAT (362)

1.4 TSI	Petrol	90	08/10 →
---------	--------	----	---------

1.4 TSI EcoFuel	Petrol/ CNG	110	09/10 →
-----------------	----------------	-----	---------

1.4 TSI MultiFuel	Petrol/ Ethanol	118	11/10 →
-------------------	--------------------	-----	---------

1.6 TDI	Diesel	77	08/10 →
---------	--------	----	---------

1.8 TSI	Petrol	112	02/11 →
---------	--------	-----	---------

1.8 TSI	Petrol	118	08/10 →
---------	--------	-----	---------

2.0 TDi	Diesel	100	08/10 →
---------	--------	-----	---------

2.0 TDi	Diesel	103	08/10 →
---------	--------	-----	---------

2.0 TDi	Diesel	125	08/10 →
---------	--------	-----	---------

2.0 TDi 4motion	Diesel	103	08/10 →
-----------------	--------	-----	---------

2.0 TDi 4motion	Diesel	125	08/10 →
-----------------	--------	-----	---------

2.0 TSI	Petrol	155	11/10 →
---------	--------	-----	---------

PASSAT (3B3)

2.3 V5	Petrol	125	11/00 → 03/05
--------	--------	-----	---------------

2.3 V5 4motion	Petrol	125	01/01 → 05/05
----------------	--------	-----	---------------

4.0 W8 4motion	Petrol	202	09/01 → 09/04
----------------	--------	-----	---------------

PASSAT (3C2)

1.4 TSI	Petrol	90	05/07 → 07/10
---------	--------	----	---------------

1.4 TSI EcoFuel	BiFuel	110	01/09 → 07/10
-----------------	--------	-----	---------------

1.6	Petrol	75	05/05 → 07/10
-----	--------	----	---------------

1.6 FSI	Petrol	85	03/05 → 06/08
---------	--------	----	---------------

1.6 TDI	Diesel	77	08/09 → 07/10
---------	--------	----	---------------

1.8 TSI	Petrol	112	11/09 → 07/10
---------	--------	-----	---------------

1.8 TSI	Petrol	118	05/07 → 07/10
---------	--------	-----	---------------

1.9 TDI	Diesel	77	03/05 → 11/08
---------	--------	----	---------------

2.0 BlueTDI	Diesel	105	01/09 → 11/10
-------------	--------	-----	---------------

2.0 FSI	Petrol	110	03/05 → 07/10
---------	--------	-----	---------------

2.0 FSI	Petrol	125	08/07 → 07/10
---------	--------	-----	---------------

2.0 FSI	Petrol	147	07/05 → 07/10
---------	--------	-----	---------------

2.0 FSI 4motion	Petrol	110	09/05 → 07/10
-----------------	--------	-----	---------------

2.0 TDi	Diesel	100	03/05 → 11/10
---------	--------	-----	---------------

2.0 TDi	Diesel	103	03/05 → 05/09
---------	--------	-----	---------------

2.0 TDi	Diesel	120	08/05 → 05/09
---------	--------	-----	---------------

2.0 TDi	Diesel	125	08/05 → 07/10
---------	--------	-----	---------------

SPA111

VOLKSWAGEN
PASSAT (3C2)

2.0 TDi	Diesel	90	08/05 → 07/06
2.0 TDi	Diesel	81	11/08 → 07/10
2.0 TDi	Diesel	88	11/05 → 05/07
2.0 TDI 16V	Diesel	103	03/05 → 07/10
2.0 TDI 16V 4motion	Diesel	103	03/05 → 08/10
2.0 TDI 4motion	Diesel	103	03/05 → 05/09
2.0 TDI 4motion	Diesel	125	05/09 → 11/10
3.2 FSI 4motion	Petrol	184	11/05 → 07/10
3.6 R36 4motion	Petrol	220	04/07 → 07/10

PASSAT ALLTRACK (365)

2.0 TSI 4motion	Petrol	155	01/12 →
-----------------	--------	-----	---------

PASSAT CC (357)

1.4 TSI MultiFuel	Petrol/ Ethanol	118	01/11 → 01/12
1.8 TSI	Petrol	112	11/08 → 05/10
1.8 TSI	Petrol	118	06/08 → 11/10
2.0 BlueTDI	Diesel	105	05/09 → 11/10
2.0 TDi	Diesel	100	06/08 → 05/11
2.0 TDi	Diesel	103	06/08 → 01/12
2.0 TDi	Diesel	125	06/08 → 01/12
2.0 TDI 4motion	Diesel	103	08/09 → 01/12
2.0 TDI 4motion	Diesel	125	11/09 → 01/12
2.0 TSI	Petrol	147	06/08 → 01/12
2.0 TSI	Petrol	155	11/10 → 01/12
3.6 FSI 4motion	Petrol	220	06/08 → 05/10

PASSAT Variant (365)

1.4 TSI	Petrol	90	08/10 →
1.4 TSI EcoFuel	BiFuel	110	09/10 →
1.4 TSI MultiFuel	Petrol/ Ethanol	118	11/10 →
1.6 TDI	Diesel	77	08/10 →
1.8 TSI	Petrol	112	02/11 →
1.8 TSI	Petrol	118	08/10 →
2.0 TDi	Diesel	100	08/10 →
2.0 TDi	Diesel	103	08/10 →
2.0 TDi	Diesel	125	08/10 →
2.0 TDI 4motion	Diesel	103	08/10 →
2.0 TDI 4motion	Diesel	125	08/10 →
2.0 TSI	Petrol	155	11/10 →

PASSAT Variant (3B6)

2.3 VR5 4motion	Petrol	125	01/01 → 05/05
4.0 W8 4motion	Petrol	202	09/01 → 09/04

SPA111

VOLKSWAGEN
PASSAT Variant (3C5)

1.4 TSI	Petrol	90	05/07 → 11/10
1.4 TSI EcoFuel	Petrol/ CNG	110	01/09 → 11/10
1.6	Petrol	75	08/05 → 11/10
1.6 FSI	Petrol	85	08/05 → 06/08
1.6 TDI	Diesel	77	08/09 → 11/10
1.8 TSI	Petrol	112	11/09 → 11/10
1.8 TSI	Petrol	118	05/07 → 10/11
1.9 TDI	Diesel	77	08/05 → 11/08
2.0 BlueTDI	Diesel	105	01/09 → 11/10
2.0 FSI	Petrol	110	08/05 → 11/10
2.0 FSI	Petrol	147	08/05 → 11/10
2.0 FSI 4motion	Petrol	110	09/05 → 11/10
2.0 TDi	Diesel	100	08/05 → 11/10
2.0 TDi	Diesel	103	08/05 → 05/09
2.0 TDi	Diesel	120	08/05 → 05/09
2.0 TDi	Diesel	125	08/05 → 11/10
2.0 TDi	Diesel	90	08/05 → 02/06
2.0 TDi	Diesel	81	11/08 → 11/10
2.0 TDI 16V	Diesel	103	08/05 → 11/10
2.0 TDI 16V 4motion	Diesel	103	08/05 → 11/10
2.0 TDI 4motion	Diesel	103	08/05 → 05/09
2.0 TDI 4motion	Diesel	125	11/09 → 11/10
3.2 FSI 4motion	Petrol	184	11/05 → 11/10
3.6 R36 4motion	Petrol	220	04/07 → 11/10

PHAETON (3D_)

3.0 V6 TDI 4motion	Diesel	165	09/04 →
3.0 V6 TDI 4motion	Diesel	171	06/07 →
3.0 V6 TDI 4motion	Diesel	176	11/08 →
3.2 V6	Petrol	177	04/02 →
3.2 V6 4motion	Petrol	177	02/04 →
3.6 V6 4motion	Petrol	206	11/08 →
4.2 V8 4motion	Petrol	246	05/03 →
5.0 V10 TDI 4motion	Diesel	230	11/02 →
6.0 W12 4motion	Petrol	309	04/02 →
6.0 W12 4motion	Petrol	331	05/05 →

POLO (6R, 6C)

1.2	Petrol	44	06/09 →
1.2	Petrol	51	06/09 →

SPA111



KW



VOLKSWAGEN

POLO (6R, 6C)

1.2 TDI	Diesel	55	10/09 →
1.2 TSI	Petrol	77	11/09 →
1.4	Petrol	63	06/09 →
1.4 BiFuel	Petrol/ LPG	60	03/10 → 01/11
1.4 GTi	Petrol	132	05/10 →
1.6 Bifuel	Petrol/ LPG	60	01/11 →
1.6 TDI	Diesel	55	06/09 →
1.6 TDI	Diesel	66	06/09 →
1.6 TDI	Diesel	77	06/09 →

POLO (9N_)

1.2	Petrol	40	01/02 → 05/07
1.2 12V	Petrol	47	10/01 → 07/07
1.2 12V	Petrol	51	05/07 → 11/09
1.4 16V	Petrol	55	10/01 → 05/08
1.4 16V	Petrol	59	05/06 → 11/09
1.4 16V	Petrol	74	10/01 → 05/08
1.4 FSI	Petrol	63	02/02 → 07/06
1.4 TDI	Diesel	51	04/05 → 11/09
1.4 TDI	Diesel	55	10/01 → 06/05
1.4 TDI	Diesel	59	04/05 → 11/09
1.6 16V	Petrol	77	05/06 → 11/09
1.9 SDI	Diesel	47	10/01 → 11/09
1.9 TDI	Diesel	96	11/03 → 11/09
1.9 TDI	Diesel	74	10/01 → 11/09

POLO Tre volumi

1.6	Petrol	63	11/10 →
1.6	Petrol	77	09/10 →

POLO Tre volumi (9A4)

1.4	Petrol	55	07/03 →
1.4	Petrol	74	11/03 →
1.4 TDI	Diesel	55	07/03 →
1.6	Petrol	74	09/02 →
1.9 SDI	Diesel	47	09/02 →
1.9 TDI	Diesel	74	09/02 →

SCIROCCO (137, 138)

1.4 TSI	Petrol	118	05/08 →
1.4 TSI	Petrol	90	11/08 →
2.0 R	Petrol	195	11/09 →
2.0 R	Petrol	188	11/09 →
2.0 TDi	Diesel	100	11/10 →
2.0 TDi	Diesel	103	08/08 →
2.0 TDi	Diesel	125	05/09 →

SPA111



KW



VOLKSWAGEN

SCIROCCO (137, 138)

2.0 TSI	Petrol	147	05/08 → 11/09
2.0 TSI	Petrol	155	11/09 → 05/11

SHARAN (7M8, 7M9, 7M6)

2.0 TDi	Diesel	100	11/05 → 03/10
---------	--------	-----	---------------

SHARAN (7N)

1.4 TSI	Petrol	110	05/10 →
2.0 TDi	Diesel	100	05/10 →
2.0 TDi	Diesel	103	05/10 →
2.0 TDi	Diesel	125	08/10 →
2.0 TDi	Diesel	85	05/11 →
2.0 TDi 4motion	Diesel	100	05/11 → 05/12
2.0 TDi 4motion	Diesel	103	05/11 →

TIGUAN (5N_)

1.4 TSI	Petrol	110	05/08 →
1.4 TSI	Petrol	118	05/11 →
1.4 TSI	Petrol	90	08/10 →
1.4 TSI 4motion	Petrol	110	11/07 →
1.4 TSI 4motion	Petrol	118	05/11 →
2.0 TDi	Diesel	103	03/08 →
2.0 TDi	Diesel	81	05/10 →
2.0 TDi 4motion	Diesel	100	11/07 →
2.0 TDi 4motion	Diesel	103	11/07 →
2.0 TDi 4motion	Diesel	120	02/08 → 08/09
2.0 TDi 4motion	Diesel	125	02/08 →
2.0 TFSI 4motion	Petrol	125	01/08 →
2.0 TFSI 4motion	Petrol	147	11/07 →
2.0 TSI 4motion	Petrol	132	05/11 →
2.0 TSI 4motion	Petrol	155	05/11 →

TOUAREG (7LA, 7L6, 7L7)

3.0 TDI	Diesel	155	04/06 → 05/10
3.0 V6 TDI	Diesel	176	11/07 → 05/10
3.2 V6	Petrol	162	10/02 → 11/06
3.2 V6	Petrol	177	11/04 → 11/06
3.6 V6 FSI	Petrol	206	10/05 → 05/10
4.2 V8	Petrol	228	12/02 → 11/06
4.2 V8 FSI	Petrol	257	06/06 → 05/10
5.0 R50 TDI	Diesel	257	08/07 → 05/10
5.0 V10 TDI	Diesel	230	10/02 → 05/10
6.0 W12	Petrol	331	08/04 → 05/10

TOUAREG (7P5)

3.0 V6 TDI	Diesel	150	01/10 →
3.0 V6 TDI	Diesel	176	01/10 → 05/11
3.0 V6 TSI Hybrid	Petrol	245	04/10 →

SPA111

VOLKSWAGEN
TOUAREG (7P5)

3.6 V6 FSI	Petrol	183	08/10 →	
3.6 V6 FSI	Petrol	206	04/10 →	
4.2 V8 FSI	Petrol	265	01/11 →	
4.2 V8 TDI	Diesel	250	01/10 →	

TOURAN (1T1, 1T2)

1.4 FSI	Petrol	125	11/06 → 05/10	
1.4 TSI	Petrol	103	02/06 → 05/10	
1.4 TSI EcoFuel	Petrol/ CNG	110	05/09 → 05/10	
1.6	Petrol	75	07/03 → 05/10	
1.6 FSI	Petrol	85	02/03 → 01/07	
1.6 TDI	Diesel	77	04/10 → 05/10	
1.9 TDI	Diesel	66	11/04 → 05/10	
1.9 TDI	Diesel	74	02/03 → 05/04	
1.9 TDI	Diesel	77	08/03 → 05/10	
2.0 EcoFuel	Petrol/ CNG	80	02/06 → 05/09	
2.0 FSI	Petrol	110	10/03 → 11/05	
2.0 TDi	Diesel	103	12/05 → 05/10	
2.0 TDi	Diesel	125	12/05 → 05/10	
2.0 TDi	Diesel	100	02/03 → 05/10	
2.0 TDi 16V	Diesel	103	08/03 → 05/10	

TOURAN (1T3)

1.6 TDI	Diesel	66	05/10 →	
2.0 TDi	Diesel	81	11/10 →	

TRANSPORTER V Autobus (7HB, 7HJ, 7EB, 7EJ, 7EF)

1.9 TDI	Diesel	62	01/06 → 11/09	
1.9 TDI	Diesel	63	04/03 → 11/09	
1.9 TDI	Diesel	75	06/06 → 11/09	
1.9 TDI	Diesel	77	04/03 → 11/09	
2.0	Petrol	85	11/03 →	
2.0 BiTDI	Diesel	132	09/09 →	
2.0 BiTDI 4motion	Diesel	132	09/09 →	
2.0 TDi	Diesel	100	05/10 →	
2.0 TDi	Diesel	103	09/09 →	
2.0 TDi	Diesel	62	09/09 →	
2.0 TDi	Diesel	75	09/09 →	
2.0 TDi	Diesel	84	05/11 →	
2.0 TDi 4motion	Diesel	100	05/10 →	
2.0 TDi 4motion	Diesel	103	09/09 →	
2.0 TSI	Petrol	150	05/11 →	
2.0 TSI 4motion	Petrol	150	07/11 →	
2.5 TDI	Diesel	120	11/03 → 11/09	

SPA111

VOLKSWAGEN
TRANSPORTER V Autobus (7HB, 7HJ, 7EB, 7EJ, 7EF)

3.2 V6	Petrol	170	02/04 → 06/04	
3.2 V6	Petrol	173	02/04 → 11/09	
3.2 V6 4motion	Petrol	173	11/03 → 11/09	

TRANSPORTER V Furgonato (7HA, 7HH, 7EA, 7EH)

1.9 TDI	Diesel	62	01/06 → 11/09	
1.9 TDI	Diesel	63	04/03 → 11/09	
1.9 TDI	Diesel	75	06/06 → 11/09	
1.9 TDI	Diesel	77	04/03 → 11/09	
2.0	Petrol	85	11/03 →	
2.0 BiTDI	Diesel	132	09/09 →	
2.0 BiTDI 4motion	Diesel	132	09/09 →	
2.0 TDi	Diesel	100	05/10 →	
2.0 TDi	Diesel	103	09/09 →	
2.0 TDi	Diesel	62	09/09 →	
2.0 TDi	Diesel	75	09/09 →	
2.0 TDi	Diesel	84	05/11 →	
2.0 TDi 4motion	Diesel	100	05/10 →	
2.0 TDi 4motion	Diesel	103	09/09 →	
2.0 TSI	Petrol	150	05/11 →	
2.0 TSI 4motion	Petrol	150	07/11 →	
3.2 4motion	Petrol	173	11/03 → 11/09	
3.2 V6	Petrol	170	04/03 → 06/04	
3.2 V6	Petrol	173	02/04 → 11/09	

TRANSPORTER V Pianale piatto/Telaio (7JD, 7JE, 7JL, 7JY, 7JZ)

1.9 TDI	Diesel	62	01/06 → 11/09	
1.9 TDI	Diesel	63	04/03 → 11/09	
1.9 TDI	Diesel	75	06/06 → 11/09	
1.9 TDI	Diesel	77	04/03 → 11/09	
2.0	Petrol	85	09/09 →	
2.0 BiTDI	Diesel	132	09/09 →	
2.0 BiTDI 4motion	Diesel	132	01/10 →	
2.0 TDi	Diesel	100	05/10 →	
2.0 TDi	Diesel	103	09/09 →	
2.0 TDi	Diesel	62	09/09 →	
2.0 TDi	Diesel	75	09/09 →	
2.0 TDi	Diesel	84	05/11 →	
2.0 TDi 4motion	Diesel	100	05/10 →	
2.0 TDi 4motion	Diesel	103	09/09 →	
3.2 V6	Petrol	170	02/04 → 11/09	

SPA112

F1 **SENSORE TEMPERATURA REFRIGERANTE**
COOLANT TEMPERATURE SENSOR

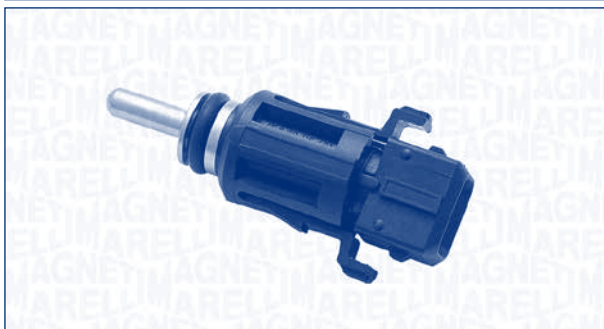

BMW

3 (E46)

316 i	Petrol	77	09/98 → 02/05
318 i	Petrol	87	02/98 → 09/01
320 i	Petrol	110	03/98 → 09/00
320 i	Petrol	125	09/00 → 02/05
323 i	Petrol	125	03/98 → 09/00
328 i	Petrol	142	02/98 → 06/00

3 Cabriolet (E46)

323 Ci	Petrol	125	04/00 → 09/00
--------	--------	-----	---------------

3 Coupé (E46)

316 Ci	Petrol	77	04/00 →
318 Ci	Petrol	87	11/99 → 09/01
320 Ci	Petrol	110	08/99 → 09/00
328 Ci	Petrol	142	04/99 → 06/00

3 Touring (E46)

316 i	Petrol	85	03/02 → 02/05
320 i	Petrol	110	10/99 → 09/00
328 i	Petrol	142	10/99 → 06/00

5 (E39)

520 i	Petrol	110	09/98 → 09/00
520 i	Petrol	125	09/00 → 06/03
523 i	Petrol	125	09/98 → 09/00
525 i	Petrol	141	09/00 → 06/03
528 i	Petrol	142	09/98 → 09/00
530 i	Petrol	170	09/00 → 06/03
535 i	Petrol	180	04/99 → 06/03
540 i	Petrol	210	04/96 → 06/03
M 4.9	Petrol	294	10/98 → 06/03

5 Touring (E39)

520 i	Petrol	125	09/00 → 05/04
525 i	Petrol	141	09/00 → 05/04
528 i	Petrol	142	09/98 → 09/00
530 i	Petrol	170	09/00 → 05/04

SPA112



BMW

7 (E38)

728 i,iL	Petrol	142	09/98 → 11/01
735 i,iL	Petrol	173	09/98 → 11/01
740 i,iL	Petrol	210	09/98 → 11/01
750 i,iL	Petrol	240	09/98 → 11/01

X5 (E53)

3.0 i	Petrol	163	05/00 →
4.4 i	Petrol	210	05/00 →

Z8 (E52)

4.9	Petrol	294	06/00 → 06/03
-----	--------	-----	---------------

SPA113

F1 **SENSORE TEMPERATURA REFRIGERANTE**
COOLANT TEMPERATURE SENSOR

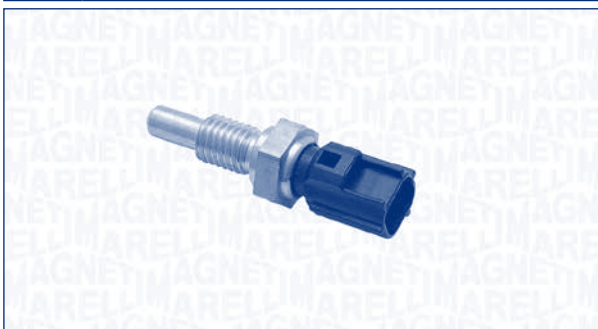

FORD

FIESTA IV (JA_, JB_)

1.6 16V Sport	Petrol	76	02/00 → 01/02
---------------	--------	----	---------------

FOCUS (DAW, DBW)

1.4 16V	Petrol	55	10/98 → 11/04
1.6 16V	Petrol	74	10/98 → 11/04

FOCUS Station wagon (DNW)

1.4 16V	Petrol	55	02/99 → 11/04
1.6 16V	Petrol	74	02/99 → 11/04

FOCUS Tre volumi (DFW)

1.4 16V	Petrol	55	02/99 → 11/04
1.6 16V	Petrol	74	02/99 → 11/04

PUMA (EC_)

1.6 16V	Petrol	76	08/00 → 06/02
---------	--------	----	---------------

SPA115
F1 **SENSORE TEMPERATURA REFRIGERANTE**
COOLANT TEMPERATURE SENSOR

ALFA ROMEO
145 (930)

1.6 i.e. Petrol 76 01/95 → 12/96

146 (930)

1.6 i.e. Petrol 76 05/95 → 12/96

CHEVROLET
EVANDA

2.0 Petrol 96 03/05 →

KALOS

1.4 Petrol 61 03/05 →

1.4 16V Petrol 69 03/05 →

KALOS Tre volumi

1.4 16V Petrol 69 03/05 →

LACETTI (J200)

1.4 16V Petrol 70 03/05 →

1.6 Petrol 80 03/05 →

1.8 Petrol 90 03/05 →

MATIZ (M200, M250)

0.8 Petrol 38 03/05 →

1.0 Petrol 47 03/05 →

1.0 Petrol 49 03/05 →

NUBIRA Station wagon

1.6 Petrol 80 03/05 →

1.8 Petrol 90 03/05 →

NUBIRA Tre volumi

1.6 Petrol 80 03/05 →

1.8 Petrol 90 03/05 →

TACUMA

2.0 Petrol 89 03/05 →

DAEWOO
ESPERO (KLEJ)

1.5 16V Petrol 66 02/95 → 06/99

2.0 Petrol 96 08/02 →

SPA115

DAEWOO
KALOS (KLAS)

1.4 Petrol 61 09/02 →

1.4 16V Petrol 69 04/03 →

LACETTI 2 volumi /Coda spiovente (KLAN)

1.4 Petrol 70 02/04 →

1.6 Petrol 80 02/04 →

1.8 Petrol 90 02/04 →

LANOS (KLAT)

1.4 Petrol 55 05/97 →

1.5 Petrol 63 05/97 →

1.6 16V Petrol 78 05/97 →

LANOS Tre volumi (KLAT)

1.4 Petrol 55 05/97 →

1.5 Petrol 63 05/97 →

1.6 16V Petrol 78 05/97 →

LEGANZA (KLAV)

2.0 16V Petrol 98 06/97 → 12/02

2.2 16V Petrol 100 04/99 → 12/02

MATIZ (KLYA)

0.8 Petrol 38 09/98 →

NEXIA (KLETN)

1.5 Petrol 52 02/95 → 08/97

1.5 Petrol 55 02/95 → 08/97

1.5 16V Petrol 66 02/95 → 08/97

NEXIA Tre volumi (KLETN)

1.5 Petrol 52 02/95 → 08/97

1.5 Petrol 55 02/95 → 08/97

1.5 16V Petrol 66 02/95 → 08/97

NUBIRA (KLAJ)

1.6 16V Petrol 78 05/97 → CHASSIS: → 580669

2.0 16V Petrol 98 05/97 →

NUBIRA Tre volumi (KLAJ)

1.6 16V Petrol 76 07/00 → CHASSIS: → 580669

1.6 16V Petrol 78 05/97 → CHASSIS: → 580669

2.0 16V Petrol 98 05/97 →

2.0 16V Petrol 93 12/00 →

NUBIRA Tre volumi (KLAN)

1.6 Petrol 80 07/03 →

1.8 Petrol 90 07/03 →

NUBIRA Wagon (KLAJ)

1.6 16V Petrol 66 06/97 → CHASSIS: → 580669

1.6 16V Petrol 76 12/00 → CHASSIS: → 580669

1.6 16V Petrol 78 05/97 → CHASSIS: → 580669

2.0 16V Petrol 98 05/97 →

2.0 16V Petrol 93 12/00 →

SPA115



DAEWOO

TACUMA (KLAU)

2.0	Petrol	94	09/00 →
2.0	Petrol	89	09/01 →

FIAT

PUNTO Cabriolet (176C)

90 1.6	Petrol	65	04/94 → 04/97
--------	--------	----	---------------

TEMPRA (159)

1.6 i.e. (159.AJ)	Petrol	63	06/94 → 08/96
1.6 i.e. (159.AJ)	Petrol	66	06/94 → 08/96

TEMPRA S.W. (159)

1.6 i.e. (159.AJ)	Petrol	66	06/94 → 08/96
-------------------	--------	----	---------------

LANCIA

DEDRA (835)

1.6 LE (835EB) Cat.	Petrol	66	07/94 → 07/99
------------------------	--------	----	---------------

DEDRA SW (835)

1.6 (835EB)	Petrol	66	10/94 → 07/99
-------------	--------	----	---------------

OPEL

ASTRA G 2 volumi /Coda spiovente (F48_, F08_)

2.2 16V	Petrol	108	06/00 → 01/05
---------	--------	-----	---------------

ASTRA G Cabriolet (F67)

2.2 16V	Petrol	108	03/01 → 10/05
---------	--------	-----	---------------

ASTRA G Coupé (F07_)

2.2 16V	Petrol	108	09/00 → 05/05
---------	--------	-----	---------------

ASTRA G Station wagon (F35_)

2.2 16V	Petrol	108	03/01 → 07/04
---------	--------	-----	---------------

ASTRA G Tre volumi (F69_)

2.2 16V	Petrol	108	03/01 → 01/05
---------	--------	-----	---------------

CORSA A 2 volumi /Coda spiovente (93_, 94_, 98_, 99_)

1.6 GSI	Petrol	55	08/88 → 09/92
---------	--------	----	---------------

FRONTERA B (6B_)

2.2 i (6B_ZC, 6B_VF, 6B_66, 6B_76)	Petrol	100	10/98 →
--	--------	-----	---------

SIGNUM

2.2 direct	Petrol	114	05/03 →
3.0 V6 CDTI	Diesel	130	05/03 →
3.0 V6 CDTI	Diesel	135	09/05 →

SPEEDSTER

2.2	Petrol	108	09/00 →
-----	--------	-----	---------

VECTRA B (36_)

2.2 i 16V	Petrol	108	09/00 → 04/02
-----------	--------	-----	---------------

VECTRA B 2 volumi /Coda spiovente (38_)

2.2 i 16V	Petrol	108	09/00 → 07/03
-----------	--------	-----	---------------

SPA115



OPEL

VECTRA B Station wagon (31_)

2.2 i 16V	Petrol	108	09/00 → 07/03
-----------	--------	-----	---------------

VECTRA C

2.2 16V	Petrol	108	04/02 →
2.2 direct	Petrol	114	10/03 →
3.0 CDTI	Diesel	130	06/03 →
3.0 CDTI	Diesel	135	08/05 →

VECTRA C GTS

2.2 16V	Petrol	108	08/02 →
2.2 direct	Petrol	114	10/03 →
3.0 CDTI	Diesel	130	06/03 →
3.0 CDTI	Diesel	135	08/05 →

VECTRA C Station wagon

2.2 direct	Petrol	114	10/03 →
3.0 V6 CDTI	Diesel	130	10/03 →

ZAFIRA A (F75_)

2.2 16V	Petrol	108	09/00 → 06/05
---------	--------	-----	---------------

RENAULT

ESPACE IV (JK0/1_)

3.0 dCi (JK0J, JK0V)	Diesel	130	11/02 →
-------------------------	--------	-----	---------

VEL SATIS (BJ0_)

3.0 dCi (BJ0J, BJ0N)	Diesel	130	06/02 →
-------------------------	--------	-----	---------

SPA116

F1

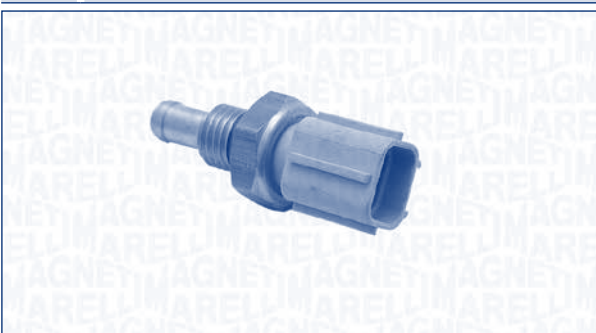
SENSORE TEMPERATURA REFRIGERANTE
COOLANT TEMPERATURE SENSOR

FORD

ESCORT CLASSIC (AAL, ABL)

1.6 16V	Petrol	66	10/98 → 07/00
---------	--------	----	---------------

ESCORT CLASSIC Turnier (ANL)

1.6 16V	Petrol	66	02/99 → 07/00
---------	--------	----	---------------

SPA116

FORD
ESCORT VII (GAL, AAL, ABL)

1.6 16V	Petrol	66	05/98 → 10/98
1.6 16V 4x4	Petrol	66	05/98 → 10/98
1.8 16V	Petrol	85	05/98 → 10/98

ESCORT VII Cabriolet (ALL)

1.6 16V XR3i	Petrol	66	05/98 → 09/99
1.8 16V XR3i	Petrol	77	05/98 → 08/98
1.8 16V XR3i	Petrol	85	05/98 → 08/98

ESCORT VII Station wagon (GAL, ANL)

1.6 16V	Petrol	66	05/98 → 02/99
1.8 16V	Petrol	85	05/98 → 02/99

ESCORT VII Tre volumi (GAL, AFL)

1.6 i 16V	Petrol	66	05/98 → 02/99
-----------	--------	----	---------------

ESCORT VII Tre volumi (GAL, AFL)

1.8 16V	Petrol	85	05/98 → 02/99
---------	--------	----	---------------

FIESTA V (JH_, JD_)

ST150	Petrol	110	03/05 → 06/08
-------	--------	-----	---------------

FOCUS C-MAX

1.8	Petrol	88	10/03 → 03/07
1.8	Petrol	92	04/04 → 03/07
2.0	Petrol	107	03/04 → 03/07

FOCUS II (DA_)

2.0	Petrol	107	11/04 →
-----	--------	-----	---------

FOCUS II Station wagon (DA_)

2.0	Petrol	107	11/04 →
-----	--------	-----	---------

FOCUS II Tre volumi (DA_)

2.0	Petrol	107	04/05 →
-----	--------	-----	---------

MONDEO II (BAP)

1.6 i 16V	Petrol	70	06/98 → 11/99
-----------	--------	----	---------------

MONDEO II Station wagon (BNP)

1.6 i 16V	Petrol	70	05/98 → 11/99
-----------	--------	----	---------------

MONDEO II Tre volumi (BFP)

1.6 i 16V	Petrol	70	06/98 → 11/99
-----------	--------	----	---------------

MONDEO III (B5Y)

1.8 16V	Petrol	81	11/00 → 08/07
1.8 16V	Petrol	92	11/00 → 08/07
1.8 SCi	Petrol	96	06/03 → 08/07
2.0 16V	Petrol	107	11/00 → 08/07

MONDEO III Station wagon (BWY)

1.8 16V	Petrol	81	11/00 → 08/07
1.8 16V	Petrol	92	11/00 → 08/07
1.8 SCi	Petrol	96	06/03 → 08/07
2.0 16V	Petrol	107	11/00 → 08/07

SPA116

FORD
MONDEO III Tre volumi (B4Y)

1.8 16V	Petrol	81	11/00 → 08/07
1.8 16V	Petrol	92	11/00 → 08/07
1.8 SCi	Petrol	96	06/03 → 08/07
2.0 16V	Petrol	107	11/00 → 08/07

JAGUAR
S-TYPE (CCX)

2.5 V6	Petrol	147	04/02 → 10/07
4.0 V8	Petrol	203	01/99 → 04/02
4.2 V8	Petrol	219	04/02 → 10/07
R 4,2 V8	Petrol	291	04/02 → 10/07

XJ (X350, X358)

3.5	Petrol	190	05/03 → 03/09
4.2	Petrol	219	05/03 → 03/09
R 4.2	Petrol	291	05/03 → 03/09

XK 8 Convertible (QDV)

4.2	Petrol	219	08/02 → 12/06
R 4,2	Petrol	291	08/02 → 07/05

XK 8 Coupé (QEV)

4.2	Petrol	219	08/02 → 12/06
R 4,2	Petrol	291	08/02 → 07/05

MAZDA
3 (BK)

2.0	Petrol	110	10/03 → 06/09
-----	--------	-----	---------------

3 Tre volumi (BK)

2.0	Petrol	110	02/04 →
-----	--------	-----	---------

5 (CR19)

1.8	Petrol	85	03/05 →
2.0	Petrol	107	03/05 →

6 (GG)

1.8	Petrol	88	08/02 → 08/07
2.0	Petrol	104	06/02 → 08/07
2.0	Petrol	108	03/05 → 08/07
2.3	Petrol	122	06/02 → 08/07
2.3 MPS Turbo	Petrol	191	12/05 → 08/07

6 Hatchback (GG)

1.8	Petrol	88	08/02 → 08/07
2.0	Petrol	104	08/02 → 08/07
2.0	Petrol	108	03/05 → 08/07
2.3	Petrol	122	08/02 → 08/07

6 Station Wagon (GY)

1.8	Petrol	88	08/02 → 08/07
2.0	Petrol	104	08/02 → 08/07
2.0	Petrol	108	03/05 → 08/07
2.3	Petrol	122	08/02 → 08/07

SPA116



MAZDA

6 Station Wagon (GY)

2.3 AWD Petrol 119 11/02 → 08/07

626 V (GF)

1.8 Petrol 66 05/97 → 12/99

1.8 Petrol 74 12/99 → 10/02

2.0 Petrol 100 04/98 → 10/02

2.0 Petrol 85 05/97 → 10/02

626 V Hatchback (GF)

1.8 Petrol 66 05/97 → 12/99

1.8 Petrol 74 12/99 → 10/02

2.0 Petrol 85 05/97 → 10/02

2.0 H.P. Petrol 100 02/98 → 10/02

626 V Station Wagon (GW)

1.8 Petrol 66 02/98 → 01/00

1.8 Petrol 74 01/00 → 10/02

2.0 Petrol 85 02/98 → 10/02

2.0 H.P. Petrol 100 02/98 → 10/02

SPA117

F1 **SENSORE TEMPERATURA REFRIGERANTE**
COOLANT TEMPERATURE SENSOR

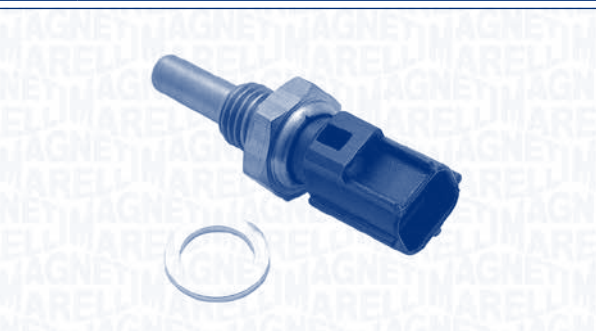

SUZUKI

X-90 (EL)

1.6 i 16V 4x4 Petrol 71 09/95 → 12/97

SPA119

F1 **SENSORE TEMPERATURA REFRIGERANTE**
COOLANT TEMPERATURE SENSOR

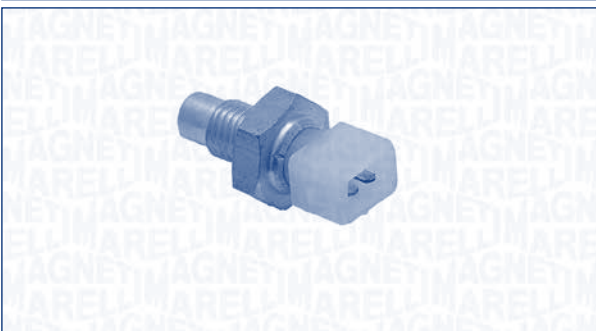

VOLKSWAGEN

KAEFER

1600 i (Mexico) Petrol 34 06/95 → 07/03

SPA120

F1 **SENSORE TEMPERATURA REFRIGERANTE**
COOLANT TEMPERATURE SENSOR

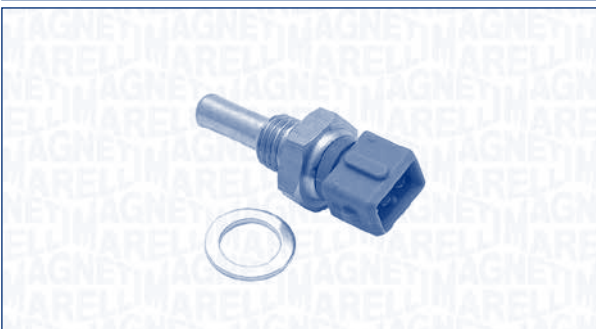

CITROËN

XANTIA (X2)

3.0 V6 Petrol 140 01/98 → 04/03

XANTIA Break (X2)

3.0 V6 Petrol 140 01/98 → 04/03

XM (Y4)

3.0 V6 Petrol 140 04/97 → 10/00

XM Break (Y4)

3.0 V6 Petrol 140 04/97 → 10/00

PEUGEOT

406 Coupé (8C)

3.0 V6 24V Petrol 140 03/97 → 12/04

RENAULT

ESPACE III (JE0_)

3.0 V6 24V (JE0G, JE0R) Petrol 140 10/98 → 10/02

SPA120

RENAULT
LAGUNA I Grandtour (K56_)

3.0 24V (K56V)	Petrol	140	03/97 → 03/01
----------------	--------	-----	---------------

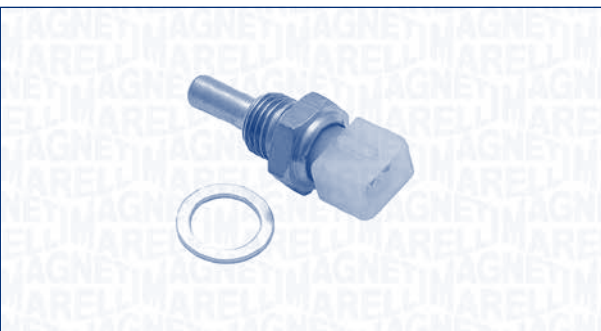
SPA121
F1 **SENSORE TEMPERATURA REFRIGERANTE
COOLANT TEMPERATURE SENSOR**

AUDI
100 (44, 44Q, C3)

2.5 TDI	Diesel	88	01/90 → 11/90
---------	--------	----	---------------

100 (4A, C4)

2.5 TDI	Diesel	85	06/91 → 06/94
---------	--------	----	---------------

S4 V8 quattro	Petrol	206	10/92 → 06/94
---------------	--------	-----	---------------

100 Avant (44, 44Q, C3)

2.5 TDI	Diesel	88	01/90 → 11/90
---------	--------	----	---------------

100 Avant (4A, C4)

2.5 TDI	Diesel	85	06/91 → 06/94
---------	--------	----	---------------

200 (44, 44Q)

2.2 20V Turbo quattro	Petrol	162	03/89 → 12/90
-----------------------	--------	-----	---------------

200 Avant (44, 44Q)

2.2 20V Turbo quattro	Petrol	162	07/89 → 12/90
-----------------------	--------	-----	---------------

80 (8C, B4)

S2 quattro	Petrol	169	02/93 → 12/94
------------	--------	-----	---------------

80 Avant (8C, B4)

S2 quattro	Petrol	169	07/94 → 07/95
------------	--------	-----	---------------

90 (89, 89Q, 8A, B3)

2.0 20 V quattro	Petrol	118	08/88 → 09/91
------------------	--------	-----	---------------

2.3 E 20V	Petrol	123	04/90 → 07/91
-----------	--------	-----	---------------

2.3 E 20V	Petrol	125	08/88 → 07/91
-----------	--------	-----	---------------

2.3 E 20V quattro	Petrol	123	04/90 → 09/91
-------------------	--------	-----	---------------

2.3 E 20V quattro	Petrol	125	06/88 → 09/91
-------------------	--------	-----	---------------

SPA121

AUDI
COUPE (89, 8B)

2.3 20V	Petrol	123	08/90 → 07/91
---------	--------	-----	---------------

2.3 20V	Petrol	125	08/89 → 07/91
---------	--------	-----	---------------

2.3 20V quattro	Petrol	123	05/90 → 07/91
-----------------	--------	-----	---------------

2.3 20V quattro	Petrol	125	11/88 → 07/91
-----------------	--------	-----	---------------

S2 quattro	Petrol	162	09/90 → 09/92
------------	--------	-----	---------------

QUATTRO (85)

2.2 20V Turbo	Petrol	162	08/89 → 07/91
---------------	--------	-----	---------------

V8 (44_, 4C_)

3.6 quattro	Petrol	180	04/93 → 02/94
-------------	--------	-----	---------------

V8 (44_, 4C_)

3.6 quattro	Petrol	184	10/88 → 02/94
-------------	--------	-----	---------------

4.2 quattro	Petrol	206	10/91 → 02/94
-------------	--------	-----	---------------

BMW
5 (E28)

524 td	Diesel	85	01/87 → 12/87
--------	--------	----	---------------

VOLKSWAGEN
POLO (86C, 80)

1.3 Cat.	Petrol	55	10/89 → 08/90
----------	--------	----	---------------

POLO Coupé (86C, 80)

1.3 Cat.	Petrol	55	10/89 → 08/90
----------	--------	----	---------------

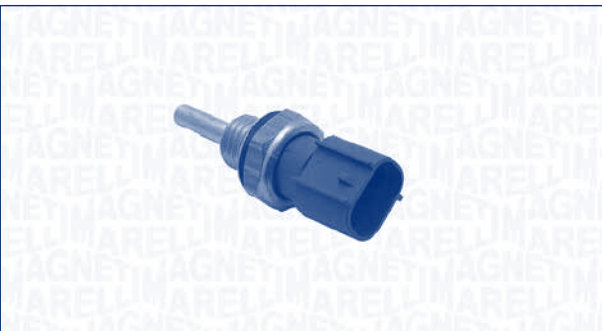
SPA122
F1 **SENSORE TEMPERATURA REFRIGERANTE
COOLANT TEMPERATURE SENSOR**

SUZUKI
SWIFT II 2 volumi /Coda spiovente (EA, MA)

1.3 GTi (SF413, AA34)	Petrol	74	03/89 → 05/01
-----------------------	--------	----	---------------

SPA123

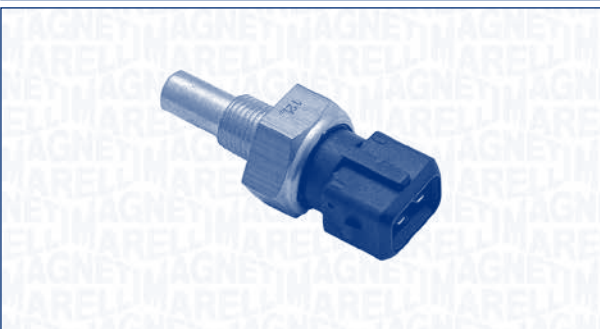
F1 **SENSORE TEMPERATURA REFRIGERANTE**
COOLANT TEMPERATURE SENSOR



KW



OPEL

ASTRA F (56_, 57_)

1.7 TD Diesel 50 11/94 → 09/98

ASTRA F 2 volumi /Coda spiovente (53_, 54_, 58_, 59_)

1.7 TD Diesel 50 11/94 → 01/98

ASTRA F Station wagon (51_, 52_)

1.7 TD Diesel 50 11/94 → 01/98

ASTRA F Van (55_)

1.7 TD Diesel 50 08/94 → 01/99

SPA124

F1 **SENSORE TEMPERATURA REFRIGERANTE**
COOLANT TEMPERATURE SENSOR



KW



SAAB

900 II

2.0 -16 Turbo Petrol 136 09/93 → 08/95

2.0 i Petrol 96 08/94 → 08/95

2.0 i Petrol 98 09/93 → 07/94

2.3 -16 Petrol 110 09/93 → 08/95

900 II Cabriolet

2.0 -16 Turbo Petrol 136 03/94 → 08/95

2.0 i Petrol 96 09/94 → 08/95

2.3 -16 Petrol 110 03/94 → 08/95

SPA124



KW



SAAB

900 II Coupé

2.0 i Petrol 98 12/93 → 07/94

9000

2.0 -16 Turbo CD Petrol 108 09/93 → 12/98

2.3 -16 CD Turbo Petrol 147 09/93 → 12/98

SPA125

F1 **SENSORE TEMPERATURA REFRIGERANTE**
COOLANT TEMPERATURE SENSOR



KW



AUDI

100 (44, 44Q, C3)

2.3 E Petrol 100 10/86 → 11/90

2.3 E quattro Petrol 100 08/86 → 11/90

100 Avant (44, 44Q, C3)

2.3 Petrol 100 08/86 → 11/90

2.3 E quattro Petrol 100 08/86 → 11/90

200 (44, 44Q)

2.3 Petrol 100 11/86 → 12/90

200 Avant (44, 44Q)

2.3 Petrol 100 11/86 → 12/90

80 (8C, B4)

2.3 E Petrol 98 09/91 → 12/94

2.3 E quattro Petrol 98 09/91 → 12/94

80 Avant (8C, B4)

2.3 E Petrol 98 07/92 → 11/94

2.3 E quattro Petrol 98 09/91 → 11/94

90 (89, 89Q, 8A, B3)

2.0 Petrol 85 07/88 → 09/91

2.3 E Petrol 100 04/87 → 07/91

2.3 E Petrol 98 04/87 → 09/91

2.3 E quattro Petrol 100 04/87 → 07/91

2.3 E quattro Petrol 98 04/87 → 09/91

SPA125

KW

AUDI
CABRIOLET (8G7, B4)

2.3 E Petrol 98 05/91 → 07/94

COUPE (89, 8B)

2.3 Petrol 100 10/88 → 07/94

2.3 Petrol 98 03/90 → 07/94

2.3 quattro Petrol 100 11/88 → 12/92

2.3 quattro Petrol 98 05/90 → 07/94

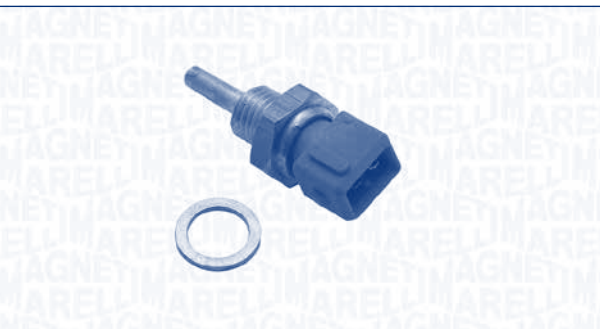
SPA126
F1 **SENSORE TEMPERATURA REFRIGERANTE
COOLANT TEMPERATURE SENSOR**

KW

NISSAN
PRIMERA (P10)

2.0 16V Petrol 85 06/90 → 05/93

2.0 16V 4x4 Petrol 85 04/91 → 05/93

2.0 GT Petrol 110 06/90 → 05/93

PRIMERA Hatchback (P10)

2.0 16V Petrol 85 06/90 → 05/93

2.0 16V 4x4 Petrol 85 04/91 → 05/93

PRIMERA Traveller (W10)

2.0 i Petrol 85 07/90 → 07/94

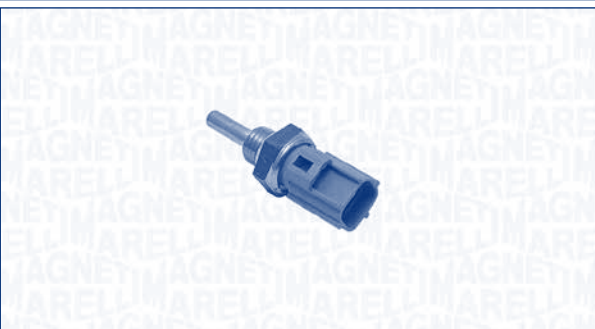
SPA127
F1 **SENSORE TEMPERATURA REFRIGERANTE
COOLANT TEMPERATURE SENSOR**

KW

LEXUS
RX (MHU3_, GSU3_, MCU3_)

400h AWD Petrol 155 09/04 → 12/08

MITSUBISHI
GALANT VI (EA_)

2.4 GDI (EA3A) Petrol 106 09/00 → 10/04

2.4 GDI (EA3A) Petrol 110 02/99 → 09/00

GALANT VI Station wagon (EA_)

2.4 GDI (EA3W) Petrol 106 09/00 → 10/03

2.4 GDI (EA3W) Petrol 110 02/99 → 10/03

TOYOTA
CAMRY (_CV2_, _XV2_)

3.0 V6 Petrol 135 08/96 → 11/01

CAMRY (MCV3_, ACV3_, _XV3_)

3.0 V6 Petrol 137 11/01 → 11/06

SPA128
F1 **SENSORE TEMPERATURA REFRIGERANTE
COOLANT TEMPERATURE SENSOR**

KW

OPEL
ASTRA G 2 volumi /Coda spiovente (F48_, F08_)

1.7 TD Diesel 50 02/98 → 08/00

ASTRA G Furgonato (F70)

1.7 TD Diesel 50 01/99 → 08/00

SPA128



OPEL

ASTRA G Station wagon (F35_)

1.7 TD	Diesel	50	02/98 → 08/00
--------	--------	----	---------------

ASTRA G Tre volumi (F69_)

1.7 TD	Diesel	50	09/98 → 08/00
--------	--------	----	---------------

VAUXHALL

ASTRA Mk IV (G) 2 volumi /Coda spiovente

1.7 TD	Diesel	50	02/98 → 08/00
--------	--------	----	---------------

ASTRA Mk IV (G) Station wagon

1.7 TD	Diesel	50	02/98 → 08/00
--------	--------	----	---------------

ASTRA Mk IV (G) Tre volumi

1.7 TD	Diesel	50	09/98 → 08/00
--------	--------	----	---------------

ASTRAVAN Mk IV (G)

1.7 TD	Diesel	50	08/98 → 08/00
--------	--------	----	---------------

SPA129

F1 **SENSORE TEMPERATURA REFRIGERANTE**
COOLANT TEMPERATURE SENSOR

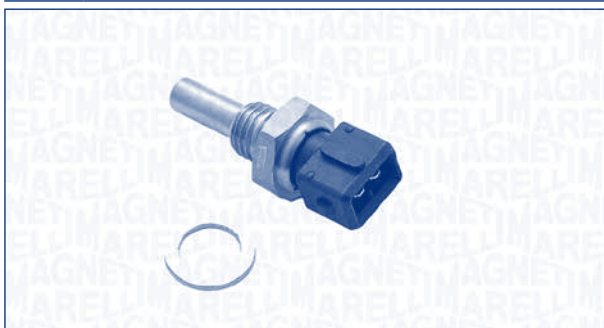

ALFA ROMEO

164 (164)

2.0 V6 Turbo (164.A2G, 164.A2F)	Petrol	150	03/91 → 09/92
---------------------------------------	--------	-----	---------------

2.0 V6 Turbo (164.K3)	Petrol	148	09/92 → 09/98
--------------------------	--------	-----	---------------

75 (162B)

1.8 Turbo (162.B1C, 162.B1D, 162.B1G)	Petrol	110	09/86 → 02/92
--	--------	-----	---------------

1.8 Turbo i.e. (162.B1E)	Petrol	114	02/86 → 01/90
-----------------------------	--------	-----	---------------

SPA129



FERRARI

TESTAROSSA

5.0	Petrol	272	08/86 → 10/91
-----	--------	-----	---------------

5.0	Petrol	287	01/86 → 12/91
-----	--------	-----	---------------

JAGUAR

XJ (XJ 40, 81)

6 2.9	Petrol	108	10/86 → 08/90
-------	--------	-----	---------------

6 2.9	Petrol	117	10/86 → 08/90
-------	--------	-----	---------------

6 2.9	Petrol	123	10/86 → 08/90
-------	--------	-----	---------------

LANCIA

KAPPA (838A)

2.0 20V (838AA1AA)	Petrol	107	10/94 → 10/01
-----------------------	--------	-----	---------------

THEMA (834)

2850 V6 i.e. (834AD, 834CD, 834BD)	Petrol	108	06/88 → 05/92
--	--------	-----	---------------

OPEL

OMEGA A (16_, 17_, 19_)

3.0 (3000)	Petrol	130	03/87 → 12/89
------------	--------	-----	---------------

OMEGA A Station wagon (66_, 67_)

3.0	Petrol	130	03/87 → 12/89
-----	--------	-----	---------------

3.0 Cat.	Petrol	130	01/88 → 03/94
----------	--------	-----	---------------

PEUGEOT

505 (551A)

2.8 GTI V6	Petrol	105	06/86 → 12/93
------------	--------	-----	---------------

PORSCHE

928

4.7 S	Petrol	228	08/83 → 07/86
-------	--------	-----	---------------

5.0 GT	Petrol	243	01/89 → 07/91
--------	--------	-----	---------------

5.0 S,S4	Petrol	235	08/86 → 07/91
----------	--------	-----	---------------

5.0 S4 Cat.	Petrol	235	08/86 → 07/91
-------------	--------	-----	---------------

5.4 GTS	Petrol	257	08/91 → 11/95
---------	--------	-----	---------------

VOLVO

240 (P242, P244)

2.3 i Cat.	Petrol	85	08/88 → 07/92
------------	--------	----	---------------

240 Kombi (P245)

2.3 i Cat.	Petrol	85	08/88 → 07/92
------------	--------	----	---------------

440 K (445)

1.7 Turbo	Petrol	88	08/88 → 07/96
-----------	--------	----	---------------

460 L (464)

1.7	Petrol	75	03/90 → 07/92
-----	--------	----	---------------

1.7 Turbo	Petrol	88	03/90 → 07/96
-----------	--------	----	---------------

480 E

1.7 Turbo	Petrol	88	08/88 → 07/95
-----------	--------	----	---------------

1.7 Turbo	Petrol	90	01/91 → 07/95
-----------	--------	----	---------------

SPA129

KW

VOLVO
940 (944)

2.0	Petrol	82	01/92 → 07/94
2.0 Turbo	Petrol	114	08/90 → 12/94
2.3	Petrol	114	08/90 → 07/91
2.3	Petrol	85	08/92 → 07/94
2.3	Petrol	96	06/91 → 12/94
2.3 Turbo	Petrol	121	08/90 → 07/94

940 II (944)

2.0 Turbo	Petrol	114	04/96 → 07/97
2.3	Petrol	85	08/94 → 07/95
2.3	Petrol	96	08/94 → 07/95
2.3 ti	Petrol	99	01/95 → 07/97
2.3 Turbo	Petrol	121	08/94 → 07/97

940 II Station wagon (945)

2.0 Turbo	Petrol	114	04/96 → 07/97
2.3	Petrol	85	08/94 → 07/95
2.3	Petrol	96	08/94 → 07/95
2.3 ti	Petrol	99	01/95 → 07/97
2.3 Turbo	Petrol	121	08/94 → 07/97

940 Kombi (945)

2.0	Petrol	82	01/92 → 07/94
2.0 Turbo	Petrol	114	09/91 → 07/95
2.3	Petrol	85	08/92 → 07/94
2.3	Petrol	96	06/91 → 12/94
2.3 Turbo	Petrol	121	08/90 → 07/94

960 (964)

2.0	Petrol	103	09/91 → 08/93
2.0	Petrol	140	09/91 → 09/93

960 Kombi (965)

2.0	Petrol	103	09/91 → 08/93
2.0	Petrol	140	09/91 → 09/93

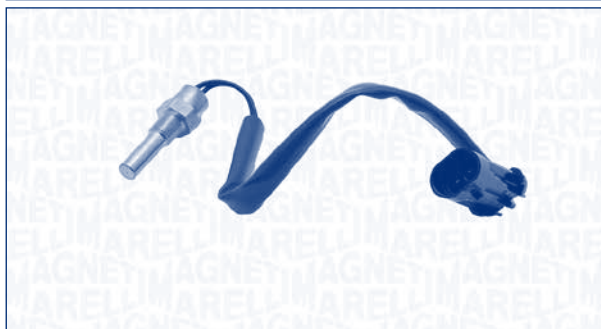
SPA130
F1
**SENSORE TEMPERATURA REFRIGERANTE
COOLANT TEMPERATURE SENSOR**

KW

OPEL
ASTRA F (56_, 57_)

1.7 D	Diesel	42	03/92 → 09/92
1.7 TDS	Diesel	60	03/92 → 09/98

ASTRA F 2 volumi /Coda spiovente (53_, 54_, 58_, 59_)

1.7 D	Diesel	42	12/91 → 09/92
1.7 TDS	Diesel	60	12/91 → 01/98

ASTRA F Station wagon (51_, 52_)

1.7 D	Diesel	42	12/91 → 09/92
1.7 TDS	Diesel	60	12/91 → 01/98

ASTRA F Van (55_)

1.7 D	Diesel	42	12/91 → 09/92
-------	--------	----	---------------

CORSA A 2 volumi /Coda spiovente (93_, 94_, 98_, 99_)

1.5 D	Diesel	37	09/87 → 03/93
-------	--------	----	---------------

CORSA A TR (91_, 92_, 96_, 97_)

1.5 TD	Diesel	49	10/87 → 03/93
--------	--------	----	---------------

VECTRA A (86_, 87_)

1.7 TD	Diesel	60	03/90 → 11/95
--------	--------	----	---------------

VECTRA A 2 volumi /Coda spiovente (88_, 89_)

1.7 TD	Diesel	60	03/90 → 11/95
--------	--------	----	---------------

SPA131

F1 **SENSORE TEMPERATURA REFRIGERANTE**
COOLANT TEMPERATURE SENSOR

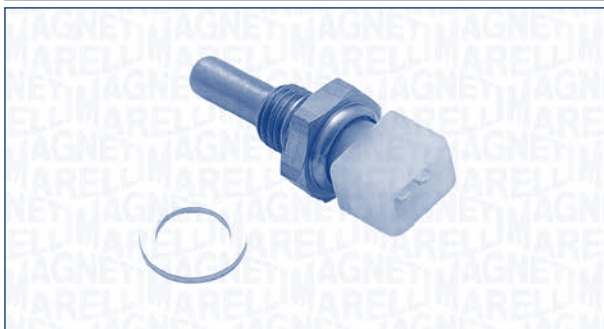

ALFA ROMEO

75 (162B)

1.8 (162.B1L, 162.B1F)	Petrol	88	09/88 → 02/92
------------------------	--------	----	---------------

2.5 V6 (162.B3)	Petrol	115	05/85 → 08/86
-----------------	--------	-----	---------------

2.5 V6 Cat.	Petrol	113	09/86 → 04/89
-------------	--------	-----	---------------

3.0 V6 (162.B6A)	Petrol	136	01/87 → 12/90
------------------	--------	-----	---------------

3.0 V6 (162.B6A) Cat.	Petrol	136	01/87 → 02/92
-----------------------	--------	-----	---------------

90 (162)

2.0 i.e. (162.A2A, 162.A2E)	Petrol	94	10/84 → 07/87
-----------------------------	--------	----	---------------

2.5 i.e. V6	Petrol	114	10/84 → 07/87
-------------	--------	-----	---------------

2.5 i.e. V6 (162.A, 162.AA)	Petrol	110	10/84 → 07/87
-----------------------------	--------	-----	---------------

SPIDER (115)

2000	Petrol	85	08/86 → 12/90
------	--------	----	---------------

2000 Veloce	Petrol	93	01/77 → 12/93
-------------	--------	----	---------------

FORD

MAVERICK (UDS, UNS)

2.7 TD	Diesel	74	02/93 → 08/96
--------	--------	----	---------------

NISSAN

300 ZX (Z31)

3.0	Petrol	125	01/84 → 12/87
-----	--------	-----	---------------

3.0 TURBO	Petrol	149	05/87 → 10/90
-----------	--------	-----	---------------

PATROL GR I (Y60, GR)

2.8 TD (Y60A)	Diesel	85	09/88 → 06/97
---------------	--------	----	---------------

PATROL Station Wagon (W260)

2.8 TD	Diesel	85	06/89 → 11/95
--------	--------	----	---------------

PRIMERA (P10)

2.0 D	Diesel	55	01/91 → 12/92
-------	--------	----	---------------

PRIMERA Hatchback (P10)

2.0 D	Diesel	55	01/91 → 12/92
-------	--------	----	---------------

SPA131



NISSAN

PRIMERA Traveller (W10)

2.0 D	Diesel	55	07/90 → 12/92
-------	--------	----	---------------

SUNNY Furgonato (Y10)

1.7 D	Diesel	40	11/90 → 10/92
-------	--------	----	---------------

SUNNY III (N14)

2.0 D	Diesel	55	10/90 → 10/92
-------	--------	----	---------------

SUNNY III Hatchback (N14)

2.0 D	Diesel	55	10/90 → 10/92
-------	--------	----	---------------

SUNNY III Liftback (N14)

2.0 D	Diesel	55	10/90 → 10/92
-------	--------	----	---------------

SUNNY III Traveller (Y10)

2.0 D	Diesel	55	06/91 → 10/92
-------	--------	----	---------------

TERRANO II (R20)

2.7 TD 4WD	Diesel	74	02/93 → 01/02
------------	--------	----	---------------

URVAN Autobus (E24)

2.5 D	Diesel	59	05/89 → 10/96
-------	--------	----	---------------

URVAN Furgonato (E24)

2.3 D	Diesel	51	01/88 → 05/97
-------	--------	----	---------------

2.5 D	Diesel	59	12/88 → 05/97
-------	--------	----	---------------

RENAULT

25 (B29_)

2.2 (B29B)	Petrol	79	09/86 → 06/88
------------	--------	----	---------------

SPA132

F1 **SENSORE TEMPERATURA REFRIGERANTE**
COOLANT TEMPERATURE SENSOR



BMW

3 (E36)

320 i	Petrol	110	10/92 → 12/95
-------	--------	-----	---------------

3 Cabriolet (E36)

320 i	Petrol	110	12/93 → 12/95
-------	--------	-----	---------------

3 Coupé (E36)

320 i	Petrol	110	09/92 → 12/95
-------	--------	-----	---------------

SPA132

BMW
5 (E34)

520 i 24V	Petrol	110	09/92 → 09/95
-----------	--------	-----	---------------

5 Touring (E34)

520 i	Petrol	110	09/92 → 09/95
-------	--------	-----	---------------

SPA134

FIAT
UNO (146A/E)

70 i.e. 1.4	Petrol	51	09/89 → 12/93
-------------	--------	----	---------------

70 i.e. 1.4	Petrol	53	09/89 → 12/93
-------------	--------	----	---------------

75 i.e. 1.5	Petrol	55	09/89 → 12/93
-------------	--------	----	---------------

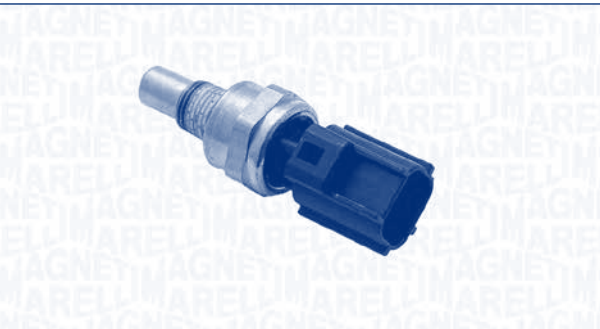
SPA133
F1 **SENSORE TEMPERATURA REFRIGERANTE**
COOLANT TEMPERATURE SENSOR

FORD
FIESTA IV (JA_, JB_)

1.8 Di	Diesel	55	04/00 → 01/02
--------	--------	----	---------------

SPA135
F1 **SENSORE TEMPERATURA REFRIGERANTE**
COOLANT TEMPERATURE SENSOR

VOLVO
S40 I (VS)

1.6	Petrol	80	03/99 → 12/03
-----	--------	----	---------------

1.8	Petrol	85	07/95 → 08/99
-----	--------	----	---------------

1.8	Petrol	90	03/99 → 12/03
-----	--------	----	---------------

1.9 T4	Petrol	147	05/97 → 07/00
--------	--------	-----	---------------

2.0	Petrol	100	07/95 → 12/03
-----	--------	-----	---------------

2.0 T	Petrol	118	10/97 → 12/03
-------	--------	-----	---------------

2.0 T	Petrol	120	06/01 → 12/03
-------	--------	-----	---------------

2.0 T4	Petrol	147	07/00 → 12/03
--------	--------	-----	---------------

V40 Station wagon (VW)

1.6	Petrol	80	03/99 → 06/04
-----	--------	----	---------------

1.8	Petrol	85	07/95 → 08/99
-----	--------	----	---------------

1.8	Petrol	90	03/99 → 06/04
-----	--------	----	---------------

1.9 T4	Petrol	147	05/97 → 07/00
--------	--------	-----	---------------

2.0 T	Petrol	118	10/97 → 07/00
-------	--------	-----	---------------

2.0 T	Petrol	121	07/99 → 06/04
-------	--------	-----	---------------

2.0 T4	Petrol	147	07/00 → 06/04
--------	--------	-----	---------------

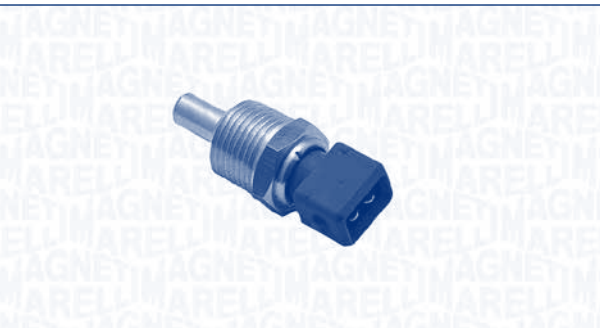
SPA134
F1 **SENSORE TEMPERATURA REFRIGERANTE**
COOLANT TEMPERATURE SENSOR

FIAT
TIPO (160)

1.4 i.e. (160.AP, 160.AD, 160.EA)	Petrol	51	04/93 → 04/95
--------------------------------------	--------	----	---------------

UNO (146A/E)

1.3 Turbo i.e.	Petrol	73	01/87 → 12/87
----------------	--------	----	---------------

45 i.e. 1.0	Petrol	33	04/84 → 10/95
-------------	--------	----	---------------

SPA136

F1 **SENSORE TEMPERATURA REFRIGERANTE**
COOLANT TEMPERATURE SENSOR



MERCEDES-BENZ

190 (W201)

E 1.8 (201.018)	Petrol	80	04/90 → 08/93	
E 2.0	Petrol	87	01/85 → 08/93	ENGINE: 236839 →, 122336 →
E 2.0 (201.024)	Petrol	90	10/82 → 06/93	ENGINE: 236839 →, 122336 →
E 2.3	Petrol	97	09/86 → 08/91	ENGINE: 033730 →, 080065 →
E 2.3 (201.028)	Petrol	100	10/86 → 08/93	ENGINE: 033730 →, 080065 →
E 2.5-16	Petrol	143	03/89 → 08/93	
E Evolution II 2.5	Petrol	173	05/90 → 08/93	

CABRIOLET (A124)

300 CE-24 (124.061)	Petrol	162	04/92 → 06/93	
---------------------	--------	-----	---------------	--

CLASSE C (W202)

C 200 D (202.120)	Diesel	55	03/93 → 05/00	
-------------------	--------	----	---------------	--

CLASSE E (W124)

E 300 4-matic (124.230)	Petrol	132	06/93 → 06/95	ENGINE: 002188 →, 008268 →
E 300 D (124.131)	Diesel	100	07/93 → 06/95	
E 420 (124.034)	Petrol	205	06/93 → 06/95	
E 500 (124.036)	Petrol	235	06/93 → 06/95	

CLASSE E Station wagon (S124)

E 300 T 4-matic (124.290)	Petrol	132	06/93 → 06/96	ENGINE: 002188 →, 008268 →
E 300 TD (124.191)	Diesel	100	06/93 → 06/96	

CLASSE G (W461)

230 GE (461.238, 461.239)	Petrol	90	02/93 →	
---------------------------	--------	----	---------	--

SPA136



MERCEDES-BENZ

CLASSE G (W463)

230 GE (463.224, 463.225)	Petrol	93	06/90 → 06/93	
300 GE (463.227, 463.228)	Petrol	125	06/90 →	
300 GE (463.227, 463.228)	Petrol	128	06/90 →	
G 500 E (463.228)	Petrol	177	09/93 →	ENGINE: 016683 →

CLASSE G Cabrio (W463)

230 GE (463.204)	Petrol	93	06/90 → 02/93	
300 GE (463.207)	Petrol	125	09/89 → 09/97	

CLASSE S (W140)

300 SE,SEL/ S320 (140.032, 140.033)	Petrol	170	03/91 → 10/98	
400 SE,SEL/ S420 (140.042, 140.043)	Petrol	210	02/91 → 10/98	
500 SE,SEL (140.050, 140.051)	Petrol	240	02/91 → 10/98	
600 SE,SEL (140.056, 140.057)	Petrol	300	04/91 → 12/92	
S 420 (140.042)	Petrol	205	01/93 → 10/98	
S 500 (140.050, 140.051)	Petrol	235	01/93 → 10/98	
S 600 (140.056, 140.057)	Petrol	290	01/93 → 10/98	

CLASSE S Coupé (C140)

SEC/CL 420 (140.063)	Petrol	205	10/94 → 02/99	
SEC/CL 500 (140.070)	Petrol	235	10/92 → 02/99	
SEC/CL 600 (140.076)	Petrol	290	09/92 → 02/99	

COUPE (C124)

230 CE (124.043) Cat.	Petrol	97	06/89 → 12/92	ENGINE: 146597 →, 147102 →
300 CE (124.050)	Petrol	132	03/87 → 05/93	ENGINE: 032928 →, 181462 →

KOMBI Station wagon (S124)

200 TE (124.081)	Petrol	87	09/88 → 08/92	ENGINE: 036266 →, 009690 →
------------------	--------	----	---------------	----------------------------

SPA136

KW

MERCEDES-BENZ
KOMBI Station wagon (S124)

230 TE (124.083)	Petrol	100	09/85 → 08/92	ENGINE: 146597 →, 147102 →
230 TE (124.083) Cat.	Petrol	97	06/89 → 08/92	ENGINE: 146597 →, 147102 →
300 TE (124.090)	Petrol	132	01/86 → 08/92	ENGINE: 032928 →, 181462 →
300 TE 4-matic (124.290)	Petrol	132	09/86 → 06/93	ENGINE: 002188 →, 008268 →
300 TE-24 (124.091)	Petrol	162	09/89 → 08/92	

SL (R129)

300 SL (129.060)	Petrol	140	03/89 → 08/93	
300 SL-24 (129.061)	Petrol	170	03/89 → 07/93	
500 (129.067)	Petrol	235	09/92 → 10/01	
500 SL (129.066)	Petrol	240	09/89 → 08/92	
600 (129.076)	Petrol	290	07/92 → 10/01	

Tre volumi (W124)

200 E (124.021)	Petrol	87	09/88 → 08/92	ENGINE: 036266 →, 009690 →
230 E (124.023)	Petrol	100	01/85 → 06/93	ENGINE: 146597 →, 147102 →
230 E (124.023) Cat.	Petrol	97	06/89 → 06/93	ENGINE: 146597 →, 147102 →
260 E (124.026)	Petrol	118	09/85 → 08/92	ENGINE: 027640 →, 070068 →
260 E 4-matic (124.226)	Petrol	118	09/86 → 08/92	ENGINE: 000453 →
300 E	Petrol	138	06/85 → 08/92	ENGINE: 181462 →
300 E (124.030)	Petrol	132	08/85 → 08/92	ENGINE: 181462 →
300 E 4-matic	Petrol	138	09/86 → 02/92	ENGINE: 002188 →, 008268 →
300 E 4-matic (124.230)	Petrol	132	09/86 → 06/93	ENGINE: 002188 →, 008268 →
300 E-24 (124.031)	Petrol	162	09/88 → 08/92	
400 E 4.2 (124.034)	Petrol	205	10/92 → 06/93	
500 E (124.036)	Petrol	240	01/91 → 06/93	

SPA137
F1
**SENSORE TEMPERATURA REFRIGERANTE
COOLANT TEMPERATURE SENSOR**

KW

CHRYSLER
LE BARON

2.2 i	Petrol	69	09/86 → 12/94
2.5 i	Petrol	75	09/86 → 12/94

LE BARON Cabriolet

2.5 i	Petrol	75	09/86 → 12/93
-------	--------	----	---------------

SARATOGA

2.5	Petrol	72	10/89 → 09/91
-----	--------	----	---------------

INFINITI
J30

3.0	Petrol	157	01/92 → 12/97
-----	--------	-----	---------------

Q45 I

4.5	Petrol	205	01/89 → 12/93
-----	--------	-----	---------------

KIA
CARNIVAL I (UP)

2.9 TD	Diesel	93	08/99 → 10/01
--------	--------	----	---------------

CLARUS Station wagon (GC)

1.8 i 16V	Petrol	85	05/98 →
2.0 i 16V	Petrol	98	05/98 →

PRIDE (DA)

1.1 i	Petrol	38	01/91 →
1.3 i	Petrol	51	01/90 →

RETONA (CE)

2.0 16V	Petrol	94	05/00 →
2.0 TD	Diesel	61	06/99 → 12/02

SHUMA (FB)

1.5 i 16V	Petrol	65	10/97 → 03/01
1.8 i 16V	Petrol	81	10/97 → 03/01

SHUMA II (FB)

1.8	Petrol	84	04/03 → 08/04
-----	--------	----	---------------

SHUMA Tre volumi (FB)

1.5	Petrol	59	03/96 → 12/98
1.5 i 16V	Petrol	65	10/97 → 10/01

SPA137



KW



KIA

SPORTAGE (K00)

2.0	Petrol	87	10/00 → 08/03
2.0 4WD	Petrol	87	10/00 → 08/03
2.0 i 16V	Petrol	94	10/99 → 08/03
2.0 i 16V 4WD	Petrol	94	04/94 → 08/03
2.0 i 4WD	Petrol	70	04/94 → 08/99
2.0 TD 4WD	Diesel	61	10/97 → 08/03

NISSAN

100 NX (B13)

1.6	Petrol	66	03/90 → 10/94
1.6 SR	Petrol	75	09/93 → 10/94
2.0 GTI	Petrol	105	03/91 → 10/94

200 SX (S13)

1.8 Turbo	Petrol	124	07/88 → 11/93
2.0 i 16V Turbo	Petrol	147	10/93 → 07/96

300 ZX (Z32)

3.0 Twin Turbo	Petrol	197	05/90 → 09/95
3.0 Twin Turbo	Petrol	208	05/90 → 09/95

BLUEBIRD (T72 , T12)

1.8 i 16V (RLT72)	Petrol	95	02/89 → 12/90
2.0 i (HLT72, T12)	Petrol	77	01/88 → 12/90

BLUEBIRD (U11)

1.8 Turbo	Petrol	99	01/88 → 05/90
-----------	--------	----	---------------

BLUEBIRD Hatchback (T72, T12)

1.8 i 16V (FRLT72)	Petrol	95	02/89 → 12/90
1.8 Turbo	Petrol	99	01/88 → 11/92
2.0 i (FHLT72, T12)	Petrol	77	01/88 → 12/90

BLUEBIRD Station Wagon (WU11)

2.0 i	Petrol	77	01/88 → 12/90
-------	--------	----	---------------

MAXIMA II (J30)

3.0 i	Petrol	125	10/88 → 06/94
-------	--------	-----	---------------

PATROL GR I (Y60, GR)

4.2 Cat.	Petrol	121	11/88 → 02/98
----------	--------	-----	---------------

PICK UP (D21)

2.4 i 12V	Petrol	91	04/92 → 02/98
2.4 i 12V 4WD	Petrol	93	04/92 → 02/98
2.4 i 4WD	Petrol	74	03/86 → 04/92
3.0 i V6 4WD	Petrol	109	09/90 → 02/98

PICK UP (D22)

2.4 i	Petrol	88	02/98 →
2.4 i 4WD	Petrol	88	02/98 →

SPA137



KW



NISSAN

PRAIRIE PRO (M11)

2.4 i	Petrol	98	04/92 → 07/94
2.4 i 4x4	Petrol	98	04/92 → 07/94

PRIMERA (P10)

1.6	Petrol	66	06/90 → 05/93
-----	--------	----	---------------

PRIMERA Hatchback (P10)

1.6	Petrol	66	06/90 → 05/93
-----	--------	----	---------------

PRIMERA Traveller (W10)

1.6 i	Petrol	66	07/90 → 05/93
-------	--------	----	---------------

SUNNY Furgonato (Y10)

1.6 i 16V	Petrol	66	10/92 → 03/00
-----------	--------	----	---------------

SUNNY II Hatchback (N13)

1.8 GTI 16V	Petrol	92	01/89 → 06/91
-------------	--------	----	---------------

SUNNY III (N14)

1.4 i	Petrol	55	10/90 → 05/95
1.6 i	Petrol	66	10/90 → 05/95
1.6 i 16V 4WD	Petrol	66	10/90 → 05/95

SUNNY III Hatchback (N14)

1.4 i	Petrol	55	10/90 → 05/95
1.4 i 16V	Petrol	64	10/90 → 05/95
1.6 i	Petrol	66	10/90 → 05/95
1.6 i 16V 4x4	Petrol	75	10/92 → 05/95
2.0 GTI 16V	Petrol	105	10/90 → 05/95
2.0 GTI-R 4x4	Petrol	162	10/90 → 05/95

SUNNY III Liftback (N14)

1.4 i	Petrol	55	10/90 → 05/95
1.6 i	Petrol	66	10/90 → 05/95
2.0 i 16V	Petrol	105	10/90 → 05/95

SUNNY III Traveller (Y10)

1.6 16V 4x4	Petrol	66	11/90 → 05/95
1.6 i	Petrol	66	06/91 → 03/00
1.6 i 16V 4x4	Petrol	75	10/92 → 03/00

TERRANO I (WD21)

2.4 i 4WD	Petrol	76	10/87 → 02/93
-----------	--------	----	---------------

TERRANO II (R20)

2.4 i 12V 4WD	Petrol	91	02/93 → 06/96
---------------	--------	----	---------------

URVAN Autobus (E24)

2.4 i	Petrol	74	05/89 → 09/93
-------	--------	----	---------------

VANETTE Autobus (C22)

2.4 i (SLC22)	Petrol	74	10/86 → 12/95
2.4 i (SLC22)	Petrol	77	10/86 → 12/95

SPA138
F1 **SENSORE TEMPERATURA REFRIGERANTE**
COOLANT TEMPERATURE SENSOR

HYUNDAI
ACCENT II (LC)

1.3	Petrol	55	01/00 → 11/05
1.3	Petrol	62	08/02 → 11/05
1.3	Petrol	63	01/00 → 11/05
1.5	Petrol	66	01/00 → 11/05
1.5	Petrol	75	09/00 → 11/05
1.5 CRDi	Diesel	60	04/02 → 11/05
1.6	Petrol	77	12/02 → 11/05

ACCENT Tre volumi (LC)

1.3	Petrol	55	01/00 → 11/05
1.3	Petrol	63	01/00 → 11/05
1.5 CRDi	Diesel	60	01/02 → 11/05
1.6	Petrol	77	12/02 → 11/05

COUPE (GK)

2.0	Petrol	102	03/02 → 08/09
2.7 V6	Petrol	123	03/02 → 08/09

GETZ (TB)

1.3 i	Petrol	60	09/02 → 03/04
-------	--------	----	---------------

MATRIX (FC)

1.6	Petrol	76	06/01 → 08/10
1.8	Petrol	90	06/01 → 08/10

XG (XG)

250	Petrol	120	12/98 → 12/05
-----	--------	-----	---------------

KIA
MAGENTIS (GD)

2.0	Petrol	100	05/01 →
2.5 V6	Petrol	124	05/01 →

SPA139
F1 **SENSORE TEMPERATURA REFRIGERANTE**
COOLANT TEMPERATURE SENSOR

VOLVO
C70 I Cabriolet

2.0 T	Petrol	120	03/00 → 10/05
2.0 T	Petrol	166	03/98 → 10/05
2.3 T5	Petrol	176	03/98 → 10/05
2.5 T	Petrol	142	03/98 → 10/05

C70 I Coupé

2.0 T	Petrol	120	03/00 → 09/02
2.0 T	Petrol	166	03/97 → 09/02
2.3 T-5	Petrol	176	03/97 → 09/02
2.5	Petrol	121	03/99 → 09/02
2.5	Petrol	125	05/99 → 09/02
2.5 T	Petrol	142	03/97 → 09/02

S60 I

2.0 T	Petrol	132	07/00 → 04/10
2.4	Petrol	103	11/00 → 04/10
2.4	Petrol	125	11/00 → 04/10
2.4 Bifuel (CNG)	Petrol/ CNG	103	06/02 → 04/10
2.4 T	Petrol	147	11/00 → 04/10
2.4 T AWD	Petrol	147	11/01 → 04/10
T5	Petrol	184	11/00 → 04/10

S70 (LS)

2.0	Petrol	120	01/97 → 11/00
2.4	Petrol	103	08/99 → 11/00
2.4 AWD	Petrol	103	04/99 → 09/00
2.4 AWD	Petrol	106	11/96 → 05/99
2.4 AWD	Petrol	125	04/99 → 09/00
2.4 T5 AWD	Petrol	142	11/96 → 04/99
2.5 Bifuel	Petrol/ CNG	106	10/98 → 11/00
2.5 Bifuel	Petrol/ CNG	103	07/99 → 11/00

SPA139



VOLVO

S80 I (TS, XY)

2.0	Petrol	120	06/98 → 07/06
2.0 T	Petrol	132	12/99 → 07/06
2.0 T	Petrol	166	06/98 → 07/06
2.4	Petrol	103	01/99 → 07/06
2.4	Petrol	125	01/99 → 07/06
2.4 Bifuel (CNG)	Petrol/ CNG	103	09/01 → 07/06
2.4 T	Petrol	147	06/00 → 07/06
2.4 T5 AWD	Petrol	147	04/00 → 09/03

V40 Station wagon (VW)

2.0 T	Petrol	120	06/01 → 06/04
-------	--------	-----	---------------

V70 I (LV)

2.0	Petrol	120	01/97 → 03/00
2.3 T-5 AWD	Petrol	176	01/97 → 03/00
2.4	Petrol	103	08/99 → 05/00
2.4 Bifuel	BiFuel	103	08/99 → 03/00
2.5 AWD	Petrol	195	03/99 → 03/00
2.5 Bifuel	BiFuel	106	10/98 → 08/99

V70 II (SW)

2.0 T	Petrol	132	07/01 → 08/07
2.3 T5	Petrol	184	03/00 → 08/07
2.4	Petrol	103	03/00 → 08/07
2.4	Petrol	125	03/00 → 08/07
2.4 Bifuel (CNG)	Petrol/ CNG	103	09/01 → 08/07
2.4 T	Petrol	147	03/00 → 08/07
2.4 T AWD	Petrol	147	09/01 → 08/07

XC70 CROSS COUNTRY

2.4 T XC AWD	Petrol	147	03/00 → 09/02
--------------	--------	-----	---------------

SPA140

F1

**SENSORE TEMPERATURA REFRIGERANTE
COOLANT TEMPERATURE SENSOR**



SEAT

CORDOBA (6K1, 6K2)

1.9 D	Diesel	50	02/93 → 08/96
1.9 TD	Diesel	55	02/93 → 08/96
1.9 TDI	Diesel	81	03/97 → 06/99

CORDOBA Vario (6K5)

1.9 TDI	Diesel	66	08/96 → 06/99
1.9 TDI	Diesel	81	07/97 → 06/99

IBIZA II (6K1)

1.9 D	Diesel	50	10/94 → 08/96
1.9 TD	Diesel	55	03/93 → 08/96

TOLEDO I (1L)

1.9 D	Diesel	50	05/91 → 03/99
1.9 TD	Diesel	55	05/91 → 03/99

SKODA

FELICIA I Fun (797)

1.9 D	Diesel	47	06/97 → 04/02
-------	--------	----	---------------

VOLKSWAGEN

GOLF III (1H1)

1.9 D	Diesel	48	11/91 → 08/97
-------	--------	----	---------------

GOLF III Variant (1H5)

1.9 D	Diesel	48	07/93 → 04/99
-------	--------	----	---------------

VENTO (1H2)

1.9 D	Diesel	48	11/91 → 09/98
-------	--------	----	---------------

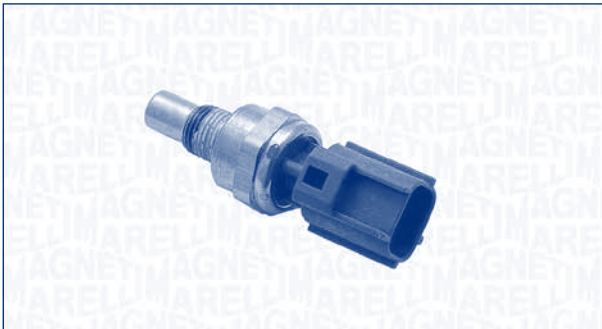
SPA141
F1 **SENSORE TEMPERATURA REFRIGERANTE**
COOLANT TEMPERATURE SENSOR

FORD
COUGAR (EC_)

2.0 16V	Petrol	96	08/98 → 12/01
2.5 V6 24V	Petrol	125	08/98 → 12/01

MONDEO II (BAP)

1.6 i 16V	Petrol	70	05/98 → 11/00
2.5 24V	Petrol	125	06/00 → 11/00
2.5 ST 200	Petrol	151	05/99 → 11/00

MONDEO II Station wagon (BNP)

1.6 i 16V	Petrol	70	05/98 → 11/00
2.5 24V	Petrol	125	10/99 → 11/00
2.5 ST 200	Petrol	151	05/99 → 11/00

MONDEO II Tre volumi (BFP)

1.6 i 16V	Petrol	70	05/98 → 11/00
2.5 24V	Petrol	125	06/00 → 11/00
2.5 ST 200	Petrol	151	05/99 → 11/00

TRANSIT Autobus (E_ _)

2.0 (EBL, EBS, ECL, EDS, EDL, EGL, ESS, ESL, EUS)	Petrol	84	09/95 → 03/00
2.0 CNG	Petrol/ CNG	84	06/94 → 03/00
2.5 DI (EBL, ECL, EDS, EDL)	Diesel	56	07/94 → 03/00
2.5 DI (EBL, EDL, EDS, ESL, ESS)	Diesel	85	08/97 → 03/00
2.5 DI (EBL, EDS, ESL, ESS, EUS)	Diesel	51	08/94 → 03/00
2.5 TD (EB_ , ED_ , ES_)	Diesel	55	08/94 → 06/00

SPA141

FORD
TRANSIT Autobus (E_ _)

2.5 TD (EBL, EDL, EDS, EGL, ESL, ESS, EUS)	Diesel	63	01/95 → 03/00
2.5 TD (ECL, EDL, EDS, ESL, ESS, EUS)	Diesel	74	07/94 → 03/00

TRANSIT Autobus (FD_ , FB_ , FS_ , FZ_ , FC_)

2.3 16V [RWD] (F_B_ , F_C_ , F_A_)	Petrol	107	08/00 → 05/06
-------------------------------------	--------	-----	---------------

TRANSIT Furgonato (E_ _)

2.0 (EAL, EAS)	Petrol	84	06/94 → 03/00
2.5 DI (EAL, EAS)	Diesel	51	06/94 → 03/00
2.5 DI (EAL, EAS)	Diesel	56	06/94 → 03/00
2.5 DI (EAL, EAS)	Diesel	85	05/99 → 03/00
2.5 TD (EAL, EAS)	Diesel	63	06/94 → 03/00
2.5 TD (EAS)	Diesel	55	10/98 → 03/00
2.5 TDI (EAL, EAS)	Diesel	74	06/94 → 03/00

TRANSIT Furgonato (FA_ _)

2.3 16V [RWD] (FAA_ , FAB_ , FAC_)	Petrol	107	04/01 → 05/06
-------------------------------------	--------	-----	---------------

TRANSIT Pianale piatto/Telaio (E_ _)

2.0 (EME/L/S, ENE/L/S)	Petrol	84	08/94 → 03/00
2.5 DI (EME/L/S, ENE/L/S)	Diesel	56	08/94 → 03/00
2.5 DI (EML, ENE/L)	Diesel	85	05/99 → 03/00
2.5 DI (EML/S, ENL/S)	Diesel	51	08/94 → 03/00
2.5 TD (EME/L/S, ENE/L/S)	Diesel	55	10/98 → 07/00
2.5 TD (EME/L/S, ENE/L/S)	Diesel	63	08/94 → 03/00
2.5 TD (EME/L/S, ENE/L/S)	Diesel	74	08/94 → 03/00

SPA141



FORD

TRANSIT Pianale piatto/Telaio (FM_ , FN_)

2.3 16V (F_A_, F_B_, F_C_, F_D_)	Petrol	107	04/01 → 05/06
----------------------------------	--------	-----	---------------

SPA142

F1 **SENSORE TEMPERATURA REFRIGERANTE**
COOLANT TEMPERATURE SENSOR



DAIHATSU

APPLAUSE I (A101, A111)

1.6 16V (A101)	Petrol	77	04/94 → 07/97
1.6 16V 4WD (A111)	Petrol	77	04/94 → 07/97

CHARADE IV (G200, G202)

1.3 i 16V	Petrol	62	01/93 → 03/96
1.6 GTI	Petrol	77	03/93 → 11/99

CUORE IV (L501)

0.8	Petrol	32	01/95 → 11/96
-----	--------	----	---------------

FEROZA Hard Top (F300)

1.6 i 16V 4x4	Petrol	70	09/93 → 10/99
---------------	--------	----	---------------

FEROZA Soft Top (F300)

1.6 i 16V	Petrol	70	09/93 → 10/99
-----------	--------	----	---------------

GRAN MOVE (G3)

1.6 16V (G301)	Petrol	67	05/98 →
----------------	--------	----	---------

HIJET Autobus (S85)

1.0 i	Petrol	35	07/94 → 05/98
-------	--------	----	---------------

HIJET Furgonato (S85)

1.0 i	Petrol	35	07/94 → 05/98
-------	--------	----	---------------

HYUNDAI

SONATA IV (EF)

2.0 16V	Petrol	100	06/98 → 10/01
2.4 16V	Petrol	105	03/98 → 10/01

SPA142



MITSUBISHI

3000 GT (Z16A)

3.0 i 24V 4WD (Z16A)	Petrol	210	06/94 → 08/99
----------------------	--------	-----	---------------

CARISMA (DA_)

1.6 (DA1A)	Petrol	66	07/95 → 07/98
1.6 (DA1A)	Petrol	73	05/97 → 07/98
1.8 (DA2A)	Petrol	85	07/95 → 06/06
1.8 16V (DA2A)	Petrol	103	07/95 → 06/06
1.8 16V GDI (DA2A)	Petrol	92	09/97 → 06/06

CARISMA Tre volumi (DA_)

1.6 (DA1A)	Petrol	73	05/97 → 07/98
1.8 16V GDI (DA2A)	Petrol	92	09/97 → 06/06

COLT IV (CA_A)

1.6 GLXi 16V (CA4A)	Petrol	83	04/92 → 04/96
1.8 GTi 16V (CA5A)	Petrol	103	04/92 → 04/96

GALANT V (E5_A, E7_A, E8_A)

1.8 GLSI (E52A)	Petrol	93	11/92 → 08/96
2.0 GLSI (E55A)	Petrol	101	11/92 → 08/96
2.0 GLSI 4WD (E75A)	Petrol	101	11/92 → 08/96
2.0 V6-24 (E64A, E54A)	Petrol	110	11/92 → 08/96
2.5 V6-24 4WD (E88A)	Petrol	125	11/92 → 08/96

GALANT V Tre volumi (E5_A, E7_A, E8_A)

1.8 GLSI (E52A)	Petrol	93	11/92 → 08/96
2.0 GLSI (E55A)	Petrol	101	11/92 → 08/96
2.0 GLSI 4WD (E75A)	Petrol	101	11/92 → 08/96
2.0 V6-24 (E64A, E54A)	Petrol	110	11/92 → 08/96
2.5 V6-24 4WD (E88A)	Petrol	125	11/92 → 08/96

LANCER IV (C6_A, C7_A)

1.6 16V (C76A, C66A)	Petrol	83	06/92 → 05/94
1.8 GTi 16V (C69A)	Petrol	103	06/92 → 12/93

SPA142

KW

MITSUBISHI
LANCER V Station Wagon (CB_W, CD_W)

1.6 16V (CB4W) Petrol 83 12/92 → 10/03

1.6 16V 4WD (CD4W) Petrol 83 12/92 → 10/03

PAJERO PININ (H6_W, H7_W)

2.0 GDI (H67W, H77W) Petrol 95 10/00 → 06/07

SPACE RUNNER (N1_W, N2_W)

1.8 (N11W) Petrol 85 06/96 → 08/99

1.8 (N11W) Petrol 90 09/94 → 08/99

1.8 4WD (N21W) Petrol 85 06/96 → 08/99

1.8 4WD (N21W) Petrol 90 09/94 → 08/99

2.0 16V Petrol 98 06/97 → 08/99

SPACE RUNNER (N6_W)

2.0 Petrol 100 08/99 → 08/02

2.4 GDI Petrol 110 08/99 → 08/02

SPACE STAR (DG_A)

1.3 16V (DG1A) Petrol 60 09/00 → 12/04

1.3 16V (DG1A) Petrol 61 12/98 → 12/04

1.3 16V (DG1A) Petrol 63 06/98 → 12/04

1.6 16V (DG3A) Petrol 72 01/01 → 12/04

1.8 GDI (DG5A) Petrol 87 06/98 → 12/04

1.8 GDI (DG5A) Petrol 90 06/98 → 12/04

1.8 MPI Petrol 82 10/02 → 12/04

SPACE WAGON (N3_W, N4_W)

1.8 (N31W) Petrol 90 09/94 → 10/98

1.8 4WD (N41W) Petrol 90 09/94 → 10/98

2.0 (N33W) Petrol 98 10/92 → 10/98

2.0 4WD (N43W) Petrol 98 10/92 → 10/98

2.4 i (N34W) Petrol 102 10/92 → 10/98

SPACE WAGON (N9_W, N8_W)

2.0 GDI Petrol 98 10/98 → 12/04

2.4 GDI Petrol 108 09/00 → 12/04

2.4 GDI Petrol 110 10/98 → 12/04

2.4 GDI 4WD Petrol 108 09/00 → 12/04

2.4 GDI 4WD Petrol 110 10/98 → 12/04

VOLVO
S40 I (VS)

1.8 i Petrol 90 06/01 → 12/03

1.8 i Petrol 92 03/98 → 12/03

V40 Station wagon (VW)

1.8 i Petrol 90 06/01 → 06/04

1.8 i Petrol 92 03/98 → 06/04

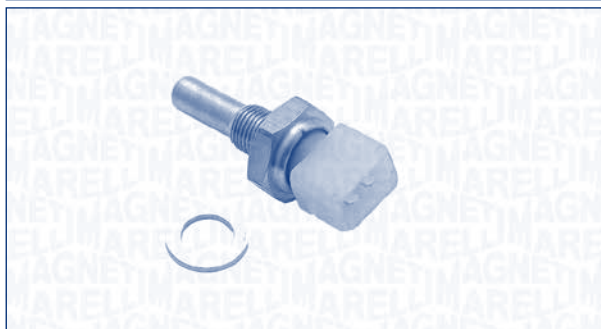
SPA143
F1
**SENSORE TEMPERATURA REFRIGERANTE
COOLANT TEMPERATURE SENSOR**

KW

AUDI
100 (44, 44Q, C3)

1.8 Cat. Petrol 66 03/85 → 11/90

1.8 quattro Cat. Petrol 66 07/88 → 11/90

100 (4A, C4)

2.6 Petrol 102 07/93 → 06/94

2.6 Petrol 110 03/92 → 06/94

2.6 quattro Petrol 110 04/92 → 06/94

2.8 E Petrol 128 12/90 → 06/94

2.8 E quattro Petrol 128 12/90 → 06/94

100 Avant (44, 44Q, C3)

1.8 Cat. Petrol 66 03/85 → 11/90

100 Avant (4A, C4)

2.6 Petrol 102 07/93 → 06/94

2.6 Petrol 110 03/92 → 06/94

2.6 quattro Petrol 110 07/92 → 06/94

2.8 E Petrol 128 09/91 → 06/94

2.8 E quattro Petrol 128 09/91 → 06/94

80 (89, 89Q, 8A, B3)

1.6 Petrol 51 08/87 → 09/91

1.6 Petrol 75 08/90 → 10/91

1.8 Petrol 83 09/87 → 07/88

1.8 E Petrol 82 09/86 → 08/91

1.8 quattro Petrol 83 09/86 → 07/88

1.8 S Petrol 65 09/86 → 01/90

1.8 S quattro Petrol 66 09/86 → 07/90

2.0 Petrol 82 10/90 → 08/91

2.0 E Petrol 83 08/88 → 10/90

2.0 E 16V Petrol 101 03/90 → 09/91

2.0 E 16V quattro Petrol 101 03/90 → 08/91

2.0 E quattro Petrol 83 08/88 → 09/90

2.0 quattro Petrol 85 10/90 → 08/91

80 (8C, B4)

2.0 E 16V Petrol 103 08/92 → 12/94

2.0 E 16V quattro Petrol 103 08/92 → 12/94

SPA143



AUDI

80 (8C, B4)

2.6	Petrol	110	07/92 → 12/94
2.6 quattro	Petrol	110	06/92 → 12/94
2.8	Petrol	128	09/91 → 12/94
2.8 quattro	Petrol	128	09/91 → 12/94

80 Avant (8C, B4)

2.0 E 16V	Petrol	103	02/93 → 07/95
2.6	Petrol	110	07/92 → 05/95
2.6 quattro	Petrol	110	07/92 → 07/95
2.8	Petrol	128	08/92 → 05/95
2.8 quattro	Petrol	128	08/92 → 07/95

CABRIOLET (8G7, B4)

2.6	Petrol	102	05/95 → 12/99
2.6	Petrol	110	01/94 → 08/00
2.8	Petrol	128	11/92 → 08/00

COUPE (89, 8B)

2.0	Petrol	82	03/90 → 07/90
2.0	Petrol	83	05/89 → 03/90
2.0	Petrol	85	08/90 → 07/91
2.0 16 V	Petrol	101	01/92 → 07/92
2.0 16 V	Petrol	103	08/92 → 12/95
2.6	Petrol	110	08/92 → 12/95
2.6 quattro	Petrol	110	08/92 → 12/95
2.8	Petrol	128	09/91 → 12/95
2.8 quattro	Petrol	128	08/91 → 12/95

VOLKSWAGEN

GOLF II (19E, 1G1)

1.6	Petrol	51	10/86 → 07/92
-----	--------	----	---------------

GOLF III (1H1)

1.8 Syncro (1HX1)	Petrol	66	01/93 → 09/94
-------------------	--------	----	---------------

PASSAT (3A2, 35I)

1.6	Petrol	53	08/88 → 07/90
1.8	Petrol	66	04/88 → 09/94
2.0 16V	Petrol	100	08/88 → 09/93

PASSAT Variant (3A5, 35I)

1.6	Petrol	53	08/88 → 07/90
1.8	Petrol	55	08/90 → 03/97
1.8	Petrol	66	04/88 → 09/94
2.0 16V	Petrol	100	08/88 → 09/93

VENTO (1H2)

1.8	Petrol	55	11/91 → 12/97
1.8	Petrol	66	11/91 → 09/94

SPA144

F1 **SENSORE TEMPERATURA REFRIGERANTE**
COOLANT TEMPERATURE SENSOR

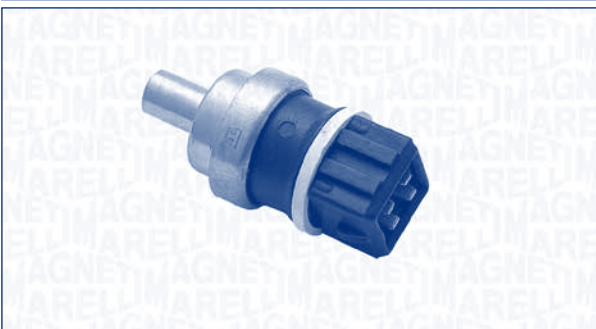

AUDI

A4 (8D2, B5)

2.6	Petrol	110	01/95 → 11/00	CHASSIS: →8DT300000
2.6 quattro	Petrol	110	01/95 → 11/00	CHASSIS: →8DT400000
2.8	Petrol	128	09/95 → 07/97	CHASSIS: →8DT300000
2.8 quattro	Petrol	128	01/95 → 07/97	CHASSIS: →8DT400000

A4 Avant (8D5, B5)

2.6	Petrol	110	02/96 → 09/01	CHASSIS: →8DT300000
2.6 quattro	Petrol	110	01/96 → 09/01	CHASSIS: →8DT400000
2.8	Petrol	128	03/96 → 09/96	CHASSIS: →8DT300000
2.8 quattro	Petrol	128	01/96 → 09/96	CHASSIS: →8DT400000

A6 (4A, C4)

1.8	Petrol	92	12/95 → 10/97	
2.6	Petrol	102	06/94 → 10/97	CHASSIS: →4AT150000
2.6	Petrol	110	06/94 → 10/97	CHASSIS: →4AT150000
2.8	Petrol	128	06/94 → 10/97	CHASSIS: →4AT150000
2.8	Petrol	142	12/95 → 10/97	

A6 Avant (4A, C4)

1.8	Petrol	92	12/95 → 12/97	
2.6	Petrol	102	06/94 → 02/97	CHASSIS: →4AT150000
2.6	Petrol	110	06/94 → 12/97	CHASSIS: →4AT150000

SPA144

AUDI
A6 Avant (4A, C4)

2.8	Petrol	128	06/94 → 12/97	CHASSIS: →4AT150000
2.8	Petrol	142	12/95 → 12/97	

CABRIOLET (8G7, B4)

2.6	Petrol	102	05/95 → 08/00	CHASSIS: →8GT015000
2.6	Petrol	110	06/93 → 08/00	CHASSIS: →8GT015000

COUPE (89, 8B)

2.6	Petrol	110	08/92 → 12/96	
2.8	Petrol	128	09/91 → 12/96	

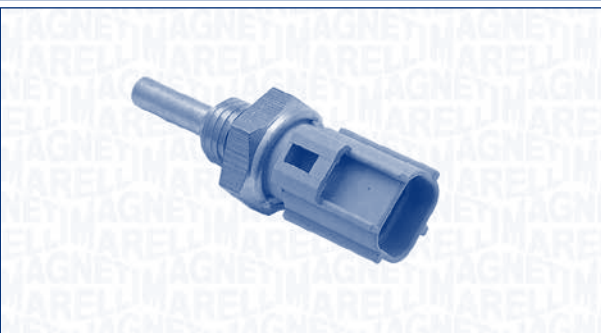
SPA145
F1 **SENSORE TEMPERATURA REFRIGERANTE
COOLANT TEMPERATURE SENSOR**

SUZUKI
IGNIS II

1.5 4x4	Petrol	73	09/03 →	
---------	--------	----	---------	--

JIMNY (FJ)

1.3 16V	Petrol	60	02/01 →	
1.3 16V 4WD	Petrol	60	02/01 →	
1.3 16V 4x4	Petrol	63	08/05 →	

LIANA (ER)

1.3	Petrol	66	03/02 →	
1.6	Petrol	76	03/02 →	
1.6 4WD	Petrol	76	03/02 →	
1.6 4WD	Petrol	78	04/02 →	
1.6 i	Petrol	78	04/02 →	

LIANA Station wagon (ER)

1.3	Petrol	66	07/01 → 12/07	
1.6	Petrol	76	07/01 → 12/07	
1.6 4WD	Petrol	76	07/01 → 12/07	
1.6 4WD	Petrol	78	04/02 → 12/07	

SPA145

SUZUKI
LIANA Station wagon (ER)

1.6 i	Petrol	78	04/02 → 12/07	
-------	--------	----	---------------	--

SWIFT III (MZ, EZ)

1.3	Petrol	68	02/05 →	
1.3 4x4	Petrol	66	01/06 →	
1.3 DDiS	Diesel	51	08/05 →	
1.3 DDiS	Diesel	55	08/05 →	
1.6	Petrol	92	05/06 →	

WAGON R+ (MM)

1.3	Petrol	69	09/03 →	
1.3 DDiS	Diesel	51	09/03 →	

SPA146
F1 **SENSORE TEMPERATURA REFRIGERANTE
COOLANT TEMPERATURE SENSOR**

ALFA ROMEO
MITO (955)

1.3 JTDM	Diesel	70	10/09 →	
----------	--------	----	---------	--

CHEVROLET
AVEO 2 volumi /Coda spiovente (T300)

1.3 D	Diesel	55	07/11 →	
1.3 D	Diesel	70	07/11 →	

AVEO Tre volumi (T300)

1.3 D	Diesel	55	07/11 →	
1.3 D	Diesel	70	07/11 →	

CITROËN
NEMO Furgonato (AA_)

1.3 HDi 75	Diesel	55	10/10 →	
------------	--------	----	---------	--

FIAT
500 (312)

1.3 D Multijet	Diesel	70	12/09 →	
----------------	--------	----	---------	--

500 C (312)

1.3 D Multijet	Diesel	70	09/09 →	
----------------	--------	----	---------	--

SPA146



FIAT

DOBLO Cassone / Furgonato / Promiscuo (263)

1.3 D Multijet Diesel 66 02/10 →

DOBLO Combi (152, 263)

1.3 D Multijet Diesel 66 02/10 →

DOBLO Pianale piatto/Telaio (263)

1.3 D Multijet Diesel 66 02/10 →

FIORINO Cassone / Furgonato / Promiscuo (225)

1.3 D Multijet Diesel 70 07/09 →

PUNTO EVO (199)

1.3 D Multijet Diesel 55 10/09 → 02/12

1.3 D Multijet Diesel 66 10/09 → 02/12

1.3 D Multijet Diesel 62 10/09 → 02/12

1.3 D Multijet Diesel 70 10/09 → 02/12

PUNTO EVO Furgonato (199)

1.3 D Multijet Diesel 55 03/09 →

PUNTO Van (199)

1.3 D Multijet Diesel 70 03/09 →

QUBO (225)

1.3 D Multijet Diesel 70 07/10 →

LANCIA

MUSA (350)

1.3 D Multijet Diesel 70 03/09 →

YPSILON (846)

1.3 Multijet Diesel 70 05/11 →

OPEL

ASTRA J

1.3 CDTI Diesel 70 12/09 →

ASTRA J Sports Tourer

1.3 CDTI Diesel 70 10/10 →

COMBO Cassone / Furgonato / Promiscuo (X12)

1.3 CDTI Diesel 66 02/12 →

CORSA D

1.3 CDTI Diesel 70 06/10 →

1.3 CDTI Diesel 55 07/06 →

CORSA D Van

1.3 CDTI Diesel 70 06/10 →

1.3 CDTI Diesel 55 07/06 →

MERIVA B

1.3 CDTI Diesel 70 06/10 →

SPA147

F1

**SENSORE TEMPERATURA REFRIGERANTE
COOLANT TEMPERATURE SENSOR**



RENAULT

CLIO III (BR0/1, CR0/1)

1.2 16V (BR02, BR0J, BR11, CR02, CR0J, CR11) Petrol 55 06/05 →

1.2 16V (BR0P, CR0P) Petrol 74 05/07 →

1.2 16V (BR0R, BR1D, BR1L, CR0R) Petrol 48 06/05 →

GRAND SCÉNIC II (JM0/1_)

2.0 Petrol 120 11/07 →

2.0 Petrol 99 11/07 →

LAGUNA III (BT0/1)

2.0 GT Petrol 150 03/08 →

MEGANE II (BM0/1_, CM0/1_)

1.4 16V (BM0B, CM0B) Petrol 72 11/07 →

2.0 16V (BM0U, CM0U) Petrol 99 11/07 →

2.0 16V Turbo Petrol 120 11/07 →

2.0 Renault Sport Petrol 165 11/07 →

MEGANE II Coupé-Cabriolet (EM0/1_)

2.0 Petrol 99 11/07 →

2.0 16V Turbo Petrol 120 11/07 →

MEGANE II Station wagon (KM0/1_)

1.4 Petrol 72 11/07 →

2.0 Petrol 99 11/07 →

MEGANE II Tre volumi (LM0/1_)

1.4 Petrol 72 11/07 →

2.0 Petrol 99 11/07 →

SPA147

KW

RENAULT
SCÉNIC II (JM0/1_)

2.0 (JM05, JM0U, JM1N, JM1U, JM2V)	Petrol	99	11/07 →
------------------------------------	--------	----	---------

2.0 16V Turbo (JM0W)	Petrol	120	11/07 →
----------------------	--------	-----	---------

TWINGO II (CN0_)

1.2 (CN0D)	Petrol	43	03/07 →
------------	--------	----	---------

1.2 16V (CN0K, CN0V)	Petrol	56	03/07 →
----------------------	--------	----	---------

1.2 Turbo (CN0C, CN0F)	Petrol	74	03/07 →
------------------------	--------	----	---------

SPA148
F1 **SENSORE TEMPERATURA REFRIGERANTE
COOLANT TEMPERATURE SENSOR**

KW

FORD
MONDEO III (B5Y)

2.0 16V DI / TDDi / TDCi	Diesel	66	11/00 → 08/07
--------------------------	--------	----	---------------

2.0 16V TDDi / TDCi	Diesel	85	11/00 → 08/07
---------------------	--------	----	---------------

2.0 TDCi	Diesel	96	10/01 → 08/07
----------	--------	----	---------------

2.2 TDCi	Diesel	114	09/04 → 08/07
----------	--------	-----	---------------

MONDEO III Station wagon (BWY)

2.0 16V DI / TDDi / TDCi	Diesel	66	11/00 → 08/07
--------------------------	--------	----	---------------

2.0 16V TDDi / TDCi	Diesel	85	11/00 → 08/07
---------------------	--------	----	---------------

2.0 TDCi	Diesel	96	10/01 → 08/07
----------	--------	----	---------------

2.2 TDCi	Diesel	114	09/04 → 08/07
----------	--------	-----	---------------

MONDEO III Tre volumi (B4Y)

2.0 16V DI / TDDi / TDCi	Diesel	66	11/00 → 08/07
--------------------------	--------	----	---------------

SPA148

KW

FORD
MONDEO III Tre volumi (B4Y)

2.0 16V TDDi / TDCi	Diesel	85	11/00 → 08/07
---------------------	--------	----	---------------

2.0 TDCi	Diesel	96	10/01 → 08/07
----------	--------	----	---------------

2.2 TDCi	Diesel	114	09/04 → 08/07
----------	--------	-----	---------------

TRANSIT Autobus

2.2 TDCi	Diesel	103	10/07 →
----------	--------	-----	---------

TRANSIT Autobus (FD_-, FB_-, FS_-, FZ_-, FC_)

2.0 DI (F_E-, F_F-, F_G-)	Diesel	55	08/00 → 05/06
---------------------------	--------	----	---------------

2.0 DI (F_E-, F_F-, F_G-)	Diesel	63	08/00 → 05/06
---------------------------	--------	----	---------------

2.0 DI (F_E-, F_F-, F_G-)	Diesel	74	08/00 → 05/06
---------------------------	--------	----	---------------

2.0 TDCi (F_F-, F_E-, F_G-)	Diesel	92	08/02 → 05/06
-----------------------------	--------	----	---------------

TRANSIT Furgonato

2.2 TDCi	Diesel	103	10/07 →
----------	--------	-----	---------

TRANSIT Furgonato (FA_)

2.0 DI (FAE-, FAF-, FAG-)	Diesel	55	08/00 → 05/06
---------------------------	--------	----	---------------

2.0 DI (FAE-, FAF-, FAG-)	Diesel	63	08/00 → 05/06
---------------------------	--------	----	---------------

2.0 DI (FAE-, FAF-, FAG-)	Diesel	74	08/00 → 05/06
---------------------------	--------	----	---------------

2.0 TDCi	Diesel	92	08/02 → 05/06
----------	--------	----	---------------

TRANSIT Pianale piatto/Telaio

2.2 TDCi	Diesel	103	10/07 →
----------	--------	-----	---------

TRANSIT Pianale piatto/Telaio (FM_-, FN_)

2.0 DI (F_E-, F_F-)	Diesel	55	08/00 → 05/06
---------------------	--------	----	---------------

2.0 DI (F_E-, F_F-)	Diesel	63	08/00 → 05/06
---------------------	--------	----	---------------

2.0 DI (F_E-, F_F-)	Diesel	74	08/00 → 05/06
---------------------	--------	----	---------------

2.0 TDCi (F_E-, F_F-)	Diesel	92	08/02 → 05/06
-----------------------	--------	----	---------------

TRANSIT TOURNEO

2.2 TDCi	Diesel	103	10/07 →
----------	--------	-----	---------

2.2 TDCi	Diesel	85	10/08 →
----------	--------	----	---------

JAGUAR
X-TYPE (CF1)

2.0 D	Diesel	96	07/03 → 11/09
-------	--------	----	---------------

2.2 D	Diesel	114	10/05 → 11/09
-------	--------	-----	---------------

SPA148



JAGUAR

X-TYPE Estate

2.0 D	Diesel	96	02/04 → 12/09
2.2 D	Diesel	114	10/05 → 12/09

SPA150

F1 **SENSORE TEMPERATURA REFRIGERANTE**
COOLANT TEMPERATURE SENSOR

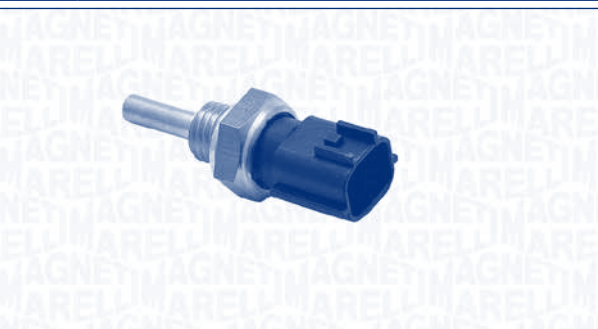

NISSAN

MICRA II (K11)

1.0 i 16V	Petrol	40	08/92 → 12/95
1.3 i 16V	Petrol	55	08/92 → 12/95

PRIMERA (P10)

1.6	Petrol	66	06/90 → 09/94
1.6	Petrol	71	06/90 → 09/94
2.0 D	Diesel	55	01/93 → 01/96
2.0 GT	Petrol	110	06/93 → 09/94

PRIMERA Hatchback (P10)

1.6	Petrol	66	05/93 → 09/94
1.6	Petrol	71	06/90 → 06/93
1.6	Petrol	75	06/93 → 09/94
2.0	Petrol	110	06/93 → 09/94
2.0 D	Diesel	55	01/93 → 01/96

PRIMERA Traveller (W10)

2.0 D	Diesel	55	01/93 → 12/95
-------	--------	----	---------------

SERENA (C23M)

1.6 16V	Petrol	71	02/93 → 09/94
2.0 16V	Petrol	93	11/92 → 09/01
2.0 D	Diesel	49	11/92 → 09/01

VANETTE CARGO Autobus (HC 23)

1.6 i	Petrol	72	01/96 →
-------	--------	----	---------

VANETTE CARGO Furgonato (HC 23)

1.6 i	Petrol	71	01/95 →
-------	--------	----	---------

SPA151

F1 **SENSORE TEMPERATURA REFRIGERANTE**
COOLANT TEMPERATURE SENSOR



FORD

FIESTA III (GFJ)

1.4 Cat.	Petrol	54	01/94 → 12/95
1.6 i 16V	Petrol	65	01/94 → 12/95
1.8 16V	Petrol	77	02/92 → 12/95
1.8 D	Diesel	44	03/89 → 12/95
1.8 TD	Diesel	55	03/93 → 12/95

GALAXY (WGR)

2.0 i	Petrol	85	11/95 → 05/06
-------	--------	----	---------------

KA (RB_)

1.0 i	Petrol	38	07/97 → 09/99
-------	--------	----	---------------

MONDEO I (GBP)

1.6 i 16V	Petrol	65	07/94 → 08/96
1.6 i 16V	Petrol	66	02/93 → 08/96
1.8 i 16V	Petrol	82	07/94 → 08/96
1.8 i 16V	Petrol	85	02/93 → 08/96
1.8 i 16V 4x4	Petrol	85	02/93 → 08/96
1.8 TD	Diesel	65	06/93 → 08/96
1.8 TD	Diesel	66	10/95 → 08/96
2.0 i 16V	Petrol	100	02/93 → 08/96
2.0 i 16V	Petrol	97	12/94 → 08/96
2.0 i 16V 4x4	Petrol	97	12/94 → 08/96
2.5 i 24V	Petrol	125	07/94 → 08/96

MONDEO I Station wagon (BNP)

1.6 i 16V	Petrol	65	07/94 → 08/96
1.6 i 16V	Petrol	66	04/93 → 08/96
1.8 i 16V	Petrol	82	07/94 → 08/96
1.8 i 16V	Petrol	85	04/93 → 08/96
1.8 i 16V 4x4	Petrol	85	04/93 → 08/96
1.8 TD	Diesel	65	06/93 → 08/96
1.8 TD	Diesel	66	11/95 → 08/96
2.0 i 16V	Petrol	100	04/93 → 08/96
2.0 i 16V	Petrol	97	01/93 → 08/96
2.0 i 16V 4x4	Petrol	100	04/93 → 08/96
2.0 i 16V 4x4	Petrol	97	12/94 → 08/96

SPA151

FORD
MONDEO I Station wagon (BNP)

2.5 i 24V	Petrol	125	07/94 → 08/96
-----------	--------	-----	---------------

MONDEO I Tre volumi (GBP)

1.6 i 16V	Petrol	65	07/94 → 08/96
-----------	--------	----	---------------

1.6 i 16V	Petrol	66	02/93 → 08/96
-----------	--------	----	---------------

1.8 i 16V	Petrol	82	01/94 → 08/96
-----------	--------	----	---------------

1.8 i 16V	Petrol	85	02/93 → 08/96
-----------	--------	----	---------------

1.8 TD	Diesel	65	06/93 → 08/96
--------	--------	----	---------------

1.8 TD	Diesel	66	10/95 → 08/96
--------	--------	----	---------------

2.0 i 16V	Petrol	100	02/93 → 08/96
-----------	--------	-----	---------------

2.0 i 16V 4x4	Petrol	97	12/94 → 08/96
---------------	--------	----	---------------

2.5 i 24V	Petrol	125	07/94 → 08/96
-----------	--------	-----	---------------

ORION III (GAL)

1.3	Petrol	44	07/90 → 12/93
-----	--------	----	---------------

1.4	Petrol	52	07/90 → 12/93
-----	--------	----	---------------

1.6 i	Petrol	77	07/90 → 09/92
-------	--------	----	---------------

1.6 i 16V	Petrol	66	07/92 → 12/93
-----------	--------	----	---------------

1.8 D	Diesel	44	11/90 → 12/93
-------	--------	----	---------------

SCORPIO I Station wagon (GGE)

2.0 i	Petrol	85	09/91 → 09/94
-------	--------	----	---------------

2.0 i	Petrol	88	09/91 → 09/94
-------	--------	----	---------------

2.4 i	Petrol	92	09/91 → 09/94
-------	--------	----	---------------

2.9 24V	Petrol	143	08/93 → 09/94
---------	--------	-----	---------------

2.9 i	Petrol	107	09/91 → 09/94
-------	--------	-----	---------------

2.9 i 4x4	Petrol	107	05/88 → 02/93
-----------	--------	-----	---------------

SCORPIO I Tre volumi (GGE)

2.0 i	Petrol	85	02/92 → 09/94
-------	--------	----	---------------

2.0 i	Petrol	88	05/89 → 09/94
-------	--------	----	---------------

2.0 i	Petrol	92	05/89 → 02/92
-------	--------	----	---------------

2.4 i	Petrol	92	10/88 → 10/94
-------	--------	----	---------------

2.9 i 24V	Petrol	143	04/91 → 09/94
-----------	--------	-----	---------------

2.9 i 4x4	Petrol	107	12/89 → 10/94
-----------	--------	-----	---------------

SIERRA (GBG, GB4)

2.0 4x4	Petrol	92	01/90 → 02/93
---------	--------	----	---------------

2.0 i	Petrol	92	01/90 → 02/93
-------	--------	----	---------------

2.8 i	Petrol	105	08/87 → 02/93
-------	--------	-----	---------------

2.9 4x4	Petrol	107	08/88 → 02/93
---------	--------	-----	---------------

2.9 4x4	Petrol	110	08/88 → 02/93
---------	--------	-----	---------------

2.9 i	Petrol	110	08/88 → 02/93
-------	--------	-----	---------------

SIERRA 2 volumi /Coda spiovente (GBC, GBG)

2.0 16V Cosworth 4x4	Petrol	162	01/90 → 02/93
----------------------	--------	-----	---------------

2.0 i	Petrol	74	01/87 → 02/93
-------	--------	----	---------------

2.0 i	Petrol	80	06/89 → 02/93
-------	--------	----	---------------

2.0 i	Petrol	92	06/89 → 02/93
-------	--------	----	---------------

SPA151

FORD
SIERRA 2 volumi /Coda spiovente (GBC, GBG)

2.8 i	Petrol	105	01/87 → 02/93
-------	--------	-----	---------------

2.8 i XR 4x4	Petrol	107	01/87 → 02/93
--------------	--------	-----	---------------

SIERRA Station wagon (BNG)

2.0 4x4	Petrol	88	02/90 → 02/93
---------	--------	----	---------------

2.0 4x4	Petrol	92	05/89 → 02/93
---------	--------	----	---------------

2.0 i	Petrol	74	01/87 → 02/93
-------	--------	----	---------------

2.0 i	Petrol	85	01/87 → 02/93
-------	--------	----	---------------

2.0 i	Petrol	88	05/89 → 02/93
-------	--------	----	---------------

2.0 i	Petrol	92	05/89 → 02/93
-------	--------	----	---------------

2.0 i Cat.	Petrol	74	01/87 → 02/93
------------	--------	----	---------------

2.8 i	Petrol	105	01/87 → 02/93
-------	--------	-----	---------------

2.8 i	Petrol	107	01/87 → 02/93
-------	--------	-----	---------------

2.8 i 4x4	Petrol	107	01/87 → 02/93
-----------	--------	-----	---------------

2.9	Petrol	107	08/88 → 02/93
-----	--------	-----	---------------

2.9 4x4	Petrol	107	08/88 → 02/93
---------	--------	-----	---------------

2.9 4x4	Petrol	110	08/88 → 02/93
---------	--------	-----	---------------

2.9 i	Petrol	110	08/88 → 02/93
-------	--------	-----	---------------

TRANSIT Autobus (T_ _)

2.0 (TBS, TCL, TCS) Cat.	Petrol	57	12/85 → 09/92
--------------------------	--------	----	---------------

2.0 (TBS, TCL, TCS, TEL, TES)	Petrol	57	11/85 → 09/92
-------------------------------	--------	----	---------------

TRANSIT Pianale piatto/Telaio (T_ _)

2.0 (TTE, TTL, TTS)	Petrol	57	01/86 → 09/92
---------------------	--------	----	---------------

2.0 (TUL) Cat.	Petrol	57	11/85 → 09/92
----------------	--------	----	---------------

SPA152
F1 **SENSORE TEMPERATURA REFRIGERANTE**
COOLANT TEMPERATURE SENSOR

HONDA
ACCORD VIII (CU)

2.0 i	Petrol	115	07/08 →
-------	--------	-----	---------

SPA152



HONDA

ACCORD VIII (CU)

2.2 i-DTEC	Diesel	110	07/08 →
2.4 i	Petrol	148	07/08 →

ACCORD VIII Station wagon

2.0 i	Petrol	115	07/08 →
2.2 i-DTEC	Diesel	110	07/08 →
2.4 i	Petrol	148	07/08 →

CIVIC VIII Hatchback (FN, FK)

1.4	Petrol	61	01/06 →
1.4	Petrol	73	10/08 →
1.8	Petrol	103	01/06 →
2.2 CTDi	Diesel	103	01/06 →
Type R	Petrol	148	09/06 →

CIVIC VIII Tre volumi (FD, FA)

1.3 Hybrid	Hybrid	70	01/06 →
------------	--------	----	---------

CR-V III (RE)

2.0 i 4WD	Petrol	110	01/07 →
2.2 i-CTDi 4WD	Diesel	103	01/07 →

FR-V (BE)

1.8	Petrol	103	01/07 →
-----	--------	-----	---------

INSIGHT (ZE_)

1.3 Hybrid	Hybrid	65	04/09 →
------------	--------	----	---------

LEGEND IV (KB_)

3.7 VTEC V6 4WD	Petrol	217	07/08 →
-----------------	--------	-----	---------

SPA153

F1 **SENSORE TEMPERATURA REFRIGERANTE**
COOLANT TEMPERATURE SENSOR



FORD

FIESTA V (JH_, JD_)

1.3	Petrol	51	11/01 → 06/08
-----	--------	----	---------------

KA (RB_)

1.3 i	Petrol	51	08/02 → 11/08
-------	--------	----	---------------

SPA153



FORD

STREET KA (RL2)

1.6	Petrol	70	05/03 → 07/05
-----	--------	----	---------------

SPA154

F1 **SENSORE TEMPERATURA REFRIGERANTE**
COOLANT TEMPERATURE SENSOR

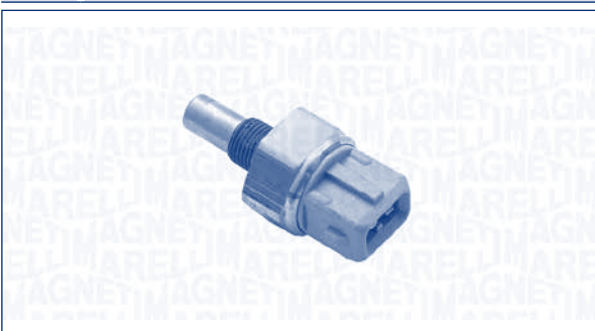

FORD

FIESTA IV (JA_, JB_)

1.25 i 16V	Petrol	55	08/95 → 01/02
1.3 i	Petrol	37	08/95 → 01/02
1.3 i	Petrol	44	08/95 → 01/02
1.8 D	Diesel	44	08/95 → 04/00

SPA155

F1 **SENSORE TEMPERATURA REFRIGERANTE**
COOLANT TEMPERATURE SENSOR



HONDA

ACCORD V (CC7, CD)

2.0 i	Petrol	85	03/93 → 01/96
2.0 i S	Petrol	96	03/93 → 01/96
2.3 i SR	Petrol	116	03/93 → 01/96

SPA155

KW

HONDA
ACCORD V (CE, CF)

1.9 i (CE7)	Petrol	85	02/96 → 10/98
2.0 i LS (CE8)	Petrol	96	02/96 → 10/98
2.2 i VTEC (CE9)	Petrol	110	02/96 → 10/98

ACCORD VI Coupé (CG)

3.0 V6 24V	Petrol	147	02/98 → 06/03
------------	--------	-----	---------------

CIVIC II Shuttle (EE)

1.6 i 16V 4WD (EE4)	Petrol	81	01/90 → 02/95
---------------------	--------	----	---------------

CIVIC V Coupé (EJ)

1.6 i (EJ6)	Petrol	77	01/94 → 11/95
1.6 i Vtec	Petrol	118	01/94 → 11/95
1.6 i Vtec (EJ1)	Petrol	92	01/94 → 03/96

CIVIC VI Aerodeck (MB, MC)

1.4 16V (MB8)	Petrol	55	04/98 → 02/01
1.4 16V (MB8)	Petrol	66	04/98 → 02/01
1.5 16V (MB9)	Petrol	84	04/98 → 02/01
1.6 16V (MC1)	Petrol	85	04/98 → 02/01
1.8 16V (MC2)	Petrol	124	04/98 → 02/01

CIVIC VI Coupé (EJ, EM1)

1.6 i	Petrol	77	03/96 → 03/00
1.6 i Vtec	Petrol	92	03/96 → 03/00
1.6 i Vtec	Petrol	118	04/99 → 12/00

CIVIC VI Fastback (MA, MB)

1.4 i (MA8, MB2)	Petrol	55	09/95 → 02/01
1.4 i (MA8, MB2)	Petrol	66	09/94 → 02/01
1.5 i Vtec-E (MA9)	Petrol	66	09/94 → 01/97
1.6 i (MB1)	Petrol	83	09/94 → 01/97
1.6 i Vtec (MB1)	Petrol	93	09/94 → 01/97
1.6 VTi	Petrol	118	01/97 → 02/01

CIVIC VI Hatchback (EJ, EK)

1.4 i (EJ9)	Petrol	55	11/95 → 02/01
1.4 i S (EJ9)	Petrol	66	11/95 → 02/01
1.5 i (EK3)	Petrol	84	11/95 → 02/01
1.6 i (EK1)	Petrol	84	11/95 → 02/01
1.6 VTi (EK4)	Petrol	118	11/95 → 02/01
1.4 i (EJ9)	Petrol	66	11/95 → 02/01
1.5 i (EK3)	Petrol	84	11/95 → 02/01
1.6 i Vtec	Petrol	92	11/95 → 02/01
1.6 VTi (EK4)	Petrol	118	11/95 → 02/01

CR-V I (RD)

2.0 16V (RD1, RD3)	Petrol	108	01/99 → 02/02
2.0 16V (RD1, RD3)	Petrol	94	10/95 → 01/99

SPA155

KW

HONDA
CRX III (EH, EG)

1.6 ESi (EH6)	Petrol	92	03/92 → 12/98
1.6 i VTi (EG2)	Petrol	118	03/92 → 12/98

HR-V (GH)

1.6 16V	Petrol	77	03/99 →
1.6 16V 4WD	Petrol	77	03/99 →
1.6 16V 4WD	Petrol	91	10/99 →

INTEGRA Coupé (DC2, DC4)

1.8 Type-R	Petrol	140	11/97 → 10/01
------------	--------	-----	---------------

LEGEND II (KA7)

3.2 i 24V	Petrol	151	01/91 → 02/96
-----------	--------	-----	---------------

LEGEND II Coupé (KA8)

3.2 i 24V	Petrol	151	01/91 → 02/96
-----------	--------	-----	---------------

NSX Cabriolet (NA)

3.0 24V Vtec	Petrol	201	03/95 → 09/05
3.0 24V Vtec Automatic	Petrol	188	03/95 → 09/05

NSX Coupé (NA)

3.0 24V Vtec (NA1)	Petrol	201	06/90 → 09/05
3.0 24V Vtec Automatic (NA1)	Petrol	188	06/90 → 09/05

S2000 (AP)

2.0	Petrol	177	06/99 →
-----	--------	-----	---------

SHUTTLE (RA)

2.2 16V	Petrol	110	10/94 → 02/98
2.3 16V	Petrol	110	10/97 → 06/04

ROVER
400 2 volumi /Coda spiovente (RT)

416 Si	Petrol	83	06/95 → 03/00
--------	--------	----	---------------

600 (RH)

620 i	Petrol	85	08/93 → 06/96
620 Si	Petrol	96	08/93 → 02/99
623 Si	Petrol	116	08/93 → 02/99

SPA156

F1 **SENSORE TEMPERATURA REFRIGERANTE**
COOLANT TEMPERATURE SENSOR

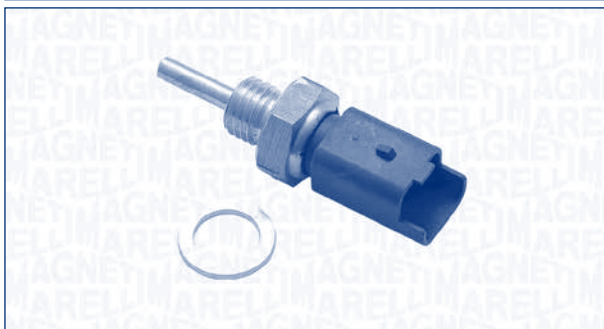

ALFA ROMEO

MITO (955)

1.4 TB Petrol 114 09/08 →

FIAT

500 (312)

1.2 Petrol 51 10/07 →

1.4 Abarth Petrol 99 08/08 →

BRAVO II (198)

1.4 T-Jet Petrol 110 09/07 →

1.4 T-Jet Petrol 88 09/07 →

DOBLO (119)

1.4 Petrol 57 10/05 →

DOBLO Cargo (223)

1.4 Petrol 57 10/05 →

IDEA

1.4 Petrol 57 10/05 →

1.4 16V Petrol 70 03/04 →

LINEA (323)

1.4 Petrol 57 06/07 →

1.4 T-Jet Petrol 88 09/07 →

PUNTO (188)

1.4 Petrol 70 03/04 →

PUNTO / GRANDE PUNTO (199)

1.2 Petrol 48 10/05 →

1.4 Petrol 57 10/05 →

1.4 16V Petrol 70 10/05 →

1.4 Abarth Petrol 114 12/07 →

1.4 T-Jet Petrol 88 09/07 →

STILO (192)

1.4 16V Petrol 66 03/05 → 11/06

1.4 16V Petrol 70 03/04 → 11/06

STILO Multi Wagon (192)

1.4 16V Petrol 66 03/05 → 08/08

1.4 16V Petrol 70 03/04 → 08/08

SPA156



LANCIA

DELTA III (844)

1.4 Petrol 110 09/08 →

1.4 Petrol 88 09/08 →

MUSA (350)

1.4 Petrol 57 09/05 →

1.4 Petrol 70 10/04 →

YPSILON (843)

1.4 Petrol 57 02/06 → 12/11

1.4 16V Petrol 70 03/04 → 12/11

SPA157

F1 **SENSORE TEMPERATURA REFRIGERANTE**
COOLANT TEMPERATURE SENSOR

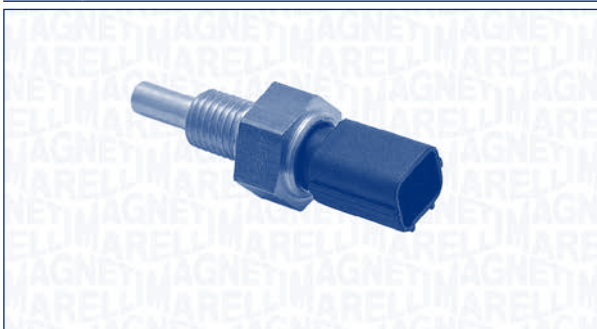

HONDA

ACCORD VII (CL)

2.0 (CL7) Petrol 114 02/03 →

2.0 Trazione integrale (CL8) Petrol 114 02/03 →

2.4 (CL9) Petrol 140 02/03 →

ACCORD VII Tourer (CM)

2.0 (CM1) Petrol 114 04/03 →

2.4 (CM2) Petrol 140 04/03 →

CIVIC VII Coupé (EM2)

1.7 i Petrol 88 05/01 → 12/05

1.7 i VTEC Petrol 92 05/01 → 12/05

CIVIC VII Hatchback (EU, EP, EV)

1.4 iS (EP1) Petrol 66 02/01 → 09/05

1.6 i Petrol 81 02/01 → 09/05

2.0 i Sport Petrol 118 09/01 → 09/05

2.0 Type-R Petrol 147 09/01 → 09/05

CIVIC VII Tre volumi (ES)

1.3 IMA Petrol 61 01/04 → 09/05

CR-V II (RD_)

2.0 Petrol 110 07/02 → 09/06

SPA157

KW

HONDA
FR-V (BE)

2.0 Petrol 110 02/05 →

JAZZ II (GD)

1.4 Petrol 61 03/02 → 07/08

STREAM (RN)

1.7 16V Petrol 92 05/01 →

2.0 16V Petrol 115 05/01 →

SPA158
F1 **SENSORE TEMPERATURA REFRIGERANTE
COOLANT TEMPERATURE SENSOR**

KW

FORD
C-MAX (DM2)

1.8 TDCi Diesel 85 02/07 →

COURIER Furgonato (J5_, J3_)

1.8 Di Diesel 55 09/00 →

FOCUS (DAW, DBW)

1.8 DI / TDDi Diesel 55 08/99 → 11/04

1.8 TDCi Diesel 74 08/02 → 11/04

1.8 TDCi Diesel 85 03/01 → 11/04

1.8 Turbo DI / TDDi Diesel 66 10/98 → 11/04

FOCUS C-MAX

1.8 TDCi Diesel 85 01/05 → 03/07

FOCUS II (DA_)

1.8 TDCi Diesel 85 01/05 →

FOCUS II Station wagon (DA_)

1.8 TDCi Diesel 85 11/04 →

1.8 TDCi Diesel 85 04/05 →

FOCUS Station wagon (DNW)

1.8 DI / TDDi Diesel 55 08/99 → 11/04

1.8 TDCi Diesel 74 08/02 → 11/04

1.8 TDCi Diesel 85 03/01 → 11/04

1.8 Turbo DI / TDDi Diesel 66 02/99 → 11/04

SPA158

KW

FORD
FOCUS Tre volumi (DFW)

1.8 TDCi Diesel 74 08/02 → 11/04

1.8 TDCi Diesel 85 03/01 → 11/04

1.8 Turbo DI / TDDi Diesel 66 02/99 → 11/04

GALAXY (WA6)

1.8 TDCi Diesel 74 05/06 →

1.8 TDCi Diesel 92 05/06 →

MONDEO IV (BA7)

1.8 TDCi Diesel 74 03/07 →

MONDEO IV Turnier (BA7)

1.8 TDCi Diesel 74 03/07 →

S-MAX (WA6)

1.8 TDCi Diesel 92 05/06 →

TOURNEO CONNECT

1.8 Di Diesel 55 06/02 →

1.8 TDCi Diesel 81 08/06 →

1.8 Turbo Di Diesel 66 06/02 →

TRANSIT CONNECT (P65_, P70_, P80_)

1.8 Di Diesel 55 06/02 →

1.8 TDCi Diesel 66 06/02 →

1.8 TDCi Diesel 81 08/06 →

SPA159
F1 **SENSORE TEMPERATURA REFRIGERANTE
COOLANT TEMPERATURE SENSOR**

KW

AUDI
A8 (4D2, 4D8)

 2.8 Petrol 120 07/95 → 03/96 CHASSIS:
4DT000001 →

 2.8 Petrol 128 03/94 → 03/96 CHASSIS:
4DT000001 →

 2.8 Petrol 142 04/96 → 09/02 CHASSIS:
4DT000001 →

SPA158



AUDI

A8 (4D2, 4D8)

2.8 quattro	Petrol	120	07/95 → 03/96	CHASSIS: 4DT000001 →
2.8 quattro	Petrol	128	03/94 → 03/96	CHASSIS: 4DT000001 →
2.8 quattro	Petrol	142	04/96 → 09/02	CHASSIS: 4DT000001 →

SEAT

CORDOBA (6K2)

1.4	Petrol	44	06/99 → 10/02	
1.6	Petrol	74	06/99 → 10/02	CHASSIS: →6KX448600
1.9 SDI	Diesel	50	06/99 → 10/02	CHASSIS: →6KX448600
1.9 TDI	Diesel	66	06/99 → 10/02	CHASSIS: →6KX448600
1.9 TDI	Diesel	81	06/99 → 10/02	CHASSIS: →6KX448600

CORDOBA Vario (6K5)

1.4	Petrol	44	06/99 → 12/02	
1.6	Petrol	74	06/99 → 12/02	CHASSIS: →6KX448600
1.9 SDI	Diesel	50	06/99 → 12/02	CHASSIS: →6KX448600
1.9 TDI	Diesel	66	06/99 → 12/02	CHASSIS: →6KX448600
1.9 TDI	Diesel	81	06/99 → 12/02	CHASSIS: →6KX448600

IBIZA III (6K1)

1.6	Petrol	74	08/99 → 02/02	CHASSIS: →6KX448600
1.9 SDI	Diesel	50	08/99 → 02/02	CHASSIS: →6KX448600
1.9 TDI	Diesel	66	08/99 → 02/02	CHASSIS: →6KX448600
1.9 TDI	Diesel	81	08/99 → 02/02	CHASSIS: →6KX448600

VOLKSWAGEN

POLO (6N1)

120 1.6 16V GTI	Petrol	88	09/98 → 10/99	
-----------------	--------	----	---------------	--

SPA160

F1

**SENSORE TEMPERATURA REFRIGERANTE
COOLANT TEMPERATURE SENSOR**



OPEL

MOVANO Combi (J9)

2.5 D	Diesel	59	07/98 → 09/00	
2.8 dTI	Diesel	84	06/99 → 10/01	ENGINE: 2762408 →

MOVANO Furgonato (F9)

2.5 D	Diesel	59	01/99 → 09/00	
2.8 dTI	Diesel	84	06/99 → 10/01	ENGINE: 2762408 →

MOVANO Pianale piatto/Telaio (U9, E9)

2.5 D	Diesel	59	07/98 → 09/00	
2.8 dTI	Diesel	84	06/99 → 10/01	ENGINE: 2762408 →

MOVANO Ribaltabile (H9)

2.5 D	Diesel	59	01/99 → 09/00	
2.8 dTI	Diesel	84	06/99 → 10/01	ENGINE: 2762408 →

RENAULT

19 I (B/C53_)

1.7 (B/C53B)	Petrol	54	09/88 → 04/92	
1.7 (B/C53C)	Petrol	66	09/88 → 04/92	
1.8 16V (B/C53D)	Petrol	99	06/89 → 04/92	

19 I Cabriolet (D53_)

1.7	Petrol	70	07/91 → 04/92	
1.8 16V (D53D)	Petrol	101	07/91 → 04/92	

19 I Chamade (L53_)

1.7 (L53B)	Petrol	54	10/89 → 04/92	
1.7 (L53C)	Petrol	66	07/88 → 04/92	
1.8 16V (L53D)	Petrol	99	10/89 → 04/92	

19 II (B/C53_)

1.4 (B/C535)	Petrol	55	01/92 → 12/95	
1.8 (5/353A)	Petrol	66	04/92 → 12/95	
1.8 (5/353F, B/C538)	Petrol	79	05/94 → 12/95	
1.8 (B/C538)	Petrol	81	04/92 → 05/94	
1.8 (B/C53Y)	Petrol	65	04/92 → 12/95	
1.8 16V (B/C53D)	Petrol	99	04/92 → 12/95	

SPA160

KW

OPEL
19 II Cabriolet (D53_, 853_)

1.7 (D53C)	Petrol	66	04/92 → 09/93
1.8 (D53V, 853F, D53C)	Petrol	79	07/94 → 06/96
1.8 (D53Y)	Petrol	65	04/92 → 06/96
1.8 16V (D53D)	Petrol	99	04/92 → 06/96

19 II Chamade (L53_)

1.4 (L535)	Petrol	55	11/93 → 12/95
1.8 (453A/F)	Petrol	66	04/92 → 12/95
1.8 (L538)	Petrol	81	04/92 → 05/94
1.8 (L53V, L538)	Petrol	79	05/94 → 12/95
1.8 (L53Y)	Petrol	65	04/92 → 12/95
1.8 16V (L53D)	Petrol	99	04/92 → 12/95

21 (B48_)

1.7 (B48E)	Petrol	66	09/89 → 06/94
1.7 (B48F)	Petrol	54	09/89 → 10/92
2.0 (B48R/Y)	Petrol	99	02/90 → 10/92
2.2 (B48K)	Petrol	79	09/89 → 06/94

21 Station wagon (K48_)

1.7 (K/S481)	Petrol	55	06/86 → 03/93
1.7 (K48E)	Petrol	66	10/89 → 12/93
1.7 (K48F) Cat.	Petrol	54	05/88 → 06/93
2.2 (K48K)	Petrol	79	06/86 → 11/93

21 Tre volumi (L48_)

1.7 (L481)	Petrol	55	03/86 → 12/87
1.7 (L482)	Petrol	65	03/86 → 03/93
1.7 (L48E)	Petrol	66	09/89 → 02/94
1.7 (L48E)	Petrol	69	03/86 → 02/94
1.7 (L48M, L48F)	Petrol	54	07/86 → 02/94
2.0	Petrol	78	05/91 → 10/93
2.2 (L48K)	Petrol	79	07/86 → 02/94

25 (B29_)

2.0 (B297)	Petrol	74	04/84 → 12/92
2.0 12V	Petrol	103	06/88 → 12/93
2.0 12V (B294)	Petrol	99	06/89 → 12/92
2.2 (B29B)	Petrol	79	09/86 → 12/92
2.8 V6 Injection (B29F)	Petrol	110	06/87 → 12/92

CLIO I (B/C57_, 5/357_)

1.2 (B/C/S57A, B/C57S, 5/357F, 5/357J, 5/357L, 5/357R)	Petrol	43	05/90 → 09/98
1.2 (B/C57R)	Petrol	40	01/91 → 06/96
1.4	Petrol	59	01/91 → 09/98

SPA160

KW

OPEL
CLIO I (B/C57_, 5/357_)

1.4 (B/C57T, B/C57Y)	Petrol	58	01/91 → 09/98
1.8 (B/C578)	Petrol	66	08/94 → 09/98
1.8 (B/C57C, B/C57U)	Petrol	65	01/91 → 09/98
1.8 16V (C57D)	Petrol	99	01/91 → 03/96
1.8 Rsi (B/C579)	Petrol	80	01/93 → 08/95
1.8 Rsi (B/C57H)	Petrol	79	08/95 → 09/98
Williams (B/C57M)	Petrol	108	01/94 → 09/98

CLIO I Furgonato (S57_)

1.2	Petrol	40	01/91 → 09/98
1.2	Petrol	44	01/91 → 09/98

ESPACE II (J/S63_)

2.0 (J636)	Petrol	76	01/91 → 10/96
2.2 (J/S637, J63G)	Petrol	79	01/91 → 10/96
2.8 V6 (J638, J63J)	Petrol	110	01/91 → 10/96

LAGUNA I (B56_, 556_)

1.8 (B56A/B)	Petrol	66	11/93 → 03/01
1.8 (B56S/T/0)	Petrol	66	08/95 → 03/01
1.8 (B56Z)	Petrol	69	08/95 → 03/01
2.0 (B56C/H/N)	Petrol	83	11/93 → 03/01
2.2 D (B56F/2)	Diesel	61	11/93 → 03/01
3.0 (B56E/R, B565)	Petrol	123	11/93 → 03/01

LAGUNA I Grandtour (K56_)

1.8 (K56S/T/0)	Petrol	66	09/95 → 03/01
1.8 (K56Z)	Petrol	69	09/95 → 03/01
2.0 (K56C/H)	Petrol	83	09/95 → 03/01
2.2 D (K56F/2, S56F)	Diesel	61	09/95 → 03/01

MASTER I Autobus (T_)

28-35 2.0	Petrol	58	10/86 → 07/98
30 2,2	Petrol	67	08/80 → 07/98

MASTER I Furgonato (T_)

28-35 2.0	Petrol	58	10/86 → 07/98
30 2,2	Petrol	67	08/80 → 07/98

MASTER I Pianale piatto/Telaio (P_)

28-35 2.0	Petrol	58	10/86 → 07/98
-----------	--------	----	---------------

MASTER II Autobus (JD)

2.5 D	Diesel	59	07/98 → 01/01
2.8 dTI	Diesel	84	07/98 → 10/01

SPA160



OPEL

MASTER II Furgonato (FD)

2.5 D Diesel 59 07/98 → 01/01

MASTER II Pianale piatto/Telaio (ED/HD/UD)

2.5 D Diesel 59 07/98 → 01/01

MEGANE I (BA0/1_)

1.6 e (BA0F, BA0S) Petrol 66 01/96 → 03/99

MEGANE I Coach (DA0/1_)

1.6 e (DA0F) Petrol 66 03/96 → 03/99

RAPID Furgonato (F40_, G40_)

1.2 (F406, G40A) Petrol 40 09/91 → 03/98

1.4 (F40D) Petrol 58 01/94 → 03/98

1.4 (F40U, F40V) Petrol 55 09/91 → 03/98

1.9 D (F40R) Diesel 40 09/94 → 03/98

SAFRANE I (B54_)

2.0 (B540) Petrol 77 11/92 → 07/96

2.0 12V (B542, B54E) Petrol 97 04/92 → 07/96

2.2 (B541) Petrol 79 04/92 → 07/96

2.2 (B543) Petrol 101 04/92 → 07/96

3.0 Biturbo 4x4 (B545) Petrol 193 02/93 → 07/96

3.0 V6 (B54B, B544) Petrol 123 12/92 → 07/96

2.9 24V (B54N) Petrol 140 03/99 → 12/00

3.0 V6 (B54M) Petrol 123 07/96 → 12/00

SUPER 5 (B/C40_)

1.7 i (C409) Petrol 69 06/88 → 08/91

TRAFIC Autobus (TXW)

1.7 Petrol 50 08/92 → 08/94

2.2 Petrol 70 05/89 → 06/94

2.2 Petrol 74 06/94 → 10/97

2.2 4x4 Petrol 70 05/89 → 06/94

2.2 4x4 Petrol 74 06/94 → 10/97

TRAFIC Furgonato (TXX)

2.2 4x4 Petrol 70 05/89 → 06/94

2.2 4x4 Petrol 74 06/94 → 10/97

TRAFIC Pianale piatto/Telaio (PXX)

1.7 Petrol 50 05/89 → 08/94

2.0 [RWD] Petrol 59 05/89 → 10/97

TWINGO I (C06_)

1.2 (C063, C064) Petrol 40 03/93 → 10/96

TWINGO I Furgonato (S06_)

1.2 (S063, S064) Petrol 40 03/93 → 05/96

SPA160



VOLVO

440 K (445)

1.7 Petrol 78 09/88 → 12/96

1.8 Petrol 66 08/91 → 07/96

1.9 Turbo-Diesel Diesel 66 01/95 → 12/96

460 L (464)

1.7 Petrol 75 08/89 → 07/92

1.8 Petrol 66 08/91 → 07/96

1.9 Turbo-Diesel Diesel 66 01/95 → 07/96

SPA161

F1 **SENSORE TEMPERATURA REFRIGERANTE**
COOLANT TEMPERATURE SENSOR



CITROËN

BERLINGO (B9)

1.6 Petrol 66 04/08 →

1.6 Petrol 80 04/08 →

BERLINGO Furgonato (B9)

1.6 Petrol 66 04/08 →

1.6 Petrol 80 04/08 →

C2 (JM_)

1.4 16V Petrol 65 06/06 →

1.6 VTS Petrol 90 01/05 →

C4 Grand Picasso I (UA_)

1.6 VTi 120 Petrol 88 07/08 →

C4 I (LC_)

1.6 THP 150 Petrol 110 07/08 →

1.6 VTi 120 Petrol 88 07/08 →

C4 Picasso I (UD_)

1.6 VTi 120 Petrol 88 07/08 →

MINI

MINI (R56)

Cooper Petrol 88 10/06 →

Cooper S Petrol 128 10/06 →

SPA161

PEUGEOT
1007 (KM_)

1.4 16V	Petrol	65	10/05 →
---------	--------	----	---------

206 Tre volumi

1.6 16V	Petrol	80	03/07 →
---------	--------	----	---------

207 (WA_, WC_)

1.4 16V	Petrol	70	06/07 →
---------	--------	----	---------

1.4 16V	Petrol	65	02/06 →
---------	--------	----	---------

1.6 16V	Petrol	80	02/06 →
---------	--------	----	---------

1.6 16V RC	Petrol	128	02/07 →
------------	--------	-----	---------

1.6 16V Turbo	Petrol	110	02/06 →
---------------	--------	-----	---------

1.6 16V VTi	Petrol	88	02/07 →
-------------	--------	----	---------

207 CC (WD_)

1.6 16V	Petrol	88	02/07 →
---------	--------	----	---------

1.6 16V Turbo	Petrol	110	02/07 →
---------------	--------	-----	---------

207 SW (WK_)

1.4 16V	Petrol	70	06/07 →
---------	--------	----	---------

1.6 16V	Petrol	88	06/07 →
---------	--------	----	---------

307 (3A/C)

1.6 16V	Petrol	80	06/05 →
---------	--------	----	---------

307 Break (3E)

1.6 16V	Petrol	80	06/05 →
---------	--------	----	---------

307 SW (3H)

1.6 16V	Petrol	80	06/05 →
---------	--------	----	---------

308 (4A_, 4C_)

1.4 16V	Petrol	70	09/07 →
---------	--------	----	---------

1.6 16V	Petrol	110	09/07 →
---------	--------	-----	---------

1.6 16V	Petrol	128	03/08 →
---------	--------	-----	---------

1.6 16V	Petrol	88	09/07 →
---------	--------	----	---------

308 SW

1.4 16V	Petrol	70	09/07 →
---------	--------	----	---------

1.6 16V	Petrol	110	09/07 →
---------	--------	-----	---------

1.6 16V	Petrol	128	03/08 →
---------	--------	-----	---------

1.6 16V	Petrol	88	09/07 →
---------	--------	----	---------

RANCH

1.6	Petrol	66	04/08 →
-----	--------	----	---------

1.6	Petrol	80	04/08 →
-----	--------	----	---------

RANCH Furgonato

1.6	Petrol	66	04/08 →
-----	--------	----	---------

1.6	Petrol	80	04/08 →
-----	--------	----	---------

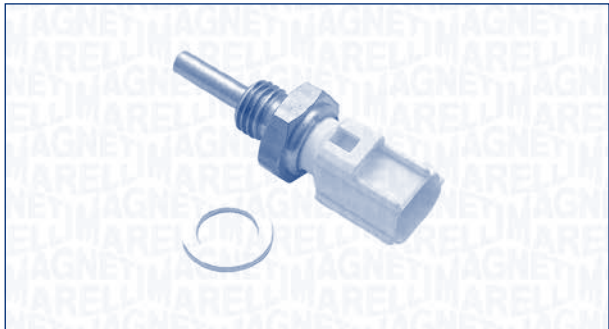
SPA162
F1 **SENSORE TEMPERATURA REFRIGERANTE**
COOLANT TEMPERATURE SENSOR

CITROËN
C1 (PM_, PN_)

1.0	Petrol	50	06/05 →
-----	--------	----	---------

PEUGEOT
107

1.0	Petrol	50	06/05 →
-----	--------	----	---------

TOYOTA
AYGO (WNB1_, KGB1_)

1.0 (KGB10)	Petrol	50	07/05 →
-------------	--------	----	---------

YARIS (SCP9_, NSP9_, KSP9_, NCP9_, ZSP9_)

1.0 VVT-i	Petrol	51	08/05 →
-----------	--------	----	---------

1.3 VVT-i	Petrol	64	08/05 →
-----------	--------	----	---------

1.4 D-4D	Diesel	66	08/05 →
----------	--------	----	---------

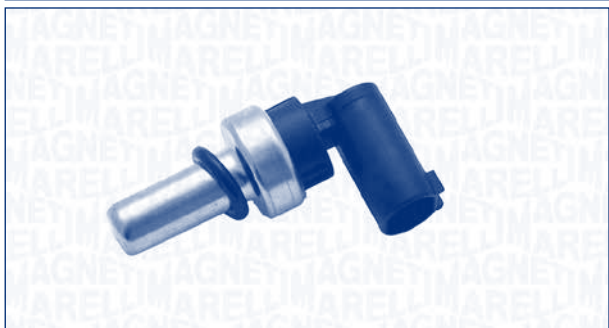
SPA163
F1 **SENSORE TEMPERATURA REFRIGERANTE**
COOLANT TEMPERATURE SENSOR

MERCEDES-BENZ
CLASSE A (W168)

A 140 (168.031, 168.131)	Petrol	60	01/01 → 08/04
--------------------------	--------	----	---------------

A 140 (168.031, 168.131)	Petrol	60	07/97 → 08/04
--------------------------	--------	----	---------------

SPA163



KW



MERCEDES-BENZ

CLASSE A (W168)

A 160 (168.033, 168.133)	Petrol	75	07/97 → 08/04
A 160 CDI (168.006)	Diesel	55	02/01 → 08/04
A 160 CDI (168.007)	Diesel	44	07/98 → 02/01
A 170 CDI (168.008)	Diesel	66	07/98 → 02/01
A 170 CDI (168.009, 168.109)	Diesel	70	02/01 → 08/04
A 190 (168.032, 168.132)	Petrol	92	03/99 → 08/04
A 210 (168.035, 168.135)	Petrol	103	03/02 → 08/04

CLASSE C (W202)

C 200 CDI (202.134)	Diesel	75	03/98 → 05/00
C 220 CDI (202.133)	Diesel	92	09/97 → 05/00
C 240 (202.026)	Petrol	125	06/97 → 05/00
C 280 (202.029)	Petrol	145	06/97 → 05/00
C 43 AMG (202.033)	Petrol	225	08/97 → 05/00

CLASSE C (W203)

C 180 Kompressor (203.046)	Petrol	105	05/02 → 02/07
C 200 CDI	Diesel	75	02/01 → 02/07
C 200 CDI (203.004)	Diesel	85	09/00 → 02/07
C 200 CDI (203.007)	Diesel	90	04/03 → 02/07
C 200 CGI Kompressor (203.043)	Petrol	125	07/03 → 02/07
C 200 Kompressor (203.042)	Petrol	120	05/02 → 02/07
C 220 CDI (203.006)	Diesel	105	05/00 → 02/07
C 220 CDI (203.008)	Diesel	110	02/03 → 02/07

SPA163



KW



MERCEDES-BENZ

CLASSE C (W203)

C 230 Kompressor (203.040)	Petrol	141	02/04 → 02/07
C 240 (203.061)	Petrol	125	05/00 → 02/07
C 240 4-matic (203.081)	Petrol	125	07/02 → 02/07
C 270 CDI (203.016)	Diesel	125	12/00 → 02/07
C 30 CDI AMG (203.018)	Diesel	170	01/03 → 02/07
C 32 AMG Kompressor (203.065)	Petrol	260	02/01 → 02/07
C 320 (203.064)	Petrol	160	05/00 → 02/07
C 320 4-matic (203.084)	Petrol	160	07/02 → 02/07

CLASSE C Sportcoupe (CL203)

C 180 Kompressor (203.746)	Petrol	105	05/02 → 05/08
C 200 CDI (203.707)	Diesel	90	03/03 → 05/08
C 200 CGI Kompressor (203.743)	Petrol	125	03/03 → 05/08
C 200 Kompressor (203.742)	Petrol	120	05/02 → 05/08
C 220 CDI (203.706)	Diesel	105	03/01 → 05/08
C 30 CDI AMG (203.718)	Diesel	170	09/02 → 05/08
C 320 (203.764)	Petrol	160	09/02 → 05/08

CLASSE C Station wagon (S202)

C 200 T CDI (202.194)	Diesel	75	03/98 → 03/01
C 220 T CDI (202.193)	Diesel	92	09/97 → 03/01
C 240 T (202.086)	Petrol	125	06/97 → 09/00
C 240 T (202.088)	Petrol	125	09/00 → 03/01
C 280 T (202.089)	Petrol	145	06/97 → 03/01

SPA163

KW

MERCEDES-BENZ
CLASSE C Station wagon (S202)

C 43 AMG (202.093)	Petrol	225	08/97 → 03/01
-----------------------	--------	-----	---------------

CLASSE C T-Model (S203)

C 180 Kompressor (203.246)	Petrol	105	05/02 → 08/07
----------------------------------	--------	-----	---------------

C 200 CDI (203.204)	Diesel	85	03/01 → 08/07
------------------------	--------	----	---------------

C 200 CDI (203.204, 203.207)	Diesel	75	03/01 → 08/07
------------------------------------	--------	----	---------------

C 200 CGI Kompressor (203.243)	Petrol	125	07/03 → 08/07
--------------------------------------	--------	-----	---------------

C 220 CDI (203.206)	Diesel	105	03/01 → 08/07
------------------------	--------	-----	---------------

C 240 (203.261)	Petrol	125	03/01 → 08/07
-----------------	--------	-----	---------------

C 240 4-matic (203.281)	Petrol	125	07/02 → 08/07
----------------------------	--------	-----	---------------

C 270 CDI (203.216)	Diesel	125	03/01 → 08/07
------------------------	--------	-----	---------------

C 30 CDI AMG (203.218)	Diesel	170	01/03 → 08/07
---------------------------	--------	-----	---------------

C 32 AMG Kompressor (203.265)	Petrol	260	03/01 → 08/07
-------------------------------------	--------	-----	---------------

C 320 (203.264, 203.764)	Petrol	160	03/01 → 08/07
-----------------------------	--------	-----	---------------

C 320 4-matic (203.284)	Petrol	160	07/02 → 08/07
----------------------------	--------	-----	---------------

CLASSE E (W210)

E 200 CDI (210.007)	Diesel	75	06/98 → 03/02
------------------------	--------	----	---------------

E 200 CDI (210.007)	Diesel	85	07/99 → 03/02
------------------------	--------	----	---------------

E 220 CDI (210.006)	Diesel	105	07/99 → 03/02
------------------------	--------	-----	---------------

E 240 (210.061)	Petrol	125	06/97 → 08/00
-----------------	--------	-----	---------------

E 240 (210.062)	Petrol	125	08/00 → 03/02
-----------------	--------	-----	---------------

E 270 CDI (210.016)	Diesel	125	07/99 → 03/02
------------------------	--------	-----	---------------

E 320 CDI (210.026)	Diesel	145	07/99 → 03/02
------------------------	--------	-----	---------------

SPA163

KW

MERCEDES-BENZ
CLASSE E (W210)

E 430 (210.070)	Petrol	205	06/97 → 03/02
-----------------	--------	-----	---------------

E 430 4-matic (210.083)	Petrol	205	05/99 → 03/02
----------------------------	--------	-----	---------------

E 55 AMG (210.074)	Petrol	260	08/97 → 03/02
-----------------------	--------	-----	---------------

CLASSE E (W211)

E 200 CDI (211.004)	Diesel	75	07/02 → 12/08
------------------------	--------	----	---------------

E 200 CDI (211.004)	Diesel	90	07/02 → 12/08
------------------------	--------	----	---------------

E 200 Kompressor (211.042)	Petrol	120	11/02 → 12/08
----------------------------------	--------	-----	---------------

E 220 CDI (211.006)	Diesel	110	03/02 → 12/08
------------------------	--------	-----	---------------

E 240 (211.061)	Petrol	130	03/02 → 12/08
-----------------	--------	-----	---------------

E 270 CDI (211.016)	Diesel	130	03/02 → 12/08
------------------------	--------	-----	---------------

E 320 (211.065)	Petrol	165	03/02 → 12/08
-----------------	--------	-----	---------------

E 320 4-matic (211.082)	Petrol	165	03/03 → 12/08
----------------------------	--------	-----	---------------

E 320 CDI (211.026)	Diesel	150	11/02 → 12/08
------------------------	--------	-----	---------------

E 400 CDI (211.028)	Diesel	191	02/03 → 12/08
------------------------	--------	-----	---------------

E 500 (211.070)	Petrol	225	03/02 → 12/08
-----------------	--------	-----	---------------

E 55 AMG Kompressor (211.076)	Petrol	350	10/02 → 12/08
-------------------------------------	--------	-----	---------------

CLASSE E Station wagon (S210)

E 220 T CDI (210.206)	Diesel	105	07/99 → 03/03
--------------------------	--------	-----	---------------

E 220 T CDI (210.206)	Diesel	92	06/98 → 07/99
--------------------------	--------	----	---------------

E 240 T (210.261)	Petrol	125	06/97 → 03/03
-------------------	--------	-----	---------------

E 240 T (210.262)	Petrol	125	08/00 → 03/03
-------------------	--------	-----	---------------

E 270 T CDI (210.216)	Diesel	125	07/99 → 03/03
--------------------------	--------	-----	---------------

E 280 T (210.263)	Petrol	150	12/96 → 03/03
-------------------	--------	-----	---------------

E 320 T CDI (210.226)	Diesel	145	07/99 → 03/03
--------------------------	--------	-----	---------------

E 430 T (210.270)	Petrol	205	06/97 → 03/03
-------------------	--------	-----	---------------

E 430 T 4-matic (210.283)	Petrol	205	05/99 → 03/03
------------------------------	--------	-----	---------------

SPA163



KW



MERCEDES-BENZ

CLASSE E Station wagon (S210)

E 55 T AMG (210.274) Petrol 260 08/97 → 03/03

E 55 T AMG 4-matic (210.283) Petrol 260 03/01 → 03/03

CLASSE E T-Model (S211)

E 200 T Kompressor (211.242) Petrol 120 03/03 → 07/09

E 220 T CDI (211.206) Diesel 110 03/03 → 07/09

E 240 T (211.261) Petrol 130 03/03 → 07/09

E 270 T CDI (211.216) Diesel 130 03/03 → 07/09

E 320 T (211.265) Petrol 165 03/03 → 07/09

E 320 T CDI (211.226) Diesel 150 03/03 → 07/09

E 500 T (211.270) Petrol 225 10/03 → 07/09

E 55 T AMG Kompressor (211.276) Petrol 350 07/03 → 07/09

CLASSE G (W463)

G 270 CDI (463.322, 463.323) Diesel 115 10/01 →

G 320 (463.232, 463.233, 463.244, 463.245) Petrol 158 07/97 →

G 400 CDI (463.332, 463.333) Diesel 184 12/00 →

G 500 (463.247, 463.248, 463.249, 463.240, 463.421) Petrol 218 04/98 →

G 55 AMG (463.243, 463.246) Petrol 260 04/99 →

CLASSE G Cabrio (W463)

G 320 (463.209) Petrol 158 11/97 →

G 400 CDI (463.309) Diesel 184 12/00 →

G 500 (463) Petrol 218 04/98 →

SPA163



KW



MERCEDES-BENZ

CLASSE M (W163)

ML 320 (163.154) Petrol 160 02/98 → 08/02

ML 350 Petrol 173 02/03 → 06/05

ML 350 (163.157) Petrol 180 08/02 → 06/05

ML 400 CDI (163.128) Diesel 184 09/01 → 06/05

ML 430 (163.172) Petrol 200 02/98 → 06/05

ML 500 (163.175) Petrol 215 09/01 → 06/05

ML 55 AMG (163.174) Petrol 255 02/00 → 06/05

CLASSE S (W220)

S 280 (220.063, 220.163) Petrol 150 10/98 → 08/05

S 320 (220.065, 220.165) Petrol 165 10/98 → 08/05

S 320 CDI (220.025, 220.125) Diesel 150 09/02 → 08/05

S 320 CDI (220.026, 220.126) Diesel 145 08/99 → 09/02

S 350 (220.067, 220.167) Petrol 180 09/02 → 08/05

S 350 4-matic (220.087, 220.187) Petrol 180 06/03 → 08/05

S 400 CDI (220.028, 220.128) Diesel 184 06/00 → 08/05

S 430 (220.070, 220.170) Petrol 205 10/98 → 08/05

S 430 4-matic (220.083, 220.183) Petrol 205 09/02 → 08/05

S 500 (220.075, 220.175, 220.875) Petrol 225 10/98 → 08/05

S 500 4-matic (220.084, 220.184) Petrol 225 09/02 → 08/05

S 55 AMG (220.073, 220.173) Petrol 265 04/99 → 08/05

SPA163

MERCEDES-BENZ
CLASSE S (W220)

S 55 AMG Kompressor (220.074, 220.174)	Petrol	368	06/02 → 08/05
--	--------	-----	---------------

S 600 (220.176)	Petrol	368	09/02 → 08/05
-----------------	--------	-----	---------------

S 600 (220.878, 220.178)	Petrol	270	01/00 → 08/05
--------------------------	--------	-----	---------------

CLASSE S Coupé (C215)

CL 500 (215.375)	Petrol	225	03/99 → 03/06
------------------	--------	-----	---------------

CL 55 AMG (215.373)	Petrol	265	10/99 → 03/06
---------------------	--------	-----	---------------

CL 55 AMG Kompressor (215.374)	Petrol	368	06/02 → 03/06
--------------------------------	--------	-----	---------------

CL 600 (215.376)	Petrol	368	09/02 → 03/06
------------------	--------	-----	---------------

CL 600 (215.378)	Petrol	270	03/99 → 03/06
------------------	--------	-----	---------------

CLASSE V (638/2)

V 200 CDI (638.294)	Diesel	75	03/99 → 07/03
---------------------	--------	----	---------------

V 220 CDI (638.294)	Diesel	90	03/99 → 07/03
---------------------	--------	----	---------------

CLK (C208)

320 (208.365)	Petrol	160	06/97 → 06/02
---------------	--------	-----	---------------

430 (208.370)	Petrol	205	07/98 → 06/02
---------------	--------	-----	---------------

55 AMG (208.374)	Petrol	255	08/99 → 06/02
------------------	--------	-----	---------------

CLK (C209)

200 CGI (209.343)	Petrol	125	07/03 → 05/09
-------------------	--------	-----	---------------

CLK (C209)

200 Kompressor (209.342)	Petrol	120	09/02 → 05/09
--------------------------	--------	-----	---------------

240 (209.361)	Petrol	125	06/02 → 05/09
---------------	--------	-----	---------------

270 CDI (209.316)	Diesel	125	10/02 → 05/09
-------------------	--------	-----	---------------

320 (209.365)	Petrol	160	06/02 → 05/09
---------------	--------	-----	---------------

500 (209.375)	Petrol	225	06/02 → 05/09
---------------	--------	-----	---------------

55 AMG (209.376)	Petrol	270	09/02 → 05/09
------------------	--------	-----	---------------

CLK Cabriolet (A208)

320 (208.465)	Petrol	160	03/98 → 03/02
---------------	--------	-----	---------------

430 (208.470)	Petrol	205	09/98 → 03/02
---------------	--------	-----	---------------

SPA163

MERCEDES-BENZ
CLK Cabriolet (A209)

CLK 200 CGI (209.443)	Petrol	125	07/03 → 03/10
-----------------------	--------	-----	---------------

CLK 200 Kompressor (209.442)	Petrol	120	02/03 → 03/10
------------------------------	--------	-----	---------------

CLK 240 (209.461)	Petrol	125	02/03 → 03/10
-------------------	--------	-----	---------------

CLK 320 (209.465)	Petrol	160	02/03 → 03/10
-------------------	--------	-----	---------------

CLK 500 (209.475)	Petrol	225	02/03 → 03/10
-------------------	--------	-----	---------------

CLK 55 AMG (209.476)	Petrol	270	02/03 → 03/10
----------------------	--------	-----	---------------

SL (R129)

280 (129.059)	Petrol	150	05/98 → 10/01
---------------	--------	-----	---------------

320 (129.064)	Petrol	165	05/98 → 10/01
---------------	--------	-----	---------------

500 (129.068)	Petrol	225	05/98 → 10/01
---------------	--------	-----	---------------

SL (R230)

350 (230.467)	Petrol	180	03/03 → 01/12
---------------	--------	-----	---------------

500 (230.475)	Petrol	225	10/01 → 01/12
---------------	--------	-----	---------------

55 AMG (230.474)	Petrol	350	10/01 → 06/02
------------------	--------	-----	---------------

55 AMG Kompressor (230.474)	Petrol	368	06/02 → 01/12
-----------------------------	--------	-----	---------------

600 (230.476)	Petrol	368	04/03 → 01/12
---------------	--------	-----	---------------

SLK (R170)

32 AMG Kompressor (170.466)	Petrol	260	03/01 → 04/04
-----------------------------	--------	-----	---------------

320 (170.465)	Petrol	160	03/00 → 04/04
---------------	--------	-----	---------------

SPRINTER 2-t Autobus (901, 902)

208 CDI	Diesel	60	04/00 → 05/06
---------	--------	----	---------------

211 CDI	Diesel	80	04/00 → 05/06
---------	--------	----	---------------

213 CDI	Diesel	95	04/00 → 05/06
---------	--------	----	---------------

216 CDI	Diesel	115	04/00 → 05/06
---------	--------	-----	---------------

SPRINTER 2-t Furgonato (901, 902)

208 CDI	Diesel	60	04/00 → 05/06
---------	--------	----	---------------

211 CDI	Diesel	80	04/00 → 05/06
---------	--------	----	---------------

213 CDI	Diesel	95	04/00 → 05/06
---------	--------	----	---------------

216 CDI	Diesel	115	04/00 → 05/06
---------	--------	-----	---------------

SPA163



KW



MERCEDES-BENZ

SPRINTER 2-t Pianale piatto/Telaio (901, 902)

208 CDI	Diesel	60	04/00 → 05/06
211 CDI	Diesel	80	04/00 → 05/06
213 CDI	Diesel	95	04/00 → 05/06
216 CDI	Diesel	115	04/00 → 05/06

SPRINTER 3-t Autobus (903)

308 CDI	Diesel	60	04/00 → 05/06
311 CDI	Diesel	80	04/00 → 05/06
311 CDI 4x4	Diesel	80	08/02 → 05/06
313 CDI 4x4	Diesel	95	08/02 → 05/06
316 CDI	Diesel	115	04/00 → 05/06
316 CDI 4x4	Diesel	115	08/02 → 05/06

SPRINTER 3-t Furgonato (903)

308 CDI	Diesel	60	04/00 → 05/06
311 CDI	Diesel	80	04/00 → 05/06
311 CDI 4x4	Diesel	80	08/02 → 05/06
313 CDI	Diesel	95	04/00 → 05/06
313 CDI 4x4	Diesel	95	08/02 → 05/06
316 CDI	Diesel	115	04/00 → 05/06
316 CDI 4x4	Diesel	115	08/02 → 05/06

SPRINTER 3-t Pianale piatto/Telaio (903)

308 CDI	Diesel	60	04/00 → 05/06
311 CDI	Diesel	80	04/00 → 05/06
311 CDI 4x4	Diesel	80	08/02 → 05/06
313 CDI	Diesel	95	04/00 → 05/06
316 CDI	Diesel	115	04/00 → 05/06
316 CDI 4x4	Diesel	115	08/02 → 05/06

SPRINTER 4-t Autobus (904)

408 CDI	Diesel	60	04/00 → 05/06
411 CDI	Diesel	80	04/00 → 05/06
413 CDI	Diesel	95	04/00 → 05/06
416 CDI	Diesel	115	04/00 → 05/06

SPRINTER 4-t Furgonato (904)

408 CDI	Diesel	60	04/00 → 05/06
411 CDI	Diesel	80	04/00 → 05/06
411 CDI 4x4	Diesel	80	04/00 → 05/06
413 CDI	Diesel	95	04/00 → 05/06
416 CDI	Diesel	115	04/00 → 05/06
416 CDI 4x4	Diesel	115	04/00 → 05/06

SPRINTER 4-t Pianale piatto/Telaio (904)

408 CDI	Diesel	60	04/00 → 05/06
411 CDI	Diesel	80	04/00 → 05/06
411 CDI 4x4	Diesel	80	04/00 → 05/06
413 CDI	Diesel	95	04/00 → 05/06
416 CDI	Diesel	115	04/00 → 05/06

SPA163



KW



MERCEDES-BENZ

SPRINTER 4-t Pianale piatto/Telaio (904)

416 CDI 4x4	Diesel	115	04/00 → 05/06
-------------	--------	-----	---------------

Vaneo (414)

1.6 (414.700)	Petrol	60	02/02 → 07/05
1.6 (414.700)	Petrol	75	02/02 → 07/05
1.7 CDI (414.700)	Diesel	55	02/02 → 07/05
1.7 CDI (414.700)	Diesel	67	02/02 → 07/05
1.9 (414.700)	Petrol	92	02/02 → 07/05

VIANO (W639)

3,0	Petrol	140	09/03 →
3.2	Petrol	160	09/03 →
3.7	Petrol	170	06/04 →
CDI 2.0	Diesel	80	09/03 →
CDI 2.2	Diesel	110	09/03 →

VITO Autobus (638)

108 CDI 2.2 (638.194)	Diesel	60	03/99 → 07/03
110 CDI 2.2 (638.194)	Diesel	75	03/99 → 07/03
112 CDI 2.2 (638.194)	Diesel	90	03/99 → 07/03

VITO Furgonato (638)

108 CDI 2.2 (638.094)	Diesel	60	03/99 → 07/03
110 CDI 2.2 (638.094)	Diesel	75	03/99 → 07/03
112 CDI 2.2 (638.094)	Diesel	90	03/99 → 07/03

SMART

CABRIO (450)

0.6 (450.400, S1OLD2)	Petrol	45	01/01 → 01/04
0.6 (450.432)	Petrol	52	06/02 → 01/04
0.6 (450.433, S1OLA1)	Petrol	40	03/00 → 01/04
0.7 (450.400)	Petrol	45	01/03 → 01/04
0.7 (450.414)	Petrol	55	01/03 → 01/04
0.8 CDI (450.401, 450.402, 450.403, S1OLC1)	Diesel	30	03/01 → 01/04

SPA163

SMART
CITY-COUPE (450)

0.6 (450.330, 450.332)	Petrol	52	06/02 → 01/04
0.6 (450.333, 450.335)	Petrol	45	01/01 → 01/04
0.6 (450.341, S1CLA1)	Petrol	40	07/98 → 01/04
0.6 (450.342, S1CLB1)	Petrol	33	07/98 → 01/04
0.7 (450.314)	Petrol	55	01/03 → 01/04
0.7 (450.336, 450.352, 450.353)	Petrol	45	01/03 → 01/04
0.7 (450.347)	Petrol	37	01/03 → 01/04
0.8 CDI (450.300, 450.301, 450.302, 450.303, 450.306...)	Diesel	30	11/99 → 01/04

FORFOUR (454)

1.5 CDI (454.000)	Diesel	50	09/04 → 06/06
1.5 CDI (454.001)	Diesel	70	09/04 → 06/06

FORTWO Cabrio (450)

0.7 (450.414, 450.441, 450.442, 450.443, 450.452)	Petrol	45	01/04 → 01/07
0.7 (450.452)	Petrol	55	01/04 → 01/07
0.8 CDI (450.401, 450.402, 450.403)	Diesel	30	01/04 → 01/07

FORTWO Coupé (450)

0.7 (450.314)	Petrol	55	01/04 → 01/07
0.7 (450.331)	Petrol	37	01/04 → 01/07
0.7 (450.335, 450.336, 450.341, 450.342, 450.343...)	Petrol	45	01/04 → 01/07
0.8 CDI (450.300, 450.301, 450.302, 450.303, 450.306)	Diesel	30	01/04 → 01/07

ROADSTER (452)

0.7 (452.432)	Petrol	45	04/03 → 11/05
0.7 (452.434)	Petrol	60	04/03 → 11/05

SPA163

SMART
ROADSTER (452)

0.7 Brabus (452.437)	Petrol	74	12/03 → 11/05
----------------------	--------	----	---------------

ROADSTER Coupé (452)

0.7 (452.334)	Petrol	60	04/03 → 11/05
0.7 Brabus (452.337)	Petrol	74	12/03 → 11/05

SPA164
F1 **SENSORE TEMPERATURA REFRIGERANTE
COOLANT TEMPERATURE SENSOR**

ALFA ROMEO
145 (930)

2.0 16V T.S.	Petrol	110	10/95 → 01/01
--------------	--------	-----	---------------

146 (930)

2.0 16V T.S.	Petrol	110	10/95 → 01/01
--------------	--------	-----	---------------

155 (167)

2.0 T.S. 16V (167.A2G)	Petrol	110	05/96 → 12/97
------------------------	--------	-----	---------------

2.5 TD (167.A1A)	Diesel	92	04/93 → 12/97
------------------	--------	----	---------------

156 (932)

2.5 V6 24V (932A1)	Petrol	140	09/97 → 12/01
--------------------	--------	-----	---------------

2.5 V6 24V (932A11_)	Petrol	141	10/00 → 09/05
----------------------	--------	-----	---------------

156 Sportwagon (932)

2.5 V6 24V (932A1)	Petrol	140	05/00 → 08/03
--------------------	--------	-----	---------------

2.5 V6 24V (932B11_)	Petrol	141	10/00 → 05/06
----------------------	--------	-----	---------------

164 (164)

2.5 TD (164.K2A, 164.K2B)	Diesel	92	09/92 → 09/98
---------------------------	--------	----	---------------

SPA164



ALFA ROMEO

GTV (916C_)

3.0 V6 24V (916.C1B_)	Petrol	160	10/00 → 10/05
-----------------------	--------	-----	---------------

SPIDER (916S_)

3.0 V6 (916S1B00)	Petrol	160	09/94 → 08/00
-------------------	--------	-----	---------------

3.0 V6 24V	Petrol	162	01/99 → 10/03
------------	--------	-----	---------------

BMW

3 (E30)

324 d	Diesel	63	09/88 → 12/90
-------	--------	----	---------------

324 td	Diesel	85	09/87 → 12/90
--------	--------	----	---------------

3 Touring (E30)

324 td	Diesel	85	01/88 → 06/93
--------	--------	----	---------------

3 Touring (E36)

325 tds	Diesel	105	09/95 → 01/96
---------	--------	-----	---------------

5 (E34)

524 td	Diesel	85	03/88 → 12/91
--------	--------	----	---------------

525 tds	Diesel	105	09/91 → 09/95
---------	--------	-----	---------------

5 Touring (E34)

525 td	Diesel	85	03/93 → 01/97
--------	--------	----	---------------

525 tds	Diesel	105	12/91 → 01/97
---------	--------	-----	---------------

CITROËN

SAXO (S0, S1)

1.0 X	Petrol	37	05/98 → 06/03
-------	--------	----	---------------

SAXO (S0, S1)

1.1 X,SX	Petrol	44	02/98 → 09/03
----------	--------	----	---------------

XSARA (N1)

1.6 i	Petrol	65	07/98 → 09/00
-------	--------	----	---------------

XSARA Break (N2)

1.6 i	Petrol	65	07/98 → 09/00
-------	--------	----	---------------

XSARA Coupé (N0)

1.6 i	Petrol	65	07/98 → 09/00
-------	--------	----	---------------

XSARA PICASSO (N68)

1.6	Petrol	65	12/99 →
-----	--------	----	---------

FIAT

BRAVA (182)

1.8 GT 16V (182.BC)	Petrol	83	10/95 → 10/98
---------------------	--------	----	---------------

BRAVO I (182)

1.8 GT (182.AC)	Petrol	83	10/95 → 07/99
-----------------	--------	----	---------------

LAND ROVER

RANGE ROVER II (LP)

2.5 TD 4x4	Diesel	100	07/94 → 03/02
------------	--------	-----	---------------

SPA164



PEUGEOT

106 II (1)

1.0 i	Petrol	37	01/97 →
-------	--------	----	---------

1.1 i	Petrol	40	12/97 →
-------	--------	----	---------

206 2 volumi /Coda spiovente (2A/C)

1.6 i	Petrol	65	09/98 → 12/00
-------	--------	----	---------------

306 (7B, N3, N5)

1.4 SL	Petrol	55	05/97 → 05/01
--------	--------	----	---------------

1.6 SR	Petrol	65	06/98 → 10/00
--------	--------	----	---------------

306 2 volumi /Coda spiovente (7A, 7C, N3, N5)

1.4	Petrol	55	05/97 → 05/01
-----	--------	----	---------------

1.6	Petrol	65	06/98 → 10/00
-----	--------	----	---------------

306 Break (7E, N3, N5)

1.4	Petrol	55	05/97 → 03/02
-----	--------	----	---------------

1.6	Petrol	65	06/98 → 10/00
-----	--------	----	---------------

RANCH MPV / Space wagon (5F)

1.1	Petrol	44	03/98 →
-----	--------	----	---------

RANCH MPV / Space wagon (5F)

1.4	Petrol	55	04/98 →
-----	--------	----	---------

ROVER

800 (XS)

825 D/SD (XS)	Diesel	87	01/96 → 02/99
---------------	--------	----	---------------

800 2 volumi /Coda spiovente (XS)

825 D/SD (XS)	Diesel	87	01/96 → 02/99
---------------	--------	----	---------------

800 Coupé

825 SD	Diesel	87	01/96 → 02/99
--------	--------	----	---------------

SPA165

F1 **SENSORE TEMPERATURA REFRIGERANTE**
COOLANT TEMPERATURE SENSOR

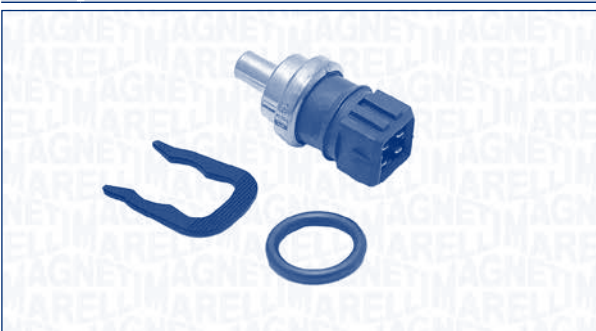

VOLKSWAGEN

GOLF IV Cabriolet (1E7)

1.9 TDI	Diesel	66	06/98 → 06/02	CHASSIS: →1JX250000
---------	--------	----	---------------	------------------------

SPA165

VOLKSWAGEN
GOLF IV Cabriolet (1E7)

1.9 TDI	Diesel	81	06/98 → 06/02	CHASSIS: →1JX250000
---------	--------	----	---------------	------------------------

PASSAT (3B2)

1.9 TDI	Diesel	85	08/98 → 11/00	CHASSIS: →3BX600000
---------	--------	----	---------------	------------------------

1.9 TDI Syncro/4motion	Diesel	81	10/96 → 11/00	CHASSIS: →3BX600000
---------------------------	--------	----	---------------	------------------------

2.3 VR5 Syncro/4motion	Petrol	110	10/97 → 11/00	CHASSIS: →3BX600000
---------------------------	--------	-----	---------------	------------------------

2.8 V6	Petrol	132	05/97 → 09/99	CHASSIS: →3BX600000
--------	--------	-----	---------------	------------------------

PASSAT Variant (3B5)

1.9 TDI	Diesel	85	08/98 → 11/00	CHASSIS: →3BX600000
---------	--------	----	---------------	------------------------

1.9 TDI 4motion	Diesel	85	08/99 → 11/00	CHASSIS: →3BX600000
-----------------	--------	----	---------------	------------------------

1.9 TDI Syncro/4motion	Diesel	81	06/97 → 11/00	CHASSIS: →3BX600000
---------------------------	--------	----	---------------	------------------------

2.3 VR5 Syncro/4motion	Petrol	110	10/97 → 11/00	CHASSIS: →3BX600000
---------------------------	--------	-----	---------------	------------------------

2.8 V6	Petrol	132	09/97 → 09/99	CHASSIS: →3BX600000
--------	--------	-----	---------------	------------------------

2.8 V6	Petrol	140	09/99 → 11/00	CHASSIS: →3BX600000
--------	--------	-----	---------------	------------------------

2.8 V6 Syncro/4motion	Petrol	142	06/97 → 11/00	CHASSIS: →3BX600000
--------------------------	--------	-----	---------------	------------------------

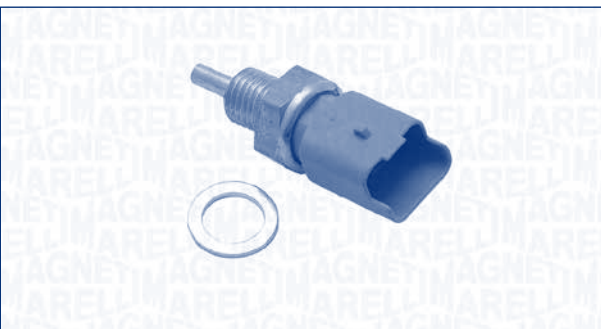
SPA167
F1 **SENSORE TEMPERATURA REFRIGERANTE
COOLANT TEMPERATURE SENSOR**

CITROËN
BERLINGO (MF)

1.6 16V (MFNFU)	Petrol	80	10/00 → 10/02
-----------------	--------	----	---------------

SPA167

CITROËN
BERLINGO (MF)

2.0 HDI 90 (MFRHY)	Diesel	66	12/99 → 10/02
-----------------------	--------	----	---------------

BERLINGO Furgonato (M_)

1.6 16V (MBNFU)	Petrol	80	10/00 → 10/02
-----------------	--------	----	---------------

2.0 HDI 90 (MBRHY, MCRHY)	Diesel	66	12/99 → 10/02
------------------------------	--------	----	---------------

2.0 HDI 90 4WD (MBRHY, MCRHY)	Diesel	66	11/00 → 10/02
----------------------------------	--------	----	---------------

C8 (EA_, EB_)

2.0 HDi	Diesel	79	07/02 →
---------	--------	----	---------

2.2 HDi	Diesel	94	07/02 →
---------	--------	----	---------

JUMPER Autobus (244, Z_)

2.0	Petrol	81	04/02 →
-----	--------	----	---------

JUMPER Furgonato (244)

2.0	Petrol	81	04/02 →
-----	--------	----	---------

SAXO (S0, S1)

1.1 X,SX	Petrol	44	05/96 → 09/03
----------	--------	----	---------------

1.6 VTS	Petrol	72	09/00 → 09/03
---------	--------	----	---------------

XANTIA (X2)

2.0 HDI 109	Diesel	80	02/99 → 04/03
-------------	--------	----	---------------

2.0 HDI 90	Diesel	66	03/99 → 04/03
------------	--------	----	---------------

XANTIA Break (X2)

2.0 HDI 109	Diesel	80	02/99 → 04/03
-------------	--------	----	---------------

2.0 HDI 90	Diesel	66	03/99 → 04/03
------------	--------	----	---------------

XSARA (N1)

1.4 i	Petrol	55	04/97 → 10/02
-------	--------	----	---------------

1.6 16V	Petrol	80	09/00 → 10/02
---------	--------	----	---------------

2.0 HDI 90	Diesel	66	02/99 → 08/00
------------	--------	----	---------------

XSARA Break (N2)

1.4 i	Petrol	55	10/97 → 10/02
-------	--------	----	---------------

1.6 16V	Petrol	80	09/00 → 10/02
---------	--------	----	---------------

2.0 HDI 90	Diesel	66	02/99 → 08/00
------------	--------	----	---------------

XSARA Coupé (N0)

1.4 i	Petrol	55	03/98 → 10/02
-------	--------	----	---------------

1.6 16V	Petrol	80	09/00 → 10/02
---------	--------	----	---------------

2.0 HDI 90	Diesel	66	02/99 → 08/00
------------	--------	----	---------------

XSARA PICASSO (N68)

1.6	Petrol	70	12/99 → 11/02
-----	--------	----	---------------

FIAT
DUCATO Autobus (244, Z_)

2.0	Petrol	81	04/02 →
-----	--------	----	---------

SPA167



KW



FIAT

DUCATO Furgonato (244)

2.0 Petrol 81 04/02 →

PEUGEOT

206 2 volumi /Coda spiovente (2A/C)

1.1 i Petrol 44 03/00 →

1.4 i Petrol 55 03/00 →

1.6 16V Petrol 80 12/00 → 09/02

206 CC (2D)

1.6 16V Petrol 80 09/00 → 09/02

206 SW (2E/K)

1.6 16V Petrol 80 07/02 → 09/02

306 (7B, N3, N5)

1.4 SL Petrol 55 10/00 → 05/01

1.6 Petrol 72 10/00 → 05/01

1.9 D Diesel 51 09/98 → 05/01

306 2 volumi /Coda spiovente (7A, 7C, N3, N5)

1.4 Petrol 55 10/00 → 05/01

1.6 Petrol 72 10/00 → 05/01

1.9 D Diesel 51 09/98 → 05/01

306 Break (7E, N3, N5)

1.4 Petrol 55 10/00 → 03/02

1.6 Petrol 72 10/00 → 03/02

1.9 D Diesel 51 09/98 → 04/02

306 Cabriolet (7D, N3, N5)

1.6 Petrol 72 10/00 → 04/02

406 (8B)

2.0 HDI 90 Diesel 66 02/99 → 05/99

406 Break (8E/F)

2.0 HDI 90 Diesel 66 02/99 → 05/99

BOXER Autobus (244, Z_)

2.0 Petrol 81 04/02 →

BOXER Furgonato (244)

2.0 Petrol 81 04/02 →

RANCH MPV / Space wagon (5F)

1.1 Petrol 44 09/00 → 08/02

1.4 Petrol 55 09/00 → 08/02

1.6 16V Petrol 80 07/01 → 08/02

RENAULT

CLIO II (BB0/1/2_, CB0/1/2_)

3.0 V6 Sport (CB1A) Petrol 166 11/00 → 12/02

SPA168

F1

**SENSORE TEMPERATURA REFRIGERANTE
COOLANT TEMPERATURE SENSOR**



KW



FORD

RANGER (ER, EQ)

2.5 D Diesel 57 10/99 → 04/02

2.5 D 4x4 Diesel 57 10/99 → 04/02

2.5 TD 4x4 Diesel 80 10/99 → 06/06

JAGUAR

XJ (X300)

12 6.0 Petrol 229 11/94 → 07/97

LEXUS

ES (F1, F2)

300 Petrol 138 09/91 → 12/97

GS (JZS147)

300 Petrol 156 03/93 → 08/97

LS (UCF10)

400 Petrol 180 12/89 → 12/94

LS (UCF20)

400 Petrol 194 12/94 → 08/97

MAZDA

121 II (DB)

1.3 16V Petrol 39 11/90 → 03/96

1.3 i 16V Petrol 53 11/90 → 03/96

3 (BK)

1.4 Petrol 59 02/04 → 06/09

1.4 Petrol 62 10/03 → 06/09

1.6 Petrol 77 10/03 → 06/09

3 Tre volumi (BK)

1.6 Petrol 77 02/04 →

323 F V (BA)

1.5 16V Petrol 65 07/94 → 09/96

1.8 16V Petrol 84 08/94 → 09/98

2.0 24V Petrol 106 08/94 → 09/98

323 F VI (BJ)

1.4 16V Petrol 54 09/98 → 01/01 ENGINE: → 229827

2.0 D Diesel 52 09/98 → 05/04 CHASSIS: 229828 →

2.0 TD Diesel 66 09/98 → 01/01 CHASSIS: 229828 →

SPA168

MAZDA
323 F VI (BJ)

2.0 TD	Diesel	74	01/01 → 05/04
--------	--------	----	---------------

323 S V (BA)

1.3 16V	Petrol	54	08/94 → 09/98
---------	--------	----	---------------

1.5 16V	Petrol	65	08/94 → 09/98
---------	--------	----	---------------

1.8 16V	Petrol	84	08/94 → 09/98
---------	--------	----	---------------

323 S VI (BJ)

1.4 16V	Petrol	54	09/98 → 01/01	ENGINE: → 229827
---------	--------	----	---------------	------------------

2.0 D	Diesel	52	09/98 → 05/04	CHASSIS: 229828 →
-------	--------	----	---------------	-------------------

2.0 TD	Diesel	66	09/98 → 05/04	CHASSIS: 229828 →
--------	--------	----	---------------	-------------------

5 (CR19)

2.0 CD	Diesel	105	06/05 →
--------	--------	-----	---------

2.0 CD	Diesel	81	03/05 →
--------	--------	----	---------

6 (GG)

2.0 DI	Diesel	100	06/02 → 08/07
--------	--------	-----	---------------

2.0 DI	Diesel	105	06/05 → 08/07
--------	--------	-----	---------------

2.0 DI	Diesel	89	08/02 → 08/07
--------	--------	----	---------------

6 Hatchback (GG)

2.0 DI	Diesel	100	08/02 → 08/07
--------	--------	-----	---------------

2.0 DI	Diesel	105	06/05 → 08/07
--------	--------	-----	---------------

2.0 DI	Diesel	89	08/02 → 08/07
--------	--------	----	---------------

6 Station Wagon (GY)

2.0 DI	Diesel	100	08/02 → 08/07
--------	--------	-----	---------------

2.0 DI	Diesel	105	06/05 → 08/07
--------	--------	-----	---------------

2.0 DI	Diesel	89	08/02 → 08/07
--------	--------	----	---------------

626 IV (GE)

1.8 i	Petrol	77	01/92 → 04/97
-------	--------	----	---------------

2.0 D GLX Complex	Diesel	55	12/95 → 04/97
----------------------	--------	----	---------------

2.0 i	Petrol	85	01/92 → 04/97
-------	--------	----	---------------

626 IV Hatchback (GE)

1.8	Petrol	77	08/91 → 04/97
-----	--------	----	---------------

2.0 D GLX Complex	Diesel	55	12/95 → 04/97
----------------------	--------	----	---------------

2.0 i	Petrol	85	08/91 → 04/97
-------	--------	----	---------------

2.5 24V	Petrol	120	08/94 → 04/97
---------	--------	-----	---------------

2.5 24V	Petrol	121	01/92 → 04/97
---------	--------	-----	---------------

B-SERIE (UF)

2.5 D	Diesel	63	02/96 → 06/99
-------	--------	----	---------------

2.5 D 4WD	Diesel	57	09/98 → 06/99
-----------	--------	----	---------------

2.5 D 4WD	Diesel	63	02/96 → 06/99
-----------	--------	----	---------------

B-SERIE (UN)

2.5 D	Diesel	57	06/99 →
-------	--------	----	---------

2.5 D	Diesel	62	12/02 →
-------	--------	----	---------

2.5 D 4WD	Diesel	57	06/99 →
-----------	--------	----	---------

SPA168

MAZDA
B-SERIE (UN)

2.5 D 4WD	Diesel	62	12/02 →
-----------	--------	----	---------

2.5 TD 4WD	Diesel	80	06/99 → 07/06
------------	--------	----	---------------

DEMIO (DW)

1.3 16V	Petrol	46	01/00 → 02/03
---------	--------	----	---------------

1.5 16V	Petrol	55	04/00 → 02/03
---------	--------	----	---------------

E-SERIE Furgonato (SR2)

E2200 D	Diesel	52	02/97 → 08/02
---------	--------	----	---------------

E2200 D 4WD	Diesel	52	02/97 → 05/03
-------------	--------	----	---------------

MPV II (LW)

2.0 DI	Diesel	100	07/02 → 02/06
--------	--------	-----	---------------

MX-3 (EC)

1.6 i	Petrol	79	01/94 →
-------	--------	----	---------

1.8 i V6	Petrol	98	01/92 → 01/94
----------	--------	----	---------------

MX-5 I (NA)

1.8	Petrol	96	02/94 → 04/98
-----	--------	----	---------------

MX-6 (GE)

2.0	Petrol	85	02/92 → 02/97
-----	--------	----	---------------

2.5 24V	Petrol	121	02/92 → 02/97
---------	--------	-----	---------------

2.5 i 24V	Petrol	120	08/94 → 02/97
-----------	--------	-----	---------------

PREMACY (CP)

1.9	Petrol	74	07/99 → 03/05
-----	--------	----	---------------

1.9	Petrol	84	07/99 → 03/05
-----	--------	----	---------------

2.0 TD	Diesel	66	10/99 → 07/00
--------	--------	----	---------------

PREMACY (CP)

2.0 TD	Diesel	74	07/00 → 03/05
--------	--------	----	---------------

XEDOS 6 (CA)

1.6 16V	Petrol	79	06/94 → 10/99
---------	--------	----	---------------

1.6 16V	Petrol	83	08/92 → 05/94
---------	--------	----	---------------

2.0 V6	Petrol	103	06/94 → 10/99
--------	--------	-----	---------------

2.0 V6	Petrol	106	01/92 → 05/94
--------	--------	-----	---------------

XEDOS 9 (TA)

2.0 24V	Petrol	105	08/93 → 01/00
---------	--------	-----	---------------

2.3 24V	Petrol	155	02/95 → 01/00
---------	--------	-----	---------------

2.5 24V	Petrol	123	07/93 → 07/00
---------	--------	-----	---------------

MINI
MINI (R50, R53)

One D	Diesel	55	06/03 → 09/06
-------	--------	----	---------------

SUBARU
JUSTY II (JMA, MS)

1.3 GX 4x4	Petrol	50	10/95 → 09/96
------------	--------	----	---------------

SUZUKI
ALTO III (EF)

1.0	Petrol	39	09/94 → 06/02
-----	--------	----	---------------

SPA168



KW



SUZUKI

CAPPUCINO (EA)

0.7 (EA11) Petrol 47 02/92 → 08/95

GRAND VITARA I (FT, GT)

2.0 TD Diesel 64 03/98 → 07/03

SAMURAI (SJ)

1.3 (SJ 413) Petrol 47 01/90 → 12/04

1.3 Trazione integrale (SJ 413) Petrol 51 01/90 → 12/04

SWIFT Cabriolet (SF413)

1.3 i (SF413, AK35) Petrol 50 01/92 → 09/95

SWIFT II 2 volumi /Coda spiovente (EA, MA)

1.0 i (SF310, AA44) Petrol 39 01/95 → 12/05

1.0 i (SF310, AA44) Petrol 40 03/89 → 12/91

1.3 (SF413, AB35) Petrol 50 01/92 → 05/01 CHASSIS: →x00250000

1.3 4WD (SF413, AA35) Petrol 50 01/92 → 05/01 CHASSIS: →x00250000

SWIFT II Tre volumi (AH, AJ)

1.3 (SF413, AH35, MA) Petrol 50 01/92 → 05/01 CHASSIS: →x00250000

VITARA (ET, TA)

1.6 i 16V Trazione integrale (ET, TA02) Petrol 71 07/90 → 03/98

1.6 Trazione integrale (ET) Petrol 60 07/88 → 12/91

1.6 Trazione integrale (TA, TA01) Petrol 59 07/88 → 03/98

VITARA Cabrio (ET, TA)

1.6 i 16V Petrol 71 07/90 → 03/99

TOYOTA

4 RUNNER (RN10_, VZN13_, VZN10_, RN13_)

3.0 V6 (VZN 130) Petrol 105 07/90 → 11/95

AVENSIS (_T22_)

1.6 (AT220_) Petrol 74 09/97 → 10/00

1.6 (AT220_) Petrol 81 09/97 → 10/00

1.6 VVT-i Petrol 81 10/00 → 02/03

1.8 (AT221_) Petrol 81 09/97 → 10/00

1.8 VVT-i Petrol 95 10/00 → 02/03

2.0 (ST220_) Petrol 94 09/97 → 10/00

SPA168



KW



TOYOTA

AVENSIS (_T22_)

2.0 D-4D (CDT220_) Diesel 81 10/99 → 02/03

2.0 TD (CT220_) Diesel 66 09/97 → 02/03

2.0 VVT-i Petrol 110 10/00 → 02/03

AVENSIS Liftback (_T22_)

1.6 (AT220_) Petrol 74 09/97 → 10/00

1.6 (AT220_) Petrol 81 09/97 → 10/00

1.6 VVT-i Petrol 81 10/00 → 02/03

1.8 (AT221_) Petrol 81 09/97 → 10/00

1.8 VVT-i Petrol 95 10/00 → 02/03

2.0 (ST220_) Petrol 94 09/97 → 10/00

2.0 D-4D (CDT220_) Diesel 81 10/99 → 02/03

2.0 TD (CT220_) Diesel 66 09/97 → 02/03

2.0 VVT-i Petrol 110 10/00 → 02/03

AVENSIS Station Wagon (_T22_)

1.6 (AT220_) Petrol 74 09/97 → 10/00

1.6 (AT220_) Petrol 81 09/97 → 10/00

1.6 VVT-i Petrol 81 10/00 → 02/03

1.8 (AT221_) Petrol 81 09/97 → 10/00

1.8 VVT-i Petrol 95 10/00 → 02/03

2.0 (ST220_) Petrol 94 09/97 → 10/00

2.0 D-4D (CDT220_) Diesel 81 10/99 → 02/03

2.0 TD (CT220_) Diesel 66 09/97 → 02/03

2.0 VVT-i Petrol 110 10/00 → 02/03

CAMRY (_V2_)

2.0 Turbo-D (CV20_) Diesel 62 08/88 → 05/91

2.0 Turbo-D (CV20_) Diesel 63 11/88 → 05/91

2.5 V6 GXI (VZV21_) Petrol 118 02/88 → 05/91

CAMRY Station Wagon (_V2_)

2.0 Turbo-D (CV20_) Diesel 62 08/88 → 05/91

2.0 Turbo-D (CV20_) Diesel 63 11/88 → 05/91

CARINA E (_T19_)

1.6 GLI (AT190) Petrol 79 04/92 → 09/97

2.0 GLI (ST191) Petrol 98 04/92 → 09/97

2.0 GTi 16V (ST191_) Petrol 129 03/94 → 09/97

SPA168

TOYOTA
CARINA E Sportswagon (_T19_)

1.6 GLI (AT190_)	Petrol	79	01/93 → 09/97
------------------	--------	----	---------------

CARINA E Tre volumi (_T19_)

1.6 16V (AT190_)	Petrol	85	12/94 → 09/97
------------------	--------	----	---------------

2.0 GTi 16V (ST191_)	Petrol	129	03/94 → 09/97
----------------------	--------	-----	---------------

CARINA II (_T17_)

1.6 (AT171)	Petrol	66	08/88 → 11/89
-------------	--------	----	---------------

1.6 (AT171)	Petrol	75	12/87 → 03/92
-------------	--------	----	---------------

2.0 GLI (ST171)	Petrol	89	12/87 → 03/92
-----------------	--------	----	---------------

CARINA II Station Wagon (_T17_)

1.6 (AT171)	Petrol	66	08/88 → 12/89
-------------	--------	----	---------------

1.6 (AT171)	Petrol	75	12/87 → 03/92
-------------	--------	----	---------------

CARINA II Tre volumi (_T17_)

1.6 (AT171)	Petrol	66	08/88 → 08/90
-------------	--------	----	---------------

1.6 (AT171)	Petrol	75	12/87 → 03/92
-------------	--------	----	---------------

2.0 GLI (ST171)	Petrol	89	12/87 → 03/92
-----------------	--------	----	---------------

CELICA (AT16_, ST16_)

1.6 GT 16V	Petrol	91	08/88 → 08/89
------------	--------	----	---------------

CELICA (ST20_, AT20_)

1.8 i 16V (AT200/ST)	Petrol	85	11/93 → 11/99
----------------------	--------	----	---------------

2.0 i 16V (ST202/GT)	Petrol	129	11/93 → 11/99
----------------------	--------	-----	---------------

2.0 i Turbo 4WD (ST205)	Petrol	178	02/94 → 11/99
-------------------------	--------	-----	---------------

CELICA 2 volumi /Coda spiovente (ST16_, AT16_)

1.6 GT	Petrol	85	08/88 → 08/89
--------	--------	----	---------------

2.0 GT	Petrol	103	08/88 → 08/89
--------	--------	-----	---------------

2.0 GT	Petrol	110	08/88 → 08/89
--------	--------	-----	---------------

CELICA Cabriolet (AT18_, ST18_)

2.0 GTi (ST182)	Petrol	115	10/89 → 11/93
-----------------	--------	-----	---------------

2.0 i 16V	Petrol	125	11/93 → 08/99
-----------	--------	-----	---------------

CELICA Cabriolet (ST16_, AT16_)

2.0 GT (ST162)	Petrol	103	08/88 → 08/89
----------------	--------	-----	---------------

2.0 GT (ST162)	Petrol	110	08/88 → 08/89
----------------	--------	-----	---------------

CELICA Coupé (AT18_, ST18_)

1.6 STi (AT180)	Petrol	77	10/89 → 11/93
-----------------	--------	----	---------------

2.0 GTi (ST182)	Petrol	115	10/89 → 11/93
-----------------	--------	-----	---------------

2.0 Turbo 4WD (ST185)	Petrol	150	10/89 → 11/93
-----------------------	--------	-----	---------------

2.0 Turbo 4WD (ST185)	Petrol	153	10/89 → 11/93
-----------------------	--------	-----	---------------

CELICA Coupé (ST16_, AT16_)

2.0 Turbo 4WD	Petrol	136	08/88 → 08/89
---------------	--------	-----	---------------

SPA168

TOYOTA
COROLLA (_E10_)

1.3 XLI (EE101_)	Petrol	55	09/95 → 04/97
------------------	--------	----	---------------

1.3 XLI 16V (EE101)	Petrol	65	07/92 → 09/95
---------------------	--------	----	---------------

1.6 Si (AE101_)	Petrol	84	09/95 → 04/97
-----------------	--------	----	---------------

2.0 D (CE100_)	Diesel	53	07/92 → 04/97
----------------	--------	----	---------------

COROLLA (_E11_)

1.6 (AE111_)	Petrol	81	04/97 → 02/00
--------------	--------	----	---------------

1.6 Aut. (AE111_)	Petrol	79	04/97 → 02/00
-------------------	--------	----	---------------

2.0 D (CE110_)	Diesel	53	04/97 → 02/00
----------------	--------	----	---------------

COROLLA (_E9_)

1.3 i (EE90)	Petrol	55	08/87 → 12/92
--------------	--------	----	---------------

1.6 i 4WD	Petrol	77	10/87 → 08/90
-----------	--------	----	---------------

COROLLA Compact (_E10_)

1.3 XLI (EE101_)	Petrol	55	09/95 → 04/97
------------------	--------	----	---------------

1.3 XLI 16V (EE101)	Petrol	65	07/92 → 09/95
---------------------	--------	----	---------------

1.6 Si (AE101_)	Petrol	84	07/92 → 04/97
-----------------	--------	----	---------------

1.8 GT (AE102_)	Petrol	86	11/92 → 05/95
-----------------	--------	----	---------------

2.0 D (CE100_)	Diesel	53	07/92 → 04/97
----------------	--------	----	---------------

COROLLA Compact (_E11_)

1.6 (AE111_)	Petrol	81	04/97 → 02/00
--------------	--------	----	---------------

1.6 Aut. (AE111_)	Petrol	79	04/97 → 02/00
-------------------	--------	----	---------------

2.0 D (CE110_)	Diesel	53	04/97 → 02/00
----------------	--------	----	---------------

COROLLA Compact (_E9_)

1.6 GTi (AE92, AE93)	Petrol	85	08/87 → 04/92
----------------------	--------	----	---------------

1.6 i (AE92)	Petrol	77	08/89 → 04/92
--------------	--------	----	---------------

COROLLA Liftback (_E10_)

1.3 XLI (EE101_)	Petrol	65	07/92 → 04/97
------------------	--------	----	---------------

1.6 GLI (AE101_)	Petrol	84	07/92 → 04/97
------------------	--------	----	---------------

1.8 GT (AE102_)	Petrol	86	11/92 → 05/95
-----------------	--------	----	---------------

2.0 D (CE100_)	Diesel	53	07/92 → 04/97
----------------	--------	----	---------------

COROLLA Liftback (_E11_)

1.6 (AE111_)	Petrol	81	04/97 → 02/00
--------------	--------	----	---------------

1.6 Aut. (AE111_)	Petrol	79	04/97 → 02/00
-------------------	--------	----	---------------

2.0 D (CE110)	Diesel	53	04/97 → 02/00
---------------	--------	----	---------------

COROLLA Liftback (_E9_)

1.3 i (EE90)	Petrol	55	08/87 → 04/92
--------------	--------	----	---------------

1.6 (AE92)	Petrol	77	08/89 → 04/92
------------	--------	----	---------------

COROLLA Station Wagon (_E9_)

1.6 XLI 4WD (AE95)	Petrol	77	08/88 → 06/92
--------------------	--------	----	---------------

COROLLA Wagon (_E11_)

1.6 (AE111_)	Petrol	81	04/97 → 02/00
--------------	--------	----	---------------

SPA168



KW



TOYOTA

COROLLA Wagon (_E11_)

1.6 Aut. (AE111_) Petrol 79 04/97 → 02/00

2.0 D (CE110_) Diesel 53 04/97 → 02/00

COROLLA Wagon (_E10_)

1.3 XLI (EE101_) Petrol 55 09/95 → 04/97

1.3 XLI 16V (EE101_) Petrol 65 07/92 → 09/95

COROLLA Wagon (_E10_)

1.6 Si (AE101_) Petrol 84 07/92 → 04/97

1.8 16V 4WD (AE103_) Petrol 81 09/95 → 04/97

2.0 D (CE100_) Diesel 53 07/92 → 04/97

HIACE III Furgonato (YH7_, LH6_, LH7_, LH5_, YH5_, YH6_)

2.4 Petrol 88 08/89 → 08/95

2.4 4WD Petrol 88 08/89 → 08/95

2.4 D 4WD Diesel 55 08/89 → 08/95

HIACE III Wagon (LH1_, RZH1_)

2.4 (RZH103) Petrol 88 08/89 → 08/95

2.4 4WD Petrol 88 08/89 → 08/95

2.4 D (LH102) Diesel 55 08/89 → 08/95

2.4 D 4WD Diesel 55 08/89 → 08/95

HIACE IV Autobus (LH1_)

2.4 (RCH12_, RCH22_) Petrol 85 08/95 → 04/98

2.4 4WD (RCH18_) Petrol 85 08/95 → 04/98

2.4 D Diesel 58 08/95 → 08/06

2.4 TD (LXH12_, LXH22_) Diesel 66 08/95 → 08/06

2.4 TD 4WD (H18/28) Diesel 66 08/95 → 08/06

2.7 (RCH13_, RCH23_) Petrol 105 04/98 → 11/01

2.7 4WD (RCH19_) Petrol 105 04/98 → 08/06

HIACE IV Furgonato (LXH1_, RZH1_, LH1_)

2.4 (RCH12_, RCH22_) Petrol 85 08/95 → 02/05

2.4 4WD (RCH18_, RCH28_) Petrol 85 08/95 → 04/98

2.4 D (LXH12_, LXH22_) Diesel 58 08/95 → 08/06

2.4 TD (LXH12_, LXH22_) Diesel 66 08/95 → 08/06

SPA168



KW



TOYOTA

HIACE IV Furgonato (LXH1_, RZH1_, LH1_)

2.4 TD 4WD (LXH18_, LXH28_) Diesel 66 08/95 → 08/06

2.7 (RCH13_, RCH23_) Petrol 105 04/98 → 08/06

2.7 4WD (RCH19_, RCH29_) Petrol 106 04/98 →

HILUX II Pick-up (RN6_, RN5_, LN6_, YN6_, YN5_, LN5_)

2.4 D Diesel 58 03/95 → 07/05

2.4 D Diesel 61 08/88 → 07/05

2.4 D 4WD Diesel 58 01/94 → 07/05

2.4 D 4WD Diesel 61 08/88 → 07/05

2.4 i 4WD Petrol 84 06/89 → 07/05

2.4 i 4WD Petrol 84 06/89 → 07/05

2.4 TD 4WD Diesel 66 08/98 → 01/02

LAND CRUISER (_J6_)

4.0 (FJ62_G) Petrol 115 08/87 → 12/89

LAND CRUISER (PZJ7_, KZJ7_, HZJ7_, BJ7_, LJ7_, RJ7_)

2.4 (RJ70_V, RJ73_V) Petrol 84 12/88 → 12/96

2.4 TD (LJ70) Diesel 66 01/90 → 05/93

3.0 TD (KZJ70_, KZJ73_, KZJ77_) Diesel 92 05/93 → 05/96

4.2 TD (HZJ7_ V) Diesel 96 01/90 →

LAND CRUISER 80 (_J8_)

4.2 D (HZJ80_) Diesel 99 01/90 → 12/97

4.2 TD (HDJ80) Diesel 118 10/92 → 12/97

4.2 TD (HDJ80) Diesel 123 01/90 → 12/97

LAND CRUISER Hardtop (_J7_)

2.4 TD (LJ77) Diesel 66 07/90 → 05/96

LAND CRUISER Hardtop (_J7_)

3.0 TD Diesel 92 05/93 → 05/96

LITEACE Autobus (_R2_ LG)

2.0 D (CR21LG) Diesel 53 01/92 → 05/94

2.2 (YR22LG) Petrol 72 01/92 → 01/95

LITEACE Autobus (CM30_G, KM30_G)

2.0 D (CM30LG) Diesel 53 08/88 → 01/92

LITEACE Furgonato (_R2_ V)

2.0 D (CR27_V) Diesel 51 01/92 → 05/94

2.2 (YR29LV) Petrol 72 01/92 → 01/95

LITEACE Furgonato (CM3_V, KM3_V)

2.0 D (CM36_V) Diesel 53 08/88 → 01/92

MR 2 II (SW2_)

2.0 16V (SW20) Petrol 115 12/89 → 05/00

SPA168

KW

TOYOTA
MR 2 III (ZZW3_)

1.8 16V VT-i (ZZW30)	Petrol	103	10/99 → 06/07
----------------------	--------	-----	---------------

PASEO Cabriolet (EL54)

1.5	Petrol	66	10/96 → 05/97
-----	--------	----	---------------

PASEO Coupé (EL54)

1.5 16V	Petrol	66	08/95 → 05/97
---------	--------	----	---------------

PICNIC (_XM10)

2.2 D (CMX10_)	Diesel	66	08/97 → 12/01
----------------	--------	----	---------------

PREVIA (TCR2_, TCR1_)

2.4	Petrol	97	05/90 → 08/00
-----	--------	----	---------------

PRIUS Tre volumi (NHW11_)

1.5	Petrol	53	05/00 → 01/04
-----	--------	----	---------------

RAV 4 I (SXA1_)

2.0 4WD	Petrol	95	06/94 → 06/00
---------	--------	----	---------------

RAV 4 I Cabrio (SXA1_)

2.0 16V 4WD	Petrol	94	12/97 → 06/00
-------------	--------	----	---------------

RAV 4 II (CLA2_, XA2_, ZCA2_, ACA2_)

1.8 VVTi	Petrol	92	08/00 → 11/05
----------	--------	----	---------------

2.0 VVTi 4WD	Petrol	110	06/00 → 11/05
--------------	--------	-----	---------------

STARLET (_P8_)

1.3 12V (EP81) Cat.	Petrol	55	12/89 → 03/96
---------------------	--------	----	---------------

1.5 D (NP80_)	Diesel	40	12/89 → 03/96
---------------	--------	----	---------------

STARLET (EP91)

1.3	Petrol	55	04/96 → 12/97
-----	--------	----	---------------

SUPRA (JZA70_, GA70_, MA70)

3.0 TURBO	Petrol	173	08/88 → 04/93
-----------	--------	-----	---------------

SUPRA (JZA70_, GA70_, MA70)

3.0 TURBO	Petrol	175	08/88 → 05/93
-----------	--------	-----	---------------

SUPRA (JZA80)

3.0 i Bi-Turbo	Petrol	243	05/93 → 08/02
----------------	--------	-----	---------------

VOLVO
S60 I

2.4	Petrol	103	01/03 → 04/10
-----	--------	-----	---------------

2.4	Petrol	125	01/03 → 04/10
-----	--------	-----	---------------

2.4 Bifuel (CNG)	Petrol/ CNG	103	01/03 → 04/10
------------------	----------------	-----	---------------

2.4 D	Diesel	96	12/01 → 04/10
-------	--------	----	---------------

2.4 D5	Diesel	120	07/01 → 04/10
--------	--------	-----	---------------

2.4 T	Petrol	147	01/02 → 04/10
-------	--------	-----	---------------

2.4 T AWD	Petrol	147	01/02 → 04/10
-----------	--------	-----	---------------

2.5 T	Petrol	154	02/04 → 04/10
-------	--------	-----	---------------

2.5 T AWD	Petrol	154	04/04 → 04/10
-----------	--------	-----	---------------

R 2,5 T AWD	Petrol	221	03/03 → 04/10
-------------	--------	-----	---------------

SPA168

KW

VOLVO
S60 I

T5	Petrol	184	01/02 → 04/10
----	--------	-----	---------------

S80 I (TS, XY)

2.4 D	Diesel	96	10/01 → 07/06
-------	--------	----	---------------

2.4 D5	Diesel	120	08/01 → 07/06
--------	--------	-----	---------------

V70 II (SW)

2.3 T5	Petrol	184	01/02 → 08/07
--------	--------	-----	---------------

2.4	Petrol	103	01/03 → 08/07
-----	--------	-----	---------------

2.4	Petrol	125	01/03 → 08/07
-----	--------	-----	---------------

2.4 Bifuel (CNG)	Petrol/ CNG	103	01/03 → 08/07
------------------	----------------	-----	---------------

2.4 D	Diesel	96	12/01 → 08/07
-------	--------	----	---------------

2.4 D5	Diesel	120	08/01 → 08/07
--------	--------	-----	---------------

2.4 T	Petrol	147	01/02 → 08/07
-------	--------	-----	---------------

2.4 T AWD	Petrol	147	01/02 → 08/07
-----------	--------	-----	---------------

2.5 T	Petrol	154	04/04 → 08/07
-------	--------	-----	---------------

2.5 T AWD	Petrol	154	09/02 → 08/07
-----------	--------	-----	---------------

R 2,5 T AWD	Petrol	221	03/03 → 08/07
-------------	--------	-----	---------------

XC70 CROSS COUNTRY

2.4 D5 XC AWD	Diesel	120	09/02 → 08/07
---------------	--------	-----	---------------

2.4 T XC AWD	Petrol	147	01/02 → 09/02
--------------	--------	-----	---------------

2.5 T XC AWD	Petrol	154	09/02 → 08/07
--------------	--------	-----	---------------

XC90 I

2.5 T	Petrol	154	10/02 →
-------	--------	-----	---------

D5	Diesel	120	10/02 →
----	--------	-----	---------

SPA169
F1
**SENSORE TEMPERATURA REFRIGERANTE
COOLANT TEMPERATURE SENSOR**

KW

DACIA
LOGAN (LS_)

1.5 dCi (LS0J, LS0Y)	Diesel	48	09/05 →
----------------------	--------	----	---------

SPA169



KW



DACIA

LOGAN (LS_)

1.5 dCi (LS0K) Diesel 50 01/06 →

1.5 dCi (LS0W) Diesel 63 09/07 →

LOGAN MCV (KS_)

1.5 dCi (KS0K) Diesel 50 02/07 →

1.5 dCi (KS0W) Diesel 63 09/07 →

MITSUBISHI

CARISMA (DA_)

1.9 DI-D Diesel 85 09/00 → 06/06

1.9 DI-D (DA5A) Diesel 75 09/00 → 06/06

CARISMA Tre volumi (DA_)

1.9 DI-D Diesel 85 09/00 → 06/06

1.9 DI-D (DA5A) Diesel 75 09/00 → 06/06

SPACE STAR (DG_A)

1.9 DI-D Diesel 85 10/02 → 12/04

1.9 DI-D (DG4A) Diesel 75 02/01 → 12/04

NISSAN

ALMERA II (N16)

1.5 dCi Diesel 60 01/03 →

ALMERA II Hatchback (N16)

1.5 dCi Diesel 60 01/03 →

dCi 100 Diesel 73 11/03 →

dCi 120 Diesel 84 07/02 →

dCi 80 Diesel 60 07/02 →

dCi 90 Diesel 66 07/02 →

INTERSTAR Furgonato (X70)

dCi 100 Diesel 73 11/03 →

dCi 120 Diesel 84 07/02 →

dCi 80 Diesel 60 07/02 →

dCi 90 Diesel 66 07/02 →

INTERSTAR Pianale piatto/Telaio

dCi 100 Diesel 73 02/04 →

dCi 120 Diesel 84 08/03 →

KUBISTAR (X76)

1.5 dCi Diesel 42 08/03 →

1.5 dCi Diesel 45 08/05 →

1.5 dCi Diesel 48 08/03 →

1.5 dCi Diesel 60 08/03 →

1.5 dCi 70 Diesel 50 04/06 →

1.5 dCi 85 Diesel 62 04/06 →

MICRA III (K12)

1.5 dCi Diesel 48 01/03 → 06/10

1.5 dCi Diesel 50 06/05 → 06/10

1.5 dCi Diesel 60 09/03 → 06/10

1.5 dCi Diesel 63 06/05 → 06/10

SPA169



KW



NISSAN

NOTE (E11)

1.5 dCi Diesel 50 03/06 →

1.5 dCi Diesel 63 03/06 →

PRIMASTAR Autobus (X83)

dCi 140 Diesel 99 07/03 →

dCi 80 Diesel 60 03/01 →

PRIMASTAR Furgonato (X83)

dCi 140 Diesel 99 07/03 →

dCi 80 Diesel 60 09/02 →

PRIMERA (P12)

1.9 dCi Diesel 88 04/03 →

PRIMERA Hatchback (P12)

1.9 dCi Diesel 88 04/03 →

PRIMERA Station wagon (WP12)

1.9 dCi Diesel 88 04/03 →

QASHQAI / QASHQAI +2 (J10, JJ10)

1.5 dCi Diesel 78 02/07 →

TIIDA 2 volumi /Coda spiovente (C11X)

1.5 dCi Diesel 78 09/07 →

TIIDA Tre volumi (SC11X)

1.5 dCi Diesel 78 09/07 →

OPEL

MOVANO Combi (J9)

1.9 DTI Diesel 59 09/00 → 10/01

1.9 DTI Diesel 60 10/01 →

2.2 DTI Diesel 66 09/00 →

2.5 DTI Diesel 84 10/01 →

MOVANO Furgonato (F9)

1.9 DTI Diesel 59 09/00 → 10/01

1.9 DTI Diesel 60 10/01 →

2.2 DTI Diesel 66 09/00 →

2.5 DTI Diesel 84 10/01 →

MOVANO Pianale piatto/Telaio (U9, E9)

2.2 DTI Diesel 66 09/00 →

2.5 DTI Diesel 84 10/01 →

MOVANO Ribaltabile (H9)

2.2 DTI Diesel 66 09/00 →

VIVARO Combi (J7)

1.9 DI Diesel 60 08/01 →

1.9 DTI Diesel 74 08/01 →

VIVARO Furgonato (F7)

1.9 DTI Diesel 74 08/01 →

RENAULT

AVANTIME (DE0_)

2.2 dCi (DE01) Diesel 110 05/02 → 05/03

SPA169

RENAULT
CLIO II (BB0/1/2_, CB0/1/2_)

1.5 dCi	Diesel	74	01/04 →
1.5 dCi (B/CB07)	Diesel	48	06/01 →
1.5 dCi (B/CB08)	Diesel	60	06/01 →
1.9 dTi (B/CB0U)	Diesel	59	12/99 → 05/05

CLIO II Furgonato (SB0/1/2_)

1.5 dCi (SB07)	Diesel	48	06/01 →
----------------	--------	----	---------

CLIO III (BR0/1, CR0/1)

1.5 dCi (BR0H, CR0H)	Diesel	78	06/05 →
----------------------	--------	----	---------

1.5 dCi (BR17, CR17)	Diesel	63	06/05 →
----------------------	--------	----	---------

1.5 dCi (C/BR1G)	Diesel	50	06/05 →
------------------	--------	----	---------

ESPACE III (JE0_)

1.9 dTi (JE0M)	Diesel	72	02/99 → 10/02
----------------	--------	----	---------------

2.2 dCi (JE0K)	Diesel	95	10/00 → 10/02
----------------	--------	----	---------------

ESPACE IV (JK0/1_)

1.9 dCi (JK0U, JK0G)	Diesel	88	11/02 →
----------------------	--------	----	---------

2.2 dCi (JK0H)	Diesel	110	11/02 →
----------------	--------	-----	---------

GRAND SCÉNIC II (JM0/1_)

1.5 dCi (JM02, JM13)	Diesel	74	04/04 →
----------------------	--------	----	---------

KANGOO (KC0/1_)

1.5 dCi	Diesel	50	06/05 →
---------	--------	----	---------

1.5 dCi	Diesel	62	06/05 →
---------	--------	----	---------

1.5 dCi (KC07)	Diesel	48	12/01 →
----------------	--------	----	---------

1.5 dCi (KC08, KC09)	Diesel	60	07/02 →
----------------------	--------	----	---------

1.9 dCi 4x4 (KC0V)	Diesel	59	10/01 →
--------------------	--------	----	---------

1.9 dTi (KC0U)	Diesel	59	02/00 →
----------------	--------	----	---------

D 65 1.9 (KC0E, KC02, KC0J, KC0N)	Diesel	47	08/97 →
-----------------------------------	--------	----	---------

KANGOO Express (FC0/1_)

1.5 dCi (FC07, FC1R)	Diesel	48	12/01 →
----------------------	--------	----	---------

1.5 dCi (FC08, FC09)	Diesel	60	04/03 →
----------------------	--------	----	---------

1.5 dCi (FC1G)	Diesel	62	06/05 →
----------------	--------	----	---------

1.5 dCi (FC1R)	Diesel	42	12/02 →
----------------	--------	----	---------

1.9 dCi 4x4 (FC0V)	Diesel	59	10/01 →
--------------------	--------	----	---------

1.9 dTi (FC0U)	Diesel	59	02/00 →
----------------	--------	----	---------

SPA169

RENAULT
KANGOO Express (FC0/1_)

D 65 1.9 (FC0E, FC02, FC0J, FC0N)	Diesel	47	08/97 →
-----------------------------------	--------	----	---------

LAGUNA I (B56_, 556_)

1.9 dCi (B56W)	Diesel	79	09/99 → 03/01
----------------	--------	----	---------------

1.9 dTi (B56J)	Diesel	72	10/97 → 03/01
----------------	--------	----	---------------

LAGUNA I Grandtour (K56_)

1.9 dCi (K56W)	Diesel	79	09/99 → 03/01
----------------	--------	----	---------------

1.9 dTi (K56J)	Diesel	72	10/97 → 03/01
----------------	--------	----	---------------

LAGUNA II (BG0/1_)

1.6 16V (BG1G, BG1H)	Petrol	82	02/05 →
----------------------	--------	----	---------

1.9 dCi (BG08, BG0G)	Diesel	88	03/01 →
----------------------	--------	----	---------

1.9 dCi (BG0R)	Diesel	74	10/01 →
----------------	--------	----	---------

1.9 dCi (BG1A, BG1V)	Diesel	96	05/05 →
----------------------	--------	----	---------

1.9 dCi (BG1A, BG1W)	Diesel	81	01/05 →
----------------------	--------	----	---------

2.2 dCi (BG0F)	Diesel	110	10/01 →
----------------	--------	-----	---------

LAGUNA II Grandtour (KG0/1_)

1.6 16V	Petrol	82	02/05 →
---------	--------	----	---------

1.9 dCi (KG0E, KG0R)	Diesel	74	10/01 →
----------------------	--------	----	---------

1.9 dCi (KG1A, KG1W)	Diesel	81	01/05 →
----------------------	--------	----	---------

1.9 dCi (KG1V)	Diesel	96	05/05 →
----------------	--------	----	---------

2.2 dCi (KG0F)	Diesel	110	10/01 →
----------------	--------	-----	---------

MASTER II Autobus (JD)

1.9 dCi 80	Diesel	60	11/01 →
------------	--------	----	---------

1.9 DTI	Diesel	59	09/00 →
---------	--------	----	---------

2.2 dCi 90	Diesel	66	09/00 →
------------	--------	----	---------

2.5 dCi 120	Diesel	84	10/01 →
-------------	--------	----	---------

MASTER II Furgonato (FD)

1.9 dCi 80	Diesel	60	11/01 →
------------	--------	----	---------

1.9 DTI	Diesel	59	09/00 →
---------	--------	----	---------

2.2 dCi 90	Diesel	66	09/00 →
------------	--------	----	---------

2.5 dCi 120	Diesel	84	10/01 →
-------------	--------	----	---------

MASTER II Pianale piatto/Telaio (ED/HD/UD)

2.2 dCi 90	Diesel	66	09/00 →
------------	--------	----	---------

2.5 dCi 120	Diesel	84	10/01 →
-------------	--------	----	---------

SPA169



RENAULT

MEGANE I (BA0/1_)

1.9 dCi (BA05, BA1F)	Diesel	75	02/01 → 08/03
1.9 dTi (BA08, BA0N)	Diesel	72	03/97 → 02/01
1.9 dTi (BA1U)	Diesel	59	02/01 → 08/03

MEGANE I Classic (LA0/1_)

1.9 dCi (LA05, LA1F)	Diesel	75	02/01 → 08/03
1.9 dTi (LA08, LA0N)	Diesel	72	03/97 → 02/01
1.9 dTi (LA1U)	Diesel	59	02/01 → 08/03

MEGANE I Coach (DA0/1_)

1.9 dCi (DA05, DA1F)	Diesel	75	02/01 → 08/03
1.9 dTi (DA0N)	Diesel	72	03/97 → 02/01

MEGANE I Grandtour (KA0/1_)

1.9 dCi (KA05, KA1F)	Diesel	75	02/01 → 08/03
1.9 dTi (KA0N)	Diesel	72	03/99 → 02/01
1.9 dTi (KA1U)	Diesel	59	02/01 → 08/03

MEGANE II (BM0/1_, CM0/1_)

1.4 16V (BM0B, CM0B)	Petrol	72	02/05 →
1.5 dCi	Diesel	63	05/05 →
1.5 dCi	Diesel	74	10/03 →
1.5 dCi	Diesel	78	05/05 →
1.5 dCi (BM0F, CM0F)	Diesel	60	11/02 →
1.6 16V (BM0C, CM0C)	Petrol	83	02/05 →
1.9 dCi	Diesel	68	03/04 →
1.9 dCi (BM0G, CM0G)	Diesel	88	11/02 →

MEGANE II Coupé-Cabriolet (EM0/1_)

1.6	Petrol	83	02/05 →
1.9 dCi	Diesel	88	09/03 →

MEGANE II Station wagon (KM0/1_)

1.4	Petrol	72	02/05 →
1.5 dCi	Diesel	60	08/03 →
1.5 dCi	Diesel	63	05/05 →
1.5 dCi	Diesel	74	02/04 →
1.5 dCi (KM16, KM1E)	Diesel	78	05/05 →
1.6	Petrol	83	02/05 →

SPA169



RENAULT

MEGANE II Station wagon (KM0/1_)

1.9 dCi	Diesel	68	03/04 →
1.9 dCi	Diesel	88	08/03 →

MEGANE II Tre volumi (LM0/1_)

1.4	Petrol	72	02/05 →
1.5 dCi	Diesel	60	09/03 →
1.5 dCi	Diesel	63	05/05 →
1.5 dCi	Diesel	74	02/04 →
1.5 dCi	Diesel	78	05/05 →
1.6	Petrol	83	02/05 →
1.9 dCi	Diesel	68	03/04 →
1.9 dCi (LM0G, LM1G, LM2C)	Diesel	88	09/03 →

MODUS / GRAND MODUS (F/JP0_)

1.4 (JP01, JP0J)	Petrol	72	12/04 →
1.5 dCi (FP0E, JP0E)	Diesel	48	12/04 →
1.5 dCi (FP0F, JP0F)	Diesel	63	12/04 →
1.5 dCi (FP0G, JP0G)	Diesel	50	12/04 →
1.5 dCi (JP0G, JP0H)	Diesel	78	05/05 →
1.6 (JP03, JP0B, JP0U, JP0Y, JP1G)	Petrol	82	12/04 →

SCÉNIC I (JA0/1_)

1.9 dCi (JA05, JA1F)	Diesel	75	09/99 → 08/03
1.9 dCi RX4	Diesel	75	11/00 → 08/03
1.9 dTi (JA0N)	Diesel	72	09/99 → 08/03
1.9 dTi (JA1U)	Diesel	59	02/01 → 08/03

SCÉNIC II (JM0/1_)

1.4 (JM0B, JM0H, JM1A)	Petrol	72	02/05 →
1.5 dCi (JM02, JM13)	Diesel	74	11/03 →
1.5 dCi (JM0F)	Diesel	60	06/03 →
1.5 dCi (JM1E)	Diesel	78	05/05 →
1.5 dCi (JM1F)	Diesel	63	05/05 →
1.6 (JM0C, JM0J, JM1B)	Petrol	83	02/05 →
1.9 dCi (JM0G, JM12, JM1G, JM2C)	Diesel	88	06/03 →

SPA169

KW

RENAULT
THALIA I (LB0/1/2_)

1.5 dCi	Diesel	48	04/02 →
1.5 dCi	Diesel	60	06/01 →

TRAFIC II Autobus (JL)

1.9 dCi 100 (JLOC)	Diesel	74	03/01 →
1.9 dCi 80 (JLOB)	Diesel	60	03/01 →
2.5 dCi 135 (JLOD)	Diesel	99	05/03 →

TRAFIC II Furgonato (FL)

1.9 dCi 100 (FLOC)	Diesel	74	03/01 →
1.9 dCi 80 (FLOB)	Diesel	60	03/01 →
2.5 dCi 135 (FLOD)	Diesel	99	05/03 →

VEL SATIS (BJ0_)

2.2 dCi (BJ0E, BJ0F)	Diesel	110	06/02 →
----------------------	--------	-----	---------

SUZUKI
GRAND VITARA II (JT)

1.9 DDiS	Diesel	95	10/05 →
----------	--------	----	---------

JIMNY (FJ)

1.5 DDiS 4WD	Diesel	48	12/03 →
1.5 DDiS 4x4	Diesel	63	08/05 →

VOLVO
S40 I (VS)

1.9 DI	Diesel	75	07/00 → 12/03
1.9 DI	Diesel	85	07/00 → 12/03

V40 Station wagon (VW)

1.9 DI	Diesel	75	07/00 → 06/04
1.9 DI	Diesel	85	07/00 → 06/04

SPA170
F1
**SENSORE TEMPERATURA REFRIGERANTE
COOLANT TEMPERATURE SENSOR**

KW

FORD
COUGAR (EC_)

2.5 ST 200	Petrol	151	01/00 → 08/00
2.5 V6 24V	Petrol	125	06/00 → 08/00
2.5 V6 24V	Petrol	125	08/98 → 08/00

COURIER Furgonato (F3L, F5L)

1.3	Petrol	44	09/91 → 02/96
1.3	Petrol	44	02/96 →
1.8 D	Diesel	44	02/96 →

ESCORT '95 Furgonato (AVL)

1.8 Turbo D	Diesel	51	12/95 → 06/01
-------------	--------	----	---------------

ESCORT CLASSIC (AAL, ABL)

1.8 TD	Diesel	66	10/98 → 07/00
--------	--------	----	---------------

ESCORT CLASSIC Turnier (ANL)

1.8 TD	Diesel	66	02/99 → 07/00
--------	--------	----	---------------

ESCORT V (GAL)

1.4	Petrol	52	07/90 → 09/92
1.6	Petrol	77	07/90 → 12/92
RS 2000	Petrol	110	05/91 → 12/92

ESCORT V Cabriolet (ALL)

1.4	Petrol	52	07/90 → 12/92
1.6	Petrol	77	07/90 → 12/92

ESCORT V Station wagon (GAL, AVL)

1.4	Petrol	52	07/90 → 09/92
1.6	Petrol	77	07/90 → 09/92

ESCORT VI (GAL)

1.4	Petrol	52	09/92 → 01/95
RS 2000	Petrol	110	09/92 → 01/95
RS 2000 4x4	Petrol	110	08/93 → 01/95

ESCORT VI Cabriolet (ALL)

1.4	Petrol	52	12/92 → 04/94
1.4 i	Petrol	55	07/93 → 01/95

ESCORT VI Station wagon (GAL)

1.4	Petrol	55	01/94 → 01/95
1.4	Petrol	52	09/92 → 01/95

SPA170



KW



FORD

ESCORT VI Tre volumi (GAL)

1.4	Petrol	52	08/93 → 04/94
1.4	Petrol	55	08/93 → 01/95

ESCORT VII (GAL, AAL, ABL)

1.3	Petrol	44	01/95 → 10/98
1.4	Petrol	55	01/95 → 10/98
1.6 16V	Petrol	66	01/95 → 04/98
1.6 16V 4x4	Petrol	66	01/95 → 04/98
1.6 i 16V	Petrol	65	01/95 → 08/95
1.8 16V	Petrol	77	01/95 → 08/95
1.8 16V	Petrol	85	01/95 → 04/98
1.8 TD	Diesel	66	01/95 → 10/98
1.8 Turbo D	Diesel	51	12/95 → 10/98
RS 2000	Petrol	110	02/95 → 02/98
RS 2000 4x4	Petrol	110	02/95 → 10/98
RS Cosworth 4x4	Petrol	162	02/95 → 10/98

ESCORT VII Cabriolet (ALL)

1.4	Petrol	55	02/95 → 08/98
1.6 16V XR3i	Petrol	65	02/95 → 12/96
1.6 16V XR3i	Petrol	66	02/95 → 04/98
1.8 16V XR3i	Petrol	77	02/95 → 04/98
1.8 16V XR3i	Petrol	85	10/95 → 04/98
1.8 16V XR3i	Petrol	96	02/95 → 08/00
1.8 TD	Diesel	66	09/95 → 08/98

ESCORT VII Station wagon (GAL, ANL)

1.3	Petrol	44	01/95 → 01/99
1.4	Petrol	55	01/95 → 02/99
1.6 16V	Petrol	66	01/95 → 04/98
1.6 i 16V	Petrol	65	01/95 → 08/95
1.8 16V	Petrol	77	01/95 → 08/95
1.8 16V	Petrol	85	01/95 → 04/98
1.8 TD	Diesel	66	01/95 → 02/99
1.8 Turbo D	Diesel	51	12/95 → 02/99

ESCORT VII Tre volumi (GAL, AFL)

1.3	Petrol	44	01/95 → 02/99
1.4	Petrol	55	01/95 → 02/99
1.6 i 16V	Petrol	65	01/95 → 08/95
1.6 i 16V	Petrol	66	01/95 → 04/98
1.8 16V	Petrol	77	01/95 → 08/95
1.8 16V	Petrol	85	01/95 → 04/98
1.8 TD	Diesel	66	01/95 → 02/99
1.8 Turbo D	Diesel	51	12/95 → 02/99

FIESTA Furgonato (JV_)

D 1.8	Diesel	44	05/98 →
-------	--------	----	---------

SPA170



KW



FORD

FIESTA III (GFJ)

1.1	Petrol	37	03/89 → 08/95
1.3 Cat.	Petrol	44	05/91 → 08/95
1.4	Petrol	52	03/89 → 12/95
1.8 XR2i 16V	Petrol	96	02/92 → 12/95

FIESTA V (JH_, JD_)

1.25 16V	Petrol	51	03/03 → 06/08
1.25 16V	Petrol	55	05/02 → 06/08
1.4 16V	Petrol	59	11/01 → 06/08
1.6 16V	Petrol	74	11/01 → 06/08

FOCUS C-MAX

1.6	Petrol	74	10/03 → 03/07
1.6 Ti	Petrol	85	08/04 → 03/07

FOCUS II (DA_)

1.4	Petrol	59	11/04 →
1.6	Petrol	74	11/04 →
1.6 Ti	Petrol	85	11/04 →

FOCUS II Station wagon (DA_)

1.4	Petrol	59	11/04 →
1.6	Petrol	74	11/04 →
1.6 Ti	Petrol	85	11/04 →

FOCUS II Tre volumi (DA_)

1.4	Petrol	59	04/05 →
1.6	Petrol	74	04/05 →
1.6 Ti	Petrol	85	04/05 →

FUSION (JU_)

1.25	Petrol	55	08/04 →
1.4	Petrol	59	08/02 →
1.6	Petrol	74	08/02 →

GALAXY (WGR)

2.3 16V	Petrol	103	09/01 → 05/06
---------	--------	-----	---------------

KA (RB_)

1.3 i	Petrol	36	06/98 → 11/08
-------	--------	----	---------------

MONDEO I (GBP)

1.6 i 16V	Petrol	65	09/95 → 08/96
1.6 i 16V	Petrol	66	09/95 → 08/96
1.8 i 16V	Petrol	82	09/95 → 08/96
1.8 i 16V	Petrol	85	09/95 → 08/96
1.8 i 16V 4x4	Petrol	85	09/95 → 08/96
2.0 i 16V	Petrol	100	09/95 → 08/96
2.0 i 16V	Petrol	97	09/95 → 08/96
2.0 i 16V 4x4	Petrol	97	09/95 → 08/96
2.5 i 24V	Petrol	125	08/95 → 08/96

SPA170

FORD
MONDEO I Station wagon (BNP)

1.6 i 16V	Petrol	66	09/95 → 08/96
1.8 i 16V	Petrol	82	09/95 → 08/96
1.8 i 16V	Petrol	85	09/95 → 08/96
1.8 i 16V 4x4	Petrol	85	09/95 → 08/96
2.0 i 16V	Petrol	100	09/95 → 08/96
2.0 i 16V	Petrol	97	09/95 → 08/96
2.0 i 16V 4x4	Petrol	100	09/95 → 08/96
2.0 i 16V 4x4	Petrol	97	09/95 → 08/96
2.5 i 24V	Petrol	125	08/95 → 08/96

MONDEO I Tre volumi (GBP)

1.6 i 16V	Petrol	65	09/95 → 08/96
1.6 i 16V	Petrol	66	09/95 → 08/96
1.8 i 16V	Petrol	82	09/95 → 08/96
1.8 i 16V	Petrol	85	09/95 → 08/96
2.0 i 16V	Petrol	100	09/95 → 08/96
2.0 i 16V 4x4	Petrol	97	09/95 → 08/96
2.5 i 24V	Petrol	125	08/95 → 08/96

PUMA (EC_)

1.4 16V	Petrol	66	11/97 → 10/00
---------	--------	----	---------------

SCORPIO II (GFR, GGR)

2.0 i 16V	Petrol	100	06/95 → 08/98
-----------	--------	-----	---------------

SCORPIO II Station wagon (GNR, GGR)

2.0 i 16V	Petrol	100	06/95 → 08/98
-----------	--------	-----	---------------

TRANSIT Autobus (E_ _)

2.5 DI (EBL, ECL, EDS, EDL)	Diesel	56	09/97 → 03/00
2.5 DI (EBL, EDL, EDS, ESL, ESS)	Diesel	85	09/97 → 03/00
2.5 DI (EBL, EDS, ESL, ESS, EUS)	Diesel	51	09/97 → 03/00
2.5 TD (EBL, EDL, EDS, EGL, ESL, ESS, EUS)	Diesel	63	09/97 → 03/00
2.5 TD (ECL, EDL, EDS, ESL, ESS, EUS)	Diesel	74	09/97 → 03/00

TRANSIT Furgonato (E_ _)

2.5 DI (EAL, EAS)	Diesel	51	09/97 → 03/00
2.5 DI (EAL, EAS)	Diesel	56	09/97 → 03/00
2.5 TD (EAL, EAS)	Diesel	63	09/97 → 03/00
2.5 TDI (EAL, EAS)	Diesel	74	09/97 → 03/00

SPA170

FORD
TRANSIT Pianale piatto/Telaio (E_ _)

2.5 DI (EME/L/S, ENE/L/S)	Diesel	56	09/97 → 03/00
2.5 DI (EML/S, ENL/S)	Diesel	51	09/97 → 03/00
2.5 TD (EME/L/S, ENE/L/S)	Diesel	63	09/97 → 03/00
2.5 TD (EME/L/S, ENE/L/S)	Diesel	74	09/97 → 03/00

MAZDA
121 III (JASM, JBSM)

1.25	Petrol	55	03/96 → 04/03
1.8 D	Diesel	44	03/96 → 04/03

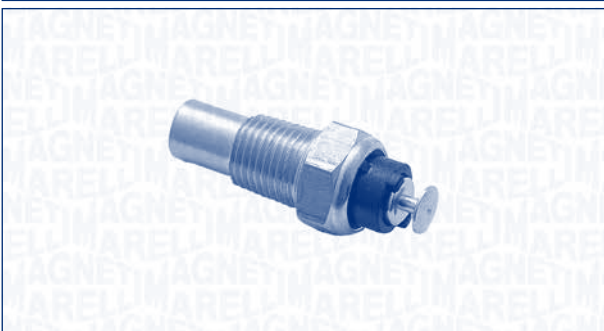
SPA171
**F1 SENSORE TEMPERATURA REFRIGERANTE
COOLANT TEMPERATURE SENSOR**

OPEL
AGILA (A) (H00)

1.0	Petrol	44	08/03 → 12/07
1.0 12V	Petrol	43	09/00 → 12/07
1.2 16V	Petrol	55	09/00 → 12/07
1.2 16V Twinport	Petrol	59	07/04 → 12/07

ANTARA

3.2 V6	Petrol	167	03/07 →
--------	--------	-----	---------

ASTRA F CLASSIC 2 volumi /Coda spiovente

1.2 i	Petrol	48	03/98 → 08/00
2.0 DI	Diesel	60	03/98 → 08/00

ASTRA G 2 volumi /Coda spiovente (F48_ , F08_)

1.2 16V	Petrol	55	09/00 → 01/05
1.4	Petrol	66	09/07 → 12/09
1.4 16V	Petrol	66	02/98 → 01/05
1.6	Petrol	76	12/02 → 12/09
1.6	Petrol	62	09/00 → 01/05

SPA171



KW



OPEL

ASTRA G 2 volumi /Coda spiovente (F48_, F08_)

1.6 16V	Petrol	74	02/98 → 01/05
1.7 CDTI	Diesel	59	04/03 → 12/09
2.0 DI	Diesel	60	02/98 → 01/05
2.0 DTI 16V	Diesel	74	08/99 → 01/05
2.0 OPC	Petrol	141	09/02 → 01/05
2.0 OPC	Petrol	147	11/02 → 01/05
2.2 DTI	Diesel	92	09/02 → 01/05

ASTRA G Cabriolet (F67)

1.6	Petrol	76	01/03 → 10/05
1.6 16V	Petrol	74	03/01 → 10/05
2.0 OPC	Petrol	141	03/02 → 10/05
2.2 DTI	Diesel	92	09/02 → 10/05

ASTRA G Coupé (F07_)

1.6 16V	Petrol	76	03/00 → 05/05
2.0 16V Turbo	Petrol	141	08/01 → 05/05
2.2 DTI	Diesel	92	09/02 → 05/05

ASTRA G Furgonato (F70)

1.6	Petrol	62	09/00 → 04/05
1.7 TD	Diesel	50	01/99 → 04/05
2.0 DI	Diesel	60	01/99 → 04/05

ASTRA G Station wagon (F35_)

1.2 16V	Petrol	55	09/00 → 07/04
1.4	Petrol	66	09/07 → 12/09
1.4 16V	Petrol	66	06/98 → 07/04
1.6	Petrol	76	12/02 → 07/09
1.6	Petrol	62	09/00 → 07/04
1.6 16V	Petrol	74	02/98 → 07/04
1.6 CNG	Petrol/ CNG	71	03/03 → 07/04
1.7 CDTI	Diesel	59	04/03 → 07/09
2.0 DI	Diesel	60	02/98 → 07/04
2.0 DTI 16V	Diesel	74	08/99 → 07/04
2.0 OPC	Petrol	141	09/02 → 07/04
2.2 DTI	Diesel	92	09/02 → 07/04

ASTRA G Tre volumi (F69_)

1.2 16V	Petrol	55	09/00 → 01/05
1.4	Petrol	66	09/07 → 12/09
1.4 16V	Petrol	66	09/98 → 01/05
1.6	Petrol	76	12/02 → 12/09
1.6	Petrol	62	09/00 → 01/05
1.6 16V	Petrol	74	09/98 → 01/05
1.7 CDTI	Diesel	59	04/03 → 12/09
2.0 DI	Diesel	60	09/98 → 01/05
2.0 DTI 16V	Diesel	74	08/99 → 01/05

SPA171



KW



OPEL

ASTRA G Tre volumi (F69_)

2.2 DTI	Diesel	92	09/02 → 01/05
---------	--------	----	---------------

ASTRA H (L48)

1.2	Petrol	48	10/06 →
1.2	Petrol	59	08/05 →
1.4	Petrol	59	04/04 → 10/04
1.6	Petrol	77	03/04 →
1.7 CDTI	Diesel	59	03/04 →
1.7 CDTI	Diesel	74	03/04 →
1.7 CDTI	Diesel	81	02/07 →
1.7 CDTI	Diesel	92	02/07 →
2.0 Turbo	Petrol	177	03/05 →

ASTRA H GTC (L08)

1.2	Petrol	48	10/06 →
1.2	Petrol	59	08/05 →
1.6	Petrol	77	03/05 →
1.7 CDTI	Diesel	59	03/05 →
1.7 CDTI	Diesel	74	03/05 →
1.7 CDTI	Diesel	81	02/07 →
1.7 CDTI	Diesel	92	02/07 →
2.0 Turbo	Petrol	177	08/05 →

ASTRA H Station wagon (L35)

1.6	Petrol	77	08/04 →
1.7 CDTI	Diesel	59	08/04 →
1.7 CDTI	Diesel	74	08/04 →
1.7 CDTI	Diesel	81	02/07 →
1.7 CDTI	Diesel	92	02/07 →

ASTRA H Tre volumi (L69)

1.7 CDTI	Diesel	74	02/07 →
1.7 CDTI	Diesel	81	02/07 →

ASTRA H TwinTop (L67)

1.6	Petrol	77	09/05 →
-----	--------	----	---------

ASTRA J

1.7 CDTI	Diesel	81	12/09 →
1.7 CDTI	Diesel	92	12/09 →
2.0 CDTi	Diesel	118	12/09 →

COMBO (71_)

1.2	Petrol	33	07/94 → 10/01
1.4	Petrol	44	07/94 → 10/01
1.4	Petrol	60	07/94 → 10/01
1.4 16V	Petrol	66	08/99 → 10/01

COMBO Cassone / Furgonato / Promiscuo

1.6	Petrol	64	10/01 →
1.6 CNG 16V	Petrol/ CNG	69	06/06 →

SPA171

KW

OPEL
COMBO Cassone / Furgonato / Promiscuo

1.6 CNG 16V Petrol/CNG 71 04/05 →

1.7 CDTI 16V Diesel 74 12/04 →

COMBO Tour

1.6 Petrol 64 10/01 →

1.6 CNG Petrol/CNG 69 06/06 →

1.6 CNG Petrol/CNG 71 04/05 →

1.7 CDTI 16V Diesel 74 12/04 →

CORSA B (73_, 78_, 79_)

1.4 i 16V Petrol 63 08/97 → 09/00

1.6 i 16V Petrol 74 08/97 → 09/00

CORSA B Furgonato (73_)

1.4 i Petrol 44 08/99 → 09/00

CORSA C (F08, F68)

1.0 Petrol 44 06/03 → 12/09

1.0 Petrol 43 09/00 → 12/09

1.2 Petrol 55 09/00 → 12/09

1.4 Petrol 66 09/00 → 12/09

1.4 Twinport Petrol 66 06/03 → 12/09

1.7 CDTI Diesel 74 06/03 → 12/09

CORSA C Furgonato (F08, W5L)

1.2 Petrol 59 07/05 →

1.2 16V Petrol 55 09/00 →

1.4 Petrol 66 08/03 →

CORSA D

1.0 Petrol 44 07/06 →

1.2 Petrol 59 07/06 →

1.2 LPG Petrol/LPG 59 09/09 →

1.4 LPG Petrol/LPG 66 07/06 →

1.7 CDTI Diesel 92 07/06 →

1.7 CDTI Diesel 96 06/10 →

FRONTERA B (6B_)

2.2 DTI Diesel 88 09/02 →

INSIGNIA

2.0 Biturbo CDTI Diesel 140 07/08 →

2.0 Biturbo CDTI 4x4 Diesel 140 05/09 →

INSIGNIA

2.0 CDTi Diesel 118 07/08 →

2.0 CDTi Diesel 81 07/08 →

SPA171

KW

OPEL
INSIGNIA

2.0 CDTi Diesel 96 07/08 →

2.0 CDTi 4x4 Diesel 118 06/10 →

2.8 V6 Turbo 4x4 Petrol 191 07/08 →

INSIGNIA Sports Tourer

2.0 Biturbo CDTI Diesel 140 07/08 →

2.0 Biturbo CDTI 4x4 Diesel 140 07/08 →

2.0 CDTi Diesel 118 07/08 →

2.0 CDTi Diesel 81 07/08 →

2.0 CDTi Diesel 96 07/08 →

2.0 CDTi 4x4 Diesel 118 06/10 →

2.8 V6 Turbo 4x4 Petrol 191 10/08 →

INSIGNIA Tre volumi

2.0 Biturbo CDTI Diesel 140 07/08 →

2.0 Biturbo CDTI 4x4 Diesel 140 07/08 →

2.0 CDTi Diesel 118 07/08 →

2.0 CDTi Diesel 81 07/08 →

2.0 CDTi Diesel 96 07/08 →

2.0 CDTi 4x4 Diesel 118 06/10 →

2.8 V6 Turbo 4x4 Petrol 191 07/08 →

MERIVA

1.4 16V Twinport Petrol 66 07/04 → 05/10

1.6 Petrol 64 05/03 → 05/10

1.6 Petrol 77 01/06 → 05/10

1.6 16V Petrol 74 05/03 → 01/06

1.7 CDTI Diesel 74 09/03 → 05/10

1.7 CDTI Diesel 92 09/06 → 05/10

MERIVA B

1.7 CDTI Diesel 74 06/10 →

1.7 CDTI Diesel 81 06/10 →

1.7 CDTI Diesel 96 06/10 →

OMEGA B (25_, 26_, 27_)

2.0 DTI 16V Diesel 74 09/97 → 09/00

2.2 16V Petrol 106 09/99 → 07/03

2.2 DTI 16V Diesel 81 09/00 → 07/03

2.2 DTI 16V Diesel 88 09/00 → 07/03

2.6 V6 Petrol 132 09/00 → 07/03

3.2 V6 Petrol 160 02/01 → 07/03

OMEGA B Station wagon (21_, 22_, 23_)

2.0 DTI 16V Diesel 74 09/97 → 09/00

2.2 16V Petrol 106 09/99 → 07/03

2.0 DTI 16V Diesel 74 09/97 → 09/00

2.2 16V Petrol 106 09/99 → 07/03

SPA171



OPEL

OMEGA B Station wagon (21_, 22_, 23_)

2.2 DTI 16V	Diesel	81	09/00 → 07/03
2.2 DTI 16V	Diesel	88	09/00 → 07/03
2.6	Petrol	138	05/94 → 05/99
2.6 V6	Petrol	132	09/00 → 07/03
3.2 V6	Petrol	160	02/01 → 07/03

SIGNUM

2.0 DTI	Diesel	74	05/03 →
2.0 Turbo	Petrol	129	05/03 →
2.2 DTI	Diesel	92	05/03 →
2.8 V6 Turbo	Petrol	169	09/05 →
2.8 V6 Turbo	Petrol	184	01/06 →
3.2 V6	Petrol	155	05/03 →

SPEEDSTER

2.0 Turbo	Petrol	147	04/03 →
-----------	--------	-----	---------

TIGRA (95_)

1.4 16V	Petrol	63	08/97 → 12/00
1.6 16V	Petrol	74	08/97 → 08/98

TIGRA TwinTop

1.4	Petrol	66	06/04 →
-----	--------	----	---------

VECTRA B (36_)

2.0 DTI 16V	Diesel	74	06/97 → 04/02
-------------	--------	----	---------------

VECTRA B 2 volumi /Coda spiovente (38_)

2.0 DTI 16V	Diesel	74	06/97 → 07/03
2.2 DTI 16V	Diesel	92	09/00 → 07/03
2.6 i V6	Petrol	125	09/00 → 07/03

VECTRA B Station wagon (31_)

2.0 DTI 16V	Diesel	74	06/97 → 07/03
2.2 DTI 16V	Diesel	92	09/00 → 07/03
2.6 i V6	Petrol	125	09/00 → 07/03

VECTRA C

1.6	Petrol	77	01/06 →
1.6 16V	Petrol	74	06/04 →
2.0 16V Turbo	Petrol	129	03/03 →
2.8 V6 Turbo	Petrol	169	08/05 →
2.8 V6 Turbo	Petrol	184	08/06 →
2.8 V6 Turbo	Petrol	188	08/05 →
3.2 V6	Petrol	155	08/02 →

VECTRA C GTS

1.6	Petrol	74	08/05 →
1.6	Petrol	77	01/06 →
2.0 16V Turbo	Petrol	129	03/03 →
2.8 V6 Turbo	Petrol	169	08/05 →
2.8 V6 Turbo	Petrol	184	08/06 →
2.8 V6 Turbo	Petrol	188	08/05 →

SPA171



OPEL

VECTRA C GTS

2.8 V6 Turbo	Petrol	206	08/06 →
3.2 V6	Petrol	155	08/02 →

VECTRA C Station wagon

1.6	Petrol	77	01/06 →
1.6 16V	Petrol	74	06/04 →
2.0 Turbo	Petrol	129	10/03 →
2.8 V6 Turbo	Petrol	169	08/05 →
2.8 V6 Turbo	Petrol	184	01/07 →
2.8 V6 Turbo	Petrol	188	08/05 →
2.8 V6 Turbo	Petrol	206	01/07 →
3.2 V6	Petrol	155	10/03 →

ZAFIRA A (F75_)

1.6 16V	Petrol	74	04/99 → 06/05
1.6 CNG	Petrol/ CNG	71	09/01 → 06/05
2.0 DI 16V	Diesel	60	10/99 → 06/05
2.2 DTI 16V	Diesel	92	01/02 → 06/05

ZAFIRA B (A05)

1.6	Petrol	77	07/05 →
1.6 CNG	Petrol/ CNG	69	01/06 →
1.7 CDTI	Diesel	81	01/08 →
1.7 CDTI	Diesel	92	01/08 →
2.0	Petrol	177	01/06 →

SPA172

F1

**SENSORE TEMPERATURA REFRIGERANTE
COOLANT TEMPERATURE SENSOR**



CITROËN

BERLINGO (MF)

1.6 HDI 75 (MF9HW)	Diesel	55	07/05 →
--------------------	--------	----	---------

SPA172

CITROËN
BERLINGO (MF)

1.6 HDi 90 (MF9HX)	Diesel	66	07/05 →	
2.0 HDi 90 (MFRHY)	Diesel	66	11/02 →	

BERLINGO Furgonato (M_)

2.0 HDi 90 (MBRHY, MCRHY)	Diesel	66	11/02 →	
2.0 HDi 90 4WD (MBRHY, MCRHY)	Diesel	66	11/02 →	

C1 (PM_, PN_)

1.4 HDi	Diesel	40	06/05 →	
---------	--------	----	---------	--

C2 (JM_)

1.4 HDi	Diesel	50	09/03 →	
---------	--------	----	---------	--

C3 I (FC_)

1.4 16V HDi	Diesel	66	02/02 →	
1.4 HDi	Diesel	50	02/02 →	
1.6 16V HDi	Diesel	80	09/05 →	

C3 Pluriel (HB_)

1.4 HDi	Diesel	50	04/04 →	
---------	--------	----	---------	--

C4 Coupé (LA_)

1.6 HDi	Diesel	66	11/04 →	
1.6 HDi	Diesel	80	11/04 →	

C4 I (LC_)

1.6 HDi	Diesel	66	11/04 →	
1.6 HDi	Diesel	80	11/04 →	
2.0 16V	Petrol	103	11/04 →	

C5 I (DC_)

2.0 HDi (DCRHYB)	Diesel	66	03/01 → 08/04	
2.0 HDi (DCRHZB, DCRHZE)	Diesel	80	03/01 → 08/04	
2.2 HDi (DC4HXB, DC4HXE)	Diesel	98	03/01 → 08/04	

C5 I Break (DE_)

2.0 HDi (DERHSB, DERHSE)	Diesel	79	06/01 → 08/04	
2.0 HDi (DERHYB)	Diesel	66	06/01 → 08/04	

SPA172

CITROËN
C5 I Break (DE_)

2.2 HDi (DE4HXB, DE4HXE)	Diesel	98	06/01 → 08/04	
--------------------------	--------	----	---------------	--

C5 II (RC_)

1.6 HDi (RC8HZB)	Diesel	80	09/04 →	
2.0 16V (RCRFJB, RCRFJC)	Petrol	103	09/04 →	

C5 II Break (RE_)

1.6 HDi (RE8HZB)	Diesel	80	09/04 →	
2.0 16V (RERFJB, RERFJC)	Petrol	103	09/04 →	

JUMPER Autobus (244, Z_)

2.2 HDi	Diesel	74	04/02 →	
---------	--------	----	---------	--

JUMPER Furgonato (244)

2.2 HDi	Diesel	74	04/02 →	
---------	--------	----	---------	--

JUMPER Pianale piatto/Telaio (244)

2.2 HDi	Diesel	74	04/02 →	
---------	--------	----	---------	--

XSARA (N1)

1.4 HDi	Diesel	50	01/03 → 03/05	
2.0 HDi 109	Diesel	80	05/01 → 03/05	
2.0 HDi 90	Diesel	66	09/00 → 03/05	

XSARA Break (N2)

1.4 HDi	Diesel	50	01/03 → 08/05	
2.0 HDi 109	Diesel	80	05/01 → 08/05	
2.0 HDi 90	Diesel	66	09/00 → 08/05	

XSARA Coupé (N0)

1.4 HDi	Diesel	50	01/03 → 03/05	
2.0 HDi 109	Diesel	80	05/01 → 03/05	
2.0 HDi 90	Diesel	66	09/00 → 03/05	

XSARA PICASSO (N68)

1.6 HDi	Diesel	80	05/04 →	
2.0 HDi	Diesel	66	12/99 →	

FIAT
SCUDO (270_)

1.6 D Multijet	Diesel	66	01/07 →	
2.0 D Multijet	Diesel	100	01/07 →	
2.0 D Multijet	Diesel	88	01/07 →	

SCUDO Furgonato (270_)

2.0 D Multijet	Diesel	100	01/07 →	
2.0 D Multijet	Diesel	88	01/07 →	

SPA172



KW



FIAT

SCUDO Pianale piatto/Telaio (270_)

1.6 D Multijet Diesel 66 01/07 →

2.0 D Multijet Diesel 100 01/07 →

ULYSSE (179AX)

2.0 D Multijet Diesel 100 05/06 → 06/11

2.0 D Multijet Diesel 88 05/06 → 06/11

2.0 JTD Diesel 79 05/03 → 08/06

FORD

FIESTA V (JH_, JD_)

1.4 TDCi Diesel 50 11/01 → 06/08

1.6 TDCi Diesel 66 11/04 → 06/08

FIESTA Van

1.4 TDCi Diesel 50 10/03 →

FIESTA VI

1.6 TDCi Diesel 66 06/08 →

FOCUS C-MAX

1.6 TDCi Diesel 66 02/05 → 03/07

1.6 TDCi Diesel 80 10/03 → 03/07

2.0 TDCi Diesel 100 10/03 → 03/07

FOCUS II (DA_)

1.6 TDCi Diesel 66 01/05 →

1.6 TDCi Diesel 80 11/04 →

2.0 TDCi Diesel 100 11/04 →

FOCUS II Station wagon (DA_)

1.6 TDCi Diesel 66 11/04 →

1.6 TDCi Diesel 80 11/04 →

2.0 TDCi Diesel 100 11/04 →

FOCUS II Tre volumi (DA_)

1.6 TDCi Diesel 66 04/05 →

1.6 TDCi Diesel 80 04/05 →

2.0 TDCi Diesel 100 04/05 →

FUSION (JU_)

1.4 TDCi Diesel 50 08/02 →

S-MAX (WA6)

2.0 TDCi Diesel 103 05/06 →

2.0 TDCi Diesel 85 11/07 →

2.0 TDCi Diesel 96 05/06 →

LANCIA

PHEDRA (179)

2.0 D Multijet Diesel 100 07/06 → 11/10

2.0 JTD Diesel 88 06/06 → 11/10

MAZDA

2 (DY)

1.4 CD Diesel 50 04/03 →

SPA172



KW



MAZDA

3 (BK)

1.6 DI Turbo Diesel 80 06/04 → 06/09

3 Tre volumi (BK)

1.6 DI Turbo Diesel 80 06/04 →

PEUGEOT

1007 (KM_)

1.4 HDi Diesel 50 04/05 →

1.6 HDi Diesel 80 06/07 →

107

1.4 HDi Diesel 40 06/05 →

206 2 volumi /Coda spiovente (2A/C)

1.4 HDi eco 70 Diesel 50 09/01 →

1.6 HDi 110 Diesel 80 05/04 →

206 CC (2D)

1.6 HDi 110 Diesel 80 04/05 →

206 SW (2E/K)

1.4 HDi Diesel 50 07/02 →

1.6 HDi 110 Diesel 80 05/04 →

207 (WA_, WC_)

1.4 HDi Diesel 50 02/06 →

1.6 HDi Diesel 66 02/06 →

1.6 HDi Diesel 80 02/06 →

207 CC (WD_)

1.6 HDi Diesel 80 02/07 →

207 SW (WK_)

1.6 HDi Diesel 80 06/07 →

307 (3A/C)

1.4 HDi Diesel 50 10/01 →

1.6 HDi Diesel 66 04/05 →

1.6 HDi 110 Diesel 80 06/05 →

2.0 16V Petrol 103 03/05 →

2.0 HDi 110 Diesel 79 08/00 →

2.0 HDi 135 Diesel 100 10/03 →

2.0 HDi 90 Diesel 66 08/00 →

307 Break (3E)

1.4 HDi Diesel 50 03/02 →

1.6 HDi Diesel 66 04/05 →

1.6 HDi 110 Diesel 80 06/05 →

2.0 16V Petrol 103 03/05 →

2.0 HDi 110 Diesel 79 03/02 →

2.0 HDi 135 Diesel 100 02/04 →

2.0 HDi 90 Diesel 66 03/02 →

307 CC (3B)

2.0 16V Petrol 103 03/05 →

2.0 HDi 135 Diesel 100 06/05 →

SPA172

KW

PEUGEOT
307 SW (3H)

1.6 HDi 110	Diesel	80	02/04 →
2.0 16V	Petrol	103	03/05 →
2.0 HDi 110	Diesel	79	03/02 →
2.0 HDi 135	Diesel	100	02/04 →
2.0 HDi 90	Diesel	66	03/02 →

308 (4A_, 4C_)

1.6 HDi	Diesel	66	09/07 →
1.6 HDi	Diesel	80	09/07 →
2.0 HDi	Diesel	100	09/07 →

308 SW

1.6 HDi	Diesel	66	09/07 →
1.6 HDi	Diesel	80	09/07 →
2.0 HDi	Diesel	100	09/07 →

4007 (GP_)

2.2 HDi	Diesel	115	02/07 →
---------	--------	-----	---------

406 (8B)

2.2 HDi	Diesel	98	03/00 → 05/04
---------	--------	----	---------------

406 Break (8E/F)

2.2 HDi	Diesel	98	03/00 → 10/04
---------	--------	----	---------------

406 Coupé (8C)

2.2 HDi	Diesel	98	03/00 → 12/04
---------	--------	----	---------------

407 (6D_)

1.6 HDi 110	Diesel	80	05/04 →
2.0 HDi 135	Diesel	100	05/04 →
2.2	Petrol	116	05/04 →

407 SW (6E_)

1.6 HDi 110	Diesel	80	05/04 →
2.0 HDi 135	Diesel	100	05/04 →
2.2	Petrol	116	05/04 →

607 (9D, 9U)

2.0 HDi	Diesel	80	05/00 →
2.2 16V	Petrol	116	12/04 →
2.2 HDi	Diesel	98	02/00 →

807 (E)

2.0 HDi	Diesel	100	06/06 →
2.2 HDi	Diesel	125	06/06 →

BIPPER (AA_)

1.4 HDi	Diesel	50	02/08 →
---------	--------	----	---------

EXPERT (224)

2.0 HDi 16V	Diesel	80	05/02 →
-------------	--------	----	---------

EXPERT Furgonato (222)

2.0 HDi	Diesel	80	05/02 →
---------	--------	----	---------

SPA172

KW

PEUGEOT
RANCH Furgonato (5)

2.0 HDi	Diesel	66	04/00 →
2.0 HDi 4x4	Diesel	66	04/04 →

RANCH MPV / Space wagon (5F)

2.0 HDi	Diesel	66	02/00 →
---------	--------	----	---------

SUZUKI
GRAND VITARA I (FT, GT)

2.0 HDi 110 16V	Diesel	80	07/01 → 09/05
-----------------	--------	----	---------------

LIANA (ER)

1.4 DDIS	Diesel	66	04/04 →
----------	--------	----	---------

LIANA Station wagon (ER)

1.4 DDIS	Diesel	66	04/04 → 12/07
----------	--------	----	---------------

TOYOTA
AYGO (WNB1_, KGB1_)

1.4 HDi (WNB10)	Diesel	40	07/05 → 08/10
-----------------	--------	----	---------------

VOLVO
C30

1.6 D	Diesel	80	10/06 → 12/12
2.0 D	Diesel	100	10/06 → 12/12

C70 II Cabriolet

2.0 D	Diesel	100	01/08 →
-------	--------	-----	---------

S40 II (MS)

1.6 D	Diesel	81	01/05 →
2.0 D	Diesel	100	01/04 →

V50 (MW)

1.6 D	Diesel	81	01/05 →
2.0 D	Diesel	100	04/04 →

V70 III (BW)

2.0 D	Diesel	100	10/07 →
-------	--------	-----	---------

SSA042

F2 TERMOCONTATTO - VENTOLA RADIATORE
FAN TEMPERATURE SWITCH



KW



OPEL

ASTRA F (56_, 57_)

1.4	Petrol	55	09/91 → 09/93
1.4	Petrol	60	09/92 → 09/98
1.4 i	Petrol	44	09/91 → 09/98
1.4 i 16V	Petrol	66	02/96 → 09/98
1.4 Si	Petrol	60	03/92 → 09/98
1.6	Petrol	55	09/95 → 09/98
1.6 i	Petrol	52	05/93 → 07/96
1.6 i	Petrol	55	03/92 → 09/98
1.6 i 16V	Petrol	74	08/94 → 09/98
1.6 Si	Petrol	74	05/92 → 12/94
1.7 D	Diesel	42	03/92 → 09/92
1.8 i	Petrol	66	03/92 → 09/98
1.8 i 16V	Petrol	92	06/93 → 10/94
1.8 i 16V	Petrol	85	11/94 → 09/98
2.0 i	Petrol	85	03/92 → 09/98
2.0 i 16V	Petrol	100	02/95 → 09/98

ASTRA F 2 volumi /Coda spiovente (53_, 54_, 58_, 59_)

1.4	Petrol	55	09/91 → 09/93
1.4	Petrol	60	09/92 → 01/98
1.4 i	Petrol	44	03/92 → 01/98
1.4 i 16V	Petrol	66	01/96 → 01/98
1.4 Si	Petrol	60	03/92 → 01/98
1.6	Petrol	55	09/95 → 01/98
1.6 i	Petrol	52	05/93 → 07/96
1.6 i	Petrol	55	09/91 → 01/98
1.6 i 16V	Petrol	74	08/94 → 01/98
1.6 Si	Petrol	74	03/92 → 12/94
1.8 i	Petrol	66	09/91 → 01/98
1.8 i 16V	Petrol	92	06/93 → 08/94
1.8 i 16V	Petrol	85	09/94 → 01/98
2.0 GSI 16V	Petrol	110	09/91 → 01/98
2.0 i	Petrol	85	09/91 → 01/98
2.0 i 16V	Petrol	100	02/95 → 01/98

SSA042



KW



OPEL

ASTRA F Cabriolet (53_B)

1.4 i 16V	Petrol	66	01/96 → 03/01
1.4 Si	Petrol	60	05/93 → 03/01
1.6 i	Petrol	52	03/93 → 08/96
1.6 i	Petrol	55	01/96 → 03/01
1.8 i 16V	Petrol	85	11/94 → 03/01
2.0 i	Petrol	85	03/93 → 10/94

ASTRA F Station wagon (51_, 52_)

1.4	Petrol	55	09/91 → 09/93
1.4	Petrol	60	09/92 → 01/98
1.4 i	Petrol	44	09/91 → 01/98
1.4 i 16V	Petrol	66	02/96 → 01/98
1.4 Si	Petrol	60	03/92 → 01/98
1.6	Petrol	55	09/95 → 01/98
1.6 i	Petrol	52	05/93 → 07/96
1.6 i	Petrol	55	09/91 → 01/98
1.6 i 16V	Petrol	74	08/94 → 01/98
1.6 Si	Petrol	74	03/92 → 12/94
1.8 i	Petrol	66	09/91 → 01/98
1.8 i 16V	Petrol	92	06/93 → 01/98
1.8 i 16V	Petrol	85	07/94 → 01/98
2.0 i	Petrol	85	09/91 → 07/94
2.0 i 16V	Petrol	100	02/95 → 01/98
2.0 i 16V	Petrol	110	03/93 → 01/98

ASTRA F Van (55_)

1.4 i	Petrol	44	10/91 → 01/99
1.6 i	Petrol	55	10/91 → 04/93
1.6 i	Petrol	52	02/93 → 07/96

CALIBRA A (85_)

2.0 i	Petrol	85	06/90 → 07/97
2.0 i 16V	Petrol	100	02/94 → 07/97
2.0 i 16V	Petrol	110	06/90 → 02/94
2.0 i 16V 4x4	Petrol	100	02/94 → 07/97
2.0 i 16V 4x4	Petrol	110	06/90 → 02/94
2.0 i 4x4	Petrol	85	06/90 → 07/97
2.0 i Turbo 4x4	Petrol	150	03/92 → 07/97

COMBO (71_)

1.2	Petrol	33	07/94 → 10/01
1.4	Petrol	44	07/94 → 10/01
1.4	Petrol	60	07/94 → 10/01
1.4 16V	Petrol	66	08/99 → 10/01
1.7 D	Diesel	44	07/94 → 10/01

CORSAA 2 volumi /Coda spiovente (93_, 94_, 98_, 99_)

1.0	Petrol	33	09/82 → 03/93	CHASSIS:K4000001 →
1.2	Petrol	33	09/82 → 08/90	CHASSIS:K4000001 →

SSA042

OPEL
CORSA A 2 volumi /Coda spiovente (93_, 94_, 98_, 99_)

1.2 S	Petrol	40	09/82 → 02/90	CHASSIS: K4000001 →
1.3 i	Petrol	44	09/86 → 09/90	CHASSIS: K4000001 →
1.3 S	Petrol	51	09/82 → 10/89	CHASSIS: K4000001 →
1.4 i	Petrol	40	01/85 → 03/93	CHASSIS: K4000001 →
1.4 i	Petrol	44	01/90 → 03/93	CHASSIS: K4000001 →
1.4 S	Petrol	53	01/90 → 03/93	CHASSIS: K4000001 →
1.4 Si	Petrol	60	09/91 → 03/93	CHASSIS: K4000001 →
1.5 TD	Diesel	49	03/88 → 03/93	CHASSIS: K4000001 →
1.6 GSI	Petrol	55	08/88 → 09/92	CHASSIS: K4000001 →
1.6 GSI	Petrol	72	09/89 → 03/93	CHASSIS: K4000001 →
1.6 GSI	Petrol	74	05/88 → 03/92	CHASSIS: K4000001 →

CORSA A TR (91_, 92_, 96_, 97_)

1.0	Petrol	33	09/82 → 09/92	CHASSIS: K4000001 →
1.2 i	Petrol	33	09/89 → 03/93	CHASSIS: K4000001 →
1.2 N	Petrol	33	01/85 → 10/87	CHASSIS: K4000001 →
1.2 S	Petrol	40	09/82 → 03/93	CHASSIS: K4000001 →
1.2 S	Petrol	43	09/82 → 10/87	CHASSIS: K4000001 →
1.3	Petrol	44	09/85 → 10/87	CHASSIS: K4000001 →
1.3 S	Petrol	51	09/82 → 10/87	CHASSIS: K4000001 →
1.4 i	Petrol	44	10/89 → 03/93	CHASSIS: K4000001 →
1.4 S	Petrol	53	09/89 → 03/93	CHASSIS: K4000001 →
1.5 TD	Diesel	49	10/87 → 03/93	CHASSIS: K4000001 →

CORSA B (73_, 78_, 79_)

1.2 i	Petrol	33	03/93 → 09/00	
1.2 i	Petrol	33	03/93 → 09/00	
1.2 i 16V	Petrol	48	03/98 → 09/00	
1.4 i	Petrol	44	03/93 → 09/00	
1.4 i 16V	Petrol	63	08/97 → 09/00	
1.4 i 16V	Petrol	66	09/94 → 09/00	
1.4 Si	Petrol	60	03/93 → 09/00	
1.5 D	Diesel	37	03/93 → 09/00	
1.5 TD	Diesel	49	03/93 → 09/00	
1.6 GSI 16V	Petrol	80	03/93 → 09/00	
1.6 i 16V	Petrol	78	09/94 → 09/00	
1.6 i 16V	Petrol	74	08/97 → 09/00	
1.7 D	Diesel	44	02/96 → 09/00	

CORSA B Furgonato (73_)

1.4 i	Petrol	44	08/99 → 09/00	
1.7 D	Diesel	44	08/99 → 09/00	

CORSA C (F08, F68)

1.7 DTI	Diesel	55	09/00 → 12/09	
---------	--------	----	---------------	--

KADETT E (39_, 49_)

1.8	Petrol	84	09/87 → 08/90	CHASSIS: J5273428 →
1.8 i	Petrol	85	09/84 → 08/86	CHASSIS: J5273428 →

SSA042

OPEL
KADETT E Cabriolet (43B_)

1.3 S	Petrol	55	03/87 → 02/93	CHASSIS: J5273428 →
1.4 i	Petrol	44	01/90 → 08/91	
1.4 S	Petrol	55	08/90 → 02/93	CHASSIS: J5273428 →
1.6 i	Petrol	60	07/89 → 02/93	CHASSIS: J5273428 →

KADETT E Combo (38_, 48_)

1.4 i	Petrol	44	08/91 → 07/94	CHASSIS: J5273428 →
1.4 S	Petrol	55	07/89 → 08/91	CHASSIS: J5273428 →
1.6 i	Petrol	55	08/91 → 07/94	CHASSIS: J5273428 →

KADETT E Furgonato (37_, 47_)

1.2	Petrol	40	09/84 → 07/86	CHASSIS: J5273428 →
1.3 N	Petrol	44	09/84 → 07/89	
1.4 i	Petrol	44	01/90 → 08/91	
1.6 D	Diesel	40	08/84 → 08/88	
1.6 i	Petrol	55	08/89 → 09/93	
1.7 D	Diesel	42	08/88 → 09/92	
1.8 i	Petrol	66	08/84 → 09/92	CHASSIS: J5273428 →

KADETT E Station wagon (35_, 36_, 45_, 46_)

1.8 i	Petrol	85	09/84 → 08/86	CHASSIS: J5273428 →
-------	--------	----	---------------	---------------------

OMEGA A (16_, 17_, 19_)

1.8	Petrol	65	09/87 → 03/94	CHASSIS: P1132204 →
1.8	Petrol	85	09/86 → 01/88	
1.8 N	Petrol	60	09/86 → 08/87	
1.8 S	Petrol	66	09/86 → 12/88	
2.0	Petrol	73	09/90 → 03/94	CHASSIS: P1132204 →
2.0	Petrol	74	09/90 → 03/94	CHASSIS: P1132204 →
2.0	Petrol	90	09/86 → 01/88	
2.0 i	Petrol	85	09/86 → 01/88	
2.3 D	Diesel	54	10/86 → 03/94	CHASSIS: K10000099 →
2.3 TD	Diesel	66	10/86 → 08/88	CHASSIS: K10000099 →
2.4 i	Petrol	92	09/88 → 03/94	
2.6 i	Petrol	110	09/90 → 03/94	
3.0 (3000)	Petrol	115	03/87 → 12/87	CHASSIS: P1132204 →
3.0 (3000)	Petrol	130	01/88 → 09/90	
3.0 24V (3000)	Petrol	147	09/89 → 03/94	CHASSIS: P1132204 →
3.6 24V Lotus	Petrol	277	08/90 → 09/92	CHASSIS: P1132204 →

OMEGA A Station wagon (66_, 67_)

1.8	Petrol	65	09/87 → 01/88	
1.8	Petrol	85	09/86 → 01/88	
1.8 N	Petrol	60	09/86 → 08/87	
1.8 S	Petrol	66	09/86 → 01/88	
2.0	Petrol	74	09/90 → 03/94	CHASSIS: P1132204 →
2.0	Petrol	90	09/86 → 03/94	CHASSIS: P1132204 →

SSA042



KW



OPEL

OMEGA A Station wagon (66_, 67_)

2.0 i	Petrol	73	09/90 → 03/94	CHASSIS: P1132204 →
2.0 i	Petrol	85	09/86 → 01/88	
2.3 D	Diesel	54	09/86 → 03/94	CHASSIS: K1000099 →
2.3 TD	Diesel	66	09/86 → 08/88	CHASSIS: K1000099 →
2.4 i	Petrol	92	09/88 → 03/94	
2.6 i	Petrol	110	09/90 → 03/94	
3.0	Petrol	115	01/88 → 03/94	
3.0	Petrol	130	01/88 → 09/90	CHASSIS: 0109242 →
3.0 24V	Petrol	147	09/89 → 03/94	CHASSIS: P1132204 →
3.0 Cat.	Petrol	130	01/88 → 03/94	CHASSIS: 0011335 →

OMEGA B (25_, 26_, 27_)

2.0	Petrol	85	03/94 → 09/99	
2.0	Petrol	85	03/94 → 12/00	
2.0 16V	Petrol	100	03/94 → 09/99	
2.2 16V	Petrol	106	09/99 → 07/03	
2.5 V6	Petrol	125	03/94 → 09/00	CHASSIS: T1003098 →
3.0 V6	Petrol	155	04/94 → 02/01	CHASSIS: T1003098 →

OMEGA B Station wagon (21_, 22_, 23_)

2.0	Petrol	85	03/94 → 09/99	
2.0 16V	Petrol	100	03/94 → 09/99	
2.5 V6	Petrol	125	03/94 → 09/00	CHASSIS: T1003098 →
3.0 V6	Petrol	155	04/94 → 02/01	CHASSIS: T1003098 →

SENATOR B (29_)

2.5 i	Petrol	103	09/90 → 09/93	CHASSIS: 0053436 →
2.6 i	Petrol	110	09/90 → 09/93	
3.0	Petrol	115	09/87 → 09/93	
3.0	Petrol	130	01/88 → 09/90	CHASSIS: 0109242 →
3.0 24V	Petrol	150	09/89 → 09/93	

SINTRA

2.2 DTI	Diesel	85	07/97 → 04/99	
---------	--------	----	---------------	--

TIGRA (95_)

1.4 16V	Petrol	66	07/94 → 12/00	
1.4 16V	Petrol	63	08/97 → 12/00	
1.6 16V	Petrol	78	07/94 → 08/98	
1.6 16V	Petrol	74	08/97 → 08/98	

VECTRA A (86_, 87_)

1.4 S	Petrol	55	09/88 → 06/92	
1.6	Petrol	60	09/88 → 05/93	
1.6 i	Petrol	52	09/93 → 11/95	
1.6 i	Petrol	55	09/88 → 11/95	
1.8 i Cat.	Petrol	66	03/90 → 11/95	CHASSIS: →L1000123
1.8 S	Petrol	65	09/88 → 07/89	CHASSIS: →L1000123
1.8 S 4x4	Petrol	65	01/89 → 07/89	CHASSIS: →L1000123
2.0 i	Petrol	85	09/88 → 10/90	CHASSIS: →L1000123

SSA042



KW



OPEL

VECTRA A (86_, 87_)

2.0 i	Petrol	95	09/88 → 09/92	CHASSIS: →L1000123
2.0 i 16V	Petrol	100	06/94 → 11/95	
2.0 i 16V 4x4	Petrol	100	06/94 → 11/95	
2.0 i 4x4	Petrol	85	01/89 → 10/90	CHASSIS: →L1000123
2.0 i 4x4	Petrol	95	01/89 → 09/92	CHASSIS: →L1000123

VECTRA A 2 volumi /Coda spiovente (88_, 89_)

1.4 S	Petrol	55	04/88 → 06/92	
1.6 i Cat.	Petrol	55	09/88 → 11/95	
1.6 S	Petrol	60	09/88 → 05/93	
1.8 i Cat.	Petrol	66	03/90 → 11/95	CHASSIS: →L1000123
1.8 S	Petrol	65	09/88 → 07/89	CHASSIS: →L1000123
2.0 i	Petrol	85	09/88 → 10/90	CHASSIS: →L1000123
2.0 i 16V	Petrol	100	06/94 → 11/95	
2.0 i GT	Petrol	95	09/88 → 11/95	CHASSIS: →L1000123

VECTRA B (36_)

1.6 i	Petrol	55	10/95 → 04/02	
1.6 i	Petrol	55	10/95 → 04/02	
1.6 i 16V	Petrol	74	10/95 → 04/02	

VECTRA B 2 volumi /Coda spiovente (38_)

1.6 i	Petrol	55	10/95 → 07/03	
1.6 i	Petrol	55	10/95 → 07/03	
1.6 i 16V	Petrol	74	10/95 → 07/02	

VECTRA B Station wagon (31_)

1.6 i	Petrol	55	11/96 → 06/00	
-------	--------	----	---------------	--

VAUXHALL

ASTRA Mk II 2 volumi /Coda spiovente

1.2	Petrol	44	09/84 → 08/91	CHASSIS: J2791968 →
1.3	Petrol	55	09/84 → 08/91	CHASSIS: J2791968 →
1.4 i	Petrol	44	01/90 → 08/91	CHASSIS: J2791968 →
1.4 S	Petrol	55	01/90 → 08/91	CHASSIS: J2791968 →
1.6	Petrol	60	09/84 → 08/91	CHASSIS: J2791968 →
1.6 S	Petrol	66	09/84 → 08/86	CHASSIS: J2791968 →
1.8 GTE	Petrol	82	09/84 → 08/91	CHASSIS: J2791968 →

ASTRA Mk II Belmont

1.3	Petrol	55	09/85 → 08/91	CHASSIS: J2791968 →
1.4 i	Petrol	44	01/90 → 12/91	CHASSIS: J2791968 →
1.6	Petrol	66	09/85 → 08/91	CHASSIS: J2791968 →
1.6 S	Petrol	60	01/89 → 12/91	CHASSIS: J2791968 →
1.8	Petrol	82	01/86 → 12/90	CHASSIS: J2791968 →
1.8 i	Petrol	85	09/85 → 08/91	CHASSIS: J2791968 →

ASTRA Mk II Cabriolet

1.6 i	Petrol	55	01/91 → 08/93	CHASSIS: J2791968 →
1.6 i	Petrol	60	01/87 → 12/91	CHASSIS: J2791968 →
1.6 i Cat.	Petrol	55	10/87 → 02/93	CHASSIS: J2791968 →

SSA042

OPEL
ASTRA Mk II Station wagon

1.2	Petrol	44	09/84 → 12/88	CHASSIS: J2791968 →
1.3	Petrol	55	09/84 → 08/91	CHASSIS: J2791968 →
1.4 S	Petrol	55	01/89 → 08/91	CHASSIS: J2791968 →
1.6	Petrol	60	09/84 → 08/91	CHASSIS: J2791968 →
1.6 S	Petrol	66	09/84 → 08/86	CHASSIS: J2791968 →
1.8 i	Petrol	83	01/90 → 08/91	CHASSIS: J2791968 →

ASTRA Mk III (F)

1.4 i	Petrol	60	04/92 → 09/98	
1.4 i	Petrol	44	04/92 → 09/98	
1.4 i 16V	Petrol	66	02/96 → 09/98	
1.6 i	Petrol	52	08/94 → 07/96	
1.6 i	Petrol	74	05/92 → 12/94	
1.6 i	Petrol	55	03/92 → 09/98	
1.6 i 16V	Petrol	74	08/94 → 09/98	
1.8 i	Petrol	66	03/92 → 09/98	
1.8 i 16V	Petrol	85	01/94 → 12/96	
1.8 i 16V	Petrol	92	06/93 → 10/94	
2.0 i	Petrol	85	03/92 → 09/98	
2.0 i 16V	Petrol	100	02/95 → 09/98	

ASTRA Mk III (F) 2 volumi /Coda spiovente

1.4 i	Petrol	60	03/92 → 02/98	
1.4 i	Petrol	44	09/91 → 02/98	
1.4 i 16V	Petrol	66	02/96 → 02/98	
1.4 S	Petrol	55	09/91 → 02/98	
1.6 i	Petrol	52	07/94 → 02/98	
1.6 i	Petrol	74	03/92 → 02/98	
1.6 i	Petrol	55	09/91 → 02/98	
1.8 i	Petrol	66	09/91 → 02/98	
1.8 i 16V	Petrol	85	09/94 → 02/98	
1.8 i 16V	Petrol	92	09/94 → 02/98	
2.0 i	Petrol	85	09/91 → 02/98	
2.0 i 16V	Petrol	100	01/94 → 02/98	
2.0 i 16V	Petrol	110	09/91 → 02/98	

ASTRA Mk III (F) Cabriolet

1.4 i	Petrol	60	05/93 → 03/01	
1.4 i 16V	Petrol	66	01/96 → 03/01	
1.6 i	Petrol	52	03/93 → 08/96	
1.6 i	Petrol	55	01/96 → 03/01	
1.8 16V	Petrol	85	11/94 → 03/01	
2.0 i	Petrol	85	03/93 → 10/94	

ASTRA Mk III (F) Station wagon

1.4 i	Petrol	60	03/91 → 02/98	
1.4 i	Petrol	44	09/91 → 02/98	
1.4 i 16V	Petrol	66	02/96 → 01/98	

SSA042

OPEL
ASTRA Mk III (F) Station wagon

1.4 S	Petrol	55	09/91 → 02/98	
1.6 i	Petrol	52	07/94 → 02/98	
1.6 i	Petrol	55	09/91 → 02/98	
1.6 i 16V	Petrol	74	01/94 → 02/98	
1.6 Si	Petrol	74	03/91 → 12/94	
1.8 i	Petrol	66	09/91 → 02/98	
1.8 i 16V	Petrol	85	09/94 → 02/98	
1.8 i 16V	Petrol	92	09/94 → 02/98	
2.0 i	Petrol	85	09/91 → 02/98	
2.0 i 16V	Petrol	100	01/94 → 02/98	

CARLTON Mk III

1.8	Petrol	65	09/87 → 03/94	CHASSIS: P1132204 →
1.8 i	Petrol	85	09/86 → 03/94	CHASSIS: P1132204 →
2.0 i	Petrol	90	09/86 → 03/94	CHASSIS: P1132204 →
3.0 3000	Petrol	130	01/88 → 09/90	CHASSIS: 0109242 →

CARLTON Mk III Station wagon

1.8	Petrol	65	09/87 → 03/94	CHASSIS: P1132204 →
1.8 i	Petrol	85	09/86 → 03/94	CHASSIS: P1132204 →
2.0 i	Petrol	90	09/86 → 03/94	CHASSIS: P1132204 →

COMBO Mk I (B)

1.2	Petrol	33	07/94 → 10/01	
1.4	Petrol	44	07/94 → 10/01	
1.4	Petrol	60	07/94 → 10/01	
1.7 D	Diesel	44	07/94 → 10/01	
1.2 i 16V	Petrol	48	03/98 → 09/00	

NOVA

1.4 S	Petrol	55	01/90 → 02/93	CHASSIS: K4000001 →
1.5 TD	Diesel	49	01/90 → 02/93	CHASSIS: K4000001 →

NOVA 2 volumi /Coda spiovente

1.0	Petrol	33	05/83 → 03/93	CHASSIS: K4000001 →
1.2 S	Petrol	40	05/83 → 02/90	CHASSIS: K4000001 →
1.2 S	Petrol	43	01/88 → 02/90	CHASSIS: K4000001 →
1.3 S	Petrol	51	05/83 → 10/89	CHASSIS: K4000001 →
1.4 S	Petrol	55	01/90 → 03/93	CHASSIS: K4000001 →
1.5 TD	Diesel	49	01/90 → 03/93	CHASSIS: K4000001 →
1.6 GSI	Petrol	74	05/88 → 03/92	CHASSIS: K4000001 →

NOVAVAN

1.2	Petrol	38	01/90 → 10/94	CHASSIS: K4000001 →
-----	--------	----	---------------	---------------------

SENATOR Mk II (B)

2.5 i	Petrol	103	09/87 → 10/90	CHASSIS: 0053436 →
3.0	Petrol	130	01/88 → 09/90	CHASSIS: 0109242 →
3.0 24V	Petrol	150	09/89 → 09/93	
3.0 i Cat.	Petrol	130	01/88 → 09/93	CHASSIS: 0011335 →

SSA042



KW



OPEL

SINTRA

2.2 DTI	Diesel	85	07/97 → 04/99
2.2 i 16 V	Petrol	104	11/96 → 04/99
3.0 i 24V	Petrol	148	11/96 → 04/99

VECTRA (B)

1.6 i	Petrol	55	08/95 → 10/01
1.6 i 16V	Petrol	74	08/95 → 10/01
1.8 i 16V	Petrol	85	10/95 → 09/00

VECTRA (B) 2 volumi /Coda spiovente

1.6 i	Petrol	55	08/95 → 10/01
1.6 i 16V	Petrol	74	08/95 → 10/01

VECTRA (B) Station wagon

1.6 i	Petrol	55	11/96 → 03/02
1.6 i 16V	Petrol	74	11/96 → 03/02

GRUPPO G - GROUP G

SAA102

**INTERRUTTORE PRESSIONE OLIO
OIL PRESSURE SWITCH**



KW



AUDI

100 (43, C2)

1.6	Petrol	63	08/76 → 07/82
1.9	Petrol	74	08/80 → 07/82
2.0	Petrol	85	06/76 → 08/78
2.0 D	Diesel	51	08/78 → 07/82
2.1	Petrol	100	03/77 → 07/82
2.1	Petrol	85	10/77 → 07/82

100 (44, 44Q, C3)

1.8	Petrol	55	08/82 → 12/87
1.8	Petrol	65	02/86 → 07/88
1.8 Cat.	Petrol	66	03/85 → 11/90
1.8 quattro	Petrol	65	08/86 → 07/90
1.8 quattro Cat.	Petrol	66	08/85 → 11/90

SAA102



KW



AUDI

100 (44, 44Q, C3)

1.9	Petrol	74	08/82 → 07/84
2.0	Petrol	83	08/86 → 11/87
2.0	Petrol	85	08/84 → 12/87
2.0 Cat.	Petrol	85	01/88 → 11/90
2.0 D	Diesel	51	08/82 → 07/88
2.0 D Turbo	Diesel	64	08/82 → 02/88
2.0 D Turbo	Diesel	74	03/88 → 11/90
2.1	Petrol	100	08/82 → 07/84
2.2	Petrol	101	08/84 → 12/88
2.2	Petrol	85	10/84 → 09/86
2.2 Cat.	Petrol	101	06/89 → 11/90
2.2 E quattro	Petrol	88	08/85 → 07/86
2.2 E Turbo quattro	Petrol	121	08/86 → 11/90
2.2 quattro	Petrol	101	08/84 → 12/88
2.2 quattro Cat.	Petrol	101	06/89 → 11/90
2.2 Turbo	Petrol	121	08/86 → 11/90
2.3 E	Petrol	100	10/86 → 11/90
2.3 E	Petrol	98	01/90 → 11/90
2.3 E quattro	Petrol	100	08/86 → 11/90
2.3 quattro	Petrol	98	01/90 → 11/90
2.4 D	Diesel	60	08/89 → 07/91
2.5 TDI	Diesel	88	01/90 → 11/90

100 (4A, C4)

2.0	Petrol	74	12/90 → 06/94
2.0 E	Petrol	85	12/90 → 06/94
2.0 E 16V	Petrol	103	01/92 → 06/94
2.0 E 16V quattro	Petrol	103	07/92 → 06/94
2.0 E quattro	Petrol	85	12/90 → 07/92
2.3 E	Petrol	98	12/90 → 06/94
2.3 E quattro	Petrol	98	12/90 → 06/94
2.4 D	Diesel	60	12/90 → 06/94
2.5 TDI	Diesel	85	12/90 → 06/94
2.6	Petrol	102	07/93 → 06/94
2.6	Petrol	110	03/92 → 06/94
2.6 quattro	Petrol	110	04/92 → 06/94
2.8 E	Petrol	128	12/90 → 06/94
2.8 E quattro	Petrol	128	12/90 → 06/94
S4 Turbo quattro	Petrol	169	08/91 → 06/94
S4 V8 quattro	Petrol	206	10/92 → 06/94
S4 V8 quattro	Petrol	213	03/94 → 06/94

SAA102

AUDI
100 (C1)

1.8	Petrol	63	09/71 → 07/73
1.8	Petrol	74	10/70 → 07/73
1.9	Petrol	82	09/71 → 07/73

100 Avant (43, C2)

1.6	Petrol	63	07/77 → 02/83
1.9	Petrol	74	08/80 → 07/82
2.0	Petrol	85	08/77 → 07/80
2.0 D	Diesel	51	08/78 → 02/83
2.1	Petrol	100	07/77 → 02/83
2.1	Petrol	85	07/77 → 02/83

100 Avant (44, 44Q, C3)

1.8	Petrol	55	08/82 → 12/87
1.8	Petrol	65	02/86 → 07/90
1.8	Petrol	66	08/83 → 07/89
1.8 Cat.	Petrol	66	03/85 → 11/90
2.0	Petrol	83	09/86 → 11/87
2.0 D	Diesel	51	03/83 → 11/90
2.0 E	Petrol	85	01/85 → 12/87
2.0 E Cat.	Petrol	85	01/88 → 11/90
2.0 TD	Diesel	64	03/83 → 10/87
2.0 TD	Diesel	74	03/88 → 11/90
2.1	Petrol	100	08/82 → 07/84
2.2	Petrol	101	08/84 → 12/88
2.2	Petrol	85	10/84 → 09/86
2.2 Cat.	Petrol	101	06/89 → 11/90
2.2 E quattro	Petrol	88	08/85 → 07/86
2.2 quattro	Petrol	101	08/84 → 12/88
2.2 quattro Cat.	Petrol	101	06/89 → 11/90
2.2 Turbo	Petrol	121	08/86 → 11/90
2.2 Turbo quattro	Petrol	121	08/86 → 11/90
2.3	Petrol	100	08/86 → 11/90
2.3	Petrol	98	03/90 → 11/90
2.3 E quattro	Petrol	100	08/86 → 11/90
2.3 quattro	Petrol	98	01/90 → 11/90
2.4 D	Diesel	60	08/89 → 11/90
2.5 TDI	Diesel	88	01/90 → 11/90

100 Avant (4A, C4)

2.0 E	Petrol	74	09/91 → 06/94
2.0 E	Petrol	85	09/91 → 06/94
2.0 E quattro	Petrol	85	12/90 → 07/92
2.3 E	Petrol	98	09/91 → 06/94
2.3 E quattro	Petrol	98	09/91 → 06/94
2.4 D	Diesel	60	12/90 → 06/94
2.5 TDI	Diesel	85	12/90 → 06/94

SAA102

AUDI
100 Avant (4A, C4)

2.6	Petrol	102	07/93 → 06/94
2.6	Petrol	110	03/92 → 06/94
2.6 quattro	Petrol	110	07/92 → 06/94
2.8 E	Petrol	128	09/91 → 06/94
2.8 E quattro	Petrol	128	09/91 → 06/94
S4 Turbo quattro	Petrol	169	09/91 → 06/94
S4 V8 quattro	Petrol	206	10/92 → 06/94
S4 V8 quattro	Petrol	213	03/94 → 06/94

200 (43)

2.1 5E	Petrol	100	10/79 → 09/82
2.1 5T	Petrol	125	10/79 → 08/82

200 (44, 44Q)

2.1 5E	Petrol	100	08/83 → 07/84
2.1 Turbo	Petrol	134	08/83 → 01/88
2.1 Turbo quattro	Petrol	134	08/83 → 09/86
2.2	Petrol	101	08/84 → 07/85
2.2 20V Turbo quattro	Petrol	162	03/89 → 12/90
2.2 Turbo	Petrol	121	08/85 → 09/91
2.2 Turbo	Petrol	140	02/88 → 12/90
2.2 Turbo	Petrol	147	02/88 → 12/90
2.2 Turbo quattro	Petrol	121	01/85 → 12/91
2.2 Turbo quattro	Petrol	147	02/88 → 11/90
2.3	Petrol	100	11/86 → 09/91

200 Avant (44, 44Q)

2.1 Turbo quattro	Petrol	134	09/83 → 01/88
2.2 20V Turbo quattro	Petrol	162	07/89 → 12/90
2.2 Turbo	Petrol	121	08/85 → 09/91
2.2 Turbo quattro	Petrol	121	09/83 → 12/90
2.2 Turbo quattro	Petrol	147	02/88 → 12/91
2.3	Petrol	100	11/86 → 09/91

50 (86)

1.1	Petrol	37	08/74 → 07/78
1.1	Petrol	44	08/74 → 07/77
1.3	Petrol	44	08/77 → 07/78

80 (81, 85, B2)

1.3	Petrol	40	09/78 → 07/81
1.3	Petrol	44	09/78 → 07/86
1.6	Petrol	54	02/86 → 07/86
1.6	Petrol	55	08/78 → 07/86
1.6	Petrol	63	08/78 → 02/83
1.6 D	Diesel	40	08/80 → 08/86
1.6 GLE	Petrol	81	01/79 → 12/86

SAA102



KW



AUDI

80 (81, 85, B2)

1.6 TD	Diesel	51	08/81 → 05/86
1.8	Petrol	65	02/86 → 07/86
1.8	Petrol	66	01/83 → 08/86
1.8 CC quattro (85Q)	Petrol	66	08/84 → 08/86
1.8 GTE	Petrol	82	10/84 → 08/86
1.8 GTE quattro (85Q)	Petrol	81	03/85 → 08/86
1.8 GTE quattro (85Q)	Petrol	82	08/84 → 08/86
2.0	Petrol	85	10/83 → 09/84
2.0 quattro (85Q)	Petrol	85	10/83 → 09/84
2.2 quattro (85Q)	Petrol	100	08/82 → 07/84

80 (89, 89Q, 8A, B3)

1.6	Petrol	51	08/87 → 09/91
1.6	Petrol	55	09/86 → 08/91
1.6 D	Diesel	40	09/86 → 08/91
1.6 TD	Diesel	59	09/86 → 08/91
1.8	Petrol	55	10/86 → 01/90
1.8	Petrol	83	09/86 → 07/88
1.8 E	Petrol	82	06/86 → 08/91
1.8 E quattro	Petrol	82	09/86 → 08/91
1.8 quattro	Petrol	83	09/86 → 08/90
1.8 S	Petrol	66	09/86 → 10/91
1.8 S	Petrol	65	09/86 → 12/90
1.8 S quattro	Petrol	65	09/86 → 07/90
1.8 S quattro	Petrol	66	09/86 → 09/91
1.9 D	Diesel	50	08/89 → 08/91
2.0	Petrol	82	10/90 → 08/91
2.0 E	Petrol	83	08/88 → 10/90
2.0 E 16V	Petrol	101	03/90 → 09/91
2.0 E 16V quattro	Petrol	101	03/90 → 08/91
2.0 E quattro	Petrol	83	08/88 → 09/90
2.0 quattro	Petrol	85	10/90 → 08/91
2.0 quattro	Petrol	82	08/88 → 07/90

80 (8C, B4)

1.6	Petrol	52	09/91 → 12/94
1.6 E	Petrol	74	06/93 → 12/94
1.9 TD	Diesel	55	09/91 → 12/94
1.9 TDI	Diesel	66	09/91 → 12/94
2.0	Petrol	66	09/91 → 12/94
2.0 E	Petrol	85	09/91 → 12/94
2.0 E 16V	Petrol	103	08/92 → 12/94
2.0 E 16V quattro	Petrol	103	04/92 → 12/94

SAA102



KW



AUDI

80 (8C, B4)

2.0 E quattro	Petrol	85	09/91 → 12/94
2.3 E	Petrol	98	09/91 → 12/94
2.3 E quattro	Petrol	98	09/91 → 12/94
2.6	Petrol	110	07/92 → 12/94
2.6 quattro	Petrol	110	06/92 → 12/94
2.8	Petrol	128	09/91 → 12/94
2.8 quattro	Petrol	128	09/91 → 12/94
S2 quattro	Petrol	169	02/93 → 12/94

80 Avant (8C, B4)

1.6 E	Petrol	74	06/93 → 01/96
1.9 TDI	Diesel	66	07/92 → 01/96
2.0	Petrol	66	07/92 → 01/96
2.0 E	Petrol	85	07/92 → 01/96
2.0 E 16V	Petrol	103	02/93 → 01/96
2.3 E	Petrol	98	07/92 → 01/96
2.3 E quattro	Petrol	98	09/91 → 11/94
2.6	Petrol	110	07/92 → 01/96
2.6 quattro	Petrol	110	07/92 → 07/95

80 Avant (8C, B4)

2.8	Petrol	128	09/91 → 01/96
2.8 quattro	Petrol	128	08/92 → 07/95
RS2 quattro (P1)	Petrol	232	03/94 → 05/95
S2 quattro	Petrol	169	02/93 → 07/95

90 (81, 85, B2)

1.6 TD	Diesel	51	10/85 → 01/87
2.0	Petrol	85	10/84 → 03/87
2.2	Petrol	100	10/84 → 03/87
2.2	Petrol	85	01/85 → 03/87
2.2 E quattro	Petrol	100	11/84 → 03/87
2.2 E quattro	Petrol	88	08/85 → 03/87

90 (89, 89Q, 8A, B3)

1.6 TD	Diesel	59	04/87 → 09/91
2.0	Petrol	85	07/88 → 09/91
2.0 20 V	Petrol	118	08/89 → 07/91
2.0 20 V quattro	Petrol	118	08/88 → 09/91
2.2 E	Petrol	100	04/87 → 07/91
2.2 E quattro	Petrol	100	04/87 → 09/91
2.3 E	Petrol	100	04/87 → 07/91
2.3 E	Petrol	98	04/87 → 09/91
2.3 E 20V	Petrol	123	04/90 → 07/91
2.3 E 20V	Petrol	125	08/88 → 07/91
2.3 E 20V quattro	Petrol	123	04/90 → 09/91
2.3 E 20V quattro	Petrol	125	06/88 → 09/91
2.3 E quattro	Petrol	100	04/87 → 07/91

SAA102

AUDI
90 (89, 89Q, 8A, B3)

2.3 E quattro Petrol 98 04/87 → 09/91

COUPE (81, 85)

1.6 Petrol 55 07/80 → 08/81

1.8 Petrol 55 08/81 → 07/83

1.8 GT Petrol 65 04/86 → 10/88

1.8 GT Petrol 66 09/82 → 10/88

1.8 GT Petrol 79 08/86 → 10/87

1.8 GT Petrol 82 08/86 → 10/88

COUPE (81, 85)

1.9 Petrol 85 08/80 → 07/83

2.0 Petrol 83 03/86 → 04/88

2.0 Petrol 85 09/83 → 07/86

2.1 GT Petrol 96 09/82 → 10/87

2.2 GT Petrol 100 09/84 → 10/88

2.2 GT Petrol 85 07/81 → 10/87

2.2 quattro Petrol 100 10/84 → 10/88

2.2 quattro Petrol 88 08/85 → 10/88

2.3 Petrol 100 01/87 → 10/88

2.3 quattro Petrol 100 01/87 → 10/88

COUPE (89, 8B)

2.0 Petrol 85 05/89 → 12/96

2.0 16 V Petrol 101 01/92 → 07/92

2.0 16 V Petrol 103 08/92 → 12/96

2.0 20 V quattro Petrol 118 08/89 → 07/91

2.3 Petrol 100 10/88 → 07/94

2.3 Petrol 98 03/90 → 12/96

2.3 20V Petrol 123 08/90 → 07/91

2.3 20V Petrol 125 08/89 → 07/91

2.3 20V quattro Petrol 125 11/88 → 07/91

2.3 20V quattro Petrol 123 05/90 → 12/96

2.3 quattro Petrol 100 11/88 → 12/92

2.3 quattro Petrol 98 05/90 → 12/96

2.6 Petrol 110 08/92 → 12/96

2.6 quattro Petrol 110 08/92 → 12/96

2.8 Petrol 128 09/91 → 12/96

2.8 quattro Petrol 128 08/91 → 12/96

S2 quattro Petrol 162 09/90 → 09/92

S2 quattro Petrol 169 10/92 → 12/96

QUATTRO (85)

2.1 20V Turbo Petrol 225 05/84 → 07/87

2.1 Turbo Petrol 147 07/80 → 07/87

2.2 20V Turbo Petrol 162 08/89 → 07/91

2.2 Turbo Petrol 147 08/87 → 07/89

SAA102

AUDI
V8 (44_, 4C_)

3.6 quattro Petrol 180 04/93 → 02/94

3.6 quattro Petrol 184 10/88 → 02/94

4.2 quattro Petrol 206 10/91 → 02/94

VOLKSWAGEN
CADDY I (14)

1.5 Petrol 51 08/82 → 07/83

1.6 Petrol 55 01/83 → 07/92

1.6 D Diesel 40 08/82 → 07/92

1.8 Petrol 70 08/85 → 07/92

CORRADO (53I)

1.8 G60 Petrol 118 09/88 → 09/93

2.0 i Petrol 85 04/93 → 12/95

2.0 i 16V Petrol 100 08/91 → 12/95

2.9 VR6 Petrol 140 08/91 → 12/95

DERBY (86)

0.9 Petrol 29 02/77 → 09/81

1.1 Petrol 37 02/77 → 09/81

1.3 Petrol 44 02/77 → 09/81

DERBY (86C, 80)

1.0 Petrol 29 10/81 → 12/84

1.1 Petrol 37 10/81 → 07/83

1.3 Petrol 40 08/83 → 12/84

1.3 Petrol 44 08/81 → 07/83

GOLF I (17)

1.1 Petrol 37 04/74 → 07/83

1.1 Petrol 38 08/76 → 07/80

1.1 Petrol 44 01/81 → 07/83

1.3 Petrol 44 08/79 → 07/83

1.5 Petrol 51 04/74 → 12/75

1.5 Petrol 51 08/77 → 07/83

1.5 D Diesel 37 08/76 → 07/80

1.6 Petrol 55 08/75 → 02/84

1.6 D Diesel 40 08/80 → 07/83

1.6 GTI Petrol 81 08/76 → 07/82

1.6 TD Diesel 51 03/82 → 07/83

1.8 GTI Petrol 82 08/82 → 12/83

GOLF I Cabriolet (155)

1.5 Petrol 51 01/79 → 11/83

1.6 Petrol 53 04/86 → 02/90

1.6 Petrol 55 08/83 → 04/92

1.6 Petrol 81 08/79 → 07/82

1.8 Petrol 66 08/83 → 09/92

1.8 Petrol 70 08/83 → 04/93

SAA102



KW



VOLKSWAGEN

GOLF I Cabriolet (155)

1.8	Petrol	72	08/89 → 03/93
1.8	Petrol	82	08/82 → 12/89

JETTA I (16)

1.1	Petrol	37	08/78 → 07/82
1.3	Petrol	44	08/79 → 07/82
1.5	Petrol	51	08/78 → 07/82
1.6	Petrol	63	08/78 → 07/82
1.6 D	Diesel	40	08/80 → 07/82
1.6 GLI	Petrol	81	08/78 → 07/82
1.6 TD	Diesel	51	03/82 → 07/82

PASSAT (32)

1.3	Petrol	40	08/78 → 07/80
1.5 D	Diesel	37	08/78 → 07/80
1.6	Petrol	63	08/78 → 07/80

PASSAT (32B)

1.3	Petrol	40	08/80 → 07/82
1.3	Petrol	44	08/80 → 07/82
1.3	Petrol	44	08/80 → 07/82
1.6	Petrol	55	08/80 → 07/82
1.6	Petrol	63	01/81 → 07/82
1.9	Petrol	85	01/81 → 07/82

PASSAT (3A2, 35I)

1.6	Petrol	53	02/88 → 09/91
1.6	Petrol	55	02/88 → 12/88
1.6 TD	Diesel	59	08/88 → 09/93
1.8	Petrol	55	08/90 → 08/96
1.8	Petrol	66	02/88 → 08/96
1.8	Petrol	79	04/88 → 07/93
1.8	Petrol	82	04/88 → 07/92
1.8 G60 Syncro	Petrol	118	08/88 → 08/96
2.0	Petrol	85	02/90 → 08/96
2.0 16V	Petrol	100	08/88 → 09/93

PASSAT Variant (32B)

1.3	Petrol	40	08/80 → 07/82
1.3	Petrol	44	08/80 → 07/82
1.3	Petrol	44	08/80 → 07/82
1.6	Petrol	55	08/80 → 07/82
1.6	Petrol	63	01/81 → 07/82
1.9	Petrol	85	01/81 → 07/82

PASSAT Variant (33)

1.3	Petrol	40	08/78 → 07/80
1.5 D	Diesel	37	08/78 → 07/80
1.6	Petrol	55	08/78 → 07/80
1.6	Petrol	63	08/78 → 07/80

SAA102



KW



VOLKSWAGEN

PASSAT Variant (33)

1.6 D	Diesel	40	02/79 → 07/80
1.6 i	Petrol	81	08/78 → 07/80

PASSAT Variant (3A5, 35I)

1.6	Petrol	53	04/88 → 09/91
1.6	Petrol	55	04/88 → 12/88
1.6 TD	Diesel	59	08/88 → 09/93
1.8	Petrol	55	08/90 → 05/97
1.8	Petrol	66	02/88 → 05/97
1.8	Petrol	79	04/88 → 07/90
1.8	Petrol	82	04/88 → 07/92
1.8 G60 Syncro	Petrol	118	08/88 → 05/97
2.0	Petrol	85	02/90 → 05/97

PASSAT Variant (3A5, 35I)

2.0 16V	Petrol	100	08/88 → 09/93
---------	--------	-----	---------------

POLO (86)

0.9	Petrol	29	09/75 → 09/81
1.1	Petrol	37	03/75 → 09/81
1.1	Petrol	44	03/75 → 09/81
1.3	Petrol	44	12/76 → 09/81

POLO (86C, 80)

1.0	Petrol	29	10/81 → 10/86
1.0 Cat.	Petrol	33	08/89 → 09/94
1.1	Petrol	37	10/81 → 09/89
1.3	Petrol	44	10/81 → 07/83
1.3 Cat.	Petrol	55	10/89 → 03/91
1.3 Cat.	Petrol	40	07/87 → 09/94
1.3 D	Diesel	33	08/86 → 07/90
1.4 D	Diesel	35	10/90 → 09/94

POLO CLASSIC (86C, 80)

1.0	Petrol	29	01/85 → 10/86
1.0	Petrol	33	01/85 → 09/94
1.3 Cat.	Petrol	40	07/87 → 09/94
1.3 D	Diesel	33	08/86 → 12/88

POLO Coupé (86C, 80)

1.0	Petrol	29	05/82 → 10/86
1.0 Cat.	Petrol	33	08/89 → 09/94
1.1	Petrol	37	10/81 → 07/83
1.3	Petrol	44	10/81 → 07/83
1.3 Cat.	Petrol	55	10/89 → 09/94
1.3 Cat.	Petrol	40	07/87 → 08/94
1.3 D	Diesel	33	08/86 → 08/90
1.3 G40	Petrol	83	08/90 → 09/94
1.3 G40	Petrol	85	01/87 → 08/90
1.4 D	Diesel	35	08/90 → 09/94

SAA102

KW

VOLKSWAGEN
SANTANA (32B)

1.3	Petrol	44	08/81 → 07/82
1.6	Petrol	55	08/81 → 07/82
1.6	Petrol	63	08/81 → 07/82
1.9	Petrol	85	08/81 → 07/82

SCIROCCO (53)

1.1	Petrol	37	04/74 → 07/79
1.3	Petrol	44	08/79 → 07/80
1.5	Petrol	51	02/74 → 12/75
1.5	Petrol	51	08/77 → 07/80
1.6	Petrol	55	08/75 → 07/79
1.6	Petrol	63	08/75 → 07/80
1.6	Petrol	81	06/76 → 07/80

SCIROCCO (53B)

1.3	Petrol	44	08/80 → 07/82
1.5	Petrol	51	08/80 → 07/82
1.6	Petrol	81	08/80 → 07/82
1.6	Petrol	63	08/80 → 07/82

TRANSPORTER III Autobus

1.6 D	Diesel	37	01/81 → 07/87
1.6 TD	Diesel	51	08/84 → 07/92
1.6 TD Syncro	Diesel	51	03/86 → 07/92
1.7 D	Diesel	42	10/86 → 07/92
1.9	Petrol	44	08/82 → 07/92
1.9	Petrol	57	08/82 → 07/92
1.9	Petrol	61	01/83 → 07/85
1.9	Petrol	66	08/83 → 07/85
1.9 Syncro	Petrol	57	02/85 → 07/92
2.1	Petrol	64	10/86 → 07/92
2.1 Syncro	Petrol	64	10/86 → 07/92
1.9	Petrol	44	10/82 → 07/92
2.1	Petrol	70	08/85 → 07/92
2.1	Petrol	82	03/86 → 07/92
2.1 i	Petrol	68	07/89 → 07/92
2.1 Syncro	Petrol	70	08/85 → 07/92

TRANSPORTER III Pianale piatto/Telaio

1.6 D	Diesel	37	01/81 → 07/87
1.6 TD	Diesel	51	10/84 → 07/92
1.7 D	Diesel	42	07/89 → 07/92
1.9	Petrol	44	09/82 → 07/92
1.9	Petrol	57	08/82 → 07/92
2.1	Petrol	82	03/86 → 07/92
2.1 i	Petrol	68	07/89 → 07/92

SAA102

KW

VOLKSWAGEN
VENTO (1H2)

1.4	Petrol	40	11/91 → 09/98
-----	--------	----	---------------

VOLVO
240 (P242, P244)

2.4 Diesel	Diesel	58	08/87 → 08/93
2.4 Diesel	Diesel	60	01/79 → 07/85

240 Kombi (P245)

2.4 Diesel	Diesel	58	08/88 → 08/93
2.4 Diesel	Diesel	60	04/79 → 08/93

740 (744)

2.4 Diesel	Diesel	60	08/84 → 07/92
2.4 TD	Diesel	83	08/84 → 07/90

740 Kombi (745)

2.4 Diesel	Diesel	60	08/85 → 07/88
2.4 TD Interc.	Diesel	90	08/86 → 07/88
2.4 Turbo-Diesel	Diesel	80	09/85 → 07/92

760 (704, 764)

2.4 TD Interc. (704)	Diesel	85	08/87 → 07/92
2.4 Turbo Diesel (704)	Diesel	80	04/87 → 07/92
2.4 Turbo Diesel (704)	Diesel	82	08/82 → 07/87

940 II (944)

2.4 TD Interc.	Diesel	90	08/94 → 10/98
----------------	--------	----	---------------

940 II Station wagon (945)

2.4 TD Interc.	Diesel	90	08/94 → 10/98
----------------	--------	----	---------------

960 (964)

2.4 TD Interc.	Diesel	85	09/91 → 07/94
----------------	--------	----	---------------

960 Kombi (965)

2.4 TD Interc.	Diesel	85	09/91 → 07/94
----------------	--------	----	---------------

SAA103

INTERRUTTORE PRESSIONE OLIO
OIL PRESSURE SWITCH



CHEVROLET

AVEO 2 volumi /Coda spiovente (T300)

1.2 Petrol 63 06/11 →

FIAT

STILO (192)

1.6 16V Petrol 77 05/05 → 11/06

OPEL

AGILA (A) (H00)

1.0 Petrol 44 08/03 → 12/07

1.0 12V Petrol 43 09/00 → 12/07

1.2 16V Petrol 55 09/00 → 12/07

1.2 16V Twinport Petrol 59 07/04 → 12/07

AMPERA

EV 150 Electric 111 11/11 →

ASTRA G 2 volumi /Coda spiovente (F48_, F08_)

1.2 16V Petrol 48 02/98 → 09/00

1.2 16V Petrol 55 09/00 → 01/05

1.4 Petrol 66 09/07 → 12/09

1.6 Petrol 76 12/02 → 12/09 ENGINE: 20EL9416 →

ASTRA G Cabriolet (F67)

1.6 Petrol 76 01/03 → 10/05 ENGINE: 20EL9416 →

ASTRA G Coupé (F07_)

1.6 16V Petrol 76 03/00 → 05/05 ENGINE: 20EL9416 →

ASTRA G Station wagon (F35_)

1.2 16V Petrol 48 02/98 → 09/00

1.2 16V Petrol 55 09/00 → 07/04

1.4 Petrol 66 09/07 → 12/09

1.6 Petrol 76 12/02 → 07/09 ENGINE: 20EL9416 →

ASTRA G Tre volumi (F69_)

1.2 16V Petrol 48 09/98 → 09/00

1.2 16V Petrol 55 09/00 → 01/05

1.4 Petrol 66 09/07 → 01/09

1.4 16V Petrol 66 09/98 → 01/05

1.6 Petrol 76 12/02 → 12/09 ENGINE: 20EL9416 →

SAA103



OPEL

ASTRA GTC J

1.4 Petrol 74 10/11 →

1.4 Petrol 103 10/11 →

1.4 Petrol 88 10/11 →

1.6 Petrol 132 10/11 →

1.8 Petrol 103 10/11 →

ASTRA H (L48)

1.2 Petrol 59 08/05 →

1.4 Petrol 55 04/04 → 10/04

1.4 Petrol 66 03/04 →

1.4 LPG Petrol/LPG 66 08/09 → 12/09

1.6 Petrol 85 12/06 →

1.6 Petrol 77 03/04 → ENGINE: 20EL5306 →

1.6 Turbo Petrol 132 02/07 →

1.8 Petrol 103 01/06 →

ASTRA H GTC (L08)

1.2 Petrol 59 08/05 →

1.4 Petrol 55 03/05 →

1.4 Petrol 66 03/05 →

1.6 Petrol 85 12/06 →

1.6 Petrol 77 03/05 → ENGINE: 20EL5306 →

1.6 Turbo Petrol 132 02/07 →

1.8 Petrol 103 01/06 →

ASTRA H Station wagon (L35)

1.4 Petrol 55 08/04 →

1.4 Petrol 66 08/04 →

1.6 Petrol 85 12/06 →

1.6 Petrol 77 08/04 → ENGINE: 20EL5306 →

1.6 Turbo Petrol 132 02/07 →

1.8 Petrol 103 10/05 →

ASTRA H Tre volumi (L69)

1.6 Petrol 85 02/07 →

1.8 Petrol 103 02/07 →

ASTRA H TwinTop (L67)

1.6 Petrol 85 12/06 →

1.6 Petrol 77 09/05 → ENGINE: 20EL5306 →

1.6 Turbo Petrol 132 02/07 →

1.8 Petrol 103 09/05 →

ASTRA J

1.4 Petrol 64 12/09 →

1.4 Petrol 74 12/09 →

1.4 LPG Petrol/LPG 103 01/12 →

1.4 Turbo Petrol 103 12/09 →

SAA103

KW

OPEL
ASTRA J

1.4 Turbo	Petrol	88	10/10 →
1.6	Petrol	85	12/09 →
1.6 Turbo	Petrol	132	12/09 →

ASTRA J Sports Tourer

1.4	Petrol	74	10/10 →
1.4 LPG	Petrol/ LPG	103	01/12 →
1.4 Turbo	Petrol	103	10/10 →
1.4 Turbo	Petrol	88	10/10 →
1.6	Petrol	85	10/10 →
1.6 Turbo	Petrol	132	10/10 →

COMBO Cassone / Furgonato / Promiscuo

1.4 16V	Petrol	66	08/05 →
1.4	Petrol	66	10/04 →

CORSA B (73_, 78_, 79_)

1.2 i 16V	Petrol	48	03/98 → 09/00
-----------	--------	----	---------------

CORSA C (F08, F68)

1.0	Petrol	44	06/03 → 12/09
1.0	Petrol	43	09/00 → 12/09
1.2	Petrol	55	09/00 → 12/09
1.2 Twinport	Petrol	59	07/04 → 12/09
1.4 Twinport	Petrol	66	06/03 → 12/09

CORSA C Furgonato (F08, W5L)

1.2	Petrol	59	07/05 →
1.2 16V	Petrol	55	09/00 →
1.4	Petrol	66	08/03 →

CORSA D

1.0	Petrol	44	07/06 →
1.0	Petrol	48	01/10 →
1.2	Petrol	63	06/10 →
1.2	Petrol	51	06/10 →
1.2	Petrol	59	07/06 →
1.2 LPG	Petrol/ LPG	59	09/09 →
1.2 LPG	Petrol/ LPG	63	08/11 →
1.4	Petrol	66	07/06 →
1.4	Petrol	74	06/10 →
1.4	Petrol	64	01/10 →
1.4 LPG	Petrol/ LPG	64	09/09 →
1.4 LPG	Petrol/ LPG	66	07/06 →
1.6 Turbo	Petrol	110	05/07 →

SAA103

KW

OPEL
CORSA D

1.6 Turbo	Petrol	141	02/07 →
1.6 Turbo	Petrol	155	07/11 →

CORSA D Van

1.0	Petrol	48	01/10 →
1.0	Petrol	44	08/06 →
1.2	Petrol	51	06/10 →
1.2	Petrol	59	07/09 →
1.2	Petrol	63	06/10 →

INSIGNIA

1.4	Petrol	103	04/11 →
1.6	Petrol	85	07/08 →
1.6 Turbo	Petrol	132	07/08 →
1.8	Petrol	103	07/08 →

INSIGNIA Sports Tourer

1.4	Petrol	103	09/11 →
1.6	Petrol	85	07/08 →
1.6 Turbo	Petrol	132	01/09 →
1.8	Petrol	103	07/08 →

INSIGNIA Tre volumi

1.4	Petrol	103	04/11 →
1.6	Petrol	85	07/08 →
1.6 Turbo	Petrol	132	01/09 →
1.8	Petrol	103	07/08 →

MERIVA

1.4 16V Twinport	Petrol	66	07/04 → 05/10
1.4 16V Twinport LPG	Petrol/ LPG	66	07/04 → 05/10
1.6	Petrol	77	01/06 → 05/10
1.6 Turbo	Petrol	132	09/05 → 05/10

MERIVA B

1.4	Petrol	74	06/10 →
1.4	Petrol	103	06/10 →
1.4	Petrol	88	06/10 →
1.4 LPG	Petrol/ LPG	88	06/11 →

MOKKA

1.4 4x4	Petrol	103	06/12 →
1.6	Petrol	85	06/12 →

SIGNUM

1.8	Petrol	103	09/05 →
-----	--------	-----	---------

TIGRA TwinTop

1.4	Petrol	66	06/04 →
-----	--------	----	---------

SAA103



KW



OPEL

VECTRA C

1.6 Petrol 77 01/06 →

1.8 Petrol 103 01/06 →

VECTRA C GTS

1.6 Petrol 77 01/06 →

1.8 Petrol 103 01/06 →

VECTRA C Station wagon

1.6 Petrol 77 10/06 →

1.8 Petrol 103 01/06 →

ZAFIRA B (A05)

1.6 Petrol 77 07/05 →

1.6 Petrol 85 01/08 →

1.6 CNG Turbo Petrol/CNG 110 04/09 →

1.8 Petrol 103 07/05 →

ZAFIRA B Van

1.6 CNG Turbo Petrol/CNG 110 04/09 →

1.8 Petrol 103 07/05 →

ZAFIRA TOURER C (P12)

1.4 Petrol 103 10/11 →

1.4 Petrol 88 10/11 →

1.6 CNG Petrol/CNG 110 12/11 →

1.8 Petrol 103 12/11 →

1.8 Petrol 85 10/11 →

VAUXHALL

AGILA Mk I (A)

1.0 12V Petrol 43 09/00 → 08/05

1.0 12V Petrol 44 02/00 → 11/06

1.2 16V Petrol 55 09/00 → 03/08

1.2 16V Twinport Petrol 59 07/04 → 11/06

1.2 16V Twinport Petrol 59 07/04 → 11/06

AMPERA

EV 150 (D1JOI) Electric 111 03/12 →

ASTRA GTC Mk VI (J)

1.4 Petrol 103 10/11 →

1.4 Petrol 74 10/11 →

1.4 Petrol 88 10/11 →

1.6 Petrol 132 10/11 →

ASTRA Mk IV (G) 2 volumi /Coda spiovente

1.2 16V Petrol 48 02/98 → 09/00

1.2 16V Petrol 55 09/00 → 05/05

1.4 16V Petrol 66 02/98 → 05/05

ASTRA Mk IV (G) Cabriolet

1.6 16V Petrol 76 04/04 → 10/05 CHASSIS:20EL9416→

SAA103



KW



VAUXHALL

ASTRA Mk IV (G) Station wagon

1.2 16V Petrol 48 02/98 → 09/00

1.2 16V Petrol 55 09/00 → 05/05

1.4 16V Petrol 66 02/98 → 05/05

1.6 Petrol 76 09/04 → 05/05 CHASSIS:20EL5306→

ASTRA Mk IV (G) Tre volumi

1.2 16V Petrol 48 09/98 → 09/00

1.2 16V Petrol 55 09/00 → 05/05

1.4 16V Petrol 66 09/98 → 05/05

ASTRA Mk V (H) 2 volumi /Coda spiovente

1.2 Petrol 59 08/05 → 05/09

1.4 Petrol 66 01/04 → 05/09

1.4 Petrol 55 04/04 → 12/05

1.6 Petrol 85 01/04 → 05/09

1.6 Petrol 77 01/04 → 05/09 ENGINE:20EL5306→

1.8 Petrol 103 01/04 → 05/09

ASTRA Mk V (H) Sport Hatch

1.4 Petrol 55 02/05 → 11/10

1.4 i 16V Petrol 66 03/05 → 11/10

1.6 Petrol 132 10/06 → 11/10

1.6 Petrol 77 02/05 → 11/10 ENGINE:20EL5306→

1.6 i 16V Petrol 85 12/06 → 11/10

1.8 i 16V Petrol 103 03/07 → 11/10

ASTRA Mk V (H) Station wagon

1.2 Petrol 59 08/05 → 10/10

1.4 Petrol 66 08/04 → 03/09

1.4 Petrol 55 08/04 → 03/06

ASTRA Mk V (H) Station wagon

1.6 Petrol 132 08/04 → 03/09

1.6 Petrol 85 08/04 → 03/09

1.6 Petrol 77 08/04 → 03/09 ENGINE:20EL5306→

1.8 Petrol 103 10/04 → 03/09

ASTRA Mk VI (J)

1.4 Petrol 64 12/09 →

1.4 Petrol 74 12/09 →

1.4 Turbo Petrol 103 12/09 →

1.6 Petrol 85 12/09 →

1.6 Turbo Petrol 132 12/09 →

ASTRA Mk VI (J) Sports Tourer

1.4 Petrol 64 12/09 →

1.4 Petrol 74 10/10 →

1.4 Turbo Petrol 103 10/10 →

1.6 Petrol 85 10/10 →

1.6 Turbo Petrol 132 10/10 →

SAA103

VAUXHALL
ASTRA TwinTop Mk V (H)

1.6	Petrol	132	10/06 → 11/10	
1.6	Petrol	77	09/05 → 11/10	ENGINE: 20EL5306 →
1.6 i 16V	Petrol	85	10/06 → 11/10	
1.8	Petrol	103	05/08 → 11/10	CHASSIS: 20EL5306 →

ASTRAVAN Mk V (H)

1.4 i	Petrol	66	03/05 →	
1.6	Petrol	76	03/05 →	CHASSIS: 20EL5306 →

COMBO Mk II (C) Cassone / Furgonato / Promiscuo (F25)

1.4 i 16V	Petrol	66	10/04 → 11/11	
-----------	--------	----	---------------	--

CORSA Mk I (B)

1.2 i 16V	Petrol	48	03/98 → 09/00	
-----------	--------	----	---------------	--

CORSA Mk II (C) (W5L, F08)

1.0 12V	Petrol	43	09/00 → 10/03	
1.0 12V	Petrol	44	11/03 → 10/06	
1.2 16V	Petrol	55	09/00 → 10/06	
1.2 16V Dualfuel	Petrol/ LPG	55	08/01 → 10/06	
1.2 Twinport	Petrol	59	07/04 → 10/06	

CORSA Mk III (D) (L_8)

1.0	Petrol	44	11/06 →	
1.0 i 12V	Petrol	48	06/10 →	
1.2	Petrol	59	11/06 →	
1.2 i 16V	Petrol	63	11/06 →	
1.4	Petrol	64	01/10 →	
1.4	Petrol	66	07/06 →	
1.4	Petrol	74	07/10 →	
1.4 LPG	Petrol/ LPG	64	09/09 →	

CORSA Mk III (D) (L_8)

1.6 SRi	Petrol	110	05/07 →	
1.6 VXR	Petrol	141	02/07 →	
1.6 VXR	Petrol	150	06/11 → 12/11	

CORSAVAN Mk II (C)

1.2 16V	Petrol	55	09/00 → 06/06	
1.2 16V Dualfuel	Petrol/ LPG	55	08/01 → 06/06	
1.4	Petrol	66	11/03 → 06/06	

CORSAVAN Mk III (D)

1.2	Petrol	51	01/10 →	
1.2	Petrol	59	07/09 →	

INSIGNIA

1.4	Petrol	103	04/11 →	
1.6	Petrol	85	07/08 →	
1.6 Turbo	Petrol	132	01/09 →	

SAA103

VAUXHALL
INSIGNIA

1.8	Petrol	103	07/08 → 09/13	
-----	--------	-----	---------------	--

INSIGNIA Sports Tourer

1.4	Petrol	103	04/11 →	
1.6	Petrol	85	07/08 →	
1.6 Turbo	Petrol	132	01/09 →	
1.8	Petrol	103	07/08 → 09/13	

INSIGNIA Tre volumi

1.4	Petrol	103	04/11 →	
1.6	Petrol	85	07/08 →	
1.6 Turbo	Petrol	132	01/09 →	
1.8	Petrol	103	07/08 → 09/13	

MERIVA Mk I (A)

1.4 16V Twinport	Petrol	66	01/03 → 10/09	
1.6 i 16V Twinport	Petrol	77	05/03 → 06/10	
1.6 Turbo	Petrol	132	05/06 → 06/10	

MERIVA Mk II (B)

1.4	Petrol	103	06/10 →	
1.4	Petrol	74	06/10 →	
1.4	Petrol	88	06/10 →	

MOKKA

1.4 4x4	Petrol	103	06/12 →	
1.6	Petrol	85	06/12 →	

SIGNUM

1.8	Petrol	103	08/05 → 05/08	
-----	--------	-----	---------------	--

TIGRA TwinTop

1.4	Petrol	66	06/04 → 08/09	
-----	--------	----	---------------	--

VECTRA Mk II (C)

1.6	Petrol	77	01/06 → 07/08	
1.8	Petrol	103	01/06 → 07/08	

VECTRA Mk II (C) GTS

1.6	Petrol	77	01/06 → 07/08	
1.8	Petrol	103	01/06 → 07/08	

VECTRA Mk II (C) Station wagon

1.8	Petrol	103	01/06 → 07/08	
-----	--------	-----	---------------	--

ZAFIRA Mk II (B) (M75)

1.6	Petrol	77	07/05 →	
1.6	Petrol	85	12/07 →	
1.6 CNG Turbo	Petrol/ CNG	110	02/09 → 06/10	
1.8	Petrol	103	04/05 →	

ZAFIRA Mk III (P12)

1.4	Petrol	103	10/11 →	
1.4	Petrol	88	10/11 →	

SAA103



KW



VAUXHALL

ZAFIRA Mk III (P12)

1.6 CNG	Petrol/ CNG	110	10/11 →
1.8	Petrol	103	10/11 →
1.8	Petrol	85	10/11 →
1.8	Petrol	88	10/11 →

SAA104

**INTERRUTTORE PRESSIONE OLIO
OIL PRESSURE SWITCH**



KW



AUDI

100 (44, 44Q, C3)

1.8	Petrol	55	08/82 → 12/87
1.8	Petrol	65	02/86 → 07/88
1.8 Cat.	Petrol	66	03/85 → 11/90
1.8 quattro	Petrol	65	08/86 → 07/90
1.8 quattro Cat.	Petrol	66	08/85 → 11/90
1.9	Petrol	74	08/82 → 07/84
2.0	Petrol	83	08/86 → 11/87
2.0	Petrol	85	08/84 → 12/87
2.0 Cat.	Petrol	85	01/88 → 11/90

100 (44, 44Q, C3)

2.0 D	Diesel	51	08/82 → 07/88
2.0 D Turbo	Diesel	64	08/82 → 02/88
2.0 D Turbo	Diesel	74	03/88 → 11/90
2.1	Petrol	100	08/82 → 07/84
2.2	Petrol	101	08/84 → 12/88
2.2	Petrol	85	10/84 → 09/86
2.2 Cat.	Petrol	101	06/89 → 11/90
2.2 E quattro	Petrol	88	08/85 → 07/86
2.2 E Turbo quattro	Petrol	121	08/86 → 11/90
2.2 quattro	Petrol	101	08/84 → 12/88

SAA104



KW



AUDI

2.2 quattro Cat.	Petrol	101	06/89 → 11/90
2.2 Turbo	Petrol	121	08/86 → 11/90
2.3 E	Petrol	100	10/86 → 11/90
2.3 E	Petrol	98	01/90 → 11/90
2.3 E quattro	Petrol	100	08/86 → 11/90
2.3 quattro	Petrol	98	01/90 → 11/90
2.4 D	Diesel	60	08/89 → 07/91
2.5 TDI	Diesel	88	01/90 → 11/90

100 (4A, C4)

2.0	Petrol	74	12/90 → 06/94
2.0 E	Petrol	85	12/90 → 06/94
2.0 E 16V	Petrol	103	01/92 → 06/94
2.0 E 16V quattro	Petrol	103	07/92 → 06/94
2.0 E quattro	Petrol	85	12/90 → 07/92
2.3 E	Petrol	98	12/90 → 06/94
2.3 E quattro	Petrol	98	12/90 → 06/94
2.4 D	Diesel	60	12/90 → 06/94
2.5 TDI	Diesel	85	12/90 → 06/94
2.6	Petrol	102	07/93 → 06/94
2.6	Petrol	110	03/92 → 06/94
2.6 quattro	Petrol	110	04/92 → 06/94
2.8 E	Petrol	128	12/90 → 06/94
2.8 E quattro	Petrol	128	12/90 → 06/94
S4 Turbo quattro	Petrol	169	08/91 → 06/94

100 Avant (44, 44Q, C3)

1.8	Petrol	55	08/82 → 12/87
1.8	Petrol	65	02/86 → 07/90
1.8	Petrol	66	08/83 → 07/89
1.8 Cat.	Petrol	66	03/85 → 11/90
2.0	Petrol	83	09/86 → 11/87
2.0 D	Diesel	51	03/83 → 11/90
2.0 E	Petrol	85	01/85 → 12/87
2.0 E Cat.	Petrol	85	01/88 → 11/90
2.0 TD	Diesel	64	03/83 → 10/87
2.0 TD	Diesel	74	03/88 → 11/90
2.1	Petrol	100	08/82 → 07/84
2.2	Petrol	101	08/84 → 12/88
2.2	Petrol	85	10/84 → 09/86
2.2 Cat.	Petrol	101	06/89 → 11/90
2.2 E quattro	Petrol	88	08/85 → 07/86
2.2 quattro	Petrol	101	08/84 → 12/88
2.2 quattro Cat.	Petrol	101	06/89 → 11/90
2.2 Turbo	Petrol	121	08/86 → 11/90
2.2 Turbo quattro	Petrol	121	08/86 → 11/90

SAA104

AUDI
100 Avant (44, 44Q, C3)

2.3	Petrol	100	08/86 → 11/90
2.3	Petrol	98	03/90 → 11/90
2.3 E quattro	Petrol	100	08/86 → 11/90
2.3 quattro	Petrol	98	01/90 → 11/90
2.4 D	Diesel	60	08/89 → 11/90
2.5 TDI	Diesel	88	01/90 → 11/90

100 Avant (4A, C4)

2.0 E	Petrol	74	09/91 → 06/94
2.0 E	Petrol	85	09/91 → 06/94
2.0 E quattro	Petrol	85	12/90 → 07/92
2.3 E	Petrol	98	09/91 → 06/94
2.3 E quattro	Petrol	98	09/91 → 06/94
2.4 D	Diesel	60	12/90 → 06/94
2.5 TDI	Diesel	85	12/90 → 06/94
2.6	Petrol	102	07/93 → 06/94
2.6	Petrol	110	03/92 → 06/94
2.6 quattro	Petrol	110	07/92 → 06/94
2.8 E	Petrol	128	09/91 → 06/94
2.8 E quattro	Petrol	128	09/91 → 06/94
S4 Turbo quattro	Petrol	169	09/91 → 06/94

200 (44, 44Q)

2.1 5E	Petrol	100	08/83 → 07/84
2.1 Turbo	Petrol	134	08/83 → 01/88
2.1 Turbo quattro	Petrol	134	08/83 → 09/86
2.2	Petrol	101	08/84 → 07/85
2.2 20V Turbo quattro	Petrol	162	03/89 → 12/90
2.2 Turbo	Petrol	121	08/85 → 09/91
2.2 Turbo	Petrol	140	02/88 → 12/90
2.2 Turbo	Petrol	147	02/88 → 12/90
2.2 Turbo quattro	Petrol	121	01/85 → 12/91
2.2 Turbo quattro	Petrol	147	02/88 → 11/90
2.3	Petrol	100	11/86 → 09/91

200 Avant (44, 44Q)

2.1 Turbo quattro	Petrol	134	09/83 → 01/88
2.2 20V Turbo quattro	Petrol	162	07/89 → 12/90
2.2 Turbo	Petrol	121	08/85 → 09/91
2.2 Turbo quattro	Petrol	121	09/83 → 12/90
2.2 Turbo quattro	Petrol	147	02/88 → 12/91
2.3	Petrol	100	11/86 → 09/91

SAA104

AUDI
80 (81, 85, B2)

1.3	Petrol	40	09/78 → 07/81
1.3	Petrol	44	08/83 → 07/86
1.6	Petrol	54	02/86 → 07/86
1.6	Petrol	55	08/83 → 07/86
1.6	Petrol	63	08/78 → 02/83
1.6 D	Diesel	40	08/83 → 08/86
1.6 GLE	Petrol	81	01/79 → 12/86
1.6 TD	Diesel	51	08/83 → 05/86
1.8	Petrol	65	02/86 → 07/86
1.8	Petrol	66	08/83 → 08/86
1.8 CC quattro (85Q)	Petrol	66	08/84 → 08/86
1.8 GTE	Petrol	82	10/84 → 08/86
1.8 GTE quattro (85Q)	Petrol	81	03/85 → 08/86
1.8 GTE quattro (85Q)	Petrol	82	08/84 → 08/86
2.0	Petrol	85	10/83 → 09/84
2.0 quattro (85Q)	Petrol	85	10/83 → 09/84
2.2 quattro (85Q)	Petrol	100	08/83 → 07/84

80 (89, 89Q, 8A, B3)

1.6	Petrol	51	08/87 → 09/91
1.6	Petrol	55	09/86 → 08/91
1.6 D	Diesel	40	09/86 → 08/91
1.6 TD	Diesel	59	09/86 → 08/91
1.8	Petrol	55	10/86 → 01/90
1.8	Petrol	83	09/86 → 07/88
1.8 E	Petrol	82	06/86 → 08/91
1.8 E quattro	Petrol	82	09/86 → 08/91
1.8 quattro	Petrol	83	09/86 → 08/90
1.8 S	Petrol	65	09/86 → 12/90
1.8 S	Petrol	66	09/86 → 10/91
1.8 S quattro	Petrol	65	09/86 → 07/90
1.8 S quattro	Petrol	66	09/86 → 09/91
1.9 D	Diesel	50	08/89 → 08/91
2.0	Petrol	82	10/90 → 08/91
2.0 E	Petrol	83	08/88 → 10/90
2.0 E 16V	Petrol	101	03/90 → 09/91
2.0 E 16V quattro	Petrol	101	03/90 → 08/91
2.0 E quattro	Petrol	83	08/88 → 09/90
2.0 quattro	Petrol	82	08/88 → 07/90
2.0 quattro	Petrol	85	10/90 → 08/91

SAA104



AUDI

80 (8C, B4)

1.6	Petrol	52	09/91 → 12/94	
1.6 E	Petrol	74	06/93 → 12/94	
1.9 TD	Diesel	55	09/91 → 12/94	
1.9 TDI	Diesel	66	09/91 → 12/94	
2.0	Petrol	66	09/91 → 12/94	
2.0 E	Petrol	85	09/91 → 12/94	
2.0 E 16V	Petrol	103	08/92 → 12/94	
2.0 E 16V quattro	Petrol	103	04/92 → 12/94	
2.0 E quattro	Petrol	85	09/91 → 12/94	
2.3 E	Petrol	98	09/91 → 12/94	
2.3 E quattro	Petrol	98	09/91 → 12/94	
2.6	Petrol	110	07/92 → 12/94	
2.6 quattro	Petrol	110	06/92 → 12/94	
2.8	Petrol	128	09/91 → 12/94	
2.8 quattro	Petrol	128	09/91 → 12/94	
S2 quattro	Petrol	169	02/93 → 12/94	

80 Avant (8C, B4)

1.6 E	Petrol	74	06/93 → 01/96	
1.9 TDI	Diesel	66	07/92 → 01/96	
2.0	Petrol	66	07/92 → 01/96	
2.0 E	Petrol	85	07/92 → 01/96	
2.0 E 16V	Petrol	103	02/93 → 01/96	
2.3 E	Petrol	98	07/92 → 01/96	
2.3 E quattro	Petrol	98	09/91 → 11/94	
2.6	Petrol	110	07/92 → 01/96	
2.6 quattro	Petrol	110	07/92 → 07/95	
2.8	Petrol	128	09/91 → 01/96	
2.8 quattro	Petrol	128	08/92 → 07/95	
RS2 quattro (P1)	Petrol	232	03/94 → 05/95	
S2 quattro	Petrol	169	02/93 → 07/95	

90 (89, 89Q, 8A, B3)

2.0 20 V	Petrol	118	08/89 → 07/91	
2.0 20 V quattro	Petrol	118	08/88 → 09/91	

A4 (8D2, B5)

2.4	Petrol	110	07/95 → 09/96	CHASSIS: → 8DV054232
2.6	Petrol	102	01/96 → 09/96	CHASSIS: → 8DV054232
2.6	Petrol	110	01/95 → 11/00	CHASSIS: → 8DV054232
2.6 quattro	Petrol	110	01/95 → 11/00	CHASSIS: → 8DV054232
2.8	Petrol	128	09/95 → 07/97	CHASSIS: → 8DV054232

SAA104



AUDI

A4 (8D2, B5)

2.8	Petrol	142	10/96 → 11/00	CHASSIS: → 8DV054232
2.8	Petrol	142	10/96 → 07/99	
2.8 quattro	Petrol	128	01/95 → 07/97	CHASSIS: → 8DV054232
2.8 quattro	Petrol	142	10/96 → 08/01	CHASSIS: → 8DV054232
S4 quattro	Petrol	195	09/97 → 09/01	CHASSIS: → 8DV054232

A4 Avant (8D5, B5)

2.6	Petrol	110	02/96 → 09/01	CHASSIS: → 8DV054232
2.6 quattro	Petrol	110	01/96 → 09/01	CHASSIS: → 8DV054232
2.8	Petrol	128	03/96 → 09/96	CHASSIS: → 8DV054232
2.8	Petrol	142	10/96 → 09/01	CHASSIS: → 8DV054232
2.8 quattro	Petrol	128	01/96 → 09/96	CHASSIS: → 8DV054232
2.8 quattro	Petrol	142	10/96 → 09/01	CHASSIS: → 8DV054232
RS4 quattro	Petrol	280	05/00 → 09/01	CHASSIS: → 8DV054232
S4 quattro	Petrol	195	09/97 → 09/01	CHASSIS: → 8DV054232

A6 (4A, C4)

2.6	Petrol	110	06/94 → 10/97	
2.6	Petrol	102	06/94 → 10/97	
2.6 quattro	Petrol	110	06/94 → 10/97	
2.8	Petrol	128	06/94 → 10/97	
2.8	Petrol	142	12/95 → 10/97	
2.8 quattro	Petrol	128	06/94 → 10/97	
2.8 quattro	Petrol	142	12/95 → 10/97	
S6 4.2 quattro	Petrol	213	06/94 → 10/97	

A6 (4B2, C5)

2.8	Petrol	142	02/97 → 01/05	
2.8 quattro	Petrol	142	02/97 → 01/05	

A6 Avant (4A, C4)

2.6	Petrol	102	06/94 → 02/97	
2.6	Petrol	110	06/94 → 12/97	
2.8	Petrol	128	06/94 → 12/97	
2.8	Petrol	142	12/95 → 12/97	
2.8 quattro	Petrol	128	06/94 → 12/97	

SAA104

AUDI
A6 Avant (4A, C4)

2.8 quattro	Petrol	142	12/95 → 12/97
S6 4.2 quattro	Petrol	213	06/94 → 12/97

A6 Avant (4B5, C5)

2.8	Petrol	142	12/97 → 01/05
2.8 quattro	Petrol	142	12/97 → 01/05

A8 (4D2, 4D8)

3.7	Petrol	169	07/95 → 12/98
3.7	Petrol	191	11/98 → 09/02
3.7 quattro	Petrol	191	11/98 → 09/02
3.7 quattro	Petrol	169	07/95 → 11/98
4.2 quattro	Petrol	228	11/98 → 09/02
4.2 quattro	Petrol	180	03/94 → 07/96
4.2 quattro	Petrol	220	03/94 → 11/98

CABRIOLET (8G7, B4)

1.9 TDI	Diesel	66	06/95 → 08/00
2.0 16V	Petrol	103	06/95 → 07/96 CHASSIS: → 8GX001000
2.0 E	Petrol	85	01/93 → 07/98 CHASSIS: → 8GX001000
2.3 E	Petrol	98	05/91 → 07/94
2.6	Petrol	102	05/95 → 08/00 CHASSIS: 8GS000001 →, → 8GV004000
2.6	Petrol	110	06/93 → 08/00 CHASSIS: 8GS000001 →, → 8GV004000
2.8	Petrol	128	11/92 → 08/00 CHASSIS: 8GS000001 →, → 8GV004000

COUPE (81, 85)

1.6	Petrol	55	07/80 → 08/81
1.8	Petrol	55	08/81 → 07/83
1.8 GT	Petrol	65	04/86 → 10/88
1.8 GT	Petrol	66	09/82 → 10/88
1.8 GT	Petrol	79	08/86 → 10/87
1.8 GT	Petrol	82	08/86 → 10/88
1.9	Petrol	85	08/80 → 07/83
2.0	Petrol	83	03/86 → 04/88
2.0	Petrol	85	09/83 → 07/86
2.1 GT	Petrol	96	09/82 → 10/87
2.2 GT	Petrol	100	09/84 → 10/88
2.2 GT	Petrol	85	07/81 → 10/87
2.2 quattro	Petrol	100	10/84 → 10/88
2.2 quattro	Petrol	88	08/85 → 10/88

SAA104

AUDI
COUPE (81, 85)

2.3	Petrol	100	01/87 → 10/88
2.3 quattro	Petrol	100	01/87 → 10/88

COUPE (89, 8B)

2.0	Petrol	85	05/89 → 12/96
2.0 16 V	Petrol	101	01/92 → 07/92
2.0 16 V	Petrol	103	08/92 → 12/96
2.0 20 V quattro	Petrol	118	08/89 → 07/91
2.3	Petrol	100	10/88 → 07/94
2.3	Petrol	98	03/90 → 12/96
2.3 20V	Petrol	123	08/90 → 07/91
2.3 20V	Petrol	125	08/89 → 07/91
2.3 20V quattro	Petrol	123	05/90 → 12/96
2.3 20V quattro	Petrol	125	11/88 → 07/91
2.3 quattro	Petrol	100	11/88 → 12/92
2.3 quattro	Petrol	98	05/90 → 12/96
2.6	Petrol	110	08/92 → 12/96
2.6 quattro	Petrol	110	08/92 → 12/96
2.8	Petrol	128	09/91 → 12/96
2.8 quattro	Petrol	128	08/91 → 12/96
S2 quattro	Petrol	162	09/90 → 09/92
S2 quattro	Petrol	169	10/92 → 12/96

QUATTRO (85)

2.1 20V Turbo	Petrol	225	05/84 → 07/87
2.1 Turbo	Petrol	147	07/80 → 07/87
2.2 20V Turbo	Petrol	162	08/89 → 07/91
2.2 Turbo	Petrol	147	08/87 → 07/89

SEAT
CORDOBA (6K1, 6K2)

1.8 i	Petrol	66	02/93 → 06/99
2.0 i	Petrol	85	02/93 → 06/99 CHASSIS: → 6KX068400

CORDOBA Vario (6K5)

1.6 i	Petrol	74	09/96 → 06/99 CHASSIS: → 6KX068400
-------	--------	----	--

IBIZA II (6K1)

1.8 i	Petrol	66	03/93 → 08/99
2.0 i	Petrol	85	03/93 → 08/99

VOLKSWAGEN
CADDY I (14)

1.5	Petrol	51	08/82 → 07/83
1.6	Petrol	55	01/83 → 07/92
1.6 D	Diesel	40	08/82 → 07/92
1.8	Petrol	70	08/85 → 07/92

SAA104



KW



VOLKSWAGEN

CORRADO (53I)

1.8 G60	Petrol	118	09/88 → 09/93
2.0 i	Petrol	85	04/93 → 12/95
2.0 i 16V	Petrol	100	08/91 → 12/95

DERBY (86C, 80)

1.0	Petrol	29	10/81 → 12/84
1.1	Petrol	37	10/81 → 07/83
1.3	Petrol	40	08/83 → 12/84
1.3	Petrol	44	08/81 → 07/83

GOLF I (17)

1.1	Petrol	38	08/76 → 07/80
1.1	Petrol	44	01/81 → 07/83
1.3	Petrol	44	01/81 → 07/83
1.5	Petrol	51	01/81 → 07/83
1.6 D	Diesel	40	01/81 → 07/83
1.6 GTI	Petrol	81	01/81 → 07/82
1.6 TD	Diesel	51	03/82 → 07/83
1.8 GTI	Petrol	82	08/82 → 12/83

GOLF I Cabriolet (155)

1.5	Petrol	51	08/82 → 11/83
1.6	Petrol	53	04/86 → 02/90
1.6	Petrol	55	08/83 → 04/92
1.8	Petrol	66	08/83 → 09/92
1.8	Petrol	70	08/83 → 04/93
1.8	Petrol	72	08/89 → 03/93
1.8	Petrol	82	08/82 → 12/89

GOLF II (19E, 1G1)

1.0	Petrol	37	08/85 → 10/91
1.0	Petrol	33	11/83 → 08/85
1.3	Petrol	37	08/85 → 12/87
1.3	Petrol	40	08/83 → 06/87
1.3	Petrol	43	08/83 → 10/86
1.6	Petrol	51	10/86 → 12/92
1.6	Petrol	53	02/86 → 10/91
1.6	Petrol	55	08/83 → 07/92
1.6 D	Diesel	37	08/83 → 10/91
1.6 D	Diesel	40	08/83 → 10/91
1.6 TD	Diesel	59	04/89 → 10/91
1.6 TD	Diesel	44	08/89 → 10/91
1.6 TD	Diesel	51	08/83 → 10/91
1.8	Petrol	62	08/86 → 01/90
1.8 GTI	Petrol	82	08/83 → 10/91
1.8 GTI 16V	Petrol	102	02/86 → 06/90
1.8 GTI 16V	Petrol	95	02/86 → 10/91
1.8 GTI Cat.	Petrol	79	01/87 → 10/91

SAA104



KW



VOLKSWAGEN

GOLF II (19E, 1G1)

1.8 GTI G60	Petrol	118	04/90 → 07/91
1.8 GTI G60 Syncro	Petrol	118	08/88 → 12/91
1.8 i Cat.	Petrol	66	08/87 → 10/91
1.8 Syncro	Petrol	66	02/86 → 07/91
1.8 Syncro	Petrol	72	08/88 → 07/91

GOLF III (1H1)

1.4	Petrol	44	10/91 → 08/97
1.6	Petrol	55	09/92 → 08/97
1.6	Petrol	74	07/95 → 08/97
1.8	Petrol	55	11/91 → 08/97
1.8	Petrol	66	11/91 → 08/97
1.8 Syncro (1HX1)	Petrol	66	01/93 → 08/97
2.0	Petrol	85	11/91 → 08/97
2.0 GTI 16V	Petrol	110	08/92 → 08/97

GOLF III Cabriolet (1E7)

1.6	Petrol	74	10/94 → 05/98
1.8	Petrol	55	07/93 → 05/98
1.8	Petrol	66	07/93 → 05/98
2.0	Petrol	85	07/93 → 05/98

GOLF III Variant (1H5)

1.4	Petrol	44	07/93 → 04/99
1.6	Petrol	55	07/93 → 12/97
1.6	Petrol	74	07/94 → 04/99
1.8	Petrol	55	07/93 → 04/99
1.8	Petrol	66	07/93 → 04/99
2.0	Petrol	85	07/93 → 04/99

GOLF IV Cabriolet (1E7)

1.6	Petrol	74	06/98 → 06/02	CHASSIS: 1EX000001 →, → 1EX015001
1.8	Petrol	55	06/98 → 06/02	CHASSIS: 1EX000001 →
1.8	Petrol	66	06/98 → 06/02	CHASSIS: 1EX000001 →
2.0	Petrol	85	06/98 → 06/02	CHASSIS: 1EX000001 →, → 1EX005000

JETTA I (16)

1.1	Petrol	37	08/82 → 02/84
1.3	Petrol	44	08/82 → 02/84
1.5	Petrol	51	08/82 → 02/84
1.6	Petrol	63	08/82 → 02/84

SAA104

VOLKSWAGEN
JETTA I (16)

1.6 D	Diesel	40	08/82 → 02/84
1.6 TD	Diesel	51	08/82 → 02/84

JETTA II (19E, 1G2, 165)

1.3	Petrol	40	01/84 → 06/87
1.3	Petrol	43	01/84 → 10/86
1.6	Petrol	51	10/86 → 10/91
1.6	Petrol	53	03/86 → 10/91
1.6	Petrol	55	01/84 → 07/92
1.6 D	Diesel	40	01/84 → 10/91
1.6 TD	Diesel	51	01/84 → 10/91
1.6 TD	Diesel	59	04/89 → 10/91
1.6 TD	Diesel	44	01/90 → 10/91
1.8	Petrol	62	08/86 → 01/90
1.8	Petrol	82	01/84 → 10/91
1.8 16V	Petrol	102	06/87 → 12/89
1.8 16V	Petrol	95	08/86 → 10/91
1.8 Cat.	Petrol	66	08/87 → 10/91
1.8 Cat.	Petrol	79	01/87 → 10/91
1.8 Syncro	Petrol	72	08/88 → 07/91

PASSAT (32B)

1.3	Petrol	40	08/82 → 07/83
1.3	Petrol	44	08/82 → 07/86
1.3	Petrol	44	08/82 → 07/86
1.6	Petrol	51	08/87 → 03/88
1.6	Petrol	53	02/86 → 03/88
1.6	Petrol	55	08/82 → 03/88
1.6	Petrol	63	08/82 → 02/83
1.8	Petrol	64	05/86 → 03/88
1.8	Petrol	66	01/83 → 03/88
1.8	Petrol	82	12/83 → 03/88
1.9	Petrol	85	08/82 → 07/83
2.0	Petrol	85	08/83 → 03/88
2.2	Petrol	100	01/85 → 03/88
2.2	Petrol	85	08/85 → 03/88

PASSAT (3A2, 35I)

1.6	Petrol	74	10/94 → 08/96
1.6	Petrol	53	02/88 → 09/91
1.6	Petrol	55	02/88 → 12/88
1.6 TD	Diesel	59	08/88 → 09/93
1.8	Petrol	55	08/90 → 08/96
1.8	Petrol	66	02/88 → 08/96
1.8	Petrol	79	04/88 → 07/93
1.8	Petrol	82	04/88 → 07/92
1.8 G60 Syncro	Petrol	118	08/88 → 08/96

SAA104

VOLKSWAGEN
PASSAT (3A2, 35I)

1.8 GL	Petrol	102	08/91 → 09/93
1.9 D	Diesel	50	05/89 → 10/93
1.9 TD	Diesel	55	03/91 → 10/93
2.0	Petrol	79	03/95 → 08/96
2.0	Petrol	85	02/90 → 08/96
2.0 16V	Petrol	110	01/94 → 08/96
2.0 16V	Petrol	100	08/88 → 09/93

PASSAT Tre volumi (32B)

1.6	Petrol	53	01/85 → 03/88
1.6	Petrol	55	01/85 → 03/88
1.6 TD	Diesel	51	01/85 → 03/88
1.8	Petrol	66	01/85 → 03/88
2.2	Petrol	85	01/85 → 03/88

PASSAT Variant (32B)

1.3	Petrol	40	08/82 → 07/83
1.3	Petrol	44	08/82 → 07/86
1.3	Petrol	44	08/82 → 07/86
1.6	Petrol	51	08/87 → 03/88
1.6	Petrol	53	02/86 → 03/88
1.6	Petrol	55	08/82 → 03/88
1.6	Petrol	63	08/82 → 02/83
1.8	Petrol	64	05/86 → 03/88
1.8	Petrol	66	01/83 → 03/88
1.8 Syncro	Petrol	66	01/86 → 03/88
1.9	Petrol	85	08/82 → 07/83
2.0	Petrol	85	08/83 → 03/88
2.2	Petrol	100	01/85 → 03/88
2.2	Petrol	85	08/85 → 03/88
2.2 Syncro	Petrol	88	08/85 → 03/88

PASSAT Variant (3A5, 35I)

1.6	Petrol	74	07/94 → 12/95
1.6	Petrol	53	04/88 → 09/91
1.6	Petrol	55	04/88 → 12/88
1.6 TD	Diesel	59	08/88 → 09/93
1.8	Petrol	102	08/91 → 09/93
1.8	Petrol	55	08/90 → 05/97
1.8	Petrol	66	02/88 → 05/97
1.8	Petrol	79	04/88 → 07/90
1.8	Petrol	82	04/88 → 07/92
1.8 G60 Syncro	Petrol	118	08/88 → 05/97
1.9 D	Diesel	50	05/89 → 10/93
1.9 TD	Diesel	55	03/91 → 10/93
2.0	Petrol	79	03/95 → 08/96
2.0	Petrol	85	02/90 → 05/97

SAA104



KW



VOLKSWAGEN

PASSAT Variant (3A5, 35I)

2.0 16V	Petrol	110	01/94 → 05/97
2.0 16V	Petrol	100	08/88 → 09/93

POLO (86C, 80)

1.0	Petrol	29	10/81 → 10/86
1.0 Cat.	Petrol	33	08/89 → 09/94
1.1	Petrol	37	10/81 → 09/89
1.3	Petrol	44	10/81 → 07/83
1.3 Cat.	Petrol	40	07/87 → 09/94
1.3 Cat.	Petrol	55	10/89 → 03/91
1.3 D	Diesel	33	08/86 → 07/90
1.4 D	Diesel	35	10/90 → 09/94

POLO CLASSIC (6KV2)

100 1.6	Petrol	74	12/95 → 06/98	CHASSIS: → 6KX520000
75 1.6	Petrol	55	11/95 → 09/97	
90 1.8	Petrol	66	01/97 → 09/01	

POLO CLASSIC (86C, 80)

1.0	Petrol	29	01/85 → 10/86
1.0	Petrol	33	01/85 → 09/94
1.3 Cat.	Petrol	40	07/87 → 09/94
1.3 D	Diesel	33	08/86 → 12/88

POLO Coupé (86C, 80)

1.0	Petrol	29	05/82 → 10/86
1.0 Cat.	Petrol	33	08/89 → 09/94
1.1	Petrol	37	10/81 → 07/83
1.3	Petrol	44	10/81 → 07/83
1.3 Cat.	Petrol	40	07/87 → 08/94
1.3 Cat.	Petrol	55	10/89 → 09/94
1.3 D	Diesel	33	08/86 → 08/90
1.3 G40	Petrol	83	08/90 → 09/94
1.3 G40	Petrol	85	01/87 → 08/90
1.4 D	Diesel	35	08/90 → 09/94

POLO Variant (6KV5)

1.6	Petrol	74	05/97 → 06/98	CHASSIS: → 6KX520000
-----	--------	----	---------------	-------------------------

SANTANA (32B)

1.3	Petrol	44	08/82 → 07/83
1.6	Petrol	55	08/82 → 12/84
1.6	Petrol	63	08/82 → 12/82
1.8	Petrol	66	01/83 → 12/84
1.9	Petrol	85	08/82 → 07/83
2.0	Petrol	85	08/83 → 12/84

SAA104



KW



VOLKSWAGEN

SCIROCCO (53B)

1.3	Petrol	44	08/82 → 12/83
1.5	Petrol	51	08/82 → 12/83
1.6	Petrol	53	04/86 → 07/90

SCIROCCO (53B)

1.6	Petrol	55	01/83 → 12/89
1.6	Petrol	63	08/82 → 04/84
1.8	Petrol	66	08/83 → 07/92
1.8	Petrol	70	11/85 → 07/92
1.8	Petrol	82	08/82 → 12/89
1.8 16V	Petrol	102	10/85 → 07/89
1.8 16V	Petrol	95	03/86 → 07/92

SHARAN (7M8, 7M9, 7M6)

2.0	Petrol	85	09/95 → 03/10	CHASSIS: → 7MX020014
-----	--------	----	---------------	-------------------------

TRANSPORTER IV Autobus (70XB, 70XC, 7DB, 7DW)

1.8	Petrol	49	12/90 → 07/92	
1.9 TD	Diesel	50	10/92 → 04/03	CHASSIS: → 70X033612
2.0	Petrol	62	09/90 → 04/03	CHASSIS: → 70X033612
2.5	Petrol	81	11/90 → 04/03	CHASSIS: → 70X053924
2.5 Syncro	Petrol	81	11/92 → 04/03	CHASSIS: → 70X053924

TRANSPORTER IV Furgonato (70XA)

2.5	Petrol	85	08/96 → 04/03	CHASSIS: → 70X053924
2.5 Syncro	Petrol	85	08/96 → 04/03	CHASSIS: → 70X053924

TRANSPORTER IV Pianale piatto/Telaio (70XD)

2.0	Petrol	62	07/90 → 04/03	CHASSIS: → 70X033612
2.5	Petrol	81	11/90 → 04/03	CHASSIS: → 70X053924
2.5	Petrol	85	08/96 → 04/03	CHASSIS: → 70X053924
2.5 Syncro	Petrol	81	10/92 → 04/03	CHASSIS: → 70X053924
2.5 Syncro	Petrol	85	08/96 → 04/03	CHASSIS: → 70X053924

VENTO (1H2)

1.4	Petrol	44	11/91 → 09/98
1.4	Petrol	40	11/91 → 09/98
1.6	Petrol	55	09/92 → 09/98

SAA104

VOLKSWAGEN
VENTO (1H2)

1.6	Petrol	74	10/94 → 09/98	CHASSIS: → 1HX015000
1.8	Petrol	55	11/91 → 09/98	
1.8	Petrol	66	11/91 → 09/98	
2.0	Petrol	85	11/91 → 09/98	

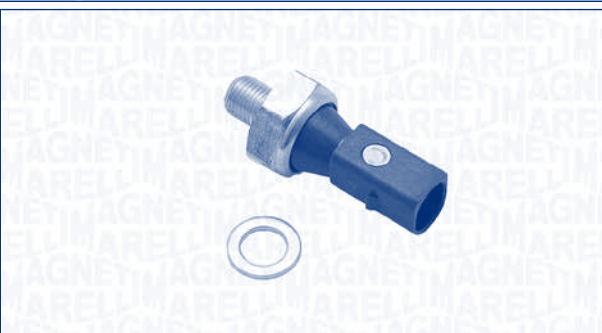
SAA105
**INTERRUTTORE PRESSIONE OLIO
OIL PRESSURE SWITCH**

AUDI
A1 (8X1, 8XF)

2.0 TDi	Diesel	105	09/11 →	
2.0 TDi	Diesel	100	05/12 →	

A1 Sportback (8XA, 8XK)

2.0 TDi	Diesel	100	05/12 →	
---------	--------	-----	---------	--

A2 (8Z0)

1.4	Petrol	55	02/00 → 08/05	
1.6 FSI	Petrol	81	05/02 → 08/05	

A3 (8P1)

1.4 TFSI	Petrol	92	09/07 → 08/12	
1.6 FSI	Petrol	85	08/03 → 09/07	

A3 (8V1)

1.4 TFSI	Petrol	90	04/12 →	
----------	--------	----	---------	--

A3 Sportback (8PA)

1.4 TFSI	Petrol	92	09/07 → 03/13	
----------	--------	----	---------------	--

A3 Sportback (8PA)

1.6 FSI	Petrol	85	09/04 → 09/07	
---------	--------	----	---------------	--

A8 (4H_)

4.2 FSI quattro	Petrol	273	11/09 →	
-----------------	--------	-----	---------	--

TT Roadster (8J9)

2.0 TDi quattro	Diesel	125	06/08 →	
-----------------	--------	-----	---------	--

SAA105

SEAT
ALHAMBRA (710)

2.0 TDi	Diesel	100	06/10 → 05/11	
2.0 TDi	Diesel	103	06/10 →	
2.0 TDi	Diesel	125	06/10 →	
2.0 TDi	Diesel	85	05/11 →	
2.0 TDi 4Drive	Diesel	103	05/11 →	

ALTEA (5P1)

1.4 16V	Petrol	63	05/06 →	
1.4 TSI	Petrol	92	11/07 → 06/09	
1.6 TDi	Diesel	66	11/10 →	
1.6 TDi	Diesel	77	10/09 →	
2.0 TDi	Diesel	125	03/06 →	
2.0 TDi 16V	Diesel	103	03/04 → 09/11	

ALTEA XL (5P5, 5P8)

1.4 16V	Petrol	63	10/06 →	
1.4 TSI	Petrol	92	11/07 → 06/09	
1.6 TDi	Diesel	66	11/10 →	
1.6 TDi	Diesel	77	10/09 →	
2.0 TDi 16V	Diesel	103	09/10 → 05/11	

AROSA (6H)

1.4 16V	Petrol	74	01/00 → 06/04	
---------	--------	----	---------------	--

CORDOBA (6K2)

1.0	Petrol	37	06/99 → 10/02	
1.4	Petrol	44	06/99 → 10/02	
1.4 16V	Petrol	55	05/00 → 10/02	
1.4 16V	Petrol	74	02/00 → 10/02	

CORDOBA (6L2)

1.2	Petrol	47	10/02 → 06/06	
1.2 12V	Petrol	51	05/06 → 11/09	
1.4 16V	Petrol	55	09/02 → 12/07	
1.4 16V	Petrol	63	05/06 → 11/09	
1.4 16V	Petrol	74	10/02 → 11/09	
1.6	Petrol	74	04/03 → 11/09	
1.6 16V	Petrol	77	11/06 → 11/09	

CORDOBA Vario (6K5)

1.4	Petrol	44	06/99 → 12/02	
1.4 16V	Petrol	55	06/99 → 12/02	

IBIZA III (6K1)

1.0	Petrol	37	08/99 → 02/02	
1.4	Petrol	44	08/99 → 02/02	
1.4 16V	Petrol	55	05/00 → 02/02	
1.4 16V	Petrol	74	08/99 → 02/02	
1.6	Petrol	74	08/99 → 02/02	
1.8 T 20V Cupra	Petrol	115	07/00 → 02/02	

SAA105



kW



SEAT

IBIZA IV (6L1)

1.2	Petrol	47	02/02 → 06/06
1.2 12V	Petrol	51	05/06 → 11/09
1.4 16V	Petrol	55	02/02 → 12/07
1.4 16V	Petrol	63	05/06 → 11/09
1.4 16V	Petrol	74	02/02 → 11/09
1.6	Petrol	74	02/03 → 11/09

IBIZA V (6J5)

1.2	Petrol	44	07/09 →
1.2	Petrol	51	03/08 →
1.2 TSI	Petrol	77	09/10 →
1.4	Petrol	63	03/08 →
1.4 TSI	Petrol	110	06/09 →
1.6	Petrol	77	05/08 →
1.6 LPG	Petrol/ LPG	60	05/11 →

IBIZA V SPORTCOUPE (6J1)

1.2	Petrol	44	07/09 →
1.2	Petrol	51	07/08 →
1.2 TSI	Petrol	77	09/10 →
1.4	Petrol	63	07/08 →
1.4 TSI	Petrol	110	06/09 →
1.4 TSI Cupra	Petrol	132	06/09 →
1.6	Petrol	77	07/08 →
1.6 LPG	Petrol/ LPG	60	05/11 →

IBIZA V ST (6J8)

1.2	Petrol	44	05/10 →
1.2	Petrol	51	05/10 →
1.2 TSI	Petrol	77	09/10 →
1.4	Petrol	63	03/10 →
1.4 TSI	Petrol	110	02/12 →
INCA (6K9)			
1.4 16V	Petrol	55	04/00 → 06/03

LEON (1M1)

1.4 16V	Petrol	55	11/99 → 06/06
1.6 16 V	Petrol	77	09/00 → 06/06

LEON (1P1)

1.4 16V	Petrol	63	06/06 →
1.4 TSI	Petrol	92	11/07 →
2.0 TDI 16V	Diesel	103	07/05 →
2.0 TFSI	Petrol	155	06/09 →

Mii (KF1_)

1.0	Petrol	44	10/11 →
1.0	Petrol	55	10/11 →

SAA105



kW



SEAT

TOLEDO II (1M2)

1.4 16V	Petrol	55	07/99 → 05/06
1.6 16V	Petrol	77	09/00 → 05/06

SKODA

CITIGO

1.0	Petrol	44	10/11 →
1.0	Petrol	55	10/11 →

FABIA

1.2	Petrol	44	12/06 →
1.2	Petrol	51	01/07 →
1.2 12V	Petrol	44	11/11 →
1.2 TDI	Diesel	55	05/10 →
1.4	Petrol	63	01/07 →
1.6	Petrol	77	04/07 →
1.6 TDI	Diesel	55	04/10 →
1.6 TDI	Diesel	77	03/10 →
1.6 TDI	Diesel	66	06/10 →

FABIA (6Y2)

1.2	Petrol	40	08/02 → 03/08
1.2	Petrol	47	01/03 → 03/08
1.4 16V	Petrol	55	12/99 → 03/08
1.4 16V	Petrol	74	12/99 → 03/08

FABIA Combi

1.2	Petrol	44	10/07 →
1.2	Petrol	51	10/07 →
1.2 12V	Petrol	44	11/11 →
1.2 TDI	Diesel	55	05/10 →
1.4	Petrol	63	10/07 →

1.6	Petrol	77	10/07 → 03/09	CHASSIS: → 5J9A509004
-----	--------	----	---------------	--------------------------

1.6 TDI	Diesel	55	04/10 →
1.6 TDI	Diesel	77	03/10 →
1.6 TDI	Diesel	66	06/10 →

FABIA Combi (6Y5)

1.2	Petrol	40	07/01 → 12/07
1.2	Petrol	47	01/03 → 12/07
1.4 16V	Petrol	55	05/00 → 12/07
1.4 16V	Petrol	59	04/06 → 12/07
1.4 16V	Petrol	74	04/00 → 12/07

FABIA Praktik

1.2	Petrol	40	07/01 → 12/07
1.2	Petrol	47	01/03 → 12/07

FABIA Tre volumi (6Y3)

1.2	Petrol	40	07/01 → 12/07
1.2	Petrol	47	01/03 → 12/07

SAA105

KW

SKODA
FABIA Tre volumi (6Y3)

1.4 16V	Petrol	55	10/99 → 12/07
1.4 16V	Petrol	59	04/06 → 12/07
1.4 16V	Petrol	74	12/99 → 12/07

OCTAVIA (1U2)

1.4 16V	Petrol	55	09/00 → 12/10
1.4	Petrol	55	05/04 → 05/06
1.4	Petrol	59	05/06 →
1.4 TSI	Petrol	90	11/08 →
1.6 FSI	Petrol	85	02/04 → 10/08
1.6 TDI	Diesel	77	06/09 →
2.0 TDI 16V	Diesel	103	02/04 →

OCTAVIA Combi (1U5)

1.4 16V	Petrol	55	08/00 → 12/10
1.4	Petrol	59	05/06 →
1.4 TSI	Petrol	90	11/08 →
1.6 FSI	Petrol	85	02/04 → 10/08
1.6 TDI	Diesel	77	06/09 →
1.6 TDI 4x4	Diesel	77	06/09 →
2.0 TDI 16V	Diesel	103	02/04 →
2.0 TDI 4x4	Diesel	81	05/11 →

ROOMSTER (5J)

1.2	Petrol	47	05/06 → 01/07
1.2	Petrol	51	01/07 →
1.4	Petrol	63	09/06 →
1.6	Petrol	77	09/06 →
1.6 TDI	Diesel	66	03/10 →
1.6 TDI	Diesel	77	03/10 →

ROOMSTER Praktik (5J)

1.2	Petrol	51	03/07 →
1.2 TDI	Diesel	55	03/10 →
1.4	Petrol	63	03/07 →
1.6 TDI	Diesel	66	03/10 →

SUPERB (3T4)

1.4 TSI	Petrol	92	07/08 → 03/09
2.0 TDi	Diesel	125	07/08 →
2.0 TDI 16V	Diesel	103	01/09 →
2.0 TDI 16V 4x4	Diesel	103	11/10 →
2.0 TDI 4x4	Diesel	125	09/08 →

SUPERB Station wagon (3T5)

2.0 TDi	Diesel	125	10/09 →
2.0 TDi	Diesel	103	10/09 → 03/10
2.0 TDI 16V	Diesel	103	10/09 →
2.0 TDI 16V 4x4	Diesel	103	11/10 →
2.0 TDI 4x4	Diesel	125	10/09 →

SAA105

KW

SKODA
YETI (5L)

2.0 TDi	Diesel	103	11/11 →
2.0 TDI 4x4	Diesel	103	05/09 →

VOLKSWAGEN
AMAROK (2H_, S1B)

2.0 BiTDI	Diesel	120	09/10 →
2.0 BiTDI 4motion	Diesel	120	09/10 →
2.0 TDi	Diesel	90	09/10 →
2.0 TDI 4motion	Diesel	132	11/11 →
2.0 TDI 4motion	Diesel	90	09/10 →

BEETLE (5C1)

1.6 TDI	Diesel	77	10/11 →
---------	--------	----	---------

BORA (1J2)

1.4 16V	Petrol	55	03/00 → 05/05
1.6 16V	Petrol	77	05/00 → 05/05
1.6 FSI	Petrol	81	01/02 → 05/05

BORA Station wagon (1J6)

1.4 16V	Petrol	55	09/01 → 05/05
1.6 16V	Petrol	77	02/00 → 05/05
1.6 FSI	Petrol	81	01/02 → 05/05

CADDY II Furgonato (9K9A)

1.4	Petrol	55	08/00 → 01/04
60 1.4	Petrol	44	11/95 → 01/04

CADDY II Station wagon (9K9B)

1.4	Petrol	44	11/95 → 01/04
1.4 16V	Petrol	55	08/00 → 01/04

CADDY III Furgonato (2KA, 2KH, 2CA, 2CH)

1.4	Petrol	55	03/04 → 05/06
1.4 16V	Petrol	59	05/06 → 08/10
1.6 TDI	Diesel	55	08/10 →
1.6 TDI	Diesel	75	08/10 →
2.0 TDi	Diesel	62	11/10 →
2.0 TDi	Diesel	125	05/12 →
2.0 TDi	Diesel	81	08/10 →
2.0 TDI 16V	Diesel	103	11/10 →
2.0 TDI 16V 4motion	Diesel	103	11/10 →
2.0 TDI 4motion	Diesel	62	12/10 →
2.0 TDI 4motion	Diesel	81	08/10 →

CADDY III Station wagon (2KB, 2KJ, 2CB, 2CJ)

1.4	Petrol	55	03/04 → 05/06
1.4 16V	Petrol	59	05/06 → 08/10
1.6 TDI	Diesel	55	08/10 →
1.6 TDI	Diesel	75	08/10 →

SAA105



KW



VOLKSWAGEN

CADDY III Station wagon (2KB, 2KJ, 2CB, 2CJ)

2.0 TDi	Diesel	125	05/12 →	
2.0 TDi	Diesel	81	08/10 →	
2.0 TDI 16V	Diesel	103	11/10 →	
2.0 TDI 16V 4motion	Diesel	103	11/10 →	
2.0 TDI 4motion	Diesel	81	08/10 →	

CC (358)

2.0 TDi	Diesel	103	11/11 →	
2.0 TDi	Diesel	125	11/11 →	

CRAFTER 30-35 Autobus (2E_)

2.0 TDi	Diesel	100	05/11 →	
2.0 TDi	Diesel	120	07/11 →	
2.0 TDi	Diesel	80	05/11 →	

CRAFTER 30-50 Furgonato (2E_)

2.0 TDi	Diesel	100	05/11 →	
2.0 TDi	Diesel	105	10/11 →	
2.0 TDi	Diesel	120	07/11 →	
2.0 TDi	Diesel	80	05/11 →	

CRAFTER 30-50 Pianale piatto/Telaio (2F_)

2.0 TDi	Diesel	100	05/11 →	
2.0 TDi	Diesel	105	10/11 →	
2.0 TDi	Diesel	120	07/11 →	
2.0 TDi	Diesel	80	05/11 →	

EOS (1F7, 1F8)

1.4 TSI	Petrol	118	05/08 → 10/10	
1.4 TSI	Petrol	90	11/07 → 10/10	
1.6 FSI	Petrol	85	06/06 → 05/08	
2.0 TDi	Diesel	100	11/10 →	

FOX (5Z1, 5Z3)

1.2	Petrol	40	04/05 →	
1.2	Petrol	44	09/10 →	
1.4	Petrol	55	04/05 →	

GOLF IV (1J1)

1.4 16V	Petrol	55	08/97 → 06/05	CHASSIS: 1JX250001 →
1.6 16V	Petrol	77	02/00 → 06/05	CHASSIS: 1JX250001 →
1.6 FSI	Petrol	81	01/02 → 06/05	
1.9 TDI	Diesel	74	09/00 → 12/01	

GOLF IV Variant (1J5)

1.4 16V	Petrol	55	05/99 → 06/06	CHASSIS: 1JX250001 →
1.6 16V	Petrol	77	02/00 → 06/06	CHASSIS: 1JX250001 →

SAA105



KW



VOLKSWAGEN

GOLF IV Variant (1J5)

1.6 FSI	Petrol	81	01/02 → 06/06	
---------	--------	----	---------------	--

GOLF PLUS (5M1, 521)

1.4 16V	Petrol	55	01/05 →	
1.4 16V	Petrol	59	05/06 →	
1.4 FSI	Petrol	66	07/05 →	
1.4 TSI	Petrol	103	05/06 → 06/08	
1.4 TSI	Petrol	118	06/08 →	
1.4 TSI	Petrol	125	05/06 → 06/08	
1.4 TSI	Petrol	90	06/07 →	
1.6 FSI	Petrol	85	01/05 → 05/08	

GOLF PLUS (5M1, 521)

1.6 TDI	Diesel	66	02/09 →	
1.6 TDI	Diesel	77	03/09 →	

GOLF V (1K1)

1.4 16V	Petrol	55	10/03 → 05/06	
1.4 16V	Petrol	59	05/06 → 11/08	
1.4 FSI	Petrol	66	10/03 → 07/06	
1.4 TSI	Petrol	103	05/06 → 11/08	
1.4 TSI	Petrol	125	11/05 → 11/08	
1.4 TSI	Petrol	90	08/07 → 11/08	
1.6 FSI	Petrol	85	10/03 → 07/08	

GOLF V Variant (1K5)

1.4	Petrol	59	08/07 → 07/09	
1.4 TSI	Petrol	103	06/07 → 07/09	
1.4 TSI	Petrol	125	06/07 → 07/09	
1.4 TSI	Petrol	118	07/08 → 07/09	

GOLF VI (5K1)

1.4	Petrol	59	10/08 → 11/12	
1.4 TSI	Petrol	118	10/08 → 11/12	
1.4 TSI	Petrol	90	10/08 → 11/12	
1.6 TDI	Diesel	66	02/09 → 11/12	
1.6 TDI	Diesel	77	02/09 → 11/12	
2.0 TDi	Diesel	100	10/08 → 11/12	

GOLF VI Cabriolet (517)

1.4 TSI	Petrol	90	11/11 →	
1.6 TDI	Diesel	77	03/11 →	
2.0 TDi	Diesel	103	11/11 →	

GOLF VI Variant (AJ5)

1.4 TSI	Petrol	118	07/09 → 12/11	
---------	--------	-----	---------------	--

JETTA III (1K2)

1.4 TSI	Petrol	103	07/06 → 10/10	
1.4 TSI	Petrol	118	07/08 → 10/10	
1.4 TSI	Petrol	125	07/06 → 10/10	
1.4 TSI	Petrol	90	07/07 → 10/10	

SAA105

KW

VOLKSWAGEN
JETTA III (1K2)

1.6 FSI Petrol 85 09/05 → 10/10

LUPO (6X1, 6E1)

1.0 Petrol 37 09/98 → 07/05

1.4 Petrol 44 10/00 → 07/05

1.4 16V Petrol 55 09/98 → 07/05

1.4 16V Petrol 74 08/99 → 07/05

1.4 FSI Petrol 77 02/01 → 07/05

1.6 GTI Petrol 92 09/00 → 07/05

MULTIVAN V (7HM, 7HN, 7HF, 7EF, 7EM, 7EN)

2.0 BiTDI Diesel 132 09/09 →

2.0 BiTDI 4motion Diesel 132 09/09 →

2.0 TDi Diesel 100 05/10 →

2.0 TDi Diesel 84 05/11 →

2.0 TDi Diesel 103 09/09 → 05/11

2.0 TDi Diesel 62 09/09 → 05/11

2.0 TDi Diesel 75 09/09 → 05/11

2.0 TDI 4motion Diesel 100 05/10 →

2.0 TDI 4motion Diesel 103 09/09 → 05/11

NEW BEETLE (9C1, 1C1)

1.4 Petrol 55 11/01 → 09/10

1.6 Petrol 74 10/99 → 09/00

1.8 T Petrol 132 11/01 → 12/01

1.9 TDi Diesel 74 07/01 → 12/01

2.3 V5 Petrol 125 10/00 → 12/01

2.5 Petrol 110 07/05 → 12/05

RSI 3.2 4motion (1C9) Petrol 165 07/00 → 05/01

NEW BEETLE Cabriolet (1Y7)

1.4 Petrol 55 01/03 → 09/10

2.5 Petrol 110 07/05 → 12/05

PASSAT (362)

1.6 TDi Diesel 77 08/10 →

2.0 TDi Diesel 100 08/10 →

2.0 TDi Diesel 103 08/10 →

2.0 TDi Diesel 125 08/10 →

2.0 TDI 4motion Diesel 103 08/10 →

2.0 TDI 4motion Diesel 125 08/10 →

PASSAT (3C2)

1.4 TSI Petrol 90 05/07 → 07/10

1.4 TSI EcoFuel BiFuel 110 01/09 → 07/10

1.6 FSI Petrol 85 03/05 → 06/08

1.6 TDi Diesel 77 08/09 → 07/10

SAA105

KW

VOLKSWAGEN
PASSAT CC (357)

2.0 TDi Diesel 100 06/08 → 05/11

2.0 TDi Diesel 103 06/08 → 01/12

2.0 TDi Diesel 125 08/08 → 01/12

2.0 TDI 4motion Diesel 103 08/09 → 01/12

2.0 TDI 4motion Diesel 125 11/09 → 01/12

PASSAT Variant (365)

1.6 TDi Diesel 77 08/10 →

2.0 TDi Diesel 100 08/10 →

2.0 TDi Diesel 103 08/10 →

2.0 TDi Diesel 125 08/10 →

2.0 TDI 4motion Diesel 103 08/10 →

2.0 TDI 4motion Diesel 125 08/10 →

PASSAT Variant (3C5)

1.4 TSI Petrol 90 05/08 → 11/10

1.4 TSI EcoFuel Petrol/CNG 110 01/09 → 11/10

1.6 FSI Petrol 85 08/05 → 06/08

1.6 TDi Diesel 77 08/09 → 11/10

POLO (6N1)

100 1.4 16V Petrol 74 04/96 → 10/99

120 1.6 16V GTI Petrol 88 09/98 → 10/99

55 1.4 Petrol 40 01/98 → 10/99

60 1.4 Petrol 44 07/95 → 10/99

POLO (6N2)

1.0 Petrol 37 10/99 → 09/01

1.4 Petrol 40 10/99 → 09/01

1.4 Petrol 44 10/99 → 09/01

1.4 16V Petrol 55 10/99 → 09/01

1.4 16V Petrol 74 10/99 → 09/01

1.6 16V GTI Petrol 92 10/99 → 09/01

POLO (6R, 6C)

1.2 Petrol 44 06/09 →

1.2 Petrol 51 06/09 →

1.2 TDi Diesel 55 10/09 →

1.2 TSI Petrol 77 11/09 →

1.2 TSI Petrol 66 05/11 → 05/14

1.4 Petrol 63 06/09 →

1.4 BiFuel Petrol/LPG 60 03/10 → 01/11

1.4 GTi Petrol 132 05/10 →

1.6 TDi Diesel 55 06/09 →

1.6 TDi Diesel 66 06/09 →

1.6 TDi Diesel 77 06/09 →

SAA105



KW



VOLKSWAGEN

POLO (9N_)

1.2	Petrol	40	01/02 → 05/07
1.2	Petrol	44	05/07 → 11/09
1.2 12V	Petrol	47	10/01 → 07/07
1.2 12V	Petrol	51	05/07 → 11/09
1.4 16V	Petrol	55	10/01 → 05/08
1.4 16V	Petrol	59	05/06 → 11/09
1.4 16V	Petrol	74	10/01 → 05/08
1.4 FSI	Petrol	63	02/02 → 07/06
1.6 16V	Petrol	77	05/06 → 11/09

POLO CLASSIC (6KV2)

60 1.4	Petrol	44	12/95 → 09/01
75 1.4 16V	Petrol	55	10/99 → 09/01

POLO Tre volumi (9A4)

1.4	Petrol	55	07/03 →
1.4	Petrol	74	11/03 →
1.6	Petrol	74	09/02 → 06/05

POLO Variant (6KV5)

1.4	Petrol	40	12/98 → 09/01
1.4	Petrol	44	05/97 → 09/01
1.4 16V	Petrol	55	10/99 → 09/01

SCIROCCO (137, 138)

1.4 TSI	Petrol	118	05/08 →
1.4 TSI	Petrol	90	11/08 →
2.0 TDi	Diesel	100	11/10 →
2.0 TDi	Diesel	103	08/08 →
2.0 TDi	Diesel	125	05/09 →

SHARAN (7N)

2.0 TDi	Diesel	100	05/10 →
2.0 TDi	Diesel	103	05/10 →
2.0 TDi	Diesel	125	08/10 →
2.0 TDi	Diesel	85	05/11 →
2.0 TDI 4motion	Diesel	100	05/11 → 05/12
2.0 TDI 4motion	Diesel	103	05/11 →

TIGUAN (5N_)

1.4 TSI	Petrol	110	05/08 →
1.4 TSI 4motion	Petrol	110	11/07 →
2.0 TDi	Diesel	103	03/08 →
2.0 TDi	Diesel	81	05/10 →
2.0 TDI 4motion	Diesel	100	11/07 →
2.0 TDI 4motion	Diesel	103	11/07 →
2.0 TDI 4motion	Diesel	125	02/08 →

SAA105



KW



VOLKSWAGEN

TOURAN (1T1, 1T2)

1.4 FSI	Petrol	125	11/06 → 05/10
1.4 TSI	Petrol	103	02/06 → 05/10
1.6 FSI	Petrol	85	02/03 → 01/07
1.6 TDI	Diesel	77	04/10 → 05/10

TOURAN (1T3)

1.6 TDI	Diesel	66	05/10 →
2.0 TDi	Diesel	81	11/10 →

TRANSPORTER V Autobus (7HB, 7HJ, 7EB, 7EJ, 7EF)

2.0 BiTDI	Diesel	132	09/09 →
2.0 BiTDI 4motion	Diesel	132	09/09 →
2.0 TDi	Diesel	103	09/09 →
2.0 TDi	Diesel	62	09/09 →
2.0 TDi	Diesel	75	09/09 →
2.0 TDi	Diesel	100	05/10 →
2.0 TDi	Diesel	84	05/11 →
2.0 TDI 4motion	Diesel	100	05/10 →
2.0 TDI 4motion	Diesel	103	05/10 →

TRANSPORTER V Furgonato (7HA, 7HH, 7EA, 7EH)

2.0 BiTDI	Diesel	132	09/09 →
2.0 BiTDI 4motion	Diesel	132	09/09 →
2.0 TDi	Diesel	103	09/09 →
2.0 TDi	Diesel	62	09/09 →
2.0 TDi	Diesel	75	09/09 →
2.0 TDi	Diesel	100	05/10 →

TRANSPORTER V Furgonato (7HA, 7HH, 7EA, 7EH)

2.0 TDi	Diesel	84	05/11 →
2.0 TDI 4motion	Diesel	103	09/09 →
2.0 TDI 4motion	Diesel	100	05/10 →

TRANSPORTER V Pianale piatto/Telaio (7JD, 7JE, 7JL, 7JY, 7JZ)

2.0 BiTDI	Diesel	132	09/09 →
2.0 BiTDI 4motion	Diesel	132	09/09 →
2.0 TDi	Diesel	103	09/09 →
2.0 TDi	Diesel	62	09/09 →
2.0 TDi	Diesel	75	09/09 →
2.0 TDi	Diesel	100	05/10 →
2.0 TDi	Diesel	84	05/11 →
2.0 TDI 4motion	Diesel	103	09/09 →
2.0 TDI 4motion	Diesel	100	05/10 →

SAA105

VOLKSWAGEN
UP

1.0	Petrol	44	08/11 →
1.0	Petrol	55	08/11 →

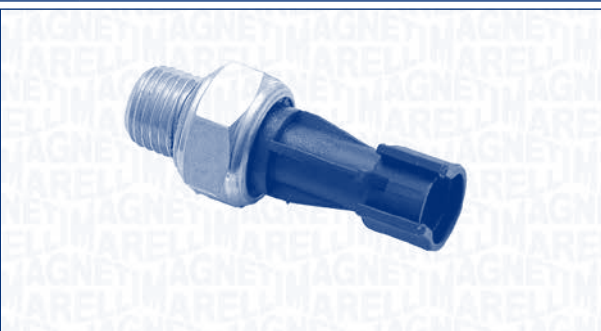
SAA101
**MANOCONTATTO
OIL PRESSURE SWITCH**

FIAT
CINQUECENTO (170)

0.9 (170AB)	Petrol	30	07/91 → 12/93
0.9 i.e. (170AC)	Petrol	30	07/91 → 12/93
0.9 i.e. S (170AF, 170CF)	Petrol	29	07/91 → 01/98

DUCATO Autobus (230)

1.9 TD Combinato	Diesel	59	08/94 → 04/02
1.9 TD Panorama/ Combinato	Diesel	60	03/94 → 04/02
2.0 Panorama/ Combinato	Petrol	80	03/94 → 04/02
2.5 D Combinato	Diesel	62	08/94 → 04/02
2.5 TDI Combinato	Diesel	80	08/94 → 04/02
2.5 TDI Panorama/ Combinato	Diesel	80	07/94 → 04/02
2.5 TDI Panorama/ Combinato	Diesel	85	03/94 → 04/02

DUCATO Furgonato (230L)

1.9 TD	Diesel	60	03/94 → 04/02
1.9 TD CAT	Diesel	59	08/94 → 04/02

SAA101

FIAT
DUCATO Pianale piatto/Telaio (230)

1.9 D	Diesel	51	03/94 → 04/02
1.9 TD	Diesel	60	03/94 → 04/02
1.9 TD CAT	Diesel	59	08/94 → 04/02
2.5 D	Diesel	62	03/94 → 04/02
2.5 D 4x4	Diesel	62	03/94 → 04/02
2.5 TDI	Diesel	80	03/94 → 04/02
2.5 TDI	Diesel	85	03/94 → 04/02

PUNTO (176)

1.6	Petrol	65	01/94 → 04/97
1.7 TD	Diesel	51	01/94 → 09/99
1.7 TD	Diesel	52	01/94 → 09/99
55 1.1	Petrol	40	09/93 → 09/99
60 1.2	Petrol	43	01/94 → 09/99
60 1.2	Petrol	44	03/94 → 09/99
75 1.2	Petrol	54	10/93 → 09/99

PUNTO Cabriolet (176C)

60 1.2	Petrol	43	04/94 → 06/00
60 1.2	Petrol	44	05/95 → 06/00
90 1.6	Petrol	65	04/94 → 04/97

PUNTO Van (176L)

1.7 TD	Diesel	52	04/96 → 02/00
--------	--------	----	---------------

TEMPRA (159)

1.4 i.e. (159.AC)	Petrol	57	03/91 → 08/96
1.4 i.e. (159.AC, 159.AX)	Petrol	51	03/92 → 08/96
1.6	Petrol	63	03/90 → 04/93
1.6 i.e. (159.AE)	Petrol	57	06/90 → 07/92
1.6 i.e. (159.AJ)	Petrol	63	06/94 → 08/96
1.6 i.e. (159.AJ)	Petrol	66	06/94 → 08/96
1.6 i.e. (159.AS, 159.AT)	Petrol	55	06/92 → 08/96
1.8 i.e. (159.AN)	Petrol	77	03/92 → 08/96
1.8 i.e. (159.AN)	Petrol	81	03/90 → 08/96
1.8 i.e. (159.AV)	Petrol	76	09/93 → 08/96
1.8 i.e. (159.AZ)	Petrol	66	09/93 → 08/96
1.8 i.e. (159.BY)	Petrol	74	10/94 → 08/96
1.9 D (159.AG)	Diesel	48	07/91 → 08/96
1.9 TD (159.AQ)	Diesel	59	07/92 → 08/96
1.9 TD (159.CU, 159.AU, 159.AI, 159.BI)	Diesel	66	05/90 → 08/96
2.0 i.e. (159.AP)	Petrol	83	10/90 → 08/96

SAA101



KW



FIAT

TEMPRA S.W. (159)

1.4 i.e. (159.AC)	Petrol	57	03/91 → 08/96
1.4 i.e. (159.AC, 159.AX)	Petrol	51	10/92 → 08/96
1.6	Petrol	63	12/90 → 04/93
1.6 i.e. (159.AE)	Petrol	57	10/90 → 08/96
1.6 i.e. (159.AJ)	Petrol	66	06/94 → 08/96
1.6 i.e. (159.AS, 159.AT)	Petrol	55	10/92 → 08/96
1.8 i.e. (159.AN)	Petrol	77	03/92 → 12/93
1.8 i.e. (159.AN)	Petrol	81	03/90 → 08/96
1.8 i.e. (159.AV)	Petrol	76	09/93 → 08/96
1.8 i.e. (159.AZ)	Petrol	66	09/93 → 08/96
1.8 i.e. (159.BY)	Petrol	74	10/94 → 08/96
1.9 D (159.AG)	Diesel	48	07/91 → 08/96
1.9 TD (159.AI, 159.BI, 159.CU, 159.AU)	Diesel	66	07/91 → 02/95
1.9 TD (159.AQ)	Diesel	59	03/92 → 06/93
2.0 i.e. (159.AP)	Petrol	83	01/91 → 03/95
2.0 i.e. 4x4 (159.AP)	Petrol	83	03/92 → 03/95

TIPO (160)

1.4 i.e.	Petrol	57	04/93 → 04/95
1.4 i.e. (160.AP, 160.AD, 160.EA)	Petrol	51	04/93 → 04/95
1.6 i.e. (160.A1, 160.EC, 160.EB)	Petrol	55	04/93 → 04/95
1.7 D (160.AG)	Diesel	45	04/93 → 10/95
1.8 i.e.	Petrol	71	03/93 → 04/95
1.8 i.e.	Petrol	66	09/93 → 04/95
1.8 i.e. (160.ED)	Petrol	76	04/93 → 04/95
1.8 i.e. (160.EQ, 160.AM)	Petrol	74	10/94 → 04/95
1.9 D	Diesel	48	04/93 → 08/96
1.9 TD (160.EL, 160.GL, 160.AQ, 160.EI, 160.AR)	Diesel	66	04/93 → 04/95
2.0 16V (160.AV)	Petrol	107	04/93 → 04/95
2.0 i.e. (160.AT, 160.AJ)	Petrol	83	04/93 → 04/95
2.0 i.e. 16V Sport (160.EF)	Petrol	102	03/93 → 04/95

SAA101



KW



LANCIA

DEDRA (835)

1.6 LE (835EB) Cat.	Petrol	66	07/94 → 07/99
1.8 i.e. (835FA)	Petrol	74	07/94 → 07/99
2.0 16V (835ED)	Petrol	102	07/94 → 07/99

DEDRA SW (835)

1.8 i.e. (835FA)	Petrol	74	07/94 → 07/99
1.9 TDS (835EE, 835EF)	Diesel	66	07/94 → 07/99
2.0 16V (835ED)	Petrol	102	07/94 → 07/99
2.0 Integrale (835ED)	Petrol	102	07/94 → 07/99

DELTA II (836)

1.6 i.e. (836AD)	Petrol	55	06/93 → 08/99
1.8 i.e. (836AE)	Petrol	76	06/93 → 08/99
2.0 16V (836AA, 836CA)	Petrol	102	06/93 → 08/99
2.0 16V Turbo (836AB)	Petrol	137	06/93 → 08/99

SAA106

**SENSORE PRESSIONE OLIO
OIL PRESSURE SWITCH**



KW



HONDA

ACCORD V (CC7, CD)

2.3 i SR	Petrol	116	03/93 → 01/96
----------	--------	-----	---------------

ACCORD VI (CG, CK)

2.2 Type-R	Petrol	156	02/99 → 12/02
------------	--------	-----	---------------

JAZZ I (AA)

45 1.2	Petrol	33	02/84 → 10/86
--------	--------	----	---------------

LEGEND I (HS, KA)

2.7 i 24V (KA4)	Petrol	124	01/88 → 12/90
-----------------	--------	-----	---------------

SAA106

HONDA
LEGEND I Coupé (KA3)

2.7 i 24V Petrol 124 10/87 → 12/90

NSX Cabriolet (NA)

3.0 24V Vtec Petrol 201 03/95 → 09/05

 3.0 24V Vtec
Automatic

Petrol 188 03/95 → 09/05

NSX Coupé (NA)

 3.0 24V Vtec
(NA1) Petrol 201 06/90 → 09/05

 3.0 24V Vtec
Automatic (NA1)

Petrol 188 06/90 → 09/05

PRELUDE IV (BB)

 2.2 i 16V Vtec
(BB1) Petrol 136 02/93 → 09/96

2.3 i 16V (BB2) Petrol 118 02/92 → 09/96

PRELUDE V (BB)

2.2 16V Petrol 147 10/96 → 10/00

QUINTET (SU)

1.6 EX Petrol 59 02/80 → 12/84

S2000 (AP)

2.0 Petrol 177 06/99 →

HYUNDAI
ATOS PRIME (MX)

1.1 Petrol 43 06/03 →

XG (XG)

30 Petrol 138 12/98 → 12/05

MARUTI
800

0.8 Petrol 26 01/91 → 12/06

MAZDA
626 II (GC)

1.6 Petrol 59 11/82 → 06/87

2.0 Petrol 68 11/86 → 09/87

2.0 Petrol 74 03/83 → 09/87

2.0 Petrol 88 01/86 → 09/87

626 II Hatchback (GC)

1.6 Petrol 59 03/83 → 09/87

2.0 Petrol 74 03/83 → 09/87

2.0 Petrol 88 01/86 → 09/87

626 III (GD)

2.0 Petrol 66 09/87 → 10/90

2.0 16V Petrol 109 07/87 → 09/89

SAA106

MAZDA
626 III Coupé (GD)

2.0 Petrol 66 09/87 → 10/90

2.0 16V Petrol 103 12/87 → 10/90

2.0 16V Petrol 109 06/87 → 09/89

626 III Hatchback (GD)

2.0 16V Petrol 103 11/87 → 10/90

2.0 16V Petrol 109 06/87 → 08/89

626 III Station Wagon (GV)

2.0 Petrol 66 10/88 → 09/97

2.2 12V Petrol 85 03/89 → 11/96

ROVER
600 (RH)

623 Si Petrol 116 08/93 → 02/99

800 (XS)

 827 Si/Sterling
(XS) Cat. Petrol 124 02/88 → 02/99

800 2 volumi /Coda spiovente (XS)

 827 24V I/SI (RS)
Cat. Petrol 124 01/92 → 02/99

 827 Vitesse (XS)
Cat. Petrol 124 10/88 → 12/91

800 Coupé

827 24V (RS) Petrol 124 08/92 → 02/99

SAA107
**SENSORE PRESSIONE OLIO
OIL PRESSURE SWITCH**

FIAT
126

600 Petrol 17 09/72 → 06/77

127

0.9 Petrol 33 06/71 → 05/83

500

0.5 Petrol 13 01/65 → 12/75

SAA107



FIAT

PANDA (141A_)

650	Petrol	22	01/82 → 07/04
650	Petrol	22	01/82 → 07/04
800	Petrol	25	02/81 → 12/85
900	Petrol	33	10/80 → 06/94
950	Petrol	35	09/82 → 08/83
750 (141AI)	Petrol	25	01/86 → 01/95
950 4x4	Petrol	35	09/83 → 12/86

PANDA Van (141_)

750	Petrol	25	01/86 → 07/92
-----	--------	----	---------------

UNO (146A/E)

45 0.9	Petrol	33	03/83 → 09/92
--------	--------	----	---------------

LANCIA

A 112

0.9 Junior (A112B/2)	Petrol	29	03/81 → 06/86
----------------------	--------	----	---------------

SEAT

FURA (025A)

0.9	Petrol	33	01/82 → 06/86
-----	--------	----	---------------

IBIZA I (021A)

0.9	Petrol	29	08/90 → 05/93
0.9	Petrol	32	08/86 → 05/93
1.2	Petrol	47	11/84 → 12/93

MARBELLA (28)

0.8	Petrol	25	08/86 → 12/93
0.9	Petrol	29	01/87 → 12/93

MARBELLA Furgonato (028A)

0.8	Petrol	25	01/87 → 12/93
0.9	Petrol	29	01/87 → 12/93

TERRA (24)

0.9	Petrol	29	02/87 → 12/96
-----	--------	----	---------------

SAA108

**SENSORE PRESSIONE OLIO
OIL PRESSURE SWITCH**

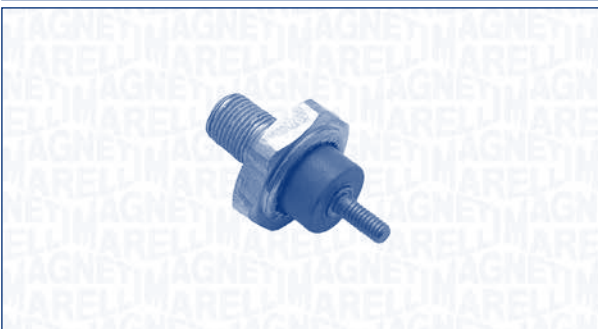

FORD

TRANSIT Autobus (E_ _)

2.5 DI (EBL, ECL, EDS, EDL)	Diesel	56	07/94 → 03/00
-----------------------------	--------	----	---------------

2.5 DI (EBL, EDL, EDS, ESL, ESS)	Diesel	85	08/97 → 03/00
----------------------------------	--------	----	---------------

2.5 DI (EBL, EDS, ESL, ESS, EUS)	Diesel	51	08/94 → 03/00
----------------------------------	--------	----	---------------

2.5 DI (EBS, EDS, EDL, ESS, EUS)	Diesel	51	08/91 → 07/94
----------------------------------	--------	----	---------------

2.5 DI (EBS, EDS, EGL, ESS, EUS)	Diesel	59	09/91 → 07/94
----------------------------------	--------	----	---------------

2.5 TD (EB_, ED_, ES_)	Diesel	55	08/94 → 06/00
------------------------	--------	----	---------------

2.5 TD (EBL, EDL, EDS, EGL, ESL, ESS, EUS)	Diesel	63	01/95 → 03/00
--	--------	----	---------------

2.5 TD (EBS, EBL, ECL, EDS, EDL, ESS, EUS)	Diesel	63	10/92 → 07/94
--	--------	----	---------------

2.5 TD (ECL, EDL, EDS, ESL, ESS, EUS)	Diesel	74	07/94 → 03/00
---------------------------------------	--------	----	---------------

2.5 TD (ECL, EDS, EDL, EGL, ESS, EUS)	Diesel	74	09/91 → 07/94
---------------------------------------	--------	----	---------------

TRANSIT Autobus (T_ _)

2.5 D (TBS, TCL, TCS, TEL, TES)	Diesel	50	12/85 → 01/89
---------------------------------	--------	----	---------------

2.5 D (TBS, TEL, TES)	Diesel	52	09/88 → 09/92
-----------------------	--------	----	---------------

SAA108

FORD
TRANSIT Furgonato (E_ _)

2.5 DI (EAL, EAS)	Diesel	51	06/94 → 03/00
2.5 DI (EAL, EAS)	Diesel	56	06/94 → 03/00
2.5 DI (EAL, EAS)	Diesel	85	05/99 → 03/00
2.5 TD (EAL, EAS)	Diesel	63	06/94 → 03/00
2.5 TD (EAS)	Diesel	55	10/98 → 03/00
2.5 TDI (EAL, EAS)	Diesel	74	06/94 → 03/00

TRANSIT Furgonato (T_ _)

2.5 D (TAL, TAS, TGL, TWS)	Diesel	52	10/88 → 09/91
----------------------------	--------	----	---------------

TRANSIT Pianale piatto/Telaio (E_ _)

2.5 DI (EME/L/S, ENE/L/S)	Diesel	56	08/94 → 03/00
2.5 DI (EME/L/S, ENE/L/S)	Diesel	59	09/91 → 08/94
2.5 DI (EML, ENE/L)	Diesel	85	05/99 → 03/00
2.5 DI (EML/S, ENL/S)	Diesel	51	08/94 → 03/00
2.5 DI (EML/S, ENL/S)	Diesel	51	09/91 → 08/94
2.5 TD (EME/L/S, ENE/L)	Diesel	74	09/91 → 08/94
2.5 TD (EME/L/S, ENE/L/S)	Diesel	55	10/98 → 07/00
2.5 TD (EME/L/S, ENE/L/S)	Diesel	63	08/94 → 03/00
2.5 TD (EME/L/S, ENE/L/S)	Diesel	74	08/94 → 03/00
2.5 TD (EME/L/S, ENE/L/S)	Diesel	63	11/92 → 08/94

TRANSIT Pianale piatto/Telaio (T_ _)

2.5 D (TTL, TTS, TUL, TUS, TTE) Cat.	Diesel	50	01/86 → 01/89
2.5 DI (TTE, TTL, TTS, TUL)	Diesel	52	09/88 → 09/92

SAA108

FORD
TRANSIT TOURNEO

2.5 DI	Diesel	51	11/94 → 12/00
2.5 DI	Diesel	56	11/94 → 12/00
2.5 TD	Diesel	63	11/94 → 12/00
2.5 TD	Diesel	74	04/98 → 12/00

SAA109
**SENSORE PRESSIONE OLIO
OIL PRESSURE SWITCH**

HONDA
ACCORD IV (CB)

2.0 16V (CB3)	Petrol	66	01/90 → 03/93
2.0 16V (CB3)	Petrol	81	01/90 → 03/93
2.0 i 16V (CB3)	Petrol	98	01/90 → 03/93
2.2 i 16V (CB7)	Petrol	110	01/90 → 03/93
2.2 i 16V Automatic (CB7)	Petrol	108	01/90 → 03/93

ACCORD IV Aerodeck (CB)

2.0 i 16V (CC9)	Petrol	98	03/93 → 12/93
2.2 i 16V (CB8)	Petrol	108	01/91 → 12/93
2.2 i 16V (CB8)	Petrol	110	01/91 → 12/93

ACCORD IV Coupé (CC1)

2.0 i 16V	Petrol	98	01/92 → 09/93
-----------	--------	----	---------------

ACCORD V (CC7, CD)

2.0 i	Petrol	85	03/93 → 01/96
2.0 i S	Petrol	96	03/93 → 01/96

ACCORD V Aerodeck (CE)

2.0 i LS 16V (CE2)	Petrol	100	09/93 → 02/98
2.2 i ES (CE1)	Petrol	110	09/93 → 02/98

ACCORD V Coupé (CD7, CD9)

2.0 (CD9)	Petrol	100	09/93 → 12/97
2.2 i ES (CD7)	Petrol	110	09/93 → 02/98

SAA109



KW



HONDA

ACCORD VI (CG, CK)

1.6 i	Petrol	85	10/98 → 12/02
1.8 i	Petrol	100	10/98 → 12/02
2.0 i	Petrol	108	10/98 → 01/01
2.3 (CK2)	Petrol	113	01/01 → 06/03

ACCORD VI Coupé (CG)

2.0 i 16V	Petrol	108	02/98 → 06/03
-----------	--------	-----	---------------

ACCORD VI Hatchback (CH)

1.8 i (CH6)	Petrol	100	12/99 → 12/02
2.0 (CH7)	Petrol	108	12/99 → 12/02
2.3 (CL4)	Petrol	113	11/00 → 12/02

CIVIC V Coupé (EJ)

1.6 i (EJ6)	Petrol	77	01/94 → 11/95
1.6 i Vtec	Petrol	118	01/94 → 11/95

CIVIC V Hatchback (EG)

1.3 16V (EG3)	Petrol	55	10/91 → 11/95
1.5 i 16V (EG4)	Petrol	66	10/91 → 11/95
1.5 i 16V (EG4)	Petrol	69	10/91 → 11/95
1.6 16V Vtec (EG5)	Petrol	92	10/91 → 11/95
1.6 VTi 16V (EG6)	Petrol	118	10/91 → 11/95

CIVIC V Tre volumi (EG, EH)

1.5 i 16V (EG8)	Petrol	69	10/91 → 11/95
1.6 16V Vtec (EH9)	Petrol	92	10/91 → 11/95
1.6 VTi (EG9)	Petrol	118	10/91 → 11/95

CIVIC VI Aerodeck (MB, MC)

1.5 16V (MB9)	Petrol	84	04/98 → 02/01
---------------	--------	----	---------------

CIVIC VI Coupé (EJ, EM1)

1.6 i	Petrol	77	03/96 → 03/00
-------	--------	----	---------------

CIVIC VI Hatchback (EJ, EK)

1.6 VTi (EK4)	Petrol	118	11/95 → 02/01
---------------	--------	-----	---------------

CIVIC VII Coupé (EM2)

1.6 i	Petrol	81	02/01 → 12/05
1.7 i	Petrol	88	05/01 → 12/05
1.7 i VTEC	Petrol	92	05/01 → 12/05

CIVIC VII Hatchback (EU, EP, EV)

1.4 iS (EP1)	Petrol	66	02/01 → 09/05
1.6 i	Petrol	81	02/01 → 09/05
2.0 i Sport	Petrol	118	09/01 → 09/05
2.0 Type-R	Petrol	147	09/01 → 09/05

CIVIC VII Tre volumi (ES)

1.6	Petrol	81	02/01 → 09/05
1.7 (EU3)	Petrol	85	02/01 → 09/05

SAA109



KW



HONDA

CR-V II (RD_)

2.0	Petrol	110	07/02 → 09/06
-----	--------	-----	---------------

CRX III (EH, EG)

1.6 ESi (EH6)	Petrol	92	03/92 → 12/98
1.6 i VTi (EG2)	Petrol	118	03/92 → 12/98

LEGEND II (KA7)

3.2 i 24V	Petrol	151	01/91 → 02/96
-----------	--------	-----	---------------

LEGEND II Coupé (KA8)

3.2 i 24V	Petrol	151	01/91 → 02/96
-----------	--------	-----	---------------

PRELUDE IV (BB)

2.0 i 16V (BB3)	Petrol	98	02/92 → 09/96
-----------------	--------	----	---------------

ROVER

600 (RH)

620 i	Petrol	85	08/93 → 06/96
620 Si	Petrol	96	08/93 → 02/99

SAA110

SENSORE PRESSIONE OLIO
OIL PRESSURE SWITCH



KW



DAIHATSU

APPLAUSE I (A101, A111)

1.6 16V (A101)	Petrol	66	06/89 → 07/97
1.6 16V (A101)	Petrol	77	06/89 → 07/97
1.6 16V 4WD (A111)	Petrol	77	06/89 → 07/97

APPLAUSE II (A101)

1.6 16V (A101)	Petrol	73	07/97 → 05/00
----------------	--------	----	---------------

CHARADE IV (G200, G202)

1.0	Petrol	38	09/94 → 03/96
1.3 i 16V	Petrol	62	01/93 → 09/00
1.6 GTI	Petrol	77	03/93 → 11/99

CHARADE IV Tre volumi (G203)

1.5 i 16V	Petrol	66	08/94 →
-----------	--------	----	---------

SAA110

DAIHATSU
CUORE II (L80, L81)

0.8 (L80)	Petrol	29	11/89 → 12/90
0.8 (L80)	Petrol	32	09/85 → 06/90
0.8 4WD (L81)	Petrol	32	09/86 → 10/88

CUORE III (L201)

0.8	Petrol	30	10/90 → 12/94
-----	--------	----	---------------

CUORE IV (L501)

0.8	Petrol	32	01/95 → 11/96
-----	--------	----	---------------

CUORE VI (L7_)

1.0 i (L701)	Petrol	41	10/98 → 05/03
--------------	--------	----	---------------

FEROZA Hard Top (F300)

1.6 16V	Petrol	63	10/88 → 12/99
1.6 i 16V 4x4	Petrol	70	10/88 → 12/99

FEROZA Soft Top (F300)

1.6 16V	Petrol	63	10/88 → 12/99
1.6 i 16V	Petrol	70	10/88 → 12/99

MOVE (L6, L9)

1.0 i	Petrol	41	10/98 →
-------	--------	----	---------

ROCKY Hard Top (F7, F8)

2.8 D	Diesel	54	02/85 → 12/98
-------	--------	----	---------------

ROCKY Soft Top (F7, F8)

2.8 D	Diesel	54	02/85 → 12/98
-------	--------	----	---------------

SIRION (M1)

1.0 i (M100)	Petrol	41	04/98 → 09/00
1.0 i 4WD	Petrol	41	04/99 → 09/00

TERIOS (J1)

1.3 4WD	Petrol	61	10/97 → 10/00
---------	--------	----	---------------

YRV (M2)

1.0	Petrol	43	02/01 →
1.3	Petrol	64	02/01 →
1.3 4WD	Petrol	64	02/01 →

KIA
BESTA Furgonato

2.2 D	Diesel	48	02/96 →
-------	--------	----	---------

PRIDE (DA)

1.1 i	Petrol	38	01/91 →
1.3 i	Petrol	51	01/90 →

PRIDE Station wagon

1.3	Petrol	47	08/99 →
-----	--------	----	---------

RETONA (CE)

2.0 TD	Diesel	61	06/99 →
--------	--------	----	---------

SPORTAGE (K00)

2.0 TD 4WD	Diesel	61	10/97 → 08/03
------------	--------	----	---------------

SAA110

MAZDA
121 I (DA)

1.1	Petrol	42	10/87 → 10/90
1.3	Petrol	44	10/87 → 11/90

323 III (BF)

1.3	Petrol	44	08/85 → 05/89
1.5	Petrol	54	09/87 → 10/89
1.5	Petrol	55	08/85 → 05/89
1.6 GT	Petrol	63	11/86 → 10/89
1.6 GT Turbo	Petrol	103	10/85 → 11/91

323 III Hatchback (BF)

1.1	Petrol	40	09/85 → 10/89
1.3	Petrol	44	09/85 → 12/87
1.5	Petrol	55	08/85 → 05/89

1.6 GT Turbo (BF1)	Petrol	103	10/85 → 08/93
--------------------	--------	-----	---------------

1.6 GT Turbo 4WD (BF2)	Petrol	110	08/87 → 10/89
------------------------	--------	-----	---------------

323 III Station Wagon (BW)

1.5	Petrol	54	01/87 → 05/89
1.5	Petrol	55	05/86 → 05/89
1.6	Petrol	63	09/86 → 10/95
1.7 D	Diesel	40	11/86 → 08/87
1.7 D	Diesel	42	11/86 → 10/89

626 II (GC)

2.0 D	Diesel	46	01/83 → 06/87
-------	--------	----	---------------

626 II Hatchback (GC)

2.0 D	Diesel	46	03/84 → 06/87
-------	--------	----	---------------

626 III (GD)

2.0 D	Diesel	44	07/87 → 07/91
2.2 12V	Petrol	85	11/87 → 07/91

626 III Coupé (GD)

2.2 12V	Petrol	85	04/88 → 12/91
---------	--------	----	---------------

626 III Hatchback (GD)

2.0	Petrol	66	09/87 → 10/90
2.0 D	Diesel	44	07/87 → 07/91
2.2 12V	Petrol	85	06/88 → 04/92

626 III Station Wagon (GV)

2.0 D	Diesel	44	09/88 → 07/91
2.0 D	Diesel	60	11/94 → 09/97
2.0 D Complex	Diesel	55	05/93 → 11/96

626 IV (GE)

2.0 D GLX Complex	Diesel	55	10/92 → 04/97
-------------------	--------	----	---------------

SAA110



MAZDA

626 IV Hatchback (GE)

2.0 D GLX Comprex	Diesel	55	01/93 → 04/97
-------------------	--------	----	---------------

929 III (HC)

2.2 12V	Petrol	85	01/88 → 04/89
2.2 i	Petrol	100	05/87 → 12/88
3.0	Petrol	125	01/88 → 12/89
3.0 i	Petrol	123	01/90 → 06/91

E-SERIE Furgonato (SR2)

E2200 D	Diesel	52	02/97 → 08/02
E2200 D 4WD	Diesel	52	02/97 → 05/03

OPEL

CAMPO (TF_)

2.5 TD (TFR54)	Diesel	56	07/94 →
2.5 TD 4x4 (TFS54)	Diesel	56	07/94 →

MONTEREY A (UBS_)

3.1 TD (UBS69_)	Diesel	84	09/91 → 07/98
-----------------	--------	----	---------------

SUZUKI

GRAND VITARA I (FT, GT)

2.0 TD	Diesel	64	03/98 → 07/03
--------	--------	----	---------------

TOYOTA

CARINA E Tre volumi (_T19_)

2.0 TD (CT190_)	Diesel	61	01/96 → 09/97
-----------------	--------	----	---------------

CARINA II (_T17_)

1.6 (AT171)	Petrol	75	12/87 → 03/92
1.6 (AT171)	Petrol	66	12/87 → 11/89

CARINA II (_T17_)

1.6 (AT171)	Petrol	72	12/87 → 03/92
-------------	--------	----	---------------

CARINA II Station Wagon (_T17_)

1.6 (AT171)	Petrol	75	12/87 → 03/92
1.6 (AT171)	Petrol	66	12/87 → 12/89

CELICA Coupé (AT18_, ST18_)

1.6 STI (AT180)	Petrol	77	10/89 → 11/93
-----------------	--------	----	---------------

COROLLA (_E10_)

1.6 Si (AE101_)	Petrol	84	09/95 → 04/97
-----------------	--------	----	---------------

COROLLA (_E9_)

1.6 (AE92)	Petrol	66	08/87 → 12/89
------------	--------	----	---------------

COROLLA Compact (_E10_)

1.6 Si (AE101_)	Petrol	84	07/92 → 04/97
-----------------	--------	----	---------------

COROLLA Compact (_E9_)

1.6 (AE92)	Petrol	66	08/87 → 04/92
1.6 GTi (AE92, AE93)	Petrol	85	08/87 → 04/92
1.6 i (AE92)	Petrol	77	08/89 → 04/92

SAA110



TOYOTA

COROLLA Compact (_E9_)

1.8 D (CE90)	Diesel	47	08/87 → 04/92
1.8 D (CE90)	Diesel	49	08/89 → 04/92

COROLLA Liftback (_E10_)

1.6 GLI (AE101_)	Petrol	84	07/92 → 04/97
------------------	--------	----	---------------

COROLLA Liftback (_E9_)

1.6 (AE92)	Petrol	77	08/89 → 04/92
1.6 (AE92)	Petrol	66	08/87 → 04/92
1.8 D (CE90)	Diesel	47	08/87 → 04/92
1.8 D (CE90)	Diesel	49	08/89 → 04/92

COROLLA Station Wagon (_E7_)

1.8 D (CE70)	Diesel	44	05/83 → 08/87
--------------	--------	----	---------------

COROLLA Station Wagon (_E9_)

1.6 (AE92)	Petrol	66	02/88 → 05/92
1.8 D (CE90)	Diesel	47	12/87 → 06/92
1.8 D (CE90)	Diesel	49	08/89 → 06/92

COROLLA Wagon (_E10_)

1.6 Si (AE101_)	Petrol	84	07/92 → 04/97
-----------------	--------	----	---------------

HIACE II Wagon (LH7_, LH5_, LH6_, YH7_, YH6_, YH5_)

2.4 D (H5G)	Diesel	55	08/84 → 08/89
-------------	--------	----	---------------

HIACE III Furgonato (YH7_, LH6_, LH7_, LH5_, YH5_, YH6_)

2.4 D 4WD	Diesel	55	08/89 → 08/95
-----------	--------	----	---------------

HIACE III Wagon (LH1_, RZH1_)

2.4 D	Diesel	57	08/89 → 08/95
2.4 D (LH102)	Diesel	55	08/89 → 08/95
2.4 D 4WD	Diesel	55	08/89 → 08/95

HIACE IV Autobus (LH1_)

2.4 D	Diesel	58	08/95 → 08/06
2.4 TD (LXH12_, LXH22_)	Diesel	66	08/95 → 08/06
2.4 TD 4WD (H18/28)	Diesel	66	08/95 → 08/06

HIACE IV Furgonato (LXH1_, RZH1_, LH1_)

2.4 D (LXH12_, LXH22_)	Diesel	58	08/95 → 08/06
2.4 TD (LXH12_, LXH22_)	Diesel	66	08/95 → 08/06
2.4 TD 4WD (LXH18_, LXH28_)	Diesel	66	08/95 → 08/06

HILUX II Pick-up (RN6_, RN5_, LN6_, YN6_, YN5_, LN5_)

2.4 D	Diesel	61	08/88 → 07/05
2.4 D	Diesel	59	01/92 → 07/05
2.4 D (LN150, LN145)	Diesel	55	07/98 → 01/02

SAA110

TOYOTA
HILUX II Pick-up (RN6_, RN5_, LN6_, YN6_, YN5_, LN5_)

2.4 D 4WD	Diesel	58	01/94 → 07/05
2.4 D 4WD	Diesel	61	08/88 → 07/05
2.4 TD 4WD	Diesel	66	08/98 → 01/02

LAND CRUISER (PZJ7_, KZJ7_, HZJ7_, BJ7_, LJ7_, RJ7_)

2.4 D (LJ70_)	Diesel	53	11/84 → 10/85
2.4 TD (LJ70_, LJ73_)	Diesel	63	10/85 → 05/90
3.4 TD (BJ71_V)	Diesel	91	10/85 → 08/86
4.2 TD (HZJ7_V)	Diesel	96	01/90 →

LAND CRUISER 80 (_J8_)

4.2 D (HZJ80_)	Diesel	99	01/90 → 12/97
----------------	--------	----	---------------

LITEACE Autobus (_R2_LG)

2.0 D (CR21LG)	Diesel	53	01/92 → 05/94
----------------	--------	----	---------------

LITEACE Autobus (CM30_G, KM30_G)

2.0 D (CM30LG)	Diesel	53	08/88 → 01/92
----------------	--------	----	---------------

LITEACE Furgonato (_R2_V)

2.0 D (CR27_V)	Diesel	51	01/92 → 05/94
----------------	--------	----	---------------

LITEACE Furgonato (CM3_V, KM3_V)

1.8 D (CM35_V)	Diesel	46	10/85 → 08/88
2.0 D (CM36_V)	Diesel	53	08/88 → 01/92

VOLKSWAGEN
TARO

2.4 D	Diesel	61	06/89 → 03/97
2.4 D 4x4	Diesel	61	04/89 → 03/97

SAA111
**SENSORE PRESSIONE OLIO
OIL PRESSURE SWITCH**

FIAT
SEDICI

1.6 16V 4x4	Petrol	79	06/06 →
-------------	--------	----	---------

SAA111

KIA
CARENS I (FC)

1.8 i	Petrol	81	11/00 → 07/02
-------	--------	----	---------------

CARENS II (FJ)

1.6	Petrol	77	07/02
1.8	Petrol	93	07/02

CARNIVAL I (UP)

2.5 V6	Petrol	121	08/99 → 10/01
2.9 TD	Diesel	93	08/99 → 10/01

CARNIVAL II (GQ)

2.5 V6	Petrol	110	10/01 →
--------	--------	-----	---------

CLARUS Station wagon (GC)

1.8 i 16V	Petrol	85	05/98 →
2.0 i 16V	Petrol	98	05/98 →

K2700 (SD)

2.7 D	Diesel	59	10/99 →
-------	--------	----	---------

PREGIO Furgonato (TB)

2.7 D	Diesel	60	10/97 →
-------	--------	----	---------

RETONA (CE)

2.0 16V	Petrol	94	05/00 →
---------	--------	----	---------

RIO Station wagon (DC)

1.3	Petrol	55	08/00 → 02/05
1.3	Petrol	60	08/00 → 02/05
1.5 16V	Petrol	71	09/02 → 02/05
1.5 16V	Petrol	72	08/00 → 02/05

RIO Tre volumi (DC_)

1.3	Petrol	55	09/00 → 02/05
1.3	Petrol	60	08/02 → 02/05
1.5 16V	Petrol	72	09/00 → 02/05

SHUMA (FB)

1.5 i 16V	Petrol	65	10/97 → 03/01
1.8 i 16V	Petrol	81	10/97 → 03/01

SHUMA II (FB)

1.6	Petrol	75	05/01 → 08/04
1.8	Petrol	84	04/03 → 08/04

SHUMA II Tre volumi (FB)

1.6	Petrol	75	05/01 → 05/04
-----	--------	----	---------------

SHUMA Tre volumi (FB)

1.5	Petrol	59	03/96 → 12/98
1.5 i 16V	Petrol	65	10/97 → 10/01

SPORTAGE (K00)

2.0	Petrol	87	10/00 → 08/03
2.0 4WD	Petrol	87	10/00 → 08/03
2.0 i 16V	Petrol	94	10/99 → 08/03
2.0 i 16V 4WD	Petrol	94	04/94 → 08/03
2.0 i 4WD	Petrol	70	04/94 → 08/99

SAA111



KW



LEXUS

ES (F1, F2)

250	Petrol	118	12/89 → 09/91
300	Petrol	138	09/91 → 12/97

LS (UCF10)

400	Petrol	180	12/89 → 12/94
-----	--------	-----	---------------

MAZDA

626 IV (GE)

1.8 i	Petrol	77	01/92 → 04/97
1.8 i	Petrol	66	08/94 → 04/97
2.0 i	Petrol	85	01/92 → 04/97

626 IV Hatchback (GE)

1.8	Petrol	77	08/91 → 04/97
1.8	Petrol	66	08/94 → 04/97
2.0 i	Petrol	85	08/91 → 04/97
2.5 24V	Petrol	120	08/94 → 04/97
2.5 24V	Petrol	121	01/92 → 04/97

MX-3 (EC)

1.8 i V6	Petrol	98	01/92 → 01/94
----------	--------	----	---------------

MX-6 (GE)

2.0	Petrol	85	02/92 → 02/97
2.5 24V	Petrol	121	02/92 → 02/97
2.5 i 24V	Petrol	120	08/94 → 02/97

XEDOS 6 (CA)

2.0 V6	Petrol	103	06/94 → 10/99
2.0 V6	Petrol	106	01/92 → 05/94

XEDOS 9 (TA)

2.0 24V	Petrol	105	08/93 → 01/00
2.3 24V	Petrol	155	02/95 → 01/00
2.5 24V	Petrol	123	07/93 → 07/00

MITSUBISHI

3000 GT (Z16A)

3.0 i 24V 4WD (Z16A)	Petrol	210	06/92 → 08/99
----------------------	--------	-----	---------------

CARISMA (DA_)

1.8 (DA2A)	Petrol	85	07/95 → 06/06
1.8 16V (DA2A)	Petrol	103	07/95 → 06/06

COLT III (C5_A)

1.6 GTi 16V (C53A)	Petrol	91	04/88 → 05/90
1.8 Diesel GLX (C54A)	Diesel	44	04/88 → 05/92
1.8 GTi 16V (C58A) Cat.	Petrol	100	06/90 → 05/92

SAA111



KW



MITSUBISHI

COLT IV (CA_A)

1.8 GTi 16V (CA5A)	Petrol	103	04/92 → 04/96
--------------------	--------	-----	---------------

COLT V (CJ_, CP_)

1300	Petrol	60	09/00 → 09/03
------	--------	----	---------------

ECLIPSE I (D2_A)

2.0 i 16V (D22A, D27A)	Petrol	110	04/91 → 11/95
2.0 i 16V 4WD (D22A, D27A)	Petrol	110	04/91 → 11/95

GALANT IV (E3_A)

1.8 (E32A)	Petrol	66	11/88 → 10/92
1.8 Turbo-D (E34A)	Diesel	55	11/88 → 10/92
2.0 (E39A, E38A, E33A)	Petrol	80	04/89 → 10/92
2.0 4WD (E33A, E38A, E39A)	Petrol	80	04/89 → 10/92
2.0 GTi 16V (E39A, E38A, E33A)	Petrol	106	11/88 → 10/92
2.0 GTi 16V (E39A, E38A, E33A)	Petrol	107	11/88 → 10/92

GALANT IV Tre volumi (E3_A)

1.8 (E32A)	Petrol	63	11/87 → 08/90
1.8 (E32A)	Petrol	66	11/87 → 10/92
1.8 Turbo-D (E34A)	Diesel	55	12/87 → 10/92
2.0 (E39A, E38A, E33A)	Petrol	80	11/87 → 10/92
2.0 4WD (E39A, E38A, E33A)	Petrol	80	12/88 → 10/92
2.0 GTi 16V (E39A, E38A, E33A)	Petrol	106	11/87 → 10/92
2.0 GTi 16V 4WD (E39A, E38A, E33A)	Petrol	106	06/88 → 10/92

GALANT V (E5_A, E7_A, E8_A)

2.0 GLSTD (E57A)	Diesel	66	11/92 → 08/96
2.0 V6-24 (E64A, E54A)	Petrol	110	11/92 → 08/96

SAA111

MITSUBISHI
GALANT V (E5_A, E7_A, E8_A)

2.5 V6-24 4WD (E88A)	Petrol	125	11/92 → 08/96
----------------------	--------	-----	---------------

GALANT V Tre volumi (E5_A, E7_A, E8_A)

2.0 GLSI (E55A)	Petrol	101	11/92 → 08/96
-----------------	--------	-----	---------------

2.0 GLSTD (E57A)	Diesel	66	11/92 → 08/96
------------------	--------	----	---------------

2.5 V6-24 4WD (E88A)	Petrol	125	11/92 → 08/96
----------------------	--------	-----	---------------

GRANDIS (NA_W)

2.4	Petrol	121	04/04 →
-----	--------	-----	---------

L 200 (K7_T, K6_T)

2.0 (K62T)	Petrol	90	06/96 → 12/07
------------	--------	----	---------------

2.4 4WD (K75T)	Petrol	97	06/96 → 12/07
----------------	--------	----	---------------

2.5 D (K64T)	Diesel	55	06/96 → 12/07
--------------	--------	----	---------------

2.5 TD 4WD (K74T)	Diesel	73	06/96 → 12/07
-------------------	--------	----	---------------

2.5 TD 4WD (K74T)	Diesel	85	09/01 → 12/07
-------------------	--------	----	---------------

L 300 Pianale piatto/Telaio (P1_T)

2.0 (P13T)	Petrol	85	07/94 → 04/00
------------	--------	----	---------------

2.5 TD (P15T)	Diesel	64	11/94 → 04/00
---------------	--------	----	---------------

L 400 / SPACE GEAR Autobus (PD_W, PC_W, PA_V, PB_V)

2.0 16V (PA3V/W, PB3V)	Petrol	85	05/95 → 05/00
------------------------	--------	----	---------------

2.4 i 4WD (PD4V/W)	Petrol	97	05/95 → 05/00
--------------------	--------	----	---------------

2.5 TD (PA5V/W, PB5V)	Diesel	73	05/95 → 05/00
-----------------------	--------	----	---------------

2.5 TD 4WD (PD5V/W)	Diesel	73	05/95 → 05/00
---------------------	--------	----	---------------

2500 TD	Diesel	64	05/95 → 06/05
---------	--------	----	---------------

L 400 Furgonato (PD_W, PC_W, PB_V, PA_W, PA_V)

2.0	Petrol	85	06/96 → 03/01
-----	--------	----	---------------

2500 TD (PD5W, PD5V, PA5W, PA5V)	Diesel	64	09/96 → 06/05
----------------------------------	--------	----	---------------

2500 TD 4WD (PD5W, PD5V, PA5W, PA5V)	Diesel	64	09/96 → 06/05
--------------------------------------	--------	----	---------------

LANCER III (C1_A, C6_A)

1.2 (C65A)	Petrol	44	08/86 → 04/88
------------	--------	----	---------------

1.8 Diesel (C14AS)	Diesel	43	01/84 → 09/86
--------------------	--------	----	---------------

SAA111

MITSUBISHI
LANCER III (C1_A, C6_A)

1.8 Diesel (C14AS)	Diesel	44	09/86 → 04/88
--------------------	--------	----	---------------

LANCER III Station Wagon (C1_V, C3_V)

1.5 12V (C12V)	Petrol	66	09/90 → 12/91
----------------	--------	----	---------------

1.8 4WD (C37V)	Petrol	63	03/89 → 12/90
----------------	--------	----	---------------

1.8 4WD (C37V)	Petrol	69	08/90 → 06/92
----------------	--------	----	---------------

1.8 D (C14V)	Diesel	43	09/85 → 09/86
--------------	--------	----	---------------

1.8 D (C14V)	Diesel	44	08/86 → 06/92
--------------	--------	----	---------------

LANCER IV (C6_A, C7_A)

1.8 4WD (C77A)	Petrol	71	09/89 → 06/92
----------------	--------	----	---------------

1.8 D (C64A)	Diesel	44	04/88 → 05/92
--------------	--------	----	---------------

1.8 GTi 16V (C68A)	Petrol	100	11/89 → 05/92
--------------------	--------	-----	---------------

1.8 GTi 16V (C69A)	Petrol	103	06/92 → 12/93
--------------------	--------	-----	---------------

LANCER IV Tre volumi (C6_A)

1.8 GLX Diesel (C64A)	Diesel	44	04/88 → 05/92
-----------------------	--------	----	---------------

LANCER V (CB/D_A)

2.0 Diesel (CB8A)	Diesel	50	06/92 → 12/96
-------------------	--------	----	---------------

LANCER V Station Wagon (CB_W, CD_W)

2.0 D (CB8W)	Diesel	50	12/92 → 10/03
--------------	--------	----	---------------

LANCER VI (CJ-CP_)

1.5 16V (CK2A)	Petrol	69	12/95 → 08/03
----------------	--------	----	---------------

2.0 16V EVO	Petrol	206	08/98 → 08/01
-------------	--------	-----	---------------

OUTLANDER I (CU_W)

2.0 (CU2W)	Petrol	100	05/03 → 10/06
------------	--------	-----	---------------

2.0 4WD	Petrol	177	05/03 → 10/06
---------	--------	-----	---------------

2.0 4WD (CU2W)	Petrol	100	05/03 → 10/06
----------------	--------	-----	---------------

2.0 4WD (CU2W)	Petrol	93	05/03 → 10/06
----------------	--------	----	---------------

2.0 Turbo 4WD (CU2W)	Petrol	148	04/04 → 10/06
----------------------	--------	-----	---------------

2.4 4WD	Petrol	102	05/03 → 10/06
---------	--------	-----	---------------

2.4 4WD (CU5W)	Petrol	118	11/03 → 10/06
----------------	--------	-----	---------------

2.4 4WD (CU5W)	Petrol	119	05/03 → 10/06
----------------	--------	-----	---------------

OUTLANDER II (CW_W)

2.4 4WD	Petrol	125	09/07 → 11/12
---------	--------	-----	---------------

PAJERO CLASSIC (V2_W)

2.5 TD	Diesel	85	07/02 →
--------	--------	----	---------

PAJERO I (L04_G, L14_G)

2.5 TD (L044G, L049G)	Diesel	64	01/90 → 12/91
-----------------------	--------	----	---------------

SAA111



MITSUBISHI

PAJERO I (L04_G, L14_G)

2.5 TD (L044G, L049G)	Diesel	70	11/89 → 11/90
-----------------------	--------	----	---------------

3.0 V6 (L141G, L146G)	Petrol	104	11/88 → 11/90
-----------------------	--------	-----	---------------

PAJERO I Canvas Top (L04_G)

2.3 TD (L043G, L048G)	Diesel	62	12/82 → 04/86
-----------------------	--------	----	---------------

2.5 TD (L044G, L049G)	Diesel	62	05/86 → 10/89
-----------------------	--------	----	---------------

2.5 TD (L044G, L049G)	Diesel	70	11/89 → 11/90
-----------------------	--------	----	---------------

2.6 (L042G, L047G)	Petrol	76	01/83 → 11/90
--------------------	--------	----	---------------

PAJERO II (V3_W, V2_W, V4_W)

2.5 TD 4WD (V24C, V24W)	Diesel	73	12/90 → 10/99
-------------------------	--------	----	---------------

3.0 V6 24V (V43W, V23W)	Petrol	130	06/97 → 10/99
-------------------------	--------	-----	---------------

3.0 V6 24V (V43W, V23W)	Petrol	133	06/94 → 05/97
-------------------------	--------	-----	---------------

3.0 V6 4WD (V23W, V43W, V23C)	Petrol	110	12/90 → 12/95
-------------------------------	--------	-----	---------------

3.5 V6 24V (V25W, V45W)	Petrol	153	06/94 → 10/99
-------------------------	--------	-----	---------------

3.5 V6 24V (V45W, V25W)	Petrol	143	07/97 → 10/99
-------------------------	--------	-----	---------------

PAJERO II Canvas Top (V2_W, V4_W)

2.5 TD 4WD (V24C, V24W)	Diesel	73	12/90 → 04/00
-------------------------	--------	----	---------------

3.0 V6 (V23W, V43W, V23C)	Petrol	110	12/90 → 12/95
---------------------------	--------	-----	---------------

3.0 V6 24V (V23W, V23C)	Petrol	133	06/94 → 04/00
-------------------------	--------	-----	---------------

PAJERO III Canvas Top (V6_W, V7_W)

2.5 TDi (V64W, V74W)	Diesel	73	04/00 → 12/06
----------------------	--------	----	---------------

3.2 DI-D (V68W, V78W)	Diesel	121	04/00 → 12/06
-----------------------	--------	-----	---------------

3.5 V6 GDI (V65W, V75W)	Petrol	149	04/00 → 12/06
-------------------------	--------	-----	---------------

PAJERO SPORT (K90)

2.5 TD (K94W)	Diesel	73	11/98 →
---------------	--------	----	---------

2.5 TD (K94W)	Diesel	85	07/02 →
---------------	--------	----	---------

SAA111



MITSUBISHI

PAJERO SPORT (K90)

2.5 TD (K94W)	Diesel	98	08/03 →
---------------	--------	----	---------

3.0 V6 (K96W)	Petrol	125	06/00 →
---------------	--------	-----	---------

3.0 V6 (K96W)	Petrol	130	11/98 →
---------------	--------	-----	---------

SPACE STAR (DG_A)

1.3 16V (DG1A)	Petrol	60	09/00 → 12/04
----------------	--------	----	---------------

1.3 16V (DG1A)	Petrol	61	12/98 → 12/04
----------------	--------	----	---------------

1.3 16V (DG1A)	Petrol	63	06/98 → 12/04
----------------	--------	----	---------------

1.6 16V (DG3A)	Petrol	72	01/01 → 12/04
----------------	--------	----	---------------

SUBARU

FORESTER (SF)

2.0	Petrol	90	08/97 → 09/02
-----	--------	----	---------------

2.0	Petrol	92	06/98 → 09/02
-----	--------	----	---------------

2.0 S Turbo	Petrol	125	06/98 → 04/01
-------------	--------	-----	---------------

IMPREZA Station wagon (GD, GG)

1.6 AWD	Petrol	70	12/00 →
---------	--------	----	---------

IMPREZA Station wagon (GF)

2.0 i 16V AWD	Petrol	92	06/98 → 12/00
---------------	--------	----	---------------

2.0 i Turbo AWD	Petrol	155	03/94 → 12/00
-----------------	--------	-----	---------------

2.0 Turbo GT AWD	Petrol	160	06/98 → 12/00
------------------	--------	-----	---------------

IMPREZA Tre volumi (GC)

1.8 i AWD	Petrol	76	08/92 → 12/00
-----------	--------	----	---------------

2.0 Turbo GT AWD	Petrol	155	03/94 → 12/00
------------------	--------	-----	---------------

2.0 Turbo GT AWD	Petrol	160	06/98 → 12/00
------------------	--------	-----	---------------

IMPREZA Tre volumi (GD, GG)

1.6 AWD	Petrol	70	12/00 →
---------	--------	----	---------

LEGACY I (BC)

1800	Petrol	76	01/89 → 12/93
------	--------	----	---------------

1800 4WD	Petrol	76	01/89 → 09/91
----------	--------	----	---------------

2000 4WD	Petrol	85	08/91 → 07/94
----------	--------	----	---------------

2000 Turbo 4WD	Petrol	147	05/92 → 07/94
----------------	--------	-----	---------------

2200 4WD	Petrol	100	01/89 → 07/94
----------	--------	-----	---------------

LEGACY I Station wagon (BC, BJJ)

1800	Petrol	76	01/89 → 07/94
------	--------	----	---------------

2000	Petrol	85	09/91 → 12/93
------	--------	----	---------------

1800 4WD	Petrol	76	01/89 → 07/94
----------	--------	----	---------------

2000 4WD	Petrol	85	09/91 → 07/94
----------	--------	----	---------------

2000 Turbo Super 4WD	Petrol	147	05/92 → 07/94
----------------------	--------	-----	---------------

2200 Super 4WD	Petrol	100	01/89 → 07/94
----------------	--------	-----	---------------

SAA111

SUBARU
LEGACY II (BD, BG)

2.0 i	Petrol	85	09/94 → 03/99
2.0 i 4WD	Petrol	85	09/94 → 03/99
2.2 i 4WD	Petrol	94	09/94 → 03/99
2.2 i 4WD	Petrol	96	06/96 → 03/99
2.5 i 4WD	Petrol	110	06/96 → 03/99

LEGACY II Station wagon (BD, BG)

2.0 i	Petrol	85	09/94 → 11/98
2.0 i 4WD	Petrol	85	09/94 → 11/98
2.2 i 4WD	Petrol	94	02/94 → 12/98
2.2 i 4WD	Petrol	96	06/96 → 11/98
2.5 i 4WD	Petrol	110	06/96 → 11/98

LEGACY III (BE, BH)

2.0	Petrol	92	04/99 → 08/03
2.5	Petrol	115	10/98 → 08/03

LEGACY III Station wagon (BE, BH)

2.0 AWD	Petrol	92	12/98 → 08/03
2.5 AWD	Petrol	115	12/98 → 08/03

TOYOTA
CAMRY (_CV1_, _XV1_, _V1_)

2.2 (SXV10)	Petrol	100	06/91 → 08/96
3.0 (VCV10)	Petrol	138	06/91 → 08/96

CAMRY (_V2_)

2.0 (SV21_, SV25_)	Petrol	94	11/86 → 05/91
2.0 Gli 16V (SV21_, SV25_)	Petrol	89	11/86 → 05/91
2.5 V6 GXI (VZV21_)	Petrol	118	02/88 → 05/91

CAMRY Station Wagon (_V2_)

2.0 GLi 16V (SV21_)	Petrol	89	11/86 → 05/91
---------------------	--------	----	---------------

CAMRY Station Wagon (_XV1_, _CV1_, _V10)

2.2 (SXV10)	Petrol	100	03/92 → 07/96
3.0 (VCV10)	Petrol	138	03/92 → 07/96

CARINA II (_T17_)

2.0 GLI (ST171)	Petrol	89	12/87 → 03/92
-----------------	--------	----	---------------

CELICA 2 volumi /Coda spiovente (ST16_, AT16_)

2.0 GT	Petrol	103	09/85 → 08/89
2.0 GT	Petrol	110	08/85 → 08/89

CELICA Cabriolet (AT18_, ST18_)

2.0 GTi (ST182)	Petrol	115	10/89 → 11/93
-----------------	--------	-----	---------------

SAA111

TOYOTA
CELICA Cabriolet (ST16_, AT16_)

2.0 GT (ST162)	Petrol	103	08/85 → 08/89
2.0 GT (ST162)	Petrol	110	10/86 → 08/89

CELICA Coupé (AT18_, ST18_)

2.0 GTi (ST182)	Petrol	115	10/89 → 11/93
-----------------	--------	-----	---------------

2.0 Turbo 4WD (ST185)	Petrol	150	10/89 → 11/93
-----------------------	--------	-----	---------------

2.0 Turbo 4WD (ST185)	Petrol	153	10/89 → 11/93
-----------------------	--------	-----	---------------

COROLLA (_E8_)

1.6 (AE82)	Petrol	53	08/85 → 08/87
------------	--------	----	---------------

COROLLA (_E9_)

1.3 i (EE90)	Petrol	55	08/87 → 12/92
--------------	--------	----	---------------

COROLLA Compact (_E9_)

1.3 (EE90)	Petrol	55	08/87 → 12/89
------------	--------	----	---------------

COROLLA Liftback (_E8_)

1.6 (AE82)	Petrol	54	08/85 → 08/87
------------	--------	----	---------------

COROLLA Liftback (_E9_)

1.3 i (EE90)	Petrol	55	08/87 → 04/92
--------------	--------	----	---------------

COROLLA Station Wagon (_E9_)

1.3 (EE90)	Petrol	55	12/87 → 06/92
------------	--------	----	---------------

HIACE III Furgonato (YH7_, LH6_, LH7_, LH5_, YH5_, YH6_)

2.4	Petrol	88	08/89 → 08/95
2.4 4WD	Petrol	88	08/89 → 08/95

HIACE III Wagon (LH1_, RZH1_)

2.0 (RZH102)	Petrol	74	08/89 → 04/98
2.4 (RZH103)	Petrol	88	08/89 → 08/95
2.4 4WD	Petrol	88	08/89 → 08/95

LITEACE Autobus (_R2_LG)

1.5 (KR21LG)	Petrol	52	01/92 → 01/95
--------------	--------	----	---------------

LITEACE Autobus (CM30_G, KM30_G)

1.5 (KM30LG)	Petrol	51	10/85 → 08/89
--------------	--------	----	---------------

LITEACE Furgonato (_R2_V)

1.5 (KR27_V)	Petrol	52	01/92 → 01/95
--------------	--------	----	---------------

MR 2 II (SW2_)

2.0 16V	Petrol	125	12/89 → 05/00
2.0 16V	Petrol	129	12/89 → 05/00
2.0 16V (SW20)	Petrol	115	12/89 → 05/00

PREVIA (TCR2_, TCR1_)

2.4	Petrol	97	05/90 → 08/00
-----	--------	----	---------------

SAA111



TOYOTA

STARLET (_P8_)

1.0 (EP80_)	Petrol	40	12/89 → 12/92
1.3 12V (EP81) Cat.	Petrol	55	12/89 → 03/96
1.3 12V (EP81_)	Petrol	55	12/89 → 12/92

TERCEL (AL2_)

1.5 4WD (AL25)	Petrol	50	05/86 → 01/88
----------------	--------	----	---------------

SAA112

**SENSORE PRESSIONE OLIO
OIL PRESSURE SWITCH**

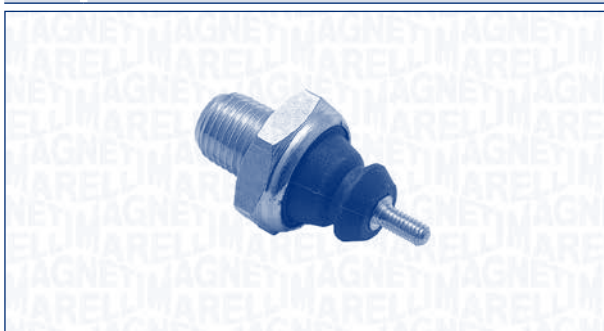

FORD

CAPRI III (GECP)

1.3	Petrol	40	01/78 → 06/85
-----	--------	----	---------------

COURIER Furgonato (F3L, F5L)

1.3	Petrol	44	09/91 → 02/96
1.8 D	Diesel	44	09/91 → 02/96

COURIER Furgonato (J5_, J3_)

1.3	Petrol	44	02/96 →
1.8 D	Diesel	44	02/96 →

ESCORT '86 Express (AVF)

1.3	Petrol	44	02/86 → 07/90
1.4 i	Petrol	54	02/86 → 07/90

ESCORT '95 Furgonato (AVL)

1.8 Turbo D	Diesel	51	12/95 → 06/01
-------------	--------	----	---------------

ESCORT CLASSIC (AAL, ABL)

1.6 16V	Petrol	66	10/98 → 07/00
1.8 TD	Diesel	66	10/98 → 07/00

ESCORT CLASSIC Turnier (ANL)

1.6 16V	Petrol	66	02/99 → 07/00
1.8 TD	Diesel	66	02/99 → 07/00

SAA112



FORD

ESCORT III (GAA)

1.1	Petrol	37	08/83 → 12/85
1.3	Petrol	51	09/80 → 12/85
1.6 XR3i	Petrol	77	10/82 → 12/85

ESCORT III Cabriolet (ALD)

1.3	Petrol	51	09/83 → 12/85
1.6 i	Petrol	77	09/83 → 12/85

ESCORT III Station wagon (AWA)

1.1	Petrol	37	08/83 → 12/85
1.3	Petrol	51	03/81 → 12/85

ESCORT IV (GAF, AWF, ABFT)

1.1	Petrol	37	12/85 → 07/90
-----	--------	----	---------------

ESCORT IV Cabriolet (ALF)

1.4	Petrol	54	02/87 → 07/90
1.6 XR3i	Petrol	77	01/86 → 07/90

ESCORT IV Station wagon (AWF, AVF)

1.3	Petrol	44	01/86 → 07/90
1.4	Petrol	54	01/86 → 07/90
1.8 D	Diesel	44	01/89 → 07/90

ESCORT V (GAL)

1.3	Petrol	44	07/90 → 09/92
1.4	Petrol	52	07/90 → 09/92
1.6	Petrol	77	07/90 → 12/92
1.8 16V XR3i	Petrol	77	02/92 → 12/92
1.8 16V XR3i	Petrol	96	02/92 → 12/92
1.8 D	Diesel	44	07/90 → 12/92
RS 2000	Petrol	110	05/91 → 12/92

ESCORT V Cabriolet (ALL)

1.4	Petrol	52	07/90 → 12/92
1.6	Petrol	77	07/90 → 12/92
1.8 16V XR3i	Petrol	77	02/92 → 12/92
1.8 16V XR3i	Petrol	96	02/92 → 12/92

ESCORT V Station wagon (GAL, AVL)

1.3	Petrol	44	09/91 → 09/92
1.4	Petrol	52	07/90 → 09/92
1.6	Petrol	77	07/90 → 09/92
1.8 16V	Petrol	77	02/92 → 12/92
1.8 D	Diesel	44	07/90 → 12/92

ESCORT VI (GAL)

1.3	Petrol	44	09/92 → 01/95
1.4	Petrol	55	01/94 → 01/95
1.4	Petrol	52	09/92 → 01/95
1.6 i 16V	Petrol	65	01/94 → 01/95
1.6 i 16V	Petrol	66	09/92 → 01/95
1.8 16V XR3i	Petrol	96	09/92 → 01/95

SAA112

FORD
ESCORT VI (GAL)

1.8 D	Diesel	44	09/92 → 01/95
1.8 i 16V	Petrol	77	09/92 → 01/95
1.8 XR3i 16V 4x4	Petrol	77	08/93 → 01/95
1.8 XR3i 16V 4x4	Petrol	96	08/93 → 01/95

ESCORT VII (GAL, AAL, ABL)

1.3	Petrol	44	01/95 → 10/98
1.6 16V	Petrol	66	01/95 → 10/98
1.6 16V 4x4	Petrol	66	01/95 → 10/98
1.8 16V	Petrol	77	01/95 → 08/95
1.8 16V	Petrol	85	01/95 → 10/98
1.8 D	Diesel	44	01/95 → 12/96
1.8 TD	Diesel	66	01/95 → 10/98
1.8 Turbo D	Diesel	51	12/95 → 10/98
RS 2000	Petrol	110	02/95 → 02/98
RS 2000 4x4	Petrol	110	02/95 → 10/98

ESCORT VII Cabriolet (ALL)

1.4	Petrol	55	02/95 → 08/98
1.6 16V XR3i	Petrol	65	02/95 → 12/96
1.6 16V XR3i	Petrol	66	02/95 → 09/99
1.8 16V XR3i	Petrol	77	02/95 → 08/98
1.8 16V XR3i	Petrol	85	10/95 → 08/98
1.8 TD	Diesel	66	09/95 → 08/98

ESCORT VII Station wagon (GAL, ANL)

1.3	Petrol	44	01/95 → 01/99
1.6 16V	Petrol	66	01/95 → 02/99
1.8 16V	Petrol	77	01/95 → 08/95
1.8 16V	Petrol	85	01/95 → 02/99
1.8 TD	Diesel	66	01/95 → 02/99
1.8 Turbo D	Diesel	51	12/95 → 02/99

ESCORT VII Tre volumi (GAL, AFL)

1.3	Petrol	44	01/95 → 02/99
1.6 i 16V	Petrol	66	01/95 → 02/99
1.8 16V	Petrol	77	01/95 → 08/95
1.8 16V	Petrol	85	01/95 → 02/99
1.8 D	Diesel	44	01/95 → 12/96
1.8 TD	Diesel	66	01/95 → 02/99
1.8 Turbo D	Diesel	51	12/95 → 02/99

FIESTA Furgonato (FVD)

1.8 D (FVJ)	Diesel	43	03/89 → 12/95
-------------	--------	----	---------------

FIESTA Furgonato (JV_)

D 1.8	Diesel	44	05/98 →
-------	--------	----	---------

SAA112

FORD
FIESTA I (GFBT)

0.9	Petrol	29	05/76 → 08/83
0.9	Petrol	33	05/76 → 08/83
1.1	Petrol	39	05/76 → 08/83
1.3	Petrol	49	08/77 → 08/83
1.6 XR2	Petrol	62	08/81 → 08/83

FIESTA II (FBD)

1.1 (FBD)	Petrol	36	05/86 → 02/89
1.1 (FBD)	Petrol	37	09/83 → 02/89
1.3 (FBD)	Petrol	51	09/83 → 01/87
1.4 (FBD)	Petrol	54	02/87 → 02/89
1.4 (FBD)	Petrol	55	10/85 → 11/89
1.6 D (FBD)	Diesel	40	04/84 → 02/89
1.6 XR2 (FBD)	Petrol	70	03/84 → 02/89
1.6 XR2 (FBD)	Petrol	71	04/84 → 02/89

FIESTA III (GFJ)

1.1	Petrol	37	03/89 → 12/95
1.1	Petrol	40	03/89 → 12/95
1.3 Cat.	Petrol	44	05/91 → 01/97
1.4	Petrol	54	03/89 → 12/95
1.4	Petrol	52	03/89 → 12/95
1.4 Cat.	Petrol	54	03/89 → 12/95
1.6	Petrol	65	01/89 → 01/94
1.6 i 16V	Petrol	65	01/94 → 12/95
1.6 XR2i	Petrol	76	03/89 → 03/93
1.6 XR2i	Petrol	81	03/89 → 01/94
1.8 D	Diesel	44	03/89 → 12/95

FIESTA IV (JA_, JB_)

1.0 i	Petrol	38	02/97 → 09/99
1.25 i 16V	Petrol	55	08/95 → 01/02
1.3 i	Petrol	37	08/95 → 01/02
1.3 i	Petrol	44	08/95 → 01/02
1.6 16V Sport	Petrol	76	02/00 → 01/02
1.8 D	Diesel	44	08/95 → 04/00

FIESTA V (JH_, JD_)

1.25 16V	Petrol	51	03/03 → 06/08
1.25 16V	Petrol	55	05/02 → 06/08
1.4 16V	Petrol	59	11/01 → 06/08
1.6 16V	Petrol	74	11/01 → 06/08

FOCUS (DAW, DBW)

1.4 16V	Petrol	55	10/98 → 11/04
1.6 16V	Petrol	74	10/98 → 11/04

FOCUS Station wagon (DNW)

1.4 16V	Petrol	55	02/99 → 11/04
1.6 16V	Petrol	74	02/99 → 11/04

SAA112



KW



FORD

FOCUS Tre volumi (DFW)

1.4 16V	Petrol	55	02/99 → 11/04
1.6 16V	Petrol	74	02/99 → 11/04

FUSION (JU_)

1.25	Petrol	55	08/04 →
1.4	Petrol	59	08/02 →
1.6	Petrol	74	08/02 →

GALAXY (WGR)

2.0 i	Petrol	85	11/95 → 05/06
2.3 16V	Petrol	103	09/01 → 05/06

KA (RB_)

1.3 i	Petrol	36	06/98 → 11/08
-------	--------	----	---------------

MONDEO I (GBP)

1.6 i 16V	Petrol	65	07/94 → 08/96
1.6 i 16V	Petrol	66	02/93 → 08/96
1.8 i 16V	Petrol	82	07/94 → 08/96
1.8 i 16V	Petrol	85	02/93 → 08/96
1.8 i 16V 4x4	Petrol	85	02/93 → 08/96
1.8 TD	Diesel	65	06/93 → 08/96
1.8 TD	Diesel	66	10/95 → 08/96
2.0 i 16V	Petrol	100	02/93 → 08/96
2.0 i 16V 4x4	Petrol	97	12/94 → 08/96
2.5 i 24V	Petrol	125	07/94 → 08/96

MONDEO I Station wagon (BNP)

1.6 i 16V	Petrol	65	07/94 → 08/96
1.6 i 16V	Petrol	66	04/93 → 08/96
1.8 i 16V	Petrol	82	07/94 → 08/96
1.8 i 16V	Petrol	85	04/93 → 08/96
1.8 i 16V 4x4	Petrol	85	04/93 → 08/96
1.8 TD	Diesel	65	06/93 → 08/96
1.8 TD	Diesel	66	11/95 → 08/96
2.0 i 16V	Petrol	100	04/93 → 08/96
2.0 i 16V 4x4	Petrol	100	04/93 → 08/96
2.0 i 16V 4x4	Petrol	97	12/94 → 08/96
2.5 i 24V	Petrol	125	07/94 → 08/96

MONDEO I Tre volumi (GBP)

1.6 i 16V	Petrol	65	07/94 → 08/96
1.6 i 16V	Petrol	66	02/93 → 08/96
1.8 i 16V	Petrol	82	01/94 → 08/96
1.8 i 16V	Petrol	85	02/93 → 08/96
1.8 TD	Diesel	65	06/93 → 08/96
1.8 TD	Diesel	66	10/95 → 08/96
2.0 i 16V	Petrol	100	02/93 → 08/96
2.0 i 16V 4x4	Petrol	97	12/94 → 08/96
2.5 i 24V	Petrol	125	07/94 → 08/96

SAA112



KW



FORD

ORION I (AFD)

1.3	Petrol	51	07/83 → 03/86
1.6 i	Petrol	77	07/83 → 03/86

ORION II (AFF)

1.6 i	Petrol	77	03/86 → 07/90
-------	--------	----	---------------

ORION III (GAL)

1.3	Petrol	44	07/90 → 12/93
1.4	Petrol	52	07/90 → 12/93
1.6	Petrol	66	07/90 → 12/92
1.6 i	Petrol	77	07/90 → 09/92
1.6 i 16V	Petrol	66	07/92 → 12/93
1.8 D	Diesel	44	11/90 → 12/93
1.8 i 16V	Petrol	77	02/92 → 12/93
1.8 TD	Diesel	66	03/92 → 12/93

P 100 II

1.8 TD	Diesel	55	10/87 → 12/92
2.0	Petrol	57	10/87 → 12/92

PUMA (EC_)

1.4 16V	Petrol	66	11/97 → 10/00
1.6 16V	Petrol	76	08/00 → 06/02

SCORPIO I (GAE, GGE)

2.0 i	Petrol	85	02/92 → 09/94
2.0 i	Petrol	88	05/89 → 09/94
2.4 i	Petrol	96	09/86 → 09/88
2.9 i	Petrol	107	09/86 → 09/94
2.9 i	Petrol	110	09/86 → 09/94
2.9 i 24V	Petrol	143	04/91 → 09/94
2.9 i 4x4	Petrol	107	05/88 → 02/93
2.9 i 4x4	Petrol	110	09/86 → 09/94
2.9 i Cat.	Petrol	107	10/87 → 09/94

SCORPIO I Station wagon (GGE)

2.0 i	Petrol	85	09/91 → 09/94
2.0 i	Petrol	88	09/91 → 09/94
2.9 24V	Petrol	143	08/93 → 09/94
2.9 i	Petrol	107	09/91 → 09/94
2.9 i 4x4	Petrol	107	05/88 → 02/93

SCORPIO I Tre volumi (GGE)

2.0 i	Petrol	85	02/92 → 09/94
2.0 i	Petrol	88	05/89 → 09/94
2.9 i 24V	Petrol	143	04/91 → 09/94
2.9 i 4x4	Petrol	107	12/89 → 10/94

SCORPIO II (GFR, GGR)

2.0 i	Petrol	85	10/94 → 08/98
2.0 i 16V	Petrol	100	10/94 → 08/98
2.9 i	Petrol	110	02/95 → 08/98

SAA112

FORD

2.9 i 24V Petrol 152 10/94 → 08/98

SCORPIO II Station wagon (GNR, GGR)

2.0 i Petrol 85 10/94 → 08/98

2.0 i 16V Petrol 100 10/94 → 08/98

2.9 i Petrol 110 02/95 → 08/98

2.9 i 24V Petrol 152 10/94 → 08/98

SIERRA 2 volumi /Coda spiovente (GBC)

1.3 Petrol 44 08/82 → 12/86

1.8 Petrol 66 10/84 → 12/86

2.0 Petrol 77 08/82 → 12/86

2.0 i Petrol 85 03/85 → 12/86

SIERRA 2 volumi /Coda spiovente (GBC, GBG)

2.0 i Petrol 92 06/89 → 02/93

SIERRA Station wagon (BNC)

1.8 Petrol 66 10/84 → 12/86

1.6 i Petrol 59 10/89 → 02/93

1.8 Petrol 64 05/88 → 02/93

1.8 TD Diesel 55 08/88 → 02/93

2.0 Petrol 77 01/87 → 02/93

TAUNUS '80 Turnier (GBNS)

1.6 Petrol 54 07/79 → 07/82

TRANSIT Autobus (E_ _)

2.0 Petrol 66 09/91 → 09/94

2.0 (EBL, EBS, ECL, EDS, EDL, EGL, ESS, ESL, EUS) Petrol 84 09/95 → 03/00

2.0 CNG Petrol/CNG 84 06/94 → 03/00

2.0 i (EBL, EDL, EGL, ESS, EUS) Petrol 72 09/91 → 07/94

2.9 i Petrol 107 01/91 → 09/94

TRANSIT Autobus (FD_ _ , FB_ _ , FS_ _ , FZ_ _ , FC_ _)

2.3 16V [RWD] (F_B_ , F_C_ , F_A_) Petrol 107 08/00 → 05/06

TRANSIT Autobus (T_ _)

1.6 (TBL, TES) Petrol 46 12/85 → 01/89

2.0 (TBS, TCL, TCS) Cat. Petrol 57 12/85 → 09/92

2.0 (TBS, TCL, TCS, TEL, TES) Petrol 57 11/85 → 09/92

TRANSIT Furgonato (E_ _)

2.0 Petrol 66 09/91 → 06/94

2.0 (EAL, EAS) Petrol 84 06/94 → 03/00

SAA112

FORD
TRANSIT Furgonato (FA_ _)

2.3 16V [RWD] (FAA_ , FAB_ , FAC_) Petrol 107 04/01 → 05/06

TRANSIT Furgonato (T_ _)

1.6 (TAS) Petrol 46 09/85 → 09/92

TRANSIT Pianale piatto/Telaio (E_ _)

2.0 (EME/L/S, ENE/L/S) Petrol 84 08/94 → 03/00

2.0 (EME/L/S, ENE/L/S) Petrol 72 09/91 → 08/94

TRANSIT Pianale piatto/Telaio (FM_ _ , FN_ _)

2.3 16V (F_A_ , F_B_ , F_C_ , F_D_) Petrol 107 04/01 → 05/06

TRANSIT Pianale piatto/Telaio (T_ _)

2.0 (TTE, TTL, TTS) Petrol 57 01/86 → 09/92

2.0 (TUL) Cat. Petrol 57 11/85 → 09/92

MAZDA
121 III (JASM, JBSM)

1.25 Petrol 55 03/96 → 04/03

1.3 Petrol 37 03/96 → 04/03

1.3 Petrol 44 03/96 → 04/03

1.8 D Diesel 44 03/96 → 04/03

SAA113
**SENSORE PRESSIONE OLIO
OIL PRESSURE SWITCH**

CITROËN
JUMPER Autobus

2.2 HDi 100 Diesel 74 04/06 →

2.2 HDi 120 Diesel 88 04/06 →

SAA113



KW



CITROËN

JUMPER Furgonato

2.2 HDi 100 Diesel 74 04/06 →

2.2 HDi 120 Diesel 88 04/06 →

JUMPER Pianale piatto/Telaio

2.2 HDi 100 Diesel 74 04/06 →

2.2 HDi 120 Diesel 88 04/06 →

FIAT

DUCATO Autobus (250)

100 Multijet 2,2 D Diesel 74 07/06 →

DUCATO Furgonato (250)

100 Multijet 2,2 D Diesel 74 07/06 →

DUCATO Pianale piatto/Telaio (250)

100 Multijet 2,2 D Diesel 74 07/06 →

FORD

COUGAR (EC_)

2.0 16V Petrol 96 08/98 → 12/01

COURIER Furgonato (J5_, J3_)

1.8 Di Diesel 55 09/00 →

FIESTA IV (JA_, JB_)

1.8 Di Diesel 55 04/00 → 01/02

FIESTA V (JH_, JD_)

1.3 Petrol 44 11/01 → 06/08

1.3 Petrol 51 11/01 → 06/08

FIESTA Van

1.3 Petrol 51 10/03 →

FOCUS (DAW, DBW)

1.8 16V Petrol 85 10/98 → 11/04

1.8 DI / TDDi Diesel 55 08/99 → 11/04

1.8 Turbo DI / TDDi Diesel 66 10/98 → 11/04

2.0 16V Petrol 96 10/98 → 11/04

RS Petrol 158 10/02 → 11/04

ST170 Petrol 127 03/02 → 11/04

FOCUS Station wagon (DNW)

1.8 16V Petrol 85 02/99 → 11/04

1.8 DI / TDDi Diesel 55 08/99 → 11/04

1.8 Turbo DI / TDDi Diesel 66 02/99 → 11/04

2.0 16V Petrol 96 02/99 → 11/04

ST170 Petrol 127 08/02 → 11/04

FOCUS Tre volumi (DFW)

1.8 16V Petrol 85 02/99 → 11/04

1.8 Turbo DI / TDDi Diesel 66 02/99 → 11/04

2.0 16V Petrol 96 02/99 → 11/04

SAA113



KW



FORD

KA (RB_)

1.3 i Petrol 51 08/02 → 11/08

1.6 i Petrol 70 07/03 → 11/08

MAVERICK

2.0 16V Petrol 91 02/01 →

MONDEO II (BAP)

1.6 i 16V Petrol 70 05/98 → 11/00

MONDEO II Station wagon (BNP)

1.6 i 16V Petrol 70 05/98 → 11/00

MONDEO II Tre volumi (BFP)

1.6 i 16V Petrol 70 05/98 → 11/00

MONDEO III (B5Y)

2.0 16V DI / TDDi / TDCi Diesel 66 11/00 → 08/07

2.0 16V TDDi / TDCi Diesel 85 11/00 → 08/07

2.0 TDCi Diesel 96 10/01 → 08/07

2.2 TDCi Diesel 114 09/04 → 08/07

MONDEO III Station wagon (BWY)

2.0 16V DI / TDDi / TDCi Diesel 66 11/00 → 08/07

2.0 16V TDDi / TDCi Diesel 85 11/00 → 08/07

2.0 TDCi Diesel 96 10/01 → 08/07

2.2 TDCi Diesel 114 09/04 → 08/07

MONDEO III Tre volumi (B4Y)

2.0 16V DI / TDDi / TDCi Diesel 66 11/00 → 08/07

MONDEO III Tre volumi (B4Y)

2.0 16V TDDi / TDCi Diesel 85 11/00 → 08/07

2.0 TDCi Diesel 96 10/01 → 08/07

2.2 TDCi Diesel 114 09/04 → 08/07

STREET KA (RL2)

1.6 Petrol 70 05/03 → 07/05

TOURNEO CONNECT

1.8 16V Petrol 85 06/02 →

TRANSIT Autobus

2.2 TDCi Diesel 63 04/06 →

2.2 TDCi Diesel 81 04/06 →

2.2 TDCi Diesel 96 04/06 →

2.4 TDCi Diesel 74 04/06 →

2.4 TDCi Diesel 85 04/06 →

2.4 TDCi Diesel 103 04/06 →

2.4 TDCi 4x4 Diesel 103 11/06 →

SAA113

FORD
TRANSIT Autobus

3.2 TDCi Diesel 147 02/08 →

TRANSIT Autobus (FD_-, FB_-, FS_-, FZ_-, FC_-,)

2.0 DI (F_E_, F_F_, F_G_) Diesel 55 08/00 → 05/06

2.0 DI (F_E_, F_F_, F_G_) Diesel 63 08/00 → 05/06

2.0 DI (F_E_, F_F_, F_G_) Diesel 74 08/00 → 05/06

2.0 TDCi (F_F_, F_E_, F_G_) Diesel 92 08/02 → 05/06

2.4 DI (F_B_, F_C_, F_A_) Diesel 66 01/00 → 05/06

2.4 DI [RWD] (F_B_, F_C_) Diesel 55 01/00 → 05/06

2.4 DI [RWD] (F_B_, F_C_, F_A_) Diesel 88 01/00 → 05/06

2.4 TDCi Diesel 101 03/04 → 05/06

2.4 TDE Diesel 85 03/04 → 05/06

2.4 TDE (F_C_, F_B_, F_A_) Diesel 92 07/01 → 05/06

2.4 TDE (F_C_, F_B_, F_A_) Diesel 92 07/01 → 05/06

TRANSIT CONNECT (P65_, P70_, P80_)

1.8 16V Petrol 85 06/02 →

TRANSIT Furgonato

2.2 TDCi Diesel 63 04/06 →

2.2 TDCi Diesel 81 04/06 →

2.2 TDCi Diesel 96 04/06 →

2.4 TDCi Diesel 74 04/06 →

2.4 TDCi Diesel 85 04/06 →

2.4 TDCi Diesel 103 04/06 →

3.2 TDCi Diesel 147 09/07 →

TRANSIT Furgonato (FA_-,)

2.0 DI (FAE_, FAF_, FAG_) Diesel 55 08/00 → 05/06

2.0 DI (FAE_, FAF_, FAG_) Diesel 63 08/00 → 05/06

2.0 DI (FAE_, FAF_, FAG_) Diesel 74 08/00 → 05/06

2.0 TDCi Diesel 92 08/02 → 05/06

2.4 DI (FAA_, FAB_, FAC_, FAD_) Diesel 66 01/00 → 05/06

SAA113

FORD
TRANSIT Furgonato (FA_-,)

2.4 DI [RWD] (FAA_, FAB_, FAC_, FAD_) Diesel 55 01/00 → 05/06

2.4 DI [RWD] (FAA_, FAB_, FAC_, FAD_) Diesel 88 01/00 → 05/06

2.4 TDCi Diesel 101 03/04 → 05/06

2.4 TDE Diesel 85 03/04 → 05/06

2.4 TDE Diesel 92 07/01 → 05/06

TRANSIT Pianale piatto/Telaio

2.2 TDCi Diesel 63 04/06 →

2.2 TDCi Diesel 81 04/06 →

2.2 TDCi Diesel 96 04/06 →

2.4 TDCi Diesel 74 04/06 →

2.4 TDCi Diesel 85 04/06 →

2.4 TDCi Diesel 103 04/06 →

2.4 TDCi 4x4 Diesel 103 11/06 →

3.2 TDCi Diesel 147 09/07 →

Pianale piatto/Telaio (FM_-, FN_-,)

2.0 DI (F_E_, F_F_) Diesel 55 08/00 → 05/06

2.0 DI (F_E_, F_F_) Diesel 63 08/00 → 05/06

2.0 DI (F_E_, F_F_) Diesel 74 08/00 → 05/06

2.0 TDCi (F_E_, F_F_) Diesel 92 08/02 → 05/06

2.4 DI (F_A_, F_B_, F_C_, F_D_) Diesel 55 01/00 → 05/06

2.4 DI (F_A_, F_B_, F_C_, F_D_) Diesel 66 01/00 → 05/06

2.4 DI (F_A_, F_B_, F_C_, F_D_) Diesel 88 01/00 → 05/06

2.4 TDCi Diesel 101 03/04 → 05/06

2.4 TDE Diesel 85 03/04 → 05/06

2.4 TDE Diesel 92 07/01 → 05/06

TRANSIT TOURNEO

2.2 TDCi Diesel 81 07/06 →

2.2 TDCi Diesel 96 07/06 →

PEUGEOT
BOXER Autobus

2.2 HDi 100 Diesel 74 04/06 →

2.2 HDi 120 Diesel 88 04/06 →

BOXER Furgonato

2.2 HDi 100 Diesel 74 04/06 →

2.2 HDi 120 Diesel 88 04/06 →

SAA113



PEUGEOT

BOXER Pianale piatto/Telaio

2.2 HDi 100	Diesel	74	04/06 →
2.2 HDi 120	Diesel	88	04/06 →

SAA115

**SENSORE PRESSIONE OLIO
OIL PRESSURE SWITCH**



FORD

C-MAX (DM2)

1.6	Petrol	74	02/07 →
1.8	Petrol	92	02/07 →
1.8 Flexifuel	Petrol/ Ethanol	92	02/07 →
1.8 TDCi	Diesel	85	02/07 →

FIESTA V (JH_, JD_)

ST150	Petrol	110	03/05 → 06/08
-------	--------	-----	---------------

FIESTA VI

1.25	Petrol	44	06/08 →
1.25	Petrol	60	06/08 →
1.4	Petrol	71	06/08 →
1.6 Ti	Petrol	88	06/08 →

FOCUS (DAW, DBW)

1.8 TDCi	Diesel	74	08/02 → 11/04
1.8 TDCi	Diesel	85	03/01 → 11/04

FOCUS C-MAX

1.6	Petrol	74	10/03 → 03/07
1.6 Ti	Petrol	85	08/04 → 03/07
1.8	Petrol	88	10/03 → 03/07

FOCUS C-MAX

1.8	Petrol	92	04/04 → 03/07
1.8 Flexifuel	Petrol/ Ethanol	92	01/06 → 03/07
1.8 TDCi	Diesel	85	01/05 → 03/07
2.0	Petrol	107	03/04 → 03/07

SAA115



FORD

FOCUS II (DA_)

1.4	Petrol	59	11/04 →
1.6	Petrol	74	11/04 →
1.6 Ti	Petrol	85	11/04 →
1.8 Flexifuel	Petrol/ Ethanol	92	01/06 →
1.8 TDCi	Diesel	85	01/05 →
2.0	Petrol	107	11/04 →

FOCUS II Cabriolet

1.6	Petrol	74	10/06 →
2.0	Petrol	107	10/06 →

FOCUS II Station wagon (DA_)

1.4	Petrol	59	11/04 →
1.6	Petrol	74	11/04 →
1.6 Ti	Petrol	85	11/04 →
1.8 Flexifuel	Petrol/ Ethanol	92	01/06 →
1.8 TDCi	Diesel	85	11/04 →
2.0	Petrol	107	11/04 →

FOCUS II Tre volumi (DA_)

1.4	Petrol	59	04/05 →
1.6	Petrol	74	04/05 →
1.6 Ti	Petrol	85	04/05 →
1.8 Flexifuel	Petrol/ Ethanol	92	06/06 →
1.8 TDCi	Diesel	85	04/05 →
2.0	Petrol	107	04/05 →

FOCUS Station wagon (DNW)

1.8 TDCi	Diesel	74	08/02 → 11/04
1.8 TDCi	Diesel	85	03/01 → 11/04

FOCUS Tre volumi (DFW)

1.8 TDCi	Diesel	74	08/02 → 11/04
1.8 TDCi	Diesel	85	03/01 → 11/04

GALAXY (WA6)

1.8 TDCi	Diesel	74	05/06 →
1.8 TDCi	Diesel	92	05/06 →
2.0	Petrol	107	05/06 →
2.3	Petrol	118	07/07 →

MAVERICK

2.3 16V	Petrol	110	03/04 →
---------	--------	-----	---------

MONDEO III (B5Y)

1.8 16V	Petrol	81	11/00 → 08/07
1.8 16V	Petrol	92	11/00 → 08/07
1.8 SCi	Petrol	96	06/03 → 08/07
2.0 16V	Petrol	107	11/00 → 08/07

SAA115

FORD
MONDEO III Station wagon (BWY)

1.8 16V	Petrol	81	11/00 → 08/07
1.8 16V	Petrol	92	11/00 → 08/07
1.8 SCi	Petrol	96	06/03 → 08/07
2.0 16V	Petrol	107	11/00 → 08/07

MONDEO III Tre volumi (B4Y)

1.8 16V	Petrol	81	11/00 → 08/07
1.8 16V	Petrol	92	11/00 → 08/07
1.8 SCi	Petrol	96	06/03 → 08/07
2.0 16V	Petrol	107	11/00 → 08/07

MONDEO IV (BA7)

1.6 Ti	Petrol	81	03/07 →
1.6 Ti	Petrol	92	03/07 →
1.8 TDCi	Diesel	74	03/07 →
2.0	Petrol	107	03/07 →
2.0 Flexifuel	Petrol/ Ethanol	107	03/09 →
2.3	Petrol	118	07/07 →

MONDEO IV Tre volumi (BA7)

2.0	Petrol	107	03/07 →
2.3	Petrol	118	07/07 →

MONDEO IV Turnier (BA7)

1.6 Ti	Petrol	81	03/07 →
1.6 Ti	Petrol	92	03/07 →
1.8 TDCi	Diesel	74	03/07 →
2.0	Petrol	107	03/07 →
2.3	Petrol	118	07/07 →

S-MAX (WA6)

1.8 TDCi	Diesel	92	05/06 →
2.0	Petrol	107	05/06 →
2.0 Flexifuel	Petrol/ Ethanol	107	05/06 →
2.3	Petrol	118	07/07 →

TOURNEO CONNECT

1.8 Di	Diesel	55	06/02 →
1.8 TDCi	Diesel	81	08/06 →
1.8 Turbo Di	Diesel	66	06/02 →

TRANSIT CONNECT (P65_, P70_, P80_)

1.8 Di	Diesel	55	06/02 →
1.8 TDCi	Diesel	66	06/02 →
1.8 TDCi	Diesel	81	08/06 →

TRANSIT Furgonato

2.3 16V	Petrol	107	04/06 →
---------	--------	-----	---------

TRANSIT Pianale piatto/Telaio

2.3 16V	Petrol	107	04/06 →
---------	--------	-----	---------

SAA115

MAZDA
3 (BK)

2.0	Petrol	110	10/03 → 06/09
2.0 MZR-CD	Diesel	105	12/06 → 06/09
2.3 MPS	Petrol	191	12/06 → 06/09

3 Tre volumi (BK)

2.0	Petrol	110	02/04 →
2.0 MZR-CD	Diesel	105	12/06 →

5 (CR19)

1.8	Petrol	85	03/05 →
2.0	Petrol	107	03/05 →

6 (GG)

1.8	Petrol	88	08/02 → 08/07
2.0	Petrol	104	06/02 → 08/07
2.0	Petrol	108	03/05 → 08/07
2.3	Petrol	122	06/02 → 08/07
2.3 MPS Turbo	Petrol	191	12/05 → 08/07

6 (GH)

1.8 MZR	Petrol	88	08/07 →
2.0 MZR	Petrol	108	08/07 →
2.5 MZR	Petrol	125	08/07 →

6 2 volumi /Coda spiovente (GH)

1.8 MZR	Petrol	88	08/07 →
2.0 MZR	Petrol	108	08/07 →
2.5 MZR	Petrol	125	08/07 →

6 Hatchback (GG)

1.8	Petrol	88	08/02 → 08/07
2.0	Petrol	104	08/02 → 08/07
2.0	Petrol	108	03/05 → 08/07
2.3	Petrol	122	08/02 → 08/07

6 Station wagon (GH)

2.0 MZR	Petrol	108	02/08 →
---------	--------	-----	---------

6 Station Wagon (GY)

2.0	Petrol	104	08/02 → 08/07
2.0	Petrol	108	03/05 → 08/07
2.3	Petrol	122	08/02 → 08/07
2.3 AWD	Petrol	119	11/02 → 08/07

CX-7 (ER)

2.3 MZR DISI Turbo	Petrol	190	10/07 →
--------------------	--------	-----	---------

MPV II (LW)

2.3	Petrol	104	07/02 → 02/06
-----	--------	-----	---------------

MX-5 III (NC)

1.8	Petrol	93	03/05 →
2.0	Petrol	118	03/05 →

SAA115



VOLVO

C30

1.6	Petrol	74	10/06 → 12/12
1.8	Petrol	92	10/06 → 12/12
1.8 FlexFuel	BiFuel	92	01/07 → 12/12
2.0	Petrol	107	10/06 → 12/12

S40 II (MS)

1.6	Petrol	74	01/05 →
1.8	Petrol	92	04/04 →
1.8 FlexFuel	BiFuel	92	01/06 →
2.0	Petrol	107	10/06 →

S80 II (AS)

2.0 FlexFuel	BiFuel	107	01/08 →
--------------	--------	-----	---------

V50 (MW)

1.6	Petrol	74	01/05 →
1.8	Petrol	92	04/04 →
1.8 FlexFuel	BiFuel	92	01/05 →
2.0	Petrol	107	10/06 →

V70 III (BW)

2.0	Petrol	107	10/07 →
2.0 Flexfuel	BiFuel	107	01/08 →

SAA117

**SENSORE PRESSIONE OLIO
OIL PRESSURE SWITCH**



FORD

TRANSIT Autobus (FD_-, FB_-, FS_-, FZ_-, FC_-)

2.4 DI (F_B_, F_C_, F_A_)	Diesel	66	01/00 → 05/06	ENGINE: D2FB,D2FA,D2FE
2.4 DI [RWD] (F_B_, F_C_)	Diesel	55	01/00 → 05/06	ENGINE: F4FA
2.4 DI [RWD] (F_B_, F_C_, F_A_)	Diesel	88	01/00 → 05/06	ENGINE: D4FA

SAA117



FORD

TRANSIT Autobus (FD_-, FB_-, FS_-, FZ_-, FC_-)

2.4 TDE (F_C_, F_B_, F_A_)	Diesel	92	07/01 → 05/06	ENGINE: DOFA
----------------------------	--------	----	---------------	--------------

TRANSIT Furgonato (FA_-)

2.4 DI (FAA_, FAB_, FAC_, FAD_)	Diesel	66	01/00 → 05/06	ENGINE: D2FB,D2FA,D2FE
2.4 DI [RWD] (FAA_, FAB_, FAC_, FAD_)	Diesel	55	01/00 → 05/06	ENGINE: F4FA
2.4 DI [RWD] (FAA_, FAB_, FAC_, FAD_)	Diesel	88	01/00 → 05/06	ENGINE: D4FA

TRANSIT Pianale piatto/Telaio (FM_-, FN_-)

2.4 DI (F_A_, F_B_, F_C_, F_D_)	Diesel	55	01/00 → 05/06	ENGINE: F4FA
2.4 DI (F_A_, F_B_, F_C_, F_D_)	Diesel	66	01/00 → 05/06	ENGINE: D2FB,D2FA,D2FE
2.4 DI (F_A_, F_B_, F_C_, F_D_)	Diesel	88	01/00 → 05/06	ENGINE: D4FA
2.4 TDE	Diesel	92	07/01 → 05/06	ENGINE: DOFA

SAA118

**SENSORE PRESSIONE OLIO
OIL PRESSURE SWITCH**

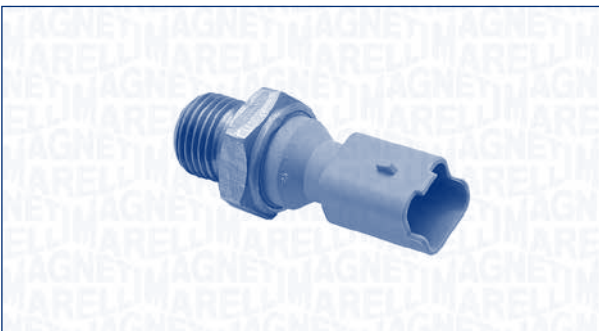

CITROËN

BERLINGO (B9)

1.6	Petrol	66	04/08 →
1.6	Petrol	80	04/08 →
1.6 HDi 110	Diesel	80	04/08 →
1.6 HDi 75	Diesel	55	04/08 →
1.6 HDi 90	Diesel	66	04/08 →

SAA118

KW

CITROËN
BERLINGO (MF)

1.4	Petrol	53	11/02 → 10/05
1.4 bivalent	Petrol/ CNG	48	11/02 →
1.4 i bivalent (MFKFW)	BiFuel	55	04/03 →
1.6 16V (MFNFU)	Petrol	80	10/00 →
1.6 HDI 75 (MF9HW)	Diesel	55	07/05 →
1.6 HDI 90 (MF9HX)	Diesel	66	07/05 →
1.8 D (MFA9A)	Diesel	43	07/98 →
1.8 i (MFLFX)	Petrol	66	05/97 →
1.8 i 4WD (MFLFX)	Petrol	66	04/97 →
1.9 D (MFWJZ)	Diesel	51	07/98 →
1.9 D 4WD (MFWJZ)	Diesel	51	07/98 →
2.0 HDI 90 (MFRHY)	Diesel	66	12/99 →

BERLINGO Furgonato (B9)

1.6	Petrol	66	04/08 →
1.6	Petrol	80	04/08 →
1.6 HDi 110	Diesel	80	04/08 →
1.6 HDi 75	Diesel	55	04/08 →
1.6 HDi 90	Diesel	66	04/08 →

BERLINGO Furgonato (M_)

1.4 bivalent	Petrol/ CNG	48	11/02 →
1.4 i bivalent (MBKFW)	BiFuel	55	04/03 →
1.6 16V (MBNFU)	Petrol	80	10/00 →
1.6 HDI 75 (MB9HW)	Diesel	55	07/05 →
1.6 HDI 90 (MB9HX, MC9HX)	Diesel	66	07/05 →
1.8 i	Petrol	66	08/99 → 10/02
1.9 D 70 (MBWJZ, MCWJZ)	Diesel	51	04/99 →
1.9 D 70 4WD (MBWJZ, MCWJZ)	Diesel	51	07/98 →

SAA118

KW

CITROËN
BERLINGO Furgonato (M_)

2.0 HDI 90 (MBRHY, MCRHY)	Diesel	66	12/99 →
2.0 HDI 90 4WD (MBRHY, MCRHY)	Diesel	66	11/00 →

C1 (PM_, PN_)

1.4 HDi	Diesel	40	06/05 →
---------	--------	----	---------

C15 (VD-_)

1.9 D	Diesel	44	12/00 → 12/05
-------	--------	----	---------------

C2 (JM_)

1.1	Petrol	44	09/03 →
1.4	Petrol	54	09/03 →
1.4 16V	Petrol	65	06/06 →
1.4 HDi	Diesel	50	09/03 →
1.6	Petrol	80	09/03 →
1.6 HDi	Diesel	80	09/05 →
1.6 VTS	Petrol	90	01/05 →

C3 I (FC_)

1.1 i	Petrol	44	02/02 →
1.4 16V	Petrol	65	12/03 →
1.4 16V HDi	Diesel	66	02/02 →
1.4 HDi	Diesel	50	02/02 →
1.4 i	Petrol	54	02/02 →
1.4 i Bivalent	Petrol/ CNG	54	02/02 →
1.6 16V	Petrol	80	02/02 →
1.6 16V HDi	Diesel	66	10/05 →
1.6 16V HDi	Diesel	80	09/05 →

C3 Pluriel (HB_)

1.4	Petrol	54	05/03 →
1.4 HDi	Diesel	50	04/04 →
1.6	Petrol	80	05/03 →

C4 Coupé (LA_)

1.4 16V	Petrol	65	11/04 →
1.6 16V	Petrol	80	11/04 →
1.6 HDi	Diesel	66	11/04 →
1.6 HDi	Diesel	80	11/04 →
2.0 16V	Petrol	100	11/04 →
2.0 16V	Petrol	130	11/04 →
2.0 HDi	Diesel	100	11/04 →

SAA118



KW



CITROËN

C4 Grand Picasso I (UA_)

1.6 HDi	Diesel	80	10/06 →
1.6 VTi 120	Petrol	88	07/08 →
1.8 i 16V	Petrol	92	10/06 →
2.0 HDi 138	Diesel	100	10/06 →
2.0 i 16V	Petrol	103	10/06 →

C4 I (LC_)

1.4 16V	Petrol	65	11/04 →
1.6 16V	Petrol	80	11/04 →
1.6 16V Bio-Flex	BiFuel	80	09/07 →
1.6 HDi	Diesel	66	11/04 →
1.6 HDi	Diesel	80	11/04 →
1.6 THP 150	Petrol	110	07/08 →
1.6 VTi 120	Petrol	88	07/08 →
2.0 16V	Petrol	100	11/04 →
2.0 16V	Petrol	103	11/04 →
2.0 16V	Petrol	130	11/04 →
2.0 HDi	Diesel	100	11/04 →

C4 Picasso I (UD_)

1.6 HDi	Diesel	80	02/07 →
1.6 VTi 120	Petrol	88	07/08 →
1.8 i 16V	Petrol	92	02/07 →
2.0 HDi 138	Diesel	100	02/07 →
2.0 i 16V	Petrol	103	02/07 →

C5 I (DC_)

1.8 16V (DC6FZB, DC6FZE)	Petrol	85	03/01 → 08/04
2.0 16V (DCRFNC, DCRFNF)	Petrol	100	03/01 → 08/04
2.0 16V HPi (DCRLZB)	Petrol	103	03/01 → 08/04
2.0 HDi	Diesel	79	03/01 → 08/04
2.0 HDi (DCRHYP)	Diesel	66	03/01 → 08/04
2.0 HDi (DCRHZB, DCRHZE)	Diesel	80	03/01 → 08/04
2.2 HDi (DC4HXB, DC4HXE)	Diesel	98	03/01 → 08/04
3.0 V6 (DCXFXC, DCXFXF)	Petrol	152	03/01 → 08/04

SAA118



KW



CITROËN

C5 I Break (DE_)

1.8 16V (DE6FZB, DE6FZE)	Petrol	85	06/01 → 08/04
2.0 16V (DERFNF, DERFNC, RERFNC)	Petrol	100	06/01 → 08/04
2.0 16V HPi (DERLZB)	Petrol	103	06/01 → 08/04
2.0 HDi	Diesel	80	06/01 → 08/04
2.0 HDi (DERHSB, DERHSE)	Diesel	79	06/01 → 08/04
2.2 HDi (DE4HXB, DE4HXE)	Diesel	98	06/01 → 08/04
3.0 V6 (DEXFXC, DEXFXF)	Petrol	152	06/01 → 08/04

C5 II (RC_)

1.6 HDi (RC8HZB)	Diesel	80	09/04 →
1.8 16V	Petrol	92	09/05 →
1.8 16V (RC6FZB)	Petrol	85	09/04 →
2.0 16V (RCRFJB, RCRFJC)	Petrol	103	09/04 →
2.0 HDi (RCRHRH)	Diesel	100	09/04 →
2.2 HDi (RC4HXE)	Diesel	98	09/04 →
3.0 V6 (RCXFUF)	Petrol	152	09/04 →

C5 II Break (RE_)

1.6 HDi (RE8HZB)	Diesel	80	09/04 →
1.8 16V	Petrol	92	09/05 →
1.8 16V (RE6FZB)	Petrol	85	09/04 →
2.0 16V (RERFJB, RERFJC)	Petrol	103	09/04 →
2.0 HDi (RERHRH)	Diesel	100	09/04 →
2.2 HDi (RE4HXE)	Diesel	98	09/04 →
3.0 V6 (REXFUF)	Petrol	152	09/04 →

SAA118

CITROËN
C5 III (RD_)

1.6 HDi	Diesel	80	02/08 →	
1.8 16V	Petrol	92	02/08 →	
2.0 HDi	Diesel	100	02/08 →	
2.2 HDi	Diesel	125	02/08 →	
3.0 V6	Petrol	155	02/08 →	

C5 III Break (TD_)

1.6 HDi	Diesel	80	02/08 →	
1.8 16V	Petrol	92	02/08 →	
2.0 16V	Petrol	103	02/08 →	
2.0 HDi	Diesel	100	02/08 →	
2.2 HDi	Diesel	125	02/08 →	
3.0 V6	Petrol	155	02/08 →	

C6 (TD_)

2.2 HDi	Diesel	125	06/06 →	
3.0 V6	Petrol	155	09/05 →	

C8 (EA_, EB_)

2.0	Petrol	100	07/02 →	
2.0 16V	Petrol	103	09/05 →	
2.0 HDi	Diesel	88	02/07 →	
2.0 HDi	Diesel	79	07/02 →	
2.0 HDi 135	Diesel	100	03/06 →	
2.2	Petrol	116	07/02 →	
2.2 HDi	Diesel	125	06/06 →	
2.2 HDi	Diesel	94	07/02 →	
3.0 V6	Petrol	150	07/02 →	

C-CROSSER (EP_)

2.2 HDi	Diesel	115	02/07 →	
---------	--------	-----	---------	--

EVASION (22, U6)

1.8	Petrol	73	05/97 → 07/02	
1.9 TD	Diesel	66	11/94 → 07/02	
1.9 TD	Diesel	68	10/95 → 12/98	
2.0	Petrol	89	06/94 → 07/02	
2.0 16V	Petrol	100	05/00 → 07/02	
2.0 16V	Petrol	97	05/98 → 04/00	
2.0 HDi	Diesel	80	08/99 → 07/02	
2.0 Turbo C.T.	Petrol	108	06/94 → 07/02	

JUMPER Autobus (230P)

1.9 D	Diesel	51	01/99 → 04/02	
1.9 TD	Diesel	66	08/94 → 04/02	
1.9 TD	Diesel	68	02/94 → 04/02	
2.0	Petrol	80	02/94 → 04/02	
2.5 D	Diesel	63	08/94 → 04/02	
2.5 TD	Diesel	76	08/94 → 04/02	

SAA118

CITROËN
JUMPER Autobus (244, Z_)

2.0	Petrol	81	04/02 →	
2.0 bivalent	Petrol/ CNG	81	02/03 →	
2.0 HDi	Diesel	62	04/02 →	
2.2 HDi	Diesel	74	04/02 →	

JUMPER Furgonato (230L)

1.9 D	Diesel	51	02/94 → 04/02	
1.9 TD	Diesel	66	03/94 → 04/02	
1.9 TD	Diesel	68	03/94 → 04/02	
2.0	Petrol	80	03/94 → 04/02	
2.5 D	Diesel	63	03/94 → 04/02	
2.5 D 4x4	Diesel	63	03/00 → 04/02	
2.5 TD	Diesel	76	03/94 → 04/02	
2.5 TDI	Diesel	79	12/96 → 11/00	
2.5 TDI 4x4	Diesel	79	03/00 → 11/00	

JUMPER Furgonato (244)

2.0	Petrol	81	04/02 →	
2.0 bivalent	Petrol/ CNG	81	02/03 →	
2.0 HDi	Diesel	62	04/02 →	
2.2 HDi	Diesel	74	04/02 →	

JUMPER Pianale piatto/Telaio (230)

1.9 TD	Diesel	66	03/94 → 04/02	
1.9 TD	Diesel	68	03/94 → 04/02	
2.0	Petrol	80	03/94 → 04/02	
2.5 D	Diesel	63	03/94 → 04/02	
2.5 D 4x4	Diesel	63	03/00 → 04/02	
2.5 TD	Diesel	76	03/94 → 04/02	
2.5 TDI	Diesel	79	12/96 → 04/02	
2.5 TDI 4x4	Diesel	79	03/00 → 04/02	

JUMPER Pianale piatto/Telaio (244)

2.0 HDi	Diesel	62	04/02 →	
2.2 HDi	Diesel	74	04/02 →	

JUMPY

1.6 HDi 90 16V	Diesel	66	01/07 →	
2.0 HDi 120	Diesel	88	01/07 →	
2.0 HDi 140	Diesel	100	01/07 →	
2.0 i	Petrol	103	01/07 →	

JUMPY (U6U)

1.9 D 70	Diesel	51	04/98 →	
2.0	Petrol	100	04/00 → 12/06	
2.0 HDi 110	Diesel	80	03/00 →	
2.0 HDi 95	Diesel	69	10/99 →	
2.0 i 16V	Petrol	102	03/00 →	

SAA118



KW



CITROËN

JUMPY Furgonato

2.0 HDi 120	Diesel	88	01/07 →
2.0 HDi 140	Diesel	100	01/07 →
2.0 i	Petrol	103	01/07 →

JUMPY Furgonato (BS_, BT_, BY_, BZ_)

1.9 D 70	Diesel	51	04/98 →
1.9 TD	Diesel	66	10/95 →
2.0 HDi 110	Diesel	80	01/02 →
2.0 HDi 95	Diesel	69	10/99 →
2.0 i 16V	Petrol	102	03/00 →

JUMPY Pianale piatto/Telaio (BU_, BV_, BW_, BX_)

1.9 TD	Diesel	68	10/99 →
2.0 HDi 95	Diesel	69	10/99 →

NEMO Furgonato (AA_)

1.4	Petrol	54	02/08 →
1.4 HDi	Diesel	50	02/08 →

SAXO (S0, S1)

1.1 X,SX	Petrol	44	05/96 → 09/03
1.6	Petrol	74	02/01 → 04/04
1.6 VTS	Petrol	72	09/00 → 09/03

XANTIA (X2)

1.8 i	Petrol	66	01/98 → 04/03
1.8 i 16V	Petrol	81	01/98 → 04/03
1.9 SD	Diesel	55	01/98 → 04/03
1.9 Turbo D	Diesel	66	01/98 → 04/03
2.0 HDi 109	Diesel	80	02/99 → 04/03
2.0 HDi 90	Diesel	66	03/99 → 04/03
2.0 i 16V	Petrol	97	01/98 → 04/03
2.0 Turbo	Petrol	108	01/98 → 04/03
3.0 V6	Petrol	140	01/98 → 04/03

XANTIA Break (X2)

1.8 i	Petrol	66	01/98 → 04/03
1.8 i 16V	Petrol	81	01/98 → 04/03
1.9 SD	Diesel	55	01/98 → 04/03
1.9 Turbo D	Diesel	66	01/98 → 04/03
2.0 HDi 109	Diesel	80	02/99 → 04/03
2.0 HDi 90	Diesel	66	03/99 → 04/03
2.0 i 16V	Petrol	97	01/98 → 04/03
2.0 Turbo	Petrol	108	01/98 → 04/03
3.0 V6	Petrol	140	01/98 → 04/03

XM (Y4)

2.0 i 16V	Petrol	97	05/94 → 10/00
2.0 Turbo	Petrol	108	05/94 → 10/00
2.5 TD	Diesel	95	05/94 → 10/00
3.0 V6	Petrol	140	04/97 → 10/00

SAA118



KW



CITROËN

XM Break (Y4)

2.0 i 16V	Petrol	97	05/94 → 10/00
2.5 TD	Diesel	95	05/94 → 10/00
3.0 V6	Petrol	140	04/97 → 10/00

XSARA (N1)

1.4 HDi	Diesel	50	01/03 → 03/05
1.4 i	Petrol	55	04/97 → 03/05
1.5 D	Diesel	42	04/97 → 09/00
1.6 16V	Petrol	80	09/00 → 03/05
1.8 D	Diesel	43	04/97 → 09/00
1.8 i	Petrol	66	04/97 → 09/00
1.8 i 16V	Petrol	81	04/97 → 09/00
1.8 i Aut.	Petrol	74	04/97 → 09/00
1.9 D	Diesel	51	07/98 → 03/05
1.9 D	Diesel	50	04/97 → 09/00
1.9 SD	Diesel	55	01/98 → 09/00
1.9 TD	Diesel	66	04/97 → 09/00
2.0 16V	Petrol	97	07/98 → 09/00
2.0 16V	Petrol	100	09/00 → 03/05
2.0 16V	Petrol	120	04/97 → 09/00
2.0 HDi 109	Diesel	80	05/01 → 03/05
2.0 HDi 90	Diesel	66	02/99 → 03/05

XSARA Break (N2)

1.4 HDi	Diesel	50	01/03 → 08/05
1.4 i	Petrol	55	10/97 → 08/05
1.5 D	Diesel	42	10/97 → 09/00
1.6 16V	Petrol	80	09/00 → 08/05
1.8 D	Diesel	43	10/97 → 09/00
1.8 i	Petrol	66	10/97 → 09/00
1.8 i 16V	Petrol	81	10/97 → 09/00
1.8 i Aut.	Petrol	74	10/97 → 09/00
1.9 D	Diesel	51	07/98 → 08/05
1.9 D	Diesel	50	10/97 → 09/00
1.9 D	Diesel	55	01/98 → 09/00
1.9 TD	Diesel	66	10/97 → 09/00
2.0 16V	Petrol	97	07/98 → 09/00
2.0 16V	Petrol	100	09/00 → 08/05
2.0 HDi 109	Diesel	80	05/01 → 08/05
2.0 HDi 90	Diesel	66	02/99 → 08/05

XSARA Coupé (N0)

1.4 HDi	Diesel	50	01/03 → 03/05
1.4 i	Petrol	55	03/98 → 03/05
1.6 16V	Petrol	80	09/00 → 03/05
1.8 i	Petrol	66	02/98 → 09/00
1.8 i	Petrol	74	02/98 → 09/00

SAA118

KW

CITROËN
XSARA Coupé (N0)

1.8 i 16V	Petrol	81	02/98 → 09/00
1.9 D	Diesel	51	02/99 → 03/05
1.9 D	Diesel	50	02/98 → 09/00
1.9 TD	Diesel	66	02/98 → 09/00
2.0 16V	Petrol	100	09/00 → 03/05
2.0 HDI 109	Diesel	80	05/01 → 03/05
2.0 HDI 90	Diesel	66	02/99 → 03/05
2.0 i 16V	Petrol	120	02/98 → 03/05

XSARA PICASSO (N68)

1.6 16V	Petrol	80	09/05 →
1.6 HDi	Diesel	66	09/05 →
1.6 HDi	Diesel	80	05/04 →
1.8 16V	Petrol	85	02/00 →
2.0 16V	Petrol	100	01/03 →
2.0 HDi	Diesel	66	12/99 →

FIAT
DUCATO Autobus (230)

1.9 D	Diesel	50	04/98 → 04/02
1.9 TD	Diesel	66	04/98 → 04/02
2.0 JTD	Diesel	62	10/01 → 04/02

DUCATO Autobus (244, Z_)

2.0	Petrol	81	04/02 →
2.0 JTD	Diesel	62	04/02 →

DUCATO Furgonato (230L)

1.9 D	Diesel	50	04/98 → 04/02
1.9 TD	Diesel	66	04/98 → 04/02
2.0	Petrol	80	03/94 → 04/02
2.0 JTD	Diesel	62	10/01 → 04/02

DUCATO Furgonato (244)

2.0	Petrol	81	04/02 →
2.0 JTD	Diesel	62	04/02 →

DUCATO Pianale piatto/Telaio (230)

1.9 D	Diesel	50	04/98 → 04/02
1.9 TD	Diesel	66	04/98 → 04/02
2.0	Petrol	80	06/98 → 04/02

DUCATO Pianale piatto/Telaio (244)

2.0 JTD	Diesel	62	04/02 → 07/06
---------	--------	----	---------------

FIORINO Cassone / Furgonato / Promiscuo (225)

1.4	Petrol	54	11/07 →
-----	--------	----	---------

QUBO (225)

1.4	Petrol	54	02/08 →
-----	--------	----	---------

SAA118

KW

FIAT
SCUDO (270_)

1.6 D Multijet	Diesel	66	01/07 →
2.0 D Multijet	Diesel	100	01/07 →
2.0 D Multijet	Diesel	88	01/07 →

SCUDO Combinato (220P)

1.9 D	Diesel	51	04/98 → 12/06
1.9 TD Eco	Diesel	66	02/96 → 12/06
2.0 16V	Petrol	100	06/00 → 12/06
2.0 JTD	Diesel	80	12/99 → 12/06
2.0 JTD	Diesel	69	01/04 → 12/06

SCUDO Furgonato (220L)

1.9 D	Diesel	51	04/98 → 12/06
1.9 TD	Diesel	66	02/96 → 12/06
1.9 TD	Diesel	68	02/98 → 12/06
2.0	Petrol	100	05/00 → 12/06
2.0 JTD	Diesel	69	12/99 → 12/06
2.0 JTD	Diesel	80	12/02 → 12/06

SCUDO Furgonato (270_)

1.6 D Multijet	Diesel	66	01/07 →
2.0 D Multijet	Diesel	100	01/07 →
2.0 D Multijet	Diesel	88	01/07 →

SCUDO Pianale piatto/Telaio (270_)

1.6 D Multijet	Diesel	66	01/07 →
2.0 D Multijet	Diesel	100	01/07 →

ULYSSE (179AX)

2.0	Petrol	100	08/02 → 06/11
2.0 D Multijet	Diesel	100	05/06 → 06/11
2.0 D Multijet	Diesel	88	05/06 → 06/11
2.0 JTD	Diesel	80	08/02 → 08/06
2.0 JTD	Diesel	79	05/03 → 08/06
2.2 D Multijet	Diesel	125	03/08 → 06/11
2.2 JTD	Diesel	94	08/02 → 08/06
3.0	Petrol	150	08/02 → 06/11

ULYSSE (220)

1.9 TD (220AH5)	Diesel	66	02/95 → 08/02
2.0 (220.AC5)	Petrol	89	06/94 → 08/02
2.0 16V	Petrol	100	09/00 → 08/02
2.0 16V	Petrol	97	05/98 → 09/00
2.0 JTD	Diesel	80	10/99 → 08/02
2.0 Turbo (220.AD5)	Petrol	108	06/94 → 08/02

SAA118



KW



FORD

C-MAX (DM2)

1.6 TDCi	Diesel	66	02/07 →
1.6 TDCi	Diesel	80	02/07 →
2.0 TDCi	Diesel	100	02/07 →
2.0 TDCi	Diesel	81	02/08 →

FIESTA V (JH_, JD_)

1.4 TDCi	Diesel	50	11/01 → 06/08
1.6 TDCi	Diesel	66	11/04 → 06/08

FIESTA Van

1.4 TDCi	Diesel	50	10/03 →
----------	--------	----	---------

FIESTA VI

1.6 TDCi	Diesel	66	06/08 →
----------	--------	----	---------

FOCUS C-MAX

1.6 TDCi	Diesel	66	02/05 → 03/07
1.6 TDCi	Diesel	80	10/03 → 03/07
2.0 TDCi	Diesel	100	10/03 → 03/07

FOCUS II (DA_)

1.6 TDCi	Diesel	80	11/04 →
1.6 TDCi	Diesel	66	01/05 →
2.0 TDCi	Diesel	100	11/04 →

FOCUS II Cabriolet

2.0 TDCi	Diesel	100	10/06 →
----------	--------	-----	---------

FOCUS II Station wagon (DA_)

1.6 TDCi	Diesel	66	11/04 →
1.6 TDCi	Diesel	80	11/04 →
2.0 TDCi	Diesel	100	11/04 →

FOCUS II Tre volumi (DA_)

1.6 TDCi	Diesel	66	04/05 →
1.6 TDCi	Diesel	80	04/05 →
2.0 TDCi	Diesel	100	04/05 →

FUSION (JU_)

1.4 TDCi	Diesel	50	08/02 →
1.6 TDCi	Diesel	66	11/04 →

GALAXY (WA6)

2.0 TDCi	Diesel	103	05/06 →
2.0 TDCi	Diesel	85	11/07 →
2.0 TDCi	Diesel	96	05/06 →
2.2 TDCi	Diesel	129	03/08 →

KUGA I

2.0 TDCi	Diesel	100	03/08 →
2.0 TDCi 4x4	Diesel	100	03/08 →

MONDEO IV (BA7)

2.0 TDCi	Diesel	103	03/07 →
2.0 TDCi	Diesel	85	11/07 →
2.0 TDCi	Diesel	96	03/07 →

SAA118



KW



FORD

MONDEO IV (BA7)

2.2 TDCi	Diesel	129	03/08 →
----------	--------	-----	---------

MONDEO IV Tre volumi (BA7)

2.0 TDCi	Diesel	103	03/07 →
2.0 TDCi	Diesel	96	03/07 →
2.2 TDCi	Diesel	129	03/08 →

MONDEO IV Turnier (BA7)

2.0 TDCi	Diesel	103	03/07 →
2.0 TDCi	Diesel	85	11/07 →
2.0 TDCi	Diesel	96	03/07 →
2.2 TDCi	Diesel	129	03/08 →

S-MAX (WA6)

2.0 TDCi	Diesel	103	05/06 →
2.0 TDCi	Diesel	85	11/07 →
2.0 TDCi	Diesel	96	05/06 →
2.2 TDCi	Diesel	129	03/08 →

LANCIA

PHEDRA (179)

2.0 (179AXA11)	Petrol	100	09/02 → 11/10
2.0 D Multijet	Diesel	100	07/06 → 11/10
2.0 JTD	Diesel	79	07/03 → 11/10
2.0 JTD	Diesel	88	06/06 → 11/10
2.0 JTD (179AXB1A)	Diesel	80	09/02 → 11/10
2.2 JTD (179AXC1A)	Diesel	94	09/02 → 11/10
3.0 V6	Petrol	150	09/02 → 11/10

ZETA (220)

2.0 16V (220AL5)	Petrol	97	05/98 → 07/00
2.0 16V (220AQ5)	Petrol	100	07/00 → 09/02
2.0 JTD	Diesel	80	04/00 → 09/02
2.0 JTD (220AN5)	Diesel	80	09/99 → 09/02
2.0 Turbo (220AD5, 220CD5)	Petrol	108	05/95 → 09/02

MAZDA

2 (DY)

1.4 CD	Diesel	50	04/03 →
--------	--------	----	---------

3 (BK)

1.6 DI Turbo	Diesel	80	06/04 → 06/09
--------------	--------	----	---------------

3 Tre volumi (BK)

1.6 DI Turbo	Diesel	80	06/04 →
--------------	--------	----	---------

SAA118

MERCEDES-BENZ
CLK (C209)

500 (209.375)	Petrol	225	06/02 → 05/09
---------------	--------	-----	---------------

MINI
MINI (R56)

Cooper	Petrol	88	10/06 →
Cooper S	Petrol	128	10/06 →

NISSAN
MICRA II (K11)

1.5 D	Diesel	42	02/98 → 02/03
-------	--------	----	---------------

PEUGEOT
1007 (KM_)

1.4	Petrol	54	04/05 →
1.4 16V	Petrol	65	10/05 →
1.4 HDi	Diesel	50	04/05 →
1.6 16V	Petrol	80	04/05 →
1.6 HDi	Diesel	80	06/07 →

106 II (1)

1.5 D	Diesel	42	04/98 →
107			
1.4 HDi	Diesel	40	06/05 →

206 2 volumi /Coda spiovente (2A/C)

1.1 i	Petrol	44	09/98 →
1.4 16V	Petrol	65	10/03 →
1.4 HDi eco 70	Diesel	50	09/01 →
1.4 i	Petrol	55	09/98 →
1.6 16V	Petrol	80	12/00 →
1.6 HDi 110	Diesel	80	05/04 →
1.9 D	Diesel	51	09/98 → 11/01
2.0 HDI 90	Diesel	66	12/99 →
2.0 RC	Petrol	130	07/03 →
2.0 S16	Petrol	100	06/99 →
2.0 S16	Petrol	99	04/99 → 10/00

206 CC (2D)

1.6 16V	Petrol	80	09/00 →
1.6 HDi 110	Diesel	80	04/05 →
2.0 S16	Petrol	100	09/00 →

206 SW (2E/K)

1.1	Petrol	44	07/02 →
1.4	Petrol	55	07/02 →
1.4 16V	Petrol	65	10/03 →
1.4 HDi	Diesel	50	07/02 →
1.6 16V	Petrol	80	07/02 →
1.6 HDi 110	Diesel	80	05/04 →
2.0 16V	Petrol	100	07/02 →

SAA118

PEUGEOT
206 Tre volumi

1.4	Petrol	55	03/07 →
1.6 16V	Petrol	80	03/07 →

207 (WA_, WC_)

1.4	Petrol	53	02/06 →
1.4 16V	Petrol	70	06/07 →
1.4 16V	Petrol	65	02/06 →

306 (7B, N3, N5)

1.4 SL	Petrol	55	06/94 → 05/01
1.6	Petrol	72	10/00 → 05/01
1.8 16V	Petrol	81	03/97 → 05/01
1.8 ST	Petrol	74	06/94 → 05/01
1.9 D	Diesel	51	09/98 → 05/01
1.9 SRDT	Diesel	66	06/94 → 05/01
2.0	Petrol	97	03/97 → 05/01
2.0 HDI 90	Diesel	66	06/99 → 05/01

306 2 volumi /Coda spiovente (7A, 7C, N3, N5)

1.4	Petrol	55	05/93 → 05/01
1.6	Petrol	72	10/00 → 05/01
1.8	Petrol	74	05/93 → 05/01
1.8 16V	Petrol	81	03/97 → 05/01
1.8 D	Diesel	43	05/93 → 05/01
1.9 D	Diesel	51	09/98 → 05/01
1.9 DT	Diesel	66	05/93 → 05/01
2.0 16V	Petrol	97	03/97 → 05/01
2.0 HDI 90	Diesel	66	06/99 → 05/01

306 Break (7E, N3, N5)

1.4	Petrol	55	03/97 → 04/02
1.6	Petrol	72	10/00 → 04/02
1.8	Petrol	74	03/97 → 04/02
1.8 16V	Petrol	81	03/97 → 04/02
1.9 D	Diesel	51	09/98 → 04/02
1.9 D	Diesel	50	03/97 → 04/02
1.9 TD	Diesel	66	02/97 → 04/02
2.0	Petrol	97	03/97 → 04/02
2.0 HDI 90	Diesel	66	06/99 → 04/02

306 Cabriolet (7D, N3, N5)

1.6	Petrol	72	10/00 → 04/02
1.8	Petrol	74	03/94 → 04/02
1.8 16V	Petrol	81	07/00 → 04/02
2.0 16V	Petrol	97	03/97 → 04/02

SAA118



KW



PEUGEOT

307 (3A/C)

1.4	Petrol	55	08/00 →
1.4 16V	Petrol	65	11/03 →
1.4 HDi	Diesel	50	10/01 →
1.6 16V	Petrol	80	08/00 →
1.6 HDi	Diesel	66	04/05 →
1.6 HDi 110	Diesel	80	02/04 →
2.0 16V	Petrol	100	08/00 →
2.0 16V	Petrol	103	03/05 →
2.0 16V	Petrol	130	06/05 →
2.0 HDi 110	Diesel	79	08/00 →
2.0 HDi 135	Diesel	100	10/03 →
2.0 HDi 90	Diesel	66	08/00 →

307 Break (3E)

1.4 16V	Petrol	65	11/03 →
1.4 HDi	Diesel	50	03/02 →
1.6 16V	Petrol	80	03/02 →
1.6 HDi	Diesel	66	04/05 →
1.6 HDi 110	Diesel	80	02/04 →
2.0	Petrol	100	03/02 →
2.0 16V	Petrol	103	03/05 →
2.0 16V	Petrol	130	06/05 →
2.0 HDi 110	Diesel	79	03/02 →
2.0 HDi 135	Diesel	100	02/04 →
2.0 HDi 90	Diesel	66	03/02 →

307 CC (3B)

1.6 16V	Petrol	80	02/05 →
2.0 16V	Petrol	103	03/05 →
2.0 16V	Petrol	130	10/03 →
2.0 16V	Petrol	100	10/03 →
2.0 HDi 135	Diesel	100	06/05 →

307 SW (3H)

1.4 16V	Petrol	65	11/03 →
1.6 16V	Petrol	80	03/02 →
1.6 HDi 110	Diesel	80	02/04 →
2.0 HDi 110	Diesel	79	03/02 →
2.0 HDi 135	Diesel	100	02/04 →
2.0 HDi 90	Diesel	66	03/02 →

308 (4A_, 4C_)

1.4 16V	Petrol	70	09/07 →
1.6 16V	Petrol	110	09/07 →
1.6 16V	Petrol	128	03/08 →
1.6 16V	Petrol	88	09/07 →
1.6 HDi	Diesel	66	09/07 →
1.6 HDi	Diesel	80	09/07 →

SAA118



KW



PEUGEOT

308 (4A_, 4C_)

2.0 HDi	Diesel	100	09/07 →
---------	--------	-----	---------

308 SW

1.4 16V	Petrol	70	09/07 →
1.6 16V	Petrol	110	09/07 →
1.6 16V	Petrol	128	03/08 →
1.6 16V	Petrol	88	09/07 →
1.6 HDi	Diesel	66	09/07 →
1.6 HDi	Diesel	80	09/07 →
2.0 HDi	Diesel	100	09/07 →

4007 (GP_)

2.2 HDi	Diesel	115	02/07 →
---------	--------	-----	---------

406 (8B)

1.6	Petrol	65	11/95 → 05/04
1.8	Petrol	66	05/97 → 05/04
1.8 16V	Petrol	81	11/95 → 10/00
1.8 16V	Petrol	85	10/00 → 05/04
2.0 16V	Petrol	97	11/95 → 05/04
2.0 16V	Petrol	100	08/00 → 06/04
2.0 16V	Petrol	99	01/99 → 08/00
2.0 16V HPi	Petrol	103	05/01 → 05/04
2.0 HDi 110	Diesel	80	06/98 → 08/01
2.0 HDi 110	Diesel	79	08/01 → 05/04
2.0 HDi 90	Diesel	66	02/99 → 05/04
2.2	Petrol	116	07/00 → 05/04
2.2 HDi	Diesel	98	03/00 → 05/04
3.0 V6	Petrol	152	03/00 → 05/04

406 Break (8E/F)

1.8	Petrol	66	05/97 → 10/04
1.8 16V	Petrol	85	10/00 → 10/04
2.0 16V	Petrol	100	10/00 → 10/04
2.0 16V	Petrol	99	01/99 → 10/00
2.0 16V HPi	Petrol	103	05/01 → 10/04
2.0 HDi 110	Diesel	80	02/99 → 04/04
2.0 HDi 110	Diesel	79	08/01 → 10/04
2.0 HDi 90	Diesel	66	02/99 → 10/04
2.2	Petrol	116	07/00 → 10/04
2.2 HDi	Diesel	98	03/00 → 10/04
3.0 V6	Petrol	152	03/00 → 10/04

406 Coupé (8C)

2.0 16V	Petrol	97	03/97 → 12/04
2.0 16V	Petrol	100	10/00 → 12/04
2.0 16V	Petrol	99	01/99 → 10/00
2.2	Petrol	116	03/02 → 12/04
2.2 HDi	Diesel	98	03/00 → 12/04

SAA118

KW

PEUGEOT
406 Coupé (8C)

3.0 V6	Petrol	152	03/00 → 12/04
3.0 V6 24V	Petrol	140	03/97 → 12/04

407 (6D_)

1.6 HDi 110	Diesel	80	05/04 →
1.8	Petrol	85	05/04 →
1.8 16V	Petrol	92	09/05 →
2.0	Petrol	100	05/04 →
2.0 16V	Petrol	103	09/05 →
2.0 HDi 135	Diesel	100	05/04 →
2.2	Petrol	116	05/04 →
2.2 16V	Petrol	120	09/05 →
2.2 HDi 170	Diesel	125	05/06 →
3.0	Petrol	155	05/04 →

407 Coupé (6C_)

2.0 HDi	Diesel	100	10/05 →
2.2 16V	Petrol	120	10/05 →
3.0 V6	Petrol	155	10/05 →

407 SW (6E_)

1.6 HDi 110	Diesel	80	05/04 →
1.8	Petrol	85	05/04 →
1.8 16V	Petrol	92	09/05 →
2.0	Petrol	100	05/04 →
2.0 16V	Petrol	103	09/05 →
2.0 HDi 135	Diesel	100	05/04 →
2.2	Petrol	116	05/04 →
2.2 16V	Petrol	120	09/05 →
2.2 HDi 170	Diesel	125	05/06 →
3.0	Petrol	155	05/04 →

607 (9D, 9U)

2.0	Petrol	100	02/00 →
2.0 HDi	Diesel	100	09/05 →
2.0 HDi	Diesel	80	05/00 →
2.0 HDi	Diesel	79	03/01 → 07/04
2.2 16V	Petrol	120	09/05 →
2.2 16V	Petrol	116	02/00 →
2.2 HDi	Diesel	125	05/06 →
2.2 HDi	Diesel	98	02/00 →
3.0 V6 24V	Petrol	152	02/00 →
3.0 V6 24V	Petrol	155	03/04 →

806 (221)

1.9 TD	Diesel	66	07/95 → 08/02
1.9 TD	Diesel	68	05/97 → 08/02
2.0	Petrol	89	06/94 → 08/02
2.0 16V	Petrol	97	05/98 → 09/00

SAA118

KW

PEUGEOT
806 (221)

2.0 16V	Petrol	100	09/00 → 08/02
2.0 HDi	Diesel	80	08/99 → 08/02
2.0 HDi 16V	Diesel	80	08/99 → 08/02
2.0 Turbo	Petrol	108	06/94 → 08/02

807 (E)

2.0	Petrol	100	06/02 →
2.0 16V	Petrol	103	09/05 →
2.0 HDi	Diesel	79	06/02 →
2.0 HDi	Diesel	100	06/06 →
2.2	Petrol	116	06/02 →
2.2 HDi	Diesel	94	06/02 →
2.2 HDi	Diesel	125	06/06 →
3.0 V6	Petrol	150	06/02 →

BIPPER (AA_)

1.4	Petrol	54	02/08 →
1.4 HDi	Diesel	50	02/08 →

BOXER Autobus (230P)

1.9 TD	Diesel	66	08/94 → 04/02
1.9 TD	Diesel	68	03/94 → 04/02
2.0 i	Petrol	80	03/94 → 04/02
2.5 D	Diesel	63	08/94 → 04/02
2.5 TD	Diesel	76	07/94 → 04/02
2.5 TDI	Diesel	79	01/97 → 04/02
2.5 TDI 4x4	Diesel	79	01/97 → 04/02

BOXER Autobus (244, Z_)

2.0	Petrol	81	04/02 →
2.0 HDi	Diesel	62	04/02 →
2.2 HDi	Diesel	74	04/02 →

BOXER Furgonato (230L)

1.9 D	Diesel	50	07/99 → 04/02
1.9 DT 4x4	Diesel	66	03/96 → 09/98
1.9 TD	Diesel	66	07/99 → 04/02
2.0 HDi	Diesel	62	08/01 → 04/02
2.0 i	Petrol	80	06/94 → 04/02
2.5 D 4x4	Diesel	63	07/99 → 04/02
2.5 TDI	Diesel	79	01/97 → 04/02
2.5 TDI 4x4	Diesel	79	07/99 → 04/02

BOXER Furgonato (244)

2.0	Petrol	81	04/02 →
2.0 HDi	Diesel	62	04/02 →
2.2 HDi	Diesel	74	04/02 →

BOXER Pianale piatto/Telaio (244)

2.0 HDi	Diesel	62	04/02 →
2.2 HDi	Diesel	74	04/02 →

SAA118



KW



PEUGEOT

BOXER Pianale piatto/Telaio (ZCT_)

1.9 TD	Diesel	66	12/98 → 04/02
1.9 TD	Diesel	68	07/96 → 04/02
2.0 i	Petrol	80	06/94 → 04/02
2.5 D	Diesel	63	03/94 → 04/02
2.5 D 4x4	Diesel	63	07/99 → 04/02
2.5 TD	Diesel	76	03/94 → 04/02
2.5 TDI	Diesel	79	01/97 → 04/02
2.5 TDI 4x4	Diesel	79	07/99 → 04/02

EXPERT (224)

1.8	Petrol	74	10/96 → 09/00
1.9 TD	Diesel	66	02/96 →
2.0	Petrol	100	07/00 →
2.0 HDi	Diesel	80	07/00 →
2.0 HDi 16V	Diesel	80	07/00 →

EXPERT Furgonato (222)

1.8	Petrol	74	10/96 → 09/00
1.9 D	Diesel	51	02/96 →
1.9 D 70	Diesel	51	12/98 →
1.9 TD	Diesel	66	02/96 →
1.9 TD	Diesel	68	02/96 →
2.0	Petrol	100	09/02 →
2.0 HDi	Diesel	69	07/00 →
2.0 HDi	Diesel	80	07/00 →
2.0 HDi	Diesel	80	07/00 →

EXPERT Furgonato (VF3A_, VF3U_, VF3X_)

1.6 HDi 90 16V	Diesel	66	01/07 →
2.0 16V	Petrol	103	01/07 →
2.0 HDi 120	Diesel	88	01/07 →
2.0 HDi 140	Diesel	100	01/07 →

EXPERT Pianale piatto/Telaio

1.6 HDi 90	Diesel	66	01/07 →
2.0 HDi 120	Diesel	88	01/07 →
2.0 HDi 140	Diesel	100	01/07 →

EXPERT Pianale piatto/Telaio (223)

1.9 D	Diesel	51	02/96 →
1.9 TD	Diesel	66	02/96 →
1.9 TD	Diesel	68	02/96 →

EXPERT Tepee (VF3V_)

1.6 HDi 90 16V	Diesel	66	01/07 →
2.0 16V	Petrol	103	01/07 →
2.0 HDi 120	Diesel	88	01/07 →
2.0 HDi 140	Diesel	100	01/07 →

SAA118



KW



PEUGEOT

RANCH

1.6	Petrol	66	04/08 →
1.6	Petrol	80	04/08 →
1.6 HDi	Diesel	55	04/08 →
1.6 HDi	Diesel	66	04/08 →
1.6 HDi	Diesel	80	04/08 →

RANCH Furgonato

1.6	Petrol	66	04/08 →
1.6	Petrol	80	04/08 →
1.6 HDi	Diesel	55	04/08 →
1.6 HDi	Diesel	66	04/08 →
1.6 HDi	Diesel	80	04/08 →

RANCH Furgonato (5)

1.4 BiFuel	Petrol/ CNG	55	04/03 →
1.6 HDi 75	Diesel	55	02/06 →
1.6 HDi 90	Diesel	66	02/06 →
1.9 D	Diesel	51	06/96 →
1.9 D 4x4	Diesel	51	04/04 →
2.0 HDi	Diesel	66	04/00 →

RANCH MPV / Space wagon (5F)

1.1	Petrol	44	06/96 →
1.4	Petrol	55	06/96 →
1.6 16V	Petrol	80	07/01 →
1.6 HDi 75	Diesel	55	02/06 →
1.6 HDi 90	Diesel	66	02/06 →
1.8	Petrol	66	05/97 →
1.9 D	Diesel	51	12/98 →
1.9 D	Diesel	50	06/96 →
1.9 D	Diesel	51	05/96 → 12/98
1.9 D 4x4	Diesel	51	04/04 → 08/05
2.0 HDi	Diesel	66	02/00 →
2.0 HDi 4x4	Diesel	66	04/04 → 08/05

RENAULT

ESPACE III (JE0_)

3.0 V6 24V (JE0G, JE0R)	Petrol	140	10/98 → 10/02
----------------------------	--------	-----	---------------

LAGUNA I Grandtour (K56_)

3.0 24V (K56V)	Petrol	140	03/97 → 03/01
----------------	--------	-----	---------------

SUZUKI

GRAND VITARA I (FT, GT)

2.0 HDi 110 16V	Diesel	80	07/01 → 09/05
-----------------	--------	----	---------------

LIANA (ER)

1.4 DDiS	Diesel	66	04/04 →
----------	--------	----	---------

SAA118

SUZUKI
LIANA Station wagon (ER)

1.4 DDiS Diesel 66 04/04 → 12/07

TOYOTA
AYGO (WNB1_, KGB1_)

1.4 HDi (WNB10) Diesel 40 07/05 → 08/10

COROLLA (_E11_)

1.9 D (WZE110_) Diesel 51 02/00 → 11/01

COROLLA Compact (_E11_)

1.9 D (WZE110_) Diesel 51 02/00 → 01/02

COROLLA Liftback (_E11_)

1.9 D (WZE110_) Diesel 51 02/00 → 01/02

COROLLA Wagon (_E11_)

1.9 D (WZE110_) Diesel 51 02/00 → 10/01

VOLVO
C30

1.6 D Diesel 80 10/06 → 12/12

2.0 D Diesel 100 10/06 → 12/12

D5 Diesel 120 10/06 → 12/12

D5 Diesel 132 10/06 → 12/12

C70 II Cabriolet

2.0 D Diesel 100 01/08 →

D5 Diesel 132 03/06 →

S40 II (MS)

1.6 D Diesel 81 01/05 →

2.0 D Diesel 100 01/04 →

2.4 D5 Diesel 132 03/06 →

S80 II (AS)

2.4 D Diesel 120 03/06 →

D5 Diesel 136 03/06 →

D5 AWD Diesel 136 01/07 →

V50 (MW)

1.6 D Diesel 81 01/05 →

2.0 D Diesel 100 04/04 →

2.4 D5 Diesel 132 03/06 →

2.4 Tdi Diesel 120 05/07 →

V70 III (BW)

2.0 D Diesel 100 10/07 →

2.4 D Diesel 120 08/07 →

D5 Diesel 136 08/07 →

D5 AWD Diesel 136 10/07 →

XC70 II

2.4 D / D4 AWD Diesel 120 08/07 →

D5 AWD Diesel 136 08/07 →

GRUPPO H - GROUP H
SAF001
H4 **SENSORE ACQUA CARBURANTE**
WATER SENSOR - FUEL SYSTEM

ALFA ROMEO
159 (939)

1.9 JTDM 16V Diesel 100 09/05 → 11/11

1.9 JTDM 8V Diesel 88 09/05 → 11/11

2.0 JTDM Diesel 100 06/10 → 11/11

2.0 JTDM Diesel 125 05/09 → 11/11

2.0 JTDM Diesel 120 05/09 → 11/11

2.4 JTDM Diesel 154 05/07 → 11/11

2.4 JTDM Diesel 147 09/05 → 11/11

2.4 JTDM Q4 Diesel 154 05/07 → 11/11

159 Sportwagon (939)

1.9 JTDM 16V Diesel 100 03/06 → 11/11

1.9 JTDM 16V Diesel 110 03/06 → 11/11

1.9 JTDM 8V Diesel 88 03/06 → 11/11

2.0 JTDM Diesel 100 06/10 → 11/11

2.0 JTDM Diesel 125 05/09 → 11/11

2.0 JTDM Diesel 120 05/09 → 11/11

2.4 JTDM Diesel 154 05/07 → 11/11

2.4 JTDM Diesel 147 03/06 → 11/11

2.4 JTDM Q4 Diesel 154 05/07 → 11/11

BRERA

2.0 JTDM Diesel 125 05/09 →

2.4 JTDM 20V Diesel 147 01/06 →

2.4 JTDM 20V Diesel 154 05/07 →

GIULIETTA (940)

1.6 JTDM Diesel 77 04/10 →

2.0 JTDM Diesel 103 04/10 →

2.0 JTDM Diesel 125 04/10 →

MITO (955)

1.3 JTDM Diesel 66 09/08 →

1.3 JTDM Diesel 70 10/09 →

1.6 JTDM Diesel 88 09/08 →

SAF001



KW



ALFA ROMEO

SPIDER (939)

2.0 JTDM Diesel 125 05/09 →

2.4 JTDM Diesel 147 04/07 →

2.4 JTDM Diesel 154 03/08 →

CITROËN

JUMPER Autobus

3.0 HDi 180 Diesel 130 07/11 →

JUMPER Furgonato

3.0 HDi 180 Diesel 130 07/11 →

JUMPER Pianale piatto/Telaio

3.0 HDi 180 Diesel 130 07/11 →

NEMO Furgonato (AA_)

1.3 HDi 75 Diesel 55 10/10 →

FIAT

500 (312)

1.3 D Multijet Diesel 70 12/09 →

500 C (312)

1.3 D Multijet Diesel 70 09/09 →

BRAVO II (198)

1.6 D Multijet Diesel 77 03/08 →

1.6 D Multijet Diesel 88 03/08 →

1.6 D Multijet Diesel 85 11/08 →

1.9 D Multijet Diesel 110 04/07 →

1.9 D Multijet Diesel 88 04/07 →

2.0 D Multijet Diesel 121 09/08 →

2.0 D Multijet Diesel 120 09/08 →

CROMA (194)

1.9 D Multijet Diesel 85 06/05 →

1.9 D Multijet Diesel 100 12/05 →

1.9 D Multijet Diesel 110 06/05 →

2.4 D Multijet Diesel 147 06/05 →

DOBLO (119)

1.9 D Multijet Diesel 88 10/05 →

DOBLO Cargo (223)

1.9 JTD Multijet Diesel 88 12/06 →

DOBLO Cassone / Furgonato / Promiscuo (263)

1.3 D Multijet Diesel 66 02/10 →

1.6 D Multijet Diesel 74 02/10 →

1.6 D Multijet Diesel 77 02/10 →

2.0 D Multijet Diesel 99 02/10 →

DOBLO Combi (152, 263)

1.3 D Multijet Diesel 66 02/10 →

1.6 D Multijet Diesel 66 02/10 →

1.6 D Multijet Diesel 77 02/10 →

2.0 D Multijet Diesel 99 02/10 →

SAF001



KW



FIAT

DOBLO Pianale piatto/Telaio (263)

1.3 D Multijet Diesel 66 02/10 →

1.6 D Multijet Diesel 66 02/10 →

1.6 D Multijet Diesel 77 02/10 →

1.6 D Multijet Diesel 74 02/11 →

2.0 D Multijet Diesel 99 02/10 →

DUCATO Autobus (250)

110 Multijet 2,3 D Diesel 83 10/11 →

115 Multijet 2,0 D Diesel 85 06/11 →

130 Multijet 2,3 D Diesel 96 01/07 →

150 Multijet 2,3 D Diesel 109 06/11 →

3.0 D Multijet Diesel 130 06/11 →

DUCATO Furgonato (250)

110 Multijet 2,3 D Diesel 83 10/11 →

115 Multijet 2,0 D Diesel 85 06/11 →

150 Multijet 2,3 D Diesel 109 06/11 →

3.0 D Multijet Diesel 130 06/11 →

DUCATO Pianale piatto/Telaio (250)

110 Multijet 2,3 D Diesel 83 10/11 →

115 Multijet 2,0 D Diesel 85 06/11 →

130 Multijet 2,3 D Diesel 96 01/07 →

150 Multijet 2,3 D Diesel 109 06/11 →

3.0 D Multijet Diesel 130 06/11 →

FIORINO Cassone / Furgonato / Promiscuo (225)

1.3 D Multijet Diesel 55 11/07 →

1.3 D Multijet Diesel 70 07/09 →

IDEA

1.3 D Multijet Diesel 66 10/05 →

1.3 D Multijet Diesel 70 05/08 →

1.6 D Multijet Diesel 88 05/08 →

LINEA (323)

1.3 D Multijet Diesel 66 06/07 →

1.6 D Multijet Diesel 77 06/09 →

PANDA (169)

1.3 D Multijet Diesel 55 06/06 →

1.3 D Multijet 4x4 Diesel 55 09/10 →

PUNTO (199)

1.3 D Multijet Diesel 55 03/12 →

1.3 D Multijet Diesel 62 03/12 →

1.3 D Multijet Diesel 70 03/12 →

PUNTO / GRANDE PUNTO (199)

1.3 D Multijet Diesel 55 10/05 →

1.3 D Multijet Diesel 62 04/10 →

1.6 D Multijet Diesel 88 07/08 →

1.9 D Multijet Diesel 85 06/06 →

SAF001

FIAT
PUNTO / GRANDE PUNTO (199)

1.9 D Multijet	Diesel	88	10/05 →
1.9 D Multijet	Diesel	96	10/05 →

PUNTO EVO (199)

1.3 D Multijet	Diesel	55	10/09 → 02/12
1.3 D Multijet	Diesel	62	10/09 → 02/12
1.3 D Multijet	Diesel	70	10/09 → 02/12
1.6 D Multijet	Diesel	88	10/09 → 02/12

QUBO (225)

1.3 D Multijet	Diesel	55	02/08 →
1.3 D Multijet	Diesel	70	07/10 →

STILO (192)

1.9 D Multijet	Diesel	110	09/05 → 11/06
1.9 D Multijet	Diesel	88	09/05 → 11/06
1.9 D Multijet	Diesel	74	09/05 → 11/06

STILO Multi Wagon (192)

1.9 D Multijet	Diesel	110	09/05 → 08/08
1.9 D Multijet	Diesel	88	09/05 → 08/08
1.9 D Multijet	Diesel	74	09/05 → 08/08

STRADA Pick-up (578_)

1.3 D Multijet	Diesel	70	10/10 →
----------------	--------	----	---------

FORD
KA (RU8)

1.3 TDCi	Diesel	55	10/08 →
----------	--------	----	---------

LANCIA
DELTA III (844)

1.6 D Multijet	Diesel	88	09/08 →
1.6 D Multijet	Diesel	77	04/11 →
1.6 D Multijet	Diesel	85	08/08 →
1.9 D Multijet	Diesel	140	01/09 →
2.0 D Multijet	Diesel	121	09/08 →
2.0 D Multijet	Diesel	120	09/08 →

MUSA (350)

1.3 D Multijet	Diesel	70	03/09 →
1.6 D Multijet	Diesel	85	07/08 →
1.6 D Multijet	Diesel	88	07/08 →

YPSILON (846)

1.3 Multijet	Diesel	70	05/11 →
--------------	--------	----	---------

OPEL
COMBO Cassone / Furgonato / Promiscuo (X12)

1.3 CDTi	Diesel	66	02/12 →
1.6 CDTi	Diesel	66	02/12 →
1.6 CDTi	Diesel	74	02/12 →
1.6 CDTi	Diesel	77	02/12 →
2.0 CDTi	Diesel	99	02/12 →

SAF001

OPEL
COMBO Tour (X12)

1.6 CDTi	Diesel	66	02/12 →
1.6 CDTi	Diesel	74	02/12 →
1.6 CDTi	Diesel	77	02/12 →
2.0 CDTi	Diesel	99	02/12 →

PEUGEOT
BOXER Autobus

3.0 HDi 175	Diesel	130	03/11 →
-------------	--------	-----	---------

BOXER Furgonato

3.0 HDi 175	Diesel	130	03/11 →
-------------	--------	-----	---------

BOXER Pianale piatto/Telaio

3.0 HDi 175	Diesel	130	03/11 →
-------------	--------	-----	---------

VOLKSWAGEN
BORA (1J2)

2.0	Petrol	85	10/98 → 05/05
-----	--------	----	---------------

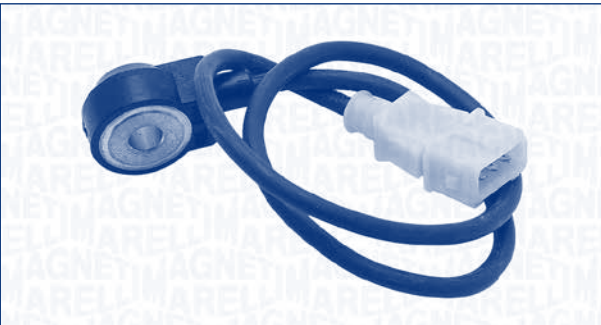
SAD002
H3 **SENSORE DETONAZIONE
KNOCK SENSOR**

FORD
GALAXY (WGR)

2.8 i V6	Petrol	128	11/95 → 04/00
2.8 i V6 4x4	Petrol	128	04/96 → 04/00

VOLKSWAGEN
GOLF III (1H1)

2.8 VR6	Petrol	128	01/92 → 08/97
2.9 VR6 Syncro (1HX1)	Petrol	140	10/94 → 08/97

GOLF III Variant (1H5)

2.9 VR6	Petrol	140	10/94 → 04/99
---------	--------	-----	---------------

SAD003

H3 **SENSORE DETONAZIONE**
KNOCK SENSOR



FIAT

BRAVO I (182)

2.0 HGT 20V (182AQ)	Petrol	113	07/98 → 10/01
---------------------	--------	-----	---------------

COUPE (FA/175)

2.0 20V	Petrol	113	04/98 → 08/00
---------	--------	-----	---------------

MAREA (185)

2.0 150 20V	Petrol	110	01/01 → 05/02
-------------	--------	-----	---------------

2.0 155 20V	Petrol	113	04/99 → 01/01
-------------	--------	-----	---------------

MAREA Weekend (185)

2.0 150 20V	Petrol	110	01/01 → 05/02
-------------	--------	-----	---------------

2.0 155 20V	Petrol	113	04/99 → 02/03
-------------	--------	-----	---------------

STILO (192)

2.4 20V (192_XD1A)	Petrol	125	10/01 → 11/06
--------------------	--------	-----	---------------

LANCIA

LYBRA (839AX)

2.0 20V (839AXC11, 839AXC1A)	Petrol	113	07/99 → 09/00
------------------------------	--------	-----	---------------

2.0 20V (839AXH1A)	Petrol	110	09/00 → 10/05
--------------------	--------	-----	---------------

LYBRA SW (839BX)

2.0 20V (839BXC11, 839BXC1A)	Petrol	113	07/99 → 09/00
------------------------------	--------	-----	---------------

2.0 20V (839BXH1A)	Petrol	110	09/00 → 10/05
--------------------	--------	-----	---------------

THESIS (841AX)

2.4 (841AXB1B00)	Petrol	125	07/02 → 07/09
------------------	--------	-----	---------------

SAD004

H3 **SENSORE DETONAZIONE**
KNOCK SENSOR



ALFA ROMEO

159 (939)

1.9 JTS	Petrol	118	09/05 → 11/11
---------	--------	-----	---------------

2.2 JTS	Petrol	136	09/05 → 11/11
---------	--------	-----	---------------

3.2 JTS Q4	Petrol	191	12/05 → 11/11
------------	--------	-----	---------------

159 Sportwagon (939)

1.9 JTS	Petrol	118	03/06 → 11/11
---------	--------	-----	---------------

2.2 JTS	Petrol	136	03/06 → 11/11
---------	--------	-----	---------------

3.2 JTS Q4	Petrol	191	03/06 → 11/11
------------	--------	-----	---------------

BRERA

2.2 JTS	Petrol	136	01/06 →
---------	--------	-----	---------

3.2 JTS	Petrol	191	03/08 →
---------	--------	-----	---------

3.2 JTS Q4	Petrol	191	01/06 →
------------	--------	-----	---------

SPIDER (939)

2.2 JTS	Petrol	136	09/06 →
---------	--------	-----	---------

3.2 JTS	Petrol	191	03/08 →
---------	--------	-----	---------

3.2 JTS Q4	Petrol	191	09/06 →
------------	--------	-----	---------

OPEL

ANTARA

3.2 V6	Petrol	167	03/07 →
--------	--------	-----	---------

SIGNUM

2.8 V6 Turbo	Petrol	169	09/05 →
--------------	--------	-----	---------

2.8 V6 Turbo	Petrol	184	01/06 →
--------------	--------	-----	---------

VECTRA C

2.8 V6 Turbo	Petrol	169	08/05 →
--------------	--------	-----	---------

2.8 V6 Turbo	Petrol	184	08/06 →
--------------	--------	-----	---------

2.8 V6 Turbo	Petrol	188	08/05 →
--------------	--------	-----	---------

VECTRA C GTS

2.8 V6 Turbo	Petrol	169	08/05 →
--------------	--------	-----	---------

2.8 V6 Turbo	Petrol	184	08/06 →
--------------	--------	-----	---------

2.8 V6 Turbo	Petrol	188	08/05 →
--------------	--------	-----	---------

2.8 V6 Turbo	Petrol	206	08/06 →
--------------	--------	-----	---------

VECTRA C Station wagon

2.8 V6 Turbo	Petrol	169	08/05 →
--------------	--------	-----	---------

2.8 V6 Turbo	Petrol	184	01/07 →
--------------	--------	-----	---------

SAD004

KW

OPEL
VECTRA C Station wagon

2.8 V6 Turbo Petrol 188 08/05 →

2.8 V6 Turbo Petrol 206 01/07 →

SAAB
9-3 (YS3F)

2.8 Turbo V6 Petrol 184 03/05 →

2.8 Turbo V6 Petrol 188 12/07 →

9-3 Cabriolet (YS3F)

2.8 Turbo V6 Petrol 184 02/06 →

2.8 Turbo V6 Petrol 188 12/07 →

9-3 Station wagon

2.8 Turbo V6 Petrol 184 03/05 →

2.8 Turbo V6 Petrol 188 12/07 →

SAD005
H3
**SENSORE DETONAZIONE
KNOCK SENSOR**

KW

VOLKSWAGEN
POLO Coupé (86C, 80)

1.3 G40 Petrol 83 12/90 → 09/94

TRANSPORTER IV Autobus (70XB, 70XC, 7DB, 7DW)

2.5 Petrol 81 01/94 → 10/96

2.5 Syncro Petrol 81 01/94 → 10/96

TRANSPORTER IV Furgonato (70XA)

2.5 Petrol 85 08/96 → 04/03

2.5 Syncro Petrol 85 08/96 → 04/03

TRANSPORTER IV Pianale piatto/Telaio (70XD)

2.5 Petrol 85 08/96 → 04/03

2.5 Petrol 81 01/94 → 10/96

2.5 Syncro Petrol 81 01/94 → 10/96

2.5 Syncro Petrol 85 08/96 → 04/03

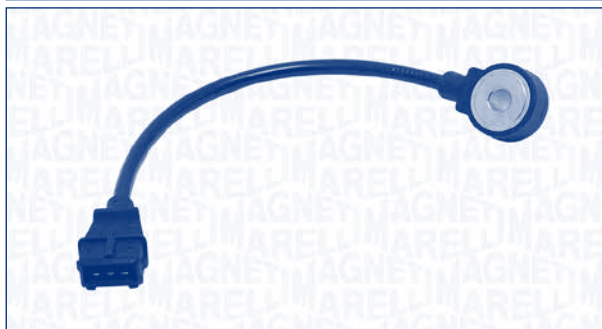
SAD006
H3
**SENSORE DETONAZIONE
KNOCK SENSOR**

KW

HYUNDAI
COUPE (RD)

1.6 16V Petrol 85 03/98 → 04/02

1.6 i 16V Petrol 84 12/96 → 04/02

LANTRA II (J-2)

1.6 i Petrol 66 11/95 → 09/00

1.8 16V Petrol 94 11/95 → 09/00

LANTRA II Wagon (J-2)

2.0 16V Petrol 102 12/96 → 10/00

KIA
RETONA (CE)

2.0 16V Petrol 94 05/00 →

SPORTAGE (K00)

2.0 Petrol 87 10/00 → 08/03

2.0 4WD Petrol 87 10/00 → 08/03

2.0 i 16V Petrol 94 10/99 → 08/03

SAD007
H3
**SENSORE DETONAZIONE
KNOCK SENSOR**

KW

OPEL
ASTRA H (L48)

1.8 Petrol 92 03/04 →

SAD007



OPEL

ASTRA H GTC (L08)

1.8 Petrol 92 03/05 →

ASTRA H Station wagon (L35)

1.8 Petrol 92 08/04 →

ASTRA H TwinTop (L67)

1.8 Petrol 92 09/05 →

CORSA C (F08, F68)

1.8 Petrol 92 09/00 → 12/09

MERIVA

1.8 Petrol 92 05/03 → 05/10

SIGNUM

1.8 Petrol 90 05/03 →

TIGRA TwinTop

1.8 Petrol 92 06/04 →

VECTRA C

1.8 Petrol 81 04/02 →

1.8 16V Petrol 90 04/02 →

VECTRA C GTS

1.8 16V Petrol 90 08/02 →

VECTRA C Station wagon

1.8 Petrol 90 10/03 →

SAD008

H3
SENSORE DETONAZIONE
KNOCK SENSOR

CITROËN

C5 II (RC_)

3.0 V6 (RCXFUF) Petrol 152 09/04 →

EVASION (22, U6)

2.0 16V Petrol 97 05/98 → 04/00

XANTIA (X2)

2.0 i 16V Petrol 97 01/98 → 04/03

XANTIA Break (X2)

2.0 i 16V Petrol 97 01/98 → 04/03

SAD008



CITROËN

XM (Y3)

2.0 i Turbo Petrol 104 09/92 → 06/94

XM (Y4)

2.0 i 16V Petrol 97 05/94 → 10/00

2.0 Turbo Petrol 108 05/94 → 10/00

XM Break (Y3)

2.0 Turbo Petrol 104 09/92 → 04/94

XM Break (Y4)

2.0 i 16V Petrol 97 05/94 → 10/00

XSARA (N1)

2.0 16V Petrol 97 07/98 → 09/00

XSARA Break (N2)

2.0 16V Petrol 97 07/98 → 09/00

ZX (N2)

1.8 i 16V Petrol 81 01/96 → 06/97

ZX Break (N2)

1.8 i 16V Petrol 81 01/96 → 02/98

FIAT

ULYSSE (179AX)

3.0 Petrol 150 08/02 → 06/11

ULYSSE (220)

2.0 16V Petrol 97 05/98 → 09/00

LANCIA

PHEDRA (179)

3.0 V6 Petrol 150 09/02 → 11/10

PEUGEOT

306 (7B, N3, N5)

2.0 Petrol 97 03/97 → 05/01

306 2 volumi /Coda spiovente (7A, 7C, N3, N5)

2.0 16V Petrol 97 03/97 → 05/01

306 Break (7E, N3, N5)

2.0 Petrol 97 03/97 → 04/02

306 Cabriolet (7D, N3, N5)

2.0 16V Petrol 97 03/97 → 04/02

406 (8B)

1.8 16V Petrol 81 11/95 → 10/00

2.0 16V Petrol 97 11/95 → 05/04

407 (6D_)

3.0 Petrol 155 05/04 →

407 Coupé (6C_)

3.0 V6 Petrol 155 10/05 →

407 SW (6E_)

3.0 Petrol 155 05/04 →

607 (9D, 9U)

3.0 V6 24V Petrol 155 03/04 →

SAD008

PEUGEOT
806 (221)

2.0 16V Petrol 97 05/98 → 09/00

RENAULT
AVANTIME (DE0_)

3.0 V6 (DE04, DE0T) Petrol 152 09/01 → 05/03

CLIO II (BB0/1/2_, CB0/1/2_)

3.0 V6 Sport (CB1A) Petrol 166 11/00 → 12/02

3.0 V6 Sport (CB1H, CB1U, CB2S) Petrol 187 12/02 →

LAGUNA II (BG0/1_)

3.0 V6 24V (BG01, BG02, BG0D, BG0Y) Petrol 152 03/01 →

LAGUNA II Grandtour (KG0/1_)

3.0 V6 24V (KG0D) Petrol 152 03/01 →

SAD009
H3 **SENSORE DETONAZIONE
KNOCK SENSOR**

ALFA ROMEO
145 (930)

2.0 16V T.S. Petrol 110 10/95 → 01/01

146 (930)

2.0 16V T.S. Petrol 110 10/95 → 01/01

155 (167)

2.0 T.S. 16V (167.A2G) Petrol 110 03/95 → 12/97

156 (932)

1.6 16V T.SPARK (932A4) Petrol 88 09/97 → 09/05

SAD009

ALFA ROMEO
156 Sportwagon (932)

1.6 16V T.SPARK. (932A4) Petrol 88 05/00 → 05/06

164 (164)

2.0 V6 Turbo (164.A2G, 164.A2F) Petrol 150 03/91 → 09/92

2.0 V6 Turbo (164.K3) Petrol 148 09/92 → 09/98

166 (936)

2.5 V6 24V (936A2_) Petrol 140 09/98 → 10/00

3.0 V6 24V (936A1_) Petrol 166 09/98 → 10/00

GTV (916C_)

2.0 T.SPARK 16V (916.C2_, 916C2C00) Petrol 110 06/95 → 10/05

2.0 V6 Turbo (916.C2A) Petrol 148 06/95 → 09/98

SPIDER (916S_)

2.0 T.SPARK 16V (916S2C00) Petrol 110 06/95 → 04/05

DAEWOO
NUBIRA Tre volumi (KLAJ)

1.6 16V Petrol 78 05/97 →

FIAT
BRAVO I (182)

2.0 HGT 20V (182.AD) Petrol 108 10/95 → 07/98

COUPE (FA/175)

2.0 16V Turbo Petrol 140 11/93 → 08/96

LANCIA
DELTA I (831AB0)

2.0 16V HF Evo Integrale (831AB.027) Petrol 155 06/93 → 01/94

DELTA II (836)

2.0 16V Turbo (836AS) Petrol 142 07/96 → 08/99

KAPPA (838A)

2.0 16V Turbo (838AB1AA) Petrol 151 02/95 → 10/01

SAD009



LANCIA

KAPPA (838A)

2.0 20V (838AA1AA) Petrol 107 10/94 → 10/01

2.4 20V (838AC1AA, 838AC11A) Petrol 129 08/94 → 10/01

THEMA (834)

3000 V6 (834GD, 834FD) Petrol 126 08/92 → 07/94

THEMA SW (834)

2000 16V (834FA) Petrol 112 05/92 → 07/94

3000 V6 (834GD, 834FD) Petrol 126 09/92 → 07/94

SAD010

H3 **SENSORE DETONAZIONE**
KNOCK SENSOR



SUBARU

FORESTER (SF)

2.0 Petrol 90 08/97 → 09/02

2.0 Petrol 92 06/98 → 09/02

IMPREZA Tre volumi (GC)

2.0 iAWD Petrol 85 10/95 → 12/00

LEGACY III (BE, BH)

2.0 Petrol 92 04/99 → 08/03

2.5 Petrol 115 10/98 → 08/03

LEGACY III Station wagon (BE, BH)

2.0 AWD Petrol 92 12/98 → 08/03

2.5 AWD Petrol 115 12/98 → 08/03

SAD012

H3 **SENSORE DETONAZIONE**
KNOCK SENSOR

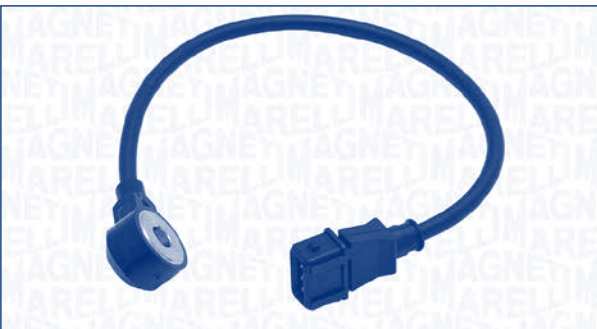

OPEL

ASTRA F (56_, 57_)

1.8 i 16V Petrol 92 06/93 → 10/94

1.8 i 16V Petrol 85 11/94 → 09/98

2.0 i 16V Petrol 100 02/95 → 09/98

ASTRA F 2 volumi /Coda spiovente (53_, 54_, 58_, 59_)

1.8 i 16V Petrol 92 06/93 → 08/94

1.8 i 16V Petrol 85 09/94 → 01/98

2.0 i 16V Petrol 100 02/95 → 01/98

ASTRA F Cabriolet (53_B)

1.8 i 16V Petrol 85 11/94 → 03/01

ASTRA F Station wagon (51_, 52_)

1.8 i 16V Petrol 92 06/93 → 01/98

1.8 i 16V Petrol 85 07/94 → 01/98

2.0 i 16V Petrol 100 02/95 → 01/98

CALIBRA A (85_)

2.0 i 16V Petrol 100 02/94 → 07/97

2.0 i 16V 4x4 Petrol 100 02/94 → 07/97

OMEGA B (25_, 26_, 27_)

2.0 16V Petrol 100 03/94 → 09/99

OMEGA B Station wagon (21_, 22_, 23_)

2.0 16V Petrol 100 03/94 → 09/99

VECTRA A (86_, 87_)

2.0 i 16V Petrol 100 06/94 → 11/95

2.0 i 16V 4x4 Petrol 100 06/94 → 11/95

VECTRA A 2 volumi /Coda spiovente (88_, 89_)

2.0 i 16V Petrol 100 06/94 → 11/95

VECTRA B (36_)

1.8 i 16V Petrol 85 10/95 → 09/00

2.0 i 16V Petrol 100 10/95 → 09/00

VECTRA B 2 volumi /Coda spiovente (38_)

1.8 i 16V Petrol 85 10/95 → 09/00

2.0 i 16V Petrol 100 10/95 → 09/00

SAD012

VAUXHALL
ASTRA Mk III (F) Cabriolet

1.8 16V	Petrol	85	11/94 → 03/01
---------	--------	----	---------------

SAD013
**H3 SENSORE DETONAZIONE
KNOCK SENSOR**

ALFA ROMEO
156 (932)

2.5 V6 24V (932A1)	Petrol	140	09/97 → 12/01
-----------------------	--------	-----	---------------

156 Sportwagon (932)

2.5 V6 24V (932A1)	Petrol	140	05/00 → 08/03
-----------------------	--------	-----	---------------

CITROËN
XANTIA (X1)

2.0 i	Petrol	89	03/93 → 01/98
2.0 i 16V	Petrol	110	06/94 → 01/98
2.0 i 16V	Petrol	112	03/93 → 01/98
2.0 Turbo	Petrol	108	06/95 → 01/98

XANTIA (X2)

2.0 i	Petrol	89	01/98 → 04/03
-------	--------	----	---------------

XANTIA Break (X1)

2.0 i	Petrol	89	06/95 → 01/98
2.0 Turbo	Petrol	108	06/95 → 01/98

XANTIA Break (X2)

2.0 i	Petrol	89	01/98 → 04/03
-------	--------	----	---------------

XM (Y3)

3.0 V6	Petrol	123	05/89 → 06/94
3.0 V6 24V	Petrol	147	07/90 → 06/94

XM (Y4)

3.0 V6	Petrol	123	05/94 → 10/00
3.0 V6 24V	Petrol	147	05/94 → 10/00

XM Break (Y3)

3.0 V6	Petrol	123	11/91 → 04/94
--------	--------	-----	---------------

SAD013

CITROËN
XM Break (Y4)

3.0 V6	Petrol	123	05/94 → 10/00
--------	--------	-----	---------------

ZX (N2)

2.0 i	Petrol	89	07/92 → 06/97
2.0 i 16V	Petrol	110	06/94 → 06/97
2.0 i 16V	Petrol	112	07/92 → 10/94

FIAT
BRAVA (182)

1.2 16V 80	Petrol	60	12/98 → 12/02
1.4 (182.BG)	Petrol	55	10/95 → 10/01

BRAVO I (182)

1.2 16V 80	Petrol	60	12/98 → 10/00
1.4 (182.AG)	Petrol	55	10/95 → 10/01

MAREA (185)

1.2 16V	Petrol	60	10/98 → 05/02
---------	--------	----	---------------

MAREA Weekend (185)

1.2 16V	Petrol	60	10/98 → 05/02
---------	--------	----	---------------

PUNTO (176)

1.4 GT Turbo	Petrol	98	01/94 → 09/96
--------------	--------	----	---------------

HYUNDAI
ACCENT I (X-3)

1.5 i 12V	Petrol	65	10/94 → 01/00
-----------	--------	----	---------------

ACCENT I (X-3)

1.5 i 16V	Petrol	73	12/95 → 01/00
-----------	--------	----	---------------

ACCENT Tre volumi (X-3)

1.5 i 12V	Petrol	65	10/94 → 01/00
1.5 i 16V	Petrol	73	10/95 → 01/00

LANTRA II (J-2)

1.5 12V	Petrol	65	12/96 → 09/00
---------	--------	----	---------------

LANTRA II Wagon (J-2)

1.5 12V	Petrol	65	04/97 → 10/00
---------	--------	----	---------------

S COUPE (SLC)

1.5 i	Petrol	65	04/92 → 05/96
-------	--------	----	---------------

S COUPE (SLC)

1.5 i Turbo	Petrol	85	04/91 → 05/96
-------------	--------	----	---------------

LANCIA
KAPPA (838A)

2.0 20V Turbo (838AM1AA)	Petrol	162	06/98 → 10/01
-----------------------------	--------	-----	---------------

KAPPA Coupé (838)

2.0 20V	Petrol	114	07/96 → 03/01
2.0 20V Turbo (838CM)	Petrol	162	06/98 → 03/01

SAD013



LANCIA

KAPPA SW (838B)

2.0 20V Turbo (838BM1AA)	Petrol	162	06/98 → 10/01
-----------------------------	--------	-----	---------------

THEMA (834)

2850 V6 i.e. (834AD, 834CD, 834BD)	Petrol	108	06/88 → 05/92
--	--------	-----	---------------

Y (840A)

1.4 12V (840AC)	Petrol	55	03/96 → 09/03
-----------------	--------	----	---------------

OPEL

FRONTERA A (5_MWL4)

2.2 i (54MWL4)	Petrol	100	03/95 → 10/98
----------------	--------	-----	---------------

FRONTERA A Sport (5_SUD2)

2.0 i (52SUD2, 55SUD2)	Petrol	85	03/92 → 10/98
---------------------------	--------	----	---------------

PEUGEOT

306 (7B, N3, N5)

2.0 S16	Petrol	110	06/94 → 05/01
---------	--------	-----	---------------

2.0 S16	Petrol	112	06/94 → 05/01
---------	--------	-----	---------------

306 2 volumi /Coda spiovente (7A, 7C, N3, N5)

2.0 S16	Petrol	110	06/94 → 05/01
---------	--------	-----	---------------

2.0 S16	Petrol	112	05/93 → 05/01
---------	--------	-----	---------------

406 (8B)

3.0 V6	Petrol	152	03/00 → 05/04
--------	--------	-----	---------------

406 Break (8E/F)

3.0 V6	Petrol	152	03/00 → 10/04
--------	--------	-----	---------------

406 Coupé (8C)

3.0 V6	Petrol	152	03/00 → 12/04
--------	--------	-----	---------------

605 (6B)

3.0 SV 24	Petrol	147	08/89 → 09/99
-----------	--------	-----	---------------

RENAULT

LAGUNA I (B56_, 556_)

3.0 (B56E/R, B565)	Petrol	123	11/93 → 03/01
-----------------------	--------	-----	---------------

SAFRANE I (B54_)

3.0 Biturbo 4x4 (B545)	Petrol	193	02/93 → 07/96
---------------------------	--------	-----	---------------

3.0 V6 (B54B, B544)	Petrol	123	12/92 → 07/96
------------------------	--------	-----	---------------

VOLVO

760 (704, 764)

2.8 (704)	Petrol	105	05/86 → 08/91
-----------	--------	-----	---------------

2.8 (704, 764)	Petrol	115	08/81 → 07/88
----------------	--------	-----	---------------

760 Kombi (704, 765)

2.8 (765)	Petrol	105	05/86 → 08/91
-----------	--------	-----	---------------

SAD014

H3 SENSORE DETONAZIONE
KNOCK SENSOR

HYUNDAI

COUPE (GK)

2.0	Petrol	102	03/02 → 08/09
-----	--------	-----	---------------

2.0	Petrol	100	08/01 → 08/09
-----	--------	-----	---------------

2.0 GLS	Petrol	105	02/03 → 08/09
---------	--------	-----	---------------

ELANTRA (XD)

1.8	Petrol	97	06/00 → 07/06
-----	--------	----	---------------

2.0	Petrol	102	06/00 → 07/06
-----	--------	-----	---------------

2.0	Petrol	104	06/00 → 07/06
-----	--------	-----	---------------

2.0	Petrol	105	10/03 → 07/06
-----	--------	-----	---------------

ELANTRA Tre volumi (XD)

1.8	Petrol	97	06/00 → 07/06
-----	--------	----	---------------

2.0	Petrol	102	06/00 → 07/06
-----	--------	-----	---------------

2.0	Petrol	104	06/00 → 07/06
-----	--------	-----	---------------

2.0	Petrol	105	10/03 → 07/06
-----	--------	-----	---------------

MATRIX (FC)

1.8	Petrol	90	06/01 → 08/10
-----	--------	----	---------------

TRAJET (FO)

2.0	Petrol	100	03/00 → 07/08
-----	--------	-----	---------------

2.0	Petrol	103	01/04 → 07/08
-----	--------	-----	---------------

TUCSON (JM)

2.0	Petrol	104	08/04 → 03/10
-----	--------	-----	---------------

2.0 Trazione integrale	Petrol	104	08/04 → 03/10
---------------------------	--------	-----	---------------

KIA

CARENS II (FJ)

2.0 CVT	Petrol	102	08/04 →
---------	--------	-----	---------

CERATO (LD)

2.0	Petrol	105	04/04 →
-----	--------	-----	---------

CERATO Tre volumi (LD)

2.0	Petrol	105	04/04 →
-----	--------	-----	---------

SPORTAGE (JE_)

2.0 16V 4WD	Petrol	104	09/04 →
-------------	--------	-----	---------

2.0 i 16V	Petrol	104	09/04 →
-----------	--------	-----	---------

SAD015
H3 **SENSORE DETONAZIONE
KNOCK SENSOR**

OPEL
ASTRA G 2 volumi /Coda spiovente (F48_, F08_)

1.8 16V Petrol 85 02/98 → 09/00

1.8 16V Petrol 92 09/00 → 01/05

ASTRA G Cabriolet (F67)

1.8 16V Petrol 92 03/01 → 10/05

ASTRA G Coupé (F07_)

1.8 16V Petrol 85 03/00 → 10/00

1.8 16V Petrol 92 09/00 → 05/05

ASTRA G Station wagon (F35_)

1.8 16V Petrol 85 02/98 → 09/00

1.8 16V Petrol 92 09/00 → 07/04

ASTRA G Tre volumi (F69_)

1.8 16V Petrol 85 09/98 → 09/00

1.8 16V Petrol 92 06/00 → 01/05

SIGNUM

2.2 direct Petrol 114 05/03 →

VECTRA C

2.2 direct Petrol 114 10/03 →

VECTRA C GTS

2.2 direct Petrol 114 10/03 →

VECTRA C Station wagon

2.2 direct Petrol 114 10/03 →

ZAFIRA A (F75_)

1.8 16V Petrol 85 04/99 → 09/00

1.8 16V Petrol 92 09/00 → 06/05

ZAFIRA B (A05)

2.2 Petrol 110 07/05 →

VAUXHALL
SIGNUM

2.2 i Petrol 114 05/03 → 05/08

VECTRA Mk II (C)

2.2 direct Petrol 114 01/02 → 10/08

VECTRA Mk II (C) GTS

2.2 direct Petrol 114 10/03 → 08/05

SAD015

VAUXHALL
VECTRA Mk II (C) Station wagon

2.2 direct Petrol 114 10/03 → 07/08

ZAFIRA Mk II (B) (M75)

2.2 Petrol 110 07/05 →

SAD016
H3 **SENSORE DETONAZIONE
KNOCK SENSOR**

ALFA ROMEO
145 (930)

1.8 i.e. 16V Petrol 106 03/98 → 01/01

 2.0 16V
Quadrifoglio Petrol 114 03/98 → 01/01

146 (930)

1.8 i.e. 16V T.S. Petrol 106 03/98 → 01/01

 2.0 16V
Quadrifoglio Petrol 114 03/98 → 01/01

147 (937)

 1.6 16V T.SPARK
(937AXB1A) Petrol 88 01/01 → 03/10

 1.6 16V
T.SPARK ECO
(937AXA1A) Petrol 77 01/01 → 03/10

 2.0 16V T.SPARK
(937AXC1_) Petrol 110 01/01 → 03/10

156 (932)

 1.8 16V T.SPARK
(932A3) Petrol 106 09/97 → 10/00

 1.8 16V T.SPARK
(932A31_) Petrol 103 10/00 → 09/05

 2.0 16V T.SPARK
(932A2) Petrol 114 09/97 → 10/00

 2.0 16V T.SPARK
(932A21_) Petrol 110 10/00 → 03/02

SAD016



ALFA ROMEO

156 Sportwagon (932)

1.8 16V T.SPARK (932A3) Petrol 106 05/00 → 10/00

1.8 16V T.SPARK (932B31_) Petrol 103 10/00 → 05/06

2.0 16V T.SPARK (932A2) Petrol 114 05/00 → 06/02

2.0 16V T.SPARK (932B21_) Petrol 110 10/00 → 03/02

166 (936)

2.0 T.Spark (936A3A_) Petrol 114 09/98 → 10/00

2.0 T.Spark (936A3B_) Petrol 110 10/00 → 06/07

GT (937)

1.8 TS Petrol 103 11/03 → 09/10

GTV (916C_)

1.8 16V (916C3) Petrol 106 05/98 → 10/05

2.0 T.SPARK 16V (916C2C) Petrol 114 05/98 → 08/00

SPIDER (916S_)

1.8 16V (916S3) Petrol 106 05/98 → 04/05

2.0 T.SPARK 16V (916S2B) Petrol 114 05/98 → 08/00

SAD018

H3 SENSORE DETONAZIONE KNOCK SENSOR

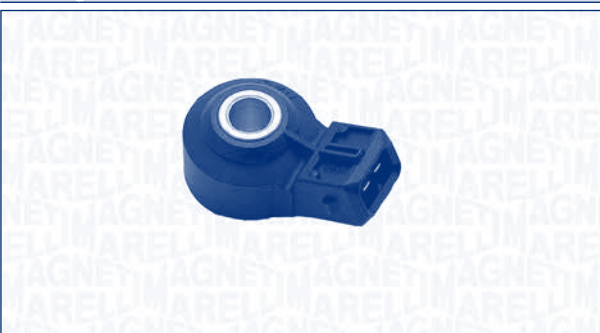

MERCEDES-BENZ

CLASSE C (W202)

C 240 (202.026) Petrol 125 06/97 → 05/00

C 280 (202.029) Petrol 145 06/97 → 05/00

C 43 AMG (202.033) Petrol 225 08/97 → 05/00

SAD018



MERCEDES-BENZ

CLASSE C (W203)

C 240 (203.061) Petrol 125 05/00 → 02/07

C 240 4-matic (203.081) Petrol 125 07/02 → 02/07

C 32 AMG Kompressor (203.065) Petrol 260 02/01 → 02/07

C 320 (203.064) Petrol 160 05/00 → 02/07

C 320 4-matic (203.084) Petrol 160 07/02 → 02/07

C 55 AMG (203.076) Petrol 270 02/04 → 02/07

CLASSE C Sportcoupe (CL203)

C 320 (203.764) Petrol 160 09/02 → 05/08

C 350 (203.756) Petrol 200 01/05 → 05/08

CLASSE C Station wagon (S202)

C 240 T (202.086) Petrol 125 06/97 → 09/00

C 240 T (202.088) Petrol 125 09/00 → 03/01

C 280 T (202.089) Petrol 145 06/97 → 03/01

C 43 AMG (202.093) Petrol 225 08/97 → 03/01

CLASSE C T-Model (S203)

C 240 (203.261) Petrol 125 03/01 → 08/07

C 240 4-matic (203.281) Petrol 125 07/02 → 08/07

C 32 AMG Kompressor (203.265) Petrol 260 03/01 → 08/07

C 320 (203.264, 203.764) Petrol 160 03/01 → 08/07

C 320 4-matic (203.284) Petrol 160 07/02 → 08/07

C 350 4-matic (203.287) Petrol 200 01/05 → 08/07

C 55 AMG (203.276) Petrol 270 02/04 → 08/07

CLASSE E (W210)

E 240 (210.061) Petrol 125 06/97 → 08/00

E 240 (210.062) Petrol 125 08/00 → 03/02

E 420 (210.072) Petrol 205 01/96 → 06/97

E 430 (210.070) Petrol 205 06/97 → 03/02

SAD018

MERCEDES-BENZ
CLASSE E (W210)

E 430 4-matic (210.083)	Petrol	205	05/99 → 03/02
E 50 AMG (210.072)	Petrol	255	02/96 → 08/97
E 55 AMG (210.074)	Petrol	260	08/97 → 03/02

CLASSE E (W211)

E 240 (211.061)	Petrol	130	03/02 → 12/08
E 240 4-matic (211.080)	Petrol	130	03/03 → 12/08
E 320 (211.065)	Petrol	165	03/02 → 12/08
E 320 4-matic (211.082)	Petrol	165	03/03 → 12/08
E 500 (211.070)	Petrol	225	03/02 → 12/08
E 500 4-matic (211.083)	Petrol	225	10/03 → 12/08
E 55 AMG Kompressor (211.076)	Petrol	350	10/02 → 12/08

CLASSE E Station wagon (S210)

E 240 T (210.261)	Petrol	125	06/97 → 03/03
E 240 T (210.262)	Petrol	125	08/00 → 03/03
E 280 T (210.263)	Petrol	150	12/96 → 03/03
E 420 T (210.272)	Petrol	205	06/96 → 06/97
E 430 T (210.270)	Petrol	205	06/97 → 03/03
E 430 T 4-matic (210.283)	Petrol	205	05/99 → 03/03
E 55 T AMG (210.274)	Petrol	260	08/97 → 03/03

CLASSE E T-Model (S211)

E 240 T (211.261)	Petrol	130	03/03 → 07/09
E 240 T 4-matic (211.280)	Petrol	130	07/03 → 07/09
E 320 T (211.265)	Petrol	165	03/03 → 07/09
E 320 T 4-matic (211.282)	Petrol	165	07/03 → 07/09
E 500 T (211.270)	Petrol	225	10/03 → 07/09
E 500 T 4-matic (211.283)	Petrol	225	10/03 → 07/09
E 55 T AMG Kompressor (211.276)	Petrol	350	07/03 → 07/09

SAD018

MERCEDES-BENZ
CLASSE G (W463)

G 320 (463.232, 463.233, 463.244, 463.245)	Petrol	158	07/97 →
G 500 (463.247, 463.248, 463.249, 463.240, 463.421)	Petrol	218	04/98 →
G 55 AMG (463.270, 463.271)	Petrol	350	06/04 →

CLASSE G Cabrio (W463)

G 320 (463.209)	Petrol	158	11/97 →
G 500 (463)	Petrol	218	04/98 →

CLASSE M (W163)

ML 320 (163.154)	Petrol	160	02/98 → 08/02
ML 350	Petrol	173	02/03 → 06/05
ML 350 (163.157)	Petrol	180	08/02 → 06/05
ML 430 (163.172)	Petrol	200	02/98 → 06/05
ML 500 (163.175)	Petrol	215	09/01 → 06/05
ML 55 AMG (163.174)	Petrol	255	02/00 → 06/05

CLASSE M (W164)

ML 500 4-matic (164.175)	Petrol	225	07/05 →
--------------------------	--------	-----	---------

CLASSE R (W251, V251)

R 500 4-matic (251.075, 251.175)	Petrol	225	01/06 →
----------------------------------	--------	-----	---------

CLASSE S (W140)

S 420 (140.042)	Petrol	205	09/95 → 10/98
S 500 (140.050, 140.051)	Petrol	235	09/95 → 10/98
S 600 (140.056, 140.057)	Petrol	290	09/95 → 10/98

CLASSE S (W220)

S 280 (220.063, 220.163)	Petrol	150	10/98 → 08/05
S 320 (220.065, 220.165)	Petrol	165	10/98 → 08/05
S 350 (220.067, 220.167)	Petrol	180	09/02 → 08/05
S 350 4-matic (220.087, 220.187)	Petrol	180	06/03 → 08/05

SAD018



KW



MERCEDES-BENZ

CLASSE S (W220)

S 430 (220.070, 220.170) Petrol 205 10/98 → 08/05

S 430 4-matic (220.083, 220.183) Petrol 205 09/02 → 08/05

S 500 (220.075, 220.175, 220.875) Petrol 225 10/98 → 08/05

S 500 4-matic (220.084, 220.184) Petrol 225 09/02 → 08/05

S 55 AMG (220.073, 220.173) Petrol 265 04/99 → 08/05

S 55 AMG Kompressor (220.074, 220.174) Petrol 368 06/02 → 08/05

S 600 (220.176) Petrol 368 09/02 → 08/05

S 65 AMG (220.179) Petrol 450 03/04 → 08/05

CLASSE S (W221)

S 600 (221.176) Petrol 380 12/05 →

CLASSE S Coupé (C140)

SEC/CL 420 (140.063) Petrol 205 10/94 → 02/99

SEC/CL 500 (140.070) Petrol 235 09/95 → 02/99

SEC/CL 600 (140.076) Petrol 290 09/95 → 02/99

CLASSE S Coupé (C215)

CL 500 (215.375) Petrol 225 03/99 → 03/06

CL 55 AMG (215.373) Petrol 265 10/99 → 03/06

CL 55 AMG Kompressor (215.374) Petrol 368 06/02 → 03/06

CL 600 (215.376) Petrol 368 09/02 → 03/06

CL 600 (215.378) Petrol 270 03/99 → 03/06

CL 65 AMG (215.379) Petrol 450 09/03 → 03/06

CLK (C208)

320 (208.365) Petrol 160 06/97 → 06/02

430 (208.370) Petrol 205 07/98 → 06/02

SAD018



KW



MERCEDES-BENZ

CLK (C208)

55 AMG (208.374) Petrol 255 08/99 → 06/02

CLK (C209)

240 (209.361) Petrol 125 06/02 → 05/09

320 (209.365) Petrol 160 06/02 → 05/09

500 (209.375) Petrol 225 06/02 → 05/09

55 AMG (209.376) Petrol 270 09/02 → 05/09

CLK Cabriolet (A208)

320 (208.465) Petrol 160 03/98 → 03/02

430 (208.470) Petrol 205 09/98 → 03/02

55 AMG (208.474) Petrol 255 01/00 → 03/02

CLK Cabriolet (A209)

CLK 240 (209.461) Petrol 125 02/03 → 03/10

CLK 320 (209.465) Petrol 160 02/03 → 03/10

CLK 500 (209.475) Petrol 225 02/03 → 03/10

CLK 55 AMG (209.476) Petrol 270 02/03 → 03/10

CLS (C219)

CLS 500 (219.375) Petrol 225 10/04 → 12/10

CLS 55 AMG (219.376) Petrol 350 01/05 → 12/10

SL (R129)

280 (129.059) Petrol 150 05/98 → 10/01

320 (129.064) Petrol 165 05/98 → 10/01

500 (129.068) Petrol 225 05/98 → 10/01

600 (129.076) Petrol 290 09/95 → 10/01

SL (R230)

350 (230.467) Petrol 180 03/03 → 01/12

500 (230.475) Petrol 225 10/01 → 01/12

55 AMG Kompressor (230.474) Petrol 368 06/02 → 01/12

600 (230.476) Petrol 368 04/03 → 01/12

65 AMG (230.479) Petrol 450 03/04 → 01/12

SAD018

MERCEDES-BENZ
SLK (R170)

32 AMG Kompressor (170.466)	Petrol	260	03/01 → 04/04
320 (170.465)	Petrol	160	03/00 → 04/04

SLK (R171)

55 AMG (171.473)	Petrol	265	06/04 → 02/11
------------------	--------	-----	---------------

SLR (R199)

5.4 (199.376)	Petrol	460	04/04 →
---------------	--------	-----	---------

VIANO (W639)

3,0	Petrol	140	09/03 →
3.2	Petrol	160	09/03 →
3.7	Petrol	170	06/04 →

VITO / MIXTO Furgonato (W639)

119	Petrol	140	09/03 →
122	Petrol	160	09/03 →

VITO Autobus (W639)

119	Petrol	140	09/03 →
122	Petrol	160	09/03 →
123	Petrol	170	06/04 →

SAD019
**H3 SENSORE DETONAZIONE
KNOCK SENSOR**

AUDI
100 (44, 44Q, C3)

2.0 Cat.	Petrol	85	01/88 → 11/90
2.3 E	Petrol	100	10/86 → 11/90

100 (4A, C4)

2.0 E	Petrol	85	12/90 → 06/94
2.0 E 16V	Petrol	103	01/92 → 06/94
2.3 E	Petrol	98	12/90 → 06/94

SAD019

AUDI
100 Avant (44, 44Q, C3)

2.0 E Cat.	Petrol	85	01/88 → 11/90
2.3	Petrol	100	08/86 → 11/90

100 Avant (4A, C4)

2.0 E	Petrol	85	09/91 → 06/94
2.3 E	Petrol	98	09/91 → 06/94

80 (89, 89Q, 8A, B3)

1.8	Petrol	83	09/86 → 07/88
2.0 E	Petrol	83	08/88 → 10/90
2.0 E 16V	Petrol	101	03/90 → 09/91

80 (8C, B4)

2.0 E 16V	Petrol	103	08/92 → 12/94
2.3 E	Petrol	98	09/91 → 12/94
2.6	Petrol	110	07/92 → 12/94
2.8	Petrol	128	09/91 → 12/94

80 Avant (8C, B4)

2.0 E 16V	Petrol	103	02/93 → 01/96
2.3 E	Petrol	98	07/92 → 01/96
2.6	Petrol	110	07/92 → 01/96
2.8	Petrol	128	09/91 → 01/96

90 (89, 89Q, 8A, B3)

2.0	Petrol	85	07/88 → 09/91
2.3 E	Petrol	100	04/87 → 07/91
2.3 E	Petrol	98	04/87 → 09/91

A4 (8D2, B5)

1.6	Petrol	74	11/94 → 10/00
1.8	Petrol	92	01/95 → 11/00
1.8 quattro	Petrol	92	01/95 → 11/00
1.8 T	Petrol	110	01/95 → 11/00
1.8 T	Petrol	132	12/97 → 11/00
1.8 T quattro	Petrol	110	01/95 → 11/00
1.8 T quattro	Petrol	132	12/97 → 11/00

A4 Avant (8D5, B5)

1.6	Petrol	74	11/94 → 09/01
1.8	Petrol	92	02/96 → 09/01
1.8 quattro	Petrol	92	01/96 → 09/01
1.8 T	Petrol	110	03/96 → 09/01
1.8 T	Petrol	132	12/97 → 09/01
1.8 T quattro	Petrol	132	12/97 → 09/01

A6 (4A, C4)

1.8	Petrol	92	12/95 → 10/97
2.0	Petrol	85	06/94 → 10/97
2.0 16V	Petrol	103	06/94 → 10/97
2.0 16V quattro	Petrol	103	06/94 → 10/97

SAD019



KW



AUDI

A6 (4A, C4)

S6 4.2 quattro	Petrol	213	06/94 → 10/97
S6 Turbo quattro	Petrol	169	06/94 → 10/97

A6 (4B2, C5)

1.8	Petrol	92	07/97 → 01/05
1.8 T	Petrol	132	12/97 → 01/05
1.8 T quattro	Petrol	110	02/97 → 01/05
1.8 T quattro	Petrol	132	12/97 → 01/05
4.2 quattro	Petrol	220	11/98 → 01/05
S6 quattro	Petrol	250	09/99 → 01/05

A6 Avant (4A, C4)

1.8	Petrol	92	12/95 → 12/97
2.0	Petrol	85	06/94 → 12/97
2.0 16V	Petrol	103	06/94 → 12/97
2.0 16V quattro	Petrol	103	06/94 → 12/97
S6 4.2 quattro	Petrol	213	06/94 → 12/97
S6 Turbo quattro	Petrol	169	06/94 → 12/97

A6 Avant (4B5, C5)

1.8	Petrol	92	12/97 → 01/05
1.8 T	Petrol	110	12/97 → 01/05
1.8 T	Petrol	132	04/99 → 01/05
1.8 T quattro	Petrol	110	12/97 → 01/05
1.8 T quattro	Petrol	132	12/97 → 01/05
4.2 quattro	Petrol	220	11/98 → 01/05

A6 Avant (4B5, C5)

S6 quattro	Petrol	250	09/99 → 01/05
------------	--------	-----	---------------

A8 (4D2, 4D8)

3.7	Petrol	169	07/95 → 12/98
3.7	Petrol	191	11/98 → 09/02
3.7 quattro	Petrol	191	11/98 → 09/02
3.7 quattro	Petrol	169	07/95 → 11/98
4.2 quattro	Petrol	175	02/99 → 04/00
4.2 quattro	Petrol	228	11/98 → 09/02
4.2 quattro	Petrol	180	03/94 → 07/96
4.2 quattro	Petrol	220	03/94 → 11/98
S 8 quattro	Petrol	265	06/99 → 09/02

CABRIOLET (8G7, B4)

2.0 16V	Petrol	103	06/95 → 07/96
2.0 E	Petrol	85	01/93 → 07/98
2.3 E	Petrol	98	05/91 → 07/94
2.6	Petrol	110	06/93 → 08/00
2.8	Petrol	128	11/92 → 08/00

SAD019



KW



AUDI

COUPE (89, 8B)

2.0	Petrol	82	03/90 → 07/90
2.0	Petrol	83	05/89 → 03/90
2.0 16 V	Petrol	101	01/92 → 07/92
2.0 16 V	Petrol	103	08/92 → 12/96
2.3	Petrol	100	10/88 → 07/94
2.3	Petrol	98	03/90 → 12/96
2.3 quattro	Petrol	100	11/88 → 12/92
2.3 quattro	Petrol	98	05/90 → 12/96
2.6 quattro	Petrol	110	08/92 → 12/96
2.8 quattro	Petrol	128	08/91 → 12/96
S2 quattro	Petrol	162	09/90 → 09/92
S2 quattro	Petrol	169	10/92 → 12/96

VOLKSWAGEN

CORRADO (53I)

1.8 G60	Petrol	118	09/88 → 09/93
2.0 i 16V	Petrol	100	08/91 → 12/95

GOLF I Cabriolet (155)

1.8	Petrol	72	08/89 → 03/93
-----	--------	----	---------------

GOLF II (19E, 1G1)

1.8 Syncro	Petrol	72	08/88 → 07/91
------------	--------	----	---------------

GOLF III Variant (1H5)

2.0 Syncro	Petrol	85	08/95 → 04/99
------------	--------	----	---------------

PASSAT (3A2, 35I)

1.8	Petrol	79	04/88 → 07/93
1.8	Petrol	82	04/88 → 07/92
2.0 16V	Petrol	100	08/88 → 09/93

PASSAT (3B2)

1.8 Syncro/4motion	Petrol	92	10/96 → 11/00
--------------------	--------	----	---------------

PASSAT Variant (3A5, 35I)

1.8	Petrol	79	04/88 → 07/90
1.8	Petrol	82	04/88 → 07/92
2.0 16V	Petrol	100	08/88 → 09/93

TOUAREG (7LA, 7L6, 7L7)

4.2 V8	Petrol	228	12/02 → 11/06
--------	--------	-----	---------------

SAD021
H3 **SENSORE DETONAZIONE
KNOCK SENSOR**

KW

AUDI
100 (4A, C4)

2.0 E	Petrol	85	12/90 → 06/94
2.0 E 16V quattro	Petrol	103	07/92 → 06/94
2.0 E quattro	Petrol	85	12/90 → 07/92
2.6	Petrol	110	03/92 → 06/94
2.6 quattro	Petrol	110	04/92 → 06/94
2.8 E	Petrol	128	12/90 → 06/94
2.8 E quattro	Petrol	128	12/90 → 06/94
S4 Turbo quattro	Petrol	169	08/91 → 06/94

100 Avant (4A, C4)

2.0 E	Petrol	85	09/91 → 06/94
2.0 E quattro	Petrol	85	12/90 → 07/92
2.6	Petrol	110	03/92 → 06/94
2.6 quattro	Petrol	110	07/92 → 06/94
2.8 E	Petrol	128	09/91 → 06/94
2.8 E quattro	Petrol	128	09/91 → 06/94

200 (44, 44Q)

2.2 20V Turbo quattro	Petrol	162	03/89 → 12/90
-----------------------	--------	-----	---------------

200 Avant (44, 44Q)

2.2 20V Turbo quattro	Petrol	162	07/89 → 12/90
-----------------------	--------	-----	---------------

80 (89, 89Q, 8A, B3)

1.8 quattro	Petrol	83	09/86 → 08/90
2.0	Petrol	82	10/90 → 08/91
2.0 E 16V	Petrol	101	03/90 → 09/91
2.0 E 16V quattro	Petrol	101	03/90 → 08/91
2.0 E quattro	Petrol	83	08/88 → 09/90
2.0 quattro	Petrol	85	10/90 → 08/91

80 (8C, B4)

1.6 E	Petrol	74	06/93 → 12/94
2.0 E	Petrol	85	09/91 → 12/94
2.0 E 16V	Petrol	103	08/92 → 12/94
2.0 E 16V quattro	Petrol	103	04/92 → 12/94

SAD021

KW

AUDI
80 (8C, B4)

2.0 E quattro	Petrol	85	09/91 → 12/94
2.3 E	Petrol	98	09/91 → 12/94
2.3 E quattro	Petrol	98	09/91 → 12/94
2.6	Petrol	110	07/92 → 12/94
2.6 quattro	Petrol	110	06/92 → 12/94
2.8	Petrol	128	09/91 → 12/94
2.8 quattro	Petrol	128	09/91 → 12/94
S2 quattro	Petrol	169	02/93 → 12/94

80 Avant (8C, B4)

1.6 E	Petrol	74	06/93 → 01/96
-------	--------	----	---------------

80 Avant (8C, B4)

2.0 E	Petrol	85	07/92 → 01/96
2.0 E 16V	Petrol	103	02/93 → 01/96
2.3 E	Petrol	98	07/92 → 01/96
2.3 E quattro	Petrol	98	09/91 → 11/94
2.6	Petrol	110	07/92 → 01/96
2.6 quattro	Petrol	110	07/92 → 07/95

80 Avant (8C, B4)

2.8	Petrol	128	09/91 → 01/96
2.8 quattro	Petrol	128	08/92 → 07/95
RS2 quattro (P1)	Petrol	232	03/94 → 05/95
S2 quattro	Petrol	169	02/93 → 07/95

90 (89, 89Q, 8A, B3)

2.3 E	Petrol	100	04/87 → 07/91
2.3 E	Petrol	98	04/87 → 09/91
2.3 E quattro	Petrol	100	04/87 → 07/91
2.3 E quattro	Petrol	98	04/87 → 09/91

A4 (8D2, B5)

1.8	Petrol	92	01/95 → 11/00
1.8 quattro	Petrol	92	01/95 → 11/00
1.8 T	Petrol	110	01/95 → 11/00
1.8 T	Petrol	132	12/97 → 11/00
1.8 T quattro	Petrol	110	01/95 → 11/00
1.8 T quattro	Petrol	132	12/97 → 11/00
2.4	Petrol	120	08/97 → 11/00
2.4 quattro	Petrol	120	08/97 → 11/00
2.4 quattro	Petrol	121	03/97 → 11/00
2.6	Petrol	110	01/95 → 11/00
2.6 quattro	Petrol	110	01/95 → 11/00
2.8	Petrol	128	09/95 → 07/97
2.8	Petrol	142	10/96 → 11/00
2.8 quattro	Petrol	128	01/95 → 07/97
2.8 quattro	Petrol	142	10/96 → 08/01
S4 quattro	Petrol	195	09/97 → 09/01

SAD021



KW



AUDI

A4 Avant (8D5, B5)

1.8	Petrol	92	02/96 → 09/01
1.8 quattro	Petrol	92	01/96 → 09/01
1.8 T	Petrol	110	03/96 → 09/01
1.8 T	Petrol	132	12/97 → 09/01
1.8 T quattro	Petrol	110	01/96 → 09/01
1.8 T quattro	Petrol	132	12/97 → 09/01
2.4	Petrol	120	08/97 → 09/01
2.4	Petrol	121	03/97 → 09/01
2.4 quattro	Petrol	120	08/97 → 09/01
2.4 quattro	Petrol	121	03/97 → 09/01
2.6	Petrol	110	02/96 → 09/01
2.6 quattro	Petrol	110	01/96 → 09/01
2.8	Petrol	142	10/96 → 09/01
2.8 quattro	Petrol	142	10/96 → 09/01
S4 quattro	Petrol	195	09/97 → 09/01

A6 (4A, C4)

1.8	Petrol	92	12/95 → 10/97
1.8 quattro	Petrol	92	12/95 → 10/97
2.0	Petrol	85	06/94 → 10/97
2.0 16V	Petrol	103	06/94 → 10/97
2.0 16V quattro	Petrol	103	06/94 → 10/97
2.6	Petrol	110	06/94 → 10/97
2.6 quattro	Petrol	110	06/94 → 10/97
2.8	Petrol	128	06/94 → 10/97
2.8	Petrol	142	12/95 → 10/97
2.8 quattro	Petrol	128	06/94 → 10/97
2.8 quattro	Petrol	142	12/95 → 10/97
S6 Turbo quattro	Petrol	169	06/94 → 10/97

A6 (4B2, C5)

1.8	Petrol	92	07/97 → 01/05
1.8 T	Petrol	132	12/97 → 01/05
1.8 T quattro	Petrol	110	02/97 → 01/05
1.8 T quattro	Petrol	132	12/97 → 01/05
2.4	Petrol	100	07/98 → 01/05
2.4	Petrol	115	02/97 → 01/05
2.4	Petrol	120	02/97 → 01/05
2.4	Petrol	121	02/97 → 01/05

A6 (4B2, C5)

2.4 quattro	Petrol	115	08/98 → 07/99
2.4 quattro	Petrol	120	02/97 → 01/05
2.4 quattro	Petrol	121	02/97 → 01/05
2.7 T	Petrol	169	02/99 → 01/05
2.7 T quattro	Petrol	169	12/97 → 01/05
2.8	Petrol	132	10/97 → 05/00

SAD021



KW



AUDI

A6 (4B2, C5)

2.8	Petrol	142	02/97 → 01/05
2.8 quattro	Petrol	142	02/97 → 01/05

A6 Avant (4A, C4)

1.8	Petrol	92	12/95 → 12/97
1.8 quattro	Petrol	92	12/95 → 12/97
2.0	Petrol	85	06/94 → 12/97
2.0 16V	Petrol	103	06/94 → 12/97
2.0 16V quattro	Petrol	103	06/94 → 12/97
2.6	Petrol	110	06/94 → 12/97
2.8	Petrol	128	06/94 → 12/97
2.8	Petrol	142	12/95 → 12/97
2.8 quattro	Petrol	128	06/94 → 12/97
2.8 quattro	Petrol	142	12/95 → 12/97
S6 Turbo quattro	Petrol	169	06/94 → 12/97

A6 Avant (4B5, C5)

1.8	Petrol	92	12/97 → 01/05
1.8 T	Petrol	110	12/97 → 01/05
1.8 T	Petrol	132	04/99 → 01/05
1.8 T quattro	Petrol	110	12/97 → 01/05
1.8 T quattro	Petrol	132	12/97 → 01/05
2.4	Petrol	100	07/98 → 01/05
2.4	Petrol	115	12/97 → 01/05
2.4	Petrol	120	12/97 → 01/05
2.4	Petrol	121	12/97 → 01/05
2.4 quattro	Petrol	115	08/98 → 05/01
2.4 quattro	Petrol	120	12/97 → 01/05
2.4 quattro	Petrol	121	12/97 → 01/05
2.7 T	Petrol	169	02/99 → 01/05
2.7 T quattro	Petrol	169	12/97 → 01/05
2.8	Petrol	132	12/97 → 05/00
2.8	Petrol	142	12/97 → 01/05
2.8 quattro	Petrol	142	12/97 → 01/05

A8 (4D2, 4D8)

2.8	Petrol	120	07/95 → 03/96
2.8	Petrol	128	03/94 → 03/96
2.8	Petrol	142	04/96 → 09/02
2.8 quattro	Petrol	120	07/95 → 03/96
2.8 quattro	Petrol	128	03/94 → 03/96
2.8 quattro	Petrol	142	04/96 → 09/02

CABRIOLET (8G7, B4)

2.0 E	Petrol	85	01/93 → 07/98
2.3 E	Petrol	98	05/91 → 07/94
2.6	Petrol	110	06/93 → 08/00
2.8	Petrol	128	11/92 → 08/00

SAD021

AUDI
COUPE (89, 8B)

2.0	Petrol	85	05/89 → 12/96
2.0	Petrol	82	03/90 → 07/90
2.0	Petrol	83	05/89 → 03/90
2.3	Petrol	100	10/88 → 07/94
2.3	Petrol	98	03/90 → 12/96
2.3 quattro	Petrol	100	11/88 → 12/92
2.3 quattro	Petrol	98	05/90 → 12/96
2.6	Petrol	110	08/92 → 12/96
2.6 quattro	Petrol	110	08/92 → 12/96
2.8	Petrol	128	09/91 → 12/96
2.8 quattro	Petrol	128	08/91 → 12/96
S2 quattro	Petrol	169	10/92 → 12/96

QUATTRO (85)

2.2 20V Turbo	Petrol	162	08/89 → 07/91
---------------	--------	-----	---------------

PORSCHE
928

5.0 GT	Petrol	243	01/89 → 07/91
5.0 S,S4	Petrol	235	08/86 → 07/91
5.0 S4 Cat.	Petrol	235	08/86 → 07/91
5.4 GTS	Petrol	257	08/91 → 11/95

SEAT
CORDOBA Vario (6K5)

1.6 i	Petrol	74	09/96 → 06/99
-------	--------	----	---------------

TOLEDO I (1L)

1.6 i	Petrol	52	05/91 → 12/93
1.6 i	Petrol	54	05/91 → 03/99
1.8 16V	Petrol	98	05/91 → 03/99
1.8 i	Petrol	65	05/91 → 12/96

VOLKSWAGEN
GOLF II (19E, 1G1)

1.8 GTI	Petrol	82	08/83 → 10/91
1.8 GTI 16V	Petrol	95	02/86 → 10/91
1.8 GTI Cat.	Petrol	79	01/87 → 10/91
1.8 GTI G60	Petrol	118	04/90 → 07/91
1.8 GTI G60 Syncro	Petrol	118	08/88 → 12/91

GOLF III (1H1)

1.6	Petrol	74	07/95 → 08/97
-----	--------	----	---------------

GOLF III Variant (1H5)

1.6	Petrol	74	07/94 → 04/99
-----	--------	----	---------------

GOLF IV Cabriolet (1E7)

1.6	Petrol	74	06/98 → 06/02
2.0	Petrol	85	06/98 → 06/02

SAD021

VOLKSWAGEN
JETTA II (19E, 1G2, 165)

1.8	Petrol	82	01/84 → 10/91
1.8 16V	Petrol	95	08/86 → 10/91
1.8 Cat.	Petrol	79	01/87 → 10/91

PASSAT (3A2, 35I)

1.6	Petrol	74	10/94 → 08/96
-----	--------	----	---------------

PASSAT Variant (3A5, 35I)

1.6	Petrol	74	07/94 → 12/95
2.0	Petrol	85	02/90 → 05/97

PASSAT Variant (3B5)

2.8 V6 Syncro/4motion	Petrol	142	06/97 → 11/00
-----------------------	--------	-----	---------------

POLO CLASSIC (6KV2)

100 1.6	Petrol	74	12/95 → 09/01
---------	--------	----	---------------

POLO Variant (6KV5)

1.6	Petrol	74	05/97 → 09/01
-----	--------	----	---------------

VENTO (1H2)

1.6	Petrol	74	10/94 → 09/98
-----	--------	----	---------------

SAD024
**H3 SENSORE DETONAZIONE
KNOCK SENSOR**

CHEVROLET
AVEO Tre volumi (T250, T255)

1.2	Petrol	53	03/06 → 12/07
1.4	Petrol	69	03/06 → 12/07

EPICA (KL1_)

2.0	Petrol	105	06/06 →
2.5	Petrol	115	06/06 →

EVANDA

2.0	Petrol	96	03/05 →
-----	--------	----	---------

SAD024



CHEVROLET

KALOS

1.2	Petrol	53	03/05 →
1.4	Petrol	61	03/05 →
1.4 16V	Petrol	69	03/05 →

LACETTI (J200)

1.4 16V	Petrol	70	03/05 →
1.6	Petrol	80	03/05 →
1.8	Petrol	90	03/05 →

MATIZ (M200, M250)

0.8	Petrol	38	03/05 →
1.0	Petrol	47	03/05 →
1.0	Petrol	49	03/05 →

NUBIRA Station wagon

1.6	Petrol	80	03/05 →
1.8	Petrol	90	03/05 →

NUBIRA Tre volumi

1.6	Petrol	80	03/05 →
1.8	Petrol	90	03/05 →

TACUMA

1.6	Petrol	77	03/05 →
1.6	Petrol	79	08/05 →
2.0	Petrol	89	03/05 →

DAEWOO

KALOS (KLAS)

1.2	Petrol	53	04/03 →
-----	--------	----	---------

LACETTI 2 volumi /Coda spiovente (KLAN)

1.4	Petrol	70	02/04 →
1.8	Petrol	90	02/04 →

LANOS (KLAT)

1.4	Petrol	55	05/97 →
1.5	Petrol	63	05/97 →
1.6 16V	Petrol	78	05/97 →

LANOS Tre volumi (KLAT)

1.4	Petrol	55	05/97 →
1.5	Petrol	63	05/97 →
1.6 16V	Petrol	78	05/97 →

LEGANZA (KLAV)

2.0 16V	Petrol	98	06/97 → 12/02
2.0 16V	Petrol	93	07/00 → 04/04
2.2 16V	Petrol	100	04/99 → 12/02

MATIZ (KLYA)

0.8	Petrol	38	09/98 →
1.0	Petrol	47	01/03 →
1.6 16V	Petrol	78	05/97 →

SAD024



DAEWOO

NUBIRA (KLAJ)

2.0 16V	Petrol	98	05/97 →
---------	--------	----	---------

NUBIRA Tre volumi (KLAJ)

1.6 16V	Petrol	76	07/00 →
1.6 16V	Petrol	78	05/97 →
2.0 16V	Petrol	98	05/97 →
2.0 16V	Petrol	93	12/00 →
1.6	Petrol	80	07/03 →

NUBIRA Wagon (KLAJ)

1.6 16V	Petrol	76	12/00 →
1.6 16V	Petrol	78	05/97 →
2.0 16V	Petrol	98	05/97 →
2.0 16V	Petrol	93	12/00 →

TACUMA (KLAU)

1.8	Petrol	67	09/00 →
1.8	Petrol	72	09/00 →
1.8	Petrol	74	09/00 →
2.0	Petrol	94	09/00 →
2.0	Petrol	89	09/01 →

KIA

SHUMA II (FB)

1.8	Petrol	84	04/03 → 08/04
-----	--------	----	---------------

OPEL

ANTARA

2.4	Petrol	104	05/06 →
-----	--------	-----	---------

SAD025

H3 SENSORE DETONAZIONE
KNOCK SENSOR



CITROËN

C1 (PM_, PN_)

1.0	Petrol	50	06/05 →
-----	--------	----	---------

SAD025

PEUGEOT
107

1.0 Petrol 50 06/05 →

TOYOTA
AYGO (WNB1_, KGB1_)

1.0 (KGB10) Petrol 50 07/05 →

YARIS (SCP9_, NSP9_, KSP9_, NCP9_, ZSP9_)

1.0 VVT-i Petrol 51 08/05 →

SAD026
H3 **SENSORE DETONAZIONE
KNOCK SENSOR**

ALFA ROMEO
GT (937)

2.0 JTS Petrol 121 11/03 → 09/10

MITO (955)

1.4 Petrol 70 09/08 →

1.4 TB Petrol 114 09/08 →

FIAT
500 (312)

1.4 Petrol 74 10/07 →

BRAVA (182)

1.2 16V 80 Petrol 59 10/00 → 10/01

BRAVO I (182)

1.2 16V 80 Petrol 59 10/00 → 10/01

BRAVO II (198)

1.4 Petrol 66 04/07 →

1.4 T-Jet Petrol 110 09/07 →

IDEA

1.2 16V Petrol 59 01/04 →

1.4 16V Petrol 70 01/04 →

LINEA (323)

1.4 T-Jet Petrol 88 09/07 →

PANDA (169)

1.4 Petrol 74 10/06 →

SAD026

FIAT
PUNTO (188)

 1.2 16V 80
(188.233, .235,
253, .255, .333,
.353, .639...) Petrol 59 09/99 →

1.4 Petrol 70 09/03 →

PUNTO / GRANDE PUNTO (199)

1.4 16V Petrol 70 10/05 →

1.4 Abarth Petrol 114 12/07 →

1.4 T-Jet Petrol 88 09/07 →

STILO (192)

 1.2 16V
(192_XA1B) Petrol 59 02/02 → 11/06

1.4 16V Petrol 66 03/05 → 11/06

1.4 16V Petrol 70 01/04 → 11/06

STILO Multi Wagon (192)

1.4 16V Petrol 66 03/05 → 08/08

1.4 16V Petrol 70 01/04 → 08/08

LANCIA
MUSA (350)

1.4 Petrol 70 10/04 →

THESIS (841AX)

 2.0 Turbo
(841AXA1B03) Petrol 136 07/02 → 07/09

Y (840A)

 1.2 16V
(840AG1A) Petrol 59 10/00 → 09/03

YPSILON (843)

1.2 Petrol 59 10/03 → 12/11

1.4 16V Petrol 70 10/03 → 12/11

OPEL
AGILA (A) (H00)

1.0 Petrol 44 08/03 → 12/07

AGILA (A) (H00)

1.2 16V Twinport Petrol 59 07/04 → 12/07

ASTRA H (L48)

1.4 Petrol 66 03/04 →

ASTRA H GTC (L08)

1.4 Petrol 66 03/05 →

ASTRA H Station wagon (L35)

1.4 Petrol 66 08/04 →

COMBO Cassone / Furgonato / Promiscuo

1.4 16V Petrol 66 08/05 →

COMBO Tour

1.4 Petrol 66 10/04 →

SAD026



KW



OPEL

CORSA C (F08, F68)

1.0	Petrol	44	06/03 → 12/09
1.2 Twinport	Petrol	59	07/04 → 12/09
1.4 Twinport	Petrol	66	06/03 → 12/09

CORSA C Furgonato (F08, W5L)

1.2	Petrol	59	07/05 →
-----	--------	----	---------

CORSA D

1.0	Petrol	44	07/06 →
1.2	Petrol	59	07/06 →
1.4 LPG	Petrol/ LPG	66	07/06 →
1.6 Turbo	Petrol	141	02/07 →

MERIVA

1.4 16V Twinport	Petrol	66	07/04 → 05/10
1.6 Turbo	Petrol	132	09/05 → 05/10

TIGRA TwinTop

1.4	Petrol	66	06/04 →
-----	--------	----	---------

PORSCHE

911 (997)

3.6 Carrera	Petrol	239	07/04 → 12/08
3.8 Carrera 4S	Petrol	261	07/04 → 12/08
3.8 Carrera S	Petrol	261	07/04 → 12/08

911 Cabriolet (997)

3.6 Carrera	Petrol	239	04/05 → 12/08
3.6 Carrera 4	Petrol	239	04/05 → 12/08
3.8 Carrera 4S	Petrol	261	04/05 → 12/08
3.8 Carrera S	Petrol	261	04/05 → 12/08

BOXSTER (987)

2.7	Petrol	176	11/04 → 12/06
2.7	Petrol	180	07/06 → 12/09
S 3.2	Petrol	206	11/04 → 12/06
S 3.4	Petrol	217	07/06 → 12/09

CAYMAN (987)

2.7	Petrol	180	07/06 → 12/09
S 3.4	Petrol	217	11/05 → 12/09

VAUXHALL

AGILA Mk I (A)

1.0 12V	Petrol	44	02/00 → 11/06
1.2 16V Twinport	Petrol	59	07/04 → 11/06

ASTRA Mk V (H) 2 volumi /Coda spiovente

1.4	Petrol	66	01/04 → 05/09
-----	--------	----	---------------

ASTRA Mk V (H) Station wagon

1.4	Petrol	66	08/04 → 03/09
-----	--------	----	---------------

COMBO Mk II (C) Cassone / Furgonato / Promiscuo (F25)

1.4 i 16V	Petrol	66	01/04 → 11/11
-----------	--------	----	---------------

SAD026



KW



VAUXHALL

MERIVA Mk I (A)

1.4 16V Twinport	Petrol	66	01/03 → 10/09
1.6 Turbo	Petrol	132	05/06 → 06/10

TIGRA TwinTop

1.4	Petrol	66	06/04 → 08/09
-----	--------	----	---------------

SAD027

H3 SENSORE DETONAZIONE
KNOCK SENSOR

KW



OPEL

ASTRA F (56_, 57_)

1.4 i 16V	Petrol	66	02/96 → 09/98
1.6	Petrol	55	09/95 → 09/98
1.6 i 16V	Petrol	74	08/94 → 09/98

ASTRA F 2 volumi /Coda spiovente (53_, 54_, 58_, 59_)

1.4 i 16V	Petrol	66	01/96 → 01/98
1.6	Petrol	55	09/95 → 01/98
1.6 i	Petrol	55	09/91 → 01/98
1.6 i 16V	Petrol	74	08/94 → 01/98

ASTRA F Cabriolet (53_B)

1.4 i 16V	Petrol	66	01/96 → 03/01
1.6 i	Petrol	55	01/96 → 03/01

ASTRA F CLASSIC 2 volumi /Coda spiovente

1.4 i	Petrol	66	03/98 → 08/00
1.6 i	Petrol	55	01/98 → 08/02
1.6 i 16V	Petrol	74	01/98 → 08/02

ASTRA F CLASSIC Station wagon

1.6 i	Petrol	55	01/98 → 01/05
1.6 i 16V	Petrol	74	01/98 → 01/05

ASTRA F CLASSIC Tre volumi

1.6 i	Petrol	55	01/98 → 08/02
1.6 i 16V	Petrol	74	01/98 → 08/02

SAD027

KW

OPEL
ASTRA F Station wagon (51_, 52_)

1.4 i 16V	Petrol	66	02/96 → 01/98
1.6	Petrol	55	09/95 → 01/98
1.6 i	Petrol	55	09/91 → 01/98
1.6 i 16V	Petrol	74	08/94 → 01/98

ASTRA G 2 volumi /Coda spiovente (F48_, F08_)

1.4 16V	Petrol	66	02/98 → 01/05
1.6	Petrol	55	02/98 → 09/00
1.6	Petrol	62	09/00 → 01/05
1.6 16V	Petrol	74	02/98 → 01/05

ASTRA G Cabriolet (F67)

1.6 16V	Petrol	74	03/01 → 10/05
---------	--------	----	---------------

ASTRA G Furgonato (F70)

1.6	Petrol	55	01/99 → 09/00
1.6	Petrol	62	09/00 → 04/05

ASTRA G Station wagon (F35_)

1.4 16V	Petrol	66	06/98 → 07/04
1.6	Petrol	55	02/98 → 09/00
1.6	Petrol	62	09/00 → 07/04
1.6 16V	Petrol	74	02/98 → 07/04
1.6 CNG	Petrol/ CNG	71	03/03 → 07/04

ASTRA G Tre volumi (F69_)

1.4 16V	Petrol	66	09/98 → 01/05
1.6	Petrol	55	09/98 → 09/00
1.6	Petrol	62	09/00 → 01/05
1.6 16V	Petrol	74	09/98 → 01/05

COMBO (71_)

1.4	Petrol	44	07/94 → 10/01
-----	--------	----	---------------

COMBO Cassone / Furgonato / Promiscuo

1.6	Petrol	64	10/01 →
1.6 CNG 16V	Petrol/ CNG	69	06/06 →
1.6 CNG 16V	Petrol/ CNG	71	04/05 →

COMBO Tour

1.6	Petrol	64	10/01 →
1.6 CNG	Petrol/ CNG	69	06/06 →
1.6 CNG	Petrol/ CNG	71	04/05 →

SAD027

KW

OPEL
CORSA B (73_, 78_, 79_)

1.4 i	Petrol	44	03/93 → 09/00
1.4 i 16V	Petrol	66	09/94 → 09/00
1.6 GSI 16V	Petrol	80	03/93 → 09/00
1.6 i 16V	Petrol	78	09/94 → 09/00

CORSA B Furgonato (73_)

1.4 i	Petrol	44	08/99 → 09/00
-------	--------	----	---------------

CORSA C (F08, F68)

1.4	Petrol	66	09/00 → 12/09
-----	--------	----	---------------

FRONTERA B (6B_)

2.2 i (6B_ZC, 6B_VF, 6B_66, 6B_76)	Petrol	100	10/98 →
--	--------	-----	---------

MERIVA

1.6	Petrol	64	05/03 → 05/10
1.6 16V	Petrol	74	05/03 → 01/06

TIGRA (95_)

1.4 16V	Petrol	66	07/94 → 12/00
1.6 16V	Petrol	78	07/94 → 08/98

VECTRA B (36_)

1.6 i	Petrol	55	10/95 → 04/02
1.6 i 16V	Petrol	74	10/95 → 04/02

VECTRA B 2 volumi /Coda spiovente (38_)

1.6 i	Petrol	55	10/95 → 07/03
1.6 i 16V	Petrol	74	10/95 → 07/02

VECTRA C

1.6 16V	Petrol	74	06/04 →
---------	--------	----	---------

VECTRA C GTS

1.6	Petrol	74	08/05 →
-----	--------	----	---------

VECTRA C Station wagon

1.6 16V	Petrol	74	06/04 →
---------	--------	----	---------

ZAFIRA A (F75_)

1.6 16V	Petrol	74	04/99 → 06/05
1.6 CNG	Petrol/ CNG	71	09/01 → 06/05

ZAFIRA B (A05)

1.6 CNG	Petrol/ CNG	69	01/06 →
---------	----------------	----	---------

SAD028

H3

SENSORE DETONAZIONE
KNOCK SENSOR

KW



CITROËN

DS3

1.4 VTi 95	Petrol	70	04/10 →	
1.6 VTi 120	Petrol	88	04/10 →	

MERCEDES-BENZ

CLASSE C (W203)

C 230 (203.052)	Petrol	150	01/05 → 02/07	
C 280 (203.054)	Petrol	170	01/05 → 02/07	
C 280 4-matic (203.092)	Petrol	170	01/05 → 02/07	
C 350 (203.056)	Petrol	200	01/05 → 02/07	
C 350 4-matic (203.087)	Petrol	200	01/05 → 02/07	

CLASSE C Sportcoupe (CL203)

C 230 (203.752)	Petrol	150	01/05 → 05/08	
-----------------	--------	-----	---------------	--

CLASSE C T-Model (S203)

C 230 (203.252)	Petrol	150	01/05 → 08/07	
C 280 (203.254)	Petrol	170	01/05 → 08/07	
C 280 4-matic (203.292)	Petrol	170	01/05 → 08/07	
C 350 (203.256)	Petrol	200	01/05 → 08/07	

CLASSE E (W211)

E 280 (211.054)	Petrol	170	03/05 → 12/08	
E 280 4-matic (211.092)	Petrol	170	01/06 → 12/08	
E 350 (211.056)	Petrol	200	03/05 → 12/08	
E 350 4-matic (211.087)	Petrol	200	03/05 → 12/08	
E 500 (211.072)	Petrol	285	04/06 → 12/08	
E 500 4-matic (211.090)	Petrol	285	04/06 → 12/08	
E 63 AMG (211.077, 211.177)	Petrol	378	03/06 → 12/08	

SAD028



KW



MERCEDES-BENZ

CLASSE E T-Model (S211)

E 280 T (211.254)	Petrol	170	03/05 → 07/09	
E 280 T 4-matic (211.292)	Petrol	170	03/05 → 07/09	
E 500 T (211.272)	Petrol	285	04/06 → 07/09	
E 500 T 4-matic (211.290)	Petrol	285	04/06 → 07/09	
E 63 AMG (211.277)	Petrol	378	03/06 → 07/09	

CLASSE GL (X164)

GL 450 4-matic (164.871)	Petrol	250	09/06 →	
GL 500 4-matic (164.886)	Petrol	285	09/06 →	

CLASSE M (W164)

ML 63 AMG 4-matic (164.177)	Petrol	375	01/06 →	
-----------------------------	--------	-----	---------	--

CLASSE R (W251, V251)

R 350 4-matic (251.065, 251.165)	Petrol	200	01/06 →	
R 63 AMG (251.077, 251.177)	Petrol	375	02/06 →	

CLASSE S (W221)

S 350 (221.056, 221.156)	Petrol	200	10/05 →	
S 450 4-matic (221.084, 221.184)	Petrol	250	12/05 →	
S 500 (221.071, 221.171)	Petrol	285	10/05 →	
S 500 4-matic (221.086, 221.186)	Petrol	285	10/05 →	
S 63 AMG (221.077, 221.177)	Petrol	386	10/06 →	

CLK (C209)

280 (209.354)	Petrol	170	01/05 → 05/09	
350 (209.356)	Petrol	200	01/05 → 05/09	
63 AMG (209.377)	Petrol	354	04/06 → 05/09	

SAD028

KW

AUDI
CLK Cabriolet (A209)

CLK 280 (209.454)	Petrol	170	01/05 → 03/10
----------------------	--------	-----	---------------

CLK 350 (209.456)	Petrol	200	01/05 → 03/10
----------------------	--------	-----	---------------

CLK 500 (209.472)	Petrol	285	06/06 → 03/10
----------------------	--------	-----	---------------

CLK 63 AMG (209.477)	Petrol	354	04/06 → 03/10
-------------------------	--------	-----	---------------

CLS (C219)

CLS 350 (219.356)	Petrol	200	10/04 → 12/10
----------------------	--------	-----	---------------

CLS 500 (219.372)	Petrol	285	04/06 → 12/10
----------------------	--------	-----	---------------

CLS 63 AMG (219.377)	Petrol	378	04/06 → 12/10
-------------------------	--------	-----	---------------

SL (R230)

350	Petrol	200	03/06 → 01/12
-----	--------	-----	---------------

500	Petrol	285	03/06 → 01/12
-----	--------	-----	---------------

SLK (R171)

280 (171.454)	Petrol	170	01/05 → 02/11
---------------	--------	-----	---------------

350 (171.456)	Petrol	200	06/04 → 02/11
---------------	--------	-----	---------------

SPRINTER 3,5-t Autobus (906)

324 (906.733, 906.735)	Petrol	190	06/06 →
---------------------------	--------	-----	---------

SPRINTER 3,5-t Furgonato (906)

324 (906.633, 906.635, 906.637)	Petrol	190	06/06 →
---------------------------------------	--------	-----	---------

SPRINTER 3,5-t Pianale piatto/Telaio (906)

324 (906.133, 906.135, 906.233, 906.235)	Petrol	190	06/06 →
---	--------	-----	---------

SPRINTER 3-t Furgonato (906)

224 (906.613)	Petrol	190	06/06 →
---------------	--------	-----	---------

SPRINTER 3-t Pianale piatto/Telaio (906)

224 (906.113, 906.213)	Petrol	190	06/06 →
---------------------------	--------	-----	---------

PEUGEOT
106 I (1A, 1C)

1.3	Petrol	72	10/93 → 04/96
-----	--------	----	---------------

RENAULT
LAGUNA I (B56_, 556_)

2.0 16V (B56D/M)	Petrol	102	06/95 → 03/01
---------------------	--------	-----	---------------

SAD028

KW

RENAULT
LAGUNA I Grandtour (K56_)

2.0 16V (K56D/M)	Petrol	102	09/95 → 03/01
---------------------	--------	-----	---------------

MEGANE I Coach (DA0/1_)

2.0 16V (DA0H)	Petrol	108	03/96 → 11/99
----------------	--------	-----	---------------

SAAB
900 II

2.0 i	Petrol	96	08/94 → 02/98
-------	--------	----	---------------

2.3 -16	Petrol	110	07/93 → 02/98
---------	--------	-----	---------------

900 II Cabriolet

2.0 i	Petrol	96	12/93 → 02/98
-------	--------	----	---------------

2.3 -16	Petrol	110	12/93 → 02/98
---------	--------	-----	---------------

900 II Coupé

2.0 i	Petrol	98	12/93 → 07/94
-------	--------	----	---------------

9-3 (YS3D)

2.0 i	Petrol	96	02/98 → 09/02
-------	--------	----	---------------

2.3 i	Petrol	110	02/98 → 09/02
-------	--------	-----	---------------

9-3 Cabriolet (YS3D)

2.0 i	Petrol	96	02/98 → 08/03
-------	--------	----	---------------

2.3 i	Petrol	110	02/98 → 08/03
-------	--------	-----	---------------

SEAT
CORDOBA (6K1, 6K2)

1.0 i	Petrol	37	09/96 → 06/99
-------	--------	----	---------------

1.4 i	Petrol	44	06/94 → 06/99
-------	--------	----	---------------

1.6 i	Petrol	55	02/93 → 06/99
-------	--------	----	---------------

CORDOBA (6K2)

1.0	Petrol	37	06/99 → 10/02
-----	--------	----	---------------

1.4	Petrol	44	06/99 → 10/02
-----	--------	----	---------------

1.4 16V	Petrol	55	05/00 → 10/02
---------	--------	----	---------------

1.6	Petrol	55	06/99 → 10/02
-----	--------	----	---------------

CORDOBA Vario (6K5)

1.4	Petrol	44	06/99 → 12/02
-----	--------	----	---------------

1.4 16V	Petrol	55	06/99 → 12/02
---------	--------	----	---------------

1.4 i	Petrol	44	09/96 → 06/99
-------	--------	----	---------------

1.6	Petrol	55	06/99 → 12/02
-----	--------	----	---------------

1.6 i	Petrol	55	09/96 → 06/99
-------	--------	----	---------------

IBIZA II (6K1)

1.6 i	Petrol	55	03/93 → 08/99
-------	--------	----	---------------

1.0	Petrol	37	08/99 → 02/02
-----	--------	----	---------------

1.4	Petrol	44	08/99 → 02/02
-----	--------	----	---------------

1.4 16V	Petrol	55	05/00 → 02/02
---------	--------	----	---------------

1.4 16V	Petrol	74	08/99 → 02/02
---------	--------	----	---------------

IBIZA III (6K1)

1.6	Petrol	55	08/99 → 02/02
-----	--------	----	---------------

SAD028



KW



SEAT

INCA (6K9)

1.4 16V	Petrol	55	04/00 → 06/03
1.6 i	Petrol	55	06/97 → 09/00

SKODA

OCTAVIA Combi (1U5)

1.6	Petrol	55	07/98 → 09/04
2.0	Petrol	85	04/99 → 05/07

VOLKSWAGEN

BORA (1J2)

1.4 16V	Petrol	55	03/00 → 05/05
1.6 16V	Petrol	77	05/00 → 05/05
2.0	Petrol	85	10/98 → 05/05
2.0 4motion	Petrol	85	04/00 → 05/05

BORA Station wagon (1J6)

1.4 16V	Petrol	55	09/01 → 05/05
1.6 16V	Petrol	77	02/00 → 05/05
2.0	Petrol	85	05/99 → 05/05
2.0 4motion	Petrol	85	04/00 → 05/05

CADDY II Furgonato (9K9A)

1.4	Petrol	55	08/00 → 01/04
60 1.4	Petrol	44	11/95 → 01/04
75 1.6	Petrol	55	11/95 → 09/00

CADDY II Station wagon (9K9B)

1.4	Petrol	44	11/95 → 01/04
1.4 16V	Petrol	55	08/00 → 01/04

GOLF III (1H1)

1.4	Petrol	44	10/91 → 08/97
1.4	Petrol	40	11/91 → 08/97
1.6	Petrol	55	09/92 → 08/97

GOLF III Variant (1H5)

1.4	Petrol	44	07/93 → 04/99
-----	--------	----	---------------

GOLF IV Variant (1J5)

1.4 16V	Petrol	55	05/99 → 06/06
1.6 16V	Petrol	77	02/00 → 06/06
2.0	Petrol	85	05/99 → 06/06
2.0 4motion	Petrol	85	10/00 → 06/06

LUPO (6X1, 6E1)

1.0	Petrol	37	09/98 → 07/05
1.4	Petrol	44	10/00 → 07/05
1.4 16V	Petrol	55	09/98 → 07/05
1.4 16V	Petrol	74	08/99 → 07/05
1.6 GTI	Petrol	92	09/00 → 07/05

NEW BEETLE (9C1, 1C1)

RSI 3.2 4motion (1C9)	Petrol	165	04/00 → 05/01
-----------------------	--------	-----	---------------

SAD028



KW



VOLKSWAGEN

POLO (6N1)

100 1.4 16V	Petrol	74	04/96 → 10/99
120 1.6 16V GTI	Petrol	88	09/98 → 10/99
55 1.3	Petrol	40	10/94 → 07/95
55 1.4	Petrol	40	08/95 → 10/99
75 1.6	Petrol	55	10/94 → 10/99

POLO (6N2)

1.0	Petrol	37	10/99 → 09/01
1.4	Petrol	40	10/99 → 09/01
1.4	Petrol	44	10/99 → 09/01
1.4 16V	Petrol	55	10/99 → 09/01
1.4 16V	Petrol	74	10/99 → 09/01
1.6 16V GTI	Petrol	92	10/99 → 09/01

POLO CLASSIC (6KV2)

60 1.4	Petrol	44	12/95 → 09/01
75 1.4 16V	Petrol	55	10/99 → 09/01
75 1.6	Petrol	55	11/95 → 09/01

POLO Furgonato (6NF)

1.4	Petrol	44	05/98 → 12/99
-----	--------	----	---------------

POLO Variant (6KV5)

1.4	Petrol	44	05/97 → 09/01
1.4 16V	Petrol	55	10/99 → 09/01
1.6	Petrol	55	05/97 → 09/01

SAD029

H3

**SENSORE DETONAZIONE
KNOCK SENSOR**



KW



MITSUBISHI

PAJERO IV (V8_W, V9_W)

3.8 V6 (V87W, V97W)	Petrol	184	02/07 →
---------------------	--------	-----	---------

SAD029

KW

NISSAN
ALMERA II (N16)

1.5	Petrol	66	07/00 →
1.5	Petrol	72	10/02 →
1.8	Petrol	85	10/02 →

ALMERA II Hatchback (N16)

1.5	Petrol	72	10/02 →
1.5	Petrol	66	03/00 →
1.8	Petrol	85	10/02 →
1.8	Petrol	84	01/00 →

ALMERA TINO (V10)

1.8	Petrol	84	08/00 →
1.8	Petrol	85	12/02 →

MICRA C+C (K12)

1.4 16V	Petrol	65	08/05 →
1.6 160 SR	Petrol	81	08/05 →

MICRA III (K12)

1.0 16V	Petrol	48	01/03 → 06/10
1.2 16V	Petrol	48	01/03 → 06/10
1.2 16V	Petrol	59	01/03 → 06/10
1.4 16V	Petrol	65	01/03 → 06/10
160 SR	Petrol	81	05/05 → 06/10

NOTE (E11)

1.4	Petrol	65	03/06 →
1.6	Petrol	81	03/06 →

PATHFINDER (R51)

4.0 4WD	Petrol	198	09/05 →
---------	--------	-----	---------

PRIMERA (P12)

1.6	Petrol	78	03/02 →
1.6	Petrol	80	01/02 →
1.8	Petrol	85	03/02 →
2.0	Petrol	103	03/02 →

PRIMERA Hatchback (P12)

1.6	Petrol	78	07/02 →
1.6	Petrol	80	07/02 →
1.8	Petrol	85	07/02 →
2.0	Petrol	103	07/02 →

PRIMERA Station wagon (WP12)

1.6 Visia	Petrol	80	01/02 →
1.8	Petrol	85	03/02 →
2.0	Petrol	103	03/02 →

QASHQAI / QASHQAI +2 (J10, JJ10)

1.6	Petrol	84	02/07 →
2.0	Petrol	103	02/07 →
2.0 Trazione integrale	Petrol	103	02/07 →

SAD029

KW

NISSAN
TIIDA 2 volumi /Coda spiovente (C11X)

1.6	Petrol	81	09/07 →
1.8	Petrol	93	09/07 →

TIIDA Tre volumi (SC11X)

1.6	Petrol	81	09/07 →
1.8	Petrol	93	09/07 →

X-TRAIL (T30)

2.0	Petrol	103	09/03 →
2.0 4x4	Petrol	103	09/03 →
2.5 4x4	Petrol	121	09/03 →

X-TRAIL (T31)

2.0	Petrol	104	06/07 →
-----	--------	-----	---------

RENAULT
CLIO III (BR0/1, CR0/1)

2.0 16V (BR0C, BR0K, CR0C, CR0K)	Petrol	102	09/06 →
----------------------------------	--------	-----	---------

LAGUNA III (BT0/1)

2.0 16V (BT05, BT0F, BT0W)	Petrol	103	10/07 →
----------------------------	--------	-----	---------

LAGUNA III Sportour (KT0/1)

2.0 16V (KT0F, KT0W)	Petrol	103	10/07 →
----------------------	--------	-----	---------

MEGANE III Coupé (DZ0/1_)

2.0 CVT (DZ0G, DZ1E)	Petrol	103	05/09 →
----------------------	--------	-----	---------

SMART
FORTWO Cabrio (451)

1.0 (451.431, 451.480)	Petrol	52	01/07 →
------------------------	--------	----	---------

1.0 Brabus (451.433)	Petrol	72	01/08 →
----------------------	--------	----	---------

1.0 Turbo (451.432)	Petrol	62	01/07 →
---------------------	--------	----	---------

FORTWO Coupé (451)

1.0 (451.330, 451.334)	Petrol	45	01/07 →
------------------------	--------	----	---------

1.0 (451.331, 451.380)	Petrol	52	01/07 →
------------------------	--------	----	---------

1.0 Brabus (451.333)	Petrol	72	01/08 →
----------------------	--------	----	---------

1.0 Turbo (451.332)	Petrol	62	01/07 →
---------------------	--------	----	---------

SAD030

H3

SENSORE DETONAZIONE
KNOCK SENSOR

KW



CITROËN

BERLINGO (MF)

1.6 16V (MFNFU) Petrol 80 10/00 →

C2 (JM_)

1.1 Petrol 44 09/03 → 10/03

1.4 Petrol 54 09/03 → 10/03

C3 I (FC_)

1.1 i Petrol 44 02/02 →

1.4 i Petrol 54 02/02 →

1.6 16V Petrol 80 02/02 → 09/02

C3 Pluriel (HB_)

1.4 Petrol 54 05/03 → 10/03

SAXO (S0, S1)

1.6 VTS Petrol 72 09/00 → 10/02

XSARA (N1)

1.4 i Petrol 55 07/97 → 03/05

1.6 16V Petrol 80 09/00 → 10/02

1.6 i Petrol 65 07/98 → 09/00

XSARA Break (N2)

1.4 i Petrol 55 04/98 → 08/05

1.6 16V Petrol 80 09/00 → 10/02

1.6 i Petrol 65 07/98 → 09/00

XSARA Coupé (N0)

1.4 i Petrol 55 03/98 → 03/05

1.6 16V Petrol 80 09/00 → 10/02

1.6 i Petrol 65 02/98 → 09/00

XSARA PICASSO (N68)

1.6 Petrol 65 12/99 →

1.6 Chrono Petrol 74 04/01 → 11/02

PEUGEOT

206 2 volumi /Coda spiovente (2A/C)

1.4 i Petrol 55 09/98 →

1.6 i Petrol 65 09/98 → 12/00

SAD030



KW



PEUGEOT

306 (7B, N3, N5)

1.4 SL Petrol 55 05/97 → 05/01

1.6 Petrol 72 10/00 → 05/01

1.6 SR Petrol 65 03/98 → 10/00

306 2 volumi /Coda spiovente (7A, 7C, N3, N5)

1.4 Petrol 55 05/97 → 05/01

1.6 Petrol 72 10/00 → 05/01

1.6 Petrol 65 03/98 → 10/00

306 Break (7E, N3, N5)

1.4 Petrol 55 03/97 → 04/02

1.6 Petrol 72 10/00 → 04/02

1.6 Petrol 65 03/98 → 10/00

306 Cabriolet (7D, N3, N5)

1.6 Petrol 72 10/00 → 04/02

RANCH Furgonato (5)

1.4 Petrol 54 11/02 → 10/06

1.6 Petrol 80 09/00 → 10/02

RANCH MPV / Space wagon (5F)

1.1 Petrol 44 09/02 →

1.4 Petrol 55 04/98 →

1.6 16V Petrol 80 07/01 → 09/02

SAD031

H3

SENSORE DETONAZIONE
KNOCK SENSOR

KW



AUDI

A2 (8Z0)

1.2 TDI Diesel 45 03/01 → 08/05

1.4 Petrol 55 02/00 → 08/05

1.4 TDI Diesel 55 02/00 → 08/05

1.4 TDI Diesel 66 11/03 → 08/05

1.6 FSI Petrol 81 05/02 → 08/05

SAD031

AUDI
A3 (8L1)

1.6	Petrol	75	08/00 → 05/03
1.8 T	Petrol	132	12/98 → 05/03
1.8 T quattro	Petrol	110	12/96 → 05/03
1.8 T quattro	Petrol	132	10/98 → 05/03
S3 quattro	Petrol	165	10/01 → 05/03
S3 quattro	Petrol	154	03/99 → 04/02

A3 (8P1)

1.6	Petrol	75	05/03 → 08/12
1.6 FSI	Petrol	85	08/03 → 09/07
2.0 FSI	Petrol	110	05/03 → 06/08
3.2 V6 quattro	Petrol	184	07/03 → 05/09

A3 Sportback (8PA)

1.6	Petrol	75	09/04 → 03/13
1.6 FSI	Petrol	85	09/04 → 09/07
2.0 FSI	Petrol	110	09/04 → 06/08
3.2 V6 quattro	Petrol	184	09/04 → 05/09

A4 (8EC, B7)

2.0 TFSI	Petrol	125	10/06 → 06/08
2.0 TFSI	Petrol	147	11/04 → 06/08
2.0 TFSI quattro	Petrol	147	11/04 → 06/08
2.0 TFSI quattro	Petrol	162	06/05 → 06/08

A4 Avant (8ED, B7)

2.0 TFSI	Petrol	125	10/06 → 06/08
2.0 TFSI	Petrol	147	11/04 → 06/08
2.0 TFSI	Petrol	162	06/05 → 06/08

A4 Avant (8ED, B7)

2.0 TFSI quattro	Petrol	162	06/05 → 06/08
------------------	--------	-----	---------------

A6 (4F2, C6)

2.0 TFSI	Petrol	125	06/05 → 03/11
----------	--------	-----	---------------

A6 Avant (4F5, C6)

2.0 TFSI	Petrol	125	06/05 → 08/11
----------	--------	-----	---------------

Q7 (4L)

3.6 FSI	Petrol	206	08/06 → 05/10
---------	--------	-----	---------------

TT (8J3)

3.2 V6 quattro	Petrol	184	08/06 → 06/10
----------------	--------	-----	---------------

TT (8N3)

1.8 T	Petrol	110	09/02 → 06/06
1.8 T	Petrol	120	09/05 → 06/06
1.8 T	Petrol	132	10/98 → 06/06
1.8 T	Petrol	140	09/05 → 06/06
1.8 T quattro	Petrol	140	09/05 → 06/06
1.8 T quattro	Petrol	176	03/05 → 06/06
1.8 T quattro	Petrol	132	10/98 → 06/06
1.8 T quattro	Petrol	165	10/98 → 06/06

SAD031

AUDI
TT (8N3)

3.2 VR6 quattro	Petrol	184	07/03 → 06/06
-----------------	--------	-----	---------------

TT Roadster (8J9)

3.2 V6 quattro	Petrol	184	03/07 → 06/10
----------------	--------	-----	---------------

TT Roadster (8N9)

1.8 T	Petrol	110	01/01 → 06/06
1.8 T	Petrol	132	10/99 → 06/06
1.8 T	Petrol	140	09/05 → 06/06
1.8 T quattro	Petrol	132	02/00 → 06/06
1.8 T quattro	Petrol	140	09/05 → 06/06
1.8 T quattro	Petrol	165	10/99 → 06/06
3.2 VR6 quattro	Petrol	184	07/03 → 06/06

FORD
GALAXY (WGR)

2.8 V6	Petrol	150	04/00 → 05/06
--------	--------	-----	---------------

SEAT
ALHAMBRA (7V8, 7V9)

1.8 T 20V	Petrol	110	10/97 → 03/10
2.8 V6	Petrol	150	06/00 → 03/10
2.8 V6 4motion	Petrol	150	06/00 → 03/10

ALTEA (5P1)

1.6	Petrol	75	03/04 →
-----	--------	----	---------

CORDOBA (6L2)

1.2	Petrol	47	10/02 → 06/06
1.4 16V	Petrol	74	10/02 → 11/09
1.6	Petrol	74	04/03 → 11/09
2.0	Petrol	85	09/02 → 11/09

IBIZA IV (6L1)

1.4 16V	Petrol	55	02/02 → 12/07
1.4 16V	Petrol	74	02/02 → 11/09
1.6	Petrol	74	02/03 → 11/09
1.8 T Cupra R	Petrol	132	01/04 → 02/08
1.8 T FR	Petrol	110	12/03 → 05/08

LEON (1M1)

1.4 16V	Petrol	55	11/99 → 06/06
1.8 T Cupra R	Petrol	154	02/02 → 06/06
1.8 T Cupra R	Petrol	165	07/03 → 06/06
2.8 Cupra 4	Petrol	150	02/01 → 06/06

LEON (1P1)

1.6	Petrol	75	07/05 →
2.0 FSI	Petrol	110	07/05 → 05/10

TOLEDO II (1M2)

1.4 16V	Petrol	55	07/99 → 05/06
2.3 V5	Petrol	110	04/99 → 05/01
2.3 V5 20V	Petrol	125	05/01 → 05/06

SAD031



KW



SEAT

TOLEDO III (5P2)

1.6 Petrol 75 10/04 → 05/09

SKODA

FABIA (6Y2)

1.2 Petrol 40 08/02 → 03/08

1.2 Petrol 47 01/03 → 03/08

1.4 16V Petrol 55 12/99 → 03/08

1.4 16V Petrol 74 12/99 → 03/08

2.0 Petrol 85 12/99 → 03/08

FABIA Combi (6Y5)

1.2 Petrol 40 07/01 → 12/07

1.2 Petrol 47 01/03 → 12/07

1.4 16V Petrol 55 05/00 → 12/07

1.4 16V Petrol 74 04/00 → 12/07

2.0 Petrol 85 04/00 → 12/07

FABIA Praktik

1.2 Petrol 47 01/03 → 12/07

1.2 Petrol 40 07/01 → 12/07

FABIA Tre volumi (6Y3)

1.2 Petrol 40 07/01 → 12/07

1.2 Petrol 47 01/03 → 12/07

1.4 16V Petrol 55 10/99 → 12/07

1.4 16V Petrol 74 12/99 → 12/07

2.0 Petrol 85 12/99 → 12/07

OCTAVIA (1U2)

1.4 16V Petrol 55 09/00 → 12/10

1.6 Petrol 75 11/00 → 12/10

1.8 T Petrol 110 08/97 → 12/10

RS 1.8 T Petrol 132 05/01 → 01/06

OCTAVIA (1Z3)

1.4 Petrol 55 05/04 → 05/06

1.6 Petrol 75 06/04 →

1.6 FSI Petrol 85 02/04 → 10/08

2.0 FSI Petrol 110 11/04 →

ROOMSTER (5J)

1.2 Petrol 47 05/06 → 01/07

1.4 Petrol 63 09/06 →

1.6 Petrol 77 09/06 →

VOLKSWAGEN

EOS (1F7, 1F8)

1.6 FSI Petrol 85 06/06 → 05/08

2.0 FSI Petrol 110 03/06 → 05/08

3.2 V6 Petrol 184 06/06 → 05/09

SAD031



KW



VOLKSWAGEN

FOX (5Z1, 5Z3)

1.2 Petrol 40 04/05 →

1.4 Petrol 55 04/05 →

GOLF IV (1J1)

1.6 Petrol 75 08/00 → 06/05

1.6 FSI Petrol 81 01/02 → 06/05

1.8 T Petrol 110 08/97 → 06/05

1.8 T GTI Petrol 132 08/01 → 06/05

GOLF PLUS (5M1, 521)

1.4 16V Petrol 55 01/05 →

1.4 16V Petrol 59 05/06 →

1.4 FSI Petrol 66 07/05 →

1.6 Petrol 75 05/05 →

2.0 FSI Petrol 110 05/05 → 06/08

GOLF V (1K1)

1.4 16V Petrol 59 05/06 → 11/08

1.4 FSI Petrol 66 10/03 → 07/06

1.4 TSI Petrol 103 05/06 → 11/08

1.4 TSI Petrol 125 11/05 → 11/08

1.6 Petrol 75 01/04 → 11/08

1.6 FSI Petrol 85 10/03 → 07/08

2.0 FSI Petrol 110 01/04 → 11/08

2.0 FSI 4motion Petrol 110 08/04 → 11/08

3.2 R32 4motion Petrol 184 11/05 → 11/08

LUPO (6X1, 6E1)

1.4 FSI Petrol 77 02/01 → 07/05

MULTIVAN V (7HM, 7HN, 7HF, 7EF, 7EM, 7EN)

2.0 Petrol 85 11/03 →

3.2 V6 Petrol 170 02/04 → 06/04

3.2 V6 Petrol 173 02/04 → 11/09

3.2 V6 4motion Petrol 173 07/04 → 11/09

NEW BEETLE (9C1, 1C1)

1.4 Petrol 55 11/01 → 09/10

1.6 Petrol 75 06/00 → 09/10

1.8 T Petrol 132 11/01 → 06/05

2.0 Petrol 85 01/98 → 09/10

PASSAT (3C2)

1.6 Petrol 75 05/05 → 07/10

1.6 FSI Petrol 85 03/05 → 06/08

2.0 FSI Petrol 110 03/05 → 07/10

2.0 FSI 4motion Petrol 110 09/05 → 07/10

3.2 FSI 4motion Petrol 184 11/05 → 07/10

PHAETON (3D_)

3.2 V6 Petrol 177 04/02 →

SAD031

KW

VOLKSWAGEN
POLO (9N_)

1.2	Petrol	40	01/02 → 05/07
1.4 16V	Petrol	55	10/01 → 05/08
1.4 16V	Petrol	74	10/01 → 05/08
1.4 16V	Petrol	59	05/06 → 11/09
1.4 FSI	Petrol	63	02/02 → 07/06
1.6 16V	Petrol	77	05/06 → 11/09
1.8 GTI	Petrol	110	09/05 → 11/09

 1.8 GTi Cup
Edition

Petrol	132	05/06 → 11/09
--------	-----	---------------

POLO Tre volumi (9A4)

1.4	Petrol	55	07/03 →
1.4	Petrol	74	11/03 →

TOUAREG (7LA, 7L6, 7L7)

3.2 V6	Petrol	162	10/02 → 11/06
3.6 V6 FSI	Petrol	206	10/05 → 05/10

TOURAN (1T1, 1T2)

1.4 TSI	Petrol	103	02/06 → 05/10
1.6	Petrol	75	07/03 → 05/10
1.6 FSI	Petrol	85	02/03 → 01/07
2.0 EcoFuel	Petrol/ CNG	80	02/06 → 05/09
2.0 FSI	Petrol	110	10/03 → 11/05

TRANSPORTER V Autobus (7HB, 7HJ, 7EB, 7EJ, 7EF)

2.0	Petrol	85	11/03 →
3.2 V6	Petrol	170	02/04 → 06/04
3.2 V6	Petrol	173	02/04 → 11/09

TRANSPORTER V Furgonato (7HA, 7HH, 7EA, 7EH)

2.0	Petrol	85	11/03 →
3.2 V6	Petrol	170	04/03 → 06/04
3.2 V6	Petrol	173	02/04 → 11/09

TRANSPORTER V Pianale piatto/Telaio (7JD, 7JE, 7JL, 7JY, 7JZ)

2.0	Petrol	85	11/03 →
3.2 V6	Petrol	170	02/04 → 11/09
3.2 V6	Petrol	173	08/03 → 05/06

SAD033
H3
**SENSORE DETONAZIONE
KNOCK SENSOR**

KW

ALFA ROMEO
159 (939)

1.8 MPI	Petrol	103	03/07 → 11/11
---------	--------	-----	---------------

159 Sportwagon (939)

1.8 MPI	Petrol	103	03/07 → 11/11
---------	--------	-----	---------------

CITROËN
BERLINGO (MF)

1.8 i (MFLFX)	Petrol	66	05/97 →
1.8 i 4WD (MFLFX)	Petrol	66	04/97 →

BERLINGO Furgonato (M_)

1.8 i	Petrol	66	08/99 → 10/02
-------	--------	----	---------------

C5 I (DC_)

2.0 16V (DCRFNC, DCRFNF)	Petrol	100	03/01 → 08/04
--------------------------	--------	-----	---------------

C5 I Break (DE_)

2.0 16V (DERFNF, DERFNC, RERFNC)	Petrol	100	06/01 → 08/04
----------------------------------	--------	-----	---------------

C8 (EA_, EB_)

2.0	Petrol	100	07/02 →
2.2	Petrol	116	07/02 →

EVASION (22, U6)

2.0 16V	Petrol	100	05/00 → 07/02
---------	--------	-----	---------------

JUMPER Autobus (244, Z_)

2.0	Petrol	81	04/02 →
2.0 bivalent	Petrol/ CNG	81	02/03 →

JUMPER Furgonato (244)

2.0	Petrol	81	04/02 →
-----	--------	----	---------

JUMPY (U6U)

2.0	Petrol	100	04/00 → 12/06
2.0 i 16V	Petrol	102	03/00 →

SAD033



KW



CITROËN

SAXO (S0, S1)

1.1 X,SX Petrol 44 05/96 → 09/03

XANTIA (X1)

1.8 i Petrol 66 04/97 → 01/98

XANTIA (X2)

1.8 i Petrol 66 01/98 → 04/03

XANTIA Break (X1)

1.8 i Petrol 66 04/97 → 01/98

XSARA (N1)

1.4 i Petrol 55 04/97 → 03/05

1.8 i Petrol 66 04/97 → 09/00

2.0 16V Petrol 100 09/00 → 03/05

XSARA PICASSO (N68)

2.0 16V Petrol 100 01/03 →

ZX (N2)

1.4 i Petrol 55 03/91 → 06/97

ZX Break (N2)

1.4 i Petrol 55 10/93 → 10/97

DAEWOO

KORANDO (KJ)

2.3 Petrol 105 01/99 →

FIAT

CROMA (194)

1.8 16V Petrol 103 12/05 →

DUCATO Autobus (244, Z_)

2.0 Petrol 81 04/02 →

DUCATO Furgonato (244)

2.0 Petrol 81 04/02 →

SCUDO Furgonato (220L)

2.0 Petrol 100 05/00 → 12/06

ULYSSE (179AX)

2.0 Petrol 100 08/02 → 06/11

LANCIA

PHEDRA (179)

2.0 (179AXA11) Petrol 100 09/02 → 11/10

ZETA (220)

2.0 16V (220AQ5) Petrol 100 07/00 → 09/02

MERCEDES-BENZ

CLASSE A (W168)

A 140 (168.031, 168.131) Petrol 60 01/01 → 08/04

A 140 (168.031, 168.131) Petrol 60 07/97 → 08/04

SAD033



KW



MERCEDES-BENZ

A 160 (168.033, 168.133) Petrol 75 07/97 → 08/04

A 190 (168.032, 168.132) Petrol 92 03/99 → 08/04

A 210 (168.035, 168.135) Petrol 103 03/02 → 08/04

CLASSE C (W202)

C 180 (202.018) Petrol 90 03/93 → 05/00

C 180 (202.018) Petrol 89 11/94 → 05/00

C 200 (202.020) Petrol 100 01/94 → 05/00

C 200 Kompressor (202.025) Petrol 132 10/95 → 05/00

C 220 (202.022) Petrol 110 03/93 → 05/00

C 230 Kompressor (202.024) Petrol 142 10/95 → 05/00

C 280 (202.028) Petrol 142 05/93 → 05/00

C 36 AMG (202.028) Petrol 206 05/94 → 05/00

CLASSE C Station wagon (S202)

C 180 T (202.078) Petrol 90 06/96 → 09/00

C 200 T (202.080) Petrol 100 06/96 → 03/01

C 200 T Kompressor (202.082) Petrol 141 11/96 → 03/01

C 230 T Kompressor (202.085) Petrol 142 06/97 → 09/00

CLASSE E (W124)

E 220 (124.022) Petrol 110 06/93 → 06/95

E 280 (124.028) Petrol 145 06/93 → 06/95

E 280 (124.029) Petrol 142 06/93 → 06/95

E 320 (124.032) Petrol 162 06/93 → 06/95

CLASSE E (W210)

E 200 (210.035) Petrol 100 06/95 → 08/00

E 200 Kompressor (210.045) Petrol 137 06/97 → 03/02

E 280 (210.053) Petrol 142 01/96 → 06/97

CLASSE E Cabriolet (A124)

E 320 (124.066) Petrol 162 06/93 → 03/98

E 36 AMG (124.066) Petrol 200 05/94 → 03/98

SAD033

MERCEDES-BENZ
CLASSE E Coupé (C124)

E 320 (124.052) Petrol 162 06/93 → 06/97

E 36 AMG (124.052) Petrol 200 05/94 → 06/97

CLASSE G (W463)

G 320 (463.230, 463.231) Petrol 155 09/94 → 12/97

G 36 AMG (463.230) Petrol 200 01/95 →

CLASSE G Cabrio (W463)

320 GE (463.208) Petrol 155 09/94 → 11/97

CLASSE M (W163)

ML 230 (163.136) Petrol 110 02/98 → 06/05

CLK (C208)

200 Kompressor (208.345) Petrol 141 06/97 → 06/00

230 Kompressor (208.347) Petrol 142 06/97 → 06/00

COUPE (C124)

220 CE (124.042) Petrol 110 10/92 → 05/93

320 CE (124.052) Petrol 162 10/92 → 05/93

SPRINTER 2-t Furgonato (901, 902)

214 Petrol 105 02/95 → 05/06

SPRINTER 3-t Autobus (903)

314 4x4 Petrol 105 08/02 → 05/06

SPRINTER 3-t Furgonato (903)

314 Petrol 105 02/95 → 05/06

VANEO (414)

1.6 (414.700) Petrol 60 02/02 → 07/05

1.6 (414.700) Petrol 75 02/02 → 07/05

1.9 (414.700) Petrol 92 02/02 → 07/05

OPEL
ASTRA H (L48)

1.8 Petrol 103 01/06 →

ASTRA H GTC (L08)

1.8 Petrol 103 01/06 →

ASTRA H TwinTop (L67)

1.8 Petrol 103 09/05 →

SIGNUM

1.8 Petrol 103 09/05 →

VECTRA C

1.8 Petrol 103 01/06 →

VECTRA C GTS

1.8 Petrol 103 01/06 →

SAD033

OPEL
VECTRA C Station wagon

1.8 Petrol 103 01/06 →

PEUGEOT
206 2 volumi /Coda spiovente (2A/C)

1.1 i Petrol 44 09/98 →

1.6 16V Petrol 80 12/00 →

206 CC (2D)

1.6 16V Petrol 80 09/00 →

2.0 S16 Petrol 100 09/00 →

206 SW (2E/K)

1.1 Petrol 44 07/02 →

1.4 Petrol 55 07/02 →

1.6 16V Petrol 80 07/02 →

2.0 16V Petrol 100 07/02 →

306 (7B, N3, N5)

1.4 SL Petrol 55 06/94 → 05/01

307 (3A/C)

1.4 Petrol 55 08/00 →

1.6 16V Petrol 80 08/00 →

2.0 16V Petrol 100 08/00 →

307 SW (3H)

1.6 16V Petrol 80 03/02 →

2.0 16V Petrol 100 03/02 →

407 (6D_)

2.2 Petrol 116 05/04 →

407 SW (6E_)

2.2 Petrol 116 05/04 →

607 (9D, 9U)

2.0 Petrol 100 02/00 →

2.2 16V Petrol 120 09/05 →

2.2 16V Petrol 116 02/00 →

806 (221)

2.0 16V Petrol 100 09/00 → 08/02

807 (E)

2.0 Petrol 100 06/02 →

2.2 Petrol 116 06/02 →

BOXER Autobus (244, Z_)

2.0 Petrol 81 04/02 →

BOXER Furgonato (244)

2.0 Petrol 81 04/02 →

EXPERT (224)

2.0 Petrol 100 07/00 →

EXPERT Furgonato (222)

2.0 Petrol 100 09/02 →

SAD033



SSANGYONG

KORANDO (KJ)

3.2 Petrol 156 01/99 →

KORANDO Cabrio (KJ)

3.2 Petrol 156 01/99 →

SAD035

**H3 SENSORE DETONAZIONE
KNOCK SENSOR**

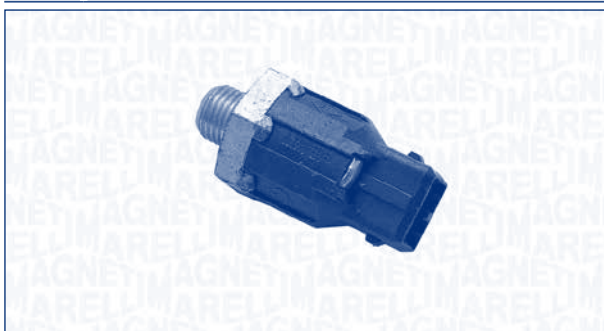

DACIA

DUSTER

1.5 dCi Diesel 63 04/10 →

1.5 dCi Diesel 79 06/10 →

1.5 dCi 4x4 Diesel 79 06/10 →

LOGAN (LS_)

1.4 (LSOA, LSOC, LSOE, LSOG) Petrol 55 09/04 →

1.5 dCi (LS0J, LS0Y) Diesel 48 09/05 →

1.5 dCi (LS0K) Diesel 50 01/06 →

1.5 dCi (LS0W) Diesel 63 09/07 →

1.6 (LSOB, LSOD, LSOE, LSOH) Petrol 64 09/04 →

1.6 16V (LS0M) Petrol 77 02/06 →

LOGAN MCV (KS_)

1.4 Petrol 55 02/07 →

1.5 dCi (KS0K) Diesel 50 02/07 →

1.5 dCi (KS0W) Diesel 63 09/07 →

1.6 Petrol 64 02/07 →

1.6 16V Petrol 77 02/07 →

SANDERO

1.4 Petrol 55 06/08 →

1.6 Petrol 64 06/08 →

SAD035



NISSAN

ALMERA II (N16)

1.5 dCi Diesel 60 01/03 →

ALMERA II Hatchback (N16)

1.5 dCi Diesel 60 01/03 →

KUBISTAR (X76)

1.2 Petrol 44 08/03 →

1.2 16V Petrol 55 04/06 →

1.5 dCi Diesel 42 08/03 →

1.5 dCi Diesel 45 08/05 →

1.5 dCi Diesel 48 08/03 →

1.5 dCi Diesel 60 08/03 →

1.5 dCi 70 Diesel 50 04/06 →

1.5 dCi 85 Diesel 62 04/06 →

1.6 16V Petrol 70 08/03 →

KUBISTAR Furgonato (X80)

1.2 Petrol 44 08/03 →

1.2 16V Petrol 55 04/06 →

1.5 dCi Diesel 48 08/03 →

1.5 dCi Diesel 60 08/03 →

1.6 16V Petrol 70 08/03 →

MICRA III (K12)

1.5 dCi Diesel 48 01/03 → 06/10

1.5 dCi Diesel 50 06/05 → 06/10

1.5 dCi Diesel 60 09/03 → 06/10

1.5 dCi Diesel 63 06/05 → 06/10

NOTE (E11)

1.5 dCi Diesel 50 03/06 →

1.5 dCi Diesel 63 03/06 →

PRIMASTAR Autobus (X83)

2.0 Petrol 88 03/01 →

PRIMASTAR Furgonato (X83)

2.0 Petrol 88 02/03 →

QASHQAI / QASHQAI +2 (J10, JJ10)

1.5 dCi Diesel 78 02/07 →

TIIDA 2 volumi /Coda spiovente (C11X)

1.5 dCi Diesel 78 09/07 →

TIIDA Tre volumi (SC11X)

1.5 dCi Diesel 78 09/07 →

OPEL

VIVARO Combi (J7)

2.0 16V Petrol 88 08/01 →

2.0 ECOTEC Petrol 86 08/06 →

VIVARO Furgonato (F7)

2.0 16V Petrol 88 08/01 →

2.0 ECOTEC Petrol 86 08/06 →

SAD035

KW

OPEL
VIVARO Pianale piatto/Telaio (E7)

2.0 16V	Petrol	88	08/06 →
2.0 ECOTEC	Petrol	86	08/06 →

RENAULT
19 I (B/C53_)

1.7 (B/C53C)	Petrol	66	09/88 → 04/92
1.8 16V (B/C53D)	Petrol	99	06/89 → 04/92

19 I Cabriolet (D53_)

1.7	Petrol	70	07/91 → 04/92
1.7 (L53C)	Petrol	66	07/88 → 04/92
1.8 16V (L53D)	Petrol	99	10/89 → 04/92

19 II (B/C53_)

1.4	Petrol	59	01/92 → 12/95
1.4 (B/C535)	Petrol	55	01/92 → 12/95
1.8 (5/353A)	Petrol	66	04/92 → 12/95
1.8 (5/353F, B/C538)	Petrol	79	05/94 → 12/95
1.8 (B/C538)	Petrol	81	04/92 → 05/94
1.8 (B/C53Y)	Petrol	65	04/92 → 12/95
1.8 16V (B/C53D)	Petrol	99	04/92 → 12/95

19 II Cabriolet (D53_, 853_)

1.7 (D53C)	Petrol	66	04/92 → 09/93
1.8 (D53V, 853F, D53C)	Petrol	79	07/94 → 06/96
1.8 (D53Y)	Petrol	65	04/92 → 06/96
1.8 16V (D53D)	Petrol	99	04/92 → 06/96

19 II Chamade (L53_)

1.4 (L535)	Petrol	55	11/93 → 12/95
1.7 (L53C)	Petrol	66	04/92 → 12/95
1.8	Petrol	67	05/92 → 09/94
1.8 (453A/F)	Petrol	66	04/92 → 12/95
1.8 (L538)	Petrol	81	04/92 → 05/94
1.8 (L53V, L538)	Petrol	79	05/94 → 12/95
1.8 (L53Y)	Petrol	65	04/92 → 12/95
1.8 16V (L53D)	Petrol	99	04/92 → 12/95

21 (B48_)

1.7 (B48E)	Petrol	66	09/89 → 06/94
2.0 (B48R/Y)	Petrol	99	02/90 → 10/92
2.2 (B48K)	Petrol	79	09/89 → 06/94

21 Station wagon (K48_)

1.7 (K48E)	Petrol	66	10/89 → 12/93
1.7 (K48E)	Petrol	69	06/86 → 12/89
2.0	Petrol	86	07/89 → 06/92
2.0 (K483)	Petrol	85	06/86 → 12/88
2.0 (K48C)	Petrol	88	03/86 → 12/93

SAD035

KW

RENAULT
21 Station wagon (K48_)

2.2 (K48K)	Petrol	79	06/86 → 11/93
------------	--------	----	---------------

21 Tre volumi (L48_)

1.7 (L48E)	Petrol	66	09/89 → 02/94
1.7 (L48E)	Petrol	69	03/86 → 02/94
2.0	Petrol	86	04/86 → 06/89
2.0 (L483)	Petrol	85	03/86 → 12/88
2.0 (L48C)	Petrol	88	03/86 → 12/93
2.0 Turbo (L485)	Petrol	129	04/87 → 03/90
2.0 Turbo 4x4	Petrol	129	08/89 → 10/93
2.2 (L48K)	Petrol	79	07/86 → 02/94

25 (B29_)

2.0 12V	Petrol	103	06/88 → 12/93
2.0 12V (B294)	Petrol	99	06/89 → 12/92
2.2 (B29B)	Petrol	79	09/86 → 12/92
2.2 (B29E)	Petrol	89	04/84 → 12/89
2.8 V6 Injection (B29F)	Petrol	110	06/87 → 12/92

AVANTIME (DE0_)

2.0 16V Turbo (DE0U, DE0V)	Petrol	120	11/01 → 05/03
----------------------------	--------	-----	---------------

CLIO Grandtour (KR0/1_)

1.2 16V Hi-Flex (KR0S)	BiFuel	55	07/08 →
1.2 16V (KR02, KR0J)	Petrol	55	02/08 →
1.2 16V (KR0E)	Petrol	58	02/08 →
1.2 16V (KR0P)	Petrol	74	02/08 →
1.5 dCi (KR0F)	Diesel	63	02/08 →
1.5 dCi (KR0G)	Diesel	50	02/08 →
1.5 dCi (KR0H)	Diesel	78	02/08 →
1.5 dCi (KR1C, KR1N)	Diesel	76	02/08 →
1.6 16V (KR0B)	Petrol	82	02/08 →
1.6 16V (KR10)	Petrol	94	11/08 →

CLIO I (B/C57_, 5/357_)

1.2 (5/357Y, 5/357K)	Petrol	40	01/96 → 09/98
1.2 (B/C/S57A, B/C57S, 5/357F, 5/357J, 5/357L, 5/357R)	Petrol	43	05/90 → 09/98
1.2 (B/C57R)	Petrol	40	01/91 → 06/96
1.4	Petrol	59	01/91 → 09/98
1.8 (B/C578)	Petrol	66	08/94 → 09/98

SAD035



RENAULT

CLIO I (B/C57_, 5/357_)

1.8 (B/C57C, B/C57U)	Petrol	65	01/91 → 09/98
1.8 16V (C57D)	Petrol	99	01/91 → 03/96
1.8 Rsi (B/C579)	Petrol	80	01/93 → 08/95
1.8 Rsi (B/C57H)	Petrol	79	08/95 → 09/98
Williams (B/C57M)	Petrol	108	01/94 → 09/98

CLIO II (BB0/1/2_, CB0/1/2_)

1.2 (BB0A, BB0F, BB10, BB1K, BB28, BB2D, BB2H, CB0A...)	Petrol	43	09/98 →
1.2 (BB0A, CB0A)	Petrol	44	03/99 → 05/01
1.2 16V (BB05, BB0W, BB11, BB27, BB2T, BB2U, BB2V, CB05...)	Petrol	55	06/01 →
1.4 (B/CB0C)	Petrol	55	09/98 → 05/05
1.4 16V (B/CB0L)	Petrol	70	10/99 → 09/04
1.4 16V (B/CB0P)	Petrol	72	08/00 →
1.5 dCi (B/CB03)	Diesel	59	06/01 → 10/03
1.5 dCi (B/CB07)	Diesel	48	06/01 →
1.5 dCi (B/CB08)	Diesel	60	06/01 →
1.6 (B/CB0D)	Petrol	66	09/98 → 05/05
1.6 16V (BB01, BB0H, BB0T, BB14, BB1D, BB1R, BB2KL...)	Petrol	79	09/98 →
2.0 16V Sport (CB0M)	Petrol	124	02/00 →

CLIO II Furgonato (SB0/1/2_)

1.1 (SB0A, SB0F, SB1K, SB2D)	Petrol	43	09/98 →
1.2 (SB0A, SB0F, SB10)	Petrol	44	03/99 → 10/03
1.5 dCi	Diesel	59	06/01 → 10/04
1.5 dCi	Diesel	60	11/03 →
1.5 dCi (SB07)	Diesel	48	06/01 →

SAD035



RENAULT

CLIO III (BR0/1, CR0/1)

1.2 16V	Petrol	58	06/05 →
1.2 16V Hi-Flex (BR1U, CR1U)	BiFuel	55	07/08 →
1.2 16V (BR02, BR0J, BR11, CR02, CR0J, CR11)	Petrol	55	06/05 →
1.2 16V (BR0P, CR0P)	Petrol	74	05/07 →
1.2 16V (BR0R, BR1D, BR1L, CR0R)	Petrol	48	06/05 →
1.5 dCi	Diesel	48	05/05 →
1.5 dCi (BR0H, CR0H)	Diesel	78	06/05 →
1.5 dCi (BR17, CR17)	Diesel	63	06/05 →
1.5 dCi (C/BR1G)	Diesel	50	06/05 →
1.6 16V (BR05, BR0B, BR0Y, BR15, BR1J, BR1M, BR1Y, CR0B...)	Petrol	82	06/05 →
1.6 16V (BR09, BR0T, CR09, CR0T)	Petrol	65	06/05 →
1.6 16V GT (BR10, CR10)	Petrol	94	06/09 →
2.0 16V Sport	Petrol	145	02/06 →
2.0 16V Sport	Petrol	148	09/08 →

ESPACE I (J11_)

2.2 (J117)	Petrol	79	07/86 → 12/90
2.2 Quadra (J117)	Petrol	79	01/88 → 12/90

ESPACE II (J/S63_)

2.0 (J636)	Petrol	76	01/91 → 10/96
2.2 (J/S637, J63G)	Petrol	79	01/91 → 10/96
2.8 V6 (J638, J63J)	Petrol	110	01/91 → 10/96

ESPACE III (JE0_)

2.0	Petrol	102	09/01 → 10/02
2.0 16V (JE0N, JE0L, JE02)	Petrol	103	10/98 → 10/02

SAD035

RENAULT
ESPACE IV (JK0/1_)

2.0 (JK09)	Petrol	100	11/02 →	
2.0 (JK0K)	Petrol	98	11/02 → 02/05	
2.0 (JK0N, JK1D)	Petrol	125	04/05 →	
2.0 Turbo (JK0B, JK0N)	Petrol	120	11/02 →	

FLUENCE (L30_)

1.5 dCi (L30S)	Diesel	66	02/10 →	
----------------	--------	----	---------	--

GRAND SCÉNIC II (JM0/1_)

1.5 dCi (JM02, JM13)	Diesel	74	04/04 →	
1.6	Petrol	83	04/04 →	
2.0	Petrol	120	04/04 →	
2.0	Petrol	99	04/04 →	
1.5 dCi	Diesel	78	02/09 →	

KANGOO (KC0/1_)

1.2 (KC0A, KC0K, KC0F, KC01)	Petrol	43	08/97 →	
1.2 16V (KC03, KC05, KC06, KC0T, KC0W)	Petrol	55	06/01 →	
1.4 (KC0C, KC0H, KC0B, KC0M)	Petrol	55	08/97 →	
1.5 dCi	Diesel	42	07/03 →	
1.5 dCi (KC07)	Diesel	48	12/01 →	
1.5 dCi (KC08, KC09)	Diesel	60	07/02 →	
1.6 16V	Petrol	70	06/01 →	
1.6 16V 4x4 (KC0P, KC0S, KC0L)	Petrol	70	10/01 →	

KANGOO / GRAND KANGOO (KW0/1_)

1.5 dCi (KW0B)	Diesel	63	02/08 →	
1.5 dCi (KW0C, KW0F)	Diesel	76	02/08 →	
1.6 (KW00, KW0Y)	Petrol	64	02/08 →	

KANGOO BE BOP (KW0/1_)

1.5 dCi (KW0F)	Diesel	76	02/09 →	
1.6 (KW0D)	Petrol	78	02/09 →	

KANGOO Express (FC0/1_)

1.2 (FC01, FC0A, FC0F)	Petrol	43	08/97 →	
------------------------	--------	----	---------	--

SAD035

RENAULT
KANGOO Express (FC0/1_)

1.2 16V (FC05)	Petrol	55	10/01 →	
1.4 (FC0C, FC0B, FC0H, FC0M)	Petrol	55	08/97 →	
1.5 dCi (FC07, FC1R)	Diesel	48	12/01 →	
1.5 dCi (FC08, FC09)	Diesel	60	04/03 →	
1.5 dCi (FC1R)	Diesel	42	12/02 →	
1.6 16V	Petrol	70	10/01 →	
1.6 16V 4x4 (FC0L, FC0P, FC0S)	Petrol	70	10/01 →	

KANGOO Express (FW0/1_)

1.5 dCi (FW0F)	Diesel	76	02/08 →	
1.5 dCi 85 (FW0A, FW0B)	Diesel	63	02/08 →	
1.6	Petrol	64	02/08 →	

LAGUNA Coupé (DT0/1)

2.0 16V Turbo	Petrol	125	09/08 →	
---------------	--------	-----	---------	--

LAGUNA I (B56_, 556_)

1.6 16V (B568, B561)	Petrol	79	11/97 → 03/01	
1.8	Petrol	69	06/95 → 02/01	
1.8	Petrol	70	06/95 → 06/98	
1.8 (B56A/B)	Petrol	66	11/93 → 03/01	
1.8 (B56S/T/O)	Petrol	66	08/95 → 03/01	
1.8 (B56Z)	Petrol	69	08/95 → 03/01	
1.8 16V (B563, B564)	Petrol	88	04/98 → 03/01	
2.0	Petrol	80	03/99 → 03/01	
2.0	Petrol	84	06/95 → 02/01	
2.0 (556A)	Petrol	102	09/99 → 02/01	
2.0 (B56C/H/N)	Petrol	83	11/93 → 03/01	
2.0 16V (556A/B)	Petrol	103	09/99 → 03/01	

LAGUNA I Grandtour (K56_)

1.6 16V (K568)	Petrol	79	11/97 → 03/01	
1.8 (K56S/T/O)	Petrol	66	09/95 → 03/01	
1.8 (K56Z)	Petrol	69	09/95 → 03/01	
1.8 16V (K563, K564)	Petrol	88	04/98 → 03/01	
2.0	Petrol	84	10/98 → 01/01	
2.0 (K56C/H)	Petrol	83	09/95 → 03/01	
2.0 16V (A56A/B)	Petrol	103	09/99 → 03/01	

SAD035



RENAULT

LAGUNA II (BG0/1_)

1.6 16V (BG0A, BG0L)	Petrol	79	03/01 →	
1.6 16V (BG1G, BG1H)	Petrol	82	02/05 →	
1.8 16V (BG06, BG0J, BG0M)	Petrol	85	03/01 →	
1.8 16V (BG0B, BG0C, BG0J, BG0M, BG0V)	Petrol	89	03/01 →	
1.8 16V (BG0B, BG0M)	Petrol	88	03/01 →	
2.0 16V	Petrol	125	01/05 →	
2.0 16V	Petrol	150	01/05 →	
2.0 16V (BG00, BG0K, BG0P, BG0W)	Petrol	99	08/02 →	
2.0 16V IDE (BG0N)	Petrol	103	04/01 →	
2.0 16V Turbo (BG0S, BG0Z, BG1L, BG1M)	Petrol	120	01/03 →	

LAGUNA II Grandtour (KG0/1_)

1.6 16V	Petrol	82	02/05 →	
1.6 16V (KG0A, KG0L)	Petrol	79	03/01 →	
1.8 16V	Petrol	89	03/01 →	
1.8 16V (KG0B, KG0M)	Petrol	88	03/01 →	
1.8 16V (KG0J)	Petrol	85	03/01 →	
2.0 16V	Petrol	125	01/05 →	
2.0 16V	Petrol	150	01/05 →	
2.0 16V (KG00, KG0K, KG0W)	Petrol	99	08/02 →	
2.0 16V IDE (KG0N)	Petrol	103	04/01 →	
2.0 16V Turbo (KG0S, KG0Z, KG1L, KG1M)	Petrol	120	01/03 →	

LAGUNA III (BT0/1)

1.5 dCi (BT00, BT0A, BT0T, BT1J)	Diesel	81	10/07 →	
1.6 16V (BT04, BT0D, BT0U)	Petrol	81	10/07 →	

SAD035



RENAULT

LAGUNA III (BT0/1)

2.0 16V Turbo	Petrol	125	10/07 →	
2.0 GT	Petrol	150	03/08 →	

LAGUNA III Sportour (KT0/1)

1.5 dCi (KT0A)	Diesel	81	10/07 →	
1.6 16V (KT0D)	Petrol	81	10/07 →	
2.0 16V Turbo	Petrol	125	10/07 →	
2.0 GT	Petrol	150	03/08 →	

LOGAN (LS_)

1.4	Petrol	55	09/04 →	
1.5 dCi	Diesel	50	04/07 →	
1.6	Petrol	64	09/04 →	
1.6	Petrol	77	04/07 →	

LOGAN Station wagon (KS_)

1.4	Petrol	55	10/07 →	
1.5 dCi	Diesel	50	04/07 →	
1.6	Petrol	64	04/07 →	
1.6	Petrol	77	04/07 →	

MASTER I Autobus (T_)

30 2,2	Petrol	67	08/80 → 07/98	
--------	--------	----	---------------	--

MEGANE I (BA0/1_)

1.4 16V (BA0D, BA1H, BA0W, BA10)	Petrol	70	03/99 → 08/03	
1.4 e (BA0E, BA0V)	Petrol	55	01/96 → 08/03	
1.6 16V (BA11, BA04, BA0B, BA1J)	Petrol	79	03/99 → 08/03	
1.6 e (BA0F, BA0S)	Petrol	66	01/96 → 03/99	
1.6 i (BA0L)	Petrol	55	01/96 → 03/99	
1.8 16V (BA06, BA12, BA1A, BA1M, BA1R)	Petrol	85	01/01 → 08/03	
2.0 i	Petrol	80	03/99 → 08/03	
2.0 i (BA0G)	Petrol	84	01/96 → 08/03	

MEGANE I Cabriolet (EA0/1_)

1.4 16V (EA0D, EA1H, EA0W, EA10)	Petrol	70	03/99 → 08/03	
1.6 16V (EA0B, EA04, EA11)	Petrol	79	03/99 → 08/03	
2.0 (EA0G)	Petrol	84	04/97 → 08/03	
2.0 16V	Petrol	102	01/02 → 08/03	

SAD035

RENAULT
MEGANE I Cabriolet (EA0/1_)

2.0 16V IDE (EA03, EA0P, EA14)	Petrol	103	11/99 → 08/03
--------------------------------------	--------	-----	---------------

2.0 i (EA0G)	Petrol	80	03/99 → 08/03
--------------	--------	----	---------------

MEGANE I Classic (LA0/1_)

1.4 16V (LA0D, LA1H, IA0W, LA10)	Petrol	70	03/99 → 08/03
--	--------	----	---------------

1.6 16V (La04, LA11, LA0B, LA1C, LA1J)	Petrol	79	03/99 → 08/03
--	--------	----	---------------

1.8 16V (LA06, LA12, LA1A, LA1M, LA1R)	Petrol	85	01/01 → 08/03
--	--------	----	---------------

2.0 i (LA0G)	Petrol	80	03/99 → 08/03
--------------	--------	----	---------------

MEGANE I Coach (DA0/1_)

1.4 16V (DA0D, DA1H, DA0W, DA10)	Petrol	70	03/99 → 08/03
--	--------	----	---------------

1.6 16V (DA0B, DA04, DA11)	Petrol	79	03/99 → 08/03
-------------------------------	--------	----	---------------

1.6 e (DA0F)	Petrol	66	03/96 → 03/99
--------------	--------	----	---------------

2.0 16V IDE (DA03, DA0P, DA14)	Petrol	103	11/99 → 08/03
--------------------------------------	--------	-----	---------------

2.0 i (DA0G)	Petrol	84	03/96 → 08/03
--------------	--------	----	---------------

MEGANE I Grandtour (KA0/1_)

1.4 16V (KA0D, KA1H, KA0W, KA10)	Petrol	70	03/99 → 08/03
--	--------	----	---------------

1.4 e (KA0V)	Petrol	55	03/99 → 08/03
--------------	--------	----	---------------

1.6 16V (KA0B, KA04, KA11)	Petrol	79	03/99 → 08/03
-------------------------------	--------	----	---------------

1.6 e (KA0F)	Petrol	66	03/99 → 08/03
--------------	--------	----	---------------

1.8 16V (KA0S, KA12, KA1A, KA1M, KA1R)	Petrol	85	01/01 → 08/03
--	--------	----	---------------

MEGANE II (BM0/1_, CM0/1_)

1.4 16V	Petrol	60	10/03 →
---------	--------	----	---------

1.4 16V (BM0B, CM0B)	Petrol	72	11/02 →
-------------------------	--------	----	---------

1.5 dCi	Diesel	63	05/05 →
---------	--------	----	---------

1.5 dCi	Diesel	74	10/03 →
---------	--------	----	---------

1.5 dCi	Diesel	76	01/07 →
---------	--------	----	---------

SAD035

RENAULT
MEGANE II (BM0/1_, CM0/1_)

1.5 dCi	Diesel	78	05/05 →
---------	--------	----	---------

1.5 dCi (BM0F, CM0F)	Diesel	60	11/02 →
-------------------------	--------	----	---------

1.6	Petrol	77	06/05 →
-----	--------	----	---------

1.6 16V	Petrol	82	01/06 →
---------	--------	----	---------

1.6 16V (BM0C, CM0C)	Petrol	83	11/02 →
-------------------------	--------	----	---------

2.0 16V (BM0U, CM0U)	Petrol	99	11/02 →
-------------------------	--------	----	---------

2.0 16V Turbo	Petrol	120	05/04 →
---------------	--------	-----	---------

2.0 Renault Sport	Petrol	165	05/04 →
-------------------	--------	-----	---------

MEGANE II Coupé-Cabriolet (EM0/1_)

1.5 dCi (EM16)	Diesel	76	01/07 →
----------------	--------	----	---------

1.5 dCi (EM1E)	Diesel	78	03/06 →
----------------	--------	----	---------

1.6	Petrol	83	09/03 →
-----	--------	----	---------

1.6 16V	Petrol	82	01/06 →
---------	--------	----	---------

2.0	Petrol	99	09/03 →
-----	--------	----	---------

2.0 16V Turbo	Petrol	120	05/04 →
---------------	--------	-----	---------

MEGANE II Station wagon (KM0/1_)

1.4	Petrol	72	08/03 →
-----	--------	----	---------

1.5 dCi	Diesel	60	08/03 →
---------	--------	----	---------

1.5 dCi	Diesel	63	05/05 →
---------	--------	----	---------

1.5 dCi	Diesel	74	02/04 →
---------	--------	----	---------

1.5 dCi (KM13)	Diesel	76	01/07 →
----------------	--------	----	---------

1.5 dCi (KM16, KM1E)	Diesel	78	05/05 →
-------------------------	--------	----	---------

1.6	Petrol	83	08/03 →
-----	--------	----	---------

1.6 16V	Petrol	82	01/06 →
---------	--------	----	---------

2.0	Petrol	99	08/03 →
-----	--------	----	---------

MEGANE II Tre volumi (LM0/1_)

1.4	Petrol	60	09/03 →
-----	--------	----	---------

1.4	Petrol	72	09/03 →
-----	--------	----	---------

1.5 dCi	Diesel	60	09/03 →
---------	--------	----	---------

1.5 dCi	Diesel	63	05/05 →
---------	--------	----	---------

1.5 dCi	Diesel	78	05/05 →
---------	--------	----	---------

1.5 dCi	Diesel	74	02/04 →
---------	--------	----	---------

1.5 dCi	Diesel	76	01/07 →
---------	--------	----	---------

1.6	Petrol	77	05/05 →
-----	--------	----	---------

1.6	Petrol	83	09/03 →
-----	--------	----	---------

1.6 16V	Petrol	82	01/06 →
---------	--------	----	---------

2.0	Petrol	99	09/03 →
-----	--------	----	---------

MEGANE III 2 volumi /Coda spiovente (BZ0_)

1.6 16V (BZ1B, BZ1H)	Petrol	81	11/08 →
-------------------------	--------	----	---------

SAD035



KW



RENAULT

MEGANE III Coupé (DZ0/1_)

1.6 16V (DZ0U, DZ1B, DZ1H) Petrol 81 11/08 →

MEGANE III Grandtour (KZ0/1)

1.5 dCi (KZ09, KZ0D, KZ1G, KZ1M, KZ1W) Diesel 81 02/09 →

1.5 dCi (KZ0C, KZ1A) Diesel 66 05/09 →

1.6 16V (KZ0U, KZ1B, KZ1U) Petrol 81 05/09 →

MEGANE Scenic (JA0/1_)

1.6 16V (JA0B, JA04, JA11) Petrol 79 04/98 → 10/99

2.0 i (JA0G) Petrol 80 01/99 → 09/99

MODUS / GRAND MODUS (F/JPO_)

1.2 (FP0C, FP0K, FP0P) Petrol 48 05/05 →

1.2 (JP0C, JP0K, FP0C, FP0K, FP0P, JP0P, JP0T) Petrol 55 12/04 →

1.2 (JP0S) Petrol 58 12/04 →

1.2 16V (JP0W) Petrol 74 05/07 →

1.4 (JP01, JP0J) Petrol 72 12/04 →

1.5 dCi (FP0E, JP0E) Diesel 48 12/04 →

1.5 dCi (FP0F, JP0F) Diesel 63 12/04 →

1.5 dCi (FP0G, JP0G) Diesel 50 12/04 →

1.5 dCi (JP0G, JP0H) Diesel 78 05/05 →

1.6 (JP03, JP0B, JP0U, JP0Y, JP1G) Petrol 82 12/04 →

1.6 (JP0L, JP0V) Petrol 65 12/04 →

RAPID Furgonato (F40_, G40_)

1.4 (F40D) Petrol 58 01/94 → 03/98

1.4 (F40U, F40V) Petrol 55 09/91 → 03/98

SAFRANE I (B54_)

2.0 12V (B542, B54E) Petrol 97 04/92 → 07/96

2.2 (B541) Petrol 79 04/92 → 07/96

2.2 (B543) Petrol 101 04/92 → 07/96

SAD035



KW



RENAULT

SCÉNIC I (JA0/1_)

1.4 16V (JA0D, JA1H, Ja0W, JA10) Petrol 70 09/99 → 08/03

1.8 16V (JA12, JA1R, JA1M, JA1A) Petrol 85 01/01 → 08/03

1.8 4x4 Petrol 85 07/00 → 04/01

2.0 16V Petrol 103 09/99 → 08/03

2.0 16V (JA1B, JA1D) Petrol 102 07/00 → 08/03

2.0 16V RX4 Petrol 102 06/00 → 08/03

SCÉNIC II (JM0/1_)

1.4 (JM0B, JM0H, JM1A) Petrol 72 06/03 →

1.5 dCi (JM02, JM13) Diesel 74 11/03 →

1.5 dCi (JM0F) Diesel 60 06/03 →

1.5 dCi (JM16) Diesel 76 01/07 →

1.5 dCi (JM1E) Diesel 78 05/05 →

1.5 dCi (JM1F) Diesel 63 05/05 →

1.6 (JM0C, JM0J, JM1B) Petrol 83 06/03 →

1.6 16V (JM1R) Petrol 82 01/07 →

2.0 (JM05, JM0U, JM1N, JM1U, JM2V) Petrol 99 06/03 →

2.0 16V Turbo (JM0W) Petrol 120 05/04 →

SCÉNIC III (JZ0/1_)

1.5 dCi Diesel 78 02/09 →

SUPER 5 (B/C40_)

1.7 i (C409) Petrol 69 10/86 → 08/91

THALIA I (LB0/1/2_)

1.4 Petrol 55 08/00 →

1.5 dCi Diesel 48 04/02 →

TRAFIC Autobus (TXW)

2.2 Petrol 74 06/94 → 10/97

TRAFIC Furgonato (TXX)

2.2 4x4 Petrol 74 06/94 → 10/97

TRAFIC II Autobus (JL)

2.0 (JL0A) Petrol 88 03/01 →

2.0 16V Petrol 86 08/06 →

SAD035

RENAULT
TRAFIC II Furgonato (FL)

2.0 (FL0A)	Petrol	88	03/01 →
2.0 16V	Petrol	86	08/06 →

TRAFIC II Pianale piatto/Telaio (EL)

2.0 (EL0A)	Petrol	88	03/01 →
------------	--------	----	---------

TRAFIC Pianale piatto/Telaio (PXX)

2.2	Petrol	74	09/94 → 04/98
2.2 4x4	Petrol	74	09/94 → 04/98

TWINGO I (C06_)

1.2 16V (C060)	Petrol	44	08/04 →
----------------	--------	----	---------

1.2 16V (C06C, C06D, C06K)	Petrol	55	01/01 →
----------------------------	--------	----	---------

TWINGO II (CN0_)

1.2 (CN0D)	Petrol	43	03/07 →
------------	--------	----	---------

1.2 16V (CN0K, CN0V)	Petrol	56	03/07 →
----------------------	--------	----	---------

1.2 Turbo (CN0C, CN0F)	Petrol	74	03/07 →
------------------------	--------	----	---------

1.5 dCi (CN0E)	Diesel	47	03/07 →
----------------	--------	----	---------

1.5 dCi (CN0U)	Diesel	62	04/08 →
----------------	--------	----	---------

1.6 RS (CN0N, CN0R, CN0S)	Petrol	98	05/08 →
---------------------------	--------	----	---------

VEL SATIS (BJ0_)

2.0 16 V Turbo	Petrol	125	04/04 →
----------------	--------	-----	---------

2.0 16V Turbo (BJ0K)	Petrol	120	06/02 →
----------------------	--------	-----	---------

SUZUKI
JIMNY (FJ)

1.5 DDiS 4x4	Diesel	63	08/05 →
--------------	--------	----	---------

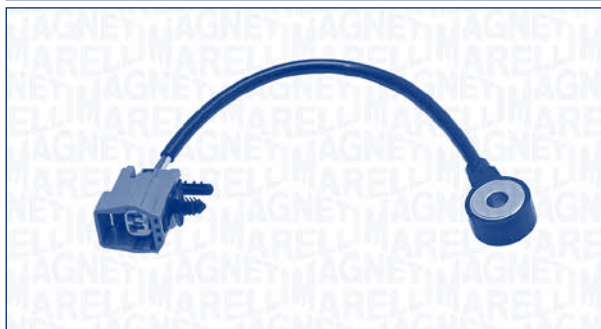
SAD036
**H3 SENSORE DETONAZIONE
KNOCK SENSOR**

FORD
C-MAX (DM2)

1.8	Petrol	92	02/07 →
-----	--------	----	---------

1.8 Flexifuel	Petrol/ Ethanol	92	02/07 →
---------------	--------------------	----	---------

2.0	Petrol	107	02/07 →
-----	--------	-----	---------

FIESTA V (JH_, JD_)

ST150	Petrol	110	03/05 → 06/08
-------	--------	-----	---------------

FOCUS (DAW, DBW)

ST170	Petrol	127	03/02 → 11/04
-------	--------	-----	---------------

FOCUS C-MAX

1.8	Petrol	88	10/03 → 03/07
-----	--------	----	---------------

1.8	Petrol	92	04/04 → 03/07
-----	--------	----	---------------

1.8 Flexifuel	Petrol/ Ethanol	92	01/06 → 03/07
---------------	--------------------	----	---------------

2.0	Petrol	107	03/04 → 03/07
-----	--------	-----	---------------

FOCUS II (DA_)

1.8 Flexifuel	Petrol/ Ethanol	92	01/06 →
---------------	--------------------	----	---------

2.0	Petrol	107	11/04 →
-----	--------	-----	---------

FOCUS II Cabriolet

2.0	Petrol	107	10/06 →
-----	--------	-----	---------

FOCUS II Station wagon (DA_)

1.8 Flexifuel	Petrol/ Ethanol	92	01/06 →
---------------	--------------------	----	---------

2.0	Petrol	107	11/04 →
-----	--------	-----	---------

FOCUS II Tre volumi (DA_)

1.8 Flexifuel	Petrol/ Ethanol	92	06/06 →
---------------	--------------------	----	---------

2.0	Petrol	107	04/05 →
-----	--------	-----	---------

FOCUS Station wagon (DNW)

ST170	Petrol	127	08/02 → 11/04
-------	--------	-----	---------------

GALAXY (WA6)

2.0	Petrol	107	05/06 →
-----	--------	-----	---------

2.3	Petrol	118	07/07 →
-----	--------	-----	---------

SAD036



KW



FORD

MONDEO III (B5Y)

1.8 16V	Petrol	81	11/00 → 08/07
1.8 16V	Petrol	92	11/00 → 08/07
2.0 16V	Petrol	107	11/00 → 08/07

MONDEO III Station wagon (BWY)

1.8 16V	Petrol	81	11/00 → 08/07
1.8 16V	Petrol	92	11/00 → 08/07
2.0 16V	Petrol	107	11/00 → 08/07

MONDEO III Tre volumi (B4Y)

1.8 16V	Petrol	81	11/00 → 08/07
1.8 16V	Petrol	92	11/00 → 08/07
2.0 16V	Petrol	107	11/00 → 08/07

MONDEO IV (BA7)

2.0	Petrol	107	03/07 →
2.0 Flexifuel	Petrol/ Ethanol	107	03/09 →
2.3	Petrol	118	07/07 →

MONDEO IV Tre volumi (BA7)

2.0	Petrol	107	03/07 →
2.0 Flexifuel	Petrol/ Ethanol	107	03/09 →
2.3	Petrol	118	07/07 →

MONDEO IV Turnier (BA7)

2.0	Petrol	107	03/07 →
2.0 Flexifuel	Petrol/ Ethanol	107	03/09 →
2.3	Petrol	118	07/07 →

S-MAX (WA6)

2.0	Petrol	107	05/06 →
2.0 Flexifuel	Petrol/ Ethanol	107	05/06 →
2.3	Petrol	118	07/07 →

TRANSIT Autobus (FD __, FB __, FS __, FZ __, FC __)

2.4 TDCi	Diesel	101	03/04 → 05/06
----------	--------	-----	---------------

TRANSIT Furgonato

2.3 16V	Petrol	107	04/06 →
---------	--------	-----	---------

TRANSIT Furgonato (FA __)

2.4 TDCi	Diesel	101	03/04 → 05/06
----------	--------	-----	---------------

TRANSIT Pianale piatto/Telaio

2.3 16V	Petrol	107	04/06 →
---------	--------	-----	---------

TRANSIT Pianale piatto/Telaio (FM __, FN __)

2.4 TDCi	Diesel	101	03/04 → 05/06
----------	--------	-----	---------------

SAD036



KW



MAZDA

3 (BK)

2.0	Petrol	110	10/03 → 06/09
2.0 MZR-CD	Diesel	105	12/06 → 06/09

3 Tre volumi (BK)

2.0	Petrol	110	02/04 →
2.0 MZR-CD	Diesel	105	12/06 →

5 (CR19)

1.8	Petrol	85	03/05 →
2.0	Petrol	107	03/05 →

6 (GG)

1.8	Petrol	88	08/02 → 08/07
2.0	Petrol	104	06/02 → 08/07
2.0	Petrol	108	03/05 → 08/07
2.3	Petrol	122	06/02 → 08/07
2.3 MPS Turbo	Petrol	191	12/05 → 08/07

6 (GH)

1.8 MZR	Petrol	88	08/07 →
2.0 MZR	Petrol	108	08/07 →
2.5 MZR	Petrol	125	08/07 →

6 2 volumi /Coda spiovente (GH)

1.8 MZR	Petrol	88	08/07 →
2.0 MZR	Petrol	108	08/07 →
2.5 MZR	Petrol	125	08/07 →

6 Hatchback (GG)

1.8	Petrol	88	08/02 → 08/07
2.0	Petrol	104	08/02 → 08/07
2.3	Petrol	122	08/02 → 08/07

6 Station wagon (GH)

2.0 MZR	Petrol	108	02/08 →
2.0	Petrol	104	08/02 → 08/07
2.3	Petrol	122	08/02 → 08/07
2.3 AWD	Petrol	119	11/02 → 08/07

MPV II (LW)

2.3	Petrol	104	07/02 → 02/06
-----	--------	-----	---------------

MX-5 III (NC)

1.8	Petrol	93	03/05 →
2.0	Petrol	118	03/05 →

VOLVO

C30

1.8	Petrol	92	10/06 → 12/12
1.8 FlexFuel	BiFuel	92	01/07 → 12/12
2.0	Petrol	107	10/06 → 12/12

SAD036

VOLVO
S40 II (MS)

1.8	Petrol	92	04/04 →
1.8 FlexFuel	BiFuel	92	01/06 →
2.0	Petrol	107	10/06 →

S80 II (AS)

2.0 FlexFuel	BiFuel	107	01/08 →
--------------	--------	-----	---------

V50 (MW)

1.8	Petrol	92	04/04 →
1.8 FlexFuel	BiFuel	92	01/05 →
2.0	Petrol	107	10/06 →

V70 III (BW)

2.0	Petrol	107	10/07 →
2.0 Flexifuel	BiFuel	107	01/08 →

SAD037
H3 **SENSORE DETONAZIONE
KNOCK SENSOR**

FORD
C-MAX (DM2)

1.6	Petrol	74	02/07 →
-----	--------	----	---------

FIESTA V (JH_, JD_)

1.25 16V	Petrol	51	03/03 → 06/08
1.25 16V	Petrol	55	05/02 → 06/08
1.4 16V	Petrol	59	11/01 → 06/08
1.6 16V	Petrol	74	11/01 → 06/08

FIESTA VI

1.25	Petrol	44	06/08 →
1.25	Petrol	60	06/08 →
1.4	Petrol	71	06/08 →
1.6 Ti	Petrol	88	06/08 →

FOCUS (DAW, DBW)

1.4 16V	Petrol	55	10/98 → 11/04
1.6 16V	Petrol	74	10/98 → 11/04

SAD037

FORD
FOCUS C-MAX

1.6	Petrol	74	10/03 → 03/07
1.6 Ti	Petrol	85	08/04 → 03/07

FOCUS II (DA_)

1.4	Petrol	59	11/04 →
1.6	Petrol	74	11/04 →
1.6 Ti	Petrol	85	11/04 →

FOCUS II Cabriolet

1.6	Petrol	74	10/06 →
-----	--------	----	---------

FOCUS II Station wagon (DA_)

1.4	Petrol	59	11/04 →
1.6	Petrol	74	11/04 →
1.6 Ti	Petrol	85	11/04 →

FOCUS II Tre volumi (DA_)

1.4	Petrol	59	04/05 →
1.6	Petrol	74	04/05 →
1.6 Ti	Petrol	85	04/05 →

FOCUS Station wagon (DNW)

1.4 16V	Petrol	55	02/99 → 11/04
1.6 16V	Petrol	74	02/99 → 11/04

FOCUS Tre volumi (DFW)

1.4 16V	Petrol	55	02/99 → 11/04
1.6 16V	Petrol	74	02/99 → 11/04

FUSION (JU_)

1.25	Petrol	55	08/04 →
1.4	Petrol	59	08/02 →
1.6	Petrol	74	08/02 →

MONDEO IV (BA7)

1.6 Ti	Petrol	81	03/07 →
1.6 Ti	Petrol	92	03/07 →

MONDEO IV Turnier (BA7)

1.6 Ti	Petrol	81	03/07 →
1.6 Ti	Petrol	92	03/07 →

JAGUAR
S-TYPE (CCX)

2.5 V6	Petrol	147	04/02 → 10/07
3.0 V6	Petrol	175	01/99 → 10/07
4.0 V8	Petrol	203	01/99 → 04/02

XF (_J05_, CC9)

3.0	Petrol	175	03/08 →
-----	--------	-----	---------

XJ (X350, X358)

3.0	Petrol	175	05/03 → 03/09
-----	--------	-----	---------------

SAD037



MAZDA

2 (DY)

1.25	Petrol	55	04/03 →
1.4	Petrol	59	04/03 →
1.6	Petrol	74	04/03 →

VOLVO

C30

1.6	Petrol	74	10/06 → 12/12
-----	--------	----	---------------

S40 II (MS)

1.6	Petrol	74	01/05 →
-----	--------	----	---------

V50 (MW)

1.6	Petrol	74	01/05 →
-----	--------	----	---------

SAD038

H3 **SENSORE DETONAZIONE**
KNOCK SENSOR



FORD

FOCUS (DAW, DBW)

1.8 16V	Petrol	85	10/98 → 11/04
---------	--------	----	---------------

FOCUS Station wagon (DNW)

1.8 16V	Petrol	85	02/99 → 11/04
---------	--------	----	---------------

FOCUS Tre volumi (DFW)

1.8 16V	Petrol	85	02/99 → 11/04
---------	--------	----	---------------

SAD039

H3 **SENSORE DETONAZIONE**
KNOCK SENSOR

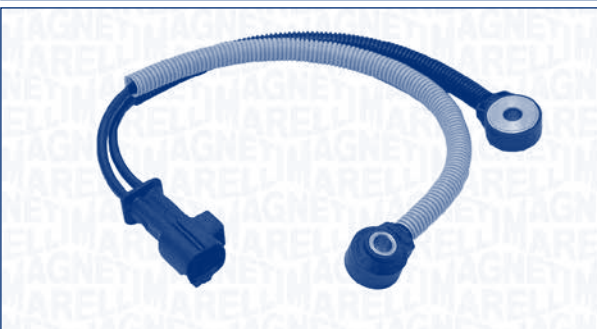

FORD

MONDEO IV (BA7)

2.5	Petrol	162	03/07 →
2.5	Petrol	162	03/07 →

MONDEO IV Tre volumi (BA7)

2.5	Petrol	162	03/07 →
-----	--------	-----	---------

MONDEO IV Turnier (BA7)

2.5	Petrol	162	03/07 →
-----	--------	-----	---------

S-MAX (WA6)

2.5 ST	Petrol	162	05/06 →
--------	--------	-----	---------

SAD040

H3 **SENSORE DETONAZIONE**
KNOCK SENSOR



FORD

FOCUS (DAW, DBW)

1.8 TDCi	Diesel	74	08/02 → 11/04
1.8 TDCi	Diesel	85	03/01 → 11/04

FOCUS Station wagon (DNW)

1.8 TDCi	Diesel	74	08/02 → 11/04
1.8 TDCi	Diesel	85	03/01 → 11/04

FOCUS Tre volumi (DFW)

1.8 TDCi	Diesel	74	08/02 → 11/04
1.8 TDCi	Diesel	85	03/01 → 11/04

SAD040

FORD
MONDEO III (B5Y)

2.0 16V DI / TDDi / TDCi	Diesel	66	11/00 → 08/07
2.0 16V TDDi / TDCi	Diesel	85	11/00 → 08/07
2.0 TDCi	Diesel	96	10/01 → 08/07
2.2 TDCi	Diesel	114	09/04 → 08/07

MONDEO III Station wagon (BWY)

2.0 16V DI / TDDi / TDCi	Diesel	66	11/00 → 08/07
2.0 16V TDDi / TDCi	Diesel	85	11/00 → 08/07
2.0 TDCi	Diesel	96	10/01 → 08/07
2.2 TDCi	Diesel	114	09/04 → 08/07

MONDEO III Tre volumi (B4Y)

2.0 16V DI / TDDi / TDCi	Diesel	66	11/00 → 08/07
2.0 16V TDDi / TDCi	Diesel	85	11/00 → 08/07
2.0 TDCi	Diesel	96	10/01 → 08/07
2.2 TDCi	Diesel	114	09/04 → 08/07

TOURNEO CONNECT

1.8 Di	Diesel	55	06/02 →
1.8 TDCi	Diesel	81	08/06 →
1.8 Turbo Di	Diesel	66	06/02 →

TRANSIT Autobus (FD_ , FB_ , FS_ , FZ_ , FC_)

2.0 TDCi (F_ F_ , F_ E_ , F_ G_)	Diesel	92	08/02 → 05/06
-----------------------------------	--------	----	---------------

TRANSIT CONNECT (P65_ , P70_ , P80_)

1.8 Di	Diesel	55	06/02 →
1.8 TDCi	Diesel	66	06/02 →
1.8 TDCi	Diesel	81	08/06 →

TRANSIT Furgonato (FA_)

2.0 TDCi	Diesel	92	08/02 → 05/06
----------	--------	----	---------------

TRANSIT Pianale piatto/Telaio (FM_ , FN_)

2.0 TDCi (F_ E_ , F_ F_)	Diesel	92	08/02 → 05/06
---------------------------	--------	----	---------------

JAGUAR
XF (_ J05_ , CC9)

5.0	Petrol	283	03/09 →
5.0 Kompressor	Petrol	375	03/09 →

X-TYPE (CF1)

2.0 D	Diesel	96	07/03 → 11/09
2.2 D	Diesel	114	10/05 → 11/09
2.2 D	Diesel	107	01/07 → 11/09

SAD040

JAGUAR
X-TYPE Estate

2.0 D	Diesel	96	02/04 → 12/09
2.2 D	Diesel	114	10/05 → 12/09
2.2 D	Diesel	107	01/07 → 12/09

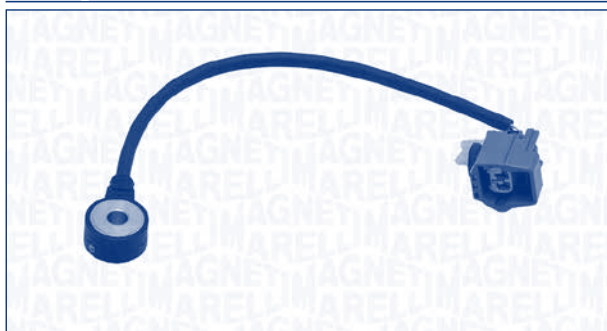
SAD041
**H3 SENSORE DETONAZIONE
KNOCK SENSOR**

FORD
C-MAX (DM2)

1.8 TDCi	Diesel	85	02/07 →
----------	--------	----	---------

FOCUS C-MAX

1.8 TDCi	Diesel	85	01/05 → 03/07
----------	--------	----	---------------

FOCUS II (DA_)

1.8 TDCi	Diesel	85	01/05 →
----------	--------	----	---------

FOCUS II Station wagon (DA_)

1.8 TDCi	Diesel	85	11/04 →
----------	--------	----	---------

FOCUS II Tre volumi (DA_)

1.8 TDCi	Diesel	85	04/05 →
----------	--------	----	---------

GALAXY (WA6)

1.8 TDCi	Diesel	74	05/06 →
1.8 TDCi	Diesel	92	05/06 →

S-MAX (WA6)

1.8 TDCi	Diesel	92	05/06 →
----------	--------	----	---------

CVM03/1

H1 **SENSORE GIRI / FASE - ALBERO MOTORE**
CRANKSHAFT POSITION SENSOR



ALFA ROMEO

MITO (955)

1.4	Petrol	51	05/11 →	ENGINE: 955A9000
1.4	Petrol	57	03/11 →	ENGINE: 955A1000

FIAT

500 (312)

1.2	Petrol	51	10/07 →	
-----	--------	----	---------	--

DOBLO (119)

1.2 (223AXA1A)	Petrol	48	03/01 →	ENGINE: 2533528 →
1.4	Petrol	57	10/05 →	

DOBLO Cargo (223)

1.2 (223ZX1A)	Petrol	48	03/01 →	ENGINE: 2533528 →
1.4	Petrol	57	10/05 →	

LINEA (323)

1.4	Petrol	57	06/07 →	
-----	--------	----	---------	--

PALIO (178BX)

1.4	Petrol	51	04/96 →	
1.4 Cat.	Petrol	51	04/96 →	

PANDA (169)

1.1	Petrol	40	09/03 →	
1.2	Petrol	44	09/03 →	

PUNTO (188)

1.2 16V 80 (188.233, .235, .253, .255, .333, .353, .639...)	Petrol	59	09/99 →	ENGINE: 2192182 →
1.2 60 (188.030, .050, .130, .150, .230, .250)	Petrol	44	09/99 →	ENGINE: 2192182 →
1.2 Natural Power	BiFuel	44	09/03 →	ENGINE: 2192182 →

PUNTO / GRANDE PUNTO (199)

1.2	Petrol	48	10/05 →	
1.4	Petrol	57	10/05 →	

CVM03/1



FIAT

SIENA (178_)

1.4	Petrol	51	04/96 →	
1.4 Cat.	Petrol	51	04/96 →	

FORD

KA (RU8)

1.2	Petrol	51	10/08 →	ENGINE: FP4
-----	--------	----	---------	-------------

LANCIA

MUSA (350)

1.4	Petrol	57	09/05 →	
-----	--------	----	---------	--

CVS02

H1 **SENSORE GIRI / FASE - ALBERO MOTORE**
CRANKSHAFT POSITION SENSOR



RENAULT

CLIO Grandtour (KR0/1_)

1.2 16V Hi-Flex (KR0S)	BiFuel	55	07/08 →	ENGINE: D4F740
1.2 16V (KR02, KR0J)	Petrol	55	02/08 →	ENGINE: D4F740
1.2 16V (KR0E)	Petrol	58	02/08 →	ENGINE: D4F764
1.5 dCi (KR0F)	Diesel	63	02/08 →	ENGINE: K9K766
1.5 dCi (KR0H)	Diesel	78	02/08 →	ENGINE: K9K764
1.6 16V (KR0B)	Petrol	82	02/08 →	ENGINE: K4M800, K4M801

CLIO III (BR0/1, CR0/1)

1.2 16V Hi-Flex (BR1U, CR1U)	BiFuel	55	07/08 →	ENGINE: D4F740, D4F742
1.2 16V (BR0R, BR1D, BR1L, CR0R)	Petrol	48	06/05 →	ENGINE: D4F740
1.5 dCi	Diesel	48	05/05 →	ENGINE: K9K752
1.5 dCi (BR0H, CR0H)	Diesel	78	06/05 →	ENGINE: K9K764

CVS02

KW

RENAULT
CLIO III (BR0/1, CR0/1)

1.5 dCi (BR17, CR17)	Diesel	63	06/05 →	ENGINE: K9K766
----------------------	--------	----	---------	----------------

1.6 16V (BR05, BR0B, BR0Y, BR15, BR1J, BR1M, BR1Y, CR0B...)	Petrol	82	06/05 →	ENGINE: K4M800, K4M801
---	--------	----	---------	------------------------

2.0 16V Sport	Petrol	145	02/06 →	ENGINE: F4R830
---------------	--------	-----	---------	----------------

2.0 16V Sport	Petrol	148	09/08 →	ENGINE: F4R830
---------------	--------	-----	---------	----------------

MODUS / GRAND MODUS (F/JP0_)

1.2 (FP0C, FP0K, FP0P)	Petrol	48	05/05 →	ENGINE: D4F740
------------------------	--------	----	---------	----------------

1.2 (JP0S)	Petrol	58	12/04 →	ENGINE: D4F764
------------	--------	----	---------	----------------

1.5 dCi (FP0E, JP0E)	Diesel	48	12/04 →	ENGINE: K9K752
----------------------	--------	----	---------	----------------

TRAFIC II Autobus (JL)

2.0 dCi 115 (JL0H)	Diesel	84	08/06 →	ENGINE: M9R780, M9R782, M9R786, M9R692, M9R630
--------------------	--------	----	---------	--

2.5 dCi 145 (JL0J)	Diesel	107	08/06 →	ENGINE: G9U630
--------------------	--------	-----	---------	----------------

TRAFIC II Furgonato (FL)

2.0 dCi 115 (FL01, FL0U)	Diesel	84	08/06 →	ENGINE: M9R780, M9R782, M9R786, M9R692
--------------------------	--------	----	---------	--

2.0 dCi 90 (FL0H)	Diesel	66	08/06 →	ENGINE: M9R780, M9R782, M9R630
-------------------	--------	----	---------	--------------------------------

2.5 dCi 145 (FL0J)	Diesel	107	08/06 →	ENGINE: G9U630
--------------------	--------	-----	---------	----------------

TRAFIC II Pianale piatto/Telaio (EL)

2.0 dCi 115 (EL0H)	Diesel	84	08/06 →	ENGINE: M9R780, M9R782, M9R786
--------------------	--------	----	---------	--------------------------------

2.0 dCi 90 (EL0H)	Diesel	66	08/06 →	ENGINE: M9R780, M9R782
-------------------	--------	----	---------	------------------------

2.5 dCi 145 (EL0J)	Diesel	107	08/06 →	ENGINE: G9U630
--------------------	--------	-----	---------	----------------

TWINGO II (CN0_)

1.2 (CN0D)	Petrol	43	03/07 →	ENGINE: D7F800
------------	--------	----	---------	----------------

1.5 dCi (CN0E)	Diesel	47	03/07 →	ENGINE: K9K740
----------------	--------	----	---------	----------------

CWM02/1
H1
**SENSORE GIRI / FASE - ALBERO MOTORE
CRANKSHAFT POSITION SENSOR**

KW

FIAT
BRAVA (182)

1.6 16V (182.BH)	Petrol	66	10/95 → 10/01
------------------	--------	----	---------------

BRAVO I (182)

1.6 16V (182.AH)	Petrol	66	10/95 → 10/01
------------------	--------	----	---------------

DOBLO (119)

1.6 16V (223AXD1A)	Petrol	76	10/01 →
--------------------	--------	----	---------

1.6 Natural Power	BiFuel	76	09/02 →
-------------------	--------	----	---------

DOBLO Cargo (223)

1.6 16V (223ZXD1A)	Petrol	76	10/01 →
--------------------	--------	----	---------

1.6 Natural Power	BiFuel	76	09/02 →
-------------------	--------	----	---------

MAREA (185)

1.6 100 16V Bipower	Petrol/ CNG	76	04/99 → 05/02
---------------------	----------------	----	---------------

MULTIPLA (186)

1.6 100 16V (186AXA1A)	Petrol	76	04/99 → 06/10
------------------------	--------	----	---------------

1.6 16V Bipower (186AMB1A)	Petrol/ CNG	76	04/99 → 06/10
----------------------------	----------------	----	---------------

1.6 16V Bipower (186AXC1A)	Petrol/ CNG	76	10/01 → 06/10
----------------------------	----------------	----	---------------

1.6 16V Blupower (186AMA1A)	Bifuel	70	04/99 → 06/10
-----------------------------	--------	----	---------------

PALIO (178BX)

1.6 16V	Petrol	74	04/96 →
---------	--------	----	---------

PALIO Weekend (178DX)

1.6 16V (178DX.D1A)	Petrol	74	04/96 → 02/01
---------------------	--------	----	---------------

1.6 16V (178DYC1A06)	Petrol	76	02/01 →
----------------------	--------	----	---------

SIENA (178_)

1.6 16V	Petrol	78	09/98 →
---------	--------	----	---------

CWM02/1



FIAT

STILO (192)

1.6 16V (192_XB1A)	Petrol	76	10/01 → 11/06
-----------------------	--------	----	---------------

STILO Multi Wagon (192)

1.6 16V	Petrol	76	01/03 → 08/08
---------	--------	----	---------------

LANCIA

DEDRA (835)

1.6 16V (835EI)	Petrol	76	01/96 → 07/99
-----------------	--------	----	---------------

DEDRA SW (835)

1.6 16V (835EI)	Petrol	76	01/96 → 07/99
-----------------	--------	----	---------------

LYBRA (839AX)

1.6 16V (839AXA1A)	Petrol	76	07/99 → 10/05
-----------------------	--------	----	---------------

LYBRA SW (839BX)

1.6 16V (839BXA1A)	Petrol	76	07/99 → 10/05
-----------------------	--------	----	---------------

CWM02/2

H1 **SENSORE GIRI / FASE - ALBERO MOTORE**
CRANKSHAFT POSITION SENSOR



FIAT

DUCATO Autobus (230)

2.8 D	Diesel	64	02/98 → 04/02
-------	--------	----	---------------

DUCATO Furgonato (230L)

2.8 D	Diesel	64	05/98 → 04/02
-------	--------	----	---------------

DUCATO Pianale piatto/Telaio (230)

2.8 D	Diesel	64	02/98 → 04/02
-------	--------	----	---------------

CWM02/3

H1 **SENSORE GIRI / FASE - ALBERO MOTORE**
CRANKSHAFT POSITION SENSOR



FIAT

PALIO (178BX)

1.2	Petrol	54	06/98 →
-----	--------	----	---------

PALIO Weekend (178DX)

1.2 (178DX.G1A)	Petrol	54	04/96 → 02/01
-----------------	--------	----	---------------

1.2 (178DYA1A)	Petrol	44	02/01 →
----------------	--------	----	---------

PUNTO (176)

55 1.1	Petrol	40	09/93 → 09/99
--------	--------	----	---------------

60 1.2	Petrol	43	01/94 → 09/99
--------	--------	----	---------------

60 1.2	Petrol	44	03/94 → 09/99
--------	--------	----	---------------

75 1.2	Petrol	54	12/93 → 09/99
--------	--------	----	---------------

PUNTO Cabriolet (176C)

60 1.2	Petrol	43	04/94 → 06/00
--------	--------	----	---------------

60 1.2	Petrol	44	05/95 → 06/00
--------	--------	----	---------------

PUNTO Van (176L)

1.1	Petrol	40	04/96 → 02/00
-----	--------	----	---------------

PUNTO Van (188AX)

1.2 60	Petrol	44	02/00 → 10/09
--------	--------	----	---------------

SIENA (178_)

1.2	Petrol	54	09/98 →
-----	--------	----	---------

STRADA Pick-up (178E)

1.2	Petrol	44	04/03 →
-----	--------	----	---------

1.2	Petrol	54	06/99 →
-----	--------	----	---------

UNO (146A/E)

55 1.0	Petrol	41	03/94 → 08/00
--------	--------	----	---------------

LANCIA

Y (840A)

1.1 (840AE)	Petrol	40	11/95 → 09/03
-------------	--------	----	---------------

1.2 (840AA, 840AF1A)	Petrol	44	03/96 → 09/03
-------------------------	--------	----	---------------

YPSILON (843)

1.2	Petrol	44	10/03 → 12/11
-----	--------	----	---------------

1.2	Petrol	59	10/03 → 12/11
-----	--------	----	---------------

CWM02/5
H1 **SENSORE GIRI / FASE - ALBERO MOTORE**
CRANKSHAFT POSITION SENSOR

FIAT
PANDA (141A_)

1100	Petrol	40	01/01 → 09/03
------	--------	----	---------------

1100 4x4	Petrol	40	01/01 → 09/03
----------	--------	----	---------------

SEICENTO (187)

1.1 (187AXB, 187AXB1A)	Petrol	40	01/01 → 01/10
------------------------	--------	----	---------------

CWM02/6
H1 **SENSORE GIRI / FASE - ALBERO MOTORE**
CRANKSHAFT POSITION SENSOR

FIAT
CINQUECENTO (170)

1.1 Sporting (170AH)	Petrol	40	10/94 → 01/98
----------------------	--------	----	---------------

SEICENTO (187)

1.1 (187AXB, 187AXB1A)	Petrol	40	01/98 → 01/10
------------------------	--------	----	---------------

SEICENTO Van (187)

1.1 (187CXB/C)	Petrol	40	01/98 → 01/10
----------------	--------	----	---------------

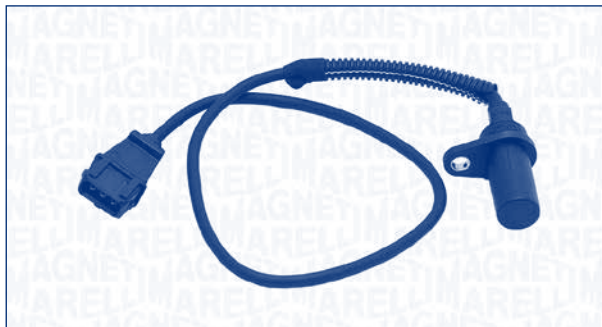
CWM02/8
H1 **SENSORE GIRI / FASE - ALBERO MOTORE**
CRANKSHAFT POSITION SENSOR

FIAT
DOBLO (119)

1.2 (223AXA1A)	Petrol	48	03/01 → 12/04
----------------	--------	----	---------------

DOBLO Cargo (223)

1.2 (223ZX1A)	Petrol	48	03/01 → 12/04
---------------	--------	----	---------------

PALIO (178BX)

1.2	Petrol	54	06/98 → 12/02
-----	--------	----	---------------

PALIO Weekend (178DX)

1.2 (178DYA1A)	Petrol	44	02/01 → 12/02
----------------	--------	----	---------------

LANCIA
Y (840A)

1.2 (840AA, 840AF1A)	Petrol	44	01/03 → 09/03
----------------------	--------	----	---------------

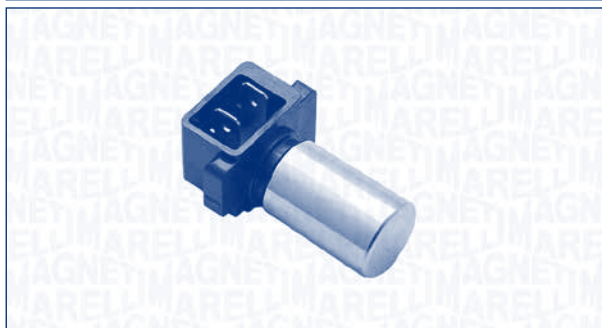
SAC005
H1 **SENSORE GIRI / FASE - ALBERO MOTORE**
CRANKSHAFT POSITION SENSOR

FORD
MONDEO III (B5Y)

ST220	Petrol	166	04/02 → 08/07
-------	--------	-----	---------------

MONDEO III Station wagon (BWY)

ST220	Petrol	166	04/02 → 08/07
-------	--------	-----	---------------

MONDEO III Tre volumi (B4Y)

ST220	Petrol	166	04/02 → 08/07
-------	--------	-----	---------------

SAC006

H1 **SENSORE GIRI / FASE - ALBERO MOTORE**
CRANKSHAFT POSITION SENSOR



FORD

COUGAR (EC_)

2.0 16V	Petrol	96	08/98 → 12/01
2.5 ST 200	Petrol	151	01/00 → 12/01
2.5 V6 24V	Petrol	125	06/00 → 12/01
2.5 V6 24V	Petrol	125	08/98 → 12/01

MONDEO II (BAP)

2.5 24V	Petrol	125	06/00 → 11/00
2.5 ST 200	Petrol	151	05/99 → 11/00

MONDEO II Station wagon (BNP)

2.5 24V	Petrol	125	05/00 → 11/00
2.5 ST 200	Petrol	151	05/99 → 11/00

MONDEO II Tre volumi (BFP)

2.5 24V	Petrol	125	06/00 → 11/00
2.5 ST 200	Petrol	151	05/99 → 11/00

SAC007

H1 **SENSORE GIRI / FASE - ALBERO MOTORE**
CRANKSHAFT POSITION SENSOR

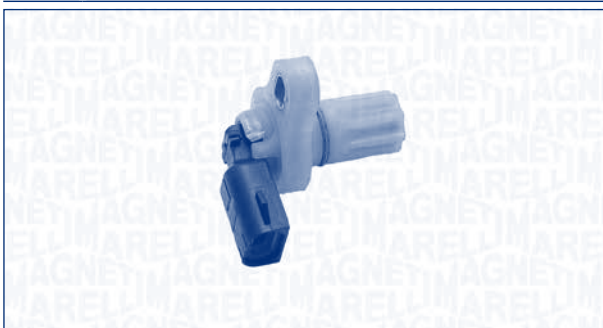

FORD

MAVERICK

2.0 16V	Petrol	91	02/01 →
2.3 16V	Petrol	110	03/04 →

SAC007



FORD

MAVERICK

3.0 V6 24V	Petrol	145	02/01 →
3.0 V6 24V	Petrol	149	03/04 →

MONDEO I (GBP)

1.8 i 16V 4x4	Petrol	85	02/93 → 08/96
1.8 TD	Diesel	65	06/93 → 08/96
1.8 TD	Diesel	66	10/95 → 08/96
2.0 i 16V	Petrol	100	02/93 → 08/96
2.0 i 16V	Petrol	97	12/94 → 08/96
2.0 i 16V 4x4	Petrol	97	12/94 → 08/96
2.5 i 24V	Petrol	125	07/94 → 08/96

MONDEO I Station wagon (BNP)

1.8 i 16V 4x4	Petrol	85	04/93 → 08/96
1.8 TD	Diesel	65	06/93 → 08/96
1.8 TD	Diesel	66	11/95 → 08/96
2.0 i 16V	Petrol	100	04/93 → 08/96
2.0 i 16V	Petrol	97	01/93 → 08/96
2.0 i 16V 4x4	Petrol	100	04/93 → 08/96
2.0 i 16V 4x4	Petrol	97	12/94 → 08/96
2.5 i 24V	Petrol	125	07/94 → 08/96

MONDEO I Tre volumi (GBP)

1.8 TD	Diesel	65	06/93 → 08/96
1.8 TD	Diesel	66	10/95 → 08/96
2.0 i 16V	Petrol	100	02/93 → 08/96
2.0 i 16V 4x4	Petrol	97	12/94 → 08/96
2.5 i 24V	Petrol	125	07/94 → 08/96

MONDEO III (B5Y)

1.8 16V	Petrol	81	11/00 → 08/07
1.8 16V	Petrol	92	11/00 → 08/07
1.8 SCi	Petrol	96	06/03 → 08/07
2.0 16V	Petrol	107	11/00 → 08/07
2.0 16V DI / TDDi / TDCi	Diesel	66	11/00 → 08/07
2.0 16V TDDi / TDCi	Diesel	85	11/00 → 08/07
2.0 TDCi	Diesel	92	02/03 → 06/05
2.0 TDCi	Diesel	96	10/01 → 08/07
2.2 TDCi	Diesel	114	09/04 → 08/07
2.5 V6 24V	Petrol	125	11/00 → 08/07
3.0 V6 24V	Petrol	150	09/04 → 08/07

MONDEO III Station wagon (BWY)

1.8 16V	Petrol	81	11/00 → 08/07
1.8 16V	Petrol	92	11/00 → 08/07
1.8 SCi	Petrol	96	06/03 → 08/07
2.0 16V	Petrol	107	11/00 → 08/07

SAC007

FORD
MONDEO III Station wagon (BWY)

2.0 16V DI / TDDi / TDCi	Diesel	66	11/00 → 08/07
2.0 16V TDDi / TDCi	Diesel	85	11/00 → 08/07
2.0 TDCi	Diesel	96	10/01 → 08/07
2.2 TDCi	Diesel	114	09/04 → 08/07
2.5 V6 24V	Petrol	125	11/00 → 08/07
3.0 V6 24V	Petrol	150	09/04 → 08/07

MONDEO III Tre volumi (B4Y)

1.8 16V	Petrol	81	11/00 → 08/07
1.8 16V	Petrol	92	11/00 → 08/07
1.8 SCi	Petrol	96	06/03 → 08/07
2.0 16V	Petrol	107	11/00 → 08/07
2.0 16V DI / TDDi / TDCi	Diesel	66	11/00 → 08/07
2.0 16V TDDi / TDCi	Diesel	85	11/00 → 08/07
2.0 TDCi	Diesel	92	02/03 → 06/05
2.0 TDCi	Diesel	96	10/01 → 08/07
2.2 TDCi	Diesel	114	09/04 → 08/07
2.5 V6 24V	Petrol	125	11/00 → 08/07
3.0 V6 24V	Petrol	150	09/04 → 08/07

SAC008
H1
**SENSORE GIRI / FASE - ALBERO MOTORE
CRANKSHAFT POSITION SENSOR**

FORD
C-MAX (DM2)

1.6	Petrol	74	02/07 →
1.6 TDCi	Diesel	66	02/07 →
1.6 TDCi	Diesel	80	02/07 →
1.8	Petrol	92	02/07 →

SAC008

FORD
C-MAX (DM2)

1.8 Flexifuel	Petrol/ Ethanol	92	02/07 →
2.0	Petrol	107	02/07 →
2.0 TDCi	Diesel	100	02/07 →

FIESTA VI

1.25	Petrol	44	06/08 →
1.25	Petrol	60	06/08 →
1.4	Petrol	71	06/08 →
1.4 TDCi	Diesel	50	01/09 →
1.6 TDCi	Diesel	66	06/08 →
1.6 TDCi	Diesel	55	06/08 →
1.6 Ti	Petrol	88	06/08 →

FOCUS (DAW, DBW)

1.6 16V	Petrol	74	10/98 → 11/04
1.8 16V	Petrol	85	10/98 → 11/04
1.8 DI / TDDi	Diesel	55	08/99 → 11/04
1.8 TDCi	Diesel	74	08/02 → 11/04
1.8 TDCi	Diesel	85	03/01 → 11/04
1.8 Turbo DI / TDDi	Diesel	66	10/98 → 11/04
2.0 16V	Petrol	96	10/98 → 11/04
ST170	Petrol	127	03/02 → 11/04

FOCUS C-MAX

1.6	Petrol	74	10/03 → 03/07
1.6 TDCi	Diesel	66	02/05 → 03/07
1.6 TDCi	Diesel	80	10/03 → 03/07
1.6 Ti	Petrol	85	08/04 → 03/07
1.8 TDCi	Diesel	85	01/05 → 03/07
2.0 TDCi	Diesel	100	10/03 → 03/07

FOCUS II (DA_)

1.4	Petrol	59	11/04 →
1.6	Petrol	74	11/04 →
1.6 TDCi	Diesel	80	11/04 →
1.6 TDCi	Diesel	66	01/05 →
1.6 Ti	Petrol	85	11/04 →
1.8 Flexifuel	Petrol/ Ethanol	96	12/05 →
1.8 TDCi	Diesel	85	01/05 →
2.0 TDCi	Diesel	100	11/04 →
2.5 ST	Petrol	166	10/05 →

FOCUS II Cabriolet

2.0	Petrol	107	10/06 →
2.0 TDCi	Diesel	100	10/06 →

SAC008



FORD

FOCUS II Station wagon (DA_)

1.4	Petrol	59	11/04 →
1.6	Petrol	74	11/04 →
1.6 TDCi	Diesel	66	11/04 →
1.6 TDCi	Diesel	80	11/04 →
1.6 Ti	Petrol	85	11/04 →
1.8 Flexifuel	Petrol/ Ethanol	97	12/05 →
1.8 TDCi	Diesel	85	11/04 →
2.0 TDCi	Diesel	100	11/04 →

FOCUS II Tre volumi (DA_)

1.4	Petrol	59	04/05 →
1.6	Petrol	74	04/05 →
1.6 TDCi	Diesel	66	04/05 →
1.6 TDCi	Diesel	80	04/05 →
1.6 Ti	Petrol	85	04/05 →
1.8 Flexifuel	Petrol/ Ethanol	96	12/05 →
1.8 TDCi	Diesel	85	04/05 →
2.0 TDCi	Diesel	100	04/05 →

FOCUS Station wagon (DNW)

1.6 16V	Petrol	74	02/99 → 11/04
1.8 16V	Petrol	85	02/99 → 11/04
1.8 DI / TDDi	Diesel	55	08/99 → 11/04
1.8 TDCi	Diesel	74	08/02 → 11/04
1.8 TDCi	Diesel	85	03/01 → 11/04
1.8 Turbo DI / TDDi	Diesel	66	02/99 → 11/04
2.0 16V	Petrol	96	02/99 → 11/04
ST170	Petrol	127	08/02 → 11/04

FOCUS Tre volumi (DFW)

1.6 16V	Petrol	74	02/99 → 11/04
1.8 16V	Petrol	85	02/99 → 11/04
1.8 TDCi	Diesel	74	08/02 → 11/04
1.8 TDCi	Diesel	85	03/01 → 11/04
1.8 Turbo DI / TDDi	Diesel	66	02/99 → 11/04
2.0 16V	Petrol	96	02/99 → 11/04

SAC009

H1 **SENSORE GIRI / FASE - ALBERO MOTORE**
CRANKSHAFT POSITION SENSOR



FORD

GALAXY (WGR)

1.9 TDI	Diesel	85	04/00 → 05/06
---------	--------	----	---------------

SAC010

H1 **SENSORE GIRI / FASE - ALBERO MOTORE**
CRANKSHAFT POSITION SENSOR



DACIA

LOGAN (LS_)

1.5 dCi (LS0J, LS0Y)	Diesel	48	09/05 →
1.5 dCi (LS0K)	Diesel	50	01/06 →
1.5 dCi (LS0W)	Diesel	63	09/07 →

LOGAN EXPRESS (FS_)

1.5 dCi (FS0K)	Diesel	50	03/09 →
1.5 dCi (FS0W)	Diesel	63	03/09 →

LOGAN MCV (KS_)

1.5 dCi (KS0K)	Diesel	50	02/07 →
1.5 dCi (KS0W)	Diesel	63	09/07 →

LOGAN Pick-up (US_)

1.5 dCi (US0K)	Diesel	50	03/08 →
1.5 dCi (US0W)	Diesel	63	03/08 →

SAC010

DACIA
SANDERO

1.5 dCi	Diesel	50	11/08 →
1.5 dCi	Diesel	63	11/08 →

NISSAN
ALMERA II (N16)

1.5 dCi	Diesel	60	06/03 →
---------	--------	----	---------

ALMERA II Hatchback (N16)

1.5 dCi	Diesel	60	06/03 →
---------	--------	----	---------

NOTE (E11)

1.5 dCi	Diesel	76	07/08 →
---------	--------	----	---------

QASHQAI / QASHQAI +2 (J10, JJ10)

1.5 dCi	Diesel	76	08/08 →
---------	--------	----	---------

1.5 dCi	Diesel	78	08/08 →
---------	--------	----	---------

1.5 dCi	Diesel	81	11/10 →
---------	--------	----	---------

RENAULT
CLIO Grandtour (KR0/1_)

1.2 16V (KR0E)	Petrol	58	02/08 → 09/08
----------------	--------	----	---------------

1.5 dCi	Diesel	48	02/10 →
---------	--------	----	---------

1.5 dCi (KR0F)	Diesel	63	02/08 → 10/08
----------------	--------	----	---------------

1.5 dCi (KR0G)	Diesel	50	02/08 → 10/08
----------------	--------	----	---------------

1.5 dCi (KR0H)	Diesel	78	02/08 → 07/08
----------------	--------	----	---------------

1.5 dCi (KR1C, KR1N)	Diesel	76	02/08 → 07/08
----------------------	--------	----	---------------

CLIO II (BB0/1/2_, CB0/1/2_)

1.5 dCi	Diesel	74	01/04 →
---------	--------	----	---------

1.5 dCi (B/C2J)	Diesel	50	08/04 →
-----------------	--------	----	---------

1.5 dCi (B/CB03)	Diesel	59	06/01 → 10/03
------------------	--------	----	---------------

1.5 dCi (B/CB07)	Diesel	48	06/01 →
------------------	--------	----	---------

1.5 dCi (B/CB08)	Diesel	60	06/01 →
------------------	--------	----	---------

1.5 dCi (B/CB3M)	Diesel	47	06/05 →
------------------	--------	----	---------

1.5 dCi (B/CB3N)	Diesel	62	02/07 → 06/09
------------------	--------	----	---------------

CLIO II Furgonato (SB0/1/2_)

1.5 dCi	Diesel	59	06/01 → 10/04
---------	--------	----	---------------

1.5 dCi	Diesel	60	11/03 →
---------	--------	----	---------

1.5 dCi (SB07)	Diesel	48	06/01 →
----------------	--------	----	---------

CLIO III (BR0/1, CR0/1)

1.2 16V	Petrol	58	10/05 → 09/08
---------	--------	----	---------------

1.5 dCi	Diesel	48	05/05 →
---------	--------	----	---------

1.5 dCi	Diesel	47	06/05 →
---------	--------	----	---------

1.5 dCi	Diesel	60	11/07 →
---------	--------	----	---------

1.5 dCi (BR0H, CR0H)	Diesel	78	06/05 → 07/08
----------------------	--------	----	---------------

1.5 dCi (BR17, CR17)	Diesel	63	06/05 → 10/08
----------------------	--------	----	---------------

SAC010

RENAULT
CLIO III (BR0/1, CR0/1)

1.5 dCi (BR1C, CR1C)	Diesel	76	06/05 →
----------------------	--------	----	---------

1.5 dCi (C/BR1G)	Diesel	50	06/05 → 10/08
------------------	--------	----	---------------

2.0 16V Sport	Petrol	145	02/06 →
---------------	--------	-----	---------

2.0 16V Sport	Petrol	148	09/08 →
---------------	--------	-----	---------

GRAND SCÉNIC II (JM0/1_)

1.5 dCi (JM02, JM13)	Diesel	74	04/04 →
----------------------	--------	----	---------

1.5 dCi (JM1E)	Diesel	78	05/05 →
----------------	--------	----	---------

1.6	Petrol	83	04/04 →
-----	--------	----	---------

KANGOO (KC0/1_)

1.5 dCi	Diesel	42	07/03 →
---------	--------	----	---------

1.5 dCi	Diesel	50	06/08 → 10/09
---------	--------	----	---------------

1.5 dCi	Diesel	62	06/05 → 06/08
---------	--------	----	---------------

1.5 dCi (KC07)	Diesel	48	12/01 →
----------------	--------	----	---------

1.5 dCi (KC08, KC09)	Diesel	60	07/03 →
----------------------	--------	----	---------

KANGOO / GRAND KANGOO (KW0/1_)

1.5 dCi (KW0A)	Diesel	50	06/08 → 10/09
----------------	--------	----	---------------

1.5 dCi (KW0B)	Diesel	63	02/08 → 10/09
----------------	--------	----	---------------

1.5 dCi (KW0C, KW0F)	Diesel	76	02/09 → 10/09
----------------------	--------	----	---------------

KANGOO BE BOP (KW0/1_)

1.5 dCi (KW0F)	Diesel	76	02/09 → 10/09
----------------	--------	----	---------------

KANGOO Express (FC0/1_)

1.5 dCi	Diesel	45	10/05 →
---------	--------	----	---------

1.5 dCi (FC07, FC1R)	Diesel	48	12/01 →
----------------------	--------	----	---------

1.5 dCi (FC08, FC09)	Diesel	60	04/03 →
----------------------	--------	----	---------

1.5 dCi (FC1E)	Diesel	50	06/05 → 06/08
----------------	--------	----	---------------

1.5 dCi (FC1G)	Diesel	62	06/05 → 06/08
----------------	--------	----	---------------

1.5 dCi (FC1R)	Diesel	42	12/02 →
----------------	--------	----	---------

1.5 dCi	Diesel	50	02/08 →
---------	--------	----	---------

1.5 dCi (FW0F)	Diesel	76	02/08 →
----------------	--------	----	---------

1.5 dCi 85 (FW0A, FW0B)	Diesel	63	02/08 →
-------------------------	--------	----	---------

LAGUNA III (BT0/1)

1.5 dCi (BT00, BT0A, BT0T, BT1J)	Diesel	81	10/07 → 06/08
----------------------------------	--------	----	---------------

LAGUNA III Sportour (KT0/1)

1.5 dCi (KT0A)	Diesel	81	02/08 → 06/08
----------------	--------	----	---------------

SAC010



KW



RENAULT

LOGAN (LS_)

1.5 dCi Diesel 50 04/07 → 06/09

LOGAN Station wagon (KS_)

1.5 dCi Diesel 50 04/07 → 06/09

MASTER II Autobus (JD)

3.0 dCi 140 (JD0T) Diesel 100 10/03 →

MASTER II Furgonato (FD)

3.0 dCi 120 Diesel 85 06/05 →

3.0 dCi 140 (HD0S, FD0S, HD1S) Diesel 100 10/03 →

3.0 dCi 160 Diesel 115 06/05 →

MASTER II Pianale piatto/Telaio (ED/HD/UD)

3.0 dCi 120 Diesel 85 06/05 →

3.0 dCi 140 (ED0S, UD0S) Diesel 100 10/03 →

3.0 dCi 160 Diesel 115 06/05 →

MEGANE II (BM0/1_, CM0/1_)

1.5 dCi Diesel 74 10/03 →

1.5 dCi Diesel 78 05/05 →

1.5 dCi Diesel 63 05/05 → 03/09

1.5 dCi Diesel 76 01/07 →

1.5 dCi (BM0F, CM0F) Diesel 60 11/02 →

MEGANE II Coupé-Cabriolet (EM0/1_)

1.5 dCi (EM16) Diesel 76 01/07 →

1.5 dCi (EM1E) Diesel 78 03/06 →

MEGANE II Station wagon (KM0/1_)

1.5 dCi Diesel 60 08/03 →

1.5 dCi Diesel 74 02/04 →

1.5 dCi Diesel 63 05/05 → 03/09

1.5 dCi (KM13) Diesel 76 01/07 →

1.5 dCi (KM16, KM1E) Diesel 78 05/05 →

MEGANE II Tre volumi (LM0/1_)

1.5 dCi Diesel 60 09/03 →

1.5 dCi Diesel 74 02/04 →

1.5 dCi Diesel 63 05/05 → 03/09

1.5 dCi Diesel 76 01/07 →

1.5 dCi Diesel 78 05/05 → 03/09

MEGANE III 2 volumi /Coda spiovente (BZ0_)

1.6 16V (BZ0H) Petrol 74 11/08 →

SAC010



KW



RENAULT

MEGANE III Coupé (DZ0/1_)

1.6 16V (DZ0H) Petrol 74 06/09 →

MEGANE III Grandtour (KZ0/1)

1.6 16V (KZ0H) Petrol 74 05/09 →

MODUS / GRAND MODUS (F/JP0_)

1.2 (JP0S) Petrol 58 04/05 →

1.5 dCi (FP0D, JP0D) Diesel 60 09/04 →

1.5 dCi (FP0E, JP0E) Diesel 48 12/04 →

1.5 dCi (FP0F, JP0F) Diesel 63 08/06 → 07/08

1.5 dCi (FP0G, JP0G) Diesel 50 12/04 →

1.5 dCi (JP02) Diesel 76 05/07 → 07/08

1.5 dCi (JP0G, JP0H) Diesel 78 05/05 → 07/08

1.6 (JP03, JP0B, JP0U, JP0Y, JP1G) Petrol 82 12/04 →

SCÉNIC II (JM0/1_)

1.5 dCi (JM02, JM13) Diesel 74 11/03 →

1.5 dCi (JM0F) Diesel 60 06/03 →

1.5 dCi (JM16) Diesel 76 01/07 →

1.5 dCi (JM1E) Diesel 78 06/06 →

1.5 dCi (JM1F) Diesel 63 05/05 →

1.6 (JM0C, JM0J, JM1B) Petrol 83 06/03 →

1.6 16V (JM1R) Petrol 82 01/07 →

THALIA I (LB0/1/2_)

1.5 dCi Diesel 48 04/02 →

1.5 dCi Diesel 60 06/01 →

1.5 dCi Diesel 47 09/08 → 10/08

THALIA II (LU1/2_)

1.5 dCi Diesel 47 09/08 → 10/08

1.5 dCi Diesel 62 09/08 → 10/08

TWINGO II (CN0_)

1.5 dCi (CN0E) Diesel 47 03/07 → 10/08

1.6 RS (CN0N, CN0R, CN0S) Petrol 98 05/08 → 02/09

SUZUKI

JIMNY (FJ)

1.5 DDiS 4WD Diesel 48 12/03 →

1.5 DDiS 4x4 Diesel 63 08/05 →

SAG001
H1 **SENSORE GIRI / FASE - ALBERO MOTORE**
CRANKSHAFT POSITION SENSOR

FORD
FOCUS (DAW, DBW)

1.8 TDCi	Diesel	85	03/01 → 11/04	ENGINE: DURATORQ18TDCI
----------	--------	----	---------------	---------------------------

FOCUS Station wagon (DNW)

1.8 TDCi	Diesel	85	03/01 → 11/04	ENGINE: DURATORQ18TDCI
----------	--------	----	---------------	---------------------------

FOCUS Tre volumi (DFW)

1.8 TDCi	Diesel	85	03/01 → 11/04	ENGINE: DURATORQ18TDCI
----------	--------	----	---------------	---------------------------

SAG002
H1 **SENSORE GIRI / FASE - ALBERO MOTORE**
CRANKSHAFT POSITION SENSOR

FORD
MONDEO III (B5Y)

2.0 16V TDDi / TDCi	Diesel	85	11/00 → 08/07	ENGINE: DURATORQ20TDCI
---------------------	--------	----	---------------	---------------------------

MONDEO III Station wagon (BWY)

2.0 16V TDDi / TDCi	Diesel	85	11/00 → 08/07	ENGINE: DURATORQ20TDCI
---------------------	--------	----	---------------	---------------------------

MONDEO III Tre volumi (B4Y)

2.0 16V TDDi / TDCi	Diesel	85	11/00 → 08/07	ENGINE: DURATORQ20TDCI
---------------------	--------	----	---------------	---------------------------

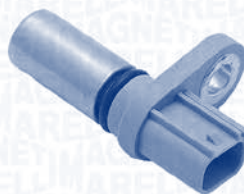
SAG003
H1 **SENSORE GIRI / FASE - ALBERO MOTORE**
CRANKSHAFT POSITION SENSOR

FORD
MAVERICK

3.0 V6 24V	Petrol	145	02/01 →	ENGINE: DURATECSE30LEFI
------------	--------	-----	---------	----------------------------

3.0 V6 24V	Petrol	149	03/04 →	ENGINE: DURATECSE30LEFI
------------	--------	-----	---------	----------------------------

MONDEO I (GBP)

2.5 i 24V	Petrol	125	07/94 → 08/96	ENGINE: DURATEC25EFI
-----------	--------	-----	---------------	-------------------------

MONDEO I Station wagon (BNP)

2.5 i 24V	Petrol	125	07/94 → 08/96	ENGINE: DURATEC25EFI
-----------	--------	-----	---------------	-------------------------

MONDEO I Tre volumi (GBP)

2.5 i 24V	Petrol	125	07/94 → 08/96	ENGINE: DURATEC25EFI
-----------	--------	-----	---------------	-------------------------

MONDEO II (BAP)

2.5 24V	Petrol	125	06/00 → 11/00	ENGINE: DURATEC25EFI
---------	--------	-----	---------------	-------------------------

2.5 ST 200	Petrol	151	05/99 → 11/00	
------------	--------	-----	---------------	--

MONDEO II Station wagon (BNP)

2.5 24V	Petrol	125	05/00 → 11/00	ENGINE: DURATEC25EFI
---------	--------	-----	---------------	-------------------------

2.5 ST 200	Petrol	151	05/99 → 11/00	
------------	--------	-----	---------------	--

MONDEO II Tre volumi (BFP)

2.5 24V	Petrol	125	06/00 → 11/00	ENGINE: DURATEC25EFI
---------	--------	-----	---------------	-------------------------

2.5 ST 200	Petrol	151	05/99 → 11/00	
------------	--------	-----	---------------	--

MONDEO III (B5Y)

2.5 V6 24V	Petrol	125	01/03 → 12/03	
------------	--------	-----	---------------	--

3.0 V6 24V	Petrol	150	09/04 → 08/07	ENGINE: DURATECSE30LEFI
------------	--------	-----	---------------	----------------------------

ST220	Petrol	166	01/03 → 12/03	ENGINE: DURATECST30LEFI
-------	--------	-----	---------------	----------------------------

SAG003



KW



FORD

MONDEO III Station wagon (BWY)

2.5 V6 24V	Petrol	125	03/03 → 03/03	
3.0 V6 24V	Petrol	150	09/04 → 08/07	ENGINE: DURATECSE30LEFI
ST220	Petrol	166	03/03 → 03/03	ENGINE: DURATECST30LEFI

MONDEO III Tre volumi (B4Y)

2.5 V6 24V	Petrol	125	03/03 → 03/03	
3.0 V6 24V	Petrol	150	09/04 → 08/07	ENGINE: DURATECSE30LEFI
ST220	Petrol	166	03/03 → 03/03	ENGINE: DURATECST30LEFI

SAG004

H1 **SENSORE GIRI / FASE - ALBERO MOTORE**
CRANKSHAFT POSITION SENSOR

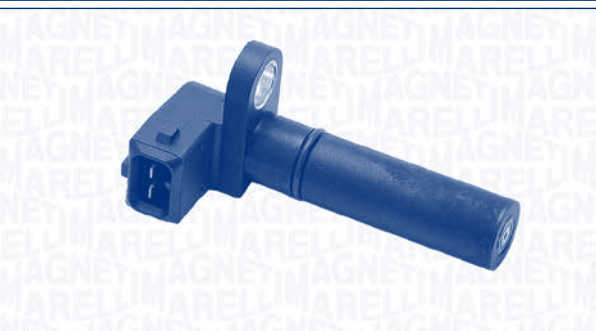

KW



FORD

SCORPIO I (GAE, GGE)

2.0 i	Petrol	85	02/92 → 09/94	ENGINE: DOHC(8V)
2.0 i	Petrol	88	05/89 → 09/94	ENGINE: DOHC(8V)

SCORPIO I Station wagon (GGE)

2.0 i	Petrol	85	09/91 → 09/94	ENGINE: DOHC(8V)
2.0 i	Petrol	88	09/91 → 09/94	ENGINE: DOHC(8V)

SCORPIO I Tre volumi (GGE)

2.0 i	Petrol	85	02/92 → 09/94	ENGINE: DOHC(8V)
2.0 i	Petrol	88	05/89 → 09/94	ENGINE: DOHC(8V)

SIERRA 2 volumi /Coda spiovente (GBC, GBG)

2.0 i	Petrol	92	06/89 → 02/93	ENGINE: DOHC(8V)
-------	--------	----	---------------	------------------

SIERRA Station wagon (BNG)

1.6 i	Petrol	59	10/89 → 09/90	ENGINE: DOHC(8V)
-------	--------	----	---------------	------------------

SAG005

H1 **SENSORE GIRI / FASE - ALBERO MOTORE**
CRANKSHAFT POSITION SENSOR



KW



FORD

ESCORT IV (GAF, AWF, ABFT)

1.1	Petrol	37	12/85 → 07/90	ENGINE: OHV,HCS
-----	--------	----	---------------	-----------------

ESCORT V (GAL)

1.3	Petrol	44	07/90 → 09/92	ENGINE: OHV,HCS
1.4	Petrol	52	07/90 → 09/92	ENGINE: OHV,HCS
1.6	Petrol	77	07/90 → 12/92	ENGINE: CVH

ESCORT V Cabriolet (ALL)

1.4	Petrol	52	07/90 → 12/92	ENGINE: OHV,HCS
1.6	Petrol	77	07/90 → 12/92	ENGINE: CVH

ESCORT V Station wagon (GAL, AVL)

1.3	Petrol	44	09/91 → 09/92	ENGINE: OHV,HCS
1.4	Petrol	52	07/90 → 09/92	ENGINE: OHV,HCS
1.6	Petrol	77	07/90 → 09/92	ENGINE: CVH

ESCORT VI (GAL)

1.3	Petrol	44	09/92 → 01/95	ENGINE: OHV,HCS
-----	--------	----	---------------	-----------------

SAG006

H1 **SENSORE GIRI / FASE - ALBERO MOTORE**
CRANKSHAFT POSITION SENSOR



KW



FORD

COUGAR (EC_)

2.0 16V	Petrol	96	08/98 → 12/01	ENGINE: ZETEC-EFI
---------	--------	----	---------------	-------------------

SAG006

FORD
ESCORT CLASSIC (AAL, ABL)

1.6 16V	Petrol	66	10/98 → 07/00
---------	--------	----	---------------

ESCORT CLASSIC Turnier (ANL)

1.6 16V	Petrol	66	02/99 → 07/00
---------	--------	----	---------------

ESCORT V (GAL)

1.8 16V XR3i	Petrol	77	02/92 → 12/92
--------------	--------	----	---------------

1.8 16V XR3i	Petrol	96	02/92 → 12/92
--------------	--------	----	---------------

ESCORT V Cabriolet (ALL)

1.8 16V XR3i	Petrol	77	02/92 → 12/92
--------------	--------	----	---------------

1.8 16V XR3i	Petrol	96	02/92 → 12/92
--------------	--------	----	---------------

ESCORT V Station wagon (GAL, AVL)

1.8 16V	Petrol	77	02/92 → 12/92
---------	--------	----	---------------

ESCORT VI (GAL)

1.6 i 16V	Petrol	65	01/94 → 01/95
-----------	--------	----	---------------

1.6 i 16V	Petrol	66	09/92 → 01/95
-----------	--------	----	---------------

1.8 16V XR3i	Petrol	96	09/92 → 01/95
--------------	--------	----	---------------

1.8 i 16V	Petrol	77	09/92 → 01/95
-----------	--------	----	---------------

1.8 XR3i 16V 4x4	Petrol	77	08/93 → 01/95
------------------	--------	----	---------------

1.8 XR3i 16V 4x4	Petrol	96	08/93 → 01/95
------------------	--------	----	---------------

ESCORT VI Cabriolet (ALL)

1.6 16V XR3i	Petrol	66	12/92 → 01/95
--------------	--------	----	---------------

1.8 16V XR3i	Petrol	77	12/92 → 01/95
--------------	--------	----	---------------

ESCORT VI Station wagon (GAL)

1.6 i 16V	Petrol	66	09/92 → 01/95
-----------	--------	----	---------------

1.8 i 16V	Petrol	77	01/93 → 01/95
-----------	--------	----	---------------

1.8 i 16V	Petrol	96	02/93 → 01/95
-----------	--------	----	---------------

ESCORT VI Tre volumi (GAL)

1.6 i 16V	Petrol	66	08/93 → 01/95
-----------	--------	----	---------------

1.8 i 16V	Petrol	77	08/93 → 01/95
-----------	--------	----	---------------

ESCORT VII (GAL, AAL, ABL)

1.3	Petrol	44	01/95 → 10/98	ENGINE: ZETEC-E
-----	--------	----	---------------	-----------------

1.6 16V	Petrol	66	01/95 → 10/98
---------	--------	----	---------------

1.6 16V 4x4	Petrol	66	01/95 → 10/98
-------------	--------	----	---------------

1.8 16V	Petrol	77	01/95 → 08/95
---------	--------	----	---------------

1.8 16V	Petrol	85	01/95 → 10/98
---------	--------	----	---------------

ESCORT VII Cabriolet (ALL)

1.6 16V XR3i	Petrol	65	02/95 → 12/96
--------------	--------	----	---------------

1.6 16V XR3i	Petrol	66	02/95 → 09/99
--------------	--------	----	---------------

1.8 16V XR3i	Petrol	85	10/95 → 08/98
--------------	--------	----	---------------

ESCORT VII Station wagon (GAL, ANL)

1.3	Petrol	44	01/95 → 01/99	ENGINE: ZETEC-E
-----	--------	----	---------------	-----------------

1.6 16V	Petrol	66	01/95 → 02/99
---------	--------	----	---------------

1.8 16V	Petrol	77	01/95 → 08/95
---------	--------	----	---------------

1.8 16V	Petrol	85	01/95 → 02/99
---------	--------	----	---------------

SAG006

FORD
ESCORT VII Tre volumi (GAL, AFL)

1.3	Petrol	44	01/95 → 02/99	ENGINE: ZETEC-E
-----	--------	----	---------------	-----------------

1.6 i 16V	Petrol	66	01/95 → 02/99
-----------	--------	----	---------------

1.8 16V	Petrol	85	01/95 → 02/99
---------	--------	----	---------------

1.8 16V	Petrol	77	01/95 → 08/95
---------	--------	----	---------------

FIESTA Furgonato (JV_)

D 1.8	Diesel	44	05/98 →
-------	--------	----	---------

FIESTA III (GFJ)

1.1	Petrol	37	03/89 → 12/95
-----	--------	----	---------------

1.3	Petrol	44	03/89 → 12/92	ENGINE: ZETEC-E
-----	--------	----	---------------	-----------------

1.3 Cat.	Petrol	44	05/91 → 12/95	ENGINE: ZETEC-E
----------	--------	----	---------------	-----------------

1.6 i 16V	Petrol	65	01/94 → 12/95
-----------	--------	----	---------------

1.8 16V	Petrol	77	02/92 → 12/95
---------	--------	----	---------------

1.8 XR2i 16V	Petrol	96	02/92 → 12/95
--------------	--------	----	---------------

FIESTA IV (JA_, JB_)

1.0 i	Petrol	38	02/97 → 09/99
-------	--------	----	---------------

1.25 i 16V	Petrol	55	08/95 → 01/02
------------	--------	----	---------------

1.3 i	Petrol	37	08/95 → 01/02	ENGINE: ZETEC-E
-------	--------	----	---------------	-----------------

1.3 i	Petrol	44	08/95 → 01/02	ENGINE: ZETEC-E
-------	--------	----	---------------	-----------------

1.6 16V Sport	Petrol	76	02/00 → 01/02
---------------	--------	----	---------------

1.8 D	Diesel	44	08/95 → 04/00
-------	--------	----	---------------

1.8 Di	Diesel	55	04/00 → 01/02
--------	--------	----	---------------

FOCUS (DAW, DBW)

1.4 16V	Petrol	55	10/98 → 11/04	ENGINE: ZETEC-S
---------	--------	----	---------------	-----------------

1.6 16V	Petrol	74	10/98 → 11/04
---------	--------	----	---------------

1.8 16V	Petrol	85	10/98 → 11/04
---------	--------	----	---------------

1.8 DI / TDDi	Diesel	55	08/99 → 11/04
---------------	--------	----	---------------

1.8 TDCi	Diesel	74	08/02 → 11/04
----------	--------	----	---------------

1.8 Turbo DI / TDDi	Diesel	66	10/98 → 11/04
---------------------	--------	----	---------------

2.0 16V	Petrol	96	10/98 → 11/04	ENGINE: ZETEC2016VEFI
---------	--------	----	---------------	-----------------------

RS	Petrol	158	10/02 → 11/04
----	--------	-----	---------------

ST170	Petrol	127	03/02 → 11/04
-------	--------	-----	---------------

ST170	Petrol	127	03/02 → 11/04
-------	--------	-----	---------------

ST170	Petrol	127	03/02 → 11/04
-------	--------	-----	---------------

FOCUS Station wagon (DNW)

1.4 16V	Petrol	55	02/99 → 11/04	ENGINE: ZETEC-S
---------	--------	----	---------------	-----------------

1.6 16V	Petrol	74	02/99 → 11/04
---------	--------	----	---------------

1.8 16V	Petrol	85	02/99 → 11/04
---------	--------	----	---------------

1.8 DI / TDDi	Diesel	55	08/99 → 11/04
---------------	--------	----	---------------

1.8 TDCi	Diesel	74	08/02 → 11/04
----------	--------	----	---------------

1.8 Turbo DI / TDDi	Diesel	66	02/99 → 11/04
---------------------	--------	----	---------------

2.0 16V	Petrol	96	02/99 → 11/04	ENGINE: ZETEC2016VEFI
---------	--------	----	---------------	-----------------------

ST170	Petrol	127	08/02 → 11/04
-------	--------	-----	---------------

ST170	Petrol	127	08/02 → 11/04
-------	--------	-----	---------------

SAG006



FORD

FOCUS Tre volumi (DFW)

1.4 16V	Petrol	55	02/99 → 11/04	ENGINE: ZETEC-S
1.6 16V	Petrol	74	02/99 → 11/04	
1.8 16V	Petrol	85	02/99 → 11/04	
1.8 TDCi	Diesel	74	08/02 → 11/04	
1.8 Turbo DI / TDDi	Diesel	66	02/99 → 11/04	
2.0 16V	Petrol	96	02/99 → 11/04	ENGINE: ZETEC2016VEFI

KA (RB_)

1.3 i	Petrol	36	06/98 → 11/08	ENGINE: ZETEC-E
-------	--------	----	---------------	-----------------

MONDEO I (GBP)

1.6 i 16V	Petrol	65	07/94 → 08/96	
1.6 i 16V	Petrol	66	02/93 → 08/96	
1.8 i 16V	Petrol	82	07/94 → 08/96	
1.8 i 16V 4x4	Petrol	85	02/93 → 08/96	
2.0 i 16V	Petrol	100	02/93 → 08/96	ENGINE: ZETEC2016VEFI
2.0 i 16V 4x4	Petrol	97	12/94 → 08/96	ENGINE: ZETEC2016VEFI

MONDEO I Station wagon (BNP)

1.6 i 16V	Petrol	65	07/94 → 08/96	
1.6 i 16V	Petrol	66	04/93 → 08/96	
1.8 i 16V	Petrol	82	07/94 → 08/96	
1.8 i 16V	Petrol	85	04/93 → 08/96	
1.8 i 16V 4x4	Petrol	85	04/93 → 08/96	
2.0 i 16V	Petrol	100	04/93 → 08/96	ENGINE: ZETEC2016VEFI
2.0 i 16V 4x4	Petrol	100	04/93 → 08/96	ENGINE: ZETEC2016VEFI

MONDEO I Tre volumi (GBP)

1.6 i 16V	Petrol	65	07/94 → 08/96	
1.6 i 16V	Petrol	66	02/93 → 08/96	
1.8 4x4	Petrol	85	02/93 → 08/96	
1.8 i 16V	Petrol	85	02/93 → 08/96	

TRANSIT Autobus (FD_-, FB_-, FS_-, FZ_-, FC_-)

2.0 DI (F_E_, F_F_, F_G_)	Diesel	55	08/00 → 05/06	
2.4 DI (F_B_, F_C_, F_A_-)	Diesel	66	01/00 → 05/06	
2.4 DI [RWD] (F_B_, F_C_, F_A_-)	Diesel	88	01/00 → 05/06	

SAG006



FORD

TRANSIT Furgonato (FA_ -)

2.0 DI (FAE_, FAF_, FAG_)	Diesel	55	08/00 → 05/06	
2.4 DI (FAA_, FAB_, FAC_, FAD_)	Diesel	66	01/00 → 05/06	
2.4 DI [RWD] (FAA_, FAB_, FAC_, FAD_)	Diesel	88	01/00 → 05/06	

TRANSIT Pianale piatto/Telaio (FM_-, FN_ -)

2.0 DI (F_E_, F_F_)	Diesel	55	08/00 → 05/06	
2.0 DI (F_E_, F_F_)	Diesel	63	08/00 → 05/06	
2.4 DI (F_A_, F_B_, F_C_, F_D_)	Diesel	66	01/00 → 05/06	
2.4 DI (F_A_, F_B_, F_C_, F_D_)	Diesel	88	01/00 → 05/06	

SAG007

H1 SENSORE GIRI / FASE - ALBERO MOTORE CRANKSHAFT POSITION SENSOR



FORD

ESCORT VI (GAL)

RS 2000 4x4	Petrol	110	08/93 → 01/95	
RS Cosworth 4x4	Petrol	162	09/92 → 01/95	

ESCORT VII (GAL, AAL, ABL)

RS 2000 4x4	Petrol	110	02/95 → 10/98	
RS Cosworth 4x4	Petrol	162	02/95 → 10/98	

GALAXY (WGR)

2.3 16V	Petrol	103	09/01 → 05/06	ENGINE: DOHC23
---------	--------	-----	---------------	----------------

SAG007

FORD
SCORPIO II (GFR, GGR)

2.0 i	Petrol	85	10/94 → 08/98	ENGINE: DOHC(8V)
2.0 i 16V	Petrol	100	10/94 → 08/98	

SCORPIO II Station wagon (GNR, GGR)

2.0 i	Petrol	85	10/94 → 08/98	ENGINE: DOHC(8V)
2.0 i 16V	Petrol	100	10/94 → 08/98	

TRANSIT Furgonato (E_ _)

2.0 (EAL, EAS)	Petrol	84	06/94 → 03/00	ENGINE: DOHC(8V)
----------------	--------	----	---------------	------------------

TRANSIT Pianale piatto/Telaio (E_ _)

2.0 (EME/L/S, ENE/L/S)	Petrol	84	08/94 → 03/00	ENGINE: DOHC(8V)
------------------------	--------	----	---------------	------------------

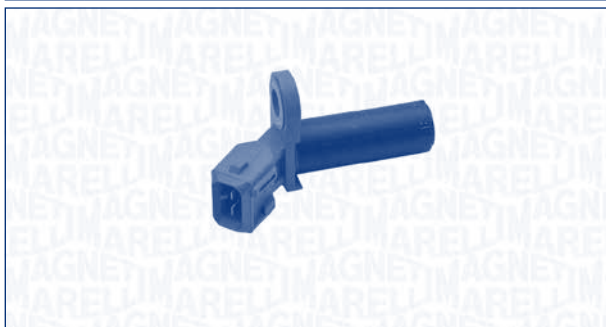
SAG008
H1 **SENSORE GIRI / FASE - ALBERO MOTORE**
CRANKSHAFT POSITION SENSOR

FORD
FIESTA IV (JA_ , JB_)

1.25 i 16V	Petrol	55	08/95 → 01/02	ENGINE: ZETEC-S
------------	--------	----	---------------	-----------------

FIESTA V (JH_ , JD_)

1.25 16V	Petrol	51	03/03 → 06/08	ENGINE: ZETEC-S
1.25 16V	Petrol	55	05/02 → 06/08	ENGINE: ZETEC-S
1.3	Petrol	44	11/01 → 06/08	ENGINE: ZETECROCAM13SOHC
1.3	Petrol	51	11/01 → 06/08	ENGINE: ZETECROCAM13SOHC
1.4 16V	Petrol	59	11/01 → 06/08	
1.6 16V	Petrol	74	11/01 → 06/08	

FOCUS C-MAX

1.6	Petrol	74	10/03 → 03/07	ENGINE: ZETEC-S
1.6 Ti	Petrol	85	08/04 → 03/07	ENGINE: ZETECROCAM16SOHC

FOCUS II (DA_)

1.4	Petrol	59	11/04 →	ENGINE: ZETECROCAM16SOHC
-----	--------	----	---------	--------------------------

SAG008

FORD
FOCUS II (DA_)

1.6	Petrol	74	11/04 →	ENGINE: ZETEC-S
1.6 Ti	Petrol	85	11/04 →	ENGINE: ZETECROCAM16SOHC

FOCUS II Station wagon (DA_)

1.4	Petrol	59	11/04 →	ENGINE: ZETEC-S
1.6	Petrol	74	11/04 →	ENGINE: ZETEC-S
1.6 Ti	Petrol	85	11/04 →	ENGINE: ZETECROCAM16SOHC

FOCUS II Tre volumi (DA_)

1.4	Petrol	59	04/05 →	ENGINE: ZETEC-S
1.6	Petrol	74	04/05 →	ENGINE: ZETEC-S
1.6 Ti	Petrol	85	04/05 →	ENGINE: ZETECROCAM16SOHC

FUSION (JU_)

1.25	Petrol	55	08/04 →	ENGINE: ZETEC-S
1.4	Petrol	59	08/02 →	ENGINE: ZETEC-S
1.6	Petrol	74	08/02 →	ENGINE: ZETEC-S

KA (RB_)

1.6 i	Petrol	70	07/03 → 11/08	ENGINE: ZETEC-S
-------	--------	----	---------------	-----------------

STREET KA (RL2)

1.6	Petrol	70	05/03 → 07/05	ENGINE: ZETEC-S
-----	--------	----	---------------	-----------------

SAG017
H1 **SENSORE GIRI / FASE - ALBERO MOTORE**
CRANKSHAFT POSITION SENSOR

AUDI
A4 (8D2, B5)

1.6	Petrol	75	07/00 → 11/00	
1.8 T	Petrol	110	10/95 → 11/00	
2.5 TDI	Diesel	110	09/97 → 11/00	
2.5 TDI quattro	Diesel	110	09/97 → 11/00	

SAG017



KW



AUDI

A4 (8E2, B6)

1.6	Petrol	75	11/00 → 12/04
1.8 T	Petrol	120	07/02 → 12/04
1.8 T	Petrol	140	11/02 → 12/04
1.8 T	Petrol	110	11/00 → 07/02
1.8 T quattro	Petrol	120	07/02 → 12/04
1.8 T quattro	Petrol	140	11/02 → 12/04
1.8 T quattro	Petrol	110	11/00 → 07/02
2.0	Petrol	96	11/00 → 12/04
2.5 TDI	Diesel	114	08/01 → 07/02
2.5 TDI	Diesel	120	07/02 → 12/04
2.5 TDI quattro	Diesel	132	11/00 → 12/04

A4 (8EC, B7)

1.6	Petrol	75	11/04 → 06/08
1.8 T	Petrol	120	11/04 → 06/08
1.8 T quattro	Petrol	120	11/04 → 06/08
2.0	Petrol	96	11/04 → 06/08
2.5 TDI	Diesel	120	11/04 → 05/06

A4 Avant (8D5, B5)

1.6	Petrol	75	07/00 → 09/01
1.8 T	Petrol	110	03/96 → 09/01
2.5 TDI	Diesel	110	09/97 → 09/01
2.5 TDI quattro	Diesel	110	09/97 → 09/01

A4 Avant (8E5, B6)

1.6	Petrol	75	09/01 → 12/04
1.8 T	Petrol	120	07/02 → 12/04
1.8 T	Petrol	140	11/02 → 12/04
1.8 T	Petrol	110	09/01 → 07/02
1.8 T quattro	Petrol	120	07/02 → 12/04
1.8 T quattro	Petrol	140	11/02 → 12/04
1.8 T quattro	Petrol	110	09/01 → 07/02
2.0	Petrol	96	09/01 → 12/04
2.5 TDI	Diesel	114	09/01 → 07/02
2.5 TDI	Diesel	120	07/02 → 12/04
2.5 TDI quattro	Diesel	132	09/01 → 12/04

A4 Avant (8ED, B7)

1.6	Petrol	75	11/04 → 06/08
1.8 T	Petrol	120	11/04 → 06/08
1.8 T quattro	Petrol	120	11/04 → 06/08
2.0	Petrol	96	11/04 → 06/08
2.5 TDI	Diesel	120	11/04 → 05/06

A4 Cabriolet (8H7, B6, 8HE, B7)

1.8 T	Petrol	120	07/02 → 03/09
1.8 T quattro	Petrol	120	05/03 → 03/09
2.0	Petrol	96	09/04 → 12/05

SAG017



KW



AUDI

A4 Cabriolet (8H7, B6, 8HE, B7)

2.5 TDI	Diesel	120	08/02 → 12/05
---------	--------	-----	---------------

A6 (4B2, C5)

1.8 T quattro	Petrol	110	02/97 → 01/05
2.5 TDI	Diesel	114	08/01 → 01/05
2.5 TDI	Diesel	120	07/02 → 01/05
2.5 TDI	Diesel	132	02/00 → 01/05
2.5 TDI	Diesel	110	07/97 → 01/05
2.5 TDI quattro	Diesel	132	02/00 → 01/05
2.5 TDI quattro	Diesel	110	07/97 → 01/05

2.7 T	Petrol	169	02/99 → 05/00	CHASSIS: → 4B1006637
-------	--------	-----	---------------	-------------------------

2.7 T quattro	Petrol	169	02/99 → 05/00	CHASSIS: → 4B1006637
---------------	--------	-----	---------------	-------------------------

A6 Avant (4B5, C5)

1.8 T	Petrol	110	12/97 → 01/05
1.8 T quattro	Petrol	110	12/97 → 01/05
2.5 TDI	Diesel	114	08/01 → 01/05
2.5 TDI	Diesel	120	07/02 → 01/05
2.5 TDI	Diesel	132	02/00 → 01/05
2.5 TDI	Diesel	110	12/97 → 01/05
2.5 TDI quattro	Diesel	132	02/00 → 01/05
2.5 TDI quattro	Diesel	110	12/97 → 01/05

2.7 T	Petrol	169	02/99 → 05/00	CHASSIS: → 4B1006637
-------	--------	-----	---------------	-------------------------

2.7 T quattro	Petrol	169	02/99 → 05/00	CHASSIS: → 4B1006637
---------------	--------	-----	---------------	-------------------------

A8 (4D2, 4D8)

2.5 TDI	Diesel	132	09/00 → 09/02
2.5 TDI quattro	Diesel	110	07/97 → 04/00

2.8	Petrol	142	05/97 → 09/02	CHASSIS: 4DV010966 →
-----	--------	-----	---------------	-------------------------

2.8 quattro	Petrol	142	05/97 → 09/02	CHASSIS: 4DV010966 →
-------------	--------	-----	---------------	-------------------------

ALLROAD (4BH, C5)

2.5 TDI quattro	Diesel	120	05/03 → 08/05
2.5 TDI quattro	Diesel	132	05/00 → 08/05

SEAT

EXEO (3R2)

1.6	Petrol	75	03/09 → 09/10
1.8 T	Petrol	110	12/08 → 05/10

EXEO ST (3R5)

1.6	Petrol	75	06/09 → 09/10
1.8 T	Petrol	110	06/09 → 05/10

SAG017

KW

SKODA
SUPERB (3U4)

1.8 T	Petrol	110	12/01 → 03/08
2.5 TDI	Diesel	114	12/01 → 08/03
2.5 TDI	Diesel	120	06/03 → 03/08

VOLKSWAGEN
PASSAT (3B2)

2.5 TDI	Diesel	110	07/98 → 11/00
2.5 TDI Syncro/4motion	Diesel	110	08/99 → 11/00

PASSAT (3B3)

1.6	Petrol	75	11/00 → 05/05
1.8 T 20V	Petrol	110	11/00 → 05/03
2.0	Petrol	96	11/01 → 05/05
2.5 TDI	Diesel	120	05/03 → 05/05
2.5 TDI	Diesel	110	11/00 → 05/03
2.5 TDI 4motion	Diesel	132	01/03 → 05/05
2.5 TDI 4motion	Diesel	110	11/00 → 05/03

PASSAT Variant (3B5)

2.5 TDI	Diesel	110	07/98 → 11/00
2.5 TDI Syncro/4motion	Diesel	110	12/98 → 11/00

PASSAT Variant (3B6)

1.6	Petrol	75	11/00 → 05/05
1.8 T 20V	Petrol	110	11/00 → 05/03
2.0	Petrol	96	11/01 → 05/05
2.5 TDI	Diesel	120	05/03 → 05/05
2.5 TDI	Diesel	110	11/00 → 05/03
2.5 TDI 4motion	Diesel	132	01/03 → 05/05
2.5 TDI 4motion	Diesel	110	11/00 → 05/03

SAG018
H1
**SENSORE GIRI / FASE - ALBERO MOTORE
CRANKSHAFT POSITION SENSOR**

KW

AUDI
A3 (8L1)

1.6	Petrol	75	08/00 → 05/03	CHASSIS: → 8LX090000
1.8 T	Petrol	132	07/99 → 04/02	CHASSIS: → 8L21050000
1.8 T quattro	Petrol	110	12/96 → 05/03	CHASSIS: → 8LX090000
1.8 T quattro	Petrol	132	10/98 → 05/03	
S3 quattro	Petrol	154	03/99 → 04/02	

A4 (8D2, B5)

1.6	Petrol	74	01/97 → 10/00	
2.4	Petrol	120	08/97 → 11/00	
2.4	Petrol	121	03/97 → 11/00	
2.4 quattro	Petrol	120	08/97 → 11/00	
2.4 quattro	Petrol	121	01/99 → 11/00	
2.8	Petrol	142	01/99 → 11/00	
2.8	Petrol	142	01/99 → 07/99	CHASSIS: 8DX200001 →
2.8 quattro	Petrol	142	01/99 → 08/01	
S4 quattro	Petrol	195	09/97 → 09/01	
3.0	Petrol	160	04/01 → 12/04	

A4 (8E2, B6)

3.0	Petrol	162	11/00 → 12/04	
3.0 quattro	Petrol	162	11/00 → 12/04	
3.0 quattro	Petrol	160	06/01 → 12/04	

A4 (8EC, B7)

3.0	Petrol	160	11/04 → 05/06	
3.0 quattro	Petrol	160	11/04 → 07/06	

A4 Avant (8D5, B5)

1.6	Petrol	74	01/97 → 09/01	
2.4	Petrol	120	08/97 → 09/01	
2.4	Petrol	121	01/99 → 09/01	
2.4 quattro	Petrol	120	08/97 → 09/01	
2.4 quattro	Petrol	121	01/99 → 09/01	

SAG018



KW



AUDI

A4 Avant (8D5, B5)

2.8	Petrol	142	01/99 → 09/01
2.8 quattro	Petrol	142	01/99 → 09/01
RS4 quattro	Petrol	280	05/00 → 09/01
S4 quattro	Petrol	195	09/97 → 09/00

A4 Avant (8E5, B6)

3.0	Petrol	162	09/01 → 12/04
3.0	Petrol	160	06/01 → 12/04
3.0 quattro	Petrol	162	09/01 → 12/04
3.0 quattro	Petrol	160	06/01 → 12/04

A4 Avant (8ED, B7)

3.0	Petrol	160	11/04 → 05/06
3.0 quattro	Petrol	160	11/04 → 07/06

A4 Cabriolet (8H7, B6, 8HE, B7)

3.0	Petrol	162	04/02 → 12/05
3.0 quattro	Petrol	162	05/03 → 12/05

A6 (4A, C4)

2.8	Petrol	142	12/95 → 10/97
2.8 quattro	Petrol	142	12/95 → 10/97

A6 (4B2, C5)

1.8	Petrol	92	07/97 → 01/05
2.4	Petrol	125	08/01 → 01/05
2.4	Petrol	100	07/98 → 01/05
2.4	Petrol	115	04/98 → 01/05
2.4	Petrol	120	02/97 → 12/99
2.4	Petrol	121	02/97 → 12/99
2.4 quattro	Petrol	115	08/98 → 07/99
2.4 quattro	Petrol	125	08/01 → 01/05
2.4 quattro	Petrol	120	02/97 → 12/99
2.4 quattro	Petrol	121	02/97 → 12/99
2.7 T	Petrol	169	02/99 → 01/05
2.7 T quattro	Petrol	169	01/99 → 01/05
2.7 T quattro	Petrol	184	08/01 → 01/05
2.8	Petrol	132	10/97 → 05/00
2.8	Petrol	140	07/99 → 01/05
2.8	Petrol	142	02/97 → 12/99
2.8 quattro	Petrol	140	07/99 → 05/01
2.8 quattro	Petrol	142	02/97 → 12/99
3.0	Petrol	162	08/01 → 01/05

A6 (4B2, C5)

3.0 quattro	Petrol	160	06/01 → 07/04
-------------	--------	-----	---------------

A6 (4B2, C5)

3.0 quattro	Petrol	162	08/01 → 01/05
-------------	--------	-----	---------------

SAG018



KW



AUDI

A6 Avant (4A, C4)

2.8	Petrol	142	12/95 → 12/97
2.8 quattro	Petrol	142	12/95 → 12/97

A6 Avant (4B5, C5)

1.8	Petrol	92	01/98 → 01/05
2.4	Petrol	125	08/01 → 01/05
2.4	Petrol	100	07/98 → 01/05
2.4	Petrol	115	04/98 → 01/05
2.4	Petrol	120	02/98 → 01/05
2.4	Petrol	121	12/97 → 01/05
2.4 quattro	Petrol	125	08/01 → 01/05
2.4 quattro	Petrol	115	08/98 → 05/01
2.4 quattro	Petrol	120	12/97 → 01/05
2.4 quattro	Petrol	121	01/98 → 12/99
2.7 T	Petrol	169	02/99 → 01/05
2.7 T quattro	Petrol	184	08/01 → 01/05
2.7 T quattro	Petrol	169	01/99 → 01/05
2.8	Petrol	132	12/97 → 05/00
2.8	Petrol	140	07/99 → 01/05
2.8	Petrol	142	12/97 → 01/05
2.8 quattro	Petrol	142	12/97 → 01/05
3.0	Petrol	162	08/01 → 01/05
3.0 quattro	Petrol	162	08/01 → 01/05

A8 (4D2, 4D8)

2.8	Petrol	142	04/96 → 09/02	CHASSIS: 4DV010966 →
2.8 quattro	Petrol	142	04/96 → 12/98	CHASSIS: 4DV010966 →

ALLROAD (4BH, C5)

2.7 T quattro	Petrol	184	05/00 → 08/05
---------------	--------	-----	---------------

TT (8N3)

1.8 T	Petrol	132	10/98 → 06/06
1.8 T quattro	Petrol	132	10/98 → 06/06
1.8 T quattro	Petrol	165	10/98 → 06/06

TT Roadster (8N9)

1.8 T	Petrol	132	10/99 → 06/06
1.8 T quattro	Petrol	132	02/00 → 06/06
1.8 T quattro	Petrol	165	10/99 → 06/06

SEAT

ALHAMBRA (7V8, 7V9)

1.8 T 20V	Petrol	110	05/98 → 03/10
-----------	--------	-----	---------------

LEON (1M1)

1.6	Petrol	74	11/99 → 06/06
1.8 20V	Petrol	92	11/99 → 06/06
1.8 20V T	Petrol	132	11/99 → 06/06

SAG018

KW

SEAT
LEON (1M1)

1.8 20V T 4 Petrol 132 03/00 → 06/06

TOLEDO II (1M2)

1.6 Petrol 74 04/99 → 09/00

1.8 20V Petrol 92 04/99 → 05/06

1.8 20VT Petrol 132 05/01 → 05/06

SKODA
FABIA (6Y2)

 2.0 Petrol 85 12/99 → 09/01 CHASSIS:
→ 6Y2389395

FABIA Combi (6Y5)

 2.0 Petrol 85 04/00 → 09/01 CHASSIS:
→ 6Y2389395

FABIA Tre volumi (6Y3)

 2.0 Petrol 85 12/99 → 09/01 CHASSIS:
→ 6Y2389395

OCTAVIA (1U2)

1.8 T Petrol 110 01/99 → 12/10

1.8 T 4x4 Petrol 110 05/01 → 05/06

2.0 Petrol 85 04/99 → 10/06

OCTAVIA Combi (1U5)

1.6 Petrol 74 07/98 → 12/07

1.8 20V Petrol 92 07/98 → 07/00

1.8 T Petrol 110 01/99 → 12/10

1.8 T 4x4 Petrol 110 05/01 → 05/06

2.0 Petrol 85 04/99 → 10/06

2.0 4x4 Petrol 85 08/00 → 09/04

2.0 4x4 Petrol 88 01/00 → 12/10

SUPERB (3U4)

2.0 Petrol 85 12/01 → 03/08

2.8 V6 Petrol 142 12/01 → 03/08

VOLKSWAGEN
BORA (1J2)

1.6 Petrol 74 10/98 → 05/05

1.8 Petrol 92 02/99 → 05/05

1.8 4motion Petrol 92 02/99 → 05/05

2.0 Petrol 85 10/98 → 05/05

2.0 4motion Petrol 85 04/00 → 12/02

BORA Station wagon (1J6)

1.6 Petrol 74 05/99 → 05/05

1.8 4motion Petrol 92 05/99 → 05/05

2.0 Petrol 85 05/99 → 05/05

2.0 4motion Petrol 85 04/00 → 12/02

SAG018

KW

VOLKSWAGEN
GOLF IV (1J1)

1.6 Petrol 74 10/97 → 05/04

1.8 Petrol 92 10/97 → 06/05

1.8 4motion Petrol 92 05/00 → 06/05

1.8 T Petrol 110 08/97 → 06/05

2.0 Petrol 85 07/98 → 05/04

2.0 4motion Petrol 85 10/00 → 06/05

GOLF IV Variant (1J5)

1.6 Petrol 74 05/99 → 04/02

1.8 4motion Petrol 92 05/99 → 06/06

1.8 T Petrol 110 05/00 → 06/06

2.0 Petrol 85 05/99 → 06/06

2.0 4motion Petrol 85 10/00 → 06/06

NEW BEETLE (9C1, 1C1)

1.8 T Petrol 110 10/99 → 09/10

 2.0 Petrol 85 01/98 → 09/10 CHASSIS:
→ 9CX999000

NEW BEETLE Cabriolet (1Y7)

1.8 T Petrol 110 01/03 → 09/10

PASSAT (3B2)

2.8 V6 Petrol 132 05/97 → 09/99

2.8 V6 Petrol 140 09/99 → 11/00

PASSAT (3B3)

2.0 Petrol 85 11/00 → 03/05

2.0 4motion Petrol 85 11/00 → 05/05

2.8 4motion Petrol 142 11/00 → 05/05

PASSAT Variant (3B5)

2.8 V6 Petrol 132 09/97 → 09/99

 2.8 V6
Syncro/4motion Petrol 142 06/97 → 11/00

PASSAT Variant (3B6)

2.0 Petrol 85 11/00 → 05/05

2.0 4motion Petrol 85 11/00 → 05/05

2.8 4motion Petrol 142 11/00 → 05/05

POLO CLASSIC (6KV2)

100 1.6 Petrol 74 05/96 → 09/01

POLO Variant (6KV5)

1.6 Petrol 74 05/97 → 09/01

SHARAN (7M8, 7M9, 7M6)

1.8 T 20V Petrol 110 11/97 → 03/10

SAG019

H1 **SENSORE GIRI / FASE - ALBERO MOTORE**
CRANKSHAFT POSITION SENSOR



OPEL

AGILA (A) (H00)

1.0	Petrol	44	08/03 → 12/07
1.0 12V	Petrol	43	09/00 → 08/03
1.2 16V	Petrol	55	09/00 → 06/04
1.2 16V Twinport	Petrol	59	07/04 → 12/07

ASTRA G 2 volumi /Coda spiovente (F48_, F08_)

1.2 16V	Petrol	48	02/98 → 09/00
1.2 16V	Petrol	55	09/00 → 09/03

ASTRA G Station wagon (F35_)

1.2 16V	Petrol	48	02/98 → 09/00
1.2 16V	Petrol	55	09/00 → 09/03

ASTRA G Tre volumi (F69_)

1.2 16V	Petrol	48	09/98 → 09/00
1.2 16V	Petrol	55	09/00 → 09/03

ASTRA H (L48)

1.4	Petrol	66	03/04 →
-----	--------	----	---------

ASTRA H GTC (L08)

1.4	Petrol	66	03/05 →
-----	--------	----	---------

ASTRA H Station wagon (L35)

1.4	Petrol	66	08/04 →
-----	--------	----	---------

COMBO Cassone / Furgonato / Promiscuo

1.4 16V	Petrol	66	08/05 →
---------	--------	----	---------

COMBO Tour

1.4	Petrol	66	10/04 →
-----	--------	----	---------

CORSA B (73_, 78_, 79_)

1.2 i 16V	Petrol	48	03/98 → 09/00
-----------	--------	----	---------------

CORSA C (F08, F68)

1.0	Petrol	43	09/00 → 08/03
1.0	Petrol	44	06/03 → 12/09
1.2	Petrol	55	09/00 → 06/04
1.2 Twinport	Petrol	59	07/04 → 12/09
1.4 Twinport	Petrol	66	09/03 → 12/09

SAG019



OPEL

CORSA C Furgonato (F08, W5L)

1.2	Petrol	59	07/05 →
1.2 16V	Petrol	55	09/00 →

MERIVA

1.4 16V Twinport	Petrol	66	09/04 → 05/10
------------------	--------	----	---------------

TIGRA TwinTop

1.4	Petrol	66	09/04 →
-----	--------	----	---------

VAUXHALL

AGILA Mk I (A)

1.0 12V	Petrol	43	09/00 → 08/05
1.0 12V	Petrol	44	02/00 → 11/06
1.2 16V	Petrol	55	09/00 → 03/08
1.2 16V Twinport	Petrol	59	07/04 → 11/06

ASTRA Mk IV (G) 2 volumi /Coda spiovente

1.2 16V	Petrol	48	02/98 → 09/00
1.2 16V	Petrol	55	09/00 → 05/05

ASTRA Mk IV (G) Station wagon

1.2 16V	Petrol	48	02/98 → 09/00
1.2 16V	Petrol	55	09/00 → 05/05

ASTRA Mk IV (G) Tre volumi

1.2 16V	Petrol	48	09/98 → 09/00
1.2 16V	Petrol	55	09/00 → 05/05

ASTRA Mk V (H) 2 volumi /Coda spiovente

1.4	Petrol	66	01/04 → 05/09
-----	--------	----	---------------

ASTRA Mk V (H) Station wagon

1.4	Petrol	66	08/04 → 03/09
-----	--------	----	---------------

COMBO Mk II (C) Cassone / Furgonato / Promiscuo (F25)

1.4 i 16V	Petrol	66	09/04 → 11/11
-----------	--------	----	---------------

CORSA Mk I (B)

1.2 i 16V	Petrol	48	03/98 → 09/00
-----------	--------	----	---------------

CORSA Mk II (C) (W5L, F08)

1.0 12V	Petrol	43	09/00 → 08/03
1.2 16V	Petrol	55	09/00 → 06/04
1.2 16V Dualfuel	Petrol/ LPG	55	08/01 → 06/04

CORSAVAN Mk II (C)

1.2 16V	Petrol	55	09/00 → 08/04
---------	--------	----	---------------

1.2 16V Dualfuel	Petrol/ LPG	55	08/01 → 08/04
------------------	----------------	----	---------------

TIGRA TwinTop

1.4	Petrol	66	09/04 → 08/09
-----	--------	----	---------------

SAG020
H1 **SENSORE GIRI / FASE - ALBERO MOTORE**
CRANKSHAFT POSITION SENSOR

KW

OPEL
ASTRA G 2 volumi /Coda spiovente (F48_, F08_)

1.4 16V	Petrol	66	02/98 → 01/05
1.6	Petrol	62	09/00 → 01/05
1.6	Petrol	76	12/02 → 12/09
1.6 16V	Petrol	74	02/98 → 01/05

ASTRA G Cabriolet (F67)

1.6	Petrol	76	01/03 → 10/05
1.6 16V	Petrol	74	03/01 → 10/05

ASTRA G Coupé (F07_)

1.6 16V	Petrol	76	10/03 → 05/05
---------	--------	----	---------------

ASTRA G Furgonato (F70)

1.6	Petrol	62	09/00 → 04/05
-----	--------	----	---------------

ASTRA G Station wagon (F35_)

1.4 16V	Petrol	66	06/98 → 07/04
1.6	Petrol	62	09/00 → 07/04
1.6	Petrol	76	12/02 → 07/09
1.6 16V	Petrol	74	02/98 → 07/04
1.6 CNG	Petrol/ CNG	71	03/03 → 07/04

ASTRA G Tre volumi (F69_)

1.4 16V	Petrol	66	09/98 → 01/05
1.6	Petrol	62	09/00 → 01/05
1.6	Petrol	76	12/02 → 12/09
1.6 16V	Petrol	74	09/98 → 01/05

ASTRA H (L48)

1.6	Petrol	77	03/04 →
-----	--------	----	---------

ASTRA H GTC (L08)

1.6	Petrol	77	03/05 →
-----	--------	----	---------

ASTRA H Station wagon (L35)

1.6	Petrol	77	08/04 →
-----	--------	----	---------

ASTRA H TwinTop (L67)

1.6	Petrol	77	09/05 →
-----	--------	----	---------

SAG020

KW

OPEL
COMBO Cassone / Furgonato / Promiscuo

1.6	Petrol	64	10/01 →
1.6 CNG 16V	Petrol/ CNG	69	06/06 →
1.6 CNG 16V	Petrol/ CNG	71	04/05 →

COMBO Tour

1.6	Petrol	64	10/01 →
1.6 CNG	Petrol/ CNG	69	06/06 →
1.6 CNG	Petrol/ CNG	71	04/05 →

CORSA C (F08, F68)

1.4	Petrol	66	09/00 → 12/09
-----	--------	----	---------------

MERIVA

1.6	Petrol	64	05/03 → 05/10
1.6	Petrol	77	01/06 → 05/10
1.6 16V	Petrol	74	05/03 → 01/06

VECTRA B (36_)

1.6 i 16V	Petrol	74	10/95 → 04/02
-----------	--------	----	---------------

VECTRA B 2 volumi /Coda spiovente (38_)

1.6 i 16V	Petrol	74	10/95 → 07/02
-----------	--------	----	---------------

VECTRA C

1.6	Petrol	77	01/06 →
1.6 16V	Petrol	74	06/04 →

VECTRA C GTS

1.6	Petrol	77	01/06 →
1.6	Petrol	74	08/05 →

VECTRA C Station wagon

1.6	Petrol	77	10/06 →
1.6 16V	Petrol	74	06/04 →

ZAFIRA A (F75_)

1.6 16V	Petrol	74	04/99 → 06/05
1.6 CNG	Petrol/ CNG	71	09/01 → 06/05

ZAFIRA B (A05)

1.6	Petrol	77	07/05 →
1.6 CNG	Petrol/ CNG	69	01/06 →

VAUXHALL
ASTRA Mk IV (G) 2 volumi /Coda spiovente

1.4 16V	Petrol	66	02/98 → 05/05
1.6	Petrol	62	09/00 → 05/05
1.6 16V	Petrol	74	02/98 → 05/05

SAG020



KW



VAUXHALL

ASTRA Mk IV (G) 2 volumi /Coda spiovente

1.6 Dualfuel	Petrol/ LPG	63	09/02 → 05/05
--------------	----------------	----	---------------

ASTRA Mk IV (G) Cabriolet

1.6 16V	Petrol	74	03/01 → 10/05
---------	--------	----	---------------

ASTRA Mk IV (G) Station wagon

1.4 16V	Petrol	66	02/98 → 05/05
---------	--------	----	---------------

1.6	Petrol	62	03/98 → 04/04
-----	--------	----	---------------

1.6 16V	Petrol	74	03/98 → 04/04
---------	--------	----	---------------

1.6 Dualfuel	Petrol/ LPG	63	03/98 → 04/04
--------------	----------------	----	---------------

ASTRA Mk IV (G) Tre volumi

1.4 16V	Petrol	66	09/98 → 05/05
---------	--------	----	---------------

1.6	Petrol	62	09/00 → 05/05
-----	--------	----	---------------

1.6 16V	Petrol	74	09/98 → 05/05
---------	--------	----	---------------

1.6 Dualfuel	Petrol/ LPG	63	09/02 → 05/05
--------------	----------------	----	---------------

ASTRA Mk V (H) 2 volumi /Coda spiovente

1.6	Petrol	77	01/04 → 05/09
-----	--------	----	---------------

ASTRA Mk V (H) Sport Hatch

1.6	Petrol	77	02/05 → 11/10
-----	--------	----	---------------

ASTRA Mk V (H) Station wagon

1.6	Petrol	77	08/04 → 03/09
-----	--------	----	---------------

ASTRA TwinTop Mk V (H)

1.6	Petrol	77	02/06 → 11/10
-----	--------	----	---------------

ASTRAVAN Mk IV (G)

1.6 i	Petrol	62	09/00 → 08/06
-------	--------	----	---------------

1.6	Petrol	76	03/05 →
-----	--------	----	---------

COMBO Mk II (C) Cassone / Furgonato / Promiscuo (F25)

1.6	Petrol	62	08/01 → 10/04
-----	--------	----	---------------

1.6	Petrol	64	10/01 → 11/11
-----	--------	----	---------------

CORSA Mk II (C) (W5L, F08)

1.4 16V	Petrol	66	09/00 → 10/06
---------	--------	----	---------------

MERIVA Mk I (A)

1.6 i	Petrol	64	01/03 → 06/10
-------	--------	----	---------------

1.6 i 16V	Petrol	74	01/03 → 09/05
-----------	--------	----	---------------

1.6 i 16V Twinport	Petrol	77	04/06 → 06/10
--------------------	--------	----	---------------

VECTRA (B)

1.6 i 16V	Petrol	74	08/95 → 10/01
-----------	--------	----	---------------

VECTRA (B) 2 volumi /Coda spiovente

1.6 i 16V	Petrol	74	08/95 → 10/01
-----------	--------	----	---------------

VECTRA (B) Station wagon

1.6 i 16V	Petrol	74	11/96 → 03/02
-----------	--------	----	---------------

SAG020



KW



VAUXHALL

VECTRA Mk II (C)

1.6	Petrol	77	01/06 → 07/08
-----	--------	----	---------------

1.6 16V	Petrol	74	06/04 → 07/08
---------	--------	----	---------------

VECTRA Mk II (C) GTS

1.6	Petrol	77	01/06 → 07/08
-----	--------	----	---------------

1.6 16V	Petrol	74	08/05 → 07/08
---------	--------	----	---------------

VECTRA Mk II (C) Station wagon

1.6 16V	Petrol	74	06/04 → 07/08
---------	--------	----	---------------

ZAFIRA Mk I (A) (F75)

1.6 16V	Petrol	74	04/99 → 08/05
---------	--------	----	---------------

1.6 CNG	Petrol/ CNG	71	09/01 → 06/05
---------	----------------	----	---------------

ZAFIRA Mk II (B) (M75)

1.6	Petrol	77	07/05 →
-----	--------	----	---------

SAG021

H1

**SENSORE GIRI / FASE - ALBERO MOTORE
CRANKSHAFT POSITION SENSOR**



KW



OPEL

ASTRA G 2 volumi /Coda spiovente (F48_, F08_)

2.0 DI	Diesel	60	02/98 → 01/05	CHASSIS: →38999999
--------	--------	----	---------------	--------------------

2.0 DTI 16V	Diesel	74	08/99 → 01/05	CHASSIS: →38999999
-------------	--------	----	---------------	--------------------

2.2 DTI	Diesel	92	09/02 → 01/05	CHASSIS: →38999999
---------	--------	----	---------------	--------------------

ASTRA G Cabriolet (F67)

2.2 DTI	Diesel	92	09/02 → 10/05	CHASSIS: →38999999
---------	--------	----	---------------	--------------------

ASTRA G Coupé (F07_)

2.2 DTI	Diesel	92	09/02 → 05/05	CHASSIS: →38999999
---------	--------	----	---------------	--------------------

ASTRA G Furgonato (F70)

2.0 DI	Diesel	60	01/99 → 04/05	CHASSIS: →38999999
--------	--------	----	---------------	--------------------

ASTRA G Station wagon (F35_)

2.0 DI	Diesel	60	02/98 → 07/04	CHASSIS: →38999999
--------	--------	----	---------------	--------------------

2.0 DTI 16V	Diesel	74	08/99 → 07/04	CHASSIS: →38999999
-------------	--------	----	---------------	--------------------

2.2 DTI	Diesel	92	09/02 → 07/04	CHASSIS: →38999999
---------	--------	----	---------------	--------------------

SAG021

OPEL
ASTRA G Tre volumi (F69_)

2.0 DI	Diesel	60	09/98 → 01/05	CHASSIS: → 38999999
2.0 DTI 16V	Diesel	74	08/99 → 01/05	CHASSIS: → 38999999
2.2 DTI	Diesel	92	09/02 → 01/05	CHASSIS: → 38999999

FRONTERA B (6B_)

2.2 DTI (6B_ZC, 6B_VF, 6B_66, 6B_76)	Diesel	85	10/98 → 09/02	
--------------------------------------	--------	----	---------------	--

OMEGA B (25_, 26_, 27_)

2.0 DTI 16V	Diesel	74	09/97 → 09/00	
2.2 DTI 16V	Diesel	81	09/00 → 07/03	
2.2 DTI 16V	Diesel	88	09/00 → 07/03	

OMEGA B Station wagon (21_, 22_, 23_)

2.0 DTI 16V	Diesel	74	09/97 → 09/00	
2.2 DTI 16V	Diesel	81	09/00 → 07/03	
2.2 DTI 16V	Diesel	88	09/00 → 07/03	

SIGNUM

2.0 DTI	Diesel	74	05/03 →	ENGINE: → 17G23740
2.2 DTI	Diesel	92	05/03 →	ENGINE: → 17G23740
2.2 DTI	Diesel	92	05/03 →	ENGINE: → 17G23740

SINTR A

2.2 DTI	Diesel	85	07/97 → 04/99	
---------	--------	----	---------------	--

VECTRA B (36_)

2.0 DTI 16V	Diesel	74	06/97 → 04/02	
2.2 DTI 16V	Diesel	92	09/00 → 04/02	

VECTRA B 2 volumi /Coda spiovente (38_)

2.0 DTI 16V	Diesel	74	06/97 → 07/03	
2.2 DTI 16V	Diesel	92	09/00 → 07/03	

VECTRA B Station wagon (31_)

2.0 DTI 16V	Diesel	74	06/97 → 07/03	
2.2 DTI 16V	Diesel	92	09/00 → 07/03	

VECTRA C

2.0 DTI 16V	Diesel	74	04/02 →	ENGINE: → 17G23740
2.2 DTI 16V	Diesel	92	04/02 →	ENGINE: → 17G23740

VECTRA C GTS

2.0 DTI 16V	Diesel	74	08/02 →	ENGINE: → 17G23740
2.2 DTI 16V	Diesel	92	08/02 →	ENGINE: → 17G23740

VECTRA C Station wagon

2.0 DTI	Diesel	74	10/03 →	ENGINE: → 17G23740
2.2 DTI	Diesel	92	10/03 →	ENGINE: → 17G23740

ZAFIRA A (F75_)

2.0 DI 16V	Diesel	60	10/99 → 06/05	CHASSIS: → 38999999
2.0 DTI 16V	Diesel	74	09/00 → 06/05	CHASSIS: → 38999999
2.2 DTI 16V	Diesel	92	01/02 → 06/05	CHASSIS: → 38999999

SAG021

SAAB
9-3 (YS3D)

2.2 TiD	Diesel	85	02/98 → 11/00	
2.2 TiD	Diesel	92	11/00 → 09/02	

9-3 (YS3F)

2.2 TiD	Diesel	92	09/02 →	
---------	--------	----	---------	--

9-5 (YS3E)

2.2 TiD	Diesel	88	03/02 →	
---------	--------	----	---------	--

9-5 Station wagon (YS3E)

2.2 TiD	Diesel	88	03/02 →	
---------	--------	----	---------	--

VAUXHALL
ASTRA Mk IV (G) 2 volumi /Coda spiovente

2.0 DI	Diesel	60	02/98 → 05/05	CHASSIS: → 38999999
2.0 DTI 16V	Diesel	74	08/99 → 05/05	CHASSIS: → 38999999

ASTRA Mk IV (G) Station wagon

2.0 DI	Diesel	60	03/98 → 04/04	CHASSIS: → 38999999
2.0 DTI 16V	Diesel	74	03/98 → 04/04	CHASSIS: → 38999999

ASTRA Mk IV (G) Tre volumi

2.0 DI	Diesel	60	02/98 → 07/04	CHASSIS: → 38999999
2.0 DTI 16V	Diesel	74	02/98 → 07/04	CHASSIS: → 38999999

FRONTERA Mk II (B)

2.2 DTI	Diesel	85	10/98 → 09/04	
---------	--------	----	---------------	--

OMEGA (B)

2.0 DTI 16V	Diesel	74	01/98 → 09/00	
2.2 DTI 16V	Diesel	88	08/00 → 07/03	

OMEGA (B) Station wagon

2.0 DTI 16V	Diesel	74	01/98 → 09/00	
2.2 DTI 16V	Diesel	88	08/00 → 06/03	

SIGNUM

2.0 DTI	Diesel	74	05/03 → 05/08	ENGINE: → 17G23740
2.2 DTI	Diesel	92	05/03 → 05/08	ENGINE: → 17G23740

SINTR A

2.2 DTI	Diesel	85	07/97 → 04/99	
---------	--------	----	---------------	--

VECTRA (B)

2.0 DI 16V	Diesel	60	08/95 → 10/01	
2.0 DTI 16V	Diesel	74	08/95 → 10/01	
2.2 DTI 16V	Diesel	92	08/95 → 10/01	

VECTRA (B) 2 volumi /Coda spiovente

2.0 DI 16V	Diesel	60	08/95 → 10/01	
2.0 DTI 16V	Diesel	74	06/97 → 10/01	
2.2 DTI 16V	Diesel	92	08/95 → 10/01	

VECTRA (B) Station wagon

2.0 DI 16V	Diesel	60	08/95 → 10/01	
2.0 DTI 16V	Diesel	74	08/95 → 10/01	
2.2 DTI 16V	Diesel	92	08/95 → 10/01	

SAG021



KW



VAUXHALL

VECTRA Mk II (C)

2.0 DTI 16V	Diesel	74	04/02 → 10/08	ENGINE: → 17G23740
2.2 DTI 16V	Diesel	92	04/02 → 10/08	ENGINE: → 17G23740

VECTRA Mk II (C) GTS

2.0 DTI 16V	Diesel	74	08/02 → 07/08	ENGINE: → 17G23740
2.2 DTI 16V	Diesel	92	08/02 → 07/08	ENGINE: → 17G23740

VECTRA Mk II (C) Station wagon

2.0 DTI 16V	Diesel	74	10/03 → 07/08	ENGINE: → 17G23740
2.2 DTI 16V	Diesel	92	10/03 → 07/08	ENGINE: → 17G23740

ZAFIRA Mk I (A) (F75)

2.0 DI 16V	Diesel	60	10/99 → 08/05	CHASSIS: → 38999999
2.0 DTI 16V	Diesel	74	04/99 → 08/05	CHASSIS: → 38999999

SAG021-1

H1

**SENSORE GIRI / FASE - ALBERO MOTORE
CRANKSHAFT POSITION SENSOR**



KW



OPEL

ASTRA G 2 volumi /Coda spiovente (F48_, F08_)

2.0 DI	Diesel	60	02/98 → 01/05	CHASSIS: → 38999999
2.0 DTI 16V	Diesel	74	08/99 → 01/05	CHASSIS: → 38999999
2.2 DTI	Diesel	92	09/02 → 01/05	CHASSIS: → 38999999

ASTRA G Cabriolet (F67)

2.2 DTI	Diesel	92	09/02 → 10/05	CHASSIS: → 38999999
---------	--------	----	---------------	---------------------

ASTRA G Coupé (F07_)

2.2 DTI	Diesel	92	09/02 → 05/05	CHASSIS: → 38999999
---------	--------	----	---------------	---------------------

ASTRA G Furgonato (F70)

2.0 DI	Diesel	60	01/99 → 04/05	CHASSIS: → 38999999
--------	--------	----	---------------	---------------------

ASTRA G Station wagon (F35_)

2.0 DI	Diesel	60	02/98 → 07/04	CHASSIS: → 38999999
2.0 DTI 16V	Diesel	74	08/99 → 07/04	CHASSIS: → 38999999
2.2 DTI	Diesel	92	09/02 → 07/04	CHASSIS: → 38999999

ASTRA G Tre volumi (F69_)

2.0 DI	Diesel	60	09/98 → 01/05	CHASSIS: → 38999999
2.0 DTI 16V	Diesel	74	08/99 → 01/05	CHASSIS: → 38999999

SAG021-1



KW



OPEL

ASTRA G Tre volumi (F69_)

2.2 DTI	Diesel	92	09/02 → 01/05	CHASSIS: → 38999999
---------	--------	----	---------------	---------------------

FRONTERA B (6B_)

2.2 DTI (6B_ZC, 6B_VF, 6B_66, 6B_76)	Diesel	85	10/98 → 09/02	
--------------------------------------	--------	----	---------------	--

OMEGA B (25_, 26_, 27_)

2.0 DTI 16V	Diesel	74	09/97 → 09/00	
2.2 DTI 16V	Diesel	81	09/00 → 07/03	
2.2 DTI 16V	Diesel	88	09/00 → 07/03	

OMEGA B Station wagon (21_, 22_, 23_)

2.0 DTI 16V	Diesel	74	09/97 → 09/00	
2.2 DTI 16V	Diesel	81	09/00 → 07/03	
2.2 DTI 16V	Diesel	88	09/00 → 07/03	

SIGNUM

2.0 DTI	Diesel	74	05/03 →	ENGINE: → 17G23740
2.2 DTI	Diesel	92	05/03 →	ENGINE: → 17G23740

SINTRA

2.2 DTI	Diesel	85	07/97 → 04/99	
---------	--------	----	---------------	--

VECTRA B (36_)

2.0 DTI 16V	Diesel	74	06/97 → 04/02	
2.2 DTI 16V	Diesel	92	09/00 → 04/02	

VECTRA B 2 volumi /Coda spiovente (38_)

2.0 DTI 16V	Diesel	74	06/97 → 07/03	
2.2 DTI 16V	Diesel	92	09/00 → 07/03	

VECTRA B Station wagon (31_)

2.0 DTI 16V	Diesel	74	06/97 → 07/03	
2.2 DTI 16V	Diesel	92	09/00 → 07/03	

VECTRA C

2.0 DTI 16V	Diesel	74	04/02 →	ENGINE: → 17G23740
2.2 DTI 16V	Diesel	92	04/02 →	ENGINE: → 17G23740

VECTRA C GTS

2.0 DTI 16V	Diesel	74	08/02 →	ENGINE: → 17G23740
2.2 DTI 16V	Diesel	92	08/02 →	ENGINE: → 17G23740

VECTRA C Station wagon

2.0 DTI	Diesel	74	10/03 →	ENGINE: → 17G23740
2.2 DTI	Diesel	92	10/03 →	ENGINE: → 17G23740

ZAFIRA A (F75_)

2.0 DI 16V	Diesel	60	10/99 → 06/05	CHASSIS: → 38999999
2.0 DTI 16V	Diesel	74	09/00 → 06/05	CHASSIS: → 38999999
2.2 DTI 16V	Diesel	92	01/02 → 06/05	CHASSIS: → 38999999

SAAB

9-3 (YS3D)

2.2 TiD	Diesel	85	02/98 → 11/00	
2.2 TiD	Diesel	92	11/00 → 09/02	

SAG021-1

SAAB
9-3 (YS3F)

2.2 TiD Diesel 92 09/02 →

9-5 (YS3E)

2.2 TiD Diesel 88 03/02 →

9-5 Station wagon (YS3E)

2.2 TiD Diesel 88 03/02 →

VAUXHALL
ASTRA Mk IV (G) 2 volumi /Coda spiovente

2.0 DI Diesel 60 02/98 → 05/05 CHASSIS: →38999999

2.0 DTI 16V Diesel 74 08/99 → 05/05 CHASSIS: →38999999

ASTRA Mk IV (G) Station wagon

2.0 DI Diesel 60 03/98 → 04/04 CHASSIS: →38999999

2.0 DTI 16V Diesel 74 03/98 → 04/04 CHASSIS: →38999999

ASTRA Mk IV (G) Tre volumi

2.0 DI Diesel 60 02/98 → 07/04 CHASSIS: →38999999

2.0 DTI 16V Diesel 74 02/98 → 07/04 CHASSIS: →38999999

FRONTERA Mk II (B)

2.2 DTI Diesel 85 10/98 → 09/04

OMEGA (B)

2.0 DTI 16V Diesel 74 01/98 → 09/00

2.2 DTI 16V Diesel 88 08/00 → 07/03

OMEGA (B) Station wagon

2.0 DTI 16V Diesel 74 01/98 → 09/00

2.2 DTI 16V Diesel 88 08/00 → 06/03

SIGNUM

2.0 DTI Diesel 74 05/03 → 05/08 ENGINE: →17G23740

2.2 DTI Diesel 92 05/03 → 05/08 ENGINE: →17G23740

SINTRA

2.2 DTI Diesel 85 07/97 → 04/99

VECTRA (B)

2.0 DI 16V Diesel 60 08/95 → 10/01

2.0 DTI 16V Diesel 74 08/95 → 10/01

2.2 DTI 16V Diesel 92 08/95 → 10/01

VECTRA (B) 2 volumi /Coda spiovente

2.0 DI 16V Diesel 60 08/95 → 10/01

2.0 DTI 16V Diesel 74 06/97 → 10/01

2.2 DTI 16V Diesel 92 08/95 → 10/01

VECTRA (B) Station wagon

2.0 DI 16V Diesel 60 08/95 → 10/01

2.0 DTI 16V Diesel 74 08/95 → 10/01

2.2 DTI 16V Diesel 92 08/95 → 10/01

VECTRA Mk II (C)

2.0 DTI 16V Diesel 74 04/02 → 10/08 ENGINE: →17G23740

2.2 DTI 16V Diesel 92 04/02 → 10/08 ENGINE: →17G23740

SAG021-1

VAUXHALL
VECTRA Mk II (C) GTS

2.0 DTI 16V Diesel 74 08/02 → 07/08 ENGINE: →17G23740

2.2 DTI 16V Diesel 92 08/02 → 07/08 ENGINE: →17G23740

VECTRA Mk II (C) Station wagon

2.0 DTI 16V Diesel 74 10/03 → 07/08 ENGINE: →17G23740

2.2 DTI 16V Diesel 92 10/03 → 07/08 ENGINE: →17G23740

ZAFIRA Mk I (A) (F75)

2.0 DI 16V Diesel 60 10/99 → 08/05 CHASSIS: →38999999

2.0 DTI 16V Diesel 74 04/99 → 08/05 CHASSIS: →38999999

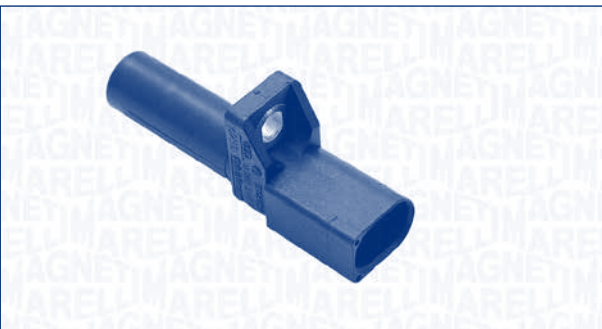
SAG023
H1 **SENSORE GIRI / FASE - ALBERO MOTORE**
CRANKSHAFT POSITION SENSOR

MERCEDES-BENZ
CLASSE A (W168)

A 140 (168.031, 168.131) Petrol 60 01/01 → 08/04

A 140 (168.031, 168.131) Petrol 60 05/98 → 08/04 ENGINE: 30040047 →

A 160 (168.033, 168.133) Petrol 75 07/97 → 08/04 ENGINE: 30040047 →

A 160 CDI (168.006) Diesel 55 02/01 → 08/04

A 160 CDI (168.007) Diesel 44 07/98 → 02/01

A 170 CDI (168.008) Diesel 66 07/98 → 02/01

A 170 CDI (168.009, 168.109) Diesel 70 02/01 → 08/04

A 190 (168.032, 168.132) Petrol 92 03/99 → 08/04

A 210 (168.035, 168.135) Petrol 103 03/02 → 08/04 ENGINE: 30045255 →

SAG023



KW



MERCEDES-BENZ

CLASSE A (W169)

A 150 (169.031, 169.331)	Petrol	70	09/04 → 06/12
A 160 (169.031, 169.331)	Petrol	70	04/09 → 06/12
A 160 CDI (169.006, 169.306)	Diesel	60	09/04 → 06/12
A 170 (169.032, 169.332)	Petrol	85	09/04 → 06/12
A 180 (169.032, 169.332)	Petrol	85	04/09 → 06/12
A 180 CDI (169.007, 169.307)	Diesel	80	09/04 → 06/12
A 200 (169.033, 169.333)	Petrol	100	09/04 → 06/12
A 200 CDI (169.008, 169.308)	Diesel	103	09/04 → 06/12
A 200 TURBO (169.034, 169.334)	Petrol	142	09/05 → 06/12

CLASSE B (W245)

B 150 (245.231)	Petrol	70	03/05 → 11/11
B 160 (245.231)	Petrol	70	04/09 → 11/11
B 170 (245.232)	Petrol	85	03/05 → 11/11
B 170 NGT (245.233)	BiFuel	85	04/08 → 11/11
B 180 (245.232)	Petrol	85	04/09 → 11/11
B 180 CDI (245.207)	Diesel	80	03/05 → 11/11
B 180 NGT (245.233)	BiFuel	85	04/08 → 11/11
B 200 (245.233)	Petrol	100	03/05 → 11/11
B 200 CDI (245.208)	Diesel	103	03/05 → 11/11
B 200 TURBO (245.234)	Petrol	142	03/05 → 11/11

CLASSE C (W202)

C 200 (202.020)	Petrol	100	01/94 → 05/00
C 200 Kompressor (202.025)	Petrol	132	10/95 → 05/00
C 230 Kompressor (202.024)	Petrol	142	10/95 → 05/00

SAG023



KW



MERCEDES-BENZ

CLASSE C (W202)

C 280 (202.028)	Petrol	142	05/93 → 05/00
C 36 AMG (202.028)	Petrol	206	05/94 → 05/00
C 43 AMG (202.033)	Petrol	225	08/97 → 05/00 ENGINE: 60002421 →

CLASSE C (W203)

C 180 (203.035)	Petrol	95	10/00 → 05/02
C 180 Kompressor (203.046)	Petrol	105	05/02 → 02/07
C 200 CDI	Diesel	75	02/01 → 02/07
C 200 CDI (203.004)	Diesel	85	09/00 → 02/07
C 200 CDI (203.007)	Diesel	90	04/03 → 02/07
C 200 CGI Kompressor (203.043)	Petrol	125	07/03 → 02/07
C 200 Kompressor (203.042)	Petrol	120	05/02 → 02/07
C 200 Kompressor (203.045)	Petrol	120	05/00 → 06/02
C 220 CDI (203.006)	Diesel	105	05/00 → 02/07
C 220 CDI (203.008)	Diesel	110	02/03 → 02/07
C 230 Kompressor (203.040)	Petrol	141	02/04 → 02/07
C 240 (203.061)	Petrol	125	05/00 → 02/07
C 240 4-matic (203.081)	Petrol	125	07/02 → 02/07
C 270 CDI (203.016)	Diesel	125	12/00 → 02/07
C 30 CDI AMG (203.018)	Diesel	170	01/03 → 02/07
C 32 AMG Kompressor (203.065)	Petrol	260	02/01 → 02/07

CLASSE C (W203)

C 320 (203.064)	Petrol	160	05/00 → 02/07
C 320 4-matic (203.084)	Petrol	160	07/02 → 02/07
C 55 AMG (203.076)	Petrol	270	02/04 → 02/07

SAG023

MERCEDES-BENZ
CLASSE C (W204)

C 180 CGI (204.049)	Petrol	115	01/07 →	
C 180 Kompressor (204.044, 204.045)	Petrol	115	01/08 →	
C 180 Kompressor (204.046)	Petrol	115	01/07 →	
C 200 CDI (204.007)	Diesel	100	01/07 →	
C 200 CGI (204.048)	Petrol	135	01/07 →	
C 200 Kompressor (204.041)	Petrol	135	01/07 →	
C 220 CDI (204.002)	Diesel	125	12/08 →	
C 220 CDI (204.008)	Diesel	125	01/07 →	
C 250 CDI (204.003)	Diesel	150	08/08 →	

CLASSE C Sportcoupe (CL203)

C 160 Kompressor (203.730)	Petrol	90	05/02 → 05/08	
C 180 (203.735)	Petrol	95	03/01 → 05/02	
C 180 Kompressor (203.746)	Petrol	105	05/02 → 05/08	
C 200 CDI (203.707)	Diesel	90	03/03 → 05/08	
C 200 CGI Kompressor (203.743)	Petrol	125	03/03 → 05/08	
C 200 Kompressor (203.742)	Petrol	120	05/02 → 05/08	
C 200 Kompressor (203.745)	Petrol	120	03/01 → 05/02	
C 220	Petrol	120	05/02 → 05/08	
C 220 CDI (203.706)	Diesel	105	03/01 → 05/08	
C 220 CDI (203.708)	Diesel	110	02/04 → 05/08	
C 230 Kompressor (203.740)	Petrol	141	05/02 → 05/08	
C 230 Kompressor (203.747)	Petrol	145	03/01 → 05/02	
C 30 CDI AMG (203.718)	Diesel	170	09/02 → 05/08	

SAG023

MERCEDES-BENZ
CLASSE C Sportcoupe (CL203)

C 320 (203.764)	Petrol	160	09/02 → 05/08	
-----------------	--------	-----	---------------	--

CLASSE C Station wagon (S202)				
C 180 T (202.081)	Petrol	95	09/00 → 03/01	
C 200 T (202.080)	Petrol	100	06/96 → 03/01	
C 200 T Kompressor (202.087)	Petrol	120	09/00 → 03/01	
C 230 T Kompressor (202.085)	Petrol	142	06/97 → 09/00	
C 240 T (202.086)	Petrol	125	06/97 → 09/00	
C 240 T (202.088)	Petrol	125	09/00 → 03/01	
C 280 T (202.089)	Petrol	145	06/97 → 03/01	
C 43 AMG (202.093)	Petrol	225	08/97 → 03/01	ENGINE: 60002421 →

CLASSE C T-Model (S203)

C 180 (203.235)	Petrol	95	03/01 → 05/02	
C 180 Kompressor (203.246)	Petrol	105	05/02 → 08/07	
C 200 CDI (203.204)	Diesel	85	03/01 → 08/07	
C 200 CDI (203.204, 203.207)	Diesel	75	03/01 → 08/07	
C 200 CDI (203.207)	Diesel	90	04/03 → 08/07	
C 200 CGI Kompressor (203.243)	Petrol	125	07/03 → 08/07	
C 200 Kompressor (203.242)	Petrol	120	05/02 → 08/07	
C 200 Kompressor (203.245)	Petrol	120	03/01 → 05/02	
C 220 CDI (203.206)	Diesel	105	03/01 → 08/07	
C 220 CDI (203.208)	Diesel	110	02/04 → 08/07	
C 230 Kompressor (203.240)	Petrol	141	02/04 → 08/07	

SAG023



MERCEDES-BENZ

CLASSE C T-Model (S203)

C 240 (203.261)	Petrol	125	03/01 → 08/07	
C 240 4-matic (203.281)	Petrol	125	07/02 → 08/07	
C 270 CDI (203.216)	Diesel	125	03/01 → 08/07	
C 30 CDI AMG (203.218)	Diesel	170	01/03 → 08/07	
C 32 AMG Kompressor (203.265)	Petrol	260	03/01 → 08/07	
C 320 (203.264, 203.764)	Petrol	160	03/01 → 08/07	
C 320 4-matic (203.284)	Petrol	160	07/02 → 08/07	
C 55 AMG (203.276)	Petrol	270	02/04 → 08/07	

CLASSE C T-Model (S204)

C 180 Kompressor (204.245)	Petrol	115	01/08 →	
C 180 Kompressor (204.246)	Petrol	115	11/07 →	
C 200 CDI (204.201)	Diesel	100	08/10 →	
C 200 CDI (204.207)	Diesel	100	11/07 →	
C 200 Kompressor (204.241)	Petrol	135	11/07 →	
C 220 CDI (204.202)	Diesel	125	12/08 →	
C 220 CDI (204.208)	Diesel	125	11/07 →	
C 250 CDI (204.203)	Diesel	150	01/09 →	

CLASSE CLC (CL203)

CLC 160 (203.731)	Petrol	95	02/09 → 06/11	
CLC 180 Kompressor (203.746)	Petrol	105	05/08 → 06/11	
CLC 200 CDI (203.707)	Diesel	90	05/08 → 06/11	
CLC 200 Kompressor (203.741)	Petrol	135	05/08 → 06/11	

SAG023



MERCEDES-BENZ

CLASSE CLC (CL203)

CLC 220 CDI (203.708)	Diesel	110	05/08 → 06/11	
-----------------------	--------	-----	---------------	--

CLASSE E (W210)

E 200 (210.035)	Petrol	100	06/95 → 08/00	
E 200 CDI (210.007)	Diesel	75	06/98 → 03/02	ENGINE: 30121322 →
E 200 CDI (210.007)	Diesel	85	07/99 → 03/02	ENGINE: 30121322 →
E 200 Kompressor (210.045)	Petrol	137	06/97 → 03/02	
E 200 Kompressor (210.048)	Petrol	120	08/00 → 03/02	
E 220 CDI (210.006)	Diesel	105	07/99 → 03/02	ENGINE: 30121322 →
E 220 CDI (210.006)	Diesel	92	06/98 → 07/99	ENGINE: 30121322 →
E 240 (210.061)	Petrol	125	06/97 → 08/00	ENGINE: 30370999 →
E 240 (210.062)	Petrol	125	08/00 → 03/02	
E 270 CDI (210.016)	Diesel	125	07/99 → 03/02	
E 320 CDI (210.026)	Diesel	145	07/99 → 03/02	
E 430 (210.070)	Petrol	205	06/97 → 03/02	ENGINE: 30039710 →
E 430 4-matic (210.083)	Petrol	205	05/99 → 03/02	ENGINE: 30039710 →
E 55 AMG (210.074)	Petrol	260	08/97 → 03/02	ENGINE: 60002693 →
E 55 AMG 4-matic (210.074)	Petrol	260	03/01 → 03/02	ENGINE: 60002693 →

CLASSE E (W211)

E 200 CDI (211.004)	Diesel	75	07/02 → 12/08	
E 200 CDI (211.004)	Diesel	90	07/02 → 12/08	
E 200 CDI (211.007)	Diesel	100	04/06 → 12/08	
E 200 CGI	Petrol	125	11/02 → 12/08	
E 200 Kompressor (211.041)	Petrol	135	04/06 → 12/08	
E 200 Kompressor (211.042)	Petrol	120	11/02 → 12/08	
E 200 NGT (211.041)	BiFuel	120	03/04 → 12/08	

SAG023

MERCEDES-BENZ
CLASSE E (W211)

E 220 CDI (211.006)	Diesel	110	03/02 → 12/08	
E 220 CDI (211.006)	Diesel	100	03/02 → 12/08	
E 220 CDI (211.008)	Diesel	125	04/06 → 12/08	
E 240 (211.061)	Petrol	130	03/02 → 12/08	
E 240 4-matic (211.080)	Petrol	130	03/03 → 12/08	
E 270 CDI (211.016)	Diesel	130	03/02 → 12/08	
E 280 CDI (211.023)	Diesel	130	05/04 → 12/08	
E 320 (211.065)	Petrol	165	03/02 → 12/08	
E 320 4-matic (211.082)	Petrol	165	03/03 → 12/08	
E 320 CDI (211.026)	Diesel	150	11/02 → 12/08	
E 400 CDI (211.028)	Diesel	191	02/03 → 12/08	
E 500 (211.070)	Petrol	225	03/02 → 12/08	
E 500 4-matic (211.083)	Petrol	225	10/03 → 12/08	
E 55 AMG Kompressor (211.076)	Petrol	350	10/02 → 12/08	

CLASSE E (W212)

E 200 CDI / BlueTEC (212.005, 212.006)	Diesel	100	01/09 →	
E 200 NGT (212.041)	BiFuel	120	03/11 →	
E 220 CDI / BlueTEC (212.001, 212.002)	Diesel	125	01/09 →	
E 250 CDI / BlueTEC (212.003, 212.004)	Diesel	150	01/09 →	
E 200 T (210.235)	Petrol	100	06/96 → 08/00	
E 200 T Kompressor (210.245)	Petrol	137	06/97 → 03/03	

SAG023

MERCEDES-BENZ
CLASSE E Station wagon (S210)

E 200 T Kompressor (210.248)	Petrol	120	08/00 → 03/03	
E 220 T CDI (210.206)	Diesel	105	07/99 → 03/03	ENGINE: 30121322 →
E 220 T CDI (210.206)	Diesel	92	06/98 → 07/99	ENGINE: 30121322 →
E 240 T (210.261)	Petrol	125	06/97 → 03/03	ENGINE: 30370999 →
E 240 T (210.262)	Petrol	125	08/00 → 03/03	
E 270 T CDI (210.216)	Diesel	125	07/99 → 03/03	
E 280 T (210.263)	Petrol	150	12/96 → 03/03	ENGINE: 30370999 →
E 320 T CDI (210.226)	Diesel	145	07/99 → 03/03	
E 430 T (210.270)	Petrol	205	06/97 → 03/03	ENGINE: 30039710 →
E 430 T 4-matic (210.283)	Petrol	205	05/99 → 03/03	ENGINE: 30039710 →
E 55 T AMG (210.274)	Petrol	260	08/97 → 03/03	ENGINE: 60002693 →
E 55 T AMG 4-matic (210.283)	Petrol	260	03/01 → 03/03	ENGINE: 60002693 →

CLASSE E T-Model (S211)

E 200 CDI (211.207)	Diesel	100	04/06 → 07/09	
E 200 Kompressor (211.241)	Petrol	135	04/06 → 07/09	
E 200 T Kompressor (211.242)	Petrol	120	03/03 → 07/09	
E 220 CDI (211.206)	Diesel	100	03/03 → 07/09	
E 220 T CDI (211.206)	Diesel	110	03/03 → 07/09	
E 220 T CDI (211.208)	Diesel	125	04/06 → 07/09	
E 240 T (211.261)	Petrol	130	03/03 → 07/09	
E 240 T 4-matic (211.280)	Petrol	130	07/03 → 07/09	
E 270 T CDI (211.216)	Diesel	130	03/03 → 07/09	
E 280 T CDI (211.223)	Diesel	130	05/04 → 07/09	
E 320 T (211.265)	Petrol	165	03/03 → 07/09	

SAG023



KW



MERCEDES-BENZ

CLASSE E T-Model (S211)

E 320 T 4-matic (211.282) Petrol 165 07/03 → 07/09

E 320 T CDI (211.226) Diesel 150 03/03 → 07/09

E 500 T (211.270) Petrol 225 10/03 → 07/09

E 500 T 4-matic (211.283) Petrol 225 10/03 → 07/09

E 55 T AMG Kompressor (211.276) Petrol 350 07/03 → 07/09

CLASSE E T-Model (S212)

E 200 CDI / BlueTEC (212.205, 212.206) Diesel 100 11/09 →

E 220 CDI / BlueTEC (212.202, 212.201) Diesel 125 11/09 →

E 250 CDI / BlueTEC (212.203, 212.204) Diesel 150 11/09 →

CLASSE G (W463)

G 270 CDI (463.322, 463.323) Diesel 115 10/01 →

G 320 (463.232, 463.233, 463.244, 463.245) Petrol 158 07/97 →

G 400 CDI (463.332, 463.333) Diesel 184 12/00 →

G 500 (463.247, 463.248, 463.249, 463.240, 463.421) Petrol 218 04/98 →

G 55 AMG (463.243, 463.246) Petrol 260 04/99 →

G 55 AMG (463.270, 463.271) Petrol 350 06/04 →

CLASSE G Cabrio (W463)

G 320 (463.209) Petrol 158 11/97 →

G 400 CDI (463.309) Diesel 184 12/00 →

G 500 (463) Petrol 218 04/98 →

SAG023



KW



MERCEDES-BENZ

CLASSE GLK (X204)

220 CDI (204.902) Diesel 120 12/08 →

220 CDI (204.902) Diesel 125 12/08 →

220 CDI 4-matic (204.984) Diesel 120 12/08 →

220 CDI 4-matic (204.984, 204.997) Diesel 125 12/08 →

250 CDI 4-matic (204.982, 204.904) Diesel 150 09/09 →

CLASSE M (W163)

ML 230 (163.136) Petrol 110 02/98 → 06/05

ML 270 CDI (163.113) Diesel 120 12/99 → 06/05

ML 320 (163.154) Petrol 160 02/98 → 08/02 ENGINE: 30358407 →

ML 350 Petrol 173 02/03 → 06/05

ML 350 (163.157) Petrol 180 08/02 → 06/05

ML 400 CDI (163.128) Diesel 184 09/01 → 06/05

ML 430 (163.172) Petrol 200 02/98 → 06/05

ML 500 (163.175) Petrol 215 09/01 → 06/05

ML 55 AMG (163.174) Petrol 255 02/00 → 06/05

CLASSE M (W164)

ML 500 4-matic (164.175) Petrol 225 07/05 →

CLASSE R (W251, V251)

R 500 4-matic (251.075, 251.175) Petrol 225 01/06 →

CLASSE S (W220)

S 280 (220.063, 220.163) Petrol 150 10/98 → 08/05

S 320 (220.065, 220.165) Petrol 165 10/98 → 08/05

S 320 CDI (220.025, 220.125) Diesel 150 09/02 → 08/05

S 320 CDI (220.026, 220.126) Diesel 145 08/99 → 09/02

SAG023

KW

MERCEDES-BENZ
CLASSE S (W220)

S 350 (220.067, 220.167) Petrol 180 09/02 → 08/05

S 350 4-matic (220.087, 220.187) Petrol 180 06/03 → 08/05

S 400 CDI (220.028, 220.128) Diesel 184 06/00 → 08/05

S 400 CDI (220.028, 220.128) Diesel 191 06/03 → 08/05

S 430 (220.070, 220.170) Petrol 205 10/98 → 08/05

S 430 4-matic (220.083, 220.183) Petrol 205 09/02 → 08/05

S 500 (220.075, 220.175, 220.875) Petrol 225 10/98 → 08/05

S 500 4-matic (220.084, 220.184) Petrol 225 09/02 → 08/05

S 55 AMG (220.073, 220.173) Petrol 265 04/99 → 08/05

S 55 AMG Kompressor (220.074, 220.174) Petrol 368 06/02 → 08/05

S 600 (220.176) Petrol 368 09/02 → 08/05

S 600 (220.878, 220.178) Petrol 270 01/00 → 08/05

S 65 AMG (220.179) Petrol 450 03/04 → 08/05

CLASSE S (W221)

S 600 (221.176) Petrol 380 12/05 →

S 65 AMG (221.179) Petrol 450 12/05 →

S 65 AMG (221.179) Petrol 463 04/11 →

CLASSE S Coupé (C215)

CL 500 (215.375) Petrol 225 03/99 → 03/06

CL 55 AMG (215.373) Petrol 265 10/99 → 03/06

SAG023

KW

MERCEDES-BENZ
CLASSE S Coupé (C215)

CL 55 AMG Kompressor (215.374) Petrol 368 06/02 → 03/06

CL 600 (215.376) Petrol 368 09/02 → 03/06

CL 600 (215.378) Petrol 270 03/99 → 03/06

CLASSE S Coupé (C215)

CL 65 AMG (215.379) Petrol 450 09/03 → 03/06

CL 600 (216.376) Petrol 380 08/06 →

CL 65 AMG (216.379) Petrol 450 10/06 → 09/10

CL 65 AMG (216.379) Petrol 463 02/11 →

CLASSE V (638/2)

V 200 CDI (638.294) Diesel 75 03/99 → 07/03

V 220 CDI (638.294) Diesel 90 03/99 → 07/03

CLK (C208)

200 (208.335) Petrol 100 06/97 → 06/02

200 Kompressor (208.344) Petrol 120 06/00 → 06/02

200 Kompressor (208.345) Petrol 141 06/97 → 06/00

230 Kompressor (208.347) Petrol 142 06/97 → 06/00

230 Kompressor (208.348) Petrol 145 06/00 → 06/02

320 (208.365) Petrol 160 06/97 → 06/02 ENGINE: 30370999 →

430 (208.370) Petrol 205 07/98 → 06/02

55 AMG (208.374) Petrol 255 08/99 → 06/02

CLK (C209)

200 CGI (209.343) Petrol 125 07/03 → 05/09

200 Kompressor (209.341) Petrol 135 05/07 → 05/09

200 Kompressor (209.342) Petrol 120 09/02 → 05/09

220 CDI (209.308) Diesel 110 01/05 → 05/09

240 (209.361) Petrol 125 06/02 → 05/09

270 CDI (209.316) Diesel 125 10/02 → 05/09

SAG023



KW



MERCEDES-BENZ

CLK (C209)

320 (209.365) Petrol 160 06/02 → 05/09

500 (209.372) Petrol 285 06/06 → 05/09

500 (209.375) Petrol 225 06/02 → 05/09

55 AMG
(209.376) Petrol 270 09/02 → 05/09

DTM AMG Petrol 428 06/04 → 05/09

CLK Cabriolet (A208)

200 (208.435) Petrol 100 03/98 → 03/02

200 Kompressor
(208.444) Petrol 120 06/00 → 03/02200 Kompressor
(208.445) Petrol 141 03/98 → 06/00230 Kompressor
(208.447) Petrol 142 03/98 → 06/00230 Kompressor
(208.448) Petrol 145 06/00 → 03/02

320 (208.465) Petrol 160 03/98 → 03/02 ENGINE: 30370999 →

430 (208.470) Petrol 205 09/98 → 03/02

55 AMG
(208.474) Petrol 255 01/00 → 03/02

CLK Cabriolet (A209)

CLK 200 CGI
(209.443) Petrol 125 07/03 → 03/10CLK 200
Kompressor
(209.441) Petrol 135 05/07 → 03/10CLK 200
Kompressor
(209.442) Petrol 120 02/03 → 03/10CLK 240
(209.461) Petrol 125 02/03 → 03/10CLK 320
(209.465) Petrol 160 02/03 → 03/10CLK 500
(209.472) Petrol 285 06/06 → 03/10CLK 500
(209.475) Petrol 225 02/03 → 03/10CLK 55 AMG
(209.476) Petrol 270 02/03 → 03/10

CLS (C219)

CLS 500
(219.375) Petrol 225 10/04 → 12/10CLS 55 AMG
(219.376) Petrol 350 01/05 → 12/10

SAG023



KW



MERCEDES-BENZ

SL (R129)

280 (129.059) Petrol 150 05/98 → 10/01

320 (129.064) Petrol 165 05/98 → 10/01

500 (129.068) Petrol 225 05/98 → 10/01

SL (R230)

600 Petrol 380 03/06 → 01/12

350 (230.467) Petrol 180 03/03 → 01/12

500 (230.475) Petrol 225 10/01 → 01/12

55 AMG Petrol 380 03/06 → 01/12

55 AMG
(230.474) Petrol 350 10/01 → 06/0255 AMG
Kompressor
(230.474) Petrol 368 06/02 → 01/12

600 (230.476) Petrol 368 04/03 → 01/12

65 AMG
(230.479) Petrol 450 03/04 → 01/1265 AMG Black
Series Petrol 493 07/08 → 01/1265 AMG Black
Series (230.479) Petrol 493 07/08 → 01/12

SLK (R170)

200 Kompressor
(170.444) Petrol 120 03/00 → 04/04230 Kompressor
(170.449) Petrol 145 03/00 → 04/0432 AMG
Kompressor
(170.466) Petrol 260 03/01 → 04/04

320 (170.465) Petrol 160 03/00 → 04/04

SLK (R171)

200 Kompressor
(171.442) Petrol 120 03/04 → 02/11200 Kompressor
(171.445) Petrol 135 01/08 → 02/11

55 AMG (171.473) Petrol 265 06/04 → 02/11

SLR (R199)

5.4 (199.376) Petrol 460 04/04 →

5.4 722 Edition Petrol 478 10/06 →

SLR ROADSTER (R199)

5.4 Petrol 460 04/07 →

5.4 Petrol 478 10/06 →

SAG023

MERCEDES-BENZ
SPRINTER 2-t Autobus (901, 902)

214	Petrol	105	02/95 → 05/06	ENGINE: 60002693 →
208 CDI	Diesel	60	04/00 → 05/06	
211 CDI	Diesel	80	04/00 → 05/06	
213 CDI	Diesel	95	04/00 → 05/06	
214 NGT	Bifuel	92	04/00 → 05/06	
216 CDI	Diesel	115	04/00 → 05/06	

SPRINTER 2-t Furgonato (901, 902)

214	Petrol	105	02/95 → 05/06	ENGINE: 60002693 →
208 CDI	Diesel	60	04/00 → 05/06	
211 CDI	Diesel	80	04/00 → 05/06	
213 CDI	Diesel	95	04/00 → 05/06	
214 NGT	Bifuel	92	04/00 → 05/06	
216 CDI	Diesel	115	04/00 → 05/06	

SPRINTER 2-t Pianale piatto/Telaio (901, 902)

214	Petrol	105	02/95 → 05/06	ENGINE: 60002693 →
208 CDI	Diesel	60	04/00 → 05/06	
211 CDI	Diesel	80	04/00 → 05/06	
213 CDI	Diesel	95	04/00 → 05/06	
214 NGT	Bifuel	92	04/00 → 05/06	
216 CDI	Diesel	115	04/00 → 05/06	

SPRINTER 3,5-t Autobus (906)

310 CDI (906.731, 906.733, 906.735)	Diesel	70	03/09 →	
311 CDI (906.731, 906.733, 906.735)	Diesel	80	06/06 →	
311 CDI 4x4 (906.731, 906.733, 906.735)	Diesel	80	02/08 →	
315 CDI (906.731, 906.733, 906.735)	Diesel	110	06/06 →	
315 CDI 4x4 (906.731, 906.733, 906.735)	Diesel	110	02/08 →	
316 (906.733, 906.735)	Petrol	115	03/09 →	
316 NGT (906.733, 906.735)	Petrol/ CNG	115	03/09 →	

SAG023

MERCEDES-BENZ
SPRINTER 3,5-t Furgonato (906)

309 CDI (906.631, 906.633, 906.635, 906.637)	Diesel	65	06/06 →	
310 CDI (906.631, 906.633, 906.635, 906.637)	Diesel	70	03/09 →	
311 CDI (906.631, 906.633, 906.635, 906.637)	Diesel	80	06/06 →	
311 CDI 4x4 (906.631, 906.633, 906.635, 906.637)	Diesel	80	02/08 →	
313 CDI (906.631, 906.633, 906.635, 906.637)	Diesel	95	06/06 →	
315 CDI (906.631, 906.633, 906.635, 906.637)	Diesel	110	06/06 →	
315 CDI 4x4 (906.631, 906.633, 906.635, 906.637)	Diesel	110	02/08 →	
316 (906.663, 906.635)	Petrol	115	03/09 →	
316 CDI (906.631, 906.633, 906.635, 906.637)	Diesel	120	03/09 →	
316 CDI 4x4 (906.631, 906.633, 906.635, 906.637)	Diesel	120	03/09 →	
316 NGT (906.633, 906.635)	Petrol/ CNG	115	03/09 →	

SPRINTER 3,5-t Pianale piatto/Telaio (906)				
309 CDI (906.131, 906.133, 906.135, 906.231, 906.233...)	Diesel	65	06/06 →	
310 CDI (906.131, 906.133, 906.135, 906.231, 906.233...)	Diesel	70	03/09 →	
311 CDI (906.131, 906.133, 906.135, 906.231, 906.233...)	Diesel	80	06/06 →	

SAG023



KW



MERCEDES-BENZ

SPRINTER 3,5-t Pianale piatto/Telaio (906)

311 CDI 4x4 (906.131, 906.133, 906.135, 906.231...)	Diesel	80	02/08 →
--	--------	----	---------

313 CDI (906.131, 906.133, 906.135, 906.231, 906.233...)	Diesel	95	06/06 →
---	--------	----	---------

315 CDI (906.131, 906.133, 906.135, 906.231, 906.233...)	Diesel	110	06/06 →
---	--------	-----	---------

315 CDI 4x4 (906.131, 906.133, 906.135, 906.231...)	Diesel	110	02/08 →
--	--------	-----	---------

316 (906.133, 906.135, 906.233, 906.235)	Petrol	115	09/08 →
--	--------	-----	---------

316 CDI (906.131, 906.133, 906.135, 906.231, 906.233...)	Diesel	120	03/09 →
---	--------	-----	---------

316 CDI 4x4 (906.131, 906.133, 906.135, 906.231...)	Diesel	120	03/09 →
--	--------	-----	---------

316 NGT (906.133, 906.135, 906.233, 906.235)	Petrol/ CNG	115	09/08 →
--	----------------	-----	---------

SPRINTER 3-t Autobus (903)

314	Petrol	105	02/95 → 05/06
-----	--------	-----	---------------

308 CDI	Diesel	60	04/00 → 05/06
---------	--------	----	---------------

311 CDI	Diesel	80	04/00 → 05/06
---------	--------	----	---------------

311 CDI 4x4	Diesel	80	08/02 → 05/06
-------------	--------	----	---------------

313 CDI	Diesel	95	04/00 → 05/06
---------	--------	----	---------------

313 CDI 4x4	Diesel	95	08/02 → 05/06
-------------	--------	----	---------------

314 4x4	Petrol	105	08/02 → 05/06
---------	--------	-----	---------------

316 CDI	Diesel	115	04/00 → 05/06
---------	--------	-----	---------------

316 CDI 4x4	Diesel	115	08/02 → 05/06
-------------	--------	-----	---------------

SAG023



KW



MERCEDES-BENZ

SPRINTER 3-t Autobus (906)

211 CDI (906.711, 906.713)	Diesel	80	06/06 →
-------------------------------	--------	----	---------

215 CDI (906.711, 906.713)	Diesel	110	06/06 →
-------------------------------	--------	-----	---------

216 (906.713)	Petrol	115	03/09 →
---------------	--------	-----	---------

SPRINTER 3-t Furgonato (903)

314	Petrol	105	02/95 → 05/06
-----	--------	-----	---------------

308 CDI	Diesel	60	04/00 → 05/06
---------	--------	----	---------------

311 CDI	Diesel	80	04/00 → 05/06
---------	--------	----	---------------

311 CDI 4x4	Diesel	80	08/02 → 05/06
-------------	--------	----	---------------

313 CDI	Diesel	95	04/00 → 05/06
---------	--------	----	---------------

313 CDI 4x4	Diesel	95	08/02 → 05/06
-------------	--------	----	---------------

314 4x4	Petrol	105	08/02 → 05/06
---------	--------	-----	---------------

316 CDI	Diesel	115	04/00 → 05/06
---------	--------	-----	---------------

316 CDI 4x4	Diesel	115	08/02 → 05/06
-------------	--------	-----	---------------

SPRINTER 3-t Furgonato (906)

209 CDI (906.611, 906.613)	Diesel	65	06/06 →
-------------------------------	--------	----	---------

210 CDI (906.611, 906.613)	Diesel	70	03/09 →
-------------------------------	--------	----	---------

211 CDI (906.611, 906.613)	Diesel	80	06/06 →
-------------------------------	--------	----	---------

213 CDI (906.611, 906.613)	Diesel	95	06/06 →
-------------------------------	--------	----	---------

215 CDI (906.611, 906.613)	Diesel	110	06/06 →
-------------------------------	--------	-----	---------

216 (906.613)	Petrol	115	09/08 →
---------------	--------	-----	---------

216 CDI (906.611, 906.613)	Diesel	120	03/09 →
-------------------------------	--------	-----	---------

219 CDI / BlueTEC (906.611, 906.613)	Diesel	140	03/09 →
--	--------	-----	---------

SPRINTER 3-t Pianale piatto/Telaio (903)

314	Petrol	105	02/95 → 05/06
-----	--------	-----	---------------

308 CDI	Diesel	60	04/00 → 05/06
---------	--------	----	---------------

311 CDI	Diesel	80	04/00 → 05/06
---------	--------	----	---------------

311 CDI 4x4	Diesel	80	08/02 → 05/06
-------------	--------	----	---------------

313 CDI	Diesel	95	04/00 → 05/06
---------	--------	----	---------------

313 CDI 4x4	Diesel	95	08/02 → 05/06
-------------	--------	----	---------------

314 4x4	Petrol	105	08/02 → 05/06
---------	--------	-----	---------------

316 CDI	Diesel	115	04/00 → 05/06
---------	--------	-----	---------------

316 CDI 4x4	Diesel	115	08/02 → 05/06
-------------	--------	-----	---------------

SAG023

MERCEDES-BENZ
SPRINTER 3-t Pianale piatto/Telaio (906)

209 CDI (906.111, 906.113, 906.211, 906.213)	Diesel	65	06/06 →	
210 CDI (906.111, 906.113, 906.211, 906.213)	Diesel	70	03/09 →	
211 CDI (906.111, 906.113, 906.211, 906.213)	Diesel	80	06/06 →	
213 CDI (906.111, 906.113, 906.211, 906.213)	Diesel	95	03/09 →	
213 CDI (906.111, 906.113, 906.211, 906.213)	Diesel	95	06/06 →	
215 CDI (906.111, 906.113, 906.211, 906.213)	Diesel	110	06/06 →	
216 (906.113, 906.213)	Petrol	115	09/08 →	
216 CDI (906.111, 906.113, 906.211, 906.213)	Diesel	120	03/09 →	
219 CDI / BlueTEC (906.111, 906.113, 906.211, 906.213)	Diesel	140	03/09 →	

SPRINTER 4,6-t Furgonato (906)

416 CDI (906.653, 906.655, 906.657)	Diesel	120	03/09 →	
--	--------	-----	---------	--

SPRINTER 4,6-t Pianale piatto/Telaio (906)

413 CDI (906.153, 906.155, 906.253, 906.255)	Diesel	95	06/06 →	
416 CDI (906.153, 906.155, 906.253, 906.255)	Diesel	120	03/09 →	

SPRINTER 4-t Autobus (904)

414	Petrol	105	02/96 → 05/06	
408 CDI	Diesel	60	04/00 → 05/06	
411 CDI	Diesel	80	04/00 → 05/06	
413 CDI	Diesel	95	04/00 → 05/06	
416 CDI	Diesel	115	04/00 → 05/06	

SAG023

MERCEDES-BENZ
SPRINTER 4-t Furgonato (904)

414	Petrol	105	02/96 → 05/06	
408 CDI	Diesel	60	04/00 → 05/06	
411 CDI	Diesel	80	04/00 → 05/06	
411 CDI 4x4	Diesel	80	04/00 → 05/06	
413 CDI	Diesel	95	04/00 → 05/06	
413 CDI 4x4	Diesel	95	04/00 → 05/06	
414 4x4	Petrol	105	05/97 → 05/06	
416 CDI	Diesel	115	04/00 → 05/06	
416 CDI 4x4	Diesel	115	04/00 → 05/06	

SPRINTER 4-t Pianale piatto/Telaio (904)

414	Petrol	105	02/96 → 05/06	
408 CDI	Diesel	60	04/00 → 05/06	
411 CDI	Diesel	80	04/00 → 05/06	
411 CDI 4x4	Diesel	80	04/00 → 05/06	
413 CDI	Diesel	95	04/00 → 05/06	
413 CDI 4x4	Diesel	95	04/00 → 05/06	
414 4x4	Petrol	105	05/97 → 05/06	
416 CDI	Diesel	115	04/00 → 05/06	
416 CDI 4x4	Diesel	115	04/00 → 05/06	

SPRINTER 5-t Furgonato (906)

509 CDI (906.653, 906.655, 906.657)	Diesel	65	06/06 →	
509 CDI (906.653, 906.655, 906.657)	Diesel	65	06/06 →	
511 CDI (906.653, 906.655, 906.657)	Diesel	80	06/06 →	
513 CDI (906.653, 906.655, 906.657)	Diesel	95	03/09 →	
515 CDI (906.653, 906.655, 906.657)	Diesel	110	06/06 →	

SPRINTER 5-t Pianale piatto/Telaio (905)

616 CDI (905.612, 905.613, 905.622, 905.623)	Diesel	115	04/01 → 05/06	
---	--------	-----	---------------	--

SPRINTER 5-t Pianale piatto/Telaio (906)

509 CDI (906.153, 906.155, 906.253, 906.255)	Diesel	65	06/06 →	
---	--------	----	---------	--

SAG023



KW



MERCEDES-BENZ

SPRINTER 5-t Pianale piatto/Telaio (906)

510 CDI (906.153, 906.155, 906.253, 906.255)	Diesel	70	03/09 →
--	--------	----	---------

511 CDI (906.153, 906.155, 906.253, 906.255)	Diesel	80	06/06 →
--	--------	----	---------

513 CDI (906.135, 906.155, 906.253, 906.255)	Diesel	95	06/06 →
--	--------	----	---------

515 CDI (906.153, 906.155, 906.253, 906.255)	Diesel	110	06/06 →
--	--------	-----	---------

516 (906.153, 906.155, 906.253, 906.255)	Petrol	115	09/08 →
--	--------	-----	---------

516 NGT (906.153, 906.155, 906.253, 906.255)	Petrol/ CNG	115	09/08 →
--	----------------	-----	---------

SPRINTER Ribaltabile (905)

616 CDI (905.612, 905.622, 905.623)	Diesel	115	04/01 →
---	--------	-----	---------

Vaneo (414)

1.6 (414.700)	Petrol	60	02/02 → 07/05
---------------	--------	----	---------------

1.6 (414.700)	Petrol	75	02/02 → 07/05
---------------	--------	----	---------------

1.7 CDI (414.700)	Diesel	55	02/02 → 07/05
-------------------	--------	----	---------------

1.7 CDI (414.700)	Diesel	67	02/02 → 07/05
-------------------	--------	----	---------------

1.9 (414.700)	Petrol	92	02/02 → 07/05 ENGINE: 30040047 →
---------------	--------	----	----------------------------------

VIANO (W639)

3,0	Petrol	140	09/03 →
-----	--------	-----	---------

3,2	Petrol	160	09/03 →
-----	--------	-----	---------

3,7	Petrol	170	06/04 →
-----	--------	-----	---------

CDI 2.0	Diesel	80	09/03 →
---------	--------	----	---------

CDI 2.0	Diesel	85	08/05 →
---------	--------	----	---------

CDI 2.0 4-matic	Diesel	80	07/05 →
-----------------	--------	----	---------

CDI 2.2	Diesel	110	09/03 →
---------	--------	-----	---------

CDI 2.2 4-matic	Diesel	110	03/06 →
-----------------	--------	-----	---------

VITO / MIXTO Furgonato (W639)

119	Petrol	140	09/03 →
-----	--------	-----	---------

122	Petrol	160	09/03 →
-----	--------	-----	---------

109 CDI	Diesel	65	09/03 → 07/06
---------	--------	----	---------------

109 CDI	Diesel	70	08/06 →
---------	--------	----	---------

111 CDI	Diesel	80	09/03 →
---------	--------	----	---------

111 CDI	Diesel	85	09/07 →
---------	--------	----	---------

SAG023



KW



MERCEDES-BENZ

VITO / MIXTO Furgonato (W639)

111 CDI 4x4	Diesel	80	09/07 →
-------------	--------	----	---------

115 CDI	Diesel	110	09/03 →
---------	--------	-----	---------

115 CDI 4x4	Diesel	110	07/06 →
-------------	--------	-----	---------

VITO Autobus (638)

108 CDI 2.2 (638.194)	Diesel	60	03/99 → 07/03
--------------------------	--------	----	---------------

110 CDI 2.2 (638.194)	Diesel	75	03/99 → 07/03
--------------------------	--------	----	---------------

112 CDI 2.2 (638.194)	Diesel	90	03/99 → 07/03
--------------------------	--------	----	---------------

VITO Autobus (W639)

119	Petrol	140	09/03 →
-----	--------	-----	---------

122	Petrol	160	09/03 →
-----	--------	-----	---------

123	Petrol	170	06/04 →
-----	--------	-----	---------

109 CDI	Diesel	65	09/03 → 07/06
---------	--------	----	---------------

109 CDI	Diesel	70	09/06 →
---------	--------	----	---------

109 CDI 4x4	Diesel	70	09/07 →
-------------	--------	----	---------

111 CDI	Diesel	80	09/03 →
---------	--------	----	---------

111 CDI (639.701)	Diesel	85	09/07 →
----------------------	--------	----	---------

111 CDI 4x4	Diesel	80	09/07 →
-------------	--------	----	---------

115 CDI	Diesel	110	09/03 →
---------	--------	-----	---------

115 CDI 4x4	Diesel	110	09/07 →
-------------	--------	-----	---------

VITO Furgonato (638)

108 CDI 2.2 (638.094)	Diesel	60	03/99 → 07/03
--------------------------	--------	----	---------------

110 CDI 2.2 (638.094)	Diesel	75	03/99 → 07/03
--------------------------	--------	----	---------------

112 CDI 2.2 (638.094)	Diesel	90	03/99 → 07/03
--------------------------	--------	----	---------------

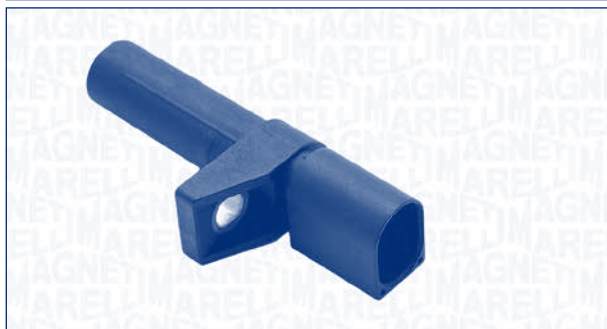
SAG023-1
H1 **SENSORE GIRI / FASE - ALBERO MOTORE**
CRANKSHAFT POSITION SENSOR

KW

MERCEDES-BENZ
CLASSE A (W168)

A 140 (168.031, 168.131)	Petrol	60	01/01 → 08/04	
A 140 (168.031, 168.131)	Petrol	60	05/98 → 08/04	ENGINE: 30040047 →
A 160 (168.033, 168.133)	Petrol	75	07/97 → 08/04	ENGINE: 30040047 →
A 160 CDI (168.006)	Diesel	55	02/01 → 08/04	
A 160 CDI (168.007)	Diesel	44	07/98 → 02/01	
A 170 CDI (168.008)	Diesel	66	07/98 → 02/01	
A 170 CDI (168.009, 168.109)	Diesel	70	02/01 → 08/04	
A 190 (168.032, 168.132)	Petrol	92	03/99 → 08/04	
A 210 (168.035, 168.135)	Petrol	103	03/02 → 08/04	ENGINE: 30045255 →

CLASSE A (W169)

A 150 (169.031, 169.331)	Petrol	70	09/04 → 06/12	
A 160 (169.031, 169.331)	Petrol	70	04/09 → 06/12	
A 160 CDI (169.006, 169.306)	Diesel	60	09/04 → 06/12	
A 170 (169.032, 169.332)	Petrol	85	09/04 → 06/12	
A 180 (169.032, 169.332)	Petrol	85	04/09 → 06/12	
A 180 CDI (169.007, 169.307)	Diesel	80	09/04 → 06/12	

SAG023-1

KW

MERCEDES-BENZ
CLASSE A (W169)

A 200 (169.033, 169.333)	Petrol	100	09/04 → 06/12	
A 200 CDI (169.008, 169.308)	Diesel	103	09/04 → 06/12	
A 200 TURBO (169.034, 169.334)	Petrol	142	09/05 → 06/12	

CLASSE B (W245)

B 150 (245.231)	Petrol	70	03/05 → 11/11	
B 160 (245.231)	Petrol	70	04/09 → 11/11	
B 170 (245.232)	Petrol	85	03/05 → 11/11	
B 170 NGT (245.233)	BiFuel	85	04/08 → 11/11	
B 180 (245.232)	Petrol	85	04/09 → 11/11	
B 180 CDI (245.207)	Diesel	80	03/05 → 11/11	
B 180 NGT (245.233)	BiFuel	85	04/08 → 11/11	
B 200 (245.233)	Petrol	100	03/05 → 11/11	
B 200 CDI (245.208)	Diesel	103	03/05 → 11/11	
B 200 TURBO (245.234)	Petrol	142	03/05 → 11/11	

CLASSE C (W202)

C 200 (202.020)	Petrol	100	01/94 → 05/00	
C 200 Kompressor (202.025)	Petrol	132	10/95 → 05/00	
C 230 Kompressor (202.024)	Petrol	142	10/95 → 05/00	
C 280 (202.028)	Petrol	142	05/93 → 05/00	
C 36 AMG (202.028)	Petrol	206	05/94 → 05/00	
C 43 AMG (202.033)	Petrol	225	08/97 → 05/00	ENGINE: 60002421 →

CLASSE C (W203)

C 180 (203.035)	Petrol	95	10/00 → 05/02	
C 180 Kompressor (203.046)	Petrol	105	05/02 → 02/07	
C 200 CDI	Diesel	75	02/01 → 02/07	
C 200 CDI (203.004)	Diesel	85	09/00 → 02/07	
C 200 CDI (203.007)	Diesel	90	04/03 → 02/07	

SAG023-1



KW



MERCEDES-BENZ

CLASSE C (W203)

C 200 CGI Kompressor (203.043)	Petrol	125	07/03 → 02/07
--------------------------------------	--------	-----	---------------

C 200 Kompressor (203.042)	Petrol	120	05/02 → 02/07
-------------------------------	--------	-----	---------------

C 200 Kompressor (203.045)	Petrol	120	05/00 → 06/02
-------------------------------	--------	-----	---------------

C 220 CDI (203.006)	Diesel	105	05/00 → 02/07
------------------------	--------	-----	---------------

C 220 CDI (203.008)	Diesel	110	02/03 → 02/07
------------------------	--------	-----	---------------

C 230 Kompressor (203.040)	Petrol	141	02/04 → 02/07
-------------------------------	--------	-----	---------------

C 240 (203.061)	Petrol	125	05/00 → 02/07
-----------------	--------	-----	---------------

C 240 4-matic (203.081)	Petrol	125	07/02 → 02/07
----------------------------	--------	-----	---------------

C 270 CDI (203.016)	Diesel	125	12/00 → 02/07
------------------------	--------	-----	---------------

C 30 CDI AMG (203.018)	Diesel	170	01/03 → 02/07
---------------------------	--------	-----	---------------

C 32 AMG Kompressor (203.065)	Petrol	260	02/01 → 02/07
-------------------------------------	--------	-----	---------------

C 320 (203.064)	Petrol	160	05/00 → 02/07
-----------------	--------	-----	---------------

C 320 4-matic (203.084)	Petrol	160	07/02 → 02/07
----------------------------	--------	-----	---------------

C 55 AMG (203.076)	Petrol	270	02/04 → 02/07
-----------------------	--------	-----	---------------

CLASSE C (W204)

C 180 CGI (204.049)	Petrol	115	01/07 →
------------------------	--------	-----	---------

C 180 Kompressor (204.044, 204.045)	Petrol	115	01/08 →
--	--------	-----	---------

C 180 Kompressor (204.046)	Petrol	115	01/07 →
-------------------------------	--------	-----	---------

C 200 CDI (204.007)	Diesel	100	01/07 →
------------------------	--------	-----	---------

C 200 CGI (204.048)	Petrol	135	01/07 →
------------------------	--------	-----	---------

C 200 Kompressor (204.041)	Petrol	135	01/07 →
-------------------------------	--------	-----	---------

C 220 CDI (204.002)	Diesel	125	12/08 →
------------------------	--------	-----	---------

SAG023-1



KW



MERCEDES-BENZ

CLASSE C (W204)

C 220 CDI (204.008)	Diesel	125	01/07 →
------------------------	--------	-----	---------

C 250 CDI (204.003)	Diesel	150	08/08 →
------------------------	--------	-----	---------

CLASSE C Sportcoupe (CL203)

C 160 Kompressor (203.730)	Petrol	90	05/02 → 05/08
-------------------------------	--------	----	---------------

C 180 (203.735)	Petrol	95	03/01 → 05/02
-----------------	--------	----	---------------

C 180 Kompressor (203.746)	Petrol	105	05/02 → 05/08
-------------------------------	--------	-----	---------------

C 200 CDI (203.707)	Diesel	90	03/03 → 05/08
------------------------	--------	----	---------------

C 200 CGI Kompressor (203.743)	Petrol	125	03/03 → 05/08
--------------------------------------	--------	-----	---------------

C 200 Kompressor (203.742)	Petrol	120	05/02 → 05/08
-------------------------------	--------	-----	---------------

C 200 Kompressor (203.745)	Petrol	120	03/01 → 05/02
-------------------------------	--------	-----	---------------

C 220	Petrol	120	05/02 → 05/08
-------	--------	-----	---------------

C 220 CDI (203.706)	Diesel	105	03/01 → 05/08
------------------------	--------	-----	---------------

C 220 CDI (203.708)	Diesel	110	02/04 → 05/08
------------------------	--------	-----	---------------

C 230 Kompressor (203.740)	Petrol	141	05/02 → 05/08
-------------------------------	--------	-----	---------------

C 230 Kompressor (203.747)	Petrol	145	03/01 → 05/02
-------------------------------	--------	-----	---------------

C 30 CDI AMG (203.718)	Diesel	170	09/02 → 05/08
---------------------------	--------	-----	---------------

C 320 (203.764)	Petrol	160	09/02 → 05/08
-----------------	--------	-----	---------------

CLASSE C Station wagon (S202)

C 180 T (202.081)	Petrol	95	09/00 → 03/01
-------------------	--------	----	---------------

C 200 T (202.080)	Petrol	100	06/96 → 03/01
-------------------	--------	-----	---------------

C 200 T Kompressor (202.087)	Petrol	120	09/00 → 03/01
---------------------------------	--------	-----	---------------

C 230 T Kompressor (202.085)	Petrol	142	06/97 → 09/00
---------------------------------	--------	-----	---------------

C 240 T (202.086)	Petrol	125	06/97 → 09/00
-------------------	--------	-----	---------------

C 240 T (202.088)	Petrol	125	09/00 → 03/01
-------------------	--------	-----	---------------

C 280 T (202.089)	Petrol	145	06/97 → 03/01
-------------------	--------	-----	---------------

C 43 AMG (202.093)	Petrol	225	08/97 → 03/01	ENGINE: 60002421 →
-----------------------	--------	-----	---------------	--------------------

SAG023-1

MERCEDES-BENZ
CLASSE C T-Model (S203)

C 180 (203.235)	Petrol	95	03/01 → 05/02	
C 180 Kompressor (203.246)	Petrol	105	05/02 → 08/07	
C 200 CDI (203.204)	Diesel	85	03/01 → 08/07	
C 200 CDI (203.204, 203.207)	Diesel	75	03/01 → 08/07	
C 200 CDI (203.207)	Diesel	90	04/03 → 08/07	
C 200 CGI Kompressor (203.243)	Petrol	125	07/03 → 08/07	
C 200 Kompressor (203.242)	Petrol	120	05/02 → 08/07	
C 200 Kompressor (203.245)	Petrol	120	03/01 → 05/02	
C 220 CDI (203.206)	Diesel	105	03/01 → 08/07	
C 220 CDI (203.208)	Diesel	110	02/04 → 08/07	
C 230 Kompressor (203.240)	Petrol	141	02/04 → 08/07	
C 240 (203.261)	Petrol	125	03/01 → 08/07	
C 240 4-matic (203.281)	Petrol	125	07/02 → 08/07	
C 270 CDI (203.216)	Diesel	125	03/01 → 08/07	
C 30 CDI AMG (203.218)	Diesel	170	01/03 → 08/07	
C 32 AMG Kompressor (203.265)	Petrol	260	03/01 → 08/07	
C 320 (203.264, 203.764)	Petrol	160	03/01 → 08/07	
C 320 4-matic (203.284)	Petrol	160	07/02 → 08/07	
C 55 AMG (203.276)	Petrol	270	02/04 → 08/07	

CLASSE C T-Model (S204)

C 180 Kompressor (204.245)	Petrol	115	01/08 →	
C 180 Kompressor (204.246)	Petrol	115	11/07 →	

SAG023-1

MERCEDES-BENZ
CLASSE C T-Model (S204)

C 200 CDI (204.201)	Diesel	100	08/10 →	
C 200 CDI (204.207)	Diesel	100	11/07 →	
C 200 Kompressor (204.241)	Petrol	135	11/07 →	
C 220 CDI (204.202)	Diesel	125	12/08 →	
C 220 CDI (204.208)	Diesel	125	11/07 →	
C 250 CDI (204.203)	Diesel	150	01/09 →	

CLASSE CLC (CL203)

CLC 160 (203.731)	Petrol	95	02/09 → 06/11	
CLC 180 Kompressor (203.746)	Petrol	105	05/08 → 06/11	
CLC 200 CDI (203.707)	Diesel	90	05/08 → 06/11	
CLC 200 Kompressor (203.741)	Petrol	135	05/08 → 06/11	
CLC 220 CDI (203.708)	Diesel	110	05/08 → 06/11	

CLASSE E (W210)

E 200 (210.035)	Petrol	100	06/95 → 08/00	
E 200 CDI (210.007)	Diesel	75	06/98 → 03/02	ENGINE: 30121322 →
E 200 CDI (210.007)	Diesel	85	07/99 → 03/02	ENGINE: 30121322 →
E 200 Kompressor (210.045)	Petrol	137	06/97 → 03/02	
E 200 Kompressor (210.048)	Petrol	120	08/00 → 03/02	
E 220 CDI (210.006)	Diesel	105	07/99 → 03/02	ENGINE: 30121322 →
E 220 CDI (210.006)	Diesel	92	06/98 → 07/99	ENGINE: 30121322 →
E 240 (210.061)	Petrol	125	06/97 → 08/00	ENGINE: 30370999 →
E 240 (210.062)	Petrol	125	08/00 → 03/02	
E 270 CDI (210.016)	Diesel	125	07/99 → 03/02	

SAG023-1



KW



MERCEDES-BENZ

CLASSE E (W210)

E 320 CDI (210.026)	Diesel	145	07/99 → 03/02	
E 430 (210.070)	Petrol	205	06/97 → 03/02	ENGINE: 30039710 →
E 430 4-matic (210.083)	Petrol	205	05/99 → 03/02	ENGINE: 30039710 →
E 55 AMG (210.074)	Petrol	260	08/97 → 03/02	ENGINE: 60002693 →
E 55 AMG 4-matic (210.074)	Petrol	260	03/01 → 03/02	ENGINE: 60002693 →

CLASSE E (W211)

E 200 CDI (211.004)	Diesel	75	07/02 → 12/08	
E 200 CDI (211.004)	Diesel	90	07/02 → 12/08	
E 200 CDI (211.007)	Diesel	100	04/06 → 12/08	
E 200 CGI	Petrol	125	11/02 → 12/08	
E 200 Kompressor (211.041)	Petrol	135	04/06 → 12/08	
E 200 Kompressor (211.042)	Petrol	120	11/02 → 12/08	
E 200 NGT (211.041)	BiFuel	120	03/04 → 12/08	
E 220 CDI (211.006)	Diesel	110	03/02 → 12/08	
E 220 CDI (211.006)	Diesel	100	03/02 → 12/08	
E 220 CDI (211.008)	Diesel	125	04/06 → 12/08	
E 240 (211.061)	Petrol	130	03/02 → 12/08	
E 240 4-matic (211.080)	Petrol	130	03/03 → 12/08	
E 270 CDI (211.016)	Diesel	130	03/02 → 12/08	
E 280 CDI (211.023)	Diesel	130	05/04 → 12/08	
E 320 (211.065)	Petrol	165	03/02 → 12/08	
E 320 4-matic (211.082)	Petrol	165	03/03 → 12/08	
E 320 CDI (211.026)	Diesel	150	11/02 → 12/08	
E 400 CDI (211.028)	Diesel	191	02/03 → 12/08	
E 500 (211.070)	Petrol	225	03/02 → 12/08	

SAG023-1



KW



MERCEDES-BENZ

CLASSE E (W211)

E 500 4-matic (211.083)	Petrol	225	10/03 → 12/08	
E 55 AMG Kompressor (211.076)	Petrol	350	10/02 → 12/08	

CLASSE E (W212)

E 200 CDI / BlueTEC (212.005, 212.006)	Diesel	100	01/09 →	
E 200 NGT (212.041)	BiFuel	120	03/11 →	
E 220 CDI / BlueTEC (212.001, 212.002)	Diesel	125	01/09 →	
E 250 CDI / BlueTEC (212.003, 212.004)	Diesel	150	01/09 →	

CLASSE E Station wagon (S210)

E 200 T (210.235)	Petrol	100	06/96 → 08/00	
E 200 T Kompressor (210.245)	Petrol	137	06/97 → 03/03	
E 200 T Kompressor (210.248)	Petrol	120	08/00 → 03/03	
E 220 T CDI (210.206)	Diesel	105	07/99 → 03/03	ENGINE: 30121322 →
E 220 T CDI (210.206)	Diesel	92	06/98 → 07/99	ENGINE: 30121322 →
E 240 T (210.261)	Petrol	125	06/97 → 03/03	ENGINE: 30370999 →
E 240 T (210.262)	Petrol	125	08/00 → 03/03	
E 270 T CDI (210.216)	Diesel	125	07/99 → 03/03	
E 280 T (210.263)	Petrol	150	12/96 → 03/03	ENGINE: 30370999 →
E 320 T CDI (210.226)	Diesel	145	07/99 → 03/03	
E 430 T (210.270)	Petrol	205	06/97 → 03/03	ENGINE: 30039710 →
E 430 T 4-matic (210.283)	Petrol	205	05/99 → 03/03	ENGINE: 30039710 →
E 55 T AMG (210.274)	Petrol	260	08/97 → 03/03	ENGINE: 60002693 →
E 55 T AMG 4-matic (210.283)	Petrol	260	03/01 → 03/03	ENGINE: 60002693 →

SAG023-1

MERCEDES-BENZ
CLASSE E T-Model (S211)

E 200 CDI (211.207)	Diesel	100	04/06 → 07/09	
E 200 Kompressor (211.241)	Petrol	135	04/06 → 07/09	
E 200 T Kompressor (211.242)	Petrol	120	03/03 → 07/09	
E 220 CDI (211.206)	Diesel	100	03/03 → 07/09	
E 220 T CDI (211.206)	Diesel	110	03/03 → 07/09	
E 220 T CDI (211.208)	Diesel	125	04/06 → 07/09	
E 240 T (211.261)	Petrol	130	03/03 → 07/09	
E 240 T 4-matic (211.280)	Petrol	130	07/03 → 07/09	
E 270 T CDI (211.216)	Diesel	130	03/03 → 07/09	
E 280 T CDI (211.223)	Diesel	130	05/04 → 07/09	
E 320 T (211.265)	Petrol	165	03/03 → 07/09	
E 320 T 4-matic (211.282)	Petrol	165	07/03 → 07/09	
E 320 T CDI (211.226)	Diesel	150	03/03 → 07/09	
E 500 T (211.270)	Petrol	225	10/03 → 07/09	
E 500 T 4-matic (211.283)	Petrol	225	10/03 → 07/09	
E 55 T AMG Kompressor (211.276)	Petrol	350	07/03 → 07/09	

CLASSE E T-Model (S212)

E 200 CDI / BlueTEC (212.205, 212.206)	Diesel	100	11/09 →	
E 220 CDI / BlueTEC (212.202, 212.201)	Diesel	125	11/09 →	
E 250 CDI / BlueTEC (212.203, 212.204)	Diesel	150	11/09 →	

SAG023-1

MERCEDES-BENZ
CLASSE G (W463)

G 270 CDI (463.322, 463.323)	Diesel	115	10/01 →	
G 320 (463.232, 463.233, 463.244, 463.245)	Petrol	158	07/97 →	
G 400 CDI (463.332, 463.333)	Diesel	184	12/00 →	
G 500 (463.247, 463.248, 463.249, 463.240, 463.421)	Petrol	218	04/98 →	
G 55 AMG (463.243, 463.246)	Petrol	260	04/99 →	
G 55 AMG (463.270, 463.271)	Petrol	350	06/04 →	

CLASSE G Cabrio (W463)

G 320 (463.209)	Petrol	158	11/97 →	
G 400 CDI (463.309)	Diesel	184	12/00 →	
G 500 (463)	Petrol	218	04/98 →	

CLASSE GLK (X204)

220 CDI (204.902)	Diesel	120	12/08 →	
220 CDI (204.902)	Diesel	125	12/08 →	
220 CDI 4-matic (204.984)	Diesel	120	12/08 →	
220 CDI 4-matic (204.984, 204.997)	Diesel	125	12/08 →	
250 CDI 4-matic (204.982, 204.904)	Diesel	150	09/09 →	

CLASSE M (W163)

ML 230 (163.136)	Petrol	110	02/98 → 06/05	
ML 270 CDI (163.113)	Diesel	120	12/99 → 06/05	
ML 320 (163.154)	Petrol	160	02/98 → 08/02	ENGINE: 30358407 →
ML 350	Petrol	173	02/03 → 06/05	
ML 350 (163.157)	Petrol	180	08/02 → 06/05	
ML 400 CDI (163.128)	Diesel	184	09/01 → 06/05	
ML 430 (163.172)	Petrol	200	02/98 → 06/05	
ML 500 (163.175)	Petrol	215	09/01 → 06/05	
ML 55 AMG (163.174)	Petrol	255	02/00 → 06/05	

SAG023-1



MERCEDES-BENZ

CLASSE M (W164)

ML 500 4-matic (164.175)	Petrol	225	07/05 →
-----------------------------	--------	-----	---------

CLASSE R (W251, V251)

R 500 4-matic (251.075, 251.175)	Petrol	225	01/06 →
-------------------------------------	--------	-----	---------

CLASSE S (W220)

S 280 (220.063, 220.163)	Petrol	150	10/98 → 08/05
-----------------------------	--------	-----	---------------

S 320 (220.065, 220.165)	Petrol	165	10/98 → 08/05
-----------------------------	--------	-----	---------------

S 320 CDI (220.025, 220.125)	Diesel	150	09/02 → 08/05
---------------------------------	--------	-----	---------------

S 320 CDI (220.026, 220.126)	Diesel	145	08/99 → 09/02
---------------------------------	--------	-----	---------------

S 350 (220.067, 220.167)	Petrol	180	09/02 → 08/05
-----------------------------	--------	-----	---------------

S 350 4-matic (220.087, 220.187)	Petrol	180	06/03 → 08/05
-------------------------------------	--------	-----	---------------

S 400 CDI (220.028, 220.128)	Diesel	184	06/00 → 08/05
---------------------------------	--------	-----	---------------

S 400 CDI (220.028, 220.128)	Diesel	191	06/03 → 08/05
---------------------------------	--------	-----	---------------

S 430 (220.070, 220.170)	Petrol	205	10/98 → 08/05
-----------------------------	--------	-----	---------------

S 430 4-matic (220.083, 220.183)	Petrol	205	09/02 → 08/05
-------------------------------------	--------	-----	---------------

S 500 (220.075, 220.175, 220.875)	Petrol	225	10/98 → 08/05
--------------------------------------	--------	-----	---------------

S 500 4-matic (220.084, 220.184)	Petrol	225	09/02 → 08/05
-------------------------------------	--------	-----	---------------

S 55 AMG (220.073, 220.173)	Petrol	265	04/99 → 08/05
--------------------------------	--------	-----	---------------

S 55 AMG Kompressor (220.074, 220.174)	Petrol	368	06/02 → 08/05
--	--------	-----	---------------

S 600 (220.176)	Petrol	368	09/02 → 08/05
-----------------	--------	-----	---------------

S 600 (220.878, 220.178)	Petrol	270	01/00 → 08/05
-----------------------------	--------	-----	---------------

S 65 AMG (220.179)	Petrol	450	03/04 → 08/05
-----------------------	--------	-----	---------------

CLASSE S (W221)

S 600 (221.176)	Petrol	380	12/05 →
-----------------	--------	-----	---------

S 65 AMG (221.179)	Petrol	450	12/05 →
-----------------------	--------	-----	---------

SAG023-1



MERCEDES-BENZ

CLASSE S (W221)

S 65 AMG (221.179)	Petrol	463	04/11 →
-----------------------	--------	-----	---------

CLASSE S Coupé (C215)

CL 500 (215.375)	Petrol	225	03/99 → 03/06
------------------	--------	-----	---------------

CL 55 AMG (215.373)	Petrol	265	10/99 → 03/06
------------------------	--------	-----	---------------

CL 55 AMG Kompressor (215.374)	Petrol	368	06/02 → 03/06
--------------------------------------	--------	-----	---------------

CL 600 (215.376)	Petrol	368	09/02 → 03/06
------------------	--------	-----	---------------

CL 600 (215.378)	Petrol	270	03/99 → 03/06
------------------	--------	-----	---------------

CL 65 AMG (215.379)	Petrol	450	09/03 → 03/06
------------------------	--------	-----	---------------

CLASSE S Coupé (C216)

CL 600 (216.376)	Petrol	380	08/06 →
------------------	--------	-----	---------

CL 65 AMG (216.379)	Petrol	450	10/06 → 09/10
------------------------	--------	-----	---------------

CL 65 AMG (216.379)	Petrol	463	02/11 →
------------------------	--------	-----	---------

CLASSE V (638/2)

V 200 CDI (638.294)	Diesel	75	03/99 → 07/03
------------------------	--------	----	---------------

V 220 CDI (638.294)	Diesel	90	03/99 → 07/03
------------------------	--------	----	---------------

CLK (C208)

200 (208.335)	Petrol	100	06/97 → 06/02
---------------	--------	-----	---------------

200 Kompressor (208.344)	Petrol	120	06/00 → 06/02
-----------------------------	--------	-----	---------------

200 Kompressor (208.345)	Petrol	141	06/97 → 06/00
-----------------------------	--------	-----	---------------

230 Kompressor (208.347)	Petrol	142	06/97 → 06/00
-----------------------------	--------	-----	---------------

230 Kompressor (208.348)	Petrol	145	06/00 → 06/02
-----------------------------	--------	-----	---------------

320 (208.365)	Petrol	160	06/97 → 06/02	ENGINE: 30370999 →
---------------	--------	-----	---------------	--------------------

430 (208.370)	Petrol	205	07/98 → 06/02
---------------	--------	-----	---------------

55 AMG (208.374)	Petrol	255	08/99 → 06/02
---------------------	--------	-----	---------------

CLK (C209)

200 CGI (209.343)	Petrol	125	07/03 → 05/09
----------------------	--------	-----	---------------

200 Kompressor (209.341)	Petrol	135	05/07 → 05/09
-----------------------------	--------	-----	---------------

SAG023-1

MERCEDES-BENZ
CLK (C209)

200 Kompressor (209.342)	Petrol	120	09/02 → 05/09	
220 CDI (209.308)	Diesel	110	01/05 → 05/09	
240 (209.361)	Petrol	125	06/02 → 05/09	
270 CDI (209.316)	Diesel	125	10/02 → 05/09	
320 (209.365)	Petrol	160	06/02 → 05/09	
500 (209.372)	Petrol	285	06/06 → 05/09	
500 (209.375)	Petrol	225	06/02 → 05/09	
55 AMG (209.376)	Petrol	270	09/02 → 05/09	
DTM AMG	Petrol	428	06/04 → 05/09	

CLK Cabriolet (A208)

200 (208.435)	Petrol	100	03/98 → 03/02	
200 Kompressor (208.444)	Petrol	120	06/00 → 03/02	
200 Kompressor (208.445)	Petrol	141	03/98 → 06/00	
230 Kompressor (208.447)	Petrol	142	03/98 → 06/00	
230 Kompressor (208.448)	Petrol	145	06/00 → 03/02	
320 (208.465)	Petrol	160	03/98 → 03/02	ENGINE: 30370999 →
430 (208.470)	Petrol	205	09/98 → 03/02	
55 AMG (208.474)	Petrol	255	01/00 → 03/02	

CLK Cabriolet (A209)

CLK 200 CGI (209.443)	Petrol	125	07/03 → 03/10	
CLK 200 Kompressor (209.441)	Petrol	135	05/07 → 03/10	
CLK 200 Kompressor (209.442)	Petrol	120	02/03 → 03/10	
CLK 240 (209.461)	Petrol	125	02/03 → 03/10	
CLK 320 (209.465)	Petrol	160	02/03 → 03/10	
CLK 500 (209.472)	Petrol	285	06/06 → 03/10	
CLK 500 (209.475)	Petrol	225	02/03 → 03/10	

SAG023-1

MERCEDES-BENZ
CLK Cabriolet (A209)

CLK 55 AMG (209.476)	Petrol	270	02/03 → 03/10	
----------------------	--------	-----	---------------	--

CLS (C219)

CLS 500 (219.375)	Petrol	225	10/04 → 12/10	
CLS 55 AMG (219.376)	Petrol	350	01/05 → 12/10	

SL (R129)

280 (129.059)	Petrol	150	05/98 → 10/01	
320 (129.064)	Petrol	165	05/98 → 10/01	
500 (129.068)	Petrol	225	05/98 → 10/01	

SL (R230)

600	Petrol	380	03/06 → 01/12	
350 (230.467)	Petrol	180	03/03 → 01/12	
500 (230.475)	Petrol	225	10/01 → 01/12	
55 AMG	Petrol	380	03/06 → 01/12	
55AMG (230.474)	Petrol	350	10/01 → 06/02	
55 AMG Kompressor (230.474)	Petrol	368	06/02 → 01/12	
600 (230.476)	Petrol	368	04/03 → 01/12	
65AMG (230.479)	Petrol	450	03/04 → 01/12	
65 AMG Black Series	Petrol	493	07/08 → 01/12	
65 AMG Black Series (230.479)	Petrol	493	07/08 → 01/12	

SLK (R170)

200 Kompressor (170.444)	Petrol	120	03/00 → 04/04	
230 Kompressor (170.449)	Petrol	145	03/00 → 04/04	
32 AMG Kompressor (170.466)	Petrol	260	03/01 → 04/04	
320 (170.465)	Petrol	160	03/00 → 04/04	

SLK (R171)

200 Kompressor (171.442)	Petrol	120	03/04 → 02/11	
200 Kompressor (171.445)	Petrol	135	01/08 → 02/11	
55AMG (171.473)	Petrol	265	06/04 → 02/11	

SLR (R199)

5.4 (199.376)	Petrol	460	04/04 →	
5.4 722 Edition	Petrol	478	10/06 →	

SAG023-1



MERCEDES-BENZ

SLR ROADSTER (R199)

5.4 Petrol 460 04/07 →

5.4 Petrol 478 10/06 →

SPRINTER 2-t Autobus (901, 902)

214 Petrol 105 02/95 → 05/06 ENGINE: 60002693 →

208 CDI Diesel 60 04/00 → 05/06

211 CDI Diesel 80 04/00 → 05/06

213 CDI Diesel 95 04/00 → 05/06

214 NGT Bifuel 92 04/00 → 05/06

216 CDI Diesel 115 04/00 → 05/06

SPRINTER 2-t Furgonato (901, 902)

214 Petrol 105 02/95 → 05/06 ENGINE: 60002693 →

208 CDI Diesel 60 04/00 → 05/06

211 CDI Diesel 80 04/00 → 05/06

213 CDI Diesel 95 04/00 → 05/06

214 NGT Bifuel 92 04/00 → 05/06

216 CDI Diesel 115 04/00 → 05/06

SPRINTER 2-t Pianale piatto/Telaio (901, 902)

214 Petrol 105 02/95 → 05/06 ENGINE: 60002693 →

208 CDI Diesel 60 04/00 → 05/06

211 CDI Diesel 80 04/00 → 05/06

213 CDI Diesel 95 04/00 → 05/06

214 NGT Bifuel 92 04/00 → 05/06

216 CDI Diesel 115 04/00 → 05/06

SPRINTER 3,5-t Autobus (906)

310 CDI
(906.731,906.733,
906.735) Diesel 70 03/09 →311 CDI
(906.731,906.733,
906.735) Diesel 80 06/06 →311 CDI 4x4
(906.731,906.733,
906.735) Diesel 80 02/08 →315 CDI
(906.731,906.733,
906.735) Diesel 110 06/06 →315 CDI 4x4
(906.731,906.733,
906.735) Diesel 110 02/08 →316 (906.733,
906.735) Petrol 115 03/09 →316 NGT
(906.733,906.735) Petrol/
CNG 115 03/09 →

SAG023-1



MERCEDES-BENZ

SPRINTER 3,5-t Furgonato (906)

309 CDI
(906.631,906.633,
906.635,906.637) Diesel 65 06/06 →310 CDI
(906.631,906.633,
906.635,906.637) Diesel 70 03/09 →311 CDI
(906.631,906.633,
906.635,906.637) Diesel 80 06/06 →311 CDI 4x4
(906.631,906.633,
906.635,906.637) Diesel 80 02/08 →313 CDI
(906.631,906.633,
906.635,906.637) Diesel 95 06/06 →315 CDI
(906.631,906.633,
906.635,906.637) Diesel 110 06/06 →315 CDI 4x4
(906.631,906.633,
906.635,906.637) Diesel 110 02/08 →316 (906.663,
906.635) Petrol 115 03/09 →316 CDI
(906.631,906.633,
906.635,906.637) Diesel 120 03/09 →316 CDI 4x4
(906.631,906.633,
906.635,906.637) Diesel 120 03/09 →316 NGT
(906.633,906.635) Petrol/
CNG 115 03/09 →

SPRINTER 3,5-t Pianale piatto/Telaio (906)

309 CDI
906.131, 906.133,
906.135, 906.231,
906.233...) Diesel 65 06/06 →310 CDI (906.131,
906.133, 906.135,
906.231,
906.233...) Diesel 70 03/09 →311 CDI
(906.131,906.133,
906.135, 906.231,
906.233...) Diesel 80 06/06 →

SAG023-1

MERCEDES-BENZ
SPRINTER 3,5-t Pianale piatto/Telaio (906)

311 CDI 4x4 (906.131, 906.133, 906.135, 906.231...)	Diesel	80	02/08 →	
313 CDI (906.131, 906.133, 906.135, 906.231, 906.233...)	Diesel	95	06/06 →	
315 CDI (906.131, 906.133, 906.135, 906.231, 906.233...)	Diesel	110	06/06 →	
315 CDI 4x4 (906.131, 906.133, 906.135, 906.231...)	Diesel	110	02/08 →	
316 (906.133, 906.135, 906.233, 906.235)	Petrol	115	09/08 →	
316 CDI (906.131, 906.133, 906.135, 906.231, 906.233...)	Diesel	120	03/09 →	
316 CDI 4x4 (906.131, 906.133, 906.135, 906.231...)	Diesel	120	03/09 →	
316NGT (906.133, 906.135, 906.233, 906.235)	Petrol/ CNG	115	09/08 →	

SPRINTER 3-t Autobus (903)

314	Petrol	105	02/95 → 05/06	
308 CDI	Diesel	60	04/00 → 05/06	
311 CDI	Diesel	80	04/00 → 05/06	
311 CDI 4x4	Diesel	80	08/02 → 05/06	
313 CDI	Diesel	95	04/00 → 05/06	
313 CDI 4x4	Diesel	95	08/02 → 05/06	
314 4x4	Petrol	105	08/02 → 05/06	
316 CDI	Diesel	115	04/00 → 05/06	
316 CDI 4x4	Diesel	115	08/02 → 05/06	

SAG023-1

MERCEDES-BENZ
SPRINTER 3-t Autobus (906)

211 CDI (906.711, 906.713)	Diesel	80	06/06 →	
215 CDI (906.711, 906.713)	Diesel	110	06/06 →	
216 (906.713)	Petrol	115	03/09 →	

SPRINTER 3-t Furgonato (903)

314	Petrol	105	02/95 → 05/06	
308 CDI	Diesel	60	04/00 → 05/06	
311 CDI	Diesel	80	04/00 → 05/06	
311 CDI 4x4	Diesel	80	08/02 → 05/06	
313 CDI	Diesel	95	04/00 → 05/06	
313 CDI 4x4	Diesel	95	08/02 → 05/06	
314 4x4	Petrol	105	08/02 → 05/06	
316 CDI	Diesel	115	04/00 → 05/06	
316 CDI 4x4	Diesel	115	08/02 → 05/06	

SPRINTER 3-t Furgonato (906)

209 CDI (906.611, 906.613)	Diesel	65	06/06 →	
210 CDI (906.611, 906.613)	Diesel	70	03/09 →	
211 CDI (906.611, 906.613)	Diesel	80	06/06 →	
213 CDI (906.611, 906.613)	Diesel	95	06/06 →	
215 CDI (906.611, 906.613)	Diesel	110	06/06 →	
216 (906.613)	Petrol	115	09/08 →	
216 CDI (906.611, 906.613)	Diesel	120	03/09 →	
219 CDI / BlueTEC (906.611, 906.613)	Diesel	140	03/09 →	

SPRINTER 3-t Pianale piatto/Telaio (903)

314	Petrol	105	02/95 → 05/06	
308 CDI	Diesel	60	04/00 → 05/06	
311 CDI	Diesel	80	04/00 → 05/06	
311 CDI 4x4	Diesel	80	08/02 → 05/06	
313 CDI	Diesel	95	04/00 → 05/06	
313 CDI 4x4	Diesel	95	08/02 → 05/06	
314 4x4	Petrol	105	08/02 → 05/06	
316 CDI	Diesel	115	04/00 → 05/06	
316 CDI 4x4	Diesel	115	08/02 → 05/06	

SAG023-1



MERCEDES-BENZ

SPRINTER 3-t Pianale piatto/Telaio (906)

209 CDI
(906.111, 906.113, 906.211, 906.213) Diesel 65 06/06 →

210 CDI
(906.111, 906.113, 906.211, 906.213) Diesel 70 03/09 →

211 CDI
(906.111, 906.113, 906.211, 906.213) Diesel 80 06/06 →

213 CDI
(906.111, 906.113, 906.211, 906.213) Diesel 95 03/09 →

213 CDI
(906.111, 906.113, 906.211, 906.213) Diesel 95 06/06 →

10 mm Diesel 110 06/06 →

216 (906.113, 906.213) Petrol 115 09/08 →

216 CDI (906.111, 906.113, 906.211, 906.213) Diesel 120 03/09 →

219 CDI / BlueTEC
(906.111, 906.113, 906.211, 906.213) Diesel 140 03/09 →

SPRINTER 4,6-t Furgonato (906)

416 CDI
(906.653, 906.655, 906.657) Diesel 120 03/09 →

SPRINTER 4,6-t Pianale piatto/Telaio (906)

413 CDI
(906.153, 906.155, 906.253, 906.255) Diesel 95 06/06 →

416 CDI
(906.153, 906.155, 906.253, 906.255) Diesel 120 03/09 →

SPRINTER 4-t Autobus (904)

414 Petrol 105 02/96 → 05/06

408 CDI Diesel 60 04/00 → 05/06

411 CDI Diesel 80 04/00 → 05/06

413 CDI Diesel 95 04/00 → 05/06

416 CDI Diesel 115 04/00 → 05/06

SAG023-1



MERCEDES-BENZ

SPRINTER 4-t Furgonato (904)

414 Petrol 105 02/96 → 05/06

408 CDI Diesel 60 04/00 → 05/06

411 CDI Diesel 80 04/00 → 05/06

411 CDI 4x4 Diesel 80 04/00 → 05/06

413 CDI Diesel 95 04/00 → 05/06

413 CDI 4x4 Diesel 95 04/00 → 05/06

414 4x4 Petrol 105 05/97 → 05/06

416 CDI Diesel 115 04/00 → 05/06

416 CDI 4x4 Diesel 115 04/00 → 05/06

SPRINTER 4-t Pianale piatto/Telaio (904)

414 Petrol 105 02/96 → 05/06

408 CDI Diesel 60 04/00 → 05/06

411 CDI Diesel 80 04/00 → 05/06

411 CDI 4x4 Diesel 80 04/00 → 05/06

413 CDI Diesel 95 04/00 → 05/06

413 CDI 4x4 Diesel 95 04/00 → 05/06

414 4x4 Petrol 105 05/97 → 05/06

416 CDI Diesel 115 04/00 → 05/06

416 CDI 4x4 Diesel 115 04/00 → 05/06

SPRINTER 5-t Furgonato (906)

509 CDI (906.653, 906.655, 906.657) Diesel 65 06/06 →

511 CDI (906.653, 906.655, 906.657) Diesel 80 06/06 →

513 CDI (906.653, 906.655, 906.657) Diesel 95 03/09 →

515 CDI (906.653, 906.655, 906.657) Diesel 110 06/06 →

SPRINTER 5-t Pianale piatto/Telaio (905)

616 CDI (905.612, 905.613, 905.622, 905.623) Diesel 115 04/01 → 05/06

SPRINTER 5-t Pianale piatto/Telaio (906)

509 CDI (906.153, 906.155, 906.253, 906.255) Diesel 65 06/06 →

510 CDI (906.153, 906.155, 906.253, 906.255) Diesel 70 03/09 →

511 CDI (906.153, 906.155, 906.253, 906.255) Diesel 80 06/06 →

SAG023-1

MERCEDES-BENZ
SPRINTER 5-t Pianale piatto/Telaio (906)

513 CDI (906.135, 906.155, 906.253, 906.255)	Diesel	95	06/06 →	
515 CDI (906.153, 906.155, 906.253, 906.255)	Diesel	110	06/06 →	
516 (906.153, 906.155, 906.253, 906.255)	Petrol	115	09/08 →	
516 NGT (906.153, 906.155, 906.253, 906.255)	Petrol/ CNG	115	09/08 →	

SPRINTER Ribaltabile (905)

616 CDI (905.612, 905.622, 905.623)	Diesel	115	04/01 →	
-------------------------------------	--------	-----	---------	--

VANEO (414)

1.6 (414.700)	Petrol	60	02/02 → 07/05	
1.6 (414.700)	Petrol	75	02/02 → 07/05	
1.7 CDI (414.700)	Diesel	55	02/02 → 07/05	
1.7 CDI (414.700)	Diesel	67	02/02 → 07/05	
1.9 (414.700)	Petrol	92	02/02 → 07/05	ENGINE: 30040047 →

VIANO (W639)

3,0	Petrol	140	09/03 →	
3.2	Petrol	160	09/03 →	
3.7	Petrol	170	06/04 →	
CDI 2.0	Diesel	80	09/03 →	
CDI 2.0	Diesel	85	08/05 →	
CDI 2.0 4-matic	Diesel	80	07/05 →	
CDI 2.2	Diesel	110	09/03 →	
CDI 2.2 4-matic	Diesel	110	03/06 →	

VITO / MIXTO Furgonato (W639)

119	Petrol	140	09/03 →	
122	Petrol	160	09/03 →	
109 CDI	Diesel	65	09/03 → 07/06	
109 CDI	Diesel	70	08/06 →	
111 CDI	Diesel	80	09/03 →	
111 CDI	Diesel	85	09/07 →	
111 CDI 4x4	Diesel	80	09/07 →	
115 CDI	Diesel	110	09/03 →	
115 CDI 4x4	Diesel	110	07/06 →	

SAG023-1

MERCEDES-BENZ
VITO Autobus (638)

108 CDI 2.2 (638.194)	Diesel	60	03/99 → 07/03	
110 CDI 2.2 (638.194)	Diesel	75	03/99 → 07/03	
112 CDI 2.2 (638.194)	Diesel	90	03/99 → 07/03	

VITO Autobus (W639)

119	Petrol	140	09/03 →	
122	Petrol	160	09/03 →	
123	Petrol	170	06/04 →	
109 CDI	Diesel	65	09/03 → 07/06	
109 CDI	Diesel	70	09/06 →	
109 CDI 4x4	Diesel	70	09/07 →	
111 CDI	Diesel	80	09/03 →	
111 CDI (639.701)	Diesel	85	09/07 →	
111 CDI 4x4	Diesel	80	09/07 →	
115 CDI	Diesel	110	09/03 →	
115 CDI 4x4	Diesel	110	09/07 →	

VITO Furgonato (638)

108 CDI 2.2 (638.094)	Diesel	60	03/99 → 07/03	
110 CDI 2.2 (638.094)	Diesel	75	03/99 → 07/03	
112 CDI 2.2 (638.094)	Diesel	90	03/99 → 07/03	

SAG024
H1 **SENSORE GIRI / FASE - ALBERO MOTORE**
CRANKSHAFT POSITION SENSOR

MERCEDES-BENZ
CLASSE C (W202)

C 240 (202.026)	Petrol	125	06/97 → 05/00	
C 280 (202.029)	Petrol	145	06/97 → 05/00	

SAG024-1

H1 **SENSORE GIRI / FASE - ALBERO MOTORE**
CRANKSHAFT POSITION SENSOR



MERCEDES-BENZ

CLASSE C (W202)

C 240 (202.026)	Petrol	125	06/97 → 05/00
C 280 (202.029)	Petrol	145	06/97 → 05/00

SAG025

H1 **SENSORE GIRI / FASE - ALBERO MOTORE**
CRANKSHAFT POSITION SENSOR



FIAT

500 (312)

1.3 D Multijet	Diesel	55	10/07 →
----------------	--------	----	---------

DOBLO (119)

1.3 D Multijet	Diesel	62	10/05 →
----------------	--------	----	---------

DOBLO Cargo (223)

1.3 D Multijet	Diesel	55	10/05 → 01/10
1.3 JTD 16V	Diesel	51	05/04 → 12/06

IDEA

1.3 D Multijet	Diesel	66	10/05 →
1.3 JTD	Diesel	51	01/04 →

LINEA (323)

1.3 D Multijet	Diesel	66	06/07 →
----------------	--------	----	---------

PANDA (169)

1.3 D Multijet	Diesel	51	09/03 →
1.3 D Multijet 4x4	Diesel	51	10/04 →

SAG025



FIAT

PANDA Van (169)

1.3 JTD	Diesel	51	03/04 →
1.3 JTD	Diesel	55	01/06 →

PUNTO (188)

1.3 JTD 16V	Diesel	51	06/03 →
-------------	--------	----	---------

PUNTO / GRANDE PUNTO (199)

1.3 D Multijet	Diesel	66	10/05 →
1.3 D Multijet	Diesel	55	10/05 →

PUNTO Van (188AX)

1.3 JTD	Diesel	51	06/03 → 10/05
---------	--------	----	---------------

STRADA Pick-up (178E)

1.3 D Multijet	Diesel	62	05/06 →
----------------	--------	----	---------

LANCIA

MUSA (350)

1.3 D Multijet	Diesel	51	10/04 →
1.3 D Multijet	Diesel	66	09/06 →

YPSILON (843)

1.3 D Multijet	Diesel	55	09/06 → 12/11
1.3 D Multijet	Diesel	66	09/06 → 12/11
1.3 JTD	Diesel	51	10/03 → 12/11

OPEL

AGILA (A) (H00)

1.3 CDTI	Diesel	51	08/03 → 12/07
1.3 CDTI	Diesel	55	04/08 →

ASTRA H (L48)

1.3 CDTI	Diesel	66	08/05 →
----------	--------	----	---------

ASTRA H GTC (L08)

1.3 CDTI	Diesel	66	04/05 →
----------	--------	----	---------

ASTRA H Station wagon (L35)

1.3 CDTI	Diesel	66	08/05 →
----------	--------	----	---------

COMBO Cassone / Furgonato / Promiscuo

1.3 CDTI 16V	Diesel	51	08/05 →
1.3 CDTI 16V	Diesel	55	10/05 →

COMBO Tour

1.3 CDTI 16V	Diesel	51	10/04 →
1.3 CDTI 16V	Diesel	55	10/05 →

CORSA C (F08, F68)

1.3 CDTI	Diesel	51	06/03 → 12/09
----------	--------	----	---------------

CORSA C Furgonato (F08, W5L)

1.3 CDTI 16V	Diesel	51	08/05 →
--------------	--------	----	---------

CORSA D

1.3 CDTI	Diesel	55	07/06 →
1.3 CDTI	Diesel	66	07/06 →

SAG025

OPEL
MERIVA

1.3 CDTI	Diesel	51	04/05 → 05/10
1.3 CDTI	Diesel	55	09/03 → 05/10

TIGRA TwinTop

1.3 CDTI	Diesel	51	06/04 →
----------	--------	----	---------

SUZUKI
IGNIS II

1.3 DDiS	Diesel	51	09/03 →
----------	--------	----	---------

SWIFT III (MZ, EZ)

1.3 DDiS	Diesel	51	08/05 →
1.3 DDiS	Diesel	55	08/05 →

WAGON R+ (MM)

1.3 DDiS	Diesel	51	09/03 →
----------	--------	----	---------

VAUXHALL
AGILA Mk II (B)

1.3 CDTI	Diesel	55	01/08 →
----------	--------	----	---------

ASTRA Mk V (H) 2 volumi /Coda spiovente

1.3 CDTI	Diesel	66	01/04 → 05/09
----------	--------	----	---------------

ASTRA Mk V (H) Station wagon

1.3 CDTI	Diesel	66	08/04 → 03/09
----------	--------	----	---------------

COMBO Mk II (C) Cassone / Furgonato / Promiscuo (F25)

1.3 CDTI 16V	Diesel	55	10/05 → 11/11
--------------	--------	----	---------------

CORSA Mk II (C) (W5L, F08)

1.3 CDTI 16V	Diesel	52	08/00 → 09/06
--------------	--------	----	---------------

CORSA Mk III (D) (L_8)

1.3 CDTI	Diesel	55	11/06 →
1.3 CDTI	Diesel	66	11/06 →

CORSAVAN Mk II (C)

1.3 CDTI 16V	Diesel	52	04/04 → 06/06
--------------	--------	----	---------------

MERIVA Mk I (A)

1.3 CDTI	Diesel	55	01/03 → 10/09
----------	--------	----	---------------

TIGRA TwinTop

1.3 CDTI	Diesel	51	06/04 → 08/09
----------	--------	----	---------------

SAG026
**H1 SENSORE GIRI / FASE - ALBERO MOTORE
CRANKSHAFT POSITION SENSOR**

AUDI
100 (4A, C4)

2.0	Petrol	74	01/93 → 06/94
2.0 E	Petrol	85	01/93 → 06/94
2.0 E 16V	Petrol	103	01/93 → 06/94
2.0 E 16V quattro	Petrol	103	01/93 → 06/94
2.3 E	Petrol	98	01/93 → 06/94
2.3 E quattro	Petrol	98	01/93 → 06/94
2.4 D	Diesel	60	01/93 → 06/94
2.5 TDI	Diesel	85	01/93 → 06/94
2.6	Petrol	110	01/93 → 06/94
2.6 quattro	Petrol	110	01/93 → 06/94
2.8 E	Petrol	128	01/93 → 06/94
2.8 E quattro	Petrol	128	01/93 → 06/94

100 Avant (4A, C4)

2.0 E	Petrol	74	01/93 → 06/94
2.0 E	Petrol	85	01/93 → 06/94
2.0 E 16V	Petrol	103	01/93 → 06/94
2.0 E 16V quattro	Petrol	103	01/93 → 06/94
2.3 E	Petrol	98	01/93 → 06/94
2.3 E quattro	Petrol	98	01/93 → 06/94
2.4 D	Diesel	60	01/93 → 06/94
2.5 TDI	Diesel	85	01/93 → 06/94
2.6	Petrol	110	01/93 → 06/94
2.6 quattro	Petrol	110	01/93 → 06/94
2.8 E	Petrol	128	01/93 → 06/94
2.8 E quattro	Petrol	128	01/93 → 06/94

80 (8C, B4)

2.0	Petrol	66	01/92 → 12/94
2.0 E	Petrol	85	01/92 → 12/94
2.0 E quattro	Petrol	85	01/92 → 12/94
2.8	Petrol	128	01/92 → 12/94
2.8 quattro	Petrol	128	01/92 → 12/94

SAG026



KW



AUDI

80 Avant (8C, B4)

2.0	Petrol	66	07/92 → 01/96
2.0 E	Petrol	85	07/92 → 01/96
2.0 E 16V	Petrol	103	02/93 → 01/96
2.8	Petrol	128	01/92 → 01/96
2.8 quattro	Petrol	128	08/92 → 07/95

A4 (8D2, B5)

1.6	Petrol	74	11/94 → 07/97
1.8	Petrol	92	01/95 → 07/97
1.8 quattro	Petrol	92	01/95 → 07/97
1.9 TDI	Diesel	81	10/95 → 07/97
1.9 TDI	Diesel	66	01/95 → 07/96

A4 Avant (8D5, B5)

1.6	Petrol	74	11/94 → 07/97
1.8	Petrol	92	02/96 → 07/97
1.8 quattro	Petrol	92	01/96 → 07/97
1.9 TDI	Diesel	66	02/96 → 07/96
1.9 TDI	Diesel	81	02/96 → 07/97

A6 (4A, C4)

1.8	Petrol	92	12/95 → 10/97
1.8 quattro	Petrol	92	12/95 → 10/97
1.9 TDI	Diesel	66	06/94 → 09/96
2.0	Petrol	85	06/94 → 08/96

A6 Avant (4A, C4)

1.8	Petrol	92	12/95 → 12/97
1.8 quattro	Petrol	92	12/95 → 12/97
1.9 TDI	Diesel	66	06/94 → 09/96
2.0	Petrol	85	06/94 → 08/96

CABRIOLET (8G7, B4)

2.8	Petrol	128	11/92 → 08/00
-----	--------	-----	---------------

COUPE (89, 8B)

2.8	Petrol	128	09/91 → 12/96
2.8 quattro	Petrol	128	08/91 → 12/96

FIAT

TEMPRA (159)

1.8 i.e. (159.AN)	Petrol	77	03/92 → 08/96
1.8 i.e. (159.AV)	Petrol	76	09/93 → 08/96
1.8 i.e. (159.AZ)	Petrol	66	09/93 → 08/96
1.8 i.e. (159.BY)	Petrol	74	10/94 → 08/96
2.0 i.e. (159.AP)	Petrol	83	10/90 → 08/96

TEMPRA S.W. (159)

1.8 i.e. (159.AV)	Petrol	76	09/93 → 08/96
1.8 i.e. (159.AZ)	Petrol	66	09/93 → 08/96
1.8 i.e. (159.BY)	Petrol	74	10/94 → 08/96
2.0 i.e. (159.AP)	Petrol	83	01/91 → 03/95

SAG026



KW



FIAT

TEMPRA S.W. (159)

2.0 i.e. 4x4 (159.AP)	Petrol	83	03/92 → 03/95
-----------------------	--------	----	---------------

TIPO (160)

1.8 i.e.	Petrol	66	09/93 → 04/95
1.8 i.e. (160.ED)	Petrol	76	04/93 → 04/95
2.0 i.e. (160.AT, 160.AJ)	Petrol	83	03/90 → 04/95

FORD

GALAXY (WGR)

1.9 TDI	Diesel	81	08/97 → 04/00
2.0 i	Petrol	85	11/95 → 05/06
2.3 16V	Petrol	103	09/01 → 05/06
2.8 i V6	Petrol	128	11/95 → 04/00
2.8 i V6 4x4	Petrol	128	04/96 → 04/00

LANCIA

DEDRA (835)

1.6 i.e. (835.AN)	Petrol	55	04/93 → 07/99
1.8 i.e. (835.AT)	Petrol	66	08/93 → 07/99
1.8 i.e. (835.BD, 835.AD)	Petrol	77	09/89 → 07/99
2.0 i.e. (835.AL)	Petrol	83	09/89 → 07/99

VOLKSWAGEN

CORRADO (53I)

1.8 G60	Petrol	118	09/88 → 09/93
2.0 i	Petrol	85	04/93 → 12/95

GOLF III (1H1)

1.4	Petrol	44	10/91 → 08/97
1.4	Petrol	40	11/91 → 08/97
1.6	Petrol	55	09/92 → 08/97
1.8	Petrol	55	11/91 → 08/97
2.0	Petrol	85	11/91 → 08/97

GOLF III Cabriolet (1E7)

1.8	Petrol	55	07/93 → 05/98
2.0	Petrol	85	07/93 → 05/98

GOLF III Variant (1H5)

1.4	Petrol	40	07/93 → 04/99
1.4	Petrol	44	07/93 → 04/99
1.8	Petrol	55	07/93 → 04/99
2.0	Petrol	85	07/93 → 04/99

PASSAT (3A2, 35I)

1.8	Petrol	55	09/91 → 08/96
2.0	Petrol	85	09/91 → 08/96
2.8 VR6	Petrol	128	06/91 → 08/96

SAG026

VOLKSWAGEN
PASSAT Variant (3A5, 35I)

1.8	Petrol	55	09/91 → 05/97
2.0	Petrol	85	09/91 → 05/97
2.8 VR6	Petrol	128	06/91 → 05/97

VENTO (1H2)

1.4	Petrol	44	11/91 → 09/98
1.4	Petrol	40	11/91 → 09/98
1.6	Petrol	55	09/92 → 09/98
1.8	Petrol	55	11/91 → 09/98

SAG027
H1 **SENSORE GIRI / FASE - ALBERO MOTORE
CRANKSHAFT POSITION SENSOR**

CITROËN
BERLINGO (MF)

1.8 D (MFA9A)	Diesel	43	09/99 →
1.8 i (MFLFX)	Petrol	66	09/99 →
1.8 i 4WD (MFLFX)	Petrol	66	09/99 →
1.9 D (MFWJZ)	Diesel	51	09/99 →
1.9 D 4WD (MFWJZ)	Diesel	51	09/99 →
2.0 HDI 90 (MFRHY)	Diesel	66	12/99 →
electrique	Electric	16	01/00 →

BERLINGO Furgonato (M_)

1.9 D 70 (MBWJZ, MCWJZ)	Diesel	51	09/99 →
1.9 D 70 4WD (MBWJZ, MCWJZ)	Diesel	51	09/99 →
2.0 HDI 90 (MBRHY, MCRHY)	Diesel	66	12/99 →

SAG027

CITROËN
EVASION (22, U6)

1.8	Petrol	73	09/99 → 07/02
1.9 TD	Diesel	66	09/99 → 07/02
2.0	Petrol	89	09/99 → 07/02
2.0 16V	Petrol	100	05/00 → 07/02
2.0 16V	Petrol	97	09/99 → 04/00
2.0 HDi	Diesel	80	08/99 → 07/02
2.0 Turbo C.T.	Petrol	108	09/99 → 07/02

JUMPY (U6U)

1.9 D 70	Diesel	51	09/99 →
2.0	Petrol	100	04/00 → 12/06
2.0 HDi 110	Diesel	80	03/00 →
2.0 HDi 95	Diesel	69	10/99 →
2.0 i 16V	Petrol	102	03/00 →

JUMPY Furgonato (BS_, BT_, BY_, BZ_)

1.6 i	Petrol	58	09/99 →
1.9 D 70	Diesel	51	09/99 →
1.9 TD	Diesel	66	09/99 →
2.0 HDi 95	Diesel	69	10/99 →
2.0 i 16V	Petrol	102	03/00 →

JUMPY Pianale piatto/Telaio (BU_, BV_, BW_, BX_)

1.9 TD	Diesel	68	10/99 →
--------	--------	----	---------

SAXO (S0, S1)

1.0 X	Petrol	37	09/99 → 06/03
1.1 X,SX	Petrol	44	09/99 → 09/03

XANTIA (X2)

1.8 i	Petrol	66	09/99 → 04/03
1.8 i 16V	Petrol	81	09/99 → 04/03
1.9 SD	Diesel	55	09/99 → 04/03
1.9 Turbo D	Diesel	66	09/99 → 04/03
2.0 HDI 109	Diesel	80	09/99 → 04/03
2.0 HDI 90	Diesel	66	09/99 → 04/03
2.0 i	Petrol	89	09/99 → 04/03
2.0 i 16V	Petrol	97	09/99 → 04/03
2.0 Turbo	Petrol	108	09/99 → 04/03
3.0 V6	Petrol	140	09/99 → 04/03

XANTIA Break (X2)

1.8 i	Petrol	66	09/99 → 04/03
1.8 i 16V	Petrol	81	09/99 → 04/03
1.9 SD	Diesel	55	09/99 → 04/03
1.9 Turbo D	Diesel	66	09/99 → 04/03
2.0 HDI 109	Diesel	80	09/99 → 04/03
2.0 HDI 90	Diesel	66	09/99 → 04/03
2.0 i	Petrol	89	09/99 → 04/03
2.0 i 16V	Petrol	97	09/99 → 04/03

SAG027



KW



CITROËN

XANTIA Break (X2)

2.0 Turbo	Petrol	108	09/99 → 04/03
3.0 V6	Petrol	140	09/99 → 04/03

XM (Y4)

2.0 i 16V	Petrol	97	09/99 → 10/00
2.0 Turbo	Petrol	108	09/99 → 10/00
2.1 TD 12V	Diesel	80	09/99 → 10/00
2.5 TD	Diesel	95	09/99 → 10/00
3.0 V6	Petrol	123	09/99 → 10/00
3.0 V6	Petrol	140	09/99 → 10/00
3.0 V6 24V	Petrol	147	09/99 → 10/00

XM Break (Y4)

2.0 i 16V	Petrol	97	09/99 → 10/00
2.1 TD 12V	Diesel	80	09/99 → 10/00
2.5 TD	Diesel	95	09/99 → 10/00
3.0 V6	Petrol	123	09/99 → 10/00
3.0 V6	Petrol	140	09/99 → 10/00

XSARA (N1)

1.4 i	Petrol	55	09/99 → 03/05
1.5 D	Diesel	42	09/99 → 09/00
1.6 16V	Petrol	80	09/00 → 03/05
1.6 i	Petrol	65	09/99 → 09/00
1.8 D	Diesel	43	09/99 → 09/00
1.8 i	Petrol	66	09/99 → 09/00
1.8 i 16V	Petrol	81	09/99 → 09/00
1.8 i Aut.	Petrol	74	09/99 → 09/00
1.8 TD	Diesel	66	09/99 → 09/00
1.9 D	Diesel	50	09/99 → 09/00
1.9 D	Diesel	51	09/99 → 03/05
1.9 SD	Diesel	55	09/99 → 09/00
1.9 TD	Diesel	66	09/99 → 09/00
2.0 16V	Petrol	100	09/00 → 03/05
2.0 16V	Petrol	120	09/99 → 09/00
2.0 16V	Petrol	97	09/99 → 09/00
2.0 HDI 90	Diesel	66	09/99 → 03/05

XSARA Break (N2)

1.4 i	Petrol	55	09/99 → 08/05
1.5 D	Diesel	42	09/99 → 09/00
1.6 16V	Petrol	80	09/00 → 08/05
1.6 i	Petrol	65	09/99 → 09/00
1.8 D	Diesel	43	09/99 → 09/00
1.8 i	Petrol	66	09/99 → 09/00
1.8 i 16V	Petrol	81	09/99 → 09/00
1.8 i Aut.	Petrol	74	09/99 → 09/00
1.9 D	Diesel	50	09/99 → 09/00

SAG027



KW



CITROËN

XSARA Break (N2)

1.9 D	Diesel	51	09/99 → 08/05
1.9 D	Diesel	55	09/99 → 09/00
1.9 TD	Diesel	66	09/99 → 09/00
2.0 16V	Petrol	100	09/00 → 08/05
2.0 16V	Petrol	97	09/99 → 09/00
2.0 HDI 90	Diesel	66	09/99 → 08/05

XSARA Coupé (N0)

1.4 i	Petrol	55	09/99 → 03/05
1.6 16V	Petrol	80	09/00 → 03/05
1.6 i	Petrol	65	09/99 → 09/00
1.8 i	Petrol	66	09/99 → 09/00
1.8 i 16V	Petrol	81	09/99 → 09/00
1.9 D	Diesel	51	09/99 → 03/05
2.0 16V	Petrol	100	09/00 → 03/05
2.0 i 16V	Petrol	120	09/99 → 03/05

XSARA PICASSO (N68)

1.6	Petrol	70	12/99 →
1.6	Petrol	65	12/99 →
1.8 16V	Petrol	85	02/00 →
2.0 HDi	Diesel	66	12/99 →

FIAT

SCUDO Combinato (220P)

1.9 D	Diesel	51	09/99 → 12/06
1.9 TD Eco	Diesel	66	09/99 → 12/06
2.0 JTD	Diesel	80	12/99 → 12/06

SCUDO Furgonato (220L)

1.6	Petrol	58	09/99 → 12/06
1.9 D	Diesel	51	09/99 → 12/06
1.9 D	Diesel	51	09/99 → 12/06
1.9 TD	Diesel	66	09/99 → 12/06
1.9 TD	Diesel	68	09/99 → 12/06
2.0 JTD	Diesel	69	12/99 → 12/06

ULYSSE (220)

1.8 (220.BB5)	Petrol	73	09/99 → 08/02
1.9 TD (220AH5)	Diesel	66	09/99 → 08/02
2.0 (220.AC5)	Petrol	89	09/99 → 08/02
2.0 16V	Petrol	100	09/00 → 08/02
2.0 16V	Petrol	97	09/99 → 09/00
2.0 JTD	Diesel	80	10/99 → 08/02
2.0 Turbo (220.AD5)	Petrol	108	09/99 → 08/02

SAG027

KW

LANCIA
ZETA (220)

2.0 16V (220AL5) Petrol 97 09/99 → 07/00

2.0 16V (220AQ5) Petrol 100 07/00 → 09/02

2.0 JTD (220AN5) Diesel 80 09/99 → 09/02

2.0 Turbo (220AD5, 220CD5) Petrol 108 09/99 → 09/02

PEUGEOT
106 II (1)

1.0 i Petrol 37 09/99 →

1.1 i Petrol 40 09/99 →

206 2 volumi /Coda spiovente (2A/C)

1.1 i Petrol 44 09/99 →

1.4 i Petrol 55 09/99 →

1.6 i Petrol 65 09/99 → 12/00

1.9 D Diesel 51 09/99 → 11/01

2.0 HDI 90 Diesel 66 12/99 →

2.0 S16 Petrol 100 06/99 →

2.0 S16 Petrol 99 09/99 → 10/00

206 CC (2D)

2.0 S16 Petrol 100 09/00 →

306 (7B, N3, N5)

1.1 Petrol 44 09/99 → 05/01

1.4 SL Petrol 55 09/99 → 05/01

1.6 Petrol 72 10/00 → 05/01

1.6 SR Petrol 65 09/99 → 10/00

1.8 16V Petrol 81 09/99 → 05/01

1.8 ST Petrol 74 09/99 → 05/01

1.9 D Diesel 51 09/99 → 05/01

1.9 D Diesel 55 09/99 → 05/01

1.9 SLD Diesel 47 09/99 → 05/01

1.9 SLD Diesel 50 09/99 → 05/01

1.9 SRDT Diesel 66 09/99 → 05/01

2.0 Petrol 97 09/99 → 05/01

2.0 HDI 90 Diesel 66 09/99 → 05/01

2.0 S16 Petrol 110 09/99 → 05/01

2.0 S16 Petrol 112 09/99 → 05/01

2.0 ST Petrol 89 09/99 → 05/01

306 2 volumi /Coda spiovente (7A, 7C, N3, N5)

1.1 Petrol 44 09/99 → 05/01

1.4 Petrol 55 09/99 → 05/01

1.6 Petrol 72 10/00 → 05/01

1.6 Petrol 65 09/99 → 10/00

SAG027

KW

PEUGEOT
306 2 volumi /Coda spiovente (7A, 7C, N3, N5)

1.8 Petrol 74 09/99 → 05/01

1.8 16V Petrol 81 09/99 → 05/01

1.8 D Diesel 43 09/99 → 05/01

1.9 D Diesel 47 09/99 → 05/01

1.9 D Diesel 50 09/99 → 05/01

1.9 D Diesel 51 09/99 → 05/01

1.9 D Diesel 55 09/99 → 05/01

1.9 DT Diesel 66 09/99 → 05/01

2.0 16V Petrol 97 09/99 → 05/01

2.0 HDI 90 Diesel 66 09/99 → 05/01

2.0 S16 Petrol 110 09/99 → 05/01

2.0 S16 Petrol 112 09/99 → 05/01

2.0 XSi Petrol 89 09/99 → 05/01

306 Break (7E, N3, N5)

1.4 Petrol 55 09/99 → 04/02

1.6 Petrol 65 09/99 → 10/00

1.6 Petrol 72 10/00 → 04/02

1.8 Petrol 74 09/99 → 04/02

1.8 16V Petrol 81 09/99 → 04/02

1.9 D Diesel 50 09/99 → 04/02

1.9 D Diesel 51 09/99 → 04/02

1.9 D Diesel 55 09/99 → 04/02

1.9 TD Diesel 66 09/99 → 04/02

2.0 Petrol 97 09/99 → 04/02

306 Cabriolet (7D, N3, N5)

1.6 Petrol 72 10/00 → 04/02

1.8 Petrol 74 09/99 → 04/02

1.8 16V Petrol 81 07/00 → 04/02

2.0 Petrol 89 09/99 → 04/02

2.0 16V Petrol 97 09/99 → 04/02

406 (8B)

1.6 Petrol 65 09/99 → 05/04

1.8 Petrol 66 09/99 → 05/04

1.8 16V Petrol 85 10/00 → 05/04

1.8 16V Petrol 81 09/99 → 10/00

1.9 D Diesel 55 09/99 → 05/04

1.9 TD Diesel 66 09/99 → 05/04

2.0 16V Petrol 100 08/00 → 06/04

2.0 16V Petrol 97 09/99 → 05/04

2.0 16V Petrol 99 09/99 → 08/00

2.0 HDi 110 Diesel 80 09/99 → 08/01

2.0 HDI 90 Diesel 66 09/99 → 05/04

2.1 TD 12V Diesel 80 09/99 → 05/04

2.2 Petrol 116 07/00 → 05/04

SAG027



KW



PEUGEOT

406 (8B)

2.2 HDi	Diesel	98	03/00 → 05/04
3.0 V6	Petrol	152	03/00 → 05/04

406 Break (8E/F)

1.8	Petrol	66	09/99 → 10/04
1.8 16V	Petrol	85	10/00 → 10/04
2.0 16V	Petrol	100	10/00 → 10/04
2.0 16V	Petrol	99	09/99 → 10/00
2.0 HDi 110	Diesel	80	09/99 → 04/04
2.0 HDi 90	Diesel	66	09/99 → 10/04
2.2	Petrol	116	07/00 → 10/04
2.2 HDi	Diesel	98	03/00 → 10/04
3.0 V6	Petrol	152	03/00 → 10/04

406 Coupé (8C)

2.0 16V	Petrol	100	10/00 → 12/04
2.0 16V	Petrol	97	09/99 → 12/04
2.0 16V	Petrol	99	09/99 → 10/00
2.2 HDi	Diesel	98	03/00 → 12/04
3.0 V6	Petrol	152	03/00 → 12/04
3.0 V6 24V	Petrol	140	09/99 → 12/04

607 (9D, 9U)

2.0	Petrol	100	02/00 →
2.0 HDi	Diesel	80	05/00 →
2.2 16V	Petrol	116	02/00 →
2.2 HDi	Diesel	98	02/00 →
3.0 V6 24V	Petrol	152	02/00 →

806 (221)

2.0 HDi	Diesel	80	09/99 → 08/02
---------	--------	----	---------------

EXPERT (224)

1.9 TD	Diesel	66	09/99 →
2.0	Petrol	100	07/00 →
2.0 HDi	Diesel	80	07/00 →

EXPERT Furgonato (222)

1.6	Petrol	58	09/99 →
1.9 D	Diesel	51	09/99 →
1.9 TD	Diesel	66	09/99 →
1.9 TD	Diesel	68	09/99 →
2.0 HDi	Diesel	69	07/00 →

EXPERT Pianale piatto/Telaio (223)

1.6	Petrol	58	09/99 →
1.9 D	Diesel	51	09/99 →
1.9 TD	Diesel	66	09/99 →
1.9 TD	Diesel	68	09/99 →

RANCH Furgonato (5)

2.0 HDi	Diesel	66	04/00 →
---------	--------	----	---------

SAG027



KW



PEUGEOT

RANCH MPV / Space wagon (5F)

2.0 HDi	Diesel	66	02/00 →
---------	--------	----	---------

RENAULT

CLIO II (BB0/1/2_, CB0/1/2_)

1.4 16V (B/CB0L)	Petrol	70	10/99 → 09/04
1.6 (B/CB0D)	Petrol	66	09/99 → 05/05

KANGOO (KC0/1_)

1.4 (KC0C, KC0H, KC0B, KC0M)	Petrol	55	09/99 →
------------------------------	--------	----	---------

KANGOO Express (FC0/1_)

1.4 (FC0C, FC0B, FC0H, FC0M)	Petrol	55	09/99 →
------------------------------	--------	----	---------

MEGANE I (BA0/1_)

2.0 i (BA0G)	Petrol	84	09/99 → 08/03
--------------	--------	----	---------------

MEGANE I Cabriolet (EA0/1_)

2.0 (EA0G)	Petrol	84	09/99 → 08/03
------------	--------	----	---------------

MEGANE I Coach (DA0/1_)

2.0 i (DA0G)	Petrol	84	09/99 → 08/03
--------------	--------	----	---------------

SAG028

H1

SENSORE GIRI / FASE - ALBERO MOTORE
CRANKSHAFT POSITION SENSOR

KW



CITROËN

BERLINGO (MF)

1.8 D (MFA9A)	Diesel	43	07/98 →
1.8 i (MFLFX)	Petrol	66	05/97 →
1.8 i 4WD (MFLFX)	Petrol	66	04/97 →
1.9 D (MFWJZ)	Diesel	51	07/98 →
1.9 D 4WD (MFWJZ)	Diesel	51	07/98 →

SAG028

CITROËN
BERLINGO Furgonato (M_)

1.9 D 70 (MBWJZ, MCWJZ)	Diesel	51	04/99 →	
1.9 D 70 4WD (MBWJZ, MCWJZ)	Diesel	51	07/98 →	

EVASION (22, U6)

1.8	Petrol	73	05/97 → 07/02	
1.9 TD	Diesel	66	11/94 → 07/02	
2.0	Petrol	89	06/94 → 07/02	
2.0 16V	Petrol	97	05/98 → 04/00	
2.0 Turbo C.T.	Petrol	108	06/94 → 07/02	

JUMPY (U6U)

1.9 D 70	Diesel	51	04/98 →	
----------	--------	----	---------	--

JUMPY Furgonato (BS_, BT_, BY_, BZ_)

1.6 i	Petrol	58	10/95 →	
1.9 D 70	Diesel	51	04/98 →	
1.9 TD	Diesel	66	10/95 →	

SAXO (S0, S1)

1.0 X	Petrol	37	05/98 → 06/03	
1.1 X,SX	Petrol	44	05/96 → 09/03	

XANTIA (X2)

1.8 i	Petrol	66	01/98 → 04/03	
1.8 i 16V	Petrol	81	01/98 → 04/03	
1.9 SD	Diesel	55	01/98 → 04/03	
1.9 Turbo D	Diesel	66	01/98 → 04/03	
2.0 HDI 109	Diesel	80	02/99 → 04/03	
2.0 HDI 90	Diesel	66	03/99 → 04/03	
2.0 i	Petrol	89	01/98 → 04/03	
2.0 i 16V	Petrol	97	01/98 → 04/03	
2.0 Turbo	Petrol	108	01/98 → 04/03	
3.0 V6	Petrol	140	01/98 → 04/03	

XANTIA Break (X2)

1.8 i	Petrol	66	01/98 → 04/03	
1.8 i 16V	Petrol	81	01/98 → 04/03	
1.9 SD	Diesel	55	01/98 → 04/03	
1.9 Turbo D	Diesel	66	01/98 → 04/03	
2.0 HDI 109	Diesel	80	02/99 → 04/03	
2.0 HDI 90	Diesel	66	03/99 → 04/03	
2.0 i	Petrol	89	01/98 → 04/03	
2.0 i 16V	Petrol	97	01/98 → 04/03	
2.0 Turbo	Petrol	108	01/98 → 04/03	
3.0 V6	Petrol	140	01/98 → 04/03	

SAG028

CITROËN
XM (Y4)

2.0 i 16V	Petrol	97	05/94 → 10/00	
2.0 Turbo	Petrol	108	05/94 → 10/00	
2.1 TD 12V	Diesel	80	05/94 → 10/00	
2.5 TD	Diesel	95	05/94 → 10/00	
3.0 V6	Petrol	140	04/97 → 10/00	
3.0 V6	Petrol	123	05/94 → 10/00	
3.0 V6 24V	Petrol	147	05/94 → 10/00	

XM Break (Y4)

2.0 i 16V	Petrol	97	05/94 → 10/00	
2.1 TD 12V	Diesel	80	05/94 → 10/00	
2.5 TD	Diesel	95	05/94 → 10/00	
3.0 V6	Petrol	140	04/97 → 10/00	
3.0 V6	Petrol	123	05/94 → 10/00	

XSARA (N1)

1.4 i	Petrol	55	04/97 → 03/05	
1.5 D	Diesel	42	04/97 → 09/00	
1.6 i	Petrol	65	04/97 → 09/00	
1.8 D	Diesel	43	04/97 → 09/00	
1.8 i	Petrol	66	04/97 → 09/00	
1.8 i 16V	Petrol	81	04/97 → 09/00	
1.8 i Aut.	Petrol	74	04/97 → 09/00	
1.8 TD	Diesel	66	10/97 → 09/00	
1.9 D	Diesel	51	07/98 → 03/05	
1.9 D	Diesel	50	04/97 → 09/00	
1.9 SD	Diesel	55	01/98 → 09/00	
1.9 TD	Diesel	66	04/97 → 09/00	
2.0 16V	Petrol	120	04/97 → 09/00	
2.0 16V	Petrol	97	07/98 → 09/00	
2.0 HDI 90	Diesel	66	02/99 → 03/05	

XSARA Break (N2)

1.4 i	Petrol	55	10/97 → 08/05	
1.5 D	Diesel	42	10/97 → 09/00	
1.6 i	Petrol	65	10/97 → 09/00	
1.8 D	Diesel	43	10/97 → 09/00	
1.8 i	Petrol	66	10/97 → 09/00	
1.8 i 16V	Petrol	81	10/97 → 09/00	
1.8 i Aut.	Petrol	74	10/97 → 09/00	
1.9 D	Diesel	51	07/98 → 08/05	
1.9 D	Diesel	50	10/97 → 09/00	
1.9 D	Diesel	55	01/98 → 09/00	
1.9 TD	Diesel	66	10/97 → 09/00	
2.0 16V	Petrol	97	07/98 → 09/00	
2.0 HDI 90	Diesel	66	02/99 → 08/05	

SAG028



KW



CITROËN

XSARA Coupé (N0)

1.4 i	Petrol	55	03/98 → 03/05
1.6 i	Petrol	65	02/98 → 09/00
1.8 i	Petrol	66	02/98 → 09/00
1.8 i 16V	Petrol	81	02/98 → 09/00
1.9 D	Diesel	51	02/99 → 03/05
2.0 i 16V	Petrol	120	02/98 → 03/05

FIAT

SCUDO Combinato (220P)

1.9 D	Diesel	51	04/98 → 12/06
1.9 TD Eco	Diesel	66	02/96 → 12/06

SCUDO Furgonato (220L)

1.6	Petrol	58	02/96 → 12/06
1.9 D	Diesel	51	04/98 → 12/06
1.9 D	Diesel	51	02/96 → 12/06
1.9 TD	Diesel	66	02/96 → 12/06
1.9 TD	Diesel	68	02/98 → 12/06

ULYSSE (220)

1.8 (220.BB5)	Petrol	73	05/97 → 08/02
1.9 TD (220AH5)	Diesel	66	02/95 → 08/02
2.0 (220.AC5)	Petrol	89	06/94 → 08/02
2.0 16V	Petrol	97	05/98 → 09/00
2.0 Turbo (220.AD5)	Petrol	108	06/94 → 08/02

LANCIA

ZETA (220)

2.0 16V (220AL5)	Petrol	97	05/98 → 07/00
2.0 Turbo (220AD5, 220CD5)	Petrol	108	05/95 → 09/02

PEUGEOT

106 II (1)

1.0 i	Petrol	37	01/97 →
1.1 i	Petrol	40	01/97 →

206 2 volumi /Coda spiovente (2A/C)

1.1 i	Petrol	44	09/98 →
1.4 i	Petrol	55	09/98 →
1.6 i	Petrol	65	09/98 → 12/00
1.9 D	Diesel	51	09/98 → 11/01
2.0 S16	Petrol	99	04/99 → 10/00

306 (7B, N3, N5)

1.1	Petrol	44	06/94 → 05/01
1.4 SL	Petrol	55	06/94 → 05/01
1.6 SR	Petrol	65	06/94 → 10/00

SAG028



KW



PEUGEOT

306 (7B, N3, N5)

1.8 16V	Petrol	81	03/97 → 05/01
1.8 ST	Petrol	74	06/94 → 05/01
1.9 D	Diesel	51	09/98 → 05/01
1.9 D	Diesel	55	03/98 → 05/01
1.9 SLD	Diesel	47	06/94 → 05/01
1.9 SLD	Diesel	50	06/94 → 05/01
1.9 SRDT	Diesel	66	06/94 → 05/01
2.0	Petrol	97	03/97 → 05/01
2.0 HDI 90	Diesel	66	06/99 → 05/01
2.0 S16	Petrol	110	06/94 → 05/01
2.0 S16	Petrol	112	06/94 → 05/01
2.0 ST	Petrol	89	07/94 → 05/01

306 2 volumi /Coda spiovente (7A, 7C, N3, N5)

1.1	Petrol	44	05/93 → 05/01
1.4	Petrol	55	05/93 → 05/01
1.6	Petrol	65	05/93 → 10/00
1.8	Petrol	74	05/93 → 05/01
1.8 16V	Petrol	81	03/97 → 05/01
1.8 D	Diesel	43	05/93 → 05/01
1.9 D	Diesel	51	09/98 → 05/01
1.9 D	Diesel	47	05/93 → 05/01
1.9 D	Diesel	50	06/94 → 05/01
1.9 D	Diesel	55	03/98 → 05/01
1.9 DT	Diesel	66	05/93 → 05/01
2.0 16V	Petrol	97	03/97 → 05/01
2.0 HDI 90	Diesel	66	06/99 → 05/01
2.0 S16	Petrol	110	06/94 → 05/01
2.0 S16	Petrol	112	05/93 → 05/01
2.0 XSi	Petrol	89	05/93 → 05/01

306 Break (7E, N3, N5)

1.4	Petrol	55	03/97 → 04/02
1.6	Petrol	65	03/97 → 10/00
1.8	Petrol	74	03/97 → 04/02
1.8 16V	Petrol	81	03/97 → 04/02
1.9 D	Diesel	51	09/98 → 04/02
1.9 D	Diesel	50	03/97 → 04/02
1.9 D	Diesel	55	03/98 → 04/02
1.9 TD	Diesel	66	02/97 → 04/02
2.0	Petrol	97	03/97 → 04/02

306 Cabriolet (7D, N3, N5)

1.8	Petrol	74	03/94 → 04/02
2.0	Petrol	89	03/94 → 04/02
2.0 16V	Petrol	97	03/97 → 04/02

SAG028

PEUGEOT
406 (8B)

1.6	Petrol	65	11/95 → 05/04
1.8	Petrol	66	05/97 → 05/04
1.8 16V	Petrol	81	11/95 → 10/00
1.9 D	Diesel	55	10/96 → 05/04
1.9 TD	Diesel	66	01/96 → 05/04
2.0 16V	Petrol	97	11/95 → 05/04
2.0 16V	Petrol	99	01/99 → 08/00
2.0 HDi 110	Diesel	80	06/98 → 08/01
2.0 HDi 90	Diesel	66	02/99 → 05/04
2.1 TD 12V	Diesel	80	01/96 → 05/04

406 Break (8E/F)

1.8	Petrol	66	05/97 → 10/04
2.0 16V	Petrol	99	01/99 → 10/00
2.0 HDi 110	Diesel	80	02/99 → 04/04
2.0 HDi 90	Diesel	66	02/99 → 10/04

406 Coupé (8C)

2.0 16V	Petrol	97	03/97 → 12/04
2.0 16V	Petrol	99	01/99 → 10/00
3.0 V6 24V	Petrol	140	03/97 → 12/04

806 (221)

2.0 HDi	Diesel	80	08/99 → 08/02
---------	--------	----	---------------

EXPERT (224)

1.9 TD	Diesel	66	02/96 →
--------	--------	----	---------

EXPERT Furgonato (222)

1.6	Petrol	58	02/96 →
1.9 D	Diesel	51	02/96 →
1.9 TD	Diesel	66	02/96 →
1.9 TD	Diesel	68	02/96 →

EXPERT Pianale piatto/Telaio (223)

1.6	Petrol	58	02/96 →
1.9 D	Diesel	51	02/96 →
1.9 TD	Diesel	66	02/96 →
1.9 TD	Diesel	68	02/96 →

RENAULT
CLIO II (BB0/1/2_, CB0/1/2_)

1.6 (B/CB0D)	Petrol	66	09/98 → 05/05
--------------	--------	----	---------------

KANGOO (KC0/1_)

1.4 (KC0C, KC0H, KC0B, KC0M)	Petrol	55	08/97 →
------------------------------	--------	----	---------

KANGOO Express (FC0/1_)

1.4 (FC0C, FC0B, FC0H, FC0M)	Petrol	55	08/97 →
------------------------------	--------	----	---------

MEGANE I (BA0/1_)

2.0 i (BA0G)	Petrol	84	01/96 → 08/03
--------------	--------	----	---------------

SAG028

RENAULT
MEGANE I Cabriolet (EA0/1_)

2.0 (EA0G)	Petrol	84	04/97 → 08/03
------------	--------	----	---------------

MEGANE I Coach (DA0/1_)

2.0 i (DA0G)	Petrol	84	03/96 → 08/03
--------------	--------	----	---------------

SAG029
**H1 SENSORE GIRI / FASE - ALBERO MOTORE
CRANKSHAFT POSITION SENSOR**

LANCIA
THEMA (834)

3000 V6 (834GD, 834FD)	Petrol	126	08/92 → 07/94
------------------------	--------	-----	---------------

THEMA SW (834)

3000 V6 (834GD, 834FD)	Petrol	126	09/92 → 07/94
------------------------	--------	-----	---------------

SAG030
**H1 SENSORE GIRI / FASE - ALBERO MOTORE
CRANKSHAFT POSITION SENSOR**

ALFA ROMEO
166 (936)

2.0 V6 (936A3_)	Petrol	151	09/98 → 10/00
-----------------	--------	-----	---------------

SAG031

H1 **SENSORE GIRI / FASE - ALBERO MOTORE**
CRANKSHAFT POSITION SENSOR



SAAB

9-5 (YS3E)

3.0 V6t Petrol 147 01/98 →

9-5 Station wagon (YS3E)

3.0 V6t Petrol 147 10/98 →

SAG033

H1 **SENSORE GIRI / FASE - ALBERO MOTORE**
CRANKSHAFT POSITION SENSOR

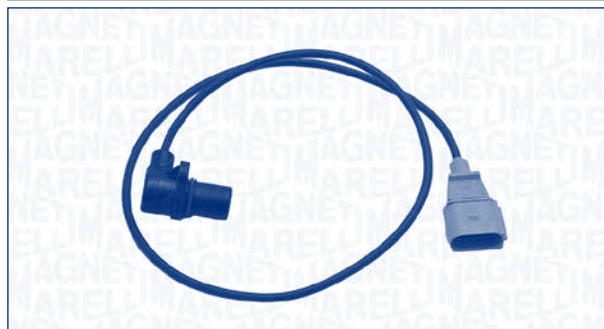

AUDI

A4 (8E2, B6)

2.0 FSI Petrol 110 07/02 → 12/04

A4 Avant (8E5, B6)

2.0 FSI Petrol 110 07/02 → 12/04

SAG032

H1 **SENSORE GIRI / FASE - ALBERO MOTORE**
CRANKSHAFT POSITION SENSOR



BMW

5 (E28)

524 d Diesel 63 03/86 → 12/87

524 td Diesel 85 09/83 → 12/87

SAG034

H1 **SENSORE GIRI / FASE - ALBERO MOTORE**
CRANKSHAFT POSITION SENSOR



FORD

RANGER (ER, EQ)

2.5 TD Diesel 62 04/02 → 06/06

2.5 TD 4x4 Diesel 62 04/02 → 06/06

SAG035
H1 **SENSORE GIRI / FASE - ALBERO MOTORE**
CRANKSHAFT POSITION SENSOR

KW

MITSUBISHI
LANCER VI (CJ-CP_)

1.6 16V (CK4A) Petrol 66 12/95 → 08/03

SAG036
H1 **SENSORE GIRI / FASE - ALBERO MOTORE**
CRANKSHAFT POSITION SENSOR

KW

MITSUBISHI
CARISMA (DA_)

1.9 TD (DA4A) Diesel 66 10/96 → 09/00

CARISMA Tre volumi (DA_)

1.9 TD (DA4A) Diesel 66 10/96 → 09/00

SAG037
H1 **SENSORE GIRI / FASE - ALBERO MOTORE**
CRANKSHAFT POSITION SENSOR

KW

HYUNDAI
SANTA FÉ I (SM)

2.7 V6 4x4 Petrol 127 02/01 → 03/06

SONATA IV (EF)

2.5 V6 24V Petrol 118 06/98 → 10/01

SAG038
H1 **SENSORE GIRI / FASE - ALBERO MOTORE**
CRANKSHAFT POSITION SENSOR

KW

AUDI
A6 Avant (4A, C4)

2.8 Petrol 142 12/95 → 10/97

2.8 quattro Petrol 142 07/96 → 10/97

A8 (4D2, 4D8)

2.8 Petrol 142 04/96 → 04/97

2.8 quattro Petrol 142 04/96 → 04/97

VOLKSWAGEN
PASSAT (3B2)

2.3 VR5 Syncro/4motion Petrol 110 10/97 → 11/00

PASSAT Variant (3B5)

2.3 VR5 Syncro/4motion Petrol 110 10/97 → 11/00

SAG039

H1 **SENSORE GIRI / FASE - ALBERO MOTORE**
CRANKSHAFT POSITION SENSOR

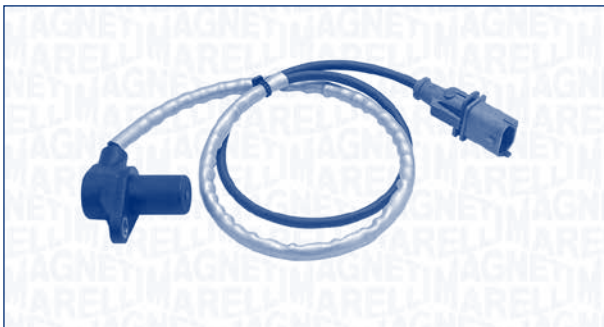

ALFA ROMEO

147 (937)

3.2 GTA Petrol 184 02/03 → 03/10

156 (932)

2.5 V6 24V (932A11_) Petrol 141 01/02 → 09/05

3.2 GTA (932AXB) Petrol 184 03/02 → 09/05

156 Sportwagon (932)

2.5 V6 24V (932B11_) Petrol 141 01/02 → 05/06

3.2 GTA (932BXB) Petrol 184 03/02 → 05/06

166 (936)

2.5 V6 24V (936A21_) Petrol 138 10/00 → 06/07

3.0 V6 24V (936A11_) Petrol 162 10/00 → 06/07

3.2 V6 24V Petrol 176 10/03 → 06/07

GT (937)

3.2 GTA Petrol 176 11/03 → 09/10

GTV (916C_)

3.0 V6 24V (916.C1B_) Petrol 160 10/00 → 10/05

3.2 V6 24V Petrol 176 04/03 → 10/05

SPIDER (916S_)

3.0 V6 (916S1B00) Petrol 160 09/94 → 08/00

3.2 V6 24V Petrol 176 04/03 → 04/05

LANCIA

THEISIS (841AX)

3.0 V6 (841AXC1101) Petrol 158 07/02 → 07/09

3.2 V6 Petrol 169 05/03 → 07/09

SAG040

H1 **SENSORE GIRI / FASE - ALBERO MOTORE**
CRANKSHAFT POSITION SENSOR

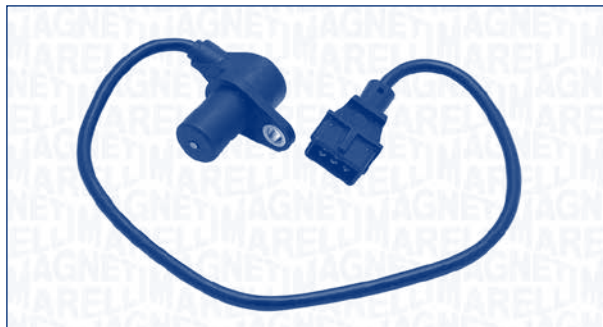

ALFA ROMEO

155 (167)

1.7 T.S. Petrol 83 04/93 → 04/96

1.7 T.S. (167.A4D, 167.A4H) Petrol 85 04/93 → 04/96

1.8 T.S. Petrol 95 02/92 → 06/93

1.8 T.S. Sport (167.A4A, 167.A4C, 167.A4E) Petrol 93 01/92 → 04/96

2.0 T.S. (167.A2) Petrol 106 02/92 → 04/93

2.0 T.S. (167.A2A) Petrol 104 04/93 → 02/95

2.5 V6 (167.A1) Petrol 121 02/92 → 04/96

2.5 V6 (167.A1C, 167.A1E) Petrol 120 05/96 → 12/97

164 (164)

3.0 24V (164.K1) Petrol 155 09/92 → 09/98

SAG041

H1 **SENSORE GIRI / FASE - ALBERO MOTORE**
CRANKSHAFT POSITION SENSOR



KIA

CARNIVAL / GRAND CARNIVAL III (VQ)

2.9 CRDi Diesel 136 06/06 →

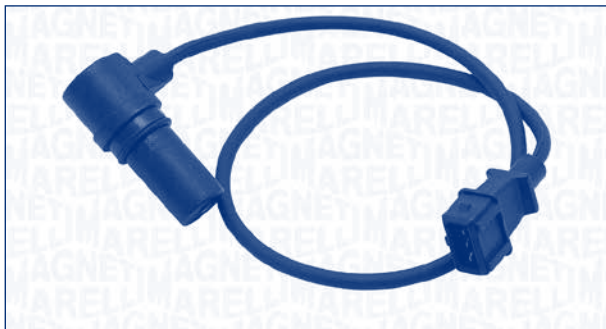
SAG043
H1 **SENSORE GIRI / FASE - ALBERO MOTORE**
CRANKSHAFT POSITION SENSOR

LANCIA
KAPPA (838A)

2.0 20V (838AA1AA)	Petrol	107	10/94 → 06/96
-----------------------	--------	-----	---------------

2.0 20V Turbo (838AM1AA)	Petrol	162	06/98 → 12/00
-----------------------------	--------	-----	---------------

2.4 20V (838AC1AA, 838AC11A)	Petrol	129	11/94 → 06/98
------------------------------------	--------	-----	---------------

2.4 T.DS (838AE1AA, 838AH1AA)	Diesel	91	11/94 → 03/98
-------------------------------------	--------	----	---------------

KAPPA Coupé (838)

2.0 20V	Petrol	114	07/96 → 06/98
---------	--------	-----	---------------

2.0 20V Turbo (838CM)	Petrol	162	06/98 → 06/00
--------------------------	--------	-----	---------------

KAPPA SW (838B)

2.0 20V Turbo (838BM1AA)	Petrol	162	06/98 → 12/00
-----------------------------	--------	-----	---------------

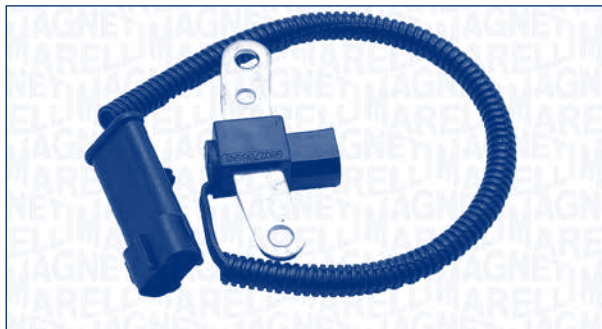
SAG044
H1 **SENSORE GIRI / FASE - ALBERO MOTORE**
CRANKSHAFT POSITION SENSOR

JEEP
WRANGLER II (TJ)

4.0	Petrol	124	06/98 → 04/07
-----	--------	-----	---------------

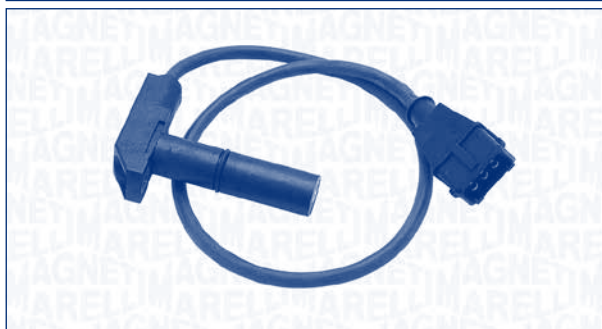
4.0 Rubicon	Petrol	128	08/03 → 04/07
-------------	--------	-----	---------------

SAG045
H1 **SENSORE GIRI / FASE - ALBERO MOTORE**
CRANKSHAFT POSITION SENSOR

BMW
3 (E30)

325 i	Petrol	125	12/86 → 09/87
-------	--------	-----	---------------

325 i	Petrol	126	09/83 → 09/87
-------	--------	-----	---------------

325 i X	Petrol	125	12/86 → 09/87
---------	--------	-----	---------------

325 i X	Petrol	126	03/86 → 09/87
---------	--------	-----	---------------

3 Cabriolet (E30)

325 i	Petrol	126	12/85 → 09/87
-------	--------	-----	---------------

3 Touring (E30)

325 i	Petrol	125	07/87 → 09/87
-------	--------	-----	---------------

SAG046

H1 **SENSORE GIRI / FASE - ALBERO MOTORE**
CRANKSHAFT POSITION SENSOR



TOYOTA

HILUX III Pick-up (TGN1_, GGN2_, GGN1_, KUN2_, KUN1_)

2.5 D 4WD	Diesel	75	08/05 →
2.5 D-4D	Diesel	75	06/06 →
3.0 (KUN16)	Diesel	120	08/05 → 09/06

SAG047

H1 **SENSORE GIRI / FASE - ALBERO MOTORE**
CRANKSHAFT POSITION SENSOR



ALFA ROMEO

155 (167)

2.5 TD (167.A1A)	Diesel	92	04/93 → 04/96
------------------	--------	----	---------------

164 (164)

2.5 TD (164.K2A, 164.K2B)	Diesel	92	09/92 → 09/98
---------------------------	--------	----	---------------

FORD

SCORPIO II (GFR, GGR)

2.5 TD	Diesel	85	01/95 → 08/98
--------	--------	----	---------------

SCORPIO II Station wagon (GNR, GGR)

2.5 TD	Diesel	85	01/95 → 08/98
--------	--------	----	---------------

PORSCHE

928

5.0 GT	Petrol	243	01/89 → 07/91
5.0 S,S4	Petrol	235	08/86 → 07/91

SAG047



PORSCHE

928

5.0 S4 Cat.	Petrol	235	08/86 → 07/91
5.4 GTS	Petrol	257	08/91 → 11/95

944

2.5	Petrol	118	08/87 → 07/88
2.5 TURBO	Petrol	184	09/87 → 07/91
3.0 S2	Petrol	155	12/88 → 07/91

944 Cabriolet

3.0 S2	Petrol	155	12/88 → 07/91
--------	--------	-----	---------------

968

3.0	Petrol	176	08/91 → 11/95
-----	--------	-----	---------------

968 Cabriolet

3.0	Petrol	176	08/91 → 11/95
-----	--------	-----	---------------

VAUXHALL

FRONTERA Mk I (A)

2.5 TDS	Diesel	85	11/91 → 06/98
---------	--------	----	---------------

FRONTERA Mk I (A) Sport

2.5 TDS	Diesel	85	09/96 → 10/98
---------	--------	----	---------------

VOLVO

740 (744)

2.0	Petrol	118	01/86 → 07/89
-----	--------	-----	---------------

760 Kombi (704, 765)

2.3 Turbo	Petrol	134	08/84 → 07/89
-----------	--------	-----	---------------

SAG048

H1 **SENSORE GIRI / FASE - ALBERO MOTORE**
CRANKSHAFT POSITION SENSOR



FIAT

FIORINO Furgonato (146)

75 i.e. 1.6	Petrol	55	06/95 → 05/01
-------------	--------	----	---------------

FIORINO Pick up (146)

1.4	Petrol	49	06/95 → 05/01
1.6	Petrol	55	06/95 → 05/01

SAG048

FIAT
SCUDO Furgonato (220L)

1.6	Petrol	58	02/96 → 05/00
-----	--------	----	---------------

SAG049
H1 **SENSORE GIRI / FASE - ALBERO MOTORE**
CRANKSHAFT POSITION SENSOR

SEAT
TOLEDO II (1M2)

2.3 V5	Petrol	110	04/99 → 05/01
--------	--------	-----	---------------

VOLKSWAGEN
BORA (1J2)

2.3 V5	Petrol	110	10/98 → 10/00
--------	--------	-----	---------------

2.3 V5 4motion	Petrol	110	12/98 → 10/00
----------------	--------	-----	---------------

BORA Station wagon (1J6)

2.3 V5	Petrol	110	05/99 → 10/00
--------	--------	-----	---------------

2.3 V5 4motion	Petrol	110	05/99 → 10/00
----------------	--------	-----	---------------

GOLF IV (1J1)

2.3 V5	Petrol	110	08/97 → 10/00
--------	--------	-----	---------------

2.3 V5 4motion	Petrol	110	12/98 → 10/00
----------------	--------	-----	---------------

GOLF IV Variant (1J5)

2.3 V5	Petrol	110	05/99 → 06/06
--------	--------	-----	---------------

2.3 V5 4motion	Petrol	110	05/99 → 06/06
----------------	--------	-----	---------------

PASSAT (3B3)

2.3 V5	Petrol	125	11/00 → 05/05
--------	--------	-----	---------------

2.3 V5 4motion	Petrol	125	11/00 → 05/05
----------------	--------	-----	---------------

PASSAT Variant (3B6)

2.3 VR5	Petrol	125	11/00 → 05/05
---------	--------	-----	---------------

2.3 VR5 4motion	Petrol	125	11/00 → 05/05
-----------------	--------	-----	---------------

SAG050
H1 **SENSORE GIRI / FASE - ALBERO MOTORE**
CRANKSHAFT POSITION SENSOR

VOLKSWAGEN
GOLF VI (5K1)

2.0 GTI	Petrol	155	04/09 → 11/12
---------	--------	-----	---------------

JETTA III (1K2)

2.5 FSI	Petrol	110	01/06 → 10/10
---------	--------	-----	---------------

NEW BEETLE (9C1, 1C1)

2.5	Petrol	110	07/05 → 09/10
-----	--------	-----	---------------

NEW BEETLE Cabriolet (1Y7)

2.5	Petrol	110	07/05 → 09/10
-----	--------	-----	---------------

SAG051
H1 **SENSORE GIRI / FASE - ALBERO MOTORE**
CRANKSHAFT POSITION SENSOR

DAEWOO
EVANDA (KLAL)

2.0	Petrol	96	03/03 → 01/05
-----	--------	----	---------------

LACETTI 2 volumi /Coda spiovente (KLAN)

1.8	Petrol	90	02/04 →
-----	--------	----	---------

LEGANZA (KLAV)

2.0 16V	Petrol	93	07/00 → 04/04
---------	--------	----	---------------

2.0 16V	Petrol	98	06/97 → 12/02
---------	--------	----	---------------

2.2 16V	Petrol	100	04/99 → 12/02
---------	--------	-----	---------------

NUBIRA Tre volumi (KLAJ)

2.0 16V	Petrol	98	05/97 →
---------	--------	----	---------

SAG051



DAEWOO

NUBIRA Tre volumi (KLAN)

1.8 Petrol 90 07/03 →

NUBIRA Wagon (KLAJ)

2.0 16V Petrol 98 05/97 →

TACUMA (KLAU)

2.0 Petrol 89 09/01 →

OPEL

FRONTERA B (6B_)

2.2 i (6B_ZC, 6B_VF, 6B_66, 6B_76) Petrol 100 10/98 →

SAG052

H1 **SENSORE GIRI / FASE - ALBERO MOTORE**
CRANKSHAFT POSITION SENSOR



VOLVO

S40 I (VS)

1.9 DI Diesel 70 03/99 → 07/00

V40 Station wagon (VW)

1.9 DI Diesel 70 03/99 → 07/00

SAG053

H1 **SENSORE GIRI / FASE - ALBERO MOTORE**
CRANKSHAFT POSITION SENSOR



SUZUKI

IGNIS II

1.3 Petrol 69 09/03 →

1.3 4x4 Petrol 69 09/03 →

WAGON R+ (MM)

1.3 Petrol 69 09/03 →

1.3 4WD Petrol 69 09/03 →

SAG054

H1 **SENSORE GIRI / FASE - ALBERO MOTORE**
CRANKSHAFT POSITION SENSOR



KIA

CARENS II (FJ)

1.6 Petrol 77 07/02 →

CARNIVAL I (UP)

2.9 TD Diesel 93 08/99 → 10/01

RIO Tre volumi (DC_)

1.3 Petrol 55 09/00 → 02/05

1.5 16V Petrol 72 09/00 → 02/05

SHUMA II (FB)

1.6 Petrol 75 05/01 → 08/04

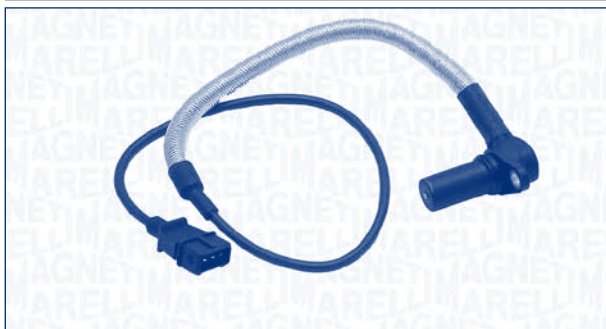
SAG055
H1 **SENSORE GIRI / FASE - ALBERO MOTORE**
CRANKSHAFT POSITION SENSOR

OPEL
OMEGA B (25_, 26_, 27_)

2.5 V6	Petrol	125	03/94 → 09/00	ENGINE: →08149313
2.6 V6	Petrol	132	09/00 → 07/03	ENGINE: →08149313
3.0 V6	Petrol	155	04/94 → 02/01	ENGINE: →08149313
3.2 V6	Petrol	160	02/01 → 07/03	ENGINE: →08149313

OMEGA B Station wagon (21_, 22_, 23_)

2.5 V6	Petrol	125	03/94 → 09/00	ENGINE: →08149313
2.6 V6	Petrol	132	09/00 → 07/03	ENGINE: →08149313
3.0 V6	Petrol	155	04/94 → 02/01	ENGINE: →08149313
3.2 V6	Petrol	160	02/01 → 07/03	ENGINE: →08149313

VAUXHALL
OMEGA (B)

2.6 V6	Petrol	132	08/00 → 07/03	ENGINE: →08149313
3.2 V6	Petrol	160	02/01 → 07/03	ENGINE: →08149313

OMEGA (B) Station wagon

2.6 V6	Petrol	132	08/00 → 06/03	ENGINE: →08149313
3.2 V6	Petrol	160	02/01 → 06/03	ENGINE: →08149313

SAG056
H1 **SENSORE GIRI / FASE - ALBERO MOTORE**
CRANKSHAFT POSITION SENSOR

AUDI
A6 (4B2, C5)

3.7 quattro	Petrol	191	03/99 → 01/05	
4.2 quattro	Petrol	220	11/98 → 01/05	
RS6 quattro	Petrol	331	07/02 → 01/05	
S6 quattro	Petrol	250	09/99 → 01/05	

A6 Avant (4B5, C5)

3.7 quattro	Petrol	191	03/99 → 01/05	
4.2 quattro	Petrol	220	11/98 → 01/05	
RS6 plus quattro	Petrol	353	04/04 → 01/05	
RS6 quattro	Petrol	331	07/02 → 01/05	
S6 quattro	Petrol	250	09/99 → 01/05	

A8 (4D2, 4D8)

3.3 TDI quattro	Diesel	165	06/00 → 09/02	
3.7 quattro	Petrol	191	11/98 → 09/02	
3.7 quattro	Petrol	169	11/98 → 11/98	
4.2 quattro	Petrol	228	11/98 → 09/02	
4.2 quattro	Petrol	175	02/99 → 04/00	
4.2 quattro	Petrol	220	11/98 → 11/98	
S 8 quattro	Petrol	265	06/99 → 09/02	

A8 (4E_)

4.0 TDI quattro	Diesel	202	05/03 → 07/05	
4.2 TDI quattro	Diesel	235	01/05 → 06/05	
4.2 TDI quattro	Diesel	240	07/05 → 07/10	

VOLKSWAGEN
TOUAREG (7LA, 7L6, 7L7)

4.2 V8	Petrol	228	12/02 → 05/05	
4.2 V8 FSI	Petrol	257	06/06 → 05/10	

SAG057

H1 **SENSORE GIRI / FASE - ALBERO MOTORE**
CRANKSHAFT POSITION SENSOR



OPEL

ASTRA G 2 volumi /Coda spiovente (F48_, F08_)

2.0 OPC	Petrol	141	09/02 → 01/05
2.0 OPC	Petrol	147	11/02 → 01/05

ASTRA G Cabriolet (F67)

2.0 16V Turbo	Petrol	147	11/02 → 10/05
2.0 OPC	Petrol	141	03/02 → 10/05

ASTRA G Coupé (F07_)

2.0 16V Turbo	Petrol	140	09/00 → 08/01
2.0 16V Turbo	Petrol	141	08/01 → 05/05
2.0 16V Turbo	Petrol	147	11/02 → 05/05

ASTRA G Station wagon (F35_)

2.0 OPC	Petrol	141	09/02 → 07/04
2.0 OPC	Petrol	147	11/02 → 07/04

ASTRA H (L48)

2.0 Turbo	Petrol	125	03/04 →
2.0 Turbo	Petrol	147	09/04 →
2.0 Turbo	Petrol	177	03/05 →

ASTRA H GTC (L08)

2.0 Turbo	Petrol	125	03/05 →
2.0 Turbo	Petrol	147	03/05 →
2.0 Turbo	Petrol	177	08/05 →

ASTRA H Station wagon (L35)

2.0 Turbo	Petrol	125	08/04 →
2.0 Turbo	Petrol	147	09/04 →

ASTRA H TwinTop (L67)

2.0 Turbo	Petrol	125	09/05 →
2.0 Turbo	Petrol	147	09/05 →

SPEEDSTER

2.0 Turbo	Petrol	147	04/03 →
-----------	--------	-----	---------

ZAFIRA A (F75_)

2.0 OPC	Petrol	141	09/01 → 06/05
2.0 OPC	Petrol	147	11/02 → 06/05

ZAFIRA B (A05)

2.0	Petrol	147	07/05 →
-----	--------	-----	---------

SAG057



OPEL

ZAFIRA B (A05)

2.0	Petrol	177	01/06 →
-----	--------	-----	---------

VAUXHALL

ASTRA Mk IV (G) 2 volumi /Coda spiovente

2.0 SRI Turbo	Petrol	141	07/02 → 05/05
---------------	--------	-----	---------------

ASTRA Mk IV (G) Cabriolet

2.0 Turbo	Petrol	141	03/02 → 10/05
-----------	--------	-----	---------------

ASTRA Mk IV (G) Coupé (F67)

2.0 16V Turbo	Petrol	140	09/00 → 08/05
---------------	--------	-----	---------------

ASTRA Mk V (H) 2 volumi /Coda spiovente

2.0 Turbo	Petrol	125	01/04 → 05/09
2.0 Turbo	Petrol	147	01/04 → 05/09
2.0 Turbo	Petrol	177	01/04 → 05/09

ASTRA Mk V (H) Sport Hatch

2.0 Turbo	Petrol	125	02/05 → 11/10
-----------	--------	-----	---------------

ASTRA Mk V (H) Station wagon

2.0 Turbo	Petrol	125	08/04 → 10/10
2.0 Turbo	Petrol	147	08/04 → 10/10

ASTRA TwinTop Mk V (H)

2.0	Petrol	125	02/06 → 11/10
-----	--------	-----	---------------

VX220

2.0 i Turbo	Petrol	147	03/01 → 07/05
-------------	--------	-----	---------------

ZAFIRA Mk I (A) (F75)

2.0 GSI Turbo	Petrol	141	09/01 → 06/05
---------------	--------	-----	---------------

ZAFIRA Mk II (B) (M75)

2.0	Petrol	147	07/05 →
2.0	Petrol	176	01/06 →

SAG058

H1 **SENSORE GIRI / FASE - ALBERO MOTORE**
CRANKSHAFT POSITION SENSOR



FIAT

DUCATO Autobus (244, Z_)

2.3 JTD	Diesel	81	04/02 →
---------	--------	----	---------

SAG058

FIAT
DUCATO Furgonato (244)

2.3 JTD Diesel 81 04/02 →

DUCATO Pianale piatto/Telaio (244)

2.3 JTD Diesel 81 04/02 → 07/06

SAG059
H1 **SENSORE GIRI / FASE - ALBERO MOTORE
CRANKSHAFT POSITION SENSOR**

VOLVO
240 (P242, P244)

2.3 i Cat. Petrol 85 01/88 → 07/93

2.4 Diesel Diesel 58 08/87 → 08/93

240 Kombi (P245)

2.3 i Cat. Petrol 85 01/88 → 07/93

2.4 Diesel Diesel 58 08/88 → 08/93

740 (744)

2.3 Petrol 85 08/87 → 07/92

2.4 Diesel Diesel 60 08/84 → 07/92

2.4 TD Diesel 83 08/84 → 07/90

740 Kombi (745)

2.3 Petrol 85 08/87 → 07/92

2.3 Turbo Petrol 121 08/89 → 07/90

2.4 Turbo-Diesel Diesel 80 09/85 → 07/92

760 (704, 764)

2.4 D Diesel 60 01/82 → 07/92

2.4 TD Interc. (704) Diesel 85 08/87 → 07/92

2.4 Turbo Diesel (704) Diesel 80 04/87 → 07/92

760 Kombi (704, 765)

2.4 D Diesel 60 01/82 → 07/92

940 (944)

2.0 Petrol 82 01/92 → 07/94

2.3 Petrol 114 08/90 → 07/91

2.3 Petrol 85 08/92 → 07/94

SAG059

VOLVO
940 (944)

2.3 Petrol 96 08/90 → 12/94

2.3 Turbo Petrol 121 08/90 → 07/94

2.4 D Diesel 60 08/90 → 12/94

940 II (944)

2.3 Petrol 85 08/94 → 07/95

2.3 Petrol 96 08/94 → 10/98

2.3 ti Petrol 99 01/95 → 10/98

940 II Station wagon (945)

2.3 Petrol 85 08/94 → 07/95

2.3 Petrol 96 08/94 → 10/98

2.3 ti Petrol 99 01/95 → 10/98

940 Kombi (945)

2.0 Petrol 82 01/92 → 07/94

2.0 Turbo Petrol 114 01/91 → 07/95

2.3 Petrol 85 08/92 → 07/94

2.3 Petrol 96 08/90 → 12/94

2.3 Turbo Petrol 121 08/90 → 07/94

2.4 D Diesel 60 08/90 → 07/95

2.4 TD Intercooler Diesel 90 08/90 → 08/94

960 (964)

2.4 TD Interc. Diesel 85 09/91 → 07/94

2.9 Petrol 150 08/90 → 07/94

960 Kombi (965)

2.4 TD Interc. Diesel 85 09/91 → 07/94

2.9 Petrol 150 08/90 → 07/94

SAG060
H1 **SENSORE GIRI / FASE - ALBERO MOTORE
CRANKSHAFT POSITION SENSOR**

OPEL
ASTRA G 2 volumi /Coda spiovente (F48_, F08_)

1.7 TD Diesel 50 02/98 → 08/00

SAG060



OPEL

ASTRA G Furgonato (F70)

1.7 TD Diesel 50 01/99 → 04/05

ASTRA G Station wagon (F35_)

1.7 TD Diesel 50 02/98 → 08/00

ASTRA G Tre volumi (F69_)

1.7 TD Diesel 50 09/98 → 08/00

VAUXHALL

ASTRA Mk IV (G) 2 volumi /Coda spiovente

1.7 TD Diesel 50 02/98 → 08/00

ASTRA Mk IV (G) Station wagon

1.7 TD Diesel 50 02/98 → 08/00

ASTRA Mk IV (G) Tre volumi

1.7 TD Diesel 50 09/98 → 08/00

ASTRAVAN Mk IV (G)

1.7 TD Diesel 50 08/98 → 08/06

SAG061

H1 **SENSORE GIRI / FASE - ALBERO MOTORE**
CRANKSHAFT POSITION SENSOR



BMW

5 (E39)

535 i Petrol 180 04/99 → 06/03

540 i Petrol 210 04/96 → 06/03

M 4.9 Petrol 294 10/98 → 06/03

5 (E60)

M Petrol 373 09/04 → 03/10

6 (E63)

M Petrol 373 09/05 →

7 (E38)

735 i,iL Petrol 173 01/96 → 11/01

740 d Diesel 180 05/99 → 11/01

740 i,iL Petrol 210 01/96 → 11/01

750 i,iL Petrol 240 12/94 → 11/01

SAG061



BMW

8 (E31)

840 Ci Petrol 210 01/96 → 12/99

850 Ci Petrol 240 09/94 → 12/99

Z8 (E52)

4.9 Petrol 294 06/00 → 06/03

SAG062

H1 **SENSORE GIRI / FASE - ALBERO MOTORE**
CRANKSHAFT POSITION SENSOR



BMW

3 (E36)

316 i Petrol 73 09/90 → 09/93

316 i Petrol 75 09/90 → 09/93

318 i Petrol 83 12/90 → 10/93

5 (E34)

518 i Petrol 83 09/91 → 09/95

5 Touring (E34)

518 i Petrol 83 03/93 → 09/94

SAG063
H1 **SENSORE GIRI / FASE - ALBERO MOTORE**
CRANKSHAFT POSITION SENSOR

NISSAN
TERRANO II (R20)

2.7 TDi 4WD Diesel 92 05/96 →

SAG064
H1 **SENSORE GIRI / FASE - ALBERO MOTORE**
CRANKSHAFT POSITION SENSOR

VOLKSWAGEN
GOLF III (1H1)

1.6 Petrol 74 07/95 → 08/97

GOLF III Cabriolet (1E7)

1.6 Petrol 74 10/94 → 05/98

GOLF III Variant (1H5)

1.6 Petrol 74 07/94 → 04/99

PASSAT (3A2, 35I)

1.6 Petrol 74 10/94 → 08/96

PASSAT Variant (3A5, 35I)

1.6 Petrol 74 07/94 → 12/95

VENTO (1H2)

1.6 Petrol 74 10/94 → 09/98

SAG065
H1 **SENSORE GIRI / FASE - ALBERO MOTORE**
CRANKSHAFT POSITION SENSOR

AUDI
A3 (8P1)

3.2 V6 quattro Petrol 184 07/03 → 05/09

A3 Sportback (8PA)

3.2 V6 quattro Petrol 184 09/04 → 05/09

TT (8J3)

3.2 V6 quattro Petrol 184 08/06 → 06/10

TT (8N3)

3.2 VR6 quattro Petrol 184 07/03 → 06/06

TT Roadster (8J9)

3.2 V6 quattro Petrol 184 03/07 → 06/10

TT Roadster (8N9)

3.2 VR6 quattro Petrol 184 07/03 → 06/06

FORD
GALAXY (WGR)

2.8 V6 Petrol 150 04/00 → 05/06

SEAT
ALHAMBRA (7V8, 7V9)

2.8 V6 Petrol 150 06/00 → 03/10

2.8 V6 4motion Petrol 150 06/00 → 03/10

LEON (1M1)

2.8 Petrol 150 05/02 → 06/04

2.8 Cupra 4 Petrol 150 02/01 → 06/06

TOLEDO II (1M2)

2.3 V5 20V Petrol 125 05/01 → 05/06

VOLKSWAGEN
BORA (1J2)

2.3 V5 Petrol 125 10/00 → 05/05

2.3 V5 4motion Petrol 125 10/00 → 05/05

2.8 V6 4motion Petrol 150 03/99 → 05/05

BORA Station wagon (1J6)

2.3 V5 Petrol 125 10/00 → 05/05

2.3 V5 4motion Petrol 125 10/00 → 05/05

2.8 V6 4motion Petrol 150 05/99 → 05/05

2.8 VR6 Petrol 150 03/00 → 05/00

SAG065



AUDI

EOS (1F7, 1F8)

3.2 V6 Petrol 184 06/06 → 05/09

GOLF IV (1J1)

2.3 V5 Petrol 125 10/00 → 06/05

2.3 V5 4motion Petrol 125 10/00 → 06/05

2.8 V6 4motion Petrol 150 03/99 → 06/05

GOLF IV Variant (1J5)

2.3 V5 Petrol 125 10/00 → 06/06

2.3 V5 4motion Petrol 125 10/00 → 06/06

2.8 V6 4motion Petrol 150 05/99 → 06/06

GOLF V (1K1)

3.2 Petrol 184 09/05 → 11/08

3.2 R32 4motion Petrol 184 11/05 → 11/08

NEW BEETLE (9C1, 1C1)

2.3 V5 Petrol 125 10/00 → 09/10

PASSAT (3C2)

3.2 FSI 4motion Petrol 184 11/05 → 07/10

3.6 R36 4motion Petrol 220 04/07 → 07/10

PASSAT CC (357)

3.6 FSI 4motion Petrol 220 06/08 → 05/10

PASSAT Variant (3C5)

3.2 FSI 4motion Petrol 184 11/05 → 11/10

3.6 R36 4motion Petrol 220 04/07 → 11/10

SHARAN (7M8, 7M9, 7M6)

2.8 V6 24V Petrol 150 04/00 → 03/10

2.8 V6 24V 4motion Petrol 150 04/00 → 03/10

SAG066

H1 **SENSORE GIRI / FASE - ALBERO MOTORE**
CRANKSHAFT POSITION SENSOR



FERRARI

512 TR

5.0 Petrol 315 01/92 → 10/94

SAG066



FERRARI

MONDIAL

3.4 T Petrol 221 03/89 → 12/93

MONDIAL Cabriolet

3.4 T Petrol 221 01/89 → 12/93

KIA

CARENS I (FC)

1.8 i Petrol 81 11/00 → 07/02

CARNIVAL II (GQ)

2.9 CRDi Diesel 106 10/01 →

SHUMA (FB)

1.8 i 16V Petrol 81 10/97 → 03/01

SHUMA II (FB)

1.8 Petrol 84 04/03 → 08/04

LANCIA

THEMA (834)

2850 V6 i.e. (834AD, 834CD, 834BD) Petrol 108 06/88 → 09/91

PEUGEOT

505 (551A)

2.8 GTI V6 Petrol 105 06/86 → 12/93

VOLVO

760 (704, 764)

2.8 (704) Petrol 105 05/86 → 08/91

760 Kombi (704, 765)

2.8 (765) Petrol 105 05/86 → 08/91

SAG067

H1 **SENSORE GIRI / FASE - ALBERO MOTORE**
CRANKSHAFT POSITION SENSOR



FIAT

PALIO (178BX)

1.4 Petrol 51 03/00 → 09/01

1.4 Cat. Petrol 51 03/98 → 09/01

SAG067

FIAT
PUNTO (176)

1.4 GT Turbo	Petrol	98	01/94 → 09/96
--------------	--------	----	---------------

SIENA (178_)

1.4	Petrol	51	03/00 → 06/01
-----	--------	----	---------------

1.4 Cat.	Petrol	51	05/98 → 06/01
----------	--------	----	---------------

KIA
CLARUS Station wagon (GC)

1.8 i 16V	Petrol	85	05/98 →
-----------	--------	----	---------

RETONA (CE)

2.0 16V	Petrol	94	05/00 →
---------	--------	----	---------

2.0 TD	Diesel	61	06/99 → 12/00
--------	--------	----	---------------

SPORTAGE (K00)

2.0	Petrol	87	10/00 → 08/03
-----	--------	----	---------------

2.0 4WD	Petrol	87	10/00 → 08/03
---------	--------	----	---------------

2.0 i 16V	Petrol	94	10/99 → 08/03
-----------	--------	----	---------------

2.0 i 16V 4WD	Petrol	94	04/94 → 08/03
---------------	--------	----	---------------

2.0 i 4WD	Petrol	70	04/94 → 08/99
-----------	--------	----	---------------

2.0 TD 4WD	Diesel	61	10/97 → 08/03
------------	--------	----	---------------

SAG068
H1 **SENSORE GIRI / FASE - ALBERO MOTORE**
CRANKSHAFT POSITION SENSOR

HYUNDAI
H-1 / STAREX

2.5 CRDi	Diesel	103	01/04 → 04/04
----------	--------	-----	---------------

2.5 CRDi 4WD	Diesel	103	01/04 → 04/04
--------------	--------	-----	---------------

KIA
SORENTO I (JC)

2.5 CRDi	Diesel	103	01/04 → 04/06
----------	--------	-----	---------------

SAG069
H1 **SENSORE GIRI / FASE - ALBERO MOTORE**
CRANKSHAFT POSITION SENSOR

OPEL
SIGNUM

2.0 DTI	Diesel	74	05/03 → 09/05	ENGINE: 17G23741 →
---------	--------	----	---------------	--------------------

VECTRA C

2.0 DTI 16V	Diesel	74	04/02 → 09/05	ENGINE: 17G23741 →
-------------	--------	----	---------------	--------------------

2.2 DTI 16V	Diesel	92	04/02 → 09/05	ENGINE: 17G23741 →
-------------	--------	----	---------------	--------------------

VECTRA C GTS

2.0 DTI 16V	Diesel	74	08/02 → 09/05	ENGINE: 17G23741 →
-------------	--------	----	---------------	--------------------

2.2 DTI 16V	Diesel	92	08/02 → 09/05	ENGINE: 17G23741 →
-------------	--------	----	---------------	--------------------

VECTRA C Station wagon

2.0 DTI	Diesel	74	10/03 → 09/05	ENGINE: 17G23741 →
---------	--------	----	---------------	--------------------

2.2 DTI	Diesel	92	10/03 → 09/05	ENGINE: 17G23741 →
---------	--------	----	---------------	--------------------

VAUXHALL
SIGNUM

2.0 DTI	Diesel	74	05/03 → 09/05	ENGINE: 17G23741 →
---------	--------	----	---------------	--------------------

VECTRA Mk II (C)

2.0 DTI 16V	Diesel	74	04/02 → 09/05	ENGINE: 17G23741 →
-------------	--------	----	---------------	--------------------

2.2 DTI 16V	Diesel	92	04/02 → 09/05	ENGINE: 17G23741 →
-------------	--------	----	---------------	--------------------

VECTRA Mk II (C) GTS

2.0 DTI 16V	Diesel	74	08/02 → 09/05	ENGINE: 17G23741 →
-------------	--------	----	---------------	--------------------

2.2 DTI 16V	Diesel	92	08/02 → 09/05	ENGINE: 17G23741 →
-------------	--------	----	---------------	--------------------

VECTRA Mk II (C) Station wagon

2.0 DTI 16V	Diesel	74	10/03 → 09/05	ENGINE: 17G23741 →
-------------	--------	----	---------------	--------------------

2.2 DTI 16V	Diesel	92	10/03 → 09/05	ENGINE: 17G23741 →
-------------	--------	----	---------------	--------------------

SAG071

H1 **SENSORE GIRI / FASE - ALBERO MOTORE**
CRANKSHAFT POSITION SENSOR



FIAT

DUCATO Autobus (230)

2.5 TDI 4x4	Diesel	85	04/97 → 03/98
2.5 TDI Panorama/ Combinato	Diesel	80	07/94 → 03/98
2.5 TDI Panorama/ Combinato	Diesel	85	03/94 → 03/98
2.8 TDI	Diesel	90	10/97 → 04/02
2.8 TDI 4x4	Diesel	90	07/99 → 04/02

DUCATO Furgonato (230L)

2.8 TDI	Diesel	90	10/97 → 04/02
2.8 TDI 4x4	Diesel	90	06/99 → 04/02

DUCATO Pianale piatto/Telaio (230)

2.5 TDI	Diesel	80	03/94 → 03/98
2.5 TDI	Diesel	85	03/94 → 03/98
2.8 TDI	Diesel	90	12/98 → 04/02

SAG072

H1 **SENSORE GIRI / FASE - ALBERO MOTORE**
CRANKSHAFT POSITION SENSOR



MITSUBISHI

CARISMA (DA_)

1.6 (DA1A)	Petrol	66	07/95 → 06/06
1.8 (DA2A)	Petrol	85	07/95 → 06/06

SAG072



MITSUBISHI

CARISMA (DA_)

1.8 16V (DA2A)	Petrol	103	07/95 → 06/06
----------------	--------	-----	---------------

LANCER Tre volumi (CS_A, CT0)

2.0 (CS9A)	Petrol	99	12/03 →
------------	--------	----	---------

PAJERO PININ (H6_W, H7_W)

1.8 GDI (H66W)	Petrol	88	10/99 → 06/07
----------------	--------	----	---------------

SPACE STAR (DG_A)

1.8 GDI (DG5A)	Petrol	87	06/98 → 12/04
1.8 GDI (DG5A)	Petrol	90	06/98 → 12/04

SAG073

H1 **SENSORE GIRI / FASE - ALBERO MOTORE**
CRANKSHAFT POSITION SENSOR



BMW

3 (E30)

316 i	Petrol	73	04/89 → 06/91
316 i	Petrol	75	04/89 → 06/91
318 i	Petrol	83	04/89 → 06/91
318 i	Petrol	85	04/89 → 06/91
320 i	Petrol	95	10/87 → 06/91
325 i	Petrol	125	10/87 → 06/91
325 i	Petrol	126	10/87 → 11/89
325 i X	Petrol	125	10/87 → 08/91
325 i X	Petrol	126	10/87 → 12/87

3 Cabriolet (E30)

318 i	Petrol	83	09/90 → 10/93
320 i	Petrol	95	10/87 → 10/93
325 i	Petrol	125	09/87 → 10/93
325 i	Petrol	126	10/87 → 12/87

3 Touring (E30)

316 i	Petrol	73	09/91 → 12/93
316 i	Petrol	75	09/91 → 12/93
318 i	Petrol	85	09/87 → 06/91
318 i	Petrol	83	04/89 → 12/93

SAG073

BMW
3 Touring (E30)

320 i	Petrol	95	04/89 → 12/91
325 i	Petrol	125	10/87 → 03/93
325 i X	Petrol	125	06/88 → 10/93

5 (E34)

518 i	Petrol	83	08/89 → 08/91
520 i	Petrol	95	01/88 → 08/91
525 i	Petrol	125	01/88 → 08/91

Z1

2.5	Petrol	125	06/88 → 06/91
-----	--------	-----	---------------

SAG074
H1 **SENSORE GIRI / FASE - ALBERO MOTORE**
CRANKSHAFT POSITION SENSOR

HYUNDAI
ATOS (MX)

1.0 i	Petrol	40	02/98 → 03/02
-------	--------	----	---------------

ATOS PRIME (MX)

1.0 i	Petrol	40	08/99 →
-------	--------	----	---------

SAG075
H1 **SENSORE GIRI / FASE - ALBERO MOTORE**
CRANKSHAFT POSITION SENSOR

BMW
3 (E36)

320 i	Petrol	110	09/90 → 02/98
-------	--------	-----	---------------

3 Cabriolet (E36)

320 i	Petrol	110	12/93 → 04/99
-------	--------	-----	---------------

3 Coupé (E36)

320 i	Petrol	110	03/92 → 04/99
-------	--------	-----	---------------

5 (E34)

520 i 24V	Petrol	110	09/89 → 09/95
-----------	--------	-----	---------------

5 Touring (E34)

520 i	Petrol	110	11/91 → 01/97
-------	--------	-----	---------------

SAG076
H1 **SENSORE GIRI / FASE - ALBERO MOTORE**
CRANKSHAFT POSITION SENSOR

FIAT
TEMPRA (159)

1.4 i.e. (159.AC, 159.AX)	Petrol	51	03/95 → 08/96
---------------------------	--------	----	---------------

1.6 i.e. (159.AS, 159.AT)	Petrol	55	04/93 → 08/96
---------------------------	--------	----	---------------

TEMPRA S.W. (159)

1.4 i.e. (159.AC, 159.AX)	Petrol	51	03/95 → 08/96
---------------------------	--------	----	---------------

SAG076



FIAT

TEMPRA S.W. (159)

1.6 i.e. (159.AS, 159.AT)	Petrol	55	04/93 → 08/96
---------------------------	--------	----	---------------

TIPO (160)

1.4 i.e. (160.AP, 160.AD, 160.EA)	Petrol	51	10/93 → 04/95
-----------------------------------	--------	----	---------------

1.6 i.e. (160.A1, 160.EC, 160.EB)	Petrol	55	03/93 → 04/95
-----------------------------------	--------	----	---------------

LANCIA

DEDRA (835)

1.6 i.e. (835AN)	Petrol	55	04/93 → 10/94
------------------	--------	----	---------------

DELTA II (836)

1.4 i.e. (836AF, 836AH)	Petrol	51	10/94 → 08/99
-------------------------	--------	----	---------------

1.6 i.e. (836AD)	Petrol	55	06/93 → 08/99
------------------	--------	----	---------------

SAG077

H1 **SENSORE GIRI / FASE - ALBERO MOTORE**
CRANKSHAFT POSITION SENSOR



SKODA

FABIA (6Y2)

1.0	Petrol	37	12/99 → 08/02
-----	--------	----	---------------

1.4	Petrol	44	08/00 → 08/02
-----	--------	----	---------------

1.4	Petrol	50	08/99 → 05/03
-----	--------	----	---------------

FABIA Combi (6Y5)

1.4	Petrol	44	04/00 → 03/03
-----	--------	----	---------------

1.4	Petrol	50	04/00 → 05/03
-----	--------	----	---------------

FABIA Praktik

1.4	Petrol	50	07/01 → 05/03
-----	--------	----	---------------

FABIA Tre volumi (6Y3)

1.4	Petrol	44	04/00 → 08/02
-----	--------	----	---------------

1.4	Petrol	50	07/01 → 05/03
-----	--------	----	---------------

OCTAVIA (1U2)

1.4	Petrol	44	04/99 → 03/01
-----	--------	----	---------------

SAG078

H1 **SENSORE GIRI / FASE - ALBERO MOTORE**
CRANKSHAFT POSITION SENSOR



SAAB

900 II

2.0 -16 Turbo	Petrol	136	09/95 → 02/98
---------------	--------	-----	---------------

2.0 i	Petrol	96	09/95 → 02/98
-------	--------	----	---------------

2.3 -16	Petrol	110	09/95 → 02/98
---------	--------	-----	---------------

900 II Cabriolet

2.0 -16 Turbo	Petrol	136	09/95 → 02/98
---------------	--------	-----	---------------

2.0 i	Petrol	96	09/95 → 02/98
-------	--------	----	---------------

2.3 -16	Petrol	110	09/95 → 02/98
---------	--------	-----	---------------

9-3 (YS3D)

2.0 i	Petrol	96	02/98 → 09/02
-------	--------	----	---------------

2.0 SE Turbo	Petrol	147	02/98 → 09/02
--------------	--------	-----	---------------

2.0 Turbo	Petrol	110	01/01 → 09/02
-----------	--------	-----	---------------

2.0 Turbo	Petrol	151	10/99 → 09/02
-----------	--------	-----	---------------

2.0 Turbo	Petrol	136	02/98 → 09/02
-----------	--------	-----	---------------

2.3	Petrol	169	09/99 → 01/02
-----	--------	-----	---------------

2.3 i	Petrol	110	02/98 → 09/02
-------	--------	-----	---------------

2.3 Turbo	Petrol	165	10/98 → 09/02
-----------	--------	-----	---------------

9-3 Cabriolet (YS3D)

2.0 i	Petrol	96	02/98 → 08/03
-------	--------	----	---------------

2.0 SE Turbo	Petrol	147	02/98 → 08/03
--------------	--------	-----	---------------

2.0 Turbo	Petrol	136	02/98 → 08/03
-----------	--------	-----	---------------

9-3 Cabriolet (YS3D)

2.0 Turbo	Petrol	110	01/01 → 08/03
-----------	--------	-----	---------------

2.0 Turbo	Petrol	151	10/99 → 08/03
-----------	--------	-----	---------------

2.3	Petrol	169	09/99 → 01/02
-----	--------	-----	---------------

2.3 i	Petrol	110	02/98 → 08/03
-------	--------	-----	---------------

2.3 Turbo	Petrol	165	10/99 → 08/03
-----------	--------	-----	---------------

9-5 (YS3E)

2.0 T	Petrol	110	09/97 →
-------	--------	-----	---------

2.0 T	Petrol	136	07/00 →
-------	--------	-----	---------

2.0 Turbo SE	Petrol	141	10/98 → 07/00
--------------	--------	-----	---------------

2.3 t	Petrol	125	09/97 →
-------	--------	-----	---------

2.3 t	Petrol	136	01/01 →
-------	--------	-----	---------

2.3 Turbo	Petrol	169	10/99 → 09/01
-----------	--------	-----	---------------

SAG078

KW

SAAB
9-5 (YS3E)

2.3 Turbo	Petrol	184	09/01 →
2.3 Turbo	Petrol	162	07/03 →

9-5 Station wagon (YS3E)

2.0 T	Petrol	110	10/98 →
2.0 T	Petrol	136	07/00 → 07/01
2.0 T	Petrol	141	10/98 →
2.3 t	Petrol	125	10/98 →
2.3 t	Petrol	136	01/01 →
2.3 Turbo	Petrol	169	10/99 → 09/01
2.3 Turbo	Petrol	184	09/01 →
2.3 Turbo	Petrol	162	07/03 →

SAG080
H1 **SENSORE GIRI / FASE - ALBERO MOTORE
CRANKSHAFT POSITION SENSOR**

KW

FIAT
BRAVO II (198)

1.6 D Multijet	Diesel	77	03/08 →
1.6 D Multijet	Diesel	88	03/08 →

DOBLO Cassone / Furgonato / Promiscuo (263)

1.6 D Multijet	Diesel	74	02/10 →
1.6 D Multijet	Diesel	77	02/10 →

DOBLO Combi (152, 263)

1.6 D Multijet	Diesel	66	02/10 →
----------------	--------	----	---------

LINEA (323)

1.6 D Multijet	Diesel	77	06/09 →
----------------	--------	----	---------

PUNTO EVO (199)

1.6 D Multijet	Diesel	88	10/09 → 02/12
----------------	--------	----	---------------

SCUDO (270_)

1.6 D Multijet	Diesel	66	01/07 →
----------------	--------	----	---------

SCUDO Pianale piatto/Telaio (270_)

1.6 D Multijet	Diesel	66	01/07 →
----------------	--------	----	---------

SAG081
H1 **SENSORE GIRI / FASE - ALBERO MOTORE
CRANKSHAFT POSITION SENSOR**

KW

HONDA
ACCORD V (CE, CF)

2.0 TDi (CF1)	Diesel	77	04/96 → 10/98
---------------	--------	----	---------------

ACCORD VI (CG, CK)

2.0 Turbo DI	Diesel	77	02/99 → 12/02
--------------	--------	----	---------------

ACCORD VI Hatchback (CH)

2.0 TDi	Diesel	77	12/99 → 10/00
---------	--------	----	---------------

CIVIC VI Aerodeck (MB, MC)

2.0 i D (MC3)	Diesel	77	04/98 → 02/01
---------------	--------	----	---------------

LAND ROVER
FREELANDER (LN)

2.0 DI 4x4	Diesel	72	02/98 → 11/00
------------	--------	----	---------------

FREELANDER Soft Top

2.0 DI 4x4	Diesel	72	02/98 → 10/06
------------	--------	----	---------------

MG
MG ZR

2.0 TD	Diesel	74	06/01 → 04/05
--------	--------	----	---------------

MG ZS

2.0 TD	Diesel	83	01/04 → 04/05
2.0 TD	Diesel	74	01/04 → 04/05

MG ZS Hatchback

2.0 TD	Diesel	83	01/04 → 10/05
2.0 TD	Diesel	74	01/04 → 10/05

ROVER
200 (RF)

220 D/SD	Diesel	63	11/95 → 03/00
220 SDi	Diesel	77	11/95 → 03/00

25 (RF)

2.0 iDT	Diesel	74	10/99 → 05/05
---------	--------	----	---------------

400 2 volumi /Coda spiovente (RT)

420 D	Diesel	63	11/95 → 03/00
420 Di	Diesel	77	10/95 → 03/00

45 (RT)

2.0 iDT	Diesel	74	02/00 → 05/05
---------	--------	----	---------------

SAG081



ROVER

45 Tre volumi (RT)

2.0 iDT Diesel 74 02/00 → 05/05

600 (RH)

620 Sdi Diesel 77 03/95 → 02/99

STREETWISE

2.0 TD Diesel 74 08/03 → 05/05

SAG082

H1 **SENSORE GIRI / FASE - ALBERO MOTORE**
CRANKSHAFT POSITION SENSOR



FIAT

500 C (312)

0.9 Petrol 63 09/09 →

1.2 Petrol 51 09/09 →

PANDA (169)

1.2 Bi-Power / Natural Power BiFuel 44 01/07 →

1.2 LPG Petrol/LPG 44 04/09 →

PUNTO EVO (199)

1.2 Petrol 48 10/09 → 02/12

SAG083

H1 **SENSORE GIRI / FASE - ALBERO MOTORE**
CRANKSHAFT POSITION SENSOR



FIAT

CROMA (194)

2.2 16V Petrol 108 06/05 →

OPEL

ASTRA G 2 volumi /Coda spiovente (F48_, F08_)

2.2 16V Petrol 108 06/00 → 01/05

ASTRA G Cabriolet (F67)

2.2 16V Petrol 108 03/01 → 10/05

ASTRA G Coupé (F07_)

2.2 16V Petrol 108 09/00 → 05/05

ASTRA G Station wagon (F35_)

2.2 16V Petrol 108 03/01 → 07/04

SIGNUM

2.2 direct Petrol 114 05/03 →

SPEEDSTER

2.2 Petrol 108 09/00 →

VECTRA B (36_)

2.2 i 16V Petrol 108 09/00 → 04/02

VECTRA B 2 volumi /Coda spiovente (38_)

2.2 i 16V Petrol 108 09/00 → 07/03

VECTRA B Station wagon (31_)

2.2 i 16V Petrol 108 09/00 → 07/03

VECTRA C

2.2 16V Petrol 108 04/02 →

2.2 direct Petrol 114 10/03 →

VECTRA C GTS

2.2 16V Petrol 108 08/02 →

2.2 direct Petrol 114 10/03 →

VECTRA C Station wagon

2.2 direct Petrol 114 10/03 →

ZAFIRA A (F75_)

2.2 16V Petrol 108 09/00 → 06/05

ZAFIRA B (A05)

2.2 Petrol 110 07/05 →

SAG083

VAUXHALL
ASTRA Mk IV (G) 2 volumi /Coda spiovente

2.2 16V Petrol 108 03/01 → 05/05

ASTRA Mk IV (G) Cabriolet

2.2 16V Petrol 108 03/01 → 10/05

ASTRA Mk IV (G) Coupé (F67)

2.2 16V Petrol 108 03/00 → 08/05

ASTRA Mk IV (G) Station wagon

2.2 16V Petrol 108 03/01 → 05/05

ASTRA Mk IV (G) Tre volumi

2.2 16V Petrol 108 03/01 → 05/05

SIGNUM

2.2 i Petrol 114 05/03 → 05/08

VECTRA (B)

2.2 i 16V Petrol 108 08/95 → 10/01

VECTRA (B) 2 volumi /Coda spiovente

2.2 i 16V Petrol 108 09/00 → 07/03

VECTRA (B) Station wagon

2.2 i 16V Petrol 108 08/95 → 10/01

VECTRA Mk II (C)

2.2 16V Petrol 108 01/02 → 10/08

2.2 direct Petrol 114 01/02 → 10/08

VECTRA Mk II (C) GTS

2.2 16V Petrol 108 08/02 → 07/08

2.2 direct Petrol 114 10/03 → 08/05

VECTRA Mk II (C) Station wagon

2.2 direct Petrol 114 10/03 → 07/08

VX220

2.2 i Petrol 108 09/00 → 07/05

ZAFIRA Mk I (A) (F75)

2.2 16V Petrol 108 11/98 → 08/04

ZAFIRA Mk II (B) (M75)

2.2 Petrol 110 07/05 →

SAG084
**H1 SENSORE GIRI / FASE - ALBERO MOTORE
CRANKSHAFT POSITION SENSOR**

VOLVO
850 (LS)

2.0 Petrol 93 08/94 → 12/96

2.0 Petrol 105 06/91 → 12/96

2.5 Petrol 106 08/94 → 12/96

2.5 Petrol 125 08/91 → 12/96

2.5 Petrol 103 06/91 → 07/94

850 Station wagon (LW)

2.0 Petrol 93 08/94 → 12/96

2.5 Petrol 103 08/92 → 07/94

2.5 Petrol 125 09/92 → 12/96

960 II (964)

2.5 Petrol 125 07/94 → 12/96

2.9 Petrol 150 07/94 → 12/96

960 II Station wagon (965)

2.5 Petrol 125 08/94 → 12/96

2.9 Petrol 150 09/94 → 12/96

C70 I Cabriolet

2.0 Petrol 132 03/98 → 07/98

2.0 T Petrol 166 03/98 → 07/98

2.3 T5 Petrol 176 03/98 → 07/98

2.5 T Petrol 142 03/98 → 07/98

C70 I Coupé

2.0 Petrol 132 03/97 → 09/02

2.0 T Petrol 166 03/97 → 07/98

2.3 T-5 Petrol 176 03/97 → 07/98

2.5 T Petrol 142 03/97 → 07/98

S70 (LS)

2.0 Petrol 120 01/97 → 07/98

V70 I (LV)

2.0 Petrol 120 01/97 → 07/98

2.3 T AWD Petrol 184 04/97 → 07/98

2.3 T-5 AWD Petrol 176 01/97 → 07/98

SAG085

H1 **SENSORE GIRI / FASE - ALBERO MOTORE**
CRANKSHAFT POSITION SENSOR



VOLVO

S40 I (VS)

1.6	Petrol	80	03/99 → 12/03
1.8	Petrol	85	07/95 → 08/99
1.8	Petrol	90	03/99 → 12/03
2.0	Petrol	100	07/95 → 12/03

V40 Station wagon (VW)

1.6	Petrol	80	03/99 → 06/04
1.8	Petrol	85	07/95 → 08/99
1.8	Petrol	90	03/99 → 06/04
2.0	Petrol	100	07/95 → 07/99

SAG086

H1 **SENSORE GIRI / FASE - ALBERO MOTORE**
CRANKSHAFT POSITION SENSOR



VOLVO

S40 I (VS)

1.9 T4	Petrol	147	05/97 → 07/00
2.0 T	Petrol	118	10/97 → 12/03
2.0 T	Petrol	120	06/01 → 12/03
2.0 T	Petrol	121	07/00 → 06/01
2.0 T4	Petrol	147	07/00 → 12/03

SAG086



VOLVO

V40 Station wagon (VW)

1.9 T4	Petrol	147	05/97 → 07/00
2.0	Petrol	100	08/99 → 06/04
2.0 T	Petrol	118	10/97 → 07/00
2.0 T	Petrol	121	07/99 → 06/04
2.0 T	Petrol	120	06/01 → 06/04
2.0 T4	Petrol	147	07/00 → 06/04

SAG087

H1 **SENSORE GIRI / FASE - ALBERO MOTORE**
CRANKSHAFT POSITION SENSOR



BMW

3 (E36)

320 i	Petrol	110	09/90 → 09/92
-------	--------	-----	---------------

3 Cabriolet (E36)

325 i	Petrol	141	03/93 → 03/95
-------	--------	-----	---------------

3 Coupé (E36)

320 i	Petrol	110	03/92 → 09/92
-------	--------	-----	---------------

5 (E34)

520 i 24V	Petrol	110	09/89 → 09/92
-----------	--------	-----	---------------

525 i 24V	Petrol	141	09/89 → 09/95
-----------	--------	-----	---------------

525 iX 24V	Petrol	141	10/91 → 09/95
------------	--------	-----	---------------

5 Touring (E34)

520 i	Petrol	110	11/91 → 09/92
-------	--------	-----	---------------

525 i	Petrol	141	11/91 → 01/97
-------	--------	-----	---------------

525 ix	Petrol	141	02/92 → 01/97
--------	--------	-----	---------------

SAG088
H1 **SENSORE GIRI / FASE - ALBERO MOTORE**
CRANKSHAFT POSITION SENSOR

MAZDA
323 S VI (BJ)

1.4 16V	Petrol	54	09/98 → 01/01
1.5 16V	Petrol	65	09/98 → 01/01
1.9 16V	Petrol	84	09/98 → 05/04
2.0 D	Diesel	52	09/98 → 05/04
2.0 TD	Diesel	66	09/98 → 05/04

DEMIO (DW)

1.5 16V	Petrol	55	04/00 → 07/03
---------	--------	----	---------------

SAG089

CITROËN
JUMPER Furgonato (244)

2.8 HDi	Diesel	94	04/02 →
2.8 HDi 4x4	Diesel	94	04/02 →

JUMPER Pianale piatto/Telaio (230)

2.8 HDi	Diesel	94	09/00 → 04/02
---------	--------	----	---------------

JUMPER Pianale piatto/Telaio (244)

2.8 HDi	Diesel	107	05/04 →
2.8 HDi	Diesel	94	04/02 →

FIAT
DUCATO Autobus (230)

2.8 JTD	Diesel	94	11/00 → 04/02
2.8 JTD 4x4	Diesel	94	11/00 → 04/02

DUCATO Autobus (244, Z_)

2.8 JTD	Diesel	94	04/02 →
2.8 JTD 4x4	Diesel	94	07/02 →

DUCATO Furgonato (230L)

2.8 JTD	Diesel	94	11/00 → 04/02
---------	--------	----	---------------

DUCATO Furgonato (244)

2.8 JTD	Diesel	94	04/02 →
2.8 JTD 4x4	Diesel	94	07/02 →
2.8 JTD Power	Diesel	107	05/04 →

DUCATO Pianale piatto/Telaio (230)

2.8 JTD	Diesel	94	11/00 → 04/02
---------	--------	----	---------------

DUCATO Pianale piatto/Telaio (244)

2.8 JTD	Diesel	94	04/02 → 07/06
2.8 JTD 4x4	Diesel	94	10/02 → 07/06
2.8 JTD Power	Diesel	107	05/04 → 07/06

PEUGEOT
BOXER Autobus (230P)

2.8 HDi	Diesel	94	11/00 → 04/02
---------	--------	----	---------------

BOXER Autobus (244, Z_)

2.8 HDi	Diesel	94	04/02 →
2.8 HDi 4x4	Diesel	94	04/02 →

BOXER Furgonato (230L)

2.8 HDi	Diesel	94	11/00 → 04/02
---------	--------	----	---------------

BOXER Furgonato (244)

2.8 HDi	Diesel	94	04/02 →
2.8 HDi	Diesel	107	04/04 →
2.8 HDi 4x4	Diesel	94	04/02 →

BOXER Pianale piatto/Telaio (244)

2.8 HDi	Diesel	94	04/02 →
2.8 HDi	Diesel	107	04/04 →
2.8 HDi 4x4	Diesel	94	04/02 →

BOXER Pianale piatto/Telaio (ZCT_)

2.8 HDi	Diesel	94	11/00 → 04/02
---------	--------	----	---------------

SAG089
H1 **SENSORE GIRI / FASE - ALBERO MOTORE**
CRANKSHAFT POSITION SENSOR

CITROËN
JUMPER Autobus (230P)

2.8 HDi	Diesel	94	09/00 → 04/02
2.8 HDi 4x4	Diesel	94	09/00 → 04/02

JUMPER Autobus (244, Z_)

2.8 HDi	Diesel	94	04/02 →
---------	--------	----	---------

JUMPER Furgonato (230L)

2.8 HDi	Diesel	94	09/00 → 04/02
2.8 HDi 4x4	Diesel	94	09/00 → 04/02

JUMPER Furgonato (244)

2.8 HDi	Diesel	107	05/04 →
---------	--------	-----	---------

SAG090

H1 **SENSORE GIRI / FASE - ALBERO MOTORE**
CRANKSHAFT POSITION SENSOR



AUDI

A4 (8EC, B7)

2.7 TDI	Diesel	132	01/06 → 06/08
3.0 TDI quattro	Diesel	150	11/04 → 06/08
3.0 TDI quattro	Diesel	171	01/06 → 06/08

A4 Avant (8ED, B7)

2.7 TDI	Diesel	120	11/05 → 03/08
2.7 TDI	Diesel	132	01/06 → 06/08
3.0 TDI quattro	Diesel	150	11/04 → 06/08
3.0 TDI quattro	Diesel	171	01/06 → 06/08

A4 Cabriolet (8H7, B6, 8HE, B7)

2.7 TDI	Diesel	132	06/06 → 03/09
3.0 TDI quattro	Diesel	150	01/06 → 03/09
3.0 TDI quattro	Diesel	171	01/06 → 03/09

A6 (4F2, C6)

2.7 TDI	Diesel	132	11/04 → 10/08
2.7 TDI	Diesel	120	11/04 → 03/11
2.7 TDI quattro	Diesel	132	11/04 → 10/08
2.7 TDI quattro	Diesel	120	06/05 → 03/11
3.0 TDI	Diesel	171	06/06 → 03/11
3.0 TDI quattro	Diesel	155	05/04 → 03/11
3.0 TDI quattro	Diesel	165	05/04 → 05/06
3.0 TDI quattro	Diesel	171	06/06 → 10/08

A6 Avant (4F5, C6)

2.7 TDI	Diesel	132	03/05 → 10/08
2.7 TDI	Diesel	120	03/05 → 08/11
2.7 TDI quattro	Diesel	120	06/05 → 08/11
3.0 TDI	Diesel	171	06/06 → 08/11
3.0 TDI quattro	Diesel	155	03/05 → 08/11
3.0 TDI quattro	Diesel	165	03/05 → 05/06
3.0 TDI quattro	Diesel	171	06/06 → 10/08

A8 (4E_)

3.0 TDI quattro	Diesel	155	11/03 → 07/10
3.0 TDI quattro	Diesel	171	08/03 → 07/10

SAG090



VOLKSWAGEN

PHAETON (3D_)

3.0 V6 TDI 4motion	Diesel	165	09/04 →
-----------------------	--------	-----	---------

SAG091

H1 **SENSORE GIRI / FASE - ALBERO MOTORE**
CRANKSHAFT POSITION SENSOR



LAND ROVER

FREELANDER (LN)

1.8 16V 4x4	Petrol	86	11/00 → 10/06
1.8 i 16V 4x4	Petrol	88	02/98 → 11/00

FREELANDER Soft Top

1.8 i 16V 4x4	Petrol	88	02/98 → 10/06
---------------	--------	----	---------------

MG

MG ZS Hatchback

1.6	Petrol	82	11/01 → 10/05	CHASSIS: → YD471063
-----	--------	----	---------------	------------------------

MGF (RD)

1.6	Petrol	82	02/00 → 03/02
1.8 i 16V	Petrol	88	03/95 → 03/02
1.8 i VVC	Petrol	107	03/95 → 03/02

ROVER

100 / METRO (XP)

114 GTI 16V	Petrol	76	08/91 → 12/98
-------------	--------	----	---------------

100 Cabriolet (XP)

114	Petrol	75	03/97 → 10/98
-----	--------	----	---------------

400 2 volumi /Coda spiovente (RT)

414 Si	Petrol	76	05/95 → 03/00	CHASSIS: → YD471063
416 Si	Petrol	82	05/95 → 03/00	CHASSIS: → YD471063
420 Di	Diesel	77	05/95 → 03/00	

SAG091

ROVER
45 (RT)

1.4	Petrol	76	02/00 → 05/05	CHASSIS: → YD471063
-----	--------	----	---------------	------------------------

1.6	Petrol	80	02/00 → 05/05	CHASSIS: → YD471063
-----	--------	----	---------------	------------------------

45 Tre volumi (RT)

1.4	Petrol	76	02/00 → 05/05	CHASSIS: → YD471063
-----	--------	----	---------------	------------------------

1.6	Petrol	80	02/00 → 05/05	CHASSIS: → YD471063
-----	--------	----	---------------	------------------------

COUPE

1.8 16 V	Petrol	107	03/96 → 11/99	
----------	--------	-----	---------------	--

MINI Cabriolet (XN)

1.3	Petrol	63	11/96 → 05/01	CHASSIS:BD134455→
-----	--------	----	---------------	-------------------

1.3 S	Petrol	46	02/98 → 05/01	CHASSIS:BD134455→
-------	--------	----	---------------	-------------------

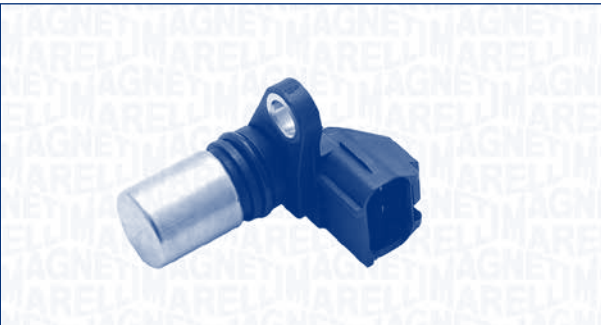
SAG092
H1 **SENSORE GIRI / FASE - ALBERO MOTORE
CRANKSHAFT POSITION SENSOR**

MAZDA
6 (GG)

2.0 DI	Diesel	100	06/02 → 08/07	
--------	--------	-----	---------------	--

2.0 DI	Diesel	89	08/02 → 08/07	
--------	--------	----	---------------	--

6 Hatchback (GG)

2.0 DI	Diesel	100	08/02 → 08/07	
--------	--------	-----	---------------	--

2.0 DI	Diesel	89	08/02 → 08/07	
--------	--------	----	---------------	--

6 Station Wagon (GY)

2.0 CiTD 4x4	Diesel	100	10/02 → 02/05	
--------------	--------	-----	---------------	--

2.0 CiTD 4x4	Diesel	89	10/02 → 02/05	
--------------	--------	----	---------------	--

2.0 DI	Diesel	100	08/02 → 08/07	
--------	--------	-----	---------------	--

2.0 DI	Diesel	89	08/02 → 08/07	
--------	--------	----	---------------	--

MPV II (LW)

2.0 DI	Diesel	100	07/02 → 02/06	
--------	--------	-----	---------------	--

SAG092

TOYOTA
DYNA Pianale piatto/Telaio (KD_, LY_, TRY2_, KDY2_, XZU4_, X)

2.5 D4d	Diesel	65	08/01 →	
---------	--------	----	---------	--

2.5 D4d	Diesel	75	08/01 →	
---------	--------	----	---------	--

HIACE III Wagon (LH1_, RZH1_)

2.5 D-4D 4WD	Diesel	75	08/01 → 08/04	
--------------	--------	----	---------------	--

HIACE IV Autobus (LH1_)

2.5 D-4D	Diesel	65	11/01 → 08/06	
----------	--------	----	---------------	--

2.5 D-4D	Diesel	75	11/01 → 08/06	
----------	--------	----	---------------	--

HIACE IV Furgonato (LXH1_, RZH1_, LH1_)

2.5 D-4D	Diesel	65	11/01 → 08/06	
----------	--------	----	---------------	--

2.5 D-4D	Diesel	75	11/01 → 08/06	
----------	--------	----	---------------	--

2.5 D-4D 4WD	Diesel	75	11/01 → 08/06	
--------------	--------	----	---------------	--

LAND CRUISER (KDJ12_, GRJ12_)

3.0 D-4D (KDJ120, KDJ125)	Diesel	122	08/04 → 02/10	
------------------------------	--------	-----	---------------	--

3.0 D-4D (KDJ120, KDJ150, KDJ125)	Diesel	120	01/03 → 02/10	
---	--------	-----	---------------	--

LAND CRUISER 150 (KDJ15_, GRJ15_)

3.0 D-4D	Diesel	127	03/10 →	
----------	--------	-----	---------	--

LAND CRUISER 90 (_J9_)

3.0 D-4D (KDJ90, KDJ95, KDJ125)	Diesel	120	10/00 →	
------------------------------------	--------	-----	---------	--

SAG093
H1 **SENSORE GIRI / FASE - ALBERO MOTORE
CRANKSHAFT POSITION SENSOR**

OPEL
ASTRA F (56_, 57_)

2.0 i	Petrol	85	03/92 → 09/98	CHASSIS:S2000001→
-------	--------	----	---------------	-------------------

ASTRA F 2 volumi /Coda spiovente (53_, 54_, 58_, 59_)

2.0 GSI 16V	Petrol	110	09/91 → 01/98	
-------------	--------	-----	---------------	--

2.0 i	Petrol	85	09/91 → 01/98	CHASSIS:S2000001→
-------	--------	----	---------------	-------------------

SAG093



KW



OPEL

ASTRA F Cabriolet (53_B)

2.0 i Petrol 85 03/93 → 10/94 CHASSIS: S2000001 →

ASTRA F Station wagon (51_, 52_)

2.0 i Petrol 85 09/91 → 07/94 CHASSIS: S2000001 →

2.0 i 16V Petrol 110 03/93 → 01/98

CALIBRA A (85_)

2.0 i Petrol 85 06/90 → 07/97

2.0 i 16V Petrol 110 06/90 → 02/94

2.0 i 16V 4x4 Petrol 110 06/90 → 02/94

2.0 i 4x4 Petrol 85 06/90 → 07/97

2.0 i Turbo 4x4 Petrol 150 03/92 → 07/97

FRONTERA A (5_MWL4)

2.2 i (54MWL4) Petrol 100 03/95 → 10/98 CHASSIS:
→ TV899999

FRONTERA A Sport (5_SUD2)

2.0 i (52SUD2, 55SUD2) Petrol 85 03/92 → 10/98

OMEGA A (16_, 17_, 19_)

1.8 Petrol 85 09/86 → 03/94

1.8 Petrol 65 09/87 → 03/94

1.8 S Petrol 66 09/86 → 03/94

2.0 Petrol 90 09/86 → 03/94

2.0 Petrol 73 09/90 → 03/94

2.0 Petrol 74 09/90 → 03/94

2.0 i Petrol 85 09/86 → 03/94

OMEGA A Station wagon (66_, 67_)

1.8 Petrol 85 09/86 → 03/94

1.8 Petrol 65 09/87 → 03/94

1.8 S Petrol 66 09/86 → 03/94

2.0 Petrol 90 09/86 → 03/94

2.0 Petrol 74 09/90 → 03/94

2.0 i Petrol 85 09/86 → 03/94

2.0 i Petrol 73 09/90 → 03/94

VECTRA A (86_, 87_)

1.6 i Petrol 55 09/93 → 11/95

1.8 i Cat. Petrol 66 03/90 → 11/95 CHASSIS:
→ P79999992.0 i Petrol 85 09/88 → 10/90 CHASSIS:
→ P7999999

2.0 i Petrol 95 09/88 → 09/92

2.0 i 4x4 Petrol 85 01/89 → 10/90 CHASSIS:
→ P7999999

2.0 i 4x4 Petrol 95 01/89 → 09/92

2000 16V 4x4 Petrol 110 01/89 → 10/90

2000/GT 16V Petrol 110 01/89 → 06/94

SAG093



KW



OPEL

VECTRA A 2 volumi /Coda spiovente (88_, 89_)

1.6 i Cat. Petrol 55 09/88 → 11/95

1.8 i Cat. Petrol 66 03/90 → 11/95 CHASSIS:
→ P79999992.0 i Petrol 85 09/88 → 10/90 CHASSIS:
→ P7999999

2.0 i 16V Petrol 110 02/89 → 10/90

2.0 i GT Petrol 95 09/88 → 11/95

SAAB

900 II

2.0 -16 Turbo Petrol 136 07/93 → 08/95

2.0 i Petrol 98 07/93 → 07/94

2.0 i Petrol 96 08/94 → 08/95

2.3 -16 Petrol 110 07/93 → 08/95

900 II Cabriolet

2.0 -16 Turbo Petrol 136 12/93 → 08/95

2.0 i Petrol 96 12/93 → 08/95

2.3 -16 Petrol 110 12/93 → 08/95

900 II Coupé

2.0 i Petrol 98 12/93 → 07/94

9000

2.0 -16 CD Petrol 96 09/93 → 12/98

2.0 -16 CD Petrol 110 09/93 → 12/98

2.0 -16 Turbo CD Petrol 108 09/93 → 12/98

2.3 -16 CD Turbo Petrol 147 09/93 → 12/98

2.3 -16 CDE Petrol 108 09/93 → 12/98

2.3 -16 CDE Eco-Power Petrol 125 09/93 → 12/98

9000 2 volumi /Coda spiovente

2.0 -16 CS Petrol 96 09/93 → 12/98

2.0 -16 ND Turbo Petrol 110 09/93 → 12/98

2.3 -16 CSE Petrol 108 09/93 → 12/98

2.3 -16 CSE Eco Power Petrol 125 09/93 → 12/98

2.3-16 Turbo CSE Petrol 147 09/93 → 12/98

9-3 (YS3D)

2.0 Turbo Petrol 113 10/98 → 09/02

9-3 Cabriolet (YS3D)

2.0 Turbo Petrol 113 10/98 → 08/03

VAUXHALL

ASTRA Mk III (F)

2.0 i Petrol 85 03/92 → 09/98 CHASSIS: S2000001 →

ASTRA Mk III (F) 2 volumi /Coda spiovente

2.0 i Petrol 85 09/91 → 02/98 CHASSIS: S2000001 →

SAG093

VAUXHALL
ASTRA Mk III (F) Cabriolet

2.0 i	Petrol	85	03/93 → 10/94	CHASSIS: S2000001 →
-------	--------	----	---------------	---------------------

ASTRA Mk III (F) Station wagon

2.0 i	Petrol	85	09/91 → 02/98	CHASSIS: S2000001 →
-------	--------	----	---------------	---------------------

CARLTON Mk III

1.8	Petrol	65	09/87 → 03/94	
-----	--------	----	---------------	--

1.8 i	Petrol	85	09/86 → 03/94	
-------	--------	----	---------------	--

2.0 i	Petrol	90	09/86 → 03/94	
-------	--------	----	---------------	--

CARLTON Mk III Station wagon

1.8	Petrol	65	09/87 → 03/94	
-----	--------	----	---------------	--

1.8 i	Petrol	85	09/86 → 03/94	
-------	--------	----	---------------	--

2.0 i	Petrol	90	09/86 → 03/94	
-------	--------	----	---------------	--

CAVALIER Mk III (87)

1.8	Petrol	66	09/88 → 08/95	CHASSIS: → P7999999
-----	--------	----	---------------	------------------------

1.8 i Cat.	Petrol	66	03/90 → 11/95	CHASSIS: → P7999999
------------	--------	----	---------------	------------------------

2.0 i	Petrol	85	09/88 → 10/90	CHASSIS: → P7999999
-------	--------	----	---------------	------------------------

2.0 i 16V	Petrol	110	09/88 → 11/95	
-----------	--------	-----	---------------	--

2.0 i 16V 4x4	Petrol	110	09/88 → 11/95	
---------------	--------	-----	---------------	--

2.0 i 4x4	Petrol	85	01/91 → 10/92	CHASSIS: → P7999999
-----------	--------	----	---------------	------------------------

2.0 i 4x4	Petrol	95	09/88 → 09/92	
-----------	--------	----	---------------	--

2.0 i Cat.	Petrol	85	09/90 → 11/95	CHASSIS: → P7999999
------------	--------	----	---------------	------------------------

2.0 i Turbo 4x4	Petrol	150	06/92 → 11/94	
-----------------	--------	-----	---------------	--

2.0 SRi	Petrol	95	09/88 → 09/92	
---------	--------	----	---------------	--

CAVALIER Mk III 2 volumi /Coda spiovente

1.8	Petrol	66	09/88 → 10/90	CHASSIS: → P7999999
-----	--------	----	---------------	------------------------

1.8 i Cat.	Petrol	66	03/90 → 11/95	CHASSIS: → P7999999
------------	--------	----	---------------	------------------------

2.0 i	Petrol	85	09/88 → 10/92	CHASSIS: → P7999999
-------	--------	----	---------------	------------------------

2.0 i 16V	Petrol	110	09/88 → 11/95	
-----------	--------	-----	---------------	--

2.0 i 16V 4x4	Petrol	110	01/92 → 11/93	
---------------	--------	-----	---------------	--

2.0 i 4x4	Petrol	85	01/91 → 10/92	CHASSIS: → P7999999
-----------	--------	----	---------------	------------------------

2.0 i 4x4	Petrol	95	09/88 → 09/92	
-----------	--------	----	---------------	--

2.0 i Cat.	Petrol	85	09/90 → 11/95	CHASSIS: → P7999999
------------	--------	----	---------------	------------------------

2.0 SRi	Petrol	95	09/88 → 09/92	
---------	--------	----	---------------	--

SAG093

VAUXHALL
FRONTERA Mk I (A)

2.2 i	Petrol	100	03/95 → 10/98	CHASSIS: → TV899999
-------	--------	-----	---------------	------------------------

FRONTERA Mk I (A) Sport

2.0 i	Petrol	85	03/92 → 10/98	
-------	--------	----	---------------	--

SAG094
**H1 SENSORE GIRI / FASE - ALBERO MOTORE
CRANKSHAFT POSITION SENSOR**

HYUNDAI
ACCENT II (LC)

1.3	Petrol	62	08/02 → 11/05	
-----	--------	----	---------------	--

ELANTRA (XD)

2.0 CRDi	Diesel	83	04/01 → 07/06	
----------	--------	----	---------------	--

GETZ (TB)

1.3	Petrol	63	09/03 → 09/05	
-----	--------	----	---------------	--

MATRIX (FC)

1.6	Petrol	76	06/01 → 08/10	
-----	--------	----	---------------	--

1.8	Petrol	90	06/01 → 08/10	
-----	--------	----	---------------	--

TRAJET (FO)

2.0	Petrol	100	03/00 → 07/08	
-----	--------	-----	---------------	--

TUCSON (JM)

2.0	Petrol	104	08/04 → 03/10	
-----	--------	-----	---------------	--

SAG095

H1 **SENSORE GIRI / FASE - ALBERO MOTORE**
CRANKSHAFT POSITION SENSOR



RENAULT

19 II (B/C53_)

1.4	Petrol	59	01/92 → 12/95
1.4 (B/C532)	Petrol	43	04/92 → 12/95
1.4 (B/C535)	Petrol	55	01/92 → 12/95
1.7 (B/C53B)	Petrol	54	04/92 → 12/95

19 II Cabriolet (D53_, 853_)

1.7 (D53C)	Petrol	66	04/92 → 09/93
------------	--------	----	---------------

19 II Chamade (L53_)

1.4 (532)	Petrol	43	04/92 → 12/95
1.4 (L535)	Petrol	55	11/93 → 12/95
1.7 (L53B)	Petrol	54	04/92 → 12/95

21 (B48_)

1.7 (B48E)	Petrol	66	09/89 → 06/94
1.7 (B48F)	Petrol	54	09/89 → 10/92
2.0 (B48C)	Petrol	88	09/89 → 12/93
2.0 (B48R/Y)	Petrol	99	02/90 → 10/92

21 Station wagon (K48_)

1.7 (K48E)	Petrol	66	10/89 → 12/93
1.7 (K48F) Cat.	Petrol	54	05/88 → 06/93
2.0 (K48C)	Petrol	88	03/86 → 12/93
2.0 4x4	Petrol	88	03/89 → 12/93

21 Tre volumi (L48_)

1.7 (L48E)	Petrol	66	09/89 → 02/94
1.7 (L48E)	Petrol	69	03/86 → 02/94
1.7 (L48M, L48F)	Petrol	54	07/86 → 02/94
2.0 (L48C)	Petrol	88	03/86 → 12/93

CLIO I (B/C57_, 5/357_)

1.2 (B/C/S577)	Petrol	40	01/96 → 12/96
----------------	--------	----	---------------

SUPER 5 (B/C40_)

1.7 (B/C408)	Petrol	54	10/86 → 03/95
--------------	--------	----	---------------

SAG096

H1 **SENSORE GIRI / FASE - ALBERO MOTORE**
CRANKSHAFT POSITION SENSOR



AUDI

A4 (8D2, B5)

2.4 quattro	Petrol	121	03/97 → 11/00
2.8	Petrol	142	10/96 → 11/00
2.8 quattro	Petrol	142	10/96 → 08/01

A4 (8E2, B6)

2.4	Petrol	125	09/01 → 12/04
3.0 quattro	Petrol	160	04/01 → 12/04

A4 Avant (8D5, B5)

2.4	Petrol	121	03/97 → 09/01
2.4 quattro	Petrol	121	03/97 → 09/01
2.8	Petrol	142	10/96 → 09/01
2.8 quattro	Petrol	142	10/96 → 09/01

A4 Avant (8E5, B6)

2.4	Petrol	125	09/01 → 12/04
3.0	Petrol	160	04/01 → 12/04
3.0 quattro	Petrol	160	04/01 → 12/04

A4 Cabriolet (8H7, B6, 8HE, B7)

2.4	Petrol	125	04/02 → 12/05
-----	--------	-----	---------------

A6 (4B2, C5)

2.4	Petrol	115	02/97 → 01/05
2.4	Petrol	120	02/97 → 01/05
2.4	Petrol	121	02/97 → 01/05
2.4 quattro	Petrol	120	02/97 → 01/05
2.4 quattro	Petrol	121	02/97 → 01/05
2.8	Petrol	142	02/97 → 01/05
2.8 quattro	Petrol	142	02/97 → 01/05

A6 Avant (4B5, C5)

2.4	Petrol	115	12/97 → 01/05
2.4	Petrol	120	12/97 → 01/05
2.4 quattro	Petrol	121	12/97 → 01/05

A8 (4E_)

3.0	Petrol	160	07/03 → 05/06
3.0	Petrol	162	07/03 → 05/05

SAG096

AUDI
TT (8N3)

1.8 T quattro Petrol 165 09/02 → 06/06

TT Roadster (8N9)

1.8 T quattro Petrol 165 09/02 → 06/06

SEAT
LEON (1M1)

1.8 T Cupra R Petrol 154 02/02 → 06/06

1.8 T Cupra R Petrol 165 07/03 → 06/06

VW
PASSAT (3B2)

2.5 TDI Syncro/4motion Diesel 110 12/98 → 04/99

PASSAT Variant (3B5)

2.5 TDI Syncro/4motion Diesel 110 12/98 → 04/99

2.8 V6 Syncro/4motion Petrol 142 07/98 → 11/00

TRANSPORTER IV Autobus (70XB, 70XC, 7DB, 7DW)

2.8 VR6 Petrol 150 04/00 → 04/03

TRANSPORTER IV Furgonato (70XA)

2.8 VR6 Petrol 150 06/00 → 04/03

SAG097
**H1 SENSORE GIRI / FASE - ALBERO MOTORE
CRANKSHAFT POSITION SENSOR**

FIAT
PUNTO (188)

1.2 16V 80 (188.233, .235, .253, .255, .333, .353, .639...) Petrol 59 09/99 → 06/03

STILO (192)

1.2 16V (192_XA1B) Petrol 59 02/02 → 12/03

SAG098
**H1 SENSORE GIRI / FASE - ALBERO MOTORE
CRANKSHAFT POSITION SENSOR**

DAEWOO
LANOS (KLAT)

1.4 Petrol 55 05/97 →

1.5 Petrol 63 05/97 →

1.6 16V Petrol 78 05/97 →

LANOS Tre volumi (KLAT)

1.4 Petrol 55 05/97 →

1.5 Petrol 63 05/97 →

1.6 16V Petrol 78 05/97 →

NUBIRA (KLAJ)

1.6 16V Petrol 78 05/97 → CHASSIS: → 580669

NUBIRA Tre volumi (KLAJ)

1.6 16V Petrol 76 07/00 → CHASSIS: → 580669

1.6 16V Petrol 78 05/97 → CHASSIS: → 580669

NUBIRA Wagon (KLAJ)

1.6 16V Petrol 76 12/00 → CHASSIS: → 580669

1.6 16V Petrol 78 05/97 → CHASSIS: → 580669

SAG099
**H1 SENSORE GIRI / FASE - ALBERO MOTORE
CRANKSHAFT POSITION SENSOR**

BMW
3 (E36)

316 i Petrol 75 07/93 → 09/95

SAG099



BMW

3 (E36)

318 i	Petrol	85	10/93 → 09/95
318 is	Petrol	103	10/93 → 02/98

3 Cabriolet (E36)

318 i	Petrol	85	01/94 → 09/95
-------	--------	----	---------------

3 Compact (E36)

316 i	Petrol	75	03/94 → 09/95
318 ti	Petrol	103	11/94 → 08/95

3 Coupé (E36)

316 i	Petrol	75	09/93 → 09/95
318 is	Petrol	103	10/93 → 10/95

5 (E34)

518 i	Petrol	85	08/89 → 09/95
-------	--------	----	---------------

5 Touring (E34)

518 g	BiFuel	85	11/95 → 06/96
518 i	Petrol	85	09/94 → 01/97

SAG100

H1 **SENSORE GIRI / FASE - ALBERO MOTORE**
CRANKSHAFT POSITION SENSOR



AUDI

A3 (8P1)

2.0 FSI	Petrol	110	05/03 → 06/08
---------	--------	-----	---------------

A3 Sportback (8PA)

2.0 FSI	Petrol	110	09/04 → 06/08
---------	--------	-----	---------------

SEAT

ALHAMBRA (7V8, 7V9)

1.8 T 20V	Petrol	110	10/97 → 03/10
-----------	--------	-----	---------------

ALTEA (5P1)

2.0 FSI	Petrol	110	05/04 → 03/09
---------	--------	-----	---------------

LEON (1P1)

2.0 FSI	Petrol	110	07/05 → 05/10
---------	--------	-----	---------------

TOLEDO III (5P2)

2.0 FSI	Petrol	110	10/04 → 05/09
---------	--------	-----	---------------

SAG100



SKODA

OCTAVIA (1Z3)

2.0 FSI	Petrol	110	11/04 →
---------	--------	-----	---------

OCTAVIA Combi (1Z5)

2.0 FSI	Petrol	110	11/04 →
2.0 FSI 4x4	Petrol	110	11/04 →

VW

EOS (1F7, 1F8)

2.0 FSI	Petrol	110	03/06 → 05/08
---------	--------	-----	---------------

GOLF V (1K1)

2.0 FSI	Petrol	110	01/04 → 11/08
2.0 FSI 4motion	Petrol	110	08/04 → 11/08

JETTA III (1K2)

2.0 FSI	Petrol	110	08/05 → 10/10
---------	--------	-----	---------------

MULTIVAN V (7HM, 7HN, 7HF, 7EF, 7EM, 7EN)

2.0	Petrol	85	11/03 →
-----	--------	----	---------

PASSAT (3C2)

2.0 FSI	Petrol	110	03/05 → 07/10
2.0 FSI 4motion	Petrol	110	09/05 → 07/10

PASSAT Variant (3C5)

2.0 FSI	Petrol	110	08/05 → 11/10
2.0 FSI 4motion	Petrol	110	09/05 → 11/10

SHARAN (7M8, 7M9, 7M6)

1.8 T 20V	Petrol	110	05/00 → 03/10
2.0	Petrol	85	05/00 → 03/10

TOURAN (1T1, 1T2)

2.0 FSI	Petrol	110	10/03 → 11/05
---------	--------	-----	---------------

TRANSPORTER V Autobus (7HB, 7HJ, 7EB, 7EJ, 7EF)

2.0	Petrol	85	11/03 →
-----	--------	----	---------

TRANSPORTER V Furgonato (7HA, 7HH, 7EA, 7EH)

2.0	Petrol	85	11/03 →
-----	--------	----	---------

TRANSPORTER V Pianale piatto/Telaio (7JD, 7JE, 7JL, 7JY, 7JZ)

2.0	Petrol	85	11/03 →
-----	--------	----	---------

SAG101
H1 **SENSORE GIRI / FASE - ALBERO MOTORE**
CRANKSHAFT POSITION SENSOR

FORD
MONDEO I (GBP)

1.8 TD	Diesel	65	06/93 → 08/96
1.8 TD	Diesel	66	10/95 → 08/96

MONDEO I Station wagon (BNP)

1.8 TD	Diesel	65	06/93 → 08/96
1.8 TD	Diesel	66	11/95 → 08/96

MONDEO I Tre volumi (GBP)

1.8 TD	Diesel	65	06/93 → 08/96
1.8 TD	Diesel	66	10/95 → 08/96

TRANSIT Autobus (E_ _)

2.5 DI (EBL, ECL, EDS, EDL)	Diesel	56	07/94 → 03/00
2.5 DI (EBL, EDL, EDS, ESL, ESS)	Diesel	85	08/97 → 03/00
2.5 DI (EBL, EDS, ESL, ESS, EUS)	Diesel	51	08/94 → 03/00
2.5 DI (EBS, EDS, EDL, ESS, EUS)	Diesel	51	08/91 → 07/94
2.5 DI (EBS, EDS, EGL, ESS, EUS)	Diesel	59	09/91 → 07/94

TRANSIT Furgonato (E_ _)

2.5 DI (EAL, EAS)	Diesel	51	06/94 → 03/00
2.5 DI (EAL, EAS)	Diesel	56	06/94 → 03/00
2.5 DI (EAL, EAS)	Diesel	85	05/99 → 03/00

TRANSIT Pianale piatto/Telaio (E_ _)

2.5 DI (EME/L/S, ENE/L/S)	Diesel	56	08/94 → 03/00
2.5 DI (EME/L/S, ENE/L/S)	Diesel	59	09/91 → 08/94
2.5 DI (EML, ENE/L)	Diesel	85	05/99 → 03/00
2.5 DI (EML/S, ENL/S)	Diesel	51	08/94 → 03/00

SAG101

FORD
TRANSIT Pianale piatto/Telaio (E_ _)

2.5 DI (EML/S, ENL/S)	Diesel	51	09/91 → 08/94
-----------------------	--------	----	---------------

SAG102
H1 **SENSORE GIRI / FASE - ALBERO MOTORE**
CRANKSHAFT POSITION SENSOR

ALFA ROMEO
147 (937)

1.6 16V T.SPARK (937AXB1A)	Petrol	88	01/01 → 03/10	ENGINE: 3636740 →
1.6 16V T.SPARK ECO (937AXA1A)	Petrol	77	01/01 → 03/10	ENGINE: 3613608 →
2.0 16V T.SPARK (937AXC1_)	Petrol	110	01/01 → 03/10	ENGINE: 3649575 →

156 (932)

1.6 16V T.SPARK (932A4)	Petrol	88	01/02 → 09/05	ENGINE: 3636740 →
1.8 16V T.SPARK (932A31_)	Petrol	103	01/02 → 09/05	ENGINE: 3649575 →
2.0 16V T.SPARK (932A21_)	Petrol	110	01/02 → 03/02	ENGINE: 3649575 →
2.0 JTS (932AXA)	Petrol	122	03/02 → 09/05	

156 Sportwagon (932)

1.6 16V T.SPARK (932A4)	Petrol	88	01/02 → 05/06	ENGINE: 3636740 →
1.8 16V T.SPARK (932B31_)	Petrol	103	01/02 → 05/06	ENGINE: 3649575 →
2.0 16V T.SPARK (932B21_)	Petrol	110	01/02 → 03/02	ENGINE: 3649575 →
2.0 JTS (932BXA)	Petrol	122	03/02 → 05/06	

166 (936)

2.0 T.SPARK (936A3B_)	Petrol	110	10/00 → 06/07	ENGINE: 3649575 →
-----------------------	--------	-----	---------------	-------------------

SAG102



KW



ALFA ROMEO

GT (937)

1.8 TS	Petrol	103	11/03 → 09/10
2.0 JTS	Petrol	121	11/03 → 09/10

GTV (916C_)

2.0 JTS	Petrol	121	04/03 → 10/05
---------	--------	-----	---------------

2.0 T.SPARK 16V (916.C2_ , 916C2C00)	Petrol	110	06/00 → 10/05	ENGINE: 3649575 →
--------------------------------------	--------	-----	---------------	-------------------

SPIDER (916S_)

2.0 JTS	Petrol	121	04/03 → 04/05
---------	--------	-----	---------------

2.0 T.SPARK 16V (916S2C00)	Petrol	110	09/00 → 04/05	ENGINE: 3649575 →
----------------------------	--------	-----	---------------	-------------------

SAG103

H1 **SENSORE GIRI / FASE - ALBERO MOTORE CRANKSHAFT POSITION SENSOR**

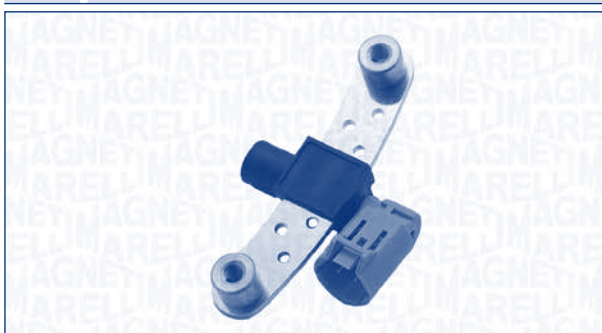

KW



NISSAN

KUBISTAR (X76)

1.6 16V	Petrol	70	08/03 →
---------	--------	----	---------

KUBISTAR Furgonato (X80)

1.6 16V	Petrol	70	08/03 →
---------	--------	----	---------

RENAULT

GRAND SCÉNIC II (JM0/1_)

1.6	Petrol	83	04/04 →
-----	--------	----	---------

LAGUNA II (BG0/1_)

1.8 16V (BG06, BG0J, BG0M)	Petrol	85	03/01 →
----------------------------	--------	----	---------

LAGUNA II Grandtour (KG0/1_)

1.8 16V (KG0J)	Petrol	85	03/01 →
----------------	--------	----	---------

MEGANE II Coupé-Cabriolet (EM0/1_)

1.6	Petrol	83	09/03 →
-----	--------	----	---------

1.6 16V	Petrol	82	01/06 →
---------	--------	----	---------

MEGANE II Station wagon (KM0/1_)

1.6	Petrol	83	08/03 →
-----	--------	----	---------

SAG103



KW



RENAULT

MEGANE II Tre volumi (LM0/1_)

1.6	Petrol	83	09/03 →
-----	--------	----	---------

SCÉNIC II (JM0/1_)

1.6 (JM0C, JM0J, JM1B)	Petrol	83	06/03 →
------------------------	--------	----	---------

SAG104

H1 **SENSORE GIRI / FASE - ALBERO MOTORE CRANKSHAFT POSITION SENSOR**



KW



BMW

3 (E36)

316 i	Petrol	75	10/95 → 02/98
318 i	Petrol	85	10/95 → 02/98

3 Cabriolet (E36)

318 i	Petrol	85	10/95 → 04/99
-------	--------	----	---------------

3 Compact (E36)

316 g	BiFuel	75	03/94 → 08/00
316 i	Petrol	75	10/95 → 08/00

3 Coupé (E36)

316 i	Petrol	75	10/95 → 04/99
-------	--------	----	---------------

3 Touring (E36)

316 i	Petrol	75	01/96 → 10/99
318 i	Petrol	85	07/95 → 10/99

Z3 (E36)

1.8	Petrol	85	10/95 → 10/98
-----	--------	----	---------------

SAG105
H1 **SENSORE GIRI / FASE - ALBERO MOTORE**
CRANKSHAFT POSITION SENSOR

HYUNDAI
ACCENT I (X-3)

1.3	Petrol	44	10/94 → 01/00
1.3	Petrol	55	10/94 → 01/00
1.3 i 12V	Petrol	62	10/94 → 01/00
1.5 i 12V	Petrol	65	10/94 → 01/00
1.5 i 16V	Petrol	73	12/95 → 01/00

ACCENT Tre volumi (X-3)

1.3	Petrol	44	10/94 → 01/00
1.3	Petrol	55	10/94 → 01/00
1.3 i 12V	Petrol	62	10/94 → 01/00
1.5 i 12V	Petrol	65	10/94 → 01/00
1.5 i 16V	Petrol	73	10/95 → 01/00

COUPE (RD)

1.6 i 16V	Petrol	84	12/96 → 04/02
-----------	--------	----	---------------

LANTRA II (J-2)

1.5 12V	Petrol	65	12/96 → 09/00
1.6 16V	Petrol	84	11/95 → 09/00
1.6 i	Petrol	66	11/95 → 09/00
1.8 16V	Petrol	94	11/95 → 09/00

LANTRA II Wagon (J-2)

1.5 12V	Petrol	65	04/97 → 10/00
2.0 16V	Petrol	102	12/96 → 10/00

SAG106
H1 **SENSORE GIRI / FASE - ALBERO MOTORE**
CRANKSHAFT POSITION SENSOR

CHEVROLET
KALOS

1.4	Petrol	61	03/05 →
1.4 16V	Petrol	69	03/05 →

KALOS Tre volumi

1.4 16V	Petrol	69	03/05 →
---------	--------	----	---------

LACETTI (J200)

1.4 16V	Petrol	70	03/05 →
1.6	Petrol	80	03/05 →

NUBIRA Station wagon

1.6	Petrol	80	03/05 →
-----	--------	----	---------

NUBIRA Tre volumi

1.6	Petrol	80	03/05 →
-----	--------	----	---------

TACUMA

1.6	Petrol	79	08/05 →
-----	--------	----	---------

DAEWOO
KALOS (KLAS)

1.4	Petrol	61	09/02 → 01/05
1.4 16V	Petrol	69	04/03 → 01/05

LACETTI 2 volumi /Coda spiovente (KLAN)

1.4	Petrol	70	02/04 → 01/05
1.6	Petrol	80	02/04 →

NUBIRA Tre volumi (KLAN)

1.6	Petrol	80	07/03 →
-----	--------	----	---------

NUBIRA Wagon (KLAN)

1.6	Petrol	80	07/03 →
-----	--------	----	---------

TACUMA (KLAU)

1.6	Petrol	77	09/00 →
1.8	Petrol	74	09/00 →

SAG107

H1 **SENSORE GIRI / FASE - ALBERO MOTORE**
CRANKSHAFT POSITION SENSOR



OPEL

ASTRA F (56_, 57_)

1.8 i 16V	Petrol	85	09/95 → 08/97	ENGINE: 14142429 →
2.0 i 16V	Petrol	100	02/95 → 09/98	ENGINE: 14142429 →

ASTRA F 2 volumi /Coda spiovente (53_, 54_, 58_, 59_)

1.8 i 16V	Petrol	85	09/95 → 08/97	ENGINE: 14142429 →
2.0 i 16V	Petrol	100	02/95 → 01/98	ENGINE: 14142429 →

ASTRA F Cabriolet (53_B)

1.8 i 16V	Petrol	85	11/94 → 03/01	ENGINE: 14142429 →
-----------	--------	----	---------------	--------------------

ASTRA F Station wagon (51_, 52_)

1.8 i 16V	Petrol	85	09/95 → 08/97	ENGINE: 14142429 →
2.0 i 16V	Petrol	100	02/95 → 01/98	ENGINE: 14142429 →

CALIBRA A (85_)

2.0 i 16V	Petrol	100	02/94 → 07/97	ENGINE: 14142429 →
2.0 i 16V 4x4	Petrol	100	02/94 → 07/97	ENGINE: 14142429 →

OMEGA B (25_, 26_, 27_)

2.0 16V	Petrol	100	03/94 → 09/99	ENGINE: 14194717 →
---------	--------	-----	---------------	--------------------

OMEGA B Station wagon (21_, 22_, 23_)

2.0 16V	Petrol	100	03/94 → 09/99	ENGINE: 14194717 →
---------	--------	-----	---------------	--------------------

VECTRA B (36_)

1.8 i 16V	Petrol	85	10/95 → 09/00	
2.0 i 16V	Petrol	100	10/95 → 09/00	

VECTRA B 2 volumi /Coda spiovente (38_)

1.8 i 16V	Petrol	85	10/95 → 09/00	
2.0 i 16V	Petrol	100	10/95 → 09/00	
2.2 i 16V	Petrol	108	09/00 → 09/02	

VAUXHALL

ASTRA Mk III (F)

2.0 i 16V	Petrol	100	02/95 → 09/98	ENGINE: 14142429 →
-----------	--------	-----	---------------	--------------------

ASTRA Mk III (F) 2 volumi /Coda spiovente

2.0 i 16V	Petrol	100	01/94 → 02/98	ENGINE: 14142429 →
-----------	--------	-----	---------------	--------------------

ASTRA Mk III (F) Cabriolet

1.8 16V	Petrol	85	11/94 → 03/01	ENGINE: 14142429 →
---------	--------	----	---------------	--------------------

ASTRA Mk III (F) Station wagon

2.0 i 16V	Petrol	100	01/94 → 02/98	ENGINE: 14142429 →
-----------	--------	-----	---------------	--------------------

SAG107



VAUXHALL

VECTRA (B)

1.8 i 16V	Petrol	85	10/95 → 09/00
2.0 i 16V	Petrol	100	10/95 → 01/01

VECTRA (B) 2 volumi /Coda spiovente

1.8 i 16V	Petrol	85	10/95 → 09/00
2.0 i 16V	Petrol	100	10/95 → 01/01

VECTRA (B) Station wagon

1.8 i 16V	Petrol	85	11/96 → 09/00
2.0 i 16V	Petrol	100	10/95 → 01/01

SAG108

H1 **SENSORE GIRI / FASE - ALBERO MOTORE**
CRANKSHAFT POSITION SENSOR



MAZDA

626 V (GF)

1.8	Petrol	66	05/97 → 12/99
1.8	Petrol	74	12/99 → 10/02
2.0	Petrol	85	05/97 → 10/02

626 V Hatchback (GF)

1.8	Petrol	66	05/97 → 12/99
1.8	Petrol	74	12/99 → 10/02
2.0	Petrol	85	05/97 → 10/02

626 V Station Wagon (GW)

2.0 DITD	Diesel	66	09/99 → 10/02
----------	--------	----	---------------

MPV II (LW)

2.0	Petrol	90	09/99 → 08/00
-----	--------	----	---------------

PREMACY (CP)

1.9	Petrol	74	07/99 → 03/05
1.9	Petrol	84	07/99 → 03/05
2.0	Petrol	96	11/01 → 03/05
2.0 TD	Diesel	66	10/99 → 07/00

SAG109
H1 **SENSORE GIRI / FASE - ALBERO MOTORE**
CRANKSHAFT POSITION SENSOR

KW

FORD
B-MAX

1.6 TDCi Diesel 70 10/12 →

FIESTA VI

1.4 TDCi Diesel 51 07/10 →

FOCUS III Turnier

1.6 EcoBoost Petrol 110 05/11 →

LAND ROVER
FREELANDER 2 (FA_)

2.2 eD4 Diesel 110 08/10 →

2.2 SD4 4x4 Diesel 140 08/10 →

2.2 Td4 4x4 Diesel 110 10/06 →

2.2 Td4 4x4 Diesel 112 01/07 →

2.2 Td4 4x4 Diesel 118 10/06 →

SAG110
H1 **SENSORE GIRI / FASE - ALBERO MOTORE**
CRANKSHAFT POSITION SENSOR

KW

FIAT
DUCATO Autobus (250)

120 Multijet 2,3 D Diesel 88 07/06 →

140 Natural Power Petrol/CNG 100 04/09 →

160 Multijet 3,0 D Diesel 116 07/06 →

SAG110

KW

FIAT
DUCATO Furgonato (250)

120 Multijet 2,3 D Diesel 88 07/06 →

160 Multijet 3,0 D Diesel 116 07/06 →

DUCATO Pianale piatto/Telaio (250)

120 Multijet 2,3 D Diesel 88 07/06 →

130 Multijet 2,3 D Diesel 96 01/07 →

160 Multijet 3,0 D Diesel 116 07/06 →

SAG111
H1 **SENSORE GIRI / FASE - ALBERO MOTORE**
CRANKSHAFT POSITION SENSOR

KW

BMW
3 (E36)

320 i Petrol 110 09/94 → 02/98

323 i 2.5 Petrol 125 03/95 → 02/98

328 i Petrol 142 01/95 → 02/98

3 Cabriolet (E36)

320 i Petrol 110 09/94 → 09/98

323 i Petrol 125 06/95 → 09/98

328 i Petrol 142 03/95 → 09/98

3 Compact (E36)

323 ti Petrol 125 08/97 → 09/98

3 Coupé (E36)

320 i Petrol 110 09/94 → 09/98

323 i Petrol 125 03/95 → 09/98

328 i Petrol 142 01/95 → 09/98

3 Touring (E36)

320 i Petrol 110 01/95 → 09/98

323 i Petrol 125 09/95 → 09/98

328 i Petrol 142 01/95 → 09/98

5 (E39)

520 i Petrol 110 01/96 → 09/98

523 i Petrol 125 11/95 → 09/98

528 i Petrol 142 11/95 → 09/98

SAG111



BMW

7 (E38)

728 i,iL Petrol 142 08/95 → 09/98

Z3 Coupé (E36)

2.8 Petrol 141 07/97 → 03/98

SAG112

H1 **SENSORE GIRI / FASE - ALBERO MOTORE**
CRANKSHAFT POSITION SENSOR

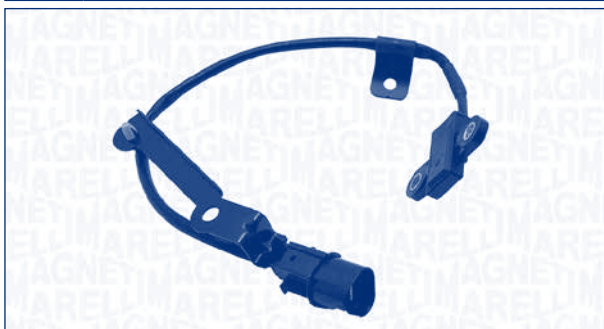

HYUNDAI

GETZ (TB)

1.1 Petrol 46 09/02 → 09/05

KIA

PICANTO (BA)

1.0 Petrol 45 04/04 →

1.0 Petrol 46 11/09 →

1.1 Petrol 48 04/04 →

SAG114

H1 **SENSORE GIRI / FASE - ALBERO MOTORE**
CRANKSHAFT POSITION SENSOR



RENAULT

LAGUNA I (B56_, 556_)

1.9 dTi (B56J) Diesel 72 10/97 → 09/99

SAG114



RENAULT

LAGUNA I Grandtour (K56_)

1.9 dTi (K56J) Diesel 72 10/97 → 09/99

MEGANE I (BA0/1_)

1.9 dTi (BA08, BA0N) Diesel 72 03/97 → 02/99

MEGANE I Classic (LA0/1_)

1.9 dTi (LA08, LA0N) Diesel 72 03/97 → 02/99

MEGANE I Coach (DA0/1_)

1.9 dTi (DA0N) Diesel 72 03/97 → 06/98

MEGANE Scenic (JA0/1_)

1.9 dTi (JA0N) Diesel 72 04/97 → 09/99

SAG115

H1 **SENSORE GIRI / FASE - ALBERO MOTORE**
CRANKSHAFT POSITION SENSOR



BMW

3 (E36)

320 i Petrol 110 09/90 → 02/98 ENGINE: M50B(206S2)VANOS, M52B(206S3)

3 Cabriolet (E36)

320 i Petrol 110 12/93 → 04/99 ENGINE: M50B, M52B

323 i Petrol 125 06/95 → 04/99

328 i Petrol 142 03/95 → 04/99

3 Coupé (E36)

320 i Petrol 110 03/92 → 04/99 ENGINE: M50B, M52B

323 i Petrol 125 03/95 → 04/99

328 i Petrol 142 01/95 → 04/99

3 Touring (E36)

320 i Petrol 110 01/95 → 10/99

323 i Petrol 125 09/95 → 10/99

328 i Petrol 142 01/95 → 10/99

SAG115

BMW
5 (E34)

520 i 24V Petrol 110 09/92 → 09/95

5 Touring (E39)

528 i Petrol 142 01/97 → 09/98

Z3 Coupé (E36)

2.8 Petrol 141 07/97 → 09/98

SAG116
**H1 SENSORE GIRI / FASE - ALBERO MOTORE
CRANKSHAFT POSITION SENSOR**

OPEL
ASTRA G 2 volumi /Coda spiovente (F48_, F08_)

1.8 16V Petrol 85 02/98 → 09/00

ASTRA G Coupé (F07_)

1.8 16V Petrol 85 03/00 → 10/00

ASTRA G Station wagon (F35_)

1.8 16V Petrol 85 02/98 → 09/00

ASTRA G Tre volumi (F69_)

1.8 16V Petrol 85 09/98 → 09/00

VECTRA B (36_)

 1.6 i 16V Petrol 74 11/95 → 04/02 CHASSIS:
W1285447 →,
W7154259 →

1.8 i 16V Petrol 85 09/98 → 09/00

VECTRA B 2 volumi /Coda spiovente (38_)

 1.6 i 16V Petrol 74 11/95 → 07/02 CHASSIS:
W1285447 →,
W7154259 →

1.8 i 16V Petrol 85 09/98 → 09/00

ZAFIRA A (F75_)

1.8 16V Petrol 85 04/99 → 09/00

VAUXHALL
ASTRA Mk IV (G) 2 volumi /Coda spiovente

1.8 16V Petrol 85 02/98 → 09/00

SAG116

VAUXHALL
ASTRA Mk IV (G) Coupé (F67)

1.8 16V Petrol 85 03/00 → 08/05

ASTRA Mk IV (G) Station wagon

1.8 16V Petrol 85 02/98 → 08/00

ASTRA Mk IV (G) Tre volumi

1.8 16V Petrol 85 02/98 → 07/04

VECTRA (B)

 1.6 i 16V Petrol 74 11/95 → 10/01 CHASSIS:
W1285447 →,
W7154259 →

VECTRA (B) 2 volumi /Coda spiovente

 1.6 i 16V Petrol 74 11/95 → 10/01 CHASSIS:
W1285447 →,
W7154259 →

ZAFIRA Mk I (A) (F75)

1.8 16V Petrol 85 05/99 → 08/00

SAG117
**H1 SENSORE GIRI / FASE - ALBERO MOTORE
CRANKSHAFT POSITION SENSOR**

OPEL
ASTRA G 2 volumi /Coda spiovente (F48_, F08_)

1.7 DTI 16V Diesel 55 02/00 → 01/05

ASTRA G Station wagon (F35_)

1.7 DTI 16V Diesel 55 02/00 → 07/04

ASTRA G Tre volumi (F69_)

1.7 DTI 16V Diesel 55 02/00 → 01/05

COMBO Cassone / Furgonato / Promiscuo

1.7 DI 16V Diesel 48 10/01 →

1.7 DTI 16V Diesel 55 10/01 →

COMBO Tour

1.7 DI 16V Diesel 48 10/01 →

1.7 DTI 16V Diesel 55 10/01 →

SAG117



OPEL

CORSA C (F08, F68)

1.7 DI	Diesel	48	09/00 → 12/09
1.7 DTI	Diesel	55	09/00 → 12/09

CORSA C Furgonato (F08, W5L)

1.7 DI 16V	Diesel	48	09/00 →
1.7 DTI 16V	Diesel	55	09/00 →

MERIVA

1.7 DTI	Diesel	55	09/03 → 05/10
---------	--------	----	---------------

VAUXHALL

ASTRA Mk IV (G) 2 volumi /Coda spiovente

1.7 DTI 16V	Diesel	55	02/00 → 05/05
-------------	--------	----	---------------

ASTRA Mk IV (G) Station wagon

1.7 DTI 16V	Diesel	55	02/00 → 05/05
-------------	--------	----	---------------

ASTRA Mk IV (G) Tre volumi

1.7 DTI 16V	Diesel	55	02/00 → 05/05
-------------	--------	----	---------------

COMBO Mk II (C) Cassone / Furgonato / Promiscuo (F25)

1.7 DI 16V	Diesel	48	09/01 → 11/11
1.7 DTI 16V	Diesel	55	10/01 → 11/11

CORSA Mk II (C) (W5L, F08)

1.7 DI 16V	Diesel	48	08/00 → 09/06
1.7 DTI 16V	Diesel	55	08/00 → 09/06

CORSAVAN Mk II (C)

1.7 DI 16V	Diesel	48	09/00 → 06/06
1.7 DTI 16V	Diesel	55	09/00 → 06/06

SAG118

H1 **SENSORE GIRI / FASE - ALBERO MOTORE**
CRANKSHAFT POSITION SENSOR



SEAT

CORDOBA (6K1, 6K2)

2.0 i	Petrol	85	02/93 → 06/99
-------	--------	----	---------------

CORDOBA Vario (6K5)

1.6 i	Petrol	74	09/96 → 06/99
-------	--------	----	---------------

SAG118



SEAT

IBIZA II (6K1)

2.0 i	Petrol	85	03/93 → 08/99
-------	--------	----	---------------

TOLEDO I (1L)

2.0 i	Petrol	85	05/91 → 03/99
2.0 i 16V	Petrol	110	11/93 → 03/99

VOLKSWAGEN

GOLF III (1H1)

2.0 GTI 16V	Petrol	110	08/92 → 08/97
2.0 Syncro (1HX1)	Petrol	85	08/95 → 08/97

GOLF III Variant (1H5)

2.0 Syncro	Petrol	85	08/95 → 04/99
------------	--------	----	---------------

GOLF IV Cabriolet (1E7)

1.6	Petrol	74	06/98 → 06/02
2.0	Petrol	85	06/98 → 06/02

PASSAT (3A2, 35I)

1.6	Petrol	74	07/95 → 08/96
2.0	Petrol	79	07/95 → 08/96
2.0	Petrol	85	07/95 → 08/96
2.0 16V	Petrol	110	07/95 → 08/96

PASSAT Variant (3A5, 35I)

1.6	Petrol	74	07/95 → 12/95
2.0	Petrol	79	07/95 → 08/96
2.0	Petrol	85	07/95 → 05/97
2.0 16V	Petrol	110	07/95 → 05/97

POLO CLASSIC (6KV2)

100 1.6	Petrol	74	12/95 → 09/01
---------	--------	----	---------------

SHARAN (7M8, 7M9, 7M6)

2.0	Petrol	85	09/95 → 03/10
-----	--------	----	---------------

VENTO (1H2)

2.0	Petrol	85	11/91 → 09/98
-----	--------	----	---------------

SAG120
H1 **SENSORE GIRI / FASE - ALBERO MOTORE**
CRANKSHAFT POSITION SENSOR

KW

OPEL
ASTRA G 2 volumi /Coda spiovente (F48_, F08_)

1.8 16V Petrol 92 09/00 → 01/05

ASTRA G Cabriolet (F67)

1.8 16V Petrol 92 03/01 → 10/05

ASTRA G Coupé (F07_)

1.8 16V Petrol 92 09/00 → 05/05

ASTRA G Station wagon (F35_)

1.8 16V Petrol 92 09/00 → 07/04

ASTRA G Tre volumi (F69_)

1.8 16V Petrol 92 06/00 → 01/05

ASTRA H (L48)

1.8 Petrol 92 03/04 →

ASTRA H GTC (L08)

1.8 Petrol 92 03/05 →

ASTRA H Station wagon (L35)

1.8 Petrol 92 08/04 →

ASTRA H TwinTop (L67)

1.8 Petrol 92 09/05 →

CORSA C (F08, F68)

1.8 Petrol 92 09/00 → 12/09

MERIVA

1.8 Petrol 92 05/03 → 05/10

SIGNUM

1.8 Petrol 90 05/03 →

TIGRA TwinTop

1.8 Petrol 92 06/04 →

VECTRA B (36_)

1.8 i 16V Petrol 92 09/00 → 04/02

VECTRA B 2 volumi /Coda spiovente (38_)

1.8 i 16V Petrol 92 09/00 → 07/03

VECTRA B Station wagon (31_)

1.8 i 16V Petrol 92 09/00 → 07/03

SAG120

KW

OPEL
VECTRA C

1.8 Petrol 81 04/02 →

1.8 16V Petrol 90 04/02 →

VECTRA C GTS

1.8 16V Petrol 90 08/02 →

VECTRA C Station wagon

1.8 Petrol 90 10/03 →

ZAFIRA A (F75_)

1.8 16V Petrol 92 09/00 → 06/05

VAUXHALL
ASTRA Mk IV (G) 2 volumi /Coda spiovente

1.8 16V Petrol 92 09/00 → 05/05

ASTRA Mk IV (G) Cabriolet

1.8 16V Petrol 92 03/01 → 10/05

ASTRA Mk IV (G) Coupé (F67)

1.8 16V Petrol 92 09/00 → 08/05

ASTRA Mk IV (G) Station wagon

1.8 16V Petrol 92 09/00 → 05/05

ASTRA Mk IV (G) Tre volumi

1.8 16V Petrol 92 02/98 → 07/04

ASTRA Mk V (H) 2 volumi /Coda spiovente

1.8 Petrol 92 01/04 → 05/09

ASTRA Mk V (H) Sport Hatch

1.8 Petrol 92 02/05 → 11/10

ASTRA Mk V (H) Station wagon

1.8 Petrol 92 10/04 → 03/09

CORSA Mk II (C) (W5L, F08)

1.8 16V Petrol 92 08/00 → 09/06

MERIVA Mk I (A)

1.8 i 16V Petrol 92 05/03 → 08/05

SIGNUM

1.8 Petrol 90 06/03 → 07/05

TIGRA TwinTop

1.8 Petrol 92 06/04 → 08/09

VECTRA (B)

1.8 i 16V Petrol 92 09/00 → 03/02

VECTRA (B) 2 volumi /Coda spiovente

1.8 i 16V Petrol 92 09/00 → 07/03

VECTRA (B) Station wagon

1.8 i 16V Petrol 92 09/00 → 03/02

VECTRA Mk II (C)

1.8 Petrol 81 04/02 → 07/08

1.8 16V Petrol 90 04/02 → 07/08

VECTRA Mk II (C) GTS

1.8 16V Petrol 90 08/02 → 07/08

SAG120



VAUXHALL

VECTRA Mk II (C) Station wagon

1.8 16V Petrol 90 10/03 → 08/05

ZAFIRA Mk I (A) (F75)

1.8 16V Petrol 92 09/00 → 08/05

SAG121

H1 **SENSORE GIRI / FASE - ALBERO MOTORE**
CRANKSHAFT POSITION SENSOR



FIAT

BRAVA (182)

1.4 (182.BG) Petrol 55 10/95 → 10/98

BRAVO I (182)

1.4 (182.AG) Petrol 55 10/95 → 10/98

2.0 HGT 20V (182.AD) Petrol 108 10/95 → 07/98

LANCIA

Y (840A)

1.2 (840AA, 840AF1A) Petrol 44 03/96 → 06/00

1.4 12V (840AC) Petrol 55 03/96 → 06/00

SAG122

H1 **SENSORE GIRI / FASE - ALBERO MOTORE**
CRANKSHAFT POSITION SENSOR



ALFA ROMEO

145 (930)

1.8 i.e. 16V Petrol 106 05/98 → 01/01

2.0 16V Quadrifoglio Petrol 114 05/98 → 01/01

146 (930)

1.8 i.e. 16V T.S. Petrol 106 05/98 → 01/01

2.0 16V Quadrifoglio Petrol 114 05/98 → 01/01

156 (932)

1.8 16V T.SPARK (932A3) Petrol 106 09/97 → 10/00

1.8 16V T.SPARK (932A31_) Petrol 103 10/00 → 09/05 ENGINE: → 3649574

2.0 16V T.SPARK (932A2) Petrol 114 09/97 → 10/00

2.0 16V T.SPARK (932A21_) Petrol 110 10/00 → 03/02 ENGINE: → 3649574

156 Sportwagon (932)

1.8 16V T.SPARK (932A3) Petrol 106 05/00 → 10/00

1.8 16V T.SPARK (932B31_) Petrol 103 10/00 → 05/06 ENGINE: → 3649574

2.0 16V T.SPARK (932A2) Petrol 114 05/00 → 06/02

2.0 16V T.SPARK (932B21_) Petrol 110 10/00 → 03/02 ENGINE: → 3649574

166 (936)

2.0 T.SPARK (936A3A_) Petrol 114 09/98 → 10/00

GTV (916C_)

1.8 16V (916C3) Petrol 106 05/98 → 12/00

2.0 T.SPARK 16V (916C2C) Petrol 114 05/98 → 08/00

SAG122

KW

ALFA ROMEO
SPIDER (916S_)

1.8 16V (916S3) Petrol 106 05/98 → 04/05

2.0 T.SPARK 16V (916S2B) Petrol 114 05/98 → 08/00

FIAT
BRAVO I (182)

2.0 HGT 20V (182AQ) Petrol 113 11/98 → 10/01

COUPE (FA/175)

2.0 20V Petrol 113 04/98 → 08/00

MAREA (185)

2.0 150 20V Petrol 110 01/01 → 05/02

2.0 155 20V Petrol 113 04/99 → 01/01

MAREA Weekend (185)

2.0 150 20V Petrol 110 01/01 → 05/02

2.0 155 20V Petrol 113 04/99 → 02/03

STILO (192)

2.4 20V (192_XD1A) Petrol 125 10/01 → 11/06

LANCIA
KAPPA (838A)

2.4 20V (838AC1AA, 838AC11A) Petrol 129 06/98 → 10/01

KAPPA Coupé (838)

2.0 20V Petrol 114 06/98 → 03/01

LYBRA (839AX)

2.0 20V (839AXC11, 839AXC1A) Petrol 113 07/99 → 09/00

2.0 20V (839AXH1A) Petrol 110 09/00 → 10/05

LYBRA SW (839BX)

2.0 20V (839BXC11, 839BXC1A) Petrol 113 07/99 → 09/00

2.0 20V (839BXH1A) Petrol 110 09/00 → 10/05

THEISIS (841AX)

2.0 Turbo (841AXA1B03) Petrol 136 07/02 → 07/09

2.4 (841AXB1B00) Petrol 125 07/02 → 07/09

SAG123
H1
**SENSORE GIRI / FASE - ALBERO MOTORE
CRANKSHAFT POSITION SENSOR**

KW

TOYOTA
AVENSIS (T25_)

2.0 Petrol 108 04/03 → 11/08

2.4 Petrol 120 10/03 → 11/08

2.4 Petrol 125 09/03 → 11/08

AVENSIS Station wagon (T25)

2.0 Petrol 108 04/03 → 11/08

2.4 Petrol 120 10/03 → 11/08

2.4 Petrol 125 09/03 → 11/08

CAMRY (MCV3_, ACV3_, _XV3_)

2.4 VVT-i Petrol 112 11/01 → 11/06

PICNIC (_XM10)

2.0 Petrol 90 01/01 → 12/01

PREVIA (MCR3_, ACR3_, CLR3_)

2.4 Petrol 115 08/00 → 01/06

RAV 4 II (CLA2_, XA2_, ZCA2_, ACA2_)

2.0 D-4D 4WD Diesel 85 09/01 → 11/05

2.0 VVTi 4WD Petrol 110 06/00 → 11/05

SAG124

H1 **SENSORE GIRI / FASE - ALBERO MOTORE**
CRANKSHAFT POSITION SENSOR



OPEL

ASTRA F (56_, 57_)

1.4 i 16V	Petrol	66	02/96 → 09/98	ENGINE: 02DF5762
1.6 i 16V	Petrol	74	08/94 → 09/98	ENGINE: 02DF5762 →

ASTRA F 2 volumi /Coda spiovente (53_, 54_, 58_, 59_)

1.4 i 16V	Petrol	66	01/96 → 01/98	ENGINE: 02DF5762 →
1.6 i 16V	Petrol	74	08/94 → 01/98	ENGINE: 02DF5762 →

ASTRA F Cabriolet (53_B)

1.4 i 16V	Petrol	66	01/96 → 03/01	ENGINE: 02DF5762 →
-----------	--------	----	---------------	--------------------

ASTRA F CLASSIC 2 volumi /Coda spiovente

1.6 i 16V	Petrol	74	01/98 → 08/02	
-----------	--------	----	---------------	--

ASTRA F CLASSIC Station wagon

1.6 i 16V	Petrol	74	01/98 → 01/05	
-----------	--------	----	---------------	--

ASTRA F CLASSIC Tre volumi

1.6 i 16V	Petrol	74	01/98 → 08/02	
-----------	--------	----	---------------	--

ASTRA F Station wagon (51_, 52_)

1.4 i 16V	Petrol	66	02/96 → 01/98	ENGINE: 02DF5762 →
1.6 i 16V	Petrol	74	08/94 → 01/98	ENGINE: 02DF5762 →

COMBO (71_)

1.4 16V	Petrol	66	08/99 → 10/01	CHASSIS: S3000001 →
---------	--------	----	---------------	---------------------

CORSA B (73_, 78_, 79_)

1.4 i 16V	Petrol	63	08/97 → 09/00	CHASSIS: S3000001 →
1.4 i 16V	Petrol	66	09/94 → 09/00	CHASSIS: S3000001 →
1.6 GSI 16V	Petrol	80	03/93 → 09/00	CHASSIS: S3000001 →
1.6 i 16V	Petrol	74	08/97 → 09/00	CHASSIS: S3000001 →
1.6 i 16V	Petrol	78	09/94 → 09/00	CHASSIS: S3000001 →

TIGRA (95_)

1.4 16V	Petrol	63	08/97 → 12/00	CHASSIS: S3000001 →
1.4 16V	Petrol	66	07/94 → 12/00	CHASSIS: S3000001 →
1.6 16V	Petrol	74	08/97 → 08/98	CHASSIS: S3000001 →
1.6 16V	Petrol	78	07/94 → 08/98	CHASSIS: S3000001 →

VAUXHALL

ASTRA Mk III (F)

1.4 i 16V	Petrol	66	02/96 → 09/98	ENGINE: 02DF5762 →
1.6 i 16V	Petrol	74	08/94 → 09/98	ENGINE: 02DF5762 →

SAG124



VAUXHALL

ASTRA Mk III (F) 2 volumi /Coda spiovente

1.4 i 16V	Petrol	66	02/96 → 02/98	ENGINE: 02DF5762 →
-----------	--------	----	---------------	--------------------

ASTRA Mk III (F) Cabriolet

1.4 i 16V	Petrol	66	01/96 → 03/01	ENGINE: 02DF5762 →
-----------	--------	----	---------------	--------------------

ASTRA Mk III (F) Station wagon

1.4 i 16V	Petrol	66	02/96 → 01/98	ENGINE: 02DF5762 →
1.6 i 16V	Petrol	74	01/94 → 02/98	ENGINE: 02DF5762 →

TIGRA Mk I (F07)

1.4 16V	Petrol	66	07/94 → 12/00	CHASSIS: S3000001 →
1.6 16V	Petrol	78	07/94 → 12/00	CHASSIS: S3000001 →

SAG126

H1 **SENSORE GIRI / FASE - ALBERO MOTORE**
CRANKSHAFT POSITION SENSOR



CITROËN

BERLINGO (MF)

1.6 16V (MFNFU)	Petrol	80	10/00 → 10/02	
-----------------	--------	----	---------------	--

BERLINGO Furgonato (M_)

1.6 16V (MBNFU)	Petrol	80	10/00 → 10/02	
-----------------	--------	----	---------------	--

XSARA PICASSO (N68)

1.6 16V	Petrol	80	09/05 →	
1.6 Chrono	Petrol	74	04/01 → 10/04	

PEUGEOT

307 (3A/C)

1.6 16V	Petrol	80	08/00 →	
---------	--------	----	---------	--

307 Break (3E)

1.6 16V	Petrol	80	03/02 →	
---------	--------	----	---------	--

307 CC (3B)

1.6 16V	Petrol	80	02/05 →	
---------	--------	----	---------	--

307 SW (3H)

1.6 16V	Petrol	80	03/02 →	
---------	--------	----	---------	--

406 (8B)

2.2	Petrol	116	07/00 → 03/02	
-----	--------	-----	---------------	--

SAG126

PEUGEOT
406 Break (8E/F)

2.2 Petrol 116 07/00 → 03/02

607 (9D, 9U)

2.0 Petrol 100 02/00 → 03/02

2.2 16V Petrol 116 02/00 → 03/02

RANCH MPV / Space wagon (5F)

1.6 16V Petrol 80 07/01 → 08/02

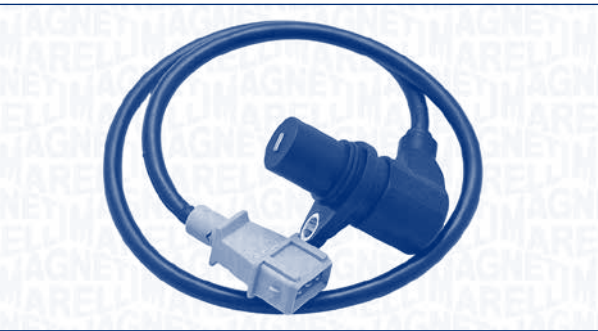
SAG127
**H1 SENSORE GIRI / FASE - ALBERO MOTORE
CRANKSHAFT POSITION SENSOR**

AUDI
80 (8C, B4)

1.6 E Petrol 74 06/93 → 12/94

80 Avant (8C, B4)

1.6 E Petrol 74 06/93 → 01/96

A4 (8D2, B5)

1.6 Petrol 74 11/94 → 10/00

1.8 Petrol 85 04/95 → 11/00

1.8 Petrol 92 01/95 → 11/00

1.8 quattro Petrol 85 07/95 → 11/00

1.8 quattro Petrol 92 01/95 → 11/00

1.8 T Petrol 110 01/95 → 11/00

1.8 T Petrol 132 12/97 → 11/00

1.8 T quattro Petrol 110 01/95 → 11/00

1.8 T quattro Petrol 132 12/97 → 11/00

A4 Avant (8D5, B5)

1.6 Petrol 74 11/94 → 09/01

1.8 Petrol 85 07/95 → 09/01

1.8 Petrol 92 02/96 → 09/01

1.8 quattro Petrol 85 07/95 → 09/01

1.8 quattro Petrol 92 01/96 → 09/01

1.8 T Petrol 132 12/97 → 09/01

1.8 T quattro Petrol 110 01/96 → 09/01

SAG127

AUDI
A4 Avant (8D5, B5)

1.8 T quattro Petrol 132 12/97 → 09/01

A6 (4B2, C5)

1.8 Petrol 85 05/97 → 01/05

1.8 T Petrol 132 12/97 → 01/05

1.8 T quattro Petrol 132 12/97 → 01/05

A6 Avant (4B5, C5)

1.8 Petrol 85 02/98 → 01/05

1.8 T Petrol 132 04/99 → 01/05

1.8 T quattro Petrol 132 12/97 → 01/05

VOLKSWAGEN
PASSAT (3B2)

1.8 Petrol 85 01/97 → 11/00

1.8 Syncro/4motion Petrol 92 10/96 → 11/00

PASSAT Variant (3B5)

1.8 Petrol 85 06/97 → 11/00

1.8 Syncro/4motion Petrol 92 06/97 → 11/00

SAG128
**H1 SENSORE GIRI / FASE - ALBERO MOTORE
CRANKSHAFT POSITION SENSOR**

RENAULT
19 I (B/C53_)

1.7 (B/C53C) Petrol 66 09/88 → 04/92

19 I Cabriolet (D53_)

1.7 Petrol 70 07/91 → 04/92

19 I Chamade (L53_)

1.7 (L53C) Petrol 66 07/88 → 04/92

19 II (B/C53_)

1.7 (B/C53C) Petrol 66 04/92 → 12/95

1.8 (5/353A) Petrol 66 04/92 → 12/95

SAG128



RENAULT

19 II (B/C53_)

1.8 (5/353F, B/C538)	Petrol	79	05/94 → 12/95
1.8 (B/C538)	Petrol	81	04/92 → 05/94
1.8 (B/C53Y)	Petrol	65	04/92 → 12/95
1.8 16V (B/C53D)	Petrol	99	04/92 → 12/95

19 II Cabriolet (D53_, 853_)

1.8 (D53V, 853F, D53C)	Petrol	79	07/94 → 06/96
1.8 (D53Y)	Petrol	65	04/92 → 06/96
1.8 16V (D53D)	Petrol	99	04/92 → 06/96

19 II Chamade (L53_)

1.8 (453A/F)	Petrol	66	04/92 → 12/95
1.8 (L538)	Petrol	81	04/92 → 05/94
1.8 (L53V, L538)	Petrol	79	05/94 → 12/95
1.8 (L53Y)	Petrol	65	04/92 → 12/95
1.8 16V (L53D)	Petrol	99	04/92 → 12/95

21 Station wagon (K48_)

1.7 (K48E)	Petrol	69	01/89 → 12/89
1.7 (K48F) Cat.	Petrol	54	01/89 → 06/93

21 Tre volumi (L48_)

1.7 (L48E)	Petrol	69	01/89 → 02/94
1.7 (L48M, L48F)	Petrol	54	01/89 → 02/94

CLIO I (B/C57_, 5/357_)

1.4 (B/C57T, B/C57Y)	Petrol	58	01/91 → 09/98
1.8 (B/C578)	Petrol	66	08/94 → 09/98
1.8 Rsi (B/C579)	Petrol	80	01/93 → 08/95

LAGUNA I (B56_, 556_)

2.0 (B56C/H/N)	Petrol	83	11/93 → 03/01
----------------	--------	----	---------------

MEGANE I (BA0/1_)

1.6 e (BA0F, BA0S)	Petrol	66	01/96 → 08/97
--------------------	--------	----	---------------

MEGANE I Coach (DA0/1_)

1.6 e (DA0F)	Petrol	66	03/96 → 08/97
--------------	--------	----	---------------

SAG129

H1 **SENSORE GIRI / FASE - ALBERO MOTORE**
CRANKSHAFT POSITION SENSOR



RENAULT

CLIO II (BB0/1/2_, CB0/1/2_)

1.4 (B/CB0C)	Petrol	55	09/98 → 05/05
1.6 (B/CB0D)	Petrol	66	09/98 → 12/00

MEGANE I (BA0/1_)

1.6 e (BA0F, BA0S)	Petrol	66	09/97 → 06/98
--------------------	--------	----	---------------

MEGANE I Coach (DA0/1_)

1.6 e (DA0F)	Petrol	66	09/97 → 06/98
--------------	--------	----	---------------

SAG130

H1 **SENSORE GIRI / FASE - ALBERO MOTORE**
CRANKSHAFT POSITION SENSOR

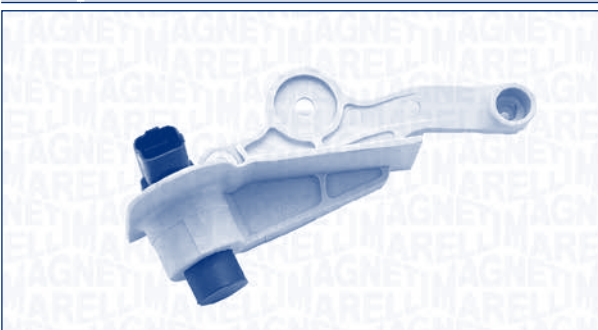

CITROËN

C3 I (FC_)

1.6 16V	Petrol	80	09/05 →
---------	--------	----	---------

C4 Coupé (LA_)

1.6 16V	Petrol	80	11/04 →
---------	--------	----	---------

C4 I (LC_)

1.6 16V	Petrol	80	11/04 →
---------	--------	----	---------

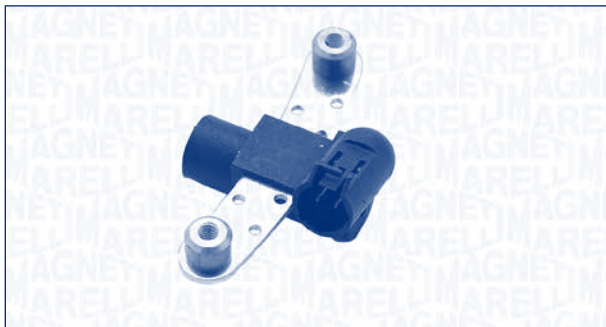
SAG131
H1 **SENSORE GIRI / FASE - ALBERO MOTORE**
CRANKSHAFT POSITION SENSOR

RENAULT
LAGUNA I (B56_, 556_)

1.9 dTi (B56J) Diesel 72 10/97 → 03/01

LAGUNA I Grandtour (K56_)

1.9 dTi (K56J) Diesel 72 10/97 → 03/01

MEGANE I (BA0/1_)

1.9 dCi (BA05, BA1F) Diesel 75 02/01 → 08/03

1.9 dTi (BA08, BA0N) Diesel 72 03/97 → 02/01

MEGANE I Classic (LA0/1_)

1.9 dCi (LA05, LA1F) Diesel 75 02/01 → 08/03

1.9 dTi (LA08, LA0N) Diesel 72 03/97 → 02/01

MEGANE I Coach (DA0/1_)

1.9 dCi (DA05, DA1F) Diesel 75 02/01 → 08/03

1.9 dTi (DA0N) Diesel 72 03/97 → 02/01

MEGANE I Grandtour (KA0/1_)

1.9 dCi (KA05, KA1F) Diesel 75 02/01 → 08/03

1.9 dTi (KA0N) Diesel 72 03/99 → 02/01

SCÉNIC I (JA0/1_)

1.9 dCi (JA05, JA1F) Diesel 75 09/99 → 08/03

1.9 dTi (JA0N) Diesel 72 09/99 → 08/03

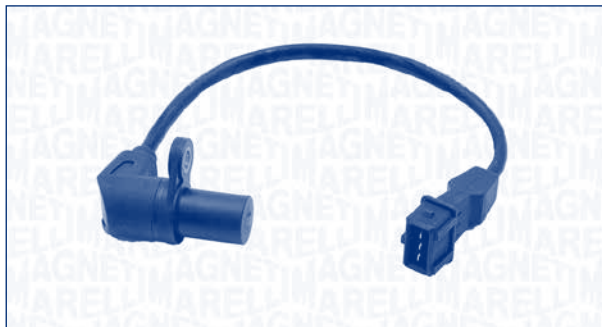
SAG132
H1 **SENSORE GIRI / FASE - ALBERO MOTORE**
CRANKSHAFT POSITION SENSOR

SEAT
CORDOBA (6L2)

1.4 16V Petrol 55 09/02 → 12/07

IBIZA IV (6L1)

1.4 16V Petrol 55 02/02 → 12/07

SKODA
FABIA (6Y2)

1.4 16V Petrol 55 12/99 → 03/08

FABIA Combi (6Y5)

1.4 16V Petrol 55 05/00 → 12/07

FABIA Tre volumi (6Y3)

1.4 16V Petrol 55 10/99 → 12/07

ROOMSTER (5J)

1.6 Petrol 77 09/06 →

VOLKSWAGEN
POLO (9N_)

1.4 16V Petrol 55 10/01 → 05/08

1.6 16V Petrol 77 05/06 → 11/09

POLO Tre volumi (9A4)

1.4 Petrol 55 07/03 →

SAG133

H1 **SENSORE GIRI / FASE - ALBERO MOTORE**
CRANKSHAFT POSITION SENSOR

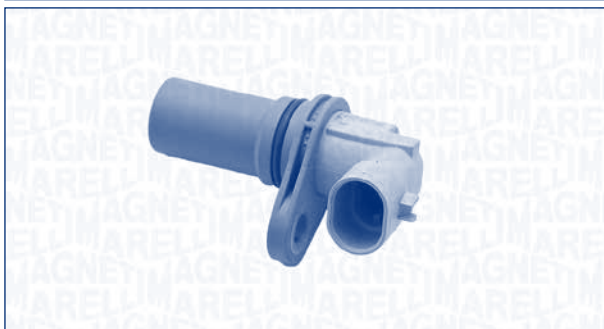

ALFA ROMEO

147 (937)

1.9 JTD 16V	Diesel	100	10/04 → 03/10
1.9 JTD 16V	Diesel	103	11/02 → 03/10
1.9 JTD 16V	Diesel	93	09/03 → 09/04
1.9 JTDM 16V	Diesel	110	09/04 → 03/10

156 (932)

1.9 JTD	Diesel	100	11/02 → 11/04
1.9 JTD	Diesel	93	11/03 → 09/05
1.9 JTD	Diesel	110	07/04 → 09/05
1.9 JTD 16V	Diesel	103	11/02 → 09/05
2.4 JTD	Diesel	120	06/03 → 09/05
2.4 JTD	Diesel	129	10/03 → 09/05

156 Sportwagon (932)

1.9 JTD	Diesel	100	11/02 → 11/04
1.9 JTD	Diesel	93	11/03 → 05/06
1.9 JTD	Diesel	110	03/05 → 05/06
1.9 JTD 16V	Diesel	103	11/02 → 05/06
1.9 JTD 16V Q4	Diesel	110	07/04 → 05/06
2.4 JTD	Diesel	120	06/03 → 05/06
2.4 JTD	Diesel	129	10/03 → 05/06

159 (939)

1.9 JTDM 16V	Diesel	110	09/05 → 11/11
1.9 JTDM 16V	Diesel	100	09/05 → 11/11
2.4 JTDM	Diesel	147	09/05 → 11/11

159 Sportwagon (939)

1.9 JTDM 16V	Diesel	100	03/06 → 11/11
1.9 JTDM 16V	Diesel	110	03/06 → 11/11
2.4 JTDM	Diesel	147	03/06 → 11/11

166 (936)

2.4 JTD	Diesel	129	10/03 → 06/07
2.4 JTD	Diesel	132	07/06 → 06/07
2.4 JTD	Diesel	136	07/05 → 06/07

BRERA

2.4 JTDM 20V	Diesel	147	01/06 →
--------------	--------	-----	---------

SAG133



ALFA ROMEO

GT (937)

1.9 JTD	Diesel	110	11/03 → 09/10
---------	--------	-----	---------------

SPIDER (939)

2.4 JTDM	Diesel	147	04/07 →
----------	--------	-----	---------

FIAT

BRAVO II (198)

1.9 D Multijet	Diesel	110	04/07 →
----------------	--------	-----	---------

CROMA (194)

1.9 D Multijet	Diesel	110	06/05 →
2.4 D Multijet	Diesel	147	06/05 →

STILO (192)

1.9 D Multijet	Diesel	110	09/05 → 11/06
1.9 JTD	Diesel	100	04/04 → 11/06
1.9 JTD	Diesel	93	09/03 → 11/06
1.9 JTD	Diesel	103	01/04 → 11/06

STILO Multi Wagon (192)

1.9 D Multijet	Diesel	110	09/05 → 08/08
1.9 JTD	Diesel	100	04/04 → 08/08
1.9 JTD	Diesel	103	01/04 → 08/08
1.9 JTD	Diesel	93	09/03 → 08/08

LANCIA

THESIS (841AX)

2.4 JTD	Diesel	129	05/03 → 07/09
---------	--------	-----	---------------

OPEL

ASTRA H (L48)

1.9 CDTI	Diesel	110	09/04 →
1.9 CDTI 16V	Diesel	88	04/04 →

ASTRA H GTC (L08)

1.9 CDTI	Diesel	110	03/05 →
1.9 CDTI 16V	Diesel	88	03/05 →

ASTRA H Station wagon (L35)

1.9 CDTI	Diesel	110	09/04 →
1.9 CDTI 16V	Diesel	88	08/04 →

ASTRA H TwinTop (L67)

1.9 CDTI	Diesel	110	09/05 →
----------	--------	-----	---------

SIGNUM

1.9 CDTI	Diesel	110	04/04 →
----------	--------	-----	---------

VECTRA C

1.9 CDTI	Diesel	110	04/04 →
----------	--------	-----	---------

VECTRA C GTS

1.9 CDTI	Diesel	110	04/04 →
----------	--------	-----	---------

VECTRA C Station wagon

1.9 CDTI	Diesel	110	04/04 →
----------	--------	-----	---------

ZAFIRA B (A05)

1.9 CDTI	Diesel	110	07/05 →
----------	--------	-----	---------

SAG133

SAAB
9-3 (YS3F)

1.9 TiD Diesel 110 09/04 →

9-3 Cabriolet (YS3F)

1.9 TiD Diesel 110 01/06 →

9-3 Station wagon

1.9 TiD Diesel 110 03/05 →

9-5 (YS3E)

1.9 TiD Diesel 110 01/06 →

9-5 Station wagon (YS3E)

1.9 TiD Diesel 110 01/06 →

VAUXHALL
ASTRA Mk V (H) 2 volumi /Coda spiovente

1.9 CDTI Diesel 110 01/04 → 05/09

1.9 CDTI 16V Diesel 88 01/04 → 05/09

ASTRA Mk V (H) Sport Hatch

1.9 CDTI Diesel 110 02/05 → 11/10

1.9 CDTI Diesel 88 02/05 → 11/10

ASTRA Mk V (H) Station wagon

1.9 CDTI Diesel 110 08/04 → 03/09

1.9 CDTI Diesel 88 08/04 → 03/09

SIGNUM

1.9 CDTI 16V Diesel 110 04/04 → 03/08

VECTRA Mk II (C)

1.9 CDTI 16V Diesel 110 04/04 → 08/08

VECTRA Mk II (C) GTS

1.9 CDTI 16V Diesel 110 04/04 → 07/08

VECTRA Mk II (C) Station wagon

1.9 CDTI 16V Diesel 110 04/04 → 07/08

ZAFIRA Mk II (B) (M75)

1.9 CDTI Diesel 110 07/05 →

SAG134
**H1 SENSORE GIRI / FASE - ALBERO MOTORE
CRANKSHAFT POSITION SENSOR**

AUDI
A2 (8Z0)

1.2 TDI Diesel 45 03/01 → 08/05

1.4 TDI Diesel 55 02/00 → 08/05

1.4 TDI Diesel 66 11/03 → 08/05

SEAT
AROSA (6H)

1.4 TDI Diesel 55 01/00 → 06/04

CORDOBA (6L2)

1.4 TDI Diesel 51 05/05 → 11/09

1.4 TDI Diesel 55 10/02 → 12/05

1.4 TDI Diesel 59 06/05 → 11/09

IBIZA IV (6L1)

1.4 TDI Diesel 51 05/05 → 11/09

1.4 TDI Diesel 55 05/02 → 12/05

1.4 TDI Diesel 59 06/05 → 11/09

SKODA
FABIA (6Y2)

1.4 TDI Diesel 55 04/03 → 03/08

1.4 TDI Diesel 59 10/05 → 03/08

1.4 TDI Diesel 51 10/05 → 03/08

FABIA Combi (6Y5)

1.4 TDI Diesel 55 04/03 → 12/07

1.4 TDI Diesel 59 10/05 → 12/07

1.4 TDI Diesel 51 10/05 → 12/07

FABIA Praktik

1.4 TDI Diesel 51 10/05 → 12/07

FABIA Tre volumi (6Y3)

1.4 TDI Diesel 55 04/03 → 12/07

1.4 TDI Diesel 59 10/05 → 12/07

1.4 TDI Diesel 51 10/05 → 12/07

ROOMSTER (5J)

1.4 TDI Diesel 51 07/06 → 03/10

1.4 TDI Diesel 59 09/06 → 03/10

SAG134



VOLKSWAGEN

FOX (5Z1, 5Z3)

1.4 TDI	Diesel	51	04/05 →
---------	--------	----	---------

LUPO (6X1, 6E1)

1.2 TDI 3L	Diesel	45	07/99 → 07/05
------------	--------	----	---------------

1.4 TDI	Diesel	55	01/99 → 07/05
---------	--------	----	---------------

POLO (6N2)

1.4 TDI	Diesel	55	10/99 → 09/01
---------	--------	----	---------------

POLO (9N_)

1.4 TDI	Diesel	51	04/05 → 11/09
---------	--------	----	---------------

1.4 TDI	Diesel	59	04/05 → 11/09
---------	--------	----	---------------

1.4 TDI	Diesel	55	10/01 → 06/05
---------	--------	----	---------------

POLO Tre volumi (9A4)

1.4 TDI	Diesel	55	07/03 →
---------	--------	----	---------

SAG135

H1 **SENSORE GIRI / FASE - ALBERO MOTORE**
CRANKSHAFT POSITION SENSOR



HYUNDAI

ACCENT I (X-3)

1.3	Petrol	44	10/94 → 05/96
-----	--------	----	---------------

1.3	Petrol	55	10/94 → 05/96
-----	--------	----	---------------

1.3 i 12V	Petrol	62	10/94 → 05/96
-----------	--------	----	---------------

1.5 i 12V	Petrol	65	10/94 → 05/96
-----------	--------	----	---------------

1.5 i 16V	Petrol	73	12/95 → 05/96
-----------	--------	----	---------------

ACCENT II (LC)

1.3	Petrol	55	01/00 → 11/05
-----	--------	----	---------------

1.3	Petrol	61	01/00 → 11/05
-----	--------	----	---------------

1.3	Petrol	63	01/00 → 11/05
-----	--------	----	---------------

1.5	Petrol	66	01/00 → 11/05
-----	--------	----	---------------

1.5	Petrol	75	09/00 → 11/05
-----	--------	----	---------------

1.6	Petrol	77	12/02 → 11/05
-----	--------	----	---------------

ACCENT Tre volumi (LC)

1.3	Petrol	55	01/00 → 11/05
-----	--------	----	---------------

1.3	Petrol	63	01/00 → 11/05
-----	--------	----	---------------

SAG134



HYUNDAI

ACCENT Tre volumi (LC)

1.5	Petrol	66	01/00 → 11/05
-----	--------	----	---------------

1.6	Petrol	77	12/02 → 11/05
-----	--------	----	---------------

ACCENT Tre volumi (X-3)

1.3	Petrol	44	10/94 → 05/96
-----	--------	----	---------------

1.3	Petrol	55	10/94 → 05/96
-----	--------	----	---------------

1.3 i 12V	Petrol	62	10/94 → 05/96
-----------	--------	----	---------------

1.5 i 12V	Petrol	65	10/94 → 05/96
-----------	--------	----	---------------

1.5 i 16V	Petrol	73	10/95 → 05/96
-----------	--------	----	---------------

COUPE (GK)

1.6 16V	Petrol	77	03/02 → 08/09
---------	--------	----	---------------

1.6 16V	Petrol	79	03/02 → 08/09
---------	--------	----	---------------

ELANTRA (XD)

1.6	Petrol	77	05/03 → 07/06
-----	--------	----	---------------

1.6	Petrol	79	06/00 → 07/06
-----	--------	----	---------------

ELANTRA Tre volumi (XD)

1.6	Petrol	77	05/03 → 07/06
-----	--------	----	---------------

1.6	Petrol	79	06/00 → 07/06
-----	--------	----	---------------

GETZ (TB)

1.3 i	Petrol	60	09/02 → 03/04
-------	--------	----	---------------

1.4 i	Petrol	71	08/05 → 06/09
-------	--------	----	---------------

1.6	Petrol	77	09/02 → 09/05
-----	--------	----	---------------

SAG136

H1 **SENSORE GIRI / FASE - ALBERO MOTORE**
CRANKSHAFT POSITION SENSOR



TOYOTA

PRIUS 2 volumi /Coda spiovente (NHW20_)

1.5	Petrol	57	08/03 → 03/09
-----	--------	----	---------------

PRIUS Tre volumi (NHW11_)

1.5	Petrol	53	05/00 → 01/04
-----	--------	----	---------------

SAG136

KW

TOYOTA
YARIS (SCP1_, NLP1_, NCP1_)

1.3 16V	Petrol	63	11/99 → 09/05
1.5 TS	Petrol	77	01/03 → 09/05
1.5 VVT-i TS	Petrol	78	04/01 → 09/05

YARIS VERSO (_NLP2_, _NCP2_)

1.3 (NCP22)	Petrol	62	08/99 → 09/05
1.3 (NCP22)	Petrol	63	08/99 → 09/05
1.5 (NCP21)	Petrol	77	05/03 → 09/05
1.5 (NCP21)	Petrol	78	03/00 → 09/05

SAG137
H1 **SENSORE GIRI / FASE - ALBERO MOTORE
CRANKSHAFT POSITION SENSOR**

KW

OPEL
ASTRA G 2 volumi /Coda spiovente (F48_, F08_)

1.6	Petrol	55	02/98 → 09/00
-----	--------	----	---------------

ASTRA G Furgonato (F70)

1.6	Petrol	55	01/99 → 09/00
-----	--------	----	---------------

ASTRA G Station wagon (F35_)

1.6	Petrol	55	02/98 → 09/00
-----	--------	----	---------------

ASTRA G Tre volumi (F69_)

1.6	Petrol	55	09/98 → 09/00
-----	--------	----	---------------

VAUXHALL
ASTRA Mk IV (G) 2 volumi /Coda spiovente

1.6	Petrol	55	02/98 → 09/00
-----	--------	----	---------------

ASTRA Mk IV (G) Station wagon

1.6	Petrol	55	03/98 → 04/04
-----	--------	----	---------------

ASTRA Mk IV (G) Tre volumi

1.6	Petrol	55	09/98 → 09/00
-----	--------	----	---------------

ASTRAVAN Mk IV (G)

1.6 i	Petrol	55	08/98 → 09/00
-------	--------	----	---------------

SAG138
H1 **SENSORE GIRI / FASE - ALBERO MOTORE
CRANKSHAFT POSITION SENSOR**

KW

SEAT
CORDOBA (6K2)

1.9 SDI	Diesel	50	06/99 → 10/99
1.9 TDI	Diesel	66	06/99 → 10/99
1.9 TDI	Diesel	81	06/99 → 10/99

CORDOBA Vario (6K5)

1.9 SDI	Diesel	50	06/99 → 10/99
1.9 TDI	Diesel	66	06/99 → 10/99
1.9 TDI	Diesel	81	06/99 → 10/99

IBIZA III (6K1)

1.9 SDI	Diesel	50	08/99 → 10/99
1.9 TDI	Diesel	66	08/99 → 10/99
1.9 TDI	Diesel	81	08/99 → 10/99

INCA (6K9)

1.9 TDI	Diesel	66	09/96 → 10/99
---------	--------	----	---------------

SKODA
OCTAVIA (1U2)

1.9 SDI	Diesel	50	06/97 → 05/99	CHASSIS: → 1UxxYxx284729
1.9 TDI	Diesel	81	08/97 → 05/99	CHASSIS: → 1UxxYxx284729

OCTAVIA Combi (1U5)

1.9 SDI	Diesel	50	07/98 → 05/99	CHASSIS: → 1UxxYxx284729
1.9 TDI	Diesel	66	07/98 → 05/99	CHASSIS: → 1UxxYxx284729
1.9 TDI	Diesel	81	07/98 → 05/99	CHASSIS: → 1UxxYxx284729

VOLKSWAGEN
GOLF IV (1J1)

1.9 SDI	Diesel	50	08/97 → 04/99
1.9 TDI	Diesel	66	10/97 → 04/99
1.9 TDI	Diesel	81	08/97 → 04/99
1.9 TDI 4motion	Diesel	66	07/98 → 04/99

SAG138



VOLKSWAGEN

NEW BEETLE (9C1, 1C1)

1.9 TDI	Diesel	66	01/98 → 05/99
---------	--------	----	---------------

POLO CLASSIC (6KV2)

110 1.9 TDI	Diesel	81	06/98 → 10/99
-------------	--------	----	---------------

68 1.9 SDI	Diesel	50	08/99 → 10/99
------------	--------	----	---------------

POLO Variant (6KV5)

1.9 SDI	Diesel	50	08/99 → 10/99
---------	--------	----	---------------

1.9 TDI	Diesel	66	05/97 → 10/99
---------	--------	----	---------------

1.9 TDI	Diesel	81	06/98 → 10/99
---------	--------	----	---------------

SAG140

H1

**SENSORE GIRI / FASE - ALBERO MOTORE
CRANKSHAFT POSITION SENSOR**

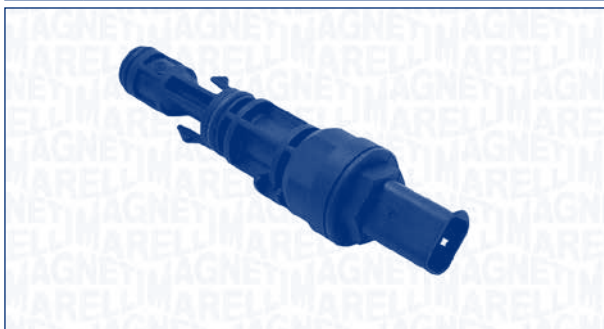

RENAULT

CLIO II (BB0/1/2_, CB0/1/2_)

2.0 16V Sport (CB0M)	Petrol	124	02/00 →
----------------------	--------	-----	---------

ESPACE III (JE0_)

1.9 dTi (JE0M)	Diesel	72	02/99 → 10/02
----------------	--------	----	---------------

2.0	Petrol	102	09/01 → 10/02
-----	--------	-----	---------------

2.0 16V (JE0N, JE0L, JE02)	Petrol	103	10/98 → 10/02
----------------------------	--------	-----	---------------

2.2 dCi (JE0K)	Diesel	95	10/00 → 10/02
----------------	--------	----	---------------

2.2 dCi (JE0S)	Diesel	85	07/00 → 10/02
----------------	--------	----	---------------

LAGUNA I (B56_, 556_)

1.8 16V (B563, B564)	Petrol	88	04/98 → 03/01
----------------------	--------	----	---------------

2.0	Petrol	84	06/95 → 02/01
-----	--------	----	---------------

2.0 16V (556A/B)	Petrol	103	09/99 → 03/01
------------------	--------	-----	---------------

2.0 16V (B56D/M)	Petrol	102	06/95 → 03/01
------------------	--------	-----	---------------

2.2 D (B56F/2)	Diesel	61	11/93 → 03/01
----------------	--------	----	---------------

SAG140



RENAULT

LAGUNA I Grandtour (K56_)

1.8 16V (K563, K564)	Petrol	88	04/98 → 03/01
----------------------	--------	----	---------------

1.9 dCi (K56W)	Diesel	79	09/99 → 03/01
----------------	--------	----	---------------

2.0	Petrol	84	10/98 → 01/01
-----	--------	----	---------------

2.0 16V (A56A/B)	Petrol	103	09/99 → 03/01
------------------	--------	-----	---------------

2.0 16V (K56D/M)	Petrol	102	09/95 → 03/01
------------------	--------	-----	---------------

2.2 D (K56F/2, S56F)	Diesel	61	09/95 → 03/01
----------------------	--------	----	---------------

MEGANE I (BA0/1_)

1.9 dT (B/SA0K, B/SA0Y)	Diesel	66	01/96 → 08/03
-------------------------	--------	----	---------------

1.9 dTi (BA1U)	Diesel	59	02/01 → 08/03
----------------	--------	----	---------------

MEGANE I Cabriolet (EA0/1_)

1.6 16V (EA0B, EA04, EA11)	Petrol	79	03/99 → 08/03
----------------------------	--------	----	---------------

2.0 16V	Petrol	102	01/02 → 08/03
---------	--------	-----	---------------

2.0 16V IDE (EA03, EA0P, EA14)	Petrol	103	11/99 → 08/03
--------------------------------	--------	-----	---------------

MEGANE I Coach (DA0/1_)

2.0 16V	Petrol	102	01/02 → 08/03
---------	--------	-----	---------------

2.0 16V (DA0H)	Petrol	108	03/96 → 11/99
----------------	--------	-----	---------------

2.0 16V IDE (DA03, DA0P, DA14)	Petrol	103	11/99 → 08/03
--------------------------------	--------	-----	---------------

2.0 i	Petrol	80	03/99 → 08/03
-------	--------	----	---------------

MEGANE Scenic (JA0/1_)

2.0 i (JA0G)	Petrol	80	01/99 → 09/99
--------------	--------	----	---------------

SCÉNIC I (JA0/1_)

1.8 16V (JA12, JA1R, JA1M, JA1A)	Petrol	85	01/01 → 08/03
----------------------------------	--------	----	---------------

1.8 4x4	Petrol	85	07/00 → 04/01
---------	--------	----	---------------

2.0 16V	Petrol	103	09/99 → 08/03
---------	--------	-----	---------------

2.0 16V (JA1B, JA1D)	Petrol	102	07/00 → 08/03
----------------------	--------	-----	---------------

SAG141
H1 **SENSORE GIRI / FASE - ALBERO MOTORE**
CRANKSHAFT POSITION SENSOR

OPEL
ASTRA F (56_, 57_)

1.4	Petrol	60	09/92 → 09/98
1.4 Si	Petrol	60	03/92 → 09/98
1.6	Petrol	55	09/95 → 09/98
1.6 i	Petrol	52	05/93 → 07/96
1.6 Si	Petrol	74	05/92 → 12/94

ASTRA F 2 volumi /Coda spiovente (53_, 54_, 58_, 59_)

1.4	Petrol	60	09/92 → 01/98
1.4 Si	Petrol	60	03/92 → 01/98
1.6	Petrol	55	09/95 → 01/98
1.6 i	Petrol	52	05/93 → 07/96
1.6 i	Petrol	55	09/91 → 01/98
1.6 Si	Petrol	74	03/92 → 12/94

ASTRA F Cabriolet (53_B)

1.4 Si	Petrol	60	05/93 → 03/01
1.6 i	Petrol	52	03/93 → 08/96
1.6 i	Petrol	55	01/96 → 03/01

ASTRA F CLASSIC 2 volumi /Coda spiovente

1.6 i	Petrol	55	01/98 → 08/02
-------	--------	----	---------------

ASTRA F CLASSIC Station wagon

1.6 i	Petrol	55	01/98 → 01/05
-------	--------	----	---------------

ASTRA F CLASSIC Tre volumi

1.6 i	Petrol	55	01/98 → 08/02
-------	--------	----	---------------

ASTRA F Station wagon (51_, 52_)

1.4	Petrol	60	09/92 → 01/98
1.4 Si	Petrol	60	03/92 → 01/98
1.6	Petrol	55	09/95 → 01/98
1.6 i	Petrol	52	05/93 → 07/96
1.6 i	Petrol	55	09/91 → 01/98
1.6 Si	Petrol	74	03/92 → 12/94

ASTRA F Van (55_)

1.6 i	Petrol	52	02/93 → 07/96
-------	--------	----	---------------

SAG141

OPEL
COMBO (71_)

1.2	Petrol	33	07/94 → 10/01
1.4	Petrol	44	07/94 → 10/01
1.4	Petrol	60	07/94 → 10/01

CORSA A 2 volumi /Coda spiovente (93_, 94_, 98_, 99_)

1.4 Si	Petrol	60	09/91 → 03/93
--------	--------	----	---------------

CORSA B (73_, 78_, 79_)

1.2 i	Petrol	33	03/93 → 09/00
1.4 i	Petrol	44	03/93 → 09/00
1.4 Si	Petrol	60	03/93 → 09/00

CORSA B Furgonato (73_)

1.4 i	Petrol	44	08/99 → 09/00
-------	--------	----	---------------

VECTRA A (86_, 87_)

1.6 i	Petrol	52	09/93 → 11/95
-------	--------	----	---------------

VECTRA B (36_)

1.6 i	Petrol	55	10/95 → 04/02
-------	--------	----	---------------

VECTRA B 2 volumi /Coda spiovente (38_)

1.6 i	Petrol	55	10/95 → 07/03
-------	--------	----	---------------

VAUXHALL
ASTRA Mk III (F)

1.4 i	Petrol	60	04/92 → 09/98
1.6 i	Petrol	52	08/94 → 07/96
1.6 i	Petrol	55	03/92 → 09/98
1.6 i	Petrol	74	05/92 → 12/94

ASTRA Mk III (F) 2 volumi /Coda spiovente

1.4 i	Petrol	60	03/92 → 02/98
1.6 i	Petrol	52	07/94 → 02/98
1.6 i	Petrol	74	03/92 → 02/98

ASTRA Mk III (F) Cabriolet

1.4 i	Petrol	60	05/93 → 03/01
1.6 i	Petrol	52	03/93 → 08/96
1.6 i	Petrol	55	01/96 → 03/01

ASTRA Mk III (F) Station wagon

1.4 i	Petrol	60	03/91 → 02/98
1.6 i	Petrol	52	07/94 → 02/98
1.6 Si	Petrol	74	03/91 → 12/94

ASTRAVAN Mk III (F)

1.6 i	Petrol	52	02/94 → 10/96
-------	--------	----	---------------

CAVALIER Mk III (87)

1.6 i	Petrol	52	09/93 → 11/95
-------	--------	----	---------------

CAVALIER Mk III 2 volumi /Coda spiovente

1.6 i	Petrol	52	09/93 → 11/95
-------	--------	----	---------------

SAG141



VAUXHALL

COMBO Mk I (B)

1.2	Petrol	33	07/94 → 10/01
1.4	Petrol	44	07/94 → 10/01
1.4	Petrol	60	07/94 → 10/01

VECTRA (B)

1.6 i	Petrol	55	08/95 → 10/01
-------	--------	----	---------------

VECTRA (B) 2 volumi /Coda spiovente

1.6 i	Petrol	55	08/95 → 10/01
-------	--------	----	---------------

VECTRA (B) Station wagon

1.6 i	Petrol	55	11/96 → 03/02
-------	--------	----	---------------

SAG142

H1 **SENSORE GIRI / FASE - ALBERO MOTORE**
CRANKSHAFT POSITION SENSOR



AUDI

A4 (8D2, B5)

1.9 TDI	Diesel	55	12/95 → 11/00
1.9 TDI	Diesel	66	01/95 → 11/00
1.9 TDI	Diesel	81	10/95 → 11/00

A4 Avant (8D5, B5)

1.9 TDI	Diesel	55	03/96 → 09/01
1.9 TDI	Diesel	66	02/96 → 09/01
1.9 TDI	Diesel	81	02/96 → 09/01

A6 (4A, C4)

1.9 TDI	Diesel	66	06/94 → 10/97
---------	--------	----	---------------

A6 (4B2, C5)

1.9 TDI	Diesel	81	04/97 → 10/00
---------	--------	----	---------------

A6 Avant (4A, C4)

1.9 TDI	Diesel	66	06/94 → 12/97
---------	--------	----	---------------

A6 Avant (4B5, C5)

1.9 TDI	Diesel	81	02/98 → 04/01
---------	--------	----	---------------

FORD

GALAXY (WGR)

1.9 TDI	Diesel	81	08/97 → 04/00
---------	--------	----	---------------

SAG142



SEAT

AROSA (6H)

1.7 SDI	Diesel	44	08/97 → 10/03
---------	--------	----	---------------

CORDOBA Vario (6K5)

1.9 SDI	Diesel	47	09/96 → 06/99
1.9 TDI	Diesel	66	08/96 → 06/99

IBIZA II (6K1)

1.9 SDI	Diesel	47	08/96 → 08/99
---------	--------	----	---------------

TOLEDO I (1L)

1.9 TDI	Diesel	66	08/95 → 03/99
---------	--------	----	---------------

VOLKSWAGEN

CADDY II Furgonato (9K9A)

1.9 SDI	Diesel	47	11/95 → 01/04
---------	--------	----	---------------

CADDY II Station wagon (9K9B)

1.9 SDI	Diesel	47	11/95 → 01/04
1.9 TDI	Diesel	66	10/96 → 01/04

GOLF III (1H1)

1.9 SDI	Diesel	47	07/95 → 08/97
1.9 TDI	Diesel	66	09/93 → 08/97
1.9 TDI Syncro (1HX1)	Diesel	66	08/95 → 08/97

GOLF III Cabriolet (1E7)

1.9 TDI	Diesel	66	08/95 → 05/98
---------	--------	----	---------------

GOLF III Variant (1H5)

1.9 SDI	Diesel	47	07/95 → 04/99
1.9 TDI	Diesel	66	03/94 → 04/99
1.9 TDI Syncro	Diesel	66	07/95 → 04/99

GOLF IV Cabriolet (1E7)

1.9 TDI	Diesel	66	06/98 → 06/02
1.9 TDI	Diesel	81	06/98 → 06/02

LUPO (6X1, 6E1)

1.7 SDI	Diesel	44	09/98 → 07/05
---------	--------	----	---------------

PASSAT (3A2, 35I)

1.9 TDI	Diesel	66	10/93 → 08/96
1.9 TDI	Diesel	81	03/96 → 08/96

PASSAT (3B2)

1.9 TDI Syncro/4motion	Diesel	81	10/96 → 11/00
------------------------	--------	----	---------------

PASSAT Variant (3A5, 35I)

1.9 TDI	Diesel	66	10/93 → 05/97
1.9 TDI	Diesel	81	03/96 → 05/97

PASSAT Variant (3B5)

1.9 TDI Syncro/4motion	Diesel	81	06/97 → 11/00
------------------------	--------	----	---------------

SAG142

VOLKSWAGEN
POLO (6N1)

1.7 SDI	Diesel	42	04/97 → 10/99
60 1.7 SDI	Diesel	44	08/97 → 10/99
64 1.9 D	Diesel	47	10/94 → 10/99
64 1.9 SDI	Diesel	47	07/96 → 10/99

POLO (6N2)

1.7 SDI	Diesel	44	10/99 → 09/01
1.9 SDI	Diesel	47	10/99 → 09/01

POLO CLASSIC (6KV2)

64 1.9 SDI	Diesel	47	12/95 → 08/99
------------	--------	----	---------------

POLO Furgonato (6NF)

1.7 SDI	Diesel	44	08/97 → 12/99
1.9 SDI	Diesel	47	07/96 → 12/99

POLO Variant (6KV5)

1.9 SDI	Diesel	47	06/97 → 09/01
1.9 TDI	Diesel	66	05/97 → 09/01

SHARAN (7M8, 7M9, 7M6)

1.9 TDI	Diesel	66	09/95 → 03/10
---------	--------	----	---------------

VENTO (1H2)

1.9 SDI	Diesel	47	04/97 → 09/98
1.9 TDI	Diesel	66	09/93 → 09/98

SAG143
H1 **SENSORE GIRI / FASE - ALBERO MOTORE
CRANKSHAFT POSITION SENSOR**

RENAULT
CLIO II (BB0/1/2_, CB0/1/2_)

1.4 16V (B/CB0P)	Petrol	72	08/00 →
1.6 (B/CB0D)	Petrol	66	01/01 → 05/05

KANGOO (KC0/1_)

1.6 16V	Petrol	70	06/01 →
1.6 16V 4x4 (KC0P, KC0S, KC0L)	Petrol	70	10/01 →

SAG143

RENAULT
KANGOO Express (FC0/1_)

1.6 16V	Petrol	70	10/01 →
---------	--------	----	---------

MEGANE I (BA0/1_)

1.6 16V (BA11, BA04, BA0B, BA1J)	Petrol	79	03/99 → 08/03
--	--------	----	---------------

1.6 e (BA0F, BA0S)	Petrol	66	07/98 → 03/99
-----------------------	--------	----	---------------

2.0 i (BA0G)	Petrol	84	10/98 → 08/03
--------------	--------	----	---------------

1.6 16V 4x4 (FC0L, FC0P, FC0S)	Petrol	70	10/01 →
--------------------------------------	--------	----	---------

MEGANE I Cabriolet (EA0/1_)

2.0 i (EA0G)	Petrol	80	03/99 → 08/03
--------------	--------	----	---------------

MEGANE I Classic (LA0/1_)

1.6 16V (La04, LA11, LA0B, LA1C, LA1J)	Petrol	79	03/99 → 08/03
--	--------	----	---------------

MEGANE I Coach (DA0/1_)

1.6 16V (DA0B, DA04, DA11)	Petrol	79	03/99 → 08/03
-------------------------------	--------	----	---------------

1.6 e (DA0F)	Petrol	66	07/98 → 03/99
--------------	--------	----	---------------

2.0 i (DA0G)	Petrol	84	10/98 → 08/03
--------------	--------	----	---------------

MEGANE I Grandtour (KA0/1_)

1.6 16V (KA0B, KA04, KA11)	Petrol	79	03/99 → 08/03
-------------------------------	--------	----	---------------

1.6 e (KA0F)	Petrol	66	03/99 → 08/03
--------------	--------	----	---------------

MEGANE II (BM0/1_, CM0/1_)

1.6 16V (BM0C, CM0C)	Petrol	83	11/02 →
-------------------------	--------	----	---------

MEGANE Scenic (JA0/1_)

1.6 16V (JA0B, JA04, JA11)	Petrol	79	04/98 → 10/99
-------------------------------	--------	----	---------------

SAG144

H1 **SENSORE GIRI / FASE - ALBERO MOTORE**
CRANKSHAFT POSITION SENSOR



BMW

3 (E46)

316 i	Petrol	77	04/00 → 02/05
316 i	Petrol	77	09/98 → 02/05
318 i	Petrol	87	02/98 → 09/01
320 i	Petrol	110	03/98 → 09/00
320 i	Petrol	125	09/00 → 02/05
323 i	Petrol	125	03/98 → 09/00
325 i	Petrol	141	09/00 → 02/05
325 xi	Petrol	141	09/00 → 02/05
328 i	Petrol	142	02/98 → 06/00
330 i	Petrol	170	06/00 → 02/05
330 xi	Petrol	170	06/00 → 02/05

3 Cabriolet (E36)

320 i	Petrol	110	12/98 → 04/99
323 i	Petrol	125	12/98 → 04/99
328 i	Petrol	142	12/98 → 04/99

3 Cabriolet (E46)

320 Ci	Petrol	125	09/00 →
323 Ci	Petrol	125	04/00 → 09/00
330 Ci	Petrol	170	06/00 →

3 Compact (E36)

316 i	Petrol	77	12/98 → 08/00
323 ti	Petrol	125	12/98 → 08/00

3 Compact (E46)

325 ti	Petrol	141	06/01 → 02/05
--------	--------	-----	---------------

3 Coupé (E36)

320 i	Petrol	110	12/98 → 04/99
323 i	Petrol	125	12/98 → 04/99
328 i	Petrol	142	12/98 → 04/99

3 Coupé (E46)

316 Ci	Petrol	77	04/00 →
318 Ci	Petrol	87	11/99 → 09/01
320 Ci	Petrol	110	08/99 → 09/00
320 Ci	Petrol	125	09/00 →

SAG144



BMW

3 Coupé (E46)

323 Ci	Petrol	125	04/99 → 09/00
325 Ci	Petrol	141	09/00 →
328 Ci	Petrol	142	04/99 → 06/00
330 xi	Petrol	170	06/00 →

3 Touring (E36)

320 i	Petrol	110	12/98 → 10/99
323 i	Petrol	125	12/98 → 10/99
328 i	Petrol	142	12/98 → 10/99

3 Touring (E46)

318 i	Petrol	87	10/99 → 09/01
320 i	Petrol	110	10/99 → 09/00
320 i	Petrol	125	09/00 → 02/05
325 i	Petrol	141	09/00 → 02/05
325 xi	Petrol	141	09/00 → 02/05
328 i	Petrol	142	10/99 → 06/00
330 i	Petrol	170	06/00 → 02/05
330 xi	Petrol	170	06/00 → 02/05

5 (E39)

520 i	Petrol	110	10/98 → 09/00
520 i	Petrol	125	09/00 → 06/03
523 i	Petrol	125	10/98 → 09/00
525 i	Petrol	141	09/00 → 06/03
528 i	Petrol	142	10/98 → 09/00
530 i	Petrol	170	09/00 → 06/03

5 (E60)

520 i	Petrol	125	07/03 → 03/10
525 i	Petrol	141	09/03 → 03/10
530 i	Petrol	170	07/03 → 03/10

5 Touring (E39)

520 i	Petrol	125	09/00 → 05/04
525 i	Petrol	141	09/00 → 05/04
528 i	Petrol	142	10/98 → 09/00
530 i	Petrol	170	09/00 → 05/04

5 Touring (E61)

525 i	Petrol	141	06/04 →
530 i	Petrol	170	06/04 →

7 (E38)

728 i,iL	Petrol	142	10/98 → 11/01
----------	--------	-----	---------------

7 (E65, E66, E67)

730 i,Li	Petrol	170	03/03 →
----------	--------	-----	---------

X3 (E83)

2.5 i	Petrol	141	01/04 →
3.0 i xDrive	Petrol	170	01/04 →

SAG144

KW

BMW
X5 (E53)

3.0 d	Diesel	135	05/01 →
3.0 i	Petrol	163	05/00 →
3.0 i	Petrol	170	05/00 →

Z3 (E36)

1.9	Petrol	87	07/98 → 01/03
1.9	Petrol	85	01/99 → 01/03
2.0	Petrol	110	04/99 → 01/03
2.2	Petrol	125	08/00 → 01/03
3.0	Petrol	170	06/00 → 01/03

Z3 Coupé (E36)

2.8	Petrol	141	04/98 → 06/00
3.0	Petrol	170	06/00 → 06/03

Z4 (E85)

2.2 i	Petrol	125	10/03 →
2.5 i	Petrol	141	02/03 →
3.0 i	Petrol	170	02/03 →

LAND ROVER
FREELANDER (LN)

2.5 V6 4x4	Petrol	130	11/00 → 10/06
------------	--------	-----	---------------

MG
MG ZS

180	Petrol	130	07/01 → 04/05
-----	--------	-----	---------------

MG ZS Hatchback

180	Petrol	130	07/01 → 10/05
-----	--------	-----	---------------

MG ZT

160	Petrol	118	06/01 → 07/05	CHASSIS:YM174263→
190	Petrol	140	06/01 → 07/05	CHASSIS:YM174263→
1.8 T 16V	Petrol	118	01/03 → 07/05	

MG ZT- T

160	Petrol	118	10/01 → 07/05	CHASSIS:YM174263→
190	Petrol	140	10/01 → 07/05	CHASSIS:YM174263→
1.8 T 16V	Petrol	118	01/03 → 07/05	

ROVER
45 (RT)

2.0 V6	Petrol	110	02/00 → 05/05	CHASSIS:YD476900→
--------	--------	-----	---------------	-------------------

45 Tre volumi (RT)

2.0 V6	Petrol	110	02/00 → 05/05	CHASSIS:YD476900→
--------	--------	-----	---------------	-------------------

75 (RJ)

1.8 Turbo	Petrol	110	05/03 → 05/05
-----------	--------	-----	---------------

75 Tourer (RJ)

1.8 Turbo	Petrol	110	05/03 → 05/05
-----------	--------	-----	---------------

SAG145
H1
**SENSORE GIRI / FASE - ALBERO MOTORE
CRANKSHAFT POSITION SENSOR**

KW

SEAT
CORDOBA (6K2)

1.4	Petrol	44	06/99 → 10/00
-----	--------	----	---------------

CORDOBA Vario (6K5)

1.4	Petrol	44	06/99 → 10/00
-----	--------	----	---------------

IBIZA III (6K1)

1.0	Petrol	37	08/99 → 07/00
1.4	Petrol	44	08/99 → 10/00

VOLKSWAGEN
CADDY II Furgonato (9K9A)

60 1.4	Petrol	44	09/00 → 06/03
--------	--------	----	---------------

CADDY II Station wagon (9K9B)

1.4	Petrol	44	11/95 → 01/04
-----	--------	----	---------------

LUPO (6X1, 6E1)

1.0	Petrol	37	09/98 → 07/00
-----	--------	----	---------------

POLO (6N1)

120 1.6 16V GTI	Petrol	88	09/98 → 10/99
-----------------	--------	----	---------------

POLO (6N2)

1.0	Petrol	37	10/99 → 09/01
1.4	Petrol	40	10/99 → 09/01
1.4	Petrol	44	10/99 → 09/01

POLO CLASSIC (6KV2)

60 1.4	Petrol	44	10/99 → 10/00
--------	--------	----	---------------

POLO Variant (6KV5)

1.4	Petrol	40	12/98 → 09/01
1.4	Petrol	44	10/99 → 10/00

SAG146

H1 **SENSORE GIRI / FASE - ALBERO MOTORE**
CRANKSHAFT POSITION SENSOR



DAEWOO

KORANDO (KJ)

2.3 Petrol 105 01/99 → 12/00

KORANDO Cabrio (KJ)

2.0 16V Petrol 94 02/99 → 12/00

2.3 Petrol 105 02/99 → 12/00

MUSSO (FJ)

2.3 Petrol 103 01/99 → 12/00

MERCEDES-BENZ

CLASSE A (W168)

A 140 (168.031, 168.131) Petrol 60 07/97 → 12/97

A 160 (168.033, 168.133) Petrol 75 07/97 → 12/97

CLASSE C (W202)

C 180 (202.018) Petrol 89 11/94 → 05/00 ENGINE: → 106153, → 060038

C 180 (202.018) Petrol 90 03/93 → 05/00 ENGINE: → 106153, → 060038

C 200 CDI (202.134) Diesel 75 03/98 → 05/00

C 220 CDI (202.133) Diesel 92 09/97 → 05/00

C 220 D Diesel 55 07/96 → 05/00 ENGINE: 086384 →, 018031 →

C 220 D (202.121) Diesel 70 08/93 → 05/00 ENGINE: 086384 →, 018031 →

C 250 Turbo-D (202.128) Diesel 110 10/95 → 05/00 ENGINE: 015000 →, 007448 →

CLASSE C Station wagon (S202)

C 180 T (202.078) Petrol 90 06/96 → 09/00 ENGINE: → 106153, → 060038

C 200 T CDI (202.194) Diesel 75 03/98 → 03/01

SAG146



MERCEDES-BENZ

CLASSE C Station wagon (S202)

C 220 T CDI (202.193) Diesel 92 09/97 → 03/01

C 220 T D Diesel 55 06/96 → 03/01 ENGINE: 086384 →, 018031 →

C 220 T D (202.182) Diesel 70 06/96 → 09/98 ENGINE: 086384 →, 018031 →

C 250 T Turbo-D (202.188) Diesel 110 06/96 → 03/01 ENGINE: 015000 →, 007448 →

CLASSE E (W210)

E 200 (210.035) Petrol 100 06/95 → 06/98

E 200 D (210.003) Diesel 65 01/96 → 03/02

E 220 D Diesel 55 05/96 → 03/02

E 220 D (210.004) Diesel 70 06/95 → 07/99

E 230 (210.037) Petrol 110 06/95 → 06/97

E 250 D (210.010) Diesel 83 06/95 → 07/99

E 250 Turbo-D (210.015) Diesel 110 06/97 → 07/99

E 290 Turbo-D (210.017) Diesel 95 03/96 → 07/99

E 300 D (210.020) Diesel 100 06/95 → 06/97

E 420 (210.072) Petrol 205 01/96 → 06/97

E 50 AMG (210.072) Petrol 255 02/96 → 08/97

CLASSE E Station wagon (S210)

E 200 T (210.235) Petrol 100 06/96 → 06/98

E 230 T (210.237) Petrol 110 06/96 → 06/97

E 250 T Turbo-D (210.215) Diesel 110 06/97 → 07/99

E 290 T Turbo-D (210.217) Diesel 95 06/96 → 07/99

E 420 T (210.272) Petrol 205 06/96 → 06/97

CLASSE S (W140)

400 SE, SEL/ S420 (140.042, 140.043) Petrol 210 09/95 → 10/98

S 420 (140.042) Petrol 205 09/95 → 10/98

S 500 (140.050, 140.051) Petrol 235 09/95 → 10/98

S 600 (140.056, 140.057) Petrol 290 09/95 → 10/98

SAG146

MERCEDES-BENZ
CLASSE S Coupé (C140)

SEC/CL 420 (140.063)	Petrol	205	06/96 → 02/99
-------------------------	--------	-----	---------------

SEC/CL 500 (140.070)	Petrol	235	09/96 → 02/99
-------------------------	--------	-----	---------------

SEC/CL 600 (140.076)	Petrol	290	06/96 → 02/99
-------------------------	--------	-----	---------------

SL (R129)

60 AMG (129.067)	Petrol	280	05/97 → 10/01
---------------------	--------	-----	---------------

600 (129.076)	Petrol	290	07/92 → 10/01
---------------	--------	-----	---------------

SPRINTER 2-t Autobus (901, 902)

210 D	Diesel	75	03/97 → 04/00
-------	--------	----	---------------

212 D	Diesel	90	02/95 → 04/00
-------	--------	----	---------------

SPRINTER 2-t Furgonato (901, 902)

210 D	Diesel	75	01/97 → 04/00
-------	--------	----	---------------

212 D	Diesel	90	02/95 → 04/00
-------	--------	----	---------------

SPRINTER 2-t Pianale piatto/Telaio (901, 902)

210 D	Diesel	75	01/97 → 04/00
-------	--------	----	---------------

212 D	Diesel	90	02/95 → 04/00
-------	--------	----	---------------

SPRINTER 3-t Autobus (903)

310 D 4x4	Diesel	75	05/97 → 03/00
-----------	--------	----	---------------

312 D 2.9	Diesel	90	02/95 → 04/00
-----------	--------	----	---------------

312 D 2.9 4x4	Diesel	90	05/97 → 03/00
---------------	--------	----	---------------

SPRINTER 3-t Furgonato (903)

310 D 2.9	Diesel	75	01/97 → 04/00
-----------	--------	----	---------------

312 D 2.9	Diesel	90	02/95 → 04/00
-----------	--------	----	---------------

312 D 2.9 4x4	Diesel	90	05/97 → 03/00
---------------	--------	----	---------------

SPRINTER 3-t Pianale piatto/Telaio (903)

310 D 2.9	Diesel	75	01/97 → 04/00
-----------	--------	----	---------------

312 D 2.9	Diesel	90	02/95 → 04/00
-----------	--------	----	---------------

SPRINTER 4-t Furgonato (904)

410 D	Diesel	75	01/97 → 03/00
-------	--------	----	---------------

410 D 4x4	Diesel	75	05/97 → 03/00
-----------	--------	----	---------------

412 D	Diesel	85	01/97 → 03/00
-------	--------	----	---------------

412 D	Diesel	90	01/97 → 03/00
-------	--------	----	---------------

412 D 4x4	Diesel	85	05/97 → 03/00
-----------	--------	----	---------------

412 D 4x4	Diesel	90	05/97 → 03/00
-----------	--------	----	---------------

SPRINTER 4-t Pianale piatto/Telaio (904)

410 D	Diesel	75	01/97 → 03/00
-------	--------	----	---------------

410 D 4x4	Diesel	75	05/97 → 03/00
-----------	--------	----	---------------

412 D	Diesel	85	01/97 → 03/00
-------	--------	----	---------------

412 D	Diesel	90	01/97 → 03/00
-------	--------	----	---------------

412 D 4x4	Diesel	85	05/97 → 03/00
-----------	--------	----	---------------

412 D 4x4	Diesel	90	05/97 → 03/00
-----------	--------	----	---------------

SAG146

SSANGYONG
KORANDO (KJ)

2.0	Petrol	94	05/97 →
-----	--------	----	---------

2.3	Petrol	105	01/99 →
-----	--------	-----	---------

2.3	Petrol	103	05/97 →
-----	--------	-----	---------

KORANDO Cabrio (KJ)

2.3	Petrol	105	02/99 →
-----	--------	-----	---------

2.3	Petrol	103	11/97 →
-----	--------	-----	---------

MUSSO (FJ)

2.3	Petrol	110	04/03 →
-----	--------	-----	---------

SAG150
H1 **SENSORE GIRI / FASE - ALBERO MOTORE**
CRANKSHAFT POSITION SENSOR

CITROËN
AX (ZA-)

14	Petrol	55	05/91 → 04/97
----	--------	----	---------------

14 4x4	Petrol	55	08/91 → 12/96
--------	--------	----	---------------

BERLINGO (MF)

1.9 D (MFWJZ)	Diesel	51	11/02 →
---------------	--------	----	---------

1.9 D 4WD (MFWJZ)	Diesel	51	11/02 →
----------------------	--------	----	---------

BERLINGO Furgonato (M_)

1.9 D 70 (MBWJZ, MCWJZ)	Diesel	51	11/02 →
-------------------------------	--------	----	---------

1.9 D 70 4WD (MBWJZ, MCWJZ)	Diesel	51	11/02 →
-----------------------------------	--------	----	---------

BX (XB-)

16 E	Petrol	65	01/91 → 02/93
------	--------	----	---------------

BX Break (XB-)

16	Petrol	65	04/91 → 12/93
----	--------	----	---------------

19 Cat.	Petrol	75	07/86 → 12/94
---------	--------	----	---------------

SAG150



KW



CITROËN

EVASION (22, U6)

1.9 TD Diesel 68 10/95 → 12/98

JUMPER Autobus (230P)

2.0 Petrol 80 02/94 → 04/02

JUMPER Furgonato (230L)

2.0 Petrol 80 03/94 → 04/02

JUMPER Pianale piatto/Telaio (230)

2.0 Petrol 80 03/94 → 04/02

XANTIA (X1)

1.6 i Petrol 65 03/93 → 01/98

1.8 i Petrol 66 04/97 → 01/98

1.8 i Petrol 74 03/93 → 01/98

1.8 i 16V Petrol 81 06/95 → 01/98

1.9 Turbo D Diesel 66 10/94 → 01/98

2.0 i Petrol 89 03/93 → 01/98

2.0 i 16V Petrol 110 06/94 → 01/98

2.0 i 16V Petrol 112 03/93 → 01/98

2.0 i 16V Petrol 97 06/95 → 01/98

2.0 Turbo Petrol 108 06/95 → 01/98

2.1 Turbo D 12V Diesel 80 06/95 → 01/98

XANTIA (X2)

2.1 Turbo D 12V Diesel 80 01/98 → 02/99

XANTIA Break (X1)

1.8 i Petrol 74 06/95 → 01/98

1.8 i Petrol 66 04/97 → 01/98

1.8 i 16V Petrol 81 06/95 → 01/98

1.9 SD Diesel 55 04/97 → 01/98

1.9 Turbo D Diesel 66 06/95 → 01/98

2.0 i Petrol 89 06/95 → 01/98

2.0 i 16V Petrol 97 06/95 → 01/98

2.0 Turbo Petrol 108 06/95 → 01/98

XANTIA Break (X2)

2.1 Turbo D 12V Diesel 80 01/98 → 02/99

XM (Y3)

2.0 i Petrol 79 05/89 → 04/94

2.0 i Petrol 89 05/89 → 06/94

2.0 i Turbo Petrol 104 09/92 → 06/94

3.0 V6 Petrol 123 05/89 → 06/94

3.0 V6 24V Petrol 147 07/90 → 06/94

XM Break (Y3)

2.0 i Petrol 89 11/91 → 04/94

2.0 i (Y3A) Petrol 79 11/91 → 04/94

2.0 Turbo Petrol 104 09/92 → 04/94

3.0 V6 Petrol 123 11/91 → 04/94

SAG150



KW



CITROËN

XM Break (Y4)

2.1 D12 Diesel 60 07/94 → 06/96

XSARA Coupé (N0)

1.8 i Petrol 74 02/98 → 09/00

ZX (N2)

1.6 i Petrol 65 03/91 → 06/97

1.8 i Petrol 74 07/92 → 06/97

1.8 i 16V Petrol 81 01/96 → 06/97

2.0 i Petrol 89 07/92 → 06/97

2.0 i 16V Petrol 110 06/94 → 06/97

2.0 i 16V Petrol 112 07/92 → 10/94

ZX Break (N2)

1.6 i Petrol 65 10/93 → 10/97

1.8 i Petrol 74 10/93 → 10/97

1.8 i 16V Petrol 81 01/96 → 02/98

FIAT

DUCATO Autobus (230)

1.9 TD Diesel 66 04/98 → 04/02

2.0 Panorama/
Combinato Petrol 80 02/95 → 04/02

DUCATO Furgonato (230L)

1.9 TD Diesel 66 04/98 → 04/02

2.0 Petrol 80 02/95 → 04/02

DUCATO Pianale piatto/Telaio (230)

1.9 TD Diesel 66 04/98 → 04/02

2.0 Petrol 80 06/98 → 04/02

ULYSSE (220)

2.0 (220.AC5) Petrol 89 02/95 → 08/02

2.0 Turbo
(220.AD5) Petrol 108 02/95 → 08/02

PEUGEOT

309 II (3C, 3A)

1.6 Petrol 65 07/89 → 12/93

405 I (15B)

1.6 Petrol 65 07/87 → 12/92

1.6 Petrol 66 10/89 → 12/92

405 I Break (15E)

1.6 Petrol 65 10/88 → 08/92

405 II (4B)

1.6 Petrol 65 08/92 → 10/95

1.8 Petrol 74 08/92 → 10/95

2.0 Petrol 89 08/92 → 10/95

2.0 16V Petrol 110 06/94 → 10/95

2.0 MI-16 Petrol 112 08/92 → 10/95

2.0 T 16 X4 Petrol 144 08/92 → 10/95

SAG150

CITROËN
405 II (4B)

2.0 X4	Petrol	89	08/92 → 10/95
--------	--------	----	---------------

405 II Break (4E)

1.6	Petrol	65	08/92 → 10/96
-----	--------	----	---------------

1.8	Petrol	74	08/92 → 10/96
-----	--------	----	---------------

2.0	Petrol	89	08/92 → 10/96
-----	--------	----	---------------

2.0 4x4	Petrol	89	08/92 → 10/96
---------	--------	----	---------------

605 (6B)

2.0	Petrol	79	02/90 → 09/99
-----	--------	----	---------------

2.0	Petrol	89	06/89 → 09/99
-----	--------	----	---------------

2.0 16V	Petrol	97	07/94 → 09/99
---------	--------	----	---------------

2.0 Turbo	Petrol	108	07/91 → 09/99
-----------	--------	-----	---------------

2.0 Turbo	Petrol	104	07/92 → 09/99
-----------	--------	-----	---------------

2.1 TD 12V	Diesel	80	08/94 → 09/99
------------	--------	----	---------------

2.1 Turbo Diesel	Diesel	80	06/89 → 09/99
------------------	--------	----	---------------

2.5 Turbo Diesel	Diesel	95	07/94 → 09/99
------------------	--------	----	---------------

3.0	Petrol	123	10/89 → 09/99
-----	--------	-----	---------------

3.0 SV 24	Petrol	147	08/89 → 09/99
-----------	--------	-----	---------------

3.0 V6	Petrol	140	04/97 → 09/99
--------	--------	-----	---------------

806 (221)

1.9 TD	Diesel	66	07/95 → 08/02
--------	--------	----	---------------

1.9 TD	Diesel	68	05/97 → 08/02
--------	--------	----	---------------

2.0	Petrol	89	06/94 → 08/02
-----	--------	----	---------------

2.0 16V	Petrol	97	05/98 → 09/00
---------	--------	----	---------------

2.0 Turbo	Petrol	108	06/94 → 08/02
-----------	--------	-----	---------------

BOXER Autobus (230P)

2.0 i	Petrol	80	03/94 → 04/02
-------	--------	----	---------------

BOXER Furgonato (230L)

2.0 i	Petrol	80	06/94 → 04/02
-------	--------	----	---------------

BOXER Pianale piatto/Telaio (ZCT_)

2.0 i	Petrol	80	06/94 → 04/02
-------	--------	----	---------------

RANCH Furgonato (5)

1.9 D	Diesel	51	09/02 →
-------	--------	----	---------

RANCH Furgonato (5)

1.9 D 4x4	Diesel	51	04/04 →
-----------	--------	----	---------

RANCH MPV / Space wagon (5F)

1.8	Petrol	66	05/97 →
-----	--------	----	---------

1.9 D	Diesel	51	09/02 →
-------	--------	----	---------

RENAULT
SPACE III (JE0_)

3.0 V6 24V (JE0G, JE0R)	Petrol	140	10/98 → 10/02
----------------------------	--------	-----	---------------

LAGUNA I Grandtour (K56_)

3.0 24V (K56V)	Petrol	140	03/97 → 03/01
----------------	--------	-----	---------------

SAG150

RENAULT
SAFRANE II (B54_)

2.9 24V (B54N)	Petrol	140	03/99 → 12/00
----------------	--------	-----	---------------

SAG151
**H1 SENSORE GIRI / FASE - ALBERO MOTORE
CRANKSHAFT POSITION SENSOR**

BMW
1 (E81)

116 i	Petrol	85	03/07 → 09/12
-------	--------	----	---------------

118 i	Petrol	95	09/06 → 09/12
-------	--------	----	---------------

120 i	Petrol	110	09/06 → 09/12
-------	--------	-----	---------------

3 (E36)

316 i	Petrol	75	07/93 → 02/98
-------	--------	----	---------------

3 (E46)

316 i	Petrol	85	02/02 → 02/05
-------	--------	----	---------------

316 i	Petrol	85	06/02 → 02/05
-------	--------	----	---------------

318 i	Petrol	105	09/01 → 02/05
-------	--------	-----	---------------

3 (E90)

316 i	Petrol	85	02/06 → 12/11
-------	--------	----	---------------

318 i	Petrol	105	09/07 → 12/11
-------	--------	-----	---------------

318 i	Petrol	95	09/05 → 03/07
-------	--------	----	---------------

320 i	Petrol	110	01/05 → 03/07
-------	--------	-----	---------------

320 si	Petrol	127	05/06 → 12/11
--------	--------	-----	---------------

3 Cabriolet (E46)

318 Ci	Petrol	105	09/01 →
--------	--------	-----	---------

318 Ci	Petrol	110	02/05 →
--------	--------	-----	---------

3 Compact (E46)

316 ti	Petrol	85	06/01 → 02/05
--------	--------	----	---------------

318 ti	Petrol	105	09/01 → 02/05
--------	--------	-----	---------------

3 Coupé (E36)

316 i	Petrol	75	09/93 → 04/99
-------	--------	----	---------------

SAG151



BMW

3 Coupé (E46)

316 Ci	Petrol	85	06/02 →
318 Ci	Petrol	105	09/01 →
318 Ci	Petrol	110	03/05 →
330 Ci	Petrol	170	06/00 →

3 Touring (E46)

316 i	Petrol	85	06/02 → 02/05
318 i	Petrol	105	09/01 → 02/05

3 Touring (E91)

318 i	Petrol	95	01/06 →
320 i	Petrol	110	09/05 →

5 (E39)

520 i	Petrol	100	04/99 → 06/03
520 i	Petrol	110	01/96 → 09/00
525 tds	Diesel	105	01/96 → 06/03
528 i	Petrol	142	11/95 → 09/00

5 (E60)

545 i	Petrol	245	09/03 → 03/10
-------	--------	-----	---------------

5 Touring (E39)

528 i	Petrol	142	01/97 → 09/00
-------	--------	-----	---------------

5 Touring (E61)

545 i	Petrol	245	06/04 →
-------	--------	-----	---------

6 (E63)

645 Ci	Petrol	245	01/04 →
--------	--------	-----	---------

6 Cabriolet (E64)

645 Ci	Petrol	245	04/04 →
--------	--------	-----	---------

7 (E38)

728 i,iL	Petrol	142	08/95 → 11/01
----------	--------	-----	---------------

7 (E65, E66, E67)

735 i,Li	Petrol	200	11/01 →
745 i,Li	Petrol	245	11/01 →

X3 (E83)

2.0 D	Diesel	130	09/07 →
2.0 i	Petrol	110	07/05 →
2.5 si	Petrol	160	09/06 →
3.0 sd	Diesel	210	09/06 →
3.0 si	Petrol	200	09/06 →

X5 (E53)

4.4 i	Petrol	235	12/03 →
4.8 is	Petrol	265	04/04 →

Z3 Coupé (E36)

2.8	Petrol	141	07/97 → 06/00
-----	--------	-----	---------------

Z4 (E85)

2.0 i	Petrol	110	04/05 →
-------	--------	-----	---------

SAG152

H1 **SENSORE GIRI / FASE - ALBERO MOTORE**
CRANKSHAFT POSITION SENSOR



CITROËN

C1 (PM_, PN_)

1.0	Petrol	50	06/05 →
-----	--------	----	---------

PEUGEOT

107

1.0	Petrol	50	06/05 →
-----	--------	----	---------

TOYOTA

AYGO (WNB1_, KGB1_)

1.0 (KGB10)	Petrol	50	07/05 →
-------------	--------	----	---------

IQ (KPJ1_, NGJ1_, KGJ1_, NUJ1_)

1.0	Petrol	50	01/09 →
-----	--------	----	---------

YARIS (SCP9_, NSP9_, KSP9_, NCP9_, ZSP9_)

1.0 VVT-i	Petrol	51	08/05 →
-----------	--------	----	---------

SAG153

H1 **SENSORE GIRI / FASE - ALBERO MOTORE**
CRANKSHAFT POSITION SENSOR



MITSUBISHI

CARISMA (DA_)

1.9 DI-D	Diesel	85	09/00 → 06/06
1.9 DI-D (DA5A)	Diesel	75	09/00 → 06/06

CARISMA Tre volumi (DA_)

1.9 DI-D	Diesel	85	09/00 → 06/06
1.9 DI-D (DA5A)	Diesel	75	09/00 → 06/06

SAG153

KW

MITSUBISHI
SPACE STAR (DG_A)

1.9 DI-D	Diesel	85	10/02 → 07/04
1.9 DI-D (DG4A)	Diesel	75	02/01 → 07/04

NISSAN
INTERSTAR Autobus (X70)

dCi 100	Diesel	73	11/03 →
dCi 120	Diesel	84	07/02 →
dCi 80	Diesel	60	07/02 →
dCi 90	Diesel	66	07/02 →

INTERSTAR Furgonato (X70)

dCi 100	Diesel	73	11/03 →
dCi 120	Diesel	84	07/02 →
dCi 80	Diesel	60	07/02 →
dCi 90	Diesel	66	07/02 →

INTERSTAR Pianale piatto/Telaio

dCi 100	Diesel	73	02/04 →
dCi 120	Diesel	84	08/03 →

PRIMASTAR Autobus (X83)

dCi 100	Diesel	74	03/01 →
dCi 140	Diesel	99	07/03 →
dCi 80	Diesel	60	03/01 →

PRIMASTAR Furgonato (X83)

dCi 100	Diesel	74	09/02 →
dCi 140	Diesel	99	07/03 →
dCi 80	Diesel	60	09/02 →

OPEL
MOVANO Combi (J9)

1.9 DTI	Diesel	60	10/01 →
2.2 DTI	Diesel	66	09/00 →
2.5 DTi	Diesel	84	10/01 →

MOVANO Furgonato (F9)

1.9 DTI	Diesel	60	10/01 →
2.2 DTI	Diesel	66	09/00 →
2.5 DTi	Diesel	84	10/01 →
2.5 DTi	Diesel	73	10/03 →

MOVANO Pianale piatto/Telaio (U9, E9)

2.2 DTI	Diesel	66	09/00 →
2.5 DTi	Diesel	84	10/01 →

MOVANO Ribaltabile (H9)

2.2 DTI	Diesel	66	09/00 →
2.5 DTi	Diesel	73	10/03 →

VIVARO Combi (J7)

1.9 DI	Diesel	60	08/01 →
2.5 DTi	Diesel	99	05/03 →

SAG153

KW

OPEL
VIVARO Furgonato (F7)

2.5 DTi	Diesel	99	05/03 →
---------	--------	----	---------

RENAULT
AVANTIME (DE0_)

2.2 dCi (DE01)	Diesel	110	05/02 → 05/03
----------------	--------	-----	---------------

ESPACE IV (JK0/1_)

2.2 dCi (JK07)	Diesel	102	02/06 →
2.2 dCi (JK0H)	Diesel	110	11/02 →

KANGOO (KC0/1_)

1.9 dCi 4x4 (KC0V)	Diesel	59	10/01 →
1.9 dTi (KC0U)	Diesel	59	05/00 →

KANGOO Express (FC0/1_)

1.9 dCi 4x4 (FC0V)	Diesel	59	10/01 →
1.9 dTi (FC0U)	Diesel	59	05/00 →

LAGUNA II (BG0/1_)

1.9 dCi (BG05)	Diesel	68	03/04 →
1.9 dCi (BG08, BG0G)	Diesel	88	03/01 →
1.9 dCi (BG0R)	Diesel	74	10/01 →
1.9 dCi (BG1A, BG1V)	Diesel	96	05/05 →
1.9 dCi (BG1A, BG1W)	Diesel	81	01/05 →
2.2 dCi	Diesel	102	05/05 →
2.2 dCi (BG0F)	Diesel	110	10/01 →

LAGUNA II Grandtour (KG0/1_)

1.9 dCi (KG05)	Diesel	68	03/04 →
1.9 dCi (KG0E, KG0R)	Diesel	74	10/01 →
1.9 dCi (KG0G)	Diesel	88	03/01 →
1.9 dCi (KG1A, KG1W)	Diesel	81	01/05 →
1.9 dCi (KG1V)	Diesel	96	05/05 →
2.2 dCi	Diesel	102	05/05 →
2.2 dCi (KG0F)	Diesel	110	10/01 →

MASTER II Autobus (JD)

1.9 dCi 80	Diesel	60	11/01 →
1.9 DTI	Diesel	59	09/00 →
2.2 dCi 90	Diesel	66	09/00 → 06/02
2.5 dCi 120	Diesel	84	10/01 →

SAG153



KW



RENAULT

MASTER II Furgonato (FD)

1.9 dCi 80	Diesel	60	11/01 →
1.9 DTI	Diesel	59	09/00 →
2.2 dCi 90	Diesel	66	09/00 → 06/02
2.5 dCi 120	Diesel	84	10/01 →

MASTER II Pianale piatto/Telaio (ED/HD/UD)

2.2 dCi 90	Diesel	66	09/00 → 06/02
2.5 dCi 120	Diesel	84	10/01 →

MEGANE II (BM0/1_, CM0/1_)

1.9 dCi	Diesel	96	05/05 →
1.9 dCi	Diesel	68	03/04 →
1.9 dCi (BMOG, CMOG)	Diesel	88	11/02 →

MEGANE II Coupé-Cabriolet (EM0/1_)

1.9 dCi	Diesel	96	05/05 →
1.9 dCi	Diesel	88	09/03 →

MEGANE II Station wagon (KM0/1_)

1.9 dCi	Diesel	96	05/05 →
1.9 dCi	Diesel	68	03/04 →
1.9 dCi	Diesel	88	08/03 →

MEGANE II Tre volumi (LM0/1_)

1.9 dCi	Diesel	96	05/05 →
1.9 dCi	Diesel	68	03/04 →
1.9 dCi (LMOG, LM1G, LM2C)	Diesel	88	09/03 →

SCÉNIC II (JM0/1_)

1.9 dCi (JM0G, JM12, JM1G, JM2C)	Diesel	88	06/03 →
1.9 dCi (JM14)	Diesel	96	05/05 →

TRAFIC II Autobus (JL)

1.9 dCi 100 (JL0C)	Diesel	74	03/01 →
1.9 dCi 80 (JL0B)	Diesel	60	03/01 →
2.5 dCi 135 (JL0D)	Diesel	99	05/03 →

TRAFIC II Furgonato (FL)

1.9 dCi 100 (FL0C)	Diesel	74	03/01 →
1.9 dCi 80 (FL0B)	Diesel	60	03/01 →
2.5 dCi 135 (FL0D)	Diesel	99	05/03 →

SAG153



KW



RENAULT

TRAFIC II Pianale piatto/Telaio (EL)

1.9 dCi 100 (EL0C)	Diesel	74	03/01 →
1.9 dCi 80 (EL0B)	Diesel	60	03/01 →
2.5 dCi 135 (EL0D)	Diesel	99	03/01 →

VEL SATIS (BJ0_)

2.2 dCi (BJ0E, BJ0F)	Diesel	110	06/02 →
2.2 dCi (BJ0E, BJ0F, BJ0G, BJ0H)	Diesel	102	09/04 →

SUZUKI

GRAND VITARA II (JT)

1.9 DDiS	Diesel	95	10/05 →
----------	--------	----	---------

VOLVO

S40 I (VS)

1.9 DI	Diesel	75	07/00 → 12/03
1.9 DI	Diesel	85	07/00 → 12/03

V40 Station wagon (VW)

1.9 DI	Diesel	75	07/00 → 06/04
1.9 DI	Diesel	85	07/00 → 06/04

SAG155

H1

SENSORE GIRI / FASE - ALBERO MOTORE
CRANKSHAFT POSITION SENSOR

KW



AUDI

A3 (8P1)

1.2 TSI	Petrol	77	04/10 → 08/12
1.4 TFSI	Petrol	92	09/07 → 08/12
1.6 TDI	Diesel	66	05/09 → 08/12
1.6 TDI	Diesel	77	05/09 → 08/12

SAG155

AUDI
A3 Cabriolet (8P7)

1.2 TFSI	Petrol	77	03/10 → 05/13
1.6 TDI	Diesel	77	05/09 → 05/13
2.0 TDi	Diesel	103	04/08 → 05/13

A3 Sportback (8PA)

1.2 TSI	Petrol	77	04/10 → 03/13
1.4 TFSI	Petrol	92	09/07 → 03/13
1.6 TDI	Diesel	66	05/09 → 03/13
1.6 TDI	Diesel	77	05/09 → 03/13

A4 (8K2, B8)

2.0 TDi	Diesel	100	11/07 →
2.0 TDi	Diesel	105	11/07 →
2.0 TDi	Diesel	120	08/08 →
2.0 TDi	Diesel	88	06/08 →
2.0 TDi	Diesel	125	01/08 →
2.0 TDi quattro	Diesel	105	11/08 →
2.0 TDi quattro	Diesel	125	01/08 →

A4 Allroad (8KH, B8)

2.0 TDi quattro	Diesel	105	09/09 →
2.0 TDi quattro	Diesel	125	04/09 →

A4 Avant (8K5, B8)

2.0 TDi	Diesel	100	04/08 →
2.0 TDi	Diesel	105	04/08 →
2.0 TDi	Diesel	120	08/08 →
2.0 TDi	Diesel	88	06/08 →
2.0 TDi	Diesel	125	04/08 →
2.0 TDi quattro	Diesel	105	04/08 →
2.0 TDi quattro	Diesel	125	08/08 →

A5 (8T3)

2.0 TDi	Diesel	125	08/08 →
2.0 TDi quattro	Diesel	125	08/08 →

A5 Cabriolet (8F7)

2.0 TDi	Diesel	125	05/09 →
---------	--------	-----	---------

A5 Sportback (8TA)

2.0 TDi	Diesel	105	09/09 →
2.0 TDi	Diesel	125	09/09 →
2.0 TDi quattro	Diesel	125	09/09 →

A6 Avant (4F5, C6)

2.0 TDi	Diesel	125	10/08 → 08/11
---------	--------	-----	---------------

Q5 (8R)

2.0 TDi quattro	Diesel	105	08/09 →
2.0 TDi quattro	Diesel	125	11/08 →

TT (8J3)

2.0 TDi quattro	Diesel	125	06/08 →
-----------------	--------	-----	---------

SAG155

AUDI
TT Roadster (8J9)

2.0 TDi quattro	Diesel	125	06/08 →
-----------------	--------	-----	---------

SEAT
ALTEA (5P1)

1.4 TSI	Petrol	92	11/07 →
---------	--------	----	---------

ALTEA XL (5P5, 5P8)

1.4 TSI	Petrol	92	11/07 →
---------	--------	----	---------

SKODA
OCTAVIA (1Z3)

2.0 TDi RS	Diesel	125	04/06 →
------------	--------	-----	---------

OCTAVIA Combi (1Z5)

2.0 TDi RS	Diesel	125	04/06 →
------------	--------	-----	---------

SUPERB (3T4)

1.4 TSI	Petrol	92	07/08 →
2.0 TDi	Diesel	125	07/08 →
2.0 TDi 4x4	Diesel	125	09/08 →

YETI (5L)

1.2 TSI	Petrol	77	09/09 →
2.0 TDi	Diesel	81	11/09 →
2.0 TDi 4x4	Diesel	103	05/09 →
2.0 TDi 4x4	Diesel	125	11/09 →

VOLKSWAGEN
EOS (1F7, 1F8)

1.4 TSI	Petrol	118	05/08 →
1.4 TSI	Petrol	90	11/07 →

GOLF PLUS (5M1, 521)

1.4 TSI	Petrol	103	05/06 → 06/08
1.4 TSI	Petrol	118	06/08 →
1.4 TSI	Petrol	125	05/06 → 06/08

GOLF PLUS (5M1, 521)

1.4 TSI	Petrol	90	06/07 →	CHASSIS: 1K8575001 →
---------	--------	----	---------	-------------------------

GOLF V (1K1)

1.4 TSI	Petrol	90	05/07 → 11/08
1.4 TSI	Petrol	103	05/06 → 11/08
1.4 TSI	Petrol	125	11/05 → 11/08

GOLF V Variant (1K5)

1.4 TSI	Petrol	103	06/07 → 07/09	CHASSIS: 1K8326332 →
1.4 TSI	Petrol	118	07/08 → 07/09	

1.4 TSI	Petrol	125	06/07 → 07/09	CHASSIS: 1K8326323 →
---------	--------	-----	---------------	-------------------------

GOLF VI (5K1)

2.0 TDi	Diesel	103	10/08 → 05/13
---------	--------	-----	---------------

SAG155



VOLKSWAGEN

JETTA III (1K2)

1.4 TSI	Petrol	118	07/08 → 10/10
---------	--------	-----	---------------

PASSAT (3C2)

1.4 TSI	Petrol	90	05/07 → 07/10
---------	--------	----	---------------

1.4 TSI EcoFuel	BiFuel	110	01/09 → 07/10
-----------------	--------	-----	---------------

2.0 BlueTDI	Diesel	105	01/09 → 11/10
-------------	--------	-----	---------------

2.0 TDi	Diesel	100	03/05 → 11/10
---------	--------	-----	---------------

2.0 TDi	Diesel	81	11/08 → 07/10
---------	--------	----	---------------

PASSAT CC (357)

2.0 TDi	Diesel	100	06/08 → 05/11
---------	--------	-----	---------------

2.0 TDi	Diesel	103	06/08 → 01/12
---------	--------	-----	---------------

2.0 TDi	Diesel	125	06/08 → 01/12
---------	--------	-----	---------------

PASSAT Variant (3C5)

1.4 TSI	Petrol	90	05/07 → 11/10
---------	--------	----	---------------

2.0 BlueTDI	Diesel	105	01/09 → 11/10
-------------	--------	-----	---------------

2.0 TDi	Diesel	100	08/05 → 11/10
---------	--------	-----	---------------

2.0 TDi	Diesel	81	11/08 → 11/10
---------	--------	----	---------------

SCIROCCO (137, 138)

1.4 TSI	Petrol	118	05/08 →
---------	--------	-----	---------

1.4 TSI	Petrol	90	08/08 →
---------	--------	----	---------

2.0 TDi	Diesel	103	08/08 →
---------	--------	-----	---------

TIGUAN (5N_)

1.4 TSI	Petrol	110	05/08 →
---------	--------	-----	---------

1.4 TSI 4motion	Petrol	110	09/07 →
-----------------	--------	-----	---------

2.0 TDi	Diesel	103	03/08 →
---------	--------	-----	---------

2.0 TDI 4motion	Diesel	125	09/07 →
-----------------	--------	-----	---------

TOURAN (1T1, 1T2)

1.4 FSI	Petrol	125	11/06 → 05/10
---------	--------	-----	---------------

1.4 TSI	Petrol	103	02/06 → 05/10
---------	--------	-----	---------------

SAG156

H1

**SENSORE GIRI / FASE - ALBERO MOTORE
CRANKSHAFT POSITION SENSOR**



CITROËN

AX (ZA-_)

10	Petrol	33	07/86 → 12/98
----	--------	----	---------------

10	Petrol	37	02/87 → 12/98
----	--------	----	---------------

11	Petrol	44	06/92 → 12/97
----	--------	----	---------------

14	Petrol	55	01/93 → 04/97
----	--------	----	---------------

1.4 GTi	Petrol	74	06/91 → 12/92
---------	--------	----	---------------

14 4x4	Petrol	55	01/93 → 12/96
--------	--------	----	---------------

SAXO (S0, S1)

1.1 X,SX	Petrol	44	05/96 → 01/98
----------	--------	----	---------------

XSARA (N1)

1.4 i	Petrol	55	04/97 → 01/98
-------	--------	----	---------------

1.6 i	Petrol	65	04/97 → 01/98
-------	--------	----	---------------

XSARA Break (N2)

1.4 i	Petrol	55	10/97 → 01/98
-------	--------	----	---------------

1.6 i	Petrol	65	10/97 → 01/98
-------	--------	----	---------------

ZX (N2)

1.1	Petrol	44	04/94 → 06/97
-----	--------	----	---------------

1.4	Petrol	55	08/92 → 06/97
-----	--------	----	---------------

1.4 i	Petrol	55	08/92 → 06/97
-------	--------	----	---------------

1.6 i	Petrol	65	02/96 → 06/97
-------	--------	----	---------------

ZX Break (N2)

1.4 i	Petrol	55	10/93 → 10/97
-------	--------	----	---------------

1.6 i	Petrol	65	02/96 → 10/97
-------	--------	----	---------------

PEUGEOT

106 I (1A, 1C)

1.0	Petrol	33	09/91 → 04/96
-----	--------	----	---------------

1.0	Petrol	37	09/91 → 04/96
-----	--------	----	---------------

1.1	Petrol	44	09/91 → 04/96
-----	--------	----	---------------

1.3	Petrol	72	10/93 → 04/96
-----	--------	----	---------------

1.4	Petrol	55	09/91 → 04/96
-----	--------	----	---------------

1.4	Petrol	69	09/91 → 04/96
-----	--------	----	---------------

1.6	Petrol	65	06/93 → 04/96
-----	--------	----	---------------

1.6	Petrol	76	01/94 → 04/96
-----	--------	----	---------------

SAG156

PEUGEOT
106 II (1)

1.0 i	Petrol	37	01/97 → 02/98
1.1 i	Petrol	40	01/97 → 02/98

306 (7B, N3, N5)

1.4 SL	Petrol	55	06/94 → 02/98
1.6 SR	Petrol	65	06/94 → 02/98

306 2 volumi /Coda spiovente (7A, 7C, N3, N5)

1.4	Petrol	55	05/93 → 02/98
1.6	Petrol	65	05/93 → 02/98

306 Break (7E, N3, N5)

1.4	Petrol	55	03/97 → 02/98
1.6	Petrol	65	03/97 → 02/98

405 II (4B)

1.4	Petrol	55	08/92 → 10/95
-----	--------	----	---------------

405 II Break (4E)

1.4	Petrol	55	08/92 → 10/96
-----	--------	----	---------------

RANCH MPV / Space wagon (5F)

1.1	Petrol	44	06/96 → 01/98
1.4	Petrol	55	06/96 → 01/98

SAG157
**H1 SENSORE GIRI / FASE - ALBERO MOTORE
CRANKSHAFT POSITION SENSOR**

CITROËN
C5 I (DC_)

1.8 16V (DC6FZB, DC6FZE)	Petrol	85	03/01 → 08/04
2.0 16V (DCRFNC, DCRFNF)	Petrol	100	03/01 → 04/02
2.0 16V HPi (DCRLZB)	Petrol	103	03/01 → 04/02
2.0 HDi (DCRHYP)	Diesel	66	03/01 → 08/04

SAG157

CITROËN
C5 I (DC_)

2.0 HDi (DCRHZB, DCRHZE)	Diesel	80	03/01 → 08/04
2.2 HDi (DC4HXB, DC4HXE)	Diesel	98	03/01 → 08/04

C5 I Break (DE_)

1.8 16V (DE6FZB, DE6FZE)	Petrol	85	06/01 → 08/04
2.0 16V (DERFNF, DERFNC, RERFNC)	Petrol	100	06/01 → 04/02
2.0 16V HPi (DERLZB)	Petrol	103	06/01 → 04/02
2.0 HDi (DERHSB, DERHSE)	Diesel	79	06/01 → 08/04
2.0 HDi (DERHYB)	Diesel	66	06/01 → 08/04
2.2 HDi (DE4HXB, DE4HXE)	Diesel	98	06/01 → 08/04

EVASION (22, U6)

2.0 16V	Petrol	100	05/00 → 12/00
---------	--------	-----	---------------

JUMPER Autobus (244, Z_)

2.0	Petrol	81	04/02 →
2.2 HDi	Diesel	74	04/02 →

JUMPER Furgonato (244)

2.0	Petrol	81	04/02 →
2.2 HDi	Diesel	74	04/02 →

JUMPER Pianale piatto/Telaio (244)

2.2 HDi	Diesel	74	04/02 →
---------	--------	----	---------

JUMPY (U6U)

2.0	Petrol	100	04/00 → 12/00
-----	--------	-----	---------------

XSARA (N1)

2.0 HDi 90	Diesel	66	09/00 → 03/05
------------	--------	----	---------------

XSARA Break (N2)

2.0 HDi 90	Diesel	66	09/00 → 08/05
------------	--------	----	---------------

XSARA Coupé (N0)

2.0 HDi 90	Diesel	66	09/00 → 03/05
------------	--------	----	---------------

XSARA PICASSO (N68)

2.0 HDi	Diesel	66	12/99 → 12/01
---------	--------	----	---------------

SAG157



KW



FIAT

DUCATO Autobus (230)

2.0 JTD Diesel 62 10/01 → 04/02

DUCATO Autobus (244, Z_)

2.0 Petrol 81 04/02 →

2.0 Bipower Petrol/CNG 81 11/02 →

2.0 JTD Diesel 62 04/02 → 08/06

DUCATO Furgonato (230L)

2.0 JTD Diesel 62 10/01 → 04/02

2.0 Petrol 81 04/02 →

2.0 Bipower Petrol/CNG 81 11/02 →

DUCATO Furgonato (244)

2.0 JTD Diesel 62 04/02 → 08/06

DUCATO Pianale piatto/Telaio (244)

2.0 JTD Diesel 62 04/02 → 07/06

SCUDO Combinato (220P)

2.0 16V Petrol 100 06/00 → 12/00

PEUGEOT

206 2 volumi /Coda spiovente (2A/C)

2.0 HDI 90 Diesel 66 12/99 → 05/02

206 SW (2E/K)

2.0 16V Petrol 100 07/02 →

307 (3A/C)

2.0 16V Petrol 100 08/00 → 05/05

2.0 HDI 90 Diesel 66 08/00 → 05/05

307 Break (3E)

2.0 Petrol 100 03/02 → 05/05

2.0 HDI 90 Diesel 66 03/02 → 05/05

307 SW (3H)

2.0 16V Petrol 100 03/02 → 05/05

2.0 HDI 90 Diesel 66 03/02 → 05/05

406 (8B)

1.8 16V Petrol 85 10/00 → 04/02

2.0 16V Petrol 100 08/00 → 03/02

2.0 16V HPi Petrol 103 05/01 → 05/04

2.0 HDi 110 Diesel 80 06/98 → 03/99

406 Break (8E/F)

1.8 16V Petrol 85 10/00 → 04/02

2.0 16V Petrol 100 10/00 → 03/02

2.0 16V HPi Petrol 103 05/01 → 10/04

2.0 HDi 110 Diesel 80 02/99 → 03/99

406 Coupé (8C)

2.0 16V Petrol 100 10/00 → 03/02

SAG157



KW



PEUGEOT

806 (221)

2.0 16V Petrol 100 09/00 → 08/02

BOXER Autobus (244, Z_)

2.0 Petrol 81 04/02 →

2.2 HDi Diesel 74 04/02 →

BOXER Furgonato (244)

2.0 Petrol 81 04/02 →

2.2 HDi Diesel 74 04/02 →

BOXER Pianale piatto/Telaio (244)

2.2 HDi Diesel 74 04/02 →

EXPERT (224)

2.0 Petrol 100 07/00 → 12/00

RANCH Furgonato (5)

2.0 HDi Diesel 66 04/00 → 08/02

RANCH MPV / Space wagon (5F)

2.0 HDi Diesel 66 02/00 → 08/02

SAG158

H1

SENSORE GIRI / FASE - ALBERO MOTORE
CRANKSHAFT POSITION SENSOR

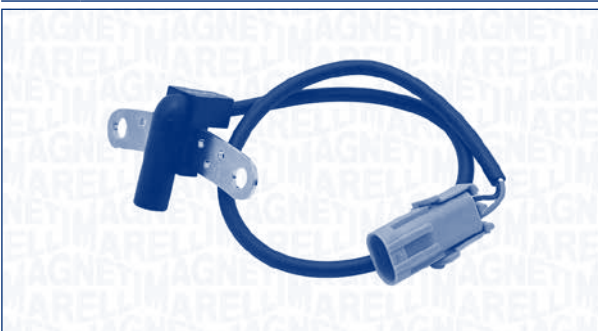

KW



RENAULT

CLIO I (B/C57_, 5/357_)

1.2 (5/357Y, 5/357K) Petrol 40 01/96 → 06/97

1.2 (B/C/S57A, B/C57S, 5/357F, 5/357J, 5/357L, 5/357R) Petrol 43 05/90 → 03/97

1.4 Petrol 59 01/91 → 12/97

1.4 (B57J, C57J) Petrol 55 01/91 → 03/97

1.8 16V (C57D) Petrol 99 01/91 → 03/96

Williams (B/C57M) Petrol 108 01/94 → 12/96

SAG158

RENAULT
ESPACE II (J/S63_)

2.0 (J636)	Petrol	76	01/91 → 10/96
2.2 (J/S637, J63G)	Petrol	79	01/91 → 10/96
2.8 V6 (J638, J63J)	Petrol	110	01/91 → 10/96

LAGUNA I (B56_, 556_)

1.8 (B56A/B)	Petrol	66	11/93 → 03/01
1.8 (B56S/T/O)	Petrol	66	08/95 → 03/01
1.8 (B56Z)	Petrol	69	08/95 → 03/01
3.0 (B56E/R, B565)	Petrol	123	11/93 → 03/01

LAGUNA I Grandtour (K56_)

1.8 (K56S/T/O)	Petrol	66	09/95 → 03/01
1.8 (K56Z)	Petrol	69	09/95 → 03/01
2.0 (K56C/H)	Petrol	83	09/95 → 03/01

MEGANE I (BA0/1_)

1.4 e (BA0E, BA0V)	Petrol	55	01/96 → 08/97
1.6 e (BA0F, BA0S)	Petrol	66	01/96 → 03/99
1.6 i (BA0L)	Petrol	55	01/96 → 08/97

RAPID Furgonato (F40_, G40_)

1.2 (F406, G40A)	Petrol	40	09/91 → 03/98
1.4 (F407) Cat.	Petrol	43	08/88 → 03/98

SAFRANE I (B54_)

2.0 (B540)	Petrol	77	11/92 → 07/96
2.0 12V (B542, B54E)	Petrol	97	04/92 → 07/96
2.2 (B541)	Petrol	79	04/92 → 07/96
2.2 (B543)	Petrol	101	04/92 → 07/96
3.0 Biturbo 4x4 (B545)	Petrol	193	02/93 → 07/96
3.0 V6 (B54B, B544)	Petrol	123	12/92 → 07/96

SAFRANE II (B54_)

3.0 V6 (B54M)	Petrol	123	07/96 → 12/00
---------------	--------	-----	---------------

SPORT SPIDER (EF0_)

2.0 16V	Petrol	110	03/95 → 10/99
---------	--------	-----	---------------

TWINGO I (C06_)

1.2 (C063, C064)	Petrol	40	03/93 → 10/96
------------------	--------	----	---------------

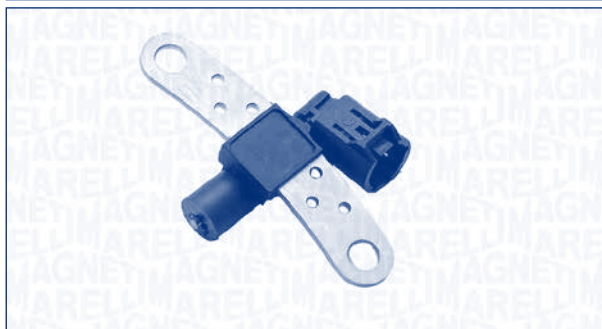
SAG159
**H1 SENSORE GIRI / FASE - ALBERO MOTORE
CRANKSHAFT POSITION SENSOR**

DACIA
LOGAN (LS_)

1.6 16V (LS0M)	Petrol	77	02/06 →
----------------	--------	----	---------

LOGAN MCV (KS_)

1.6 16V	Petrol	77	02/07 →
---------	--------	----	---------

OPEL
ARENA Combi (THB)

1.9 D	Diesel	44	03/98 → 08/01
-------	--------	----	---------------

ARENA Furgonato (TB, TF)

1.9 D	Diesel	44	03/98 → 08/01
-------	--------	----	---------------

RENAULT
CLIO II (BB0/1/2_, CB0/1/2_)

1.4 16V (B/CB0P)	Petrol	72	08/00 → 10/07
------------------	--------	----	---------------

1.6 16V (BB01, BB0H, BB0T, BB14, BB1D, BB1R, BB2KL...)	Petrol	79	09/98 →
--	--------	----	---------

1.9 D (B/CB0E)	Diesel	47	09/98 → 05/05
----------------	--------	----	---------------

CLIO II Furgonato (SB0/1/2_)

1.9 D (SB0E)	Diesel	47	09/98 →
--------------	--------	----	---------

KANGOO (KC0/1_)

D 55 1.9 (KC0D)	Diesel	40	08/97 →
-----------------	--------	----	---------

D 65 1.9 (KC0E, KC02, KC0J, KC0N)	Diesel	47	08/97 →
-----------------------------------	--------	----	---------

KANGOO Express (FC0/1_)

D 55 1.9 (FC0D)	Diesel	40	08/97 →
-----------------	--------	----	---------

D 65 1.9 (FC0E, FC02, FC0J, FC0N)	Diesel	47	08/97 →
-----------------------------------	--------	----	---------

LAGUNA I (B56_, 556_)

1.6 16V (B568, B561)	Petrol	79	11/97 → 03/01
----------------------	--------	----	---------------

LAGUNA I Grandtour (K56_)

1.6 16V (K568)	Petrol	79	11/97 → 03/01
----------------	--------	----	---------------

SAG159



KW



RENAULT

LAGUNA II (BG0/1_)

1.6 16V
(BG0A, BG0L) Petrol 79 03/01 →1.6 16V
(BG1G, BG1H) Petrol 82 02/05 →1.8 16V (BG0B,
BG0C, BG0J,
BG0M, BG0V) Petrol 89 03/01 →1.8 16V
(BG0B, BG0M) Petrol 88 03/01 →2.0 16V
(BG00, BG0K,
BG0P, BG0W) Petrol 99 08/02 →2.0 16V IDE
(BG0N) Petrol 103 04/01 →

LAGUNA II Grandtour (KG0/1_)

1.6 16V Petrol 82 02/05 →

1.6 16V
(KG0A, KG0L) Petrol 79 03/01 →

1.8 16V Petrol 89 03/01 →

1.8 16V
(KG0B, KG0M) Petrol 88 03/01 →2.0 16V (KG00,
KG0K, KG0W) Petrol 99 08/02 →2.0 16V IDE
(KG0N) Petrol 103 04/01 →

MEGANE I (BA0/1_)

1.4 16V
(BA0D, BA1H,
BA0W, BA10) Petrol 70 03/99 → 08/031.4 e
(BA0E, BA0V) Petrol 55 01/96 → 08/031.6 e
(BA0F, BA0S) Petrol 66 05/98 → 03/99

1.6 i (BA0L) Petrol 55 05/98 → 03/99

1.8 16V (BA06,
BA12, BA1A,
BA1M, BA1R) Petrol 85 01/01 → 08/03

MEGANE I Cabriolet (EA0/1_)

1.4 16V
(EA0D, EA1H,
EA0W, EA10) Petrol 70 03/99 → 08/03

SAG159



KW



RENAULT

MEGANE I Classic (LA0/1_)

1.4 16V
(LA0D, LA1H,
IA0W, LA10) Petrol 70 03/99 → 08/031.8 16V (LA06,
LA12, LA1A,
LA1M, LA1R) Petrol 85 01/01 → 08/03

MEGANE I Coach (DA0/1_)

1.4 16V
(DA0D, DA1H,
DA0W, DA10) Petrol 70 03/99 → 08/03

1.6 e (DA0F) Petrol 66 05/98 → 03/99

MEGANE I Grandtour (KA0/1_)

1.4 16V
(KA0D, KA1H,
KA0W, KA10) Petrol 70 03/99 → 08/03

1.4 e (KA0V) Petrol 55 03/99 → 08/03

1.8 16V (KA0S,
KA12, KA1A,
KA1M, KA1R) Petrol 85 01/01 → 08/03

MEGANE II (BM0/1_, CM0/1_)

1.4 16V (BM0B,
CM0B) Petrol 72 11/02 →

MEGANE II Station wagon (KM0/1_)

1.4 Petrol 72 08/03 →

MEGANE II Tre volumi (LM0/1_)

1.4 Petrol 72 09/03 →

SCÉNIC I (JA0/1_)

1.4 16V
(JA0D, JA1H,
Ja0W, JA10) Petrol 70 09/99 → 08/03

2.0 16V RX4 Petrol 102 06/00 → 08/03

SCÉNIC II (JM0/1_)

1.4 (JM0B,
JM0H, JM1A) Petrol 72 06/03 →

THALIA I (LB0/1/2_)

1.4 16V Petrol 72 08/00 →

1.6 16V Petrol 79 04/02 →

TRAFIC Autobus (TXW)

1.9 D Diesel 44 06/97 → 03/01

TRAFIC Furgonato (TXX)

1.9 D Diesel 44 06/97 → 03/01

VAUXHALL

ARENA Combi

1.9 D Diesel 44 03/98 → 08/01

SAG159

VAUXHALL
ARENA Van

1.9 D	Diesel	44	03/98 → 08/01
-------	--------	----	---------------

SAG160
H1 **SENSORE GIRI / FASE - ALBERO MOTORE
CRANKSHAFT POSITION SENSOR**

DACIA
DUSTER

1.6 16V	Petrol	77	04/10 →
---------	--------	----	---------

RENAULT
CLIO II (BB0/1/2_, CB0/1/2_)

1.9 D (B/CB0J)	Diesel	48	02/00 → 05/01
----------------	--------	----	---------------

2.0 16V Sport	Petrol	132	01/04 →
---------------	--------	-----	---------

CLIO II Furgonato (SB0/1/2_)

1.9 D (SB0J)	Diesel	48	02/00 → 05/01
--------------	--------	----	---------------

GRAND SCÉNIC II (JM0/1_)

1.6	Petrol	83	04/04 → 04/09
-----	--------	----	---------------

KANGOO (KC0/1_)

1.6 16V	Petrol	70	06/01 → 12/07
---------	--------	----	---------------

1.6 16V 4x4 (KC0P, KC0S, KC0L)	Petrol	70	10/01 → 12/07
--------------------------------------	--------	----	---------------

KANGOO / GRAND KANGOO (KW0/1_)

1.6 16V Hi-Flex	BiFuel	78	02/08 →
-----------------	--------	----	---------

1.6 16V (KW0D)	Petrol	78	02/08 →
----------------	--------	----	---------

KANGOO BE BOP (KW0/1_)

1.6 (KW0D)	Petrol	78	02/09 →
------------	--------	----	---------

KANGOO Express (FC0/1_)

1.6 16V 4x4 (FC0L, FC0P, FC0S)	Petrol	70	10/01 → 12/07
--------------------------------------	--------	----	---------------

1.9 D (FC0J)	Diesel	48	09/99 → 06/03
--------------	--------	----	---------------

SAG160

RENAULT
KANGOO Express (FW0/1_)

1.6 16V	Petrol	78	02/08 →
---------	--------	----	---------

1.6 16V LPG	Petrol/ LPG	72	02/08 →
-------------	----------------	----	---------

LAGUNA II (BG0/1_)

1.8 16V (BG06, BG0J, BG0M)	Petrol	85	03/01 → 09/07
-------------------------------	--------	----	---------------

2.0 16V (BG00, BG0K, BG0P, BG0W)	Petrol	99	08/02 → 09/07
--	--------	----	---------------

LAGUNA II Grandtour (KG0/1_)

1.8 16V (KG0J)	Petrol	85	03/01 → 09/07
----------------	--------	----	---------------

2.0 16V (KG00, KG0K, KG0W)	Petrol	99	08/02 → 09/07
-------------------------------	--------	----	---------------

LOGAN (LS_)

1.6	Petrol	77	04/07 →
-----	--------	----	---------

LOGAN Station wagon (KS_)

1.6	Petrol	77	04/07 →
-----	--------	----	---------

MEGANE I (BA0/1_)

1.6 i (BA0L)	Petrol	55	01/96 → 03/99
--------------	--------	----	---------------

MEGANE I Coach (DA0/1_)

1.6 e (DA0F)	Petrol	66	03/96 → 03/99
--------------	--------	----	---------------

MEGANE II (BM0/1_, CM0/1_)

1.4 16V	Petrol	60	10/03 →
---------	--------	----	---------

1.4 16V (BM0B, CM0B)	Petrol	72	11/02 → 10/08
-------------------------	--------	----	---------------

1.6	Petrol	77	06/05 →
-----	--------	----	---------

1.6 16V	Petrol	82	01/06 →
---------	--------	----	---------

MEGANE II Coupé-Cabriolet (EM0/1_)

1.6	Petrol	83	10/03 →
-----	--------	----	---------

MEGANE II Station wagon (KM0/1_)

1.4	Petrol	72	10/03 → 05/09
-----	--------	----	---------------

1.6	Petrol	83	10/03 → 05/09
-----	--------	----	---------------

1.6 16V	Petrol	82	01/06 → 05/09
---------	--------	----	---------------

MEGANE II Tre volumi (LM0/1_)

1.4	Petrol	72	10/03 →
-----	--------	----	---------

1.6	Petrol	83	10/03 →
-----	--------	----	---------

1.6 16V	Petrol	82	01/06 →
---------	--------	----	---------

MEGANE III 2 volumi /Coda spiovente (BZ0_)

1.6 16V (BZ0H)	Petrol	74	11/08 →
----------------	--------	----	---------

MEGANE III Coupé (DZ0/1_)

1.6 16V (DZ0H)	Petrol	74	11/08 →
----------------	--------	----	---------

MEGANE III Grandtour (KZ0/1)

1.6 16V (KZ0H)	Petrol	74	05/09 →
----------------	--------	----	---------

SAG160



RENAULT

SCÉNIC II (JM0/1_)

1.6 (JM0C, JM0J, JM1B)	Petrol	83	06/03 → 04/09
1.6 16V (JM1R)	Petrol	82	01/07 →

SAG161

H1 **SENSORE GIRI / FASE - ALBERO MOTORE**
CRANKSHAFT POSITION SENSOR



DACIA

LOGAN (LS_)

1.5 dCi (LS0J, LS0Y)	Diesel	48	09/05 →
----------------------	--------	----	---------

NISSAN

ALMERA II (N16)

1.5 dCi	Diesel	60	01/03 →
---------	--------	----	---------

ALMERA II Hatchback (N16)

1.5 dCi	Diesel	60	01/03 →
---------	--------	----	---------

KUBISTAR (X76)

1.5 dCi	Diesel	42	08/03 →
---------	--------	----	---------

1.5 dCi	Diesel	48	08/03 →
---------	--------	----	---------

1.5 dCi	Diesel	60	08/03 →
---------	--------	----	---------

MICRA III (K12)

1.5 dCi	Diesel	48	01/03 → 06/10
---------	--------	----	---------------

1.5 dCi	Diesel	60	09/03 → 06/10
---------	--------	----	---------------

RENAULT

CLIO II (BB0/1/2_, CB0/1/2_)

1.5 dCi (B/CB07)	Diesel	48	06/01 →
------------------	--------	----	---------

1.5 dCi (B/CB08)	Diesel	60	06/01 →
------------------	--------	----	---------

1.9 dTi (B/CB0U)	Diesel	59	12/99 → 05/05
------------------	--------	----	---------------

CLIO II Furgonato (SB0/1/2_)

1.5 dCi (SB07)	Diesel	48	06/01 →
----------------	--------	----	---------

KANGOO (KC0/1_)

1.5 dCi (KC07)	Diesel	48	12/01 →
----------------	--------	----	---------

SAG161



RENAULT

KANGOO (KC0/1_)

1.5 dCi (KC08, KC09)	Diesel	60	07/02 →
----------------------	--------	----	---------

1.9 dTi (KC0U)	Diesel	59	02/00 →
----------------	--------	----	---------

KANGOO Express (FC0/1_)

1.5 dCi (FC07, FC1R)	Diesel	48	12/01 →
----------------------	--------	----	---------

1.5 dCi (FC08, FC09)	Diesel	60	04/03 →
----------------------	--------	----	---------

1.9 dTi (FC0U)	Diesel	59	02/00 →
----------------	--------	----	---------

MEGANE I (BA0/1_)

1.9 D Eco (B/SA0U, BA0A)	Diesel	47	06/98 → 08/03
--------------------------	--------	----	---------------

1.9 dTi (BA08, BA0N)	Diesel	72	07/98 → 02/01
----------------------	--------	----	---------------

MEGANE I Classic (LA0/1_)

1.9 dTi (LA08, LA0N)	Diesel	72	07/98 → 02/01
----------------------	--------	----	---------------

1.9 dTi (LA1U)	Diesel	59	02/01 → 08/03
----------------	--------	----	---------------

MEGANE I Coach (DA0/1_)

1.9 dTi (DA0N)	Diesel	72	07/98 → 02/01
----------------	--------	----	---------------

MEGANE I Grandtour (KA0/1_)

1.9 D (KA0J, KA0R)	Diesel	47	04/99 → 08/03
--------------------	--------	----	---------------

1.9 dTi (KA1U)	Diesel	59	02/01 → 08/03
----------------	--------	----	---------------

MEGANE II (BM0/1_, CM0/1_)

1.5 dCi (BM0F, CM0F)	Diesel	60	11/02 →
----------------------	--------	----	---------

MEGANE II Station wagon (KM0/1_)

1.5 dCi	Diesel	60	08/03 →
---------	--------	----	---------

MEGANE II Tre volumi (LM0/1_)

1.5 dCi	Diesel	60	09/03 →
---------	--------	----	---------

MEGANE Scenic (JA0/1_)

1.9 dTi (JA0N)	Diesel	72	07/98 → 09/99
----------------	--------	----	---------------

MODUS / GRAND MODUS (F/JP0_)

1.5 dCi (FP0F, JP0F)	Diesel	63	12/04 →
----------------------	--------	----	---------

1.5 dCi (FP0G, JP0G)	Diesel	50	12/04 →
----------------------	--------	----	---------

SCÉNIC I (JA0/1_)

1.9 dCi RX4	Diesel	75	11/00 → 08/03
-------------	--------	----	---------------

1.9 dTi (JA1U)	Diesel	59	02/01 → 08/03
----------------	--------	----	---------------

SCÉNIC II (JM0/1_)

1.5 dCi (JM0F)	Diesel	60	06/03 →
----------------	--------	----	---------

SAG161

RENAULT
THALIA I (LB0/1/2_)

1.5 dCi	Diesel	48	04/02 →
1.5 dCi	Diesel	60	06/01 →

SUZUKI
SAMURAI (SJ)

1.9 D	Diesel	46	09/00 → 12/04
1.9 TD	Diesel	47	11/98 → 12/04

SAG163
H1 **SENSORE GIRI / FASE - ALBERO MOTORE
CRANKSHAFT POSITION SENSOR**

DACIA
LOGAN (LS_)

1.4 (LSOA, LSOC, LSOE, LSOG)	Petrol	55	09/04 →
------------------------------------	--------	----	---------

1.6 (LSOB, LSOD, LSOF, LSOH)	Petrol	64	09/04 →
------------------------------------	--------	----	---------

NISSAN
KUBISTAR (X76)

1.2 16V	Petrol	55	04/06 →
---------	--------	----	---------

RENAULT
CLIO I (B/C57_, 5/357_)

1.2 (5/357Y, 5/357K)	Petrol	40	07/97 → 09/98
-------------------------	--------	----	---------------

1.2 (B/C/S57A, B/C57S, 5/357F, 5/357J, 5/357L, 5/357R)	Petrol	43	04/97 → 09/98
---	--------	----	---------------

1.2 (B/C57R)	Petrol	40	01/91 → 06/96
--------------	--------	----	---------------

1.4 (B57J, C57J)	Petrol	55	04/97 → 09/98
------------------	--------	----	---------------

CLIO I Furgonato (S57_)

1.2	Petrol	40	01/91 → 09/98
-----	--------	----	---------------

SAG163

RENAULT
CLIO II (BB0/1/2_, CB0/1/2_)

1.2 (BB0A, BB0F, BB10, BB1K, BB28, BB2D, BB2H, CB0A...)	Petrol	43	09/98 →
--	--------	----	---------

1.2 16V (BB05, BB0W, BB11, BB27, BB2T, BB2U, BB2V, CB05...)	Petrol	55	06/01 →
---	--------	----	---------

CLIO II Furgonato (SB0/1/2_)

1.1 (SB0A, SB0F, SB1K, SB2D)	Petrol	43	09/98 →
---------------------------------	--------	----	---------

CLIO III (BR0/1, CR0/1)

1.2 16V	Petrol	58	06/05 →
---------	--------	----	---------

1.2 16V (BR02, BR0J, BR11, CR02, CR0J, CR11)	Petrol	55	06/05 →
---	--------	----	---------

KANGOO (KC0/1_)

1.2 (KC0A, KC0K, KC0F, KC01)	Petrol	43	08/97 →
------------------------------------	--------	----	---------

1.2 16V (KC03, KC05, KC06, KC0T, KC0W)	Petrol	55	06/01 →
--	--------	----	---------

KANGOO Express (FC0/1_)

1.2 (FC01, FC0A, FC0F)	Petrol	43	08/97 →
---------------------------	--------	----	---------

1.2 16V (FC05)	Petrol	55	10/01 →
----------------	--------	----	---------

MEGANE I (BA0/1_)

1.4 e (BA0E, BA0V)	Petrol	55	09/97 → 04/98
-----------------------	--------	----	---------------

1.6 e (BA0F, BA0S)	Petrol	66	09/97 → 04/98
-----------------------	--------	----	---------------

1.6 i (BA0L)	Petrol	55	09/97 → 04/98
--------------	--------	----	---------------

MEGANE I Coach (DA0/1_)

1.6 e (DA0F)	Petrol	66	09/97 → 04/98
--------------	--------	----	---------------

MODUS / GRAND MODUS (F/JP0_)

1.2 (JP0C, JP0K, FP0C, FP0K, FPOP, JP0P, JP0T)	Petrol	55	12/04 →
---	--------	----	---------

SAG163



RENAULT

RAPID Furgonato (F40_, G40_)

1.4 (F40U, F40V) Petrol 55 09/91 → 03/98

THALIA I (LB0/1/2_)

1.2 16V Petrol 55 04/02 →

1.4 Petrol 55 08/00 →

TWINGO I (C06_)

1.2 16V (C060) Petrol 44 08/04 →

1.2 16V (C06C, C06D, C06K) Petrol 55 01/01 →

SAG164

H1

SENSORE GIRI / FASE - ALBERO MOTORE
CRANKSHAFT POSITION SENSOR

CITROËN

BERLINGO (MF)

1.4 bivalent Petrol/CNG 48 11/02 →

1.4 i bivalent a(MFKFW) BiFuel 55 04/03 →

1.6 16V (MFNFU) Petrol 80 11/02 →

BERLINGO Furgonato (M_)

1.4 bivalent Petrol/CNG 48 11/02 →

1.4 i bivalent (MBKFW) BiFuel 55 04/03 →

1.6 16V (MBNFU) Petrol 80 11/02 →

C2 (JM_)

1.1 Petrol 44 09/03 →

1.4 Petrol 54 09/03 →

1.4 16V Petrol 65 06/06 →

1.6 Petrol 80 09/03 →

1.6 VTS Petrol 90 01/05 →

SAG164



RENAULT

C3 I (FC_)

1.1 i Petrol 44 02/02 →

1.4 16V Petrol 65 12/03 →

1.4 i Bivalent Petrol/CNG 54 02/02 →

1.6 16V Petrol 80 02/02 →

C3 Pluriel (HB_)

1.4 Petrol 54 05/03 →

1.6 Petrol 80 05/03 →

C4 Coupé (LA_)

1.4 16V Petrol 65 11/04 →

C4 I (LC_)

1.4 16V Petrol 65 11/04 →

NEMO Furgonato (AA_)

1.4 Petrol 54 02/08 →

SAXO (S0, S1)

1.1 X,SX Petrol 44 03/00 → 09/03

1.6 VTS Petrol 72 09/00 → 09/03

XSARA (N1)

1.4 i Petrol 55 09/00 → 03/05

XSARA Break (N2)

1.4 i Petrol 55 09/00 → 08/05

XSARA Coupé (N0)

1.4 i Petrol 55 09/00 → 03/05

FIAT

FIORINO Cassone / Furgonato / Promiscuo (225)

1.4 Petrol 54 11/07 →

QUBO (225)

1.4 Petrol 54 02/08 →

PEUGEOT

1007 (KM_)

1.4 Petrol 54 04/05 →

1.4 16V Petrol 65 10/05 →

1.6 16V Petrol 80 04/05 →

206 2 volumi /Coda spiovente (2A/C)

1.1 i Petrol 44 03/00 →

1.4 16V Petrol 65 10/03 →

1.4 i Petrol 55 03/00 →

1.6 16V Petrol 80 12/00 →

206 CC (2D)

1.6 16V Petrol 80 09/00 →

206 SW (2E/K)

1.1 Petrol 44 07/02 →

1.4 Petrol 55 07/02 →

1.4 16V Petrol 65 10/03 →

SAG164

RENAULT
206 SW (2E/K)

1.6 16V Petrol 80 07/02 →

207 (WA_, WC_)

1.4 Petrol 53 02/06 →

1.4 16V Petrol 65 02/06 →

1.6 16V Petrol 80 02/06 →

306 (7B, N3, N5)

1.4 SL Petrol 55 10/00 → 05/01

306 2 volumi /Coda spiovente (7A, 7C, N3, N5)

1.4 Petrol 55 10/00 → 05/01

306 Break (7E, N3, N5)

1.4 Petrol 55 10/00 → 04/02

307 (3A/C)

1.4 Petrol 55 08/00 →

1.4 16V Petrol 65 11/03 →

2.0 16V Petrol 103 03/05 →

307 Break (3E)

1.4 Petrol 55 04/02 → 09/03

1.4 16V Petrol 65 11/03 →

2.0 16V Petrol 103 03/05 →

307 CC (3B)

2.0 16V Petrol 103 03/05 →

307 SW (3H)

1.4 Petrol 55 04/02 → 09/03

1.4 16V Petrol 65 11/03 →

2.0 16V Petrol 103 03/05 →

BIPPER (AA_)

1.4 Petrol 54 02/08 →

RANCH Furgonato (5)

 1.4 BiFuel Petrol/
CNG 55 04/03 →

RANCH MPV / Space wagon (5F)

1.1 Petrol 44 09/00 →

1.4 Petrol 55 09/00 →

1.6 16V Petrol 80 09/02 →

SAG166
H1
**SENSORE GIRI / FASE - ALBERO MOTORE
CRANKSHAFT POSITION SENSOR**

AUDI
A3 (8P1)

1.6 FSI Petrol 85 08/03 → 09/07

1.9 TDI Diesel 77 05/03 → 05/10

2.0 TDi Diesel 103 06/05 → 06/08

2.0 TDi Diesel 100 05/03 → 08/12

2.0 TDi Diesel 125 03/06 → 08/12

2.0 TDi 16V Diesel 103 05/03 → 08/12

2.0 TDi 16V quattro Diesel 103 08/04 → 08/12

2.0 TDi quattro Diesel 103 01/06 → 06/08

2.0 TDi quattro Diesel 125 03/06 → 08/12

2.0 TDi quattro Diesel 100 05/03 → 06/08

A3 Cabriolet (8P7)

1.9 TDI Diesel 77 04/08 → 10/09

A3 Sportback (8PA)

1.6 FSI Petrol 85 09/04 → 09/07

1.9 TDI Diesel 77 09/04 → 05/10

2.0 TDi Diesel 103 06/05 → 06/08

2.0 TDi Diesel 125 03/06 → 03/13

2.0 TDi 16V Diesel 103 09/04 → 03/13

2.0 TDi 16V quattro Diesel 103 11/05 → 03/13

2.0 TDi quattro Diesel 103 01/06 → 06/08

2.0 TDi quattro Diesel 125 03/06 → 03/13

A4 (8EC, B7)

2.0 TDi Diesel 100 11/04 → 06/08

2.0 TDi Diesel 125 06/06 → 06/08

2.0 TDi 16V Diesel 103 11/04 → 06/08

2.0 TDi quattro Diesel 125 06/06 → 06/08

A4 Avant (8ED, B7)

2.0 TDi Diesel 100 11/04 → 06/08

2.0 TDi Diesel 125 06/06 → 06/08

2.0 TDi 16V Diesel 103 11/04 → 06/08

2.0 TDi quattro Diesel 125 06/06 → 06/08

SAG166



KW



AUDI

A6 (4F2, C6)

2.0 TDi	Diesel	103	07/04 → 10/08
2.0 TDi	Diesel	100	07/04 → 03/11

A6 Avant (4F5, C6)

2.0 TDi	Diesel	103	06/05 → 10/08
2.0 TDi	Diesel	89	09/05 → 06/06
2.0 TDi	Diesel	100	06/05 → 08/11

MITSUBISHI

GRANDIS (NA_W)

2.0 DI-D	Diesel	100	09/05 →
----------	--------	-----	---------

OUTLANDER II (CW_W)

2.0 DI-D	Diesel	103	02/07 → 11/12
----------	--------	-----	---------------

SEAT

ALHAMBRA (7V8, 7V9)

2.0 TDi	Diesel	103	11/05 → 03/10
---------	--------	-----	---------------

ALTEA (5P1)

1.4 16V	Petrol	63	05/06 →
1.9 TDi	Diesel	77	04/04 →
2.0 TDi	Diesel	103	11/05 →
2.0 TDi	Diesel	100	03/04 → 05/09
2.0 TDi	Diesel	125	03/06 →
2.0 TDi 16V	Diesel	103	03/04 →

ALTEA XL (5P5, 5P8)

1.4 16V	Petrol	63	10/06 →
1.9 TDi	Diesel	77	10/06 →
2.0 TDi	Diesel	103	10/06 →
2.0 TDi	Diesel	125	06/07 →
2.0 TDi 16V	Diesel	103	10/06 →
2.0 TDi 4x4	Diesel	103	06/07 →
2.0 TDi 4x4	Diesel	125	06/07 →

CORDOBA (6L2)

1.4 16V	Petrol	63	05/06 → 11/09
1.4 16V	Petrol	55	09/02 → 12/07
1.4 TDi	Diesel	59	06/05 → 11/09
1.9 TDi	Diesel	74	09/02 → 11/09

IBIZA IV (6L1)

1.4 16V	Petrol	55	02/02 → 12/07
1.4 TDi	Diesel	59	06/05 → 11/09
1.9 TDi	Diesel	74	02/02 → 11/09

IBIZA V (6J5)

1.4	Petrol	63	03/08 →
1.4 TDi	Diesel	59	07/08 → 06/10

IBIZA V SPORTCOUPE (6J1)

1.4	Petrol	63	07/08 →
1.4 TDi	Diesel	59	07/08 → 06/10

SAG166



KW



SEAT

LEON (1P1)

1.4 16V	Petrol	63	06/06 →
1.9 TDi	Diesel	66	06/07 →
1.9 TDi	Diesel	77	07/05 →
2.0 TDi	Diesel	103	10/05 →
2.0 TDi	Diesel	125	05/06 →
2.0 TDi	Diesel	100	07/05 → 05/10
2.0 TDi 16V	Diesel	103	07/05 →

TOLEDO III (5P2)

1.9 TDi	Diesel	77	10/04 → 05/09
2.0 TDi	Diesel	100	09/04 → 05/09
2.0 TDi	Diesel	103	11/05 → 05/09
2.0 TDi	Diesel	125	01/06 → 05/09
2.0 TDi 16V	Diesel	103	04/04 → 05/09

SKODA

FABIA

1.4 TDi	Diesel	59	01/07 →
1.9 TDi	Diesel	77	04/07 →

FABIA (6Y2)

1.4 16V	Petrol	55	12/99 → 03/08
---------	--------	----	---------------

FABIA Combi

1.4 TDi	Diesel	59	10/07 →
1.9 TDi	Diesel	77	10/07 →

FABIA Combi (6Y5)

1.4 16V	Petrol	59	04/06 → 12/07
1.4 16V	Petrol	55	05/00 → 12/07

FABIA Tre volumi (6Y3)

1.4 16V	Petrol	59	04/06 → 12/07
1.4 16V	Petrol	55	10/99 → 12/07

OCTAVIA (1Z3)

1.4	Petrol	55	05/04 → 05/06
1.6 FSI	Petrol	85	02/04 → 10/08
1.9 TDi	Diesel	77	06/04 → 12/10
2.0 TDi	Diesel	103	11/05 →
2.0 TDi	Diesel	100	02/04 → 05/10
2.0 TDi 16V	Diesel	103	02/04 →

OCTAVIA Combi (1Z5)

1.6 FSI	Petrol	85	02/04 → 10/08
1.9 TDi	Diesel	77	09/04 → 12/10
1.9 Tdi 4x4	Diesel	77	11/04 → 12/10
2.0 TDi	Diesel	103	11/05 →
2.0 TDi 16V	Diesel	103	02/04 →
2.0 TDi 16V	Diesel	100	02/04 → 05/10
2.0 TDi 4x4	Diesel	103	07/06 →

SAG166

SKODA
ROOMSTER (5J)

1.4	Petrol	63	09/06 →	
1.4 TDI	Diesel	59	09/06 → 03/10	
1.6	Petrol	77	09/06 →	CHASSIS: → 5J75011488
1.9 TDI	Diesel	77	09/06 → 03/10	

ROOMSTER Praktik (5J)

1.4 TDI	Diesel	59	03/07 → 03/10	
---------	--------	----	---------------	--

SUPERB (3T4)

1.9 TDI	Diesel	77	03/08 →	
2.0 TDi	Diesel	103	03/08 →	

VOLKSWAGEN
CADDY III Furgonato (2KA, 2KH, 2CA, 2CH)

1.4	Petrol	55	03/04 → 05/06	
1.4 16V	Petrol	59	05/06 → 08/10	
1.9 TDI	Diesel	77	04/04 → 08/10	
1.9 TDI	Diesel	55	09/05 → 08/10	
2.0 SDI	Diesel	51	03/04 → 08/10	
2.0 TDi	Diesel	103	09/07 → 08/10	

CADDY III Station wagon (2KB, 2KJ, 2CB, 2CJ)

1.4	Petrol	55	03/04 → 05/06	
1.4 16V	Petrol	59	05/06 → 08/10	
1.9 TDI	Diesel	55	09/05 → 08/10	
1.9 TDI	Diesel	77	04/04 → 08/10	
1.9 TDI 4motion	Diesel	77	05/08 → 08/10	
2.0 SDI	Diesel	51	03/04 → 08/10	
2.0 TDi	Diesel	103	09/07 → 08/10	

CRAFTER 30-35 Autobus (2E_)

2.5 TDI	Diesel	120	04/06 → 07/11	
2.5 TDI	Diesel	65	04/06 → 07/11	
2.5 TDI	Diesel	100	04/06 →	
2.5 TDI	Diesel	80	04/06 →	

CRAFTER 30-50 Furgonato (2E_)

2.5 TDI	Diesel	120	04/06 → 07/11	
2.5 TDI	Diesel	65	04/06 → 07/11	
2.5 TDI	Diesel	100	04/06 →	
2.5 TDI	Diesel	80	04/06 →	

CRAFTER 30-50 Pianale piatto/Telaio (2F_)

2.5 TDI	Diesel	120	04/06 → 07/11	
2.5 TDI	Diesel	65	04/06 → 07/11	
2.5 TDI	Diesel	100	04/06 →	
2.5 TDI	Diesel	80	04/06 →	

EOS (1F7, 1F8)

1.6 FSI	Petrol	85	06/06 → 05/08	
2.0 TDi	Diesel	103	06/06 → 05/08	

SAG166

VOLKSWAGEN
FOX (5Z1, 5Z3)

1.4	Petrol	55	04/05 →	
-----	--------	----	---------	--

GOLF PLUS (5M1, 521)

1.4 16V	Petrol	55	01/05 →	
1.4 FSI	Petrol	66	07/05 →	
1.4 TSI	Petrol	90	06/07 →	
1.6 FSI	Petrol	85	01/05 → 05/08	
1.9 TDI	Diesel	66	05/05 → 12/08	
1.9 TDI	Diesel	77	01/05 → 01/09	
2.0 TDi	Diesel	100	05/05 →	
2.0 TDi	Diesel	103	12/05 → 05/09	
2.0 TDI 16V	Diesel	103	01/05 →	

GOLF V (1K1)

1.4 16V	Petrol	55	10/03 → 05/06	
1.4 FSI	Petrol	66	10/03 → 07/06	
1.6 FSI	Petrol	85	10/03 → 07/08	
1.9 TDI	Diesel	66	05/04 → 11/08	
1.9 TDI	Diesel	77	10/03 → 11/08	
1.9 TDI 4motion	Diesel	77	08/04 → 11/08	
2.0 SDI	Diesel	55	01/04 → 11/08	
2.0 TDi	Diesel	103	12/04 → 11/08	
2.0 TDi	Diesel	100	10/03 → 11/08	
2.0 TDi	Diesel	125	11/05 → 11/08	
2.0 TDI 16V	Diesel	103	10/03 → 11/08	
2.0 TDI 16V 4motion	Diesel	103	08/04 → 11/08	
2.0 TDI 4motion	Diesel	103	08/04 → 11/08	

GOLF V Variant (1K5)

1.4 TSI	Petrol	103	06/07 → 07/09	
1.4 TSI	Petrol	125	06/07 → 07/09	
1.9 TDI	Diesel	77	06/07 → 07/09	
1.9 TDI 4motion	Diesel	77	01/08 → 07/09	
2.0 TDi	Diesel	103	06/07 → 07/09	
2.0 TDi	Diesel	100	06/07 → 07/09	
2.0 TDI 16V	Diesel	103	06/07 → 07/09	
2.0 TDI 4motion	Diesel	100	06/07 → 07/09	

JETTA III (1K2)

1.4 TSI	Petrol	90	05/07 → 10/10	
1.6 FSI	Petrol	85	09/05 → 10/10	
1.9 TDI	Diesel	77	08/05 → 10/10	
2.0 TDi	Diesel	100	09/05 → 10/10	

MULTIVAN V (7HM, 7HN, 7HF, 7EF, 7EM, 7EN)

1.9 TDI	Diesel	62	01/06 → 11/09	
1.9 TDI	Diesel	75	06/06 → 11/09	

SAG166



VOLKSWAGEN

PASSAT (3C2)

1.6 FSI	Petrol	85	03/05 → 06/08
1.9 TDI	Diesel	77	03/05 → 11/08
2.0 TDi	Diesel	103	03/05 → 05/09
2.0 TDi	Diesel	125	08/05 → 07/10
2.0 TDi	Diesel	100	03/05 → 11/10
2.0 TDi 16V	Diesel	103	03/05 → 07/10
2.0 TDi 16V 4motion	Diesel	103	03/05 → 08/10
2.0 TDi 4motion	Diesel	103	03/05 → 05/09

PASSAT Variant (3C5)

1.6 FSI	Petrol	85	08/05 → 06/08
1.9 TDI	Diesel	77	08/05 → 11/08
2.0 TDi	Diesel	103	08/05 → 05/09
2.0 TDi	Diesel	125	08/05 → 11/10
2.0 TDi	Diesel	90	08/05 → 02/06
2.0 TDi	Diesel	100	08/05 → 11/10
2.0 TDi 16V	Diesel	103	08/05 → 11/10
2.0 TDi 16V 4motion	Diesel	103	08/05 → 11/10
2.0 TDi 4motion	Diesel	103	08/05 → 05/09

POLO (9N_)

1.4 16V	Petrol	55	10/01 → 05/08
1.4 16V	Petrol	59	05/06 → 11/09
1.4 FSI	Petrol	63	02/02 → 07/06
1.4 TDI	Diesel	51	04/05 → 11/09
1.4 TDI	Diesel	59	04/05 → 11/09
1.9 TDI	Diesel	74	10/01 → 11/09

POLO Tre volumi (9A4)

1.4	Petrol	74	11/03 →
-----	--------	----	---------

SHARAN (7M8, 7M9, 7M6)

2.0 TDi	Diesel	103	11/05 → 03/10
---------	--------	-----	---------------

TOURAN (1T1, 1T2)

1.6 FSI	Petrol	85	02/03 → 01/07
1.9 TDI	Diesel	74	02/03 → 05/04
1.9 TDI	Diesel	77	08/03 → 05/10
1.9 TDI	Diesel	66	11/04 → 05/10
2.0 FSI	Petrol	110	10/03 → 11/05
2.0 TDi	Diesel	103	12/05 → 05/10
2.0 TDi	Diesel	100	02/03 → 05/10
2.0 TDi	Diesel	125	12/05 → 05/10
2.0 TDi 16V	Diesel	103	08/03 → 05/10

TRANSPORTER V Autobus (7HB, 7HJ, 7EB, 7EJ, 7EF)

1.9 TDI	Diesel	62	01/06 → 11/09
1.9 TDI	Diesel	75	06/06 → 11/09

SAG166



VOLKSWAGEN

TRANSPORTER V Furgonato (7HA, 7HH, 7EA, 7EH)

1.9 TDI	Diesel	62	01/06 → 11/09
1.9 TDI	Diesel	75	06/06 → 11/09

TRANSPORTER V Pianale piatto/Telaio (7JD, 7JE, 7JL, 7JY, 7JZ)

1.9 TDI	Diesel	62	01/06 → 11/09
1.9 TDI	Diesel	75	06/06 → 11/09

SAG167

H1 **SENSORE GIRI / FASE - ALBERO MOTORE**
CRANKSHAFT POSITION SENSOR



CITROËN

BERLINGO (B9)

1.6 HDi 110	Diesel	80	04/08 →
1.6 HDi 75	Diesel	55	04/08 →
1.6 HDi 90	Diesel	66	04/08 →

BERLINGO (MF)

1.6 HDi 110	Diesel	80	08/05 →
1.6 HDi 75 (MF9HW)	Diesel	55	07/05 →
1.6 HDi 90 (MF9HX)	Diesel	66	07/05 →

BERLINGO Furgonato (B9)

1.6 HDi 110	Diesel	80	04/08 →
1.6 HDi 75	Diesel	55	04/08 →
1.6 HDi 90	Diesel	66	04/08 →

BERLINGO Furgonato (M_)

1.6 HDi 75 (MB9HW)	Diesel	55	07/05 →
1.6 HDi 90 (MB9HX, MC9HX)	Diesel	66	07/05 →

SAG167

CITROËN
C2 (JM_)

1.4 HDi Diesel 50 09/03 →

1.6 HDi Diesel 80 09/05 →

C2 ENTERPRISE

1.4 HDi Diesel 50 04/09 →

C3 I (FC_)

1.4 HDi Diesel 50 02/02 →

1.4 HDi Diesel 55 05/05 →

1.6 16V HDi Diesel 66 10/05 →

1.6 16V HDi Diesel 80 09/05 →

C3 II

1.6 HDi 90 Diesel 66 11/09 →

C3 Picasso

1.6 HDi Diesel 66 02/09 →

1.6 HDi Diesel 80 02/09 →

C3 Pluriel (HB_)

1.4 HDi Diesel 50 04/04 →

C4 Coupé (LA_)

1.6 HDi Diesel 66 11/04 →

1.6 HDi Diesel 80 11/04 →

C4 Grand Picasso I (UA_)

1.6 HDi Diesel 80 10/06 →

C4 I (LC_)

1.6 HDi Diesel 66 11/04 →

1.6 HDi Diesel 80 11/04 →

C4 Picasso I (UD_)

1.6 HDi Diesel 80 02/07 →

C4 Tre volumi

1.6 HDi Diesel 80 07/06 →

C5 II (RC_)

1.6 HDi (RC8HZB) Diesel 80 09/04 →

2.2 HDi Diesel 125 04/06 →

C5 II Break (RE_)

1.6 HDi (RE8HZB) Diesel 80 09/04 →

2.2 HDi Diesel 125 04/06 →

C5 III (RD_)

1.6 HDi Diesel 80 02/08 →

2.2 HDi Diesel 125 02/08 →

C5 III Break (TD_)

1.6 HDi Diesel 80 02/08 →

2.2 HDi Diesel 125 02/08 →

C6 (TD_)

2.2 HDi Diesel 125 06/06 →

SAG167

CITROËN
C8 (EA_, EB_)

2.2 HDi Diesel 125 06/06 →

C-CROSSER (EP_)

2.2 HDi Diesel 115 02/07 →

C-CROSSER ENTERPRISE

2.2 HDi Diesel 115 01/09 →

JUMPY

1.6 HDi 90 16V Diesel 66 01/07 →

JUMPY Furgonato

1.6 HDi 90 16V Diesel 66 01/07 →

NEMO Furgonato (AA_)

1.4 HDi Diesel 50 02/08 →

NEMO Station wagon

1.4 HDi Diesel 50 04/09 →

XSARA (N1)

1.4 HDi Diesel 50 01/03 → 03/05

XSARA Break (N2)

1.4 HDi Diesel 50 01/03 → 08/05

XSARA Coupé (N0)

1.4 HDi Diesel 50 01/03 → 03/05

XSARA PICASSO (N68)

1.6 HDi Diesel 66 09/05 →

1.6 HDi Diesel 80 05/04 →

FORD
C-MAX (DM2)

1.6 TDCi Diesel 66 02/07 →

1.6 TDCi Diesel 80 02/07 →

FIESTA Van

1.6 TDCi Diesel 66 01/09 →

1.6 TDCi Diesel 70 02/10 →

FIESTA VI

1.6 TDCi Diesel 66 06/08 →

1.6 TDCi Diesel 70 02/10 →

FOCUS C-MAX

1.6 TDCi Diesel 66 02/05 → 03/07

1.6 TDCi Diesel 80 10/03 → 03/07

FOCUS II (DA_)

1.6 TDCi Diesel 66 01/05 →

1.6 TDCi Diesel 80 11/04 →

FOCUS II Station wagon (DA_)

1.6 TDCi Diesel 66 11/04 →

1.6 TDCi Diesel 80 11/04 →

FOCUS II Tre volumi (DA_)

1.6 TDCi Diesel 66 04/05 →

1.6 TDCi Diesel 80 04/05 →

SAG167



KW



MINI

MINI (R56)

Cooper D	Diesel	80	03/07 →
One D	Diesel	66	06/09 → 07/10

MINI CLUBMAN (R55)

Cooper D	Diesel	80	10/07 →
----------	--------	----	---------

MITSUBISHI

OUTLANDER II (CW_W)

2.2 DI-D 4WD	Diesel	115	08/07 → 11/12
--------------	--------	-----	---------------

PEUGEOT

1007 (KM_)

1.4 HDi	Diesel	50	04/05 →
1.6 HDi	Diesel	80	06/07 →

107

1.4 HDi	Diesel	40	06/05 →
---------	--------	----	---------

206 2 volumi /Coda spiovente (2A/C)

1.4 HDi	Diesel	51	09/02 → 02/07
1.4 HDi eco 70	Diesel	50	09/01 →
1.6 HDi 110	Diesel	80	05/04 →

206 CC (2D)

1.6 HDi 110	Diesel	80	04/05 →
-------------	--------	----	---------

206 SW (2E/K)

1.4 HDi	Diesel	50	07/02 →
1.6 HDi 110	Diesel	80	05/04 →

206 Tre volumi

1.4 HDi eco 70	Diesel	50	09/08 →
1.6 16V	Petrol	80	03/07 →

206 Van

1.4 HDi	Diesel	50	09/01 → 03/09
---------	--------	----	---------------

206+ (T3E)

1.4 HDi eco 70	Diesel	50	01/09 →
----------------	--------	----	---------

207 (WA_, WC_)

1.6 HDi	Diesel	66	02/06 →
1.6 HDi	Diesel	80	02/06 →
1.6 HDi 110	Diesel	82	08/09 →

207 CC (WD_)

1.6 HDi	Diesel	80	02/07 →
1.6 HDi	Diesel	82	08/09 →

207 SW (WK_)

1.6 HDi	Diesel	80	06/07 →
1.6 HDi	Diesel	66	06/07 →
1.6 HDi	Diesel	82	08/09 →

207 Van

1.4 HDi	Diesel	50	04/07 →
1.6 HDi	Diesel	66	04/07 →

SAG167



KW



PEUGEOT

3008

1.6 HDi	Diesel	80	06/09 →
1.6 HDi	Diesel	82	08/10 →

307 (3A/C)

1.4 HDi	Diesel	50	10/01 →
1.6 Bioflex	BiFuel	80	09/07 →
1.6 HDi	Diesel	66	04/05 →
1.6 HDi 110	Diesel	80	02/04 →

307 Break (3E)

1.4 HDi	Diesel	50	03/02 →
1.6 Bioflex	BiFuel	80	09/07 →
1.6 HDi	Diesel	66	04/05 →
1.6 HDi 110	Diesel	80	02/04 →

307 SW (3H)

1.6 Bioflex	BiFuel	80	09/07 →
1.6 HDi 110	Diesel	80	02/04 →
1.6 HDi 90	Diesel	66	12/06 →

308 (4A_, 4C_)

1.6 HDi	Diesel	66	09/07 →
1.6 HDi	Diesel	80	09/07 →
1.6 HDi	Diesel	82	12/09 →

308 CC

1.6 HDi	Diesel	82	06/09 →
---------	--------	----	---------

308 SW

1.6 Bioflex	BiFuel	82	03/09 →
1.6 HDi	Diesel	66	09/07 →
1.6 HDi	Diesel	80	09/07 →
1.6 HDi	Diesel	82	12/09 →

4007 (GP_)

2.2 HDi	Diesel	115	02/07 →
---------	--------	-----	---------

407 (6D_)

1.6 HDi 110	Diesel	80	05/04 →
2.2 HDi 170	Diesel	125	05/06 →

407 SW (6E_)

1.6 HDi 110	Diesel	80	05/04 →
2.2 HDi 170	Diesel	125	05/06 →

5008

1.6 HDi	Diesel	80	09/09 →
1.6 HDi	Diesel	82	08/10 →

607 (9D, 9U)

2.2 HDi	Diesel	125	05/06 →
---------	--------	-----	---------

807 (E)

2.2 HDi	Diesel	125	06/06 →
---------	--------	-----	---------

SAG167

PEUGEOT
BIPPER (AA_)

1.4 HDi Diesel 50 02/08 →

BIPPER Tepee

1.4 HDi Diesel 50 04/08 →

EXPERT Furgonato (VF3A_, VF3U_, VF3X_)

1.6 HDi 90 16V Diesel 66 01/07 →

EXPERT Pianale piatto/Telaio

1.6 HDi 90 Diesel 66 01/07 →

EXPERT Tepee (VF3V_)

1.6 HDi 90 16V Diesel 66 01/07 →

PARTNER Pianale piatto/Telaio

1.6 HDi Diesel 55 01/09 →

1.6 HDi Diesel 66 01/09 →

RANCH

1.6 Petrol 80 04/08 →

1.6 HDi Diesel 55 04/08 →

1.6 HDi Diesel 66 04/08 →

1.6 HDi Diesel 80 04/08 →

1.6 HDi 90 Diesel 68 04/10 →

RANCH Furgonato

1.6 Petrol 80 04/08 →

1.6 HDi Diesel 55 04/08 →

1.6 HDi Diesel 66 04/08 →

1.6 HDi Diesel 80 04/08 →

RANCH Furgonato (5)

1.6 Petrol 80 09/00 → 10/02

1.6 HDi 90 Diesel 66 02/06 →

RANCH MPV / Space wagon (5F)

1.6 16V Petrol 80 07/01 →

1.6 HDi 90 Diesel 66 02/06 →

VOLVO
C30

1.6 D Diesel 80 10/06 → 12/12

S40 II (MS)

1.6 D Diesel 81 01/05 →

S80 II (AS)

1.6 D DRiVe Diesel 80 01/10 →

V50 (MW)

1.6 D Diesel 81 01/05 →

V70 III (BW)

1.6 D Diesel 80 01/10 →

SAG168
H1
**SENSORE GIRI / FASE - ALBERO MOTORE
CRANKSHAFT POSITION SENSOR**

CITROËN
C1 (PM_, PN_)

1.4 HDi Diesel 40 06/05 →

C3 I (FC_)

1.4 16V HDi Diesel 66 02/02 →

C5 II (RC_)

2.2 HDi (RC4HXE) Diesel 98 09/04 →

C5 II Break (RE_)

2.2 HDi (RE4HXE) Diesel 98 09/04 →

FORD
FIESTA V (JH_, JD_)

1.4 TDCi Diesel 50 11/01 → 06/08

1.6 TDCi Diesel 66 11/04 → 06/08

FIESTA Van

1.4 TDCi Diesel 50 10/03 →

1.4 TDCi Diesel 50 01/09 →

FIESTA VI

1.4 TDCi Diesel 50 01/09 →

FOCUS C-MAX

1.6 Ti Petrol 85 08/04 → 03/07

FOCUS II (DA_)

1.6 Ti Petrol 85 11/04 →

FOCUS II Tre volumi (DA_)

1.6 Ti Petrol 85 04/05 →

FUSION (JU_)

1.4 TDCi Diesel 50 08/02 →

1.6 TDCi Diesel 66 11/04 →

GALAXY (WA6)

2.2 TDCi Diesel 129 03/08 →

MONDEO IV (BA7)

2.2 TDCi Diesel 129 03/08 →

MONDEO IV Tre volumi (BA7)

2.2 TDCi Diesel 129 03/08 →

SAG168



KW



FORD

MONDEO IV Turnier (BA7)

2.2 TDCi Diesel 129 03/08 →

S-MAX (WA6)

2.2 TDCi Diesel 129 03/08 →

MAZDA

2 (DE)

1.4 MZR-CD Diesel 50 01/08 →

2 (DY)

1.4 CD Diesel 50 04/03 →

3 (BK)

1.6 DI Turbo Diesel 80 06/04 → 06/09

3 (BL)

1.6 MZR CD Diesel 80 06/09 →

3 Tre volumi (BK)

1.6 DI Turbo Diesel 80 06/04 →

PEUGEOT

207 (WA_, WC_)

1.4 HDi Diesel 50 02/06 →

SAG169

H1

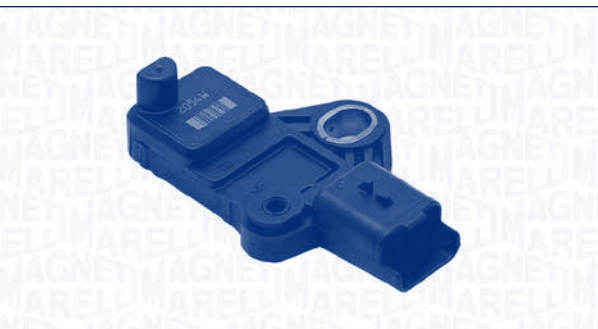
SENSORE GIRI / FASE - ALBERO MOTORE
CRANKSHAFT POSITION SENSOR

KW



CITROËN

C4 Coupé (LA_)

2.0 HDi Diesel 100 11/04 →

C4 Grand Picasso I (UA_)

2.0 HDi 138 Diesel 100 10/06 →

C4 I (LC_)

2.0 HDi Diesel 100 11/04 →

C4 Picasso I (UD_)

2.0 HDi 138 Diesel 100 02/07 →

C5 II (RC_)

2.0 HDi (RCRHRH) Diesel 100 09/04 →

SAG169



KW



CITROËN

C5 II Break (RE_)

2.0 HDi (RERHRH) Diesel 100 09/04 →

C5 III (RD_)

2.0 HDi Diesel 100 02/08 →

C5 III Break (TD_)

2.0 HDi Diesel 100 02/08 →

C8 (EA_, EB_)

2.0 HDi 135 Diesel 100 03/06 →

JUMPY

2.0 HDi 140 Diesel 100 01/07 →

JUMPY Furgonato

2.0 HDi 140 Diesel 100 01/07 →

FIAT

SCUDO (270_)

2.0 D Multijet Diesel 100 01/07 →

2.0 D Multijet Diesel 88 01/07 →

SCUDO Furgonato (270_)

2.0 D Multijet Diesel 100 01/07 →

2.0 D Multijet Diesel 88 01/07 →

SCUDO Pianale piatto/Telaio (270_)

2.0 D Multijet Diesel 100 01/07 →

ULYSSE (179AX)

2.0 D Multijet Diesel 100 05/06 → 06/11

FORD

C-MAX (DM2)

2.0 TDCi Diesel 100 02/07 →

2.0 TDCi Diesel 81 02/08 →

FOCUS C-MAX

2.0 TDCi Diesel 100 10/03 → 03/07

FOCUS II (DA_)

2.0 TDCi Diesel 100 11/04 →

FOCUS II Cabriolet

2.0 TDCi Diesel 100 10/06 →

FOCUS II Station wagon (DA_)

2.0 TDCi Diesel 100 11/04 →

FOCUS II Tre volumi (DA_)

2.0 TDCi Diesel 100 04/05 →

GALAXY (WA6)

2.0 TDCi Diesel 103 05/06 →

2.0 TDCi Diesel 85 11/07 →

2.0 TDCi Diesel 96 05/06 →

KUGA I

2.0 TDCi Diesel 100 03/08 →

2.0 TDCi 4x4 Diesel 100 03/08 →

SAG169

FORD
MONDEO IV (BA7)

2.0 TDCi	Diesel	103	03/07 →
2.0 TDCi	Diesel	85	11/07 →
2.0 TDCi	Diesel	96	03/07 →

MONDEO IV Tre volumi (BA7)

2.0 TDCi	Diesel	85	11/07 →
2.0 TDCi	Diesel	96	03/07 →

MONDEO IV Turnier (BA7)

2.0 TDCi	Diesel	103	03/07 →
2.0 TDCi	Diesel	85	11/07 →
2.0 TDCi	Diesel	96	03/07 →

S-MAX (WA6)

2.0 TDCi	Diesel	103	05/06 →
2.0 TDCi	Diesel	85	11/07 →
2.0 TDCi	Diesel	96	05/06 →

LANCIA
PHEDRA (179)

2.0 D Multijet	Diesel	100	07/06 → 11/10
----------------	--------	-----	---------------

PEUGEOT
307 (3A/C)

2.0 HDi 135	Diesel	100	10/03 →
-------------	--------	-----	---------

307 Break (3E)

2.0 HDi 135	Diesel	100	02/04 →
-------------	--------	-----	---------

307 CC (3B)

2.0 HDi 135	Diesel	100	06/05 →
-------------	--------	-----	---------

307 SW (3H)

2.0 HDi 135	Diesel	100	02/04 →
-------------	--------	-----	---------

308 (4A_, 4C_)

2.0 HDi	Diesel	100	09/07 →
---------	--------	-----	---------

308 SW

2.0 HDi	Diesel	100	09/07 →
---------	--------	-----	---------

407 (6D_)

2.0 HDi 135	Diesel	100	05/04 →
-------------	--------	-----	---------

407 Coupé (6C_)

2.0 HDi	Diesel	100	10/05 →
---------	--------	-----	---------

407 SW (6E_)

2.0 HDi 135	Diesel	100	05/04 →
-------------	--------	-----	---------

607 (9D, 9U)

2.0 HDi	Diesel	100	09/05 →
---------	--------	-----	---------

807 (E)

2.0 HDi	Diesel	100	06/06 →
---------	--------	-----	---------

EXPERT Furgonato (VF3A_, VF3U_, VF3X_)

2.0 HDi 140	Diesel	100	01/07 →
-------------	--------	-----	---------

EXPERT Pianale piatto/Telaio

2.0 HDi 140	Diesel	100	01/07 →
-------------	--------	-----	---------

SAG169

FORD
EXPERT Tepee (VF3V_)

2.0 HDi 140	Diesel	100	01/07 →
-------------	--------	-----	---------

VOLVO
C30

2.0 D	Diesel	100	10/06 → 12/12
-------	--------	-----	---------------

C70 II Cabriolet

2.0 D	Diesel	100	01/08 →
-------	--------	-----	---------

S40 II (MS)

2.0 D	Diesel	100	01/04 →
-------	--------	-----	---------

V50 (MW)

2.0 D	Diesel	100	04/04 →
-------	--------	-----	---------

V70 III (BW)

2.0 D	Diesel	100	10/07 →
-------	--------	-----	---------

SAG170
**H1 SENSORE GIRI / FASE - ALBERO MOTORE
CRANKSHAFT POSITION SENSOR**

FORD
FIESTA V (JH_, JD_)

1.25 16V	Petrol	55	05/02 → 06/08
1.3	Petrol	44	11/01 → 06/08
1.3	Petrol	51	11/01 → 06/08

FIESTA VI

1.25	Petrol	44	06/08 →
1.25	Petrol	60	06/08 →
1.4	Petrol	71	06/08 →
1.6 Ti	Petrol	88	06/08 →

FOCUS (DAW, DBW)

1.4 16V	Petrol	55	10/98 → 11/04
1.6 16V	Petrol	74	10/98 → 11/04
1.8 16V	Petrol	85	10/98 → 11/04
1.8 Turbo DI / TDDi	Diesel	66	10/98 → 11/04
2.0 16V	Petrol	96	10/98 → 11/04

SAG170



KW



FORD

FOCUS C-MAX

1.6	Petrol	74	10/03 → 03/07
1.8	Petrol	88	10/03 → 03/07

FOCUS II (DA_)

1.4	Petrol	59	11/04 →
1.6	Petrol	74	11/04 →

FOCUS II Station wagon (DA_)

1.4	Petrol	59	11/04 →
1.6	Petrol	74	11/04 →
1.6 Ti	Petrol	85	11/04 →
1.8 TDCi	Diesel	85	11/04 →

FUSION (JU_)

1.25	Petrol	55	08/04 →
------	--------	----	---------

SAG171

H1 **SENSORE GIRI / FASE - ALBERO MOTORE**
CRANKSHAFT POSITION SENSOR



KW



FORD

COUGAR (EC_)

2.0 16V	Petrol	96	08/98 → 12/01
---------	--------	----	---------------

FOCUS Tre volumi (DFW)

1.4 16V	Petrol	55	02/99 → 11/04
1.8 Turbo DI / TDDi	Diesel	66	02/99 → 11/04
2.0 16V	Petrol	96	02/99 → 11/04

MONDEO III (B5Y)

2.0 16V TDDi / TDCi	Diesel	85	11/00 → 08/07
2.5 V6 24V	Petrol	125	11/00 → 08/07

SAG172

H1 **SENSORE GIRI / FASE - ALBERO MOTORE**
CRANKSHAFT POSITION SENSOR



KW



FORD

TRANSIT Autobus

2.2 TDCi	Diesel	63	04/06 →
2.2 TDCi	Diesel	81	04/06 →
2.2 TDCi	Diesel	96	04/06 →
2.4 TDCi	Diesel	74	04/06 →
2.4 TDCi	Diesel	85	04/06 →
2.4 TDCi	Diesel	103	04/06 →

TRANSIT Autobus (FD_-, FB_-, FS_-, FZ_-, FC_)

2.0 DI (F_E_, F_F_, F_G_)	Diesel	63	08/00 → 05/06
2.0 DI (F_E_, F_F_, F_G_)	Diesel	74	08/00 → 05/06
2.3 16V [RWD] (F_B_, F_C_, F_A_)	Petrol	107	08/00 → 05/06
2.4 DI [RWD] (F_B_, F_C_)	Diesel	55	01/00 → 05/06

TRANSIT Furgonato

2.2 TDCi	Diesel	63	04/06 →
2.2 TDCi	Diesel	81	04/06 →
2.2 TDCi	Diesel	96	04/06 →
2.3 16V	Petrol	107	04/06 →
2.4 TDCi	Diesel	74	04/06 →
2.4 TDCi	Diesel	85	04/06 →
2.4 TDCi	Diesel	103	04/06 →

TRANSIT Furgonato (FA_)

2.0 DI (FAE_, FAF_, FAG_)	Diesel	63	08/00 → 05/06
2.0 DI (FAE_, FAF_, FAG_)	Diesel	74	08/00 → 05/06
2.3 16V [RWD] (FAA_, FAB_, FAC_)	Petrol	107	04/01 → 05/06

SAG172

FORD
TRANSIT Furgonato (FA_ _)

2.4 DI [RWD] (FAA_, FAB_, FAC_, FAD_)	Diesel	55	01/00 → 05/06
---	--------	----	---------------

TRANSIT Pianale piatto/Telaio

2.2 TDCi	Diesel	63	04/06 →
2.2 TDCi	Diesel	81	04/06 →
2.2 TDCi	Diesel	96	04/06 →
2.3 16V	Petrol	107	04/06 →
2.4 TDCi	Diesel	74	04/06 →
2.4 TDCi	Diesel	85	04/06 →
2.4 TDCi	Diesel	103	04/06 →

TRANSIT Pianale piatto/Telaio (FM_ _, FN_ _)

2.0 DI (F_E_, F_F_)	Diesel	74	08/00 → 05/06
2.3 16V (F_A_, F_B_, F_C_, F_D_)	Petrol	107	04/01 → 05/06
2.4 DI (F_A_, F_B_, F_C_, F_D_)	Diesel	55	01/00 → 05/06

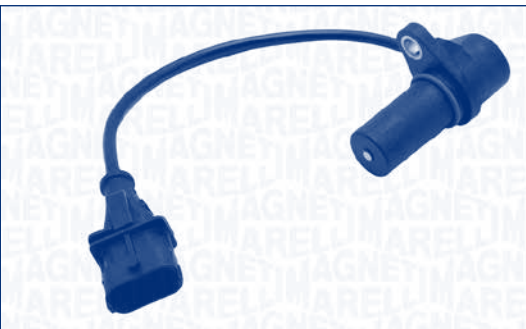
SAG174
H1 **SENSORE GIRI / FASE - ALBERO MOTORE
CRANKSHAFT POSITION SENSOR**

OPEL
ASTRA G Station wagon (F35_)

1.7 CDTI	Diesel	59	04/03 → 07/09
----------	--------	----	---------------

ASTRA G Tre volumi (F69_)

1.7 CDTI	Diesel	59	04/03 → 12/09
----------	--------	----	---------------

ASTRA H (L48)

1.7 CDTI	Diesel	74	03/04 →
----------	--------	----	---------

ASTRA H GTC (L08)

1.7 CDTI	Diesel	74	03/05 →
----------	--------	----	---------

SAG174

OPEL
ASTRA H Van (L70)

1.7 CDTI	Diesel	74	03/04 →
----------	--------	----	---------

SAG175
H1 **SENSORE GIRI / FASE - ALBERO MOTORE
CRANKSHAFT POSITION SENSOR**

FORD
KA (RB_)

1.3 i	Petrol	51	08/02 → 11/08
1.3 i	Petrol	36	06/98 → 11/08
1.6 i	Petrol	70	07/03 → 11/08

KA Van (RB)

1.3 i	Petrol	44	05/02 → 05/05
-------	--------	----	---------------

STREET KA (RL2)

1.6	Petrol	70	05/03 → 07/05
-----	--------	----	---------------

SAG176
H1 **SENSORE GIRI / FASE - ALBERO MOTORE
CRANKSHAFT POSITION SENSOR**

FORD
COUGAR (EC_)

2.5 V6 24V	Petrol	125	08/98 → 12/01
------------	--------	-----	---------------

SAG176



KW



FORD

COURIER Furgonato (J5_, J3_)

1.3	Petrol	44	02/96 →
1.8 D	Diesel	44	02/96 →

ESCORT '95 Furgonato (AVL)

1.8 TD	Diesel	66	01/95 →
1.8 Turbo D	Diesel	51	12/95 → 06/01

ESCORT CLASSIC (AAL, ABL)

1.6 16V	Petrol	66	10/98 → 07/00
1.8 TD	Diesel	66	10/98 → 07/00

ESCORT CLASSIC Turnier (ANL)

1.8 TD	Diesel	66	02/99 → 07/00
--------	--------	----	---------------

ESCORT V (GAL)

1.3	Petrol	44	07/90 → 09/92
1.8 D	Diesel	44	07/90 → 12/92
RS 2000	Petrol	110	05/91 → 12/92

ESCORT V Station wagon (GAL, AVL)

1.3	Petrol	44	09/91 → 09/92
1.8 D	Diesel	44	07/90 → 12/92

ESCORT VI (GAL)

1.3	Petrol	44	09/92 → 01/95
1.4	Petrol	55	01/94 → 01/95
1.6 i 16V	Petrol	66	09/92 → 01/95
1.8 D	Diesel	44	09/92 → 01/95
1.8 TD	Diesel	66	02/93 → 01/95
RS 2000	Petrol	110	09/92 → 01/95
RS 2000 4x4	Petrol	110	08/93 → 01/95
RS Cosworth 4x4	Petrol	162	09/92 → 01/95

ESCORT VI Cabriolet (ALL)

1.4 i	Petrol	55	07/93 → 01/95
-------	--------	----	---------------

ESCORT VI Station wagon (GAL)

1.3	Petrol	44	09/92 → 01/95
1.4	Petrol	55	01/94 → 01/95
1.6 i 16V	Petrol	66	09/92 → 01/95
1.8 D	Diesel	44	09/92 → 01/95
1.8 TD	Diesel	66	02/93 → 01/95

ESCORT VI Tre volumi (GAL)

1.3	Petrol	44	08/93 → 01/95
1.4	Petrol	55	08/93 → 01/95
1.6 i 16V	Petrol	66	08/93 → 01/95
1.8 D	Diesel	44	08/93 → 01/95
1.8 TD	Diesel	66	08/93 → 01/95

ESCORT VII (GAL, AAL, ABL)

1.3	Petrol	44	01/95 → 10/98
1.4	Petrol	55	01/95 → 10/98
1.8 D	Diesel	44	01/95 → 12/96

SAG176



KW



FORD

ESCORT VII (GAL, AAL, ABL)

1.8 TD	Diesel	66	01/95 → 10/98
1.8 Turbo D	Diesel	51	12/95 → 10/98
RS 2000	Petrol	110	02/95 → 02/98

ESCORT VII Cabriolet (ALL)

1.4	Petrol	55	02/95 → 08/98
1.8 TD	Diesel	66	09/95 → 08/98

ESCORT VII Station wagon (GAL, ANL)

1.3	Petrol	44	01/95 → 01/99
1.4	Petrol	55	01/95 → 02/99
1.8 D	Diesel	44	01/95 → 02/99
1.8 TD	Diesel	66	01/95 → 02/99
1.8 Turbo D	Diesel	51	12/95 → 02/99

ESCORT VII Tre volumi (GAL, AFL)

1.3	Petrol	44	01/95 → 02/99
1.4	Petrol	55	01/95 → 02/99
1.8 D	Diesel	44	01/95 → 12/96
1.8 TD	Diesel	66	01/95 → 02/99
1.8 Turbo D	Diesel	51	12/95 → 02/99

FIESTA IV (JA_, JB_)

1.25 i 16V	Petrol	55	08/95 → 01/02
1.3 i	Petrol	37	08/95 → 01/02
1.3 i	Petrol	44	08/95 → 01/02
1.8 D	Diesel	44	08/95 → 04/00

ORION III (GAL)

1.3	Petrol	44	07/90 → 12/93
1.4	Petrol	54	07/90 → 12/93
1.6 i 16V	Petrol	66	07/92 → 12/93
1.8 D	Diesel	44	11/90 → 12/93
1.8 TD	Diesel	66	03/92 → 12/93

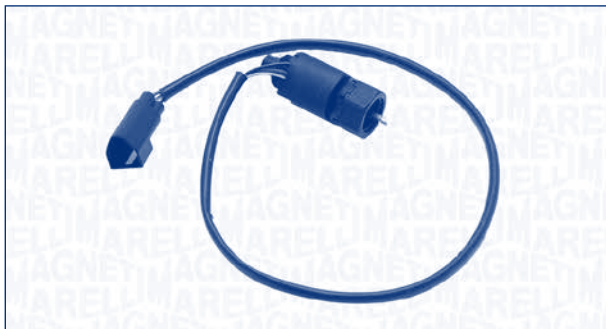
SAG177
H1 **SENSORE GIRI / FASE - ALBERO MOTORE**
CRANKSHAFT POSITION SENSOR

KW

FORD
COURIER Furgonato (F3L, F5L)

1.8 D	Diesel	44	09/91 → 02/96
-------	--------	----	---------------

ESCORT V (GAL)

1.4	Petrol	52	07/90 → 09/92
-----	--------	----	---------------

1.6	Petrol	77	07/90 → 12/92
-----	--------	----	---------------

ESCORT V Cabriolet (ALL)

1.4	Petrol	52	07/90 → 12/92
-----	--------	----	---------------

1.6	Petrol	77	07/90 → 12/92
-----	--------	----	---------------

ESCORT V Station wagon (GAL, AVL)

1.4	Petrol	52	07/90 → 09/92
-----	--------	----	---------------

1.6	Petrol	77	07/90 → 09/92
-----	--------	----	---------------

ESCORT VI (GAL)

1.4	Petrol	52	09/92 → 01/95
-----	--------	----	---------------

1.8 16V XR3i	Petrol	96	09/92 → 01/95
--------------	--------	----	---------------

1.8 i 16V	Petrol	77	09/92 → 01/95
-----------	--------	----	---------------

1.8 XR3i 16V 4x4	Petrol	77	08/93 → 01/95
------------------	--------	----	---------------

1.8 XR3i 16V 4x4	Petrol	96	08/93 → 01/95
------------------	--------	----	---------------

ESCORT VI Cabriolet (ALL)

1.4	Petrol	52	12/92 → 04/94
-----	--------	----	---------------

1.6 i 16V	Petrol	65	02/94 → 01/95
-----------	--------	----	---------------

1.8 16V XR3i	Petrol	96	12/92 → 01/95
--------------	--------	----	---------------

ESCORT VI Station wagon (GAL)

1.4	Petrol	52	09/92 → 01/95
-----	--------	----	---------------

1.6 i 16V	Petrol	65	01/94 → 01/95
-----------	--------	----	---------------

ESCORT VI Tre volumi (GAL)

1.4	Petrol	52	08/93 → 04/94
-----	--------	----	---------------

1.6 i 16V	Petrol	65	01/94 → 01/95
-----------	--------	----	---------------

1.8 i 16V	Petrol	77	08/93 → 01/95
-----------	--------	----	---------------

ESCORT VII (GAL, AAL, ABL)

1.6 i 16V	Petrol	65	01/95 → 08/95
-----------	--------	----	---------------

ESCORT VII Cabriolet (ALL)

1.8 16V XR3i	Petrol	77	02/95 → 08/98
--------------	--------	----	---------------

1.8 16V XR3i	Petrol	96	02/95 → 08/00
--------------	--------	----	---------------

SAG177

KW

FORD
ESCORT VII Station wagon (GAL, ANL)

1.6 i 16V	Petrol	65	01/95 → 08/95
-----------	--------	----	---------------

ESCORT VII Tre volumi (GAL, AFL)

1.6 i 16V	Petrol	65	01/95 → 08/95
-----------	--------	----	---------------

FIESTA Furgonato (FVD)

1.8 D (FVJ)	Diesel	43	03/89 → 12/95
-------------	--------	----	---------------

FIESTA III (GFJ)

1.1	Petrol	40	03/89 → 12/95
-----	--------	----	---------------

1.3	Petrol	44	03/89 → 12/92
-----	--------	----	---------------

1.3	Petrol	44	03/89 → 12/95
-----	--------	----	---------------

1.4	Petrol	54	03/89 → 12/95
-----	--------	----	---------------

1.4	Petrol	52	03/89 → 12/95
-----	--------	----	---------------

1.4 Cat.	Petrol	54	03/89 → 12/95
----------	--------	----	---------------

1.6	Petrol	65	01/89 → 01/94
-----	--------	----	---------------

1.6	Petrol	66	03/89 → 12/92
-----	--------	----	---------------

1.6 XR2i	Petrol	76	03/89 → 03/93
----------	--------	----	---------------

1.8 D	Diesel	44	03/89 → 12/95
-------	--------	----	---------------

MONDEO I (GBP)

1.6 i 16V	Petrol	65	07/94 → 08/96
-----------	--------	----	---------------

1.8 i 16V	Petrol	85	02/93 → 08/96
-----------	--------	----	---------------

1.8 i 16V	Petrol	82	07/94 → 08/96
-----------	--------	----	---------------

2.0 i 16V	Petrol	100	02/93 → 08/96
-----------	--------	-----	---------------

2.0 i 16V	Petrol	97	12/94 → 08/96
-----------	--------	----	---------------

2.0 i 16V 4x4	Petrol	97	12/94 → 08/96
---------------	--------	----	---------------

2.5 i 24V	Petrol	125	07/94 → 08/96
-----------	--------	-----	---------------

MONDEO I Station wagon (BNP)

1.6 i 16V	Petrol	65	07/94 → 08/96
-----------	--------	----	---------------

1.6 i 16V	Petrol	66	04/93 → 08/96
-----------	--------	----	---------------

1.8 i 16V	Petrol	82	07/94 → 08/96
-----------	--------	----	---------------

1.8 i 16V	Petrol	85	04/93 → 08/96
-----------	--------	----	---------------

1.8 i 16V 4x4	Petrol	85	04/93 → 08/96
---------------	--------	----	---------------

2.0 i 16V	Petrol	100	04/93 → 08/96
-----------	--------	-----	---------------

2.0 i 16V	Petrol	97	01/93 → 08/96
-----------	--------	----	---------------

2.0 i 16V 4x4	Petrol	100	04/93 → 08/96
---------------	--------	-----	---------------

2.0 i 16V 4x4	Petrol	97	12/94 → 08/96
---------------	--------	----	---------------

2.5 i 24V	Petrol	125	07/94 → 08/96
-----------	--------	-----	---------------

MONDEO I Tre volumi (GBP)

1.6 i 16V	Petrol	65	07/94 → 08/96
-----------	--------	----	---------------

1.8 i 16V	Petrol	82	01/94 → 08/96
-----------	--------	----	---------------

2.0 i 16V	Petrol	100	02/93 → 08/96
-----------	--------	-----	---------------

2.0 i 16V 4x4	Petrol	97	12/94 → 08/96
---------------	--------	----	---------------

2.5 i 24V	Petrol	125	07/94 → 08/96
-----------	--------	-----	---------------

ORION III (GAL)

1.4	Petrol	52	07/90 → 12/93
-----	--------	----	---------------

1.6	Petrol	66	07/90 → 12/92
-----	--------	----	---------------

SAG177



FORD

ORION III (GAL)

1.6 i	Petrol	77	07/90 → 09/92
1.8 i 16V	Petrol	77	02/92 → 12/93

RANGER (ER, EQ)

1.8	Petrol	85	06/99 → 02/02
-----	--------	----	---------------

SIERRA (GBG, GB4)

2.0 4x4	Petrol	92	01/90 → 02/93
2.0 i	Petrol	92	01/90 → 02/93
2.9 4x4	Petrol	107	08/88 → 02/93
2.9 4x4	Petrol	110	08/88 → 02/93
2.9 i	Petrol	110	08/88 → 02/93

SIERRA 2 volumi /Coda spiovente (GBC, GBG)

2.0 16V Cosworth 4x4	Petrol	162	01/90 → 02/93
2.0 4x4	Petrol	88	10/91 → 03/93
2.8 i XR 4x4	Petrol	110	01/87 → 08/88

SIERRA Station wagon (BNG)

2.0 4x4	Petrol	88	02/90 → 02/93
2.0 4x4	Petrol	92	05/89 → 02/93
2.0 i	Petrol	88	05/89 → 02/93
2.0 i	Petrol	92	05/89 → 02/93
2.8 4x4	Petrol	110	01/87 → 08/88
2.9	Petrol	107	08/88 → 02/93
2.9 4x4	Petrol	107	08/88 → 02/93
2.9 4x4	Petrol	110	08/88 → 02/93
2.9 i	Petrol	110	08/88 → 02/93

SAG178

H1 **SENSORE GIRI / FASE - ALBERO MOTORE**
CRANKSHAFT POSITION SENSOR



AUDI

TT (8N3)

1.8 T	Petrol	110	09/02 → 06/06
-------	--------	-----	---------------

SAG178



AUDI

TT Roadster (8N9)

1.8 T	Petrol	110	01/01 → 06/06
-------	--------	-----	---------------

SEAT

AROSA (6H)

1.4 16V	Petrol	74	01/00 → 06/04
---------	--------	----	---------------

CORDOBA (6K1, 6K2)

1.0 i	Petrol	37	09/96 → 06/99
1.4 i	Petrol	44	06/94 → 06/99
1.6 i	Petrol	55	02/93 → 06/99
1.6 i	Petrol	55	05/94 → 06/99
1.8 i	Petrol	66	02/93 → 06/99
1.9 TDI	Diesel	81	03/97 → 06/99

CORDOBA (6K2)

1.0	Petrol	37	06/99 → 10/02
1.4	Petrol	44	06/99 → 10/02
1.4 16V	Petrol	74	02/00 → 10/02
1.4 16V	Petrol	55	05/00 → 10/02
1.6	Petrol	55	06/99 → 10/02
1.6	Petrol	74	06/99 → 10/02
1.8 T 20V Cupra	Petrol	115	07/00 → 10/02
1.9 SDI	Diesel	50	06/99 → 10/02
1.9 TDI	Diesel	66	06/99 → 10/02
1.9 TDI	Diesel	81	06/99 → 10/02

CORDOBA (6L2)

1.4 16V	Petrol	74	10/02 → 11/09
---------	--------	----	---------------

CORDOBA Vario (6K5)

1.4	Petrol	44	06/99 → 12/02
1.4 16V	Petrol	55	06/99 → 12/02
1.4 i	Petrol	44	09/96 → 06/99
1.6	Petrol	55	06/99 → 12/02
1.6	Petrol	74	06/99 → 12/02
1.6 i	Petrol	55	09/96 → 06/99
1.6 i	Petrol	55	05/97 → 06/99
1.9 SDI	Diesel	50	06/99 → 12/02
1.9 TDI	Diesel	81	07/97 → 06/99
1.9 TDI	Diesel	66	06/99 → 12/02
1.9 TDI	Diesel	81	06/99 → 12/02

IBIZA II (6K1)

1.0	Petrol	33	03/93 → 09/96
1.0 i	Petrol	37	09/96 → 08/99
1.3 i	Petrol	40	03/93 → 08/99
1.4 i	Petrol	44	09/93 → 08/99
1.6 i	Petrol	55	03/93 → 08/99
1.6 i	Petrol	55	09/94 → 06/99
1.8 i	Petrol	66	03/93 → 08/99

SAG178

SEAT
IBIZA III (6K1)

1.0	Petrol	37	08/99 → 02/02
1.4	Petrol	44	08/99 → 02/02
1.4 16V	Petrol	55	05/00 → 02/02
1.4 16V	Petrol	74	08/99 → 02/02
1.6	Petrol	55	08/99 → 02/02
1.6	Petrol	74	08/99 → 02/02
1.8 T 20V Cupra	Petrol	115	07/00 → 02/02
1.9 SDI	Diesel	50	08/99 → 02/02
1.9 TDI	Diesel	66	08/99 → 02/02
1.9 TDI	Diesel	81	08/99 → 02/02

IBIZA IV (6L1)

1.4 16V	Petrol	74	02/02 → 11/09
---------	--------	----	---------------

INCA (6K9)

1.4 16V	Petrol	55	04/00 → 06/03
1.6 i	Petrol	55	06/97 → 09/00
1.9 TDI	Diesel	66	09/96 → 06/03

LEON (1M1)

1.4 16V	Petrol	55	11/99 → 06/06
1.9 SDI	Diesel	50	11/99 → 06/06
1.9 TDI	Diesel	66	11/99 → 06/06
1.9 TDI	Diesel	81	11/99 → 06/06

LEON (1P1)

1.9 TDI	Diesel	81	10/05 →
---------	--------	----	---------

TOLEDO I (1L)

1.6 i	Petrol	55	01/93 → 03/99
1.6 i	Petrol	52	05/91 → 12/93
1.6 i	Petrol	54	05/91 → 03/99
1.8 i	Petrol	66	11/93 → 12/96

TOLEDO II (1M2)

1.4 16V	Petrol	55	07/99 → 05/06
1.9 SDI	Diesel	50	11/99 → 06/04
1.9 TDI	Diesel	66	04/99 → 05/06
1.9 TDI	Diesel	81	04/99 → 05/06

SKODA
FABIA (6Y2)

2.0	Petrol	85	12/99 → 03/08
-----	--------	----	---------------

FABIA Combi (6Y5)

2.0	Petrol	85	04/00 → 12/07
-----	--------	----	---------------

FABIA Tre volumi (6Y3)

2.0	Petrol	85	12/99 → 12/07
-----	--------	----	---------------

OCTAVIA (1U2)

1.8 T	Petrol	110	08/97 → 12/10
1.9 TDI	Diesel	81	08/97 → 01/06
2.0	Petrol	85	04/99 → 05/07

SAG178

SKODA
OCTAVIA Combi (1U5)

1.8 T	Petrol	110	07/98 → 12/10
1.9 TDI	Diesel	81	07/98 → 01/06
2.0	Petrol	85	04/99 → 05/07

VOLKSWAGEN
BORA (1J2)

1.4 16V	Petrol	55	03/00 → 05/05
1.6	Petrol	75	08/00 → 05/05
1.8	Petrol	92	10/98 → 05/05
1.8 T	Petrol	110	05/00 → 05/05
1.9 SDI	Diesel	50	10/98 → 05/05
1.9 TDI	Diesel	66	10/98 → 06/01
1.9 TDI	Diesel	81	10/98 → 06/01
1.9 TDI	Diesel	74	09/00 → 05/05
1.9 TDI 4motion	Diesel	66	02/99 → 06/01
1.9 TDI 4motion	Diesel	74	09/00 → 05/05
2.0 4motion	Petrol	85	04/00 → 05/05

BORA Station wagon (1J6)

1.4 16V	Petrol	55	09/01 → 05/05
1.6	Petrol	75	08/00 → 05/05
1.8 T	Petrol	110	05/00 → 05/05
1.9 TDI	Diesel	66	07/04 → 05/05
1.9 TDI	Diesel	81	05/99 → 06/01
1.9 TDI	Diesel	74	09/00 → 05/05
1.9 TDI	Diesel	85	05/99 → 06/01
1.9 TDI 4motion	Diesel	74	09/00 → 05/05
1.9 TDI 4motion	Diesel	85	05/99 → 06/01
2.0 4motion	Petrol	85	04/00 → 05/05

CADDY I (14)

1.6	Petrol	55	01/83 → 07/92
-----	--------	----	---------------

CADDY II Furgonato (9K9A)

1.4	Petrol	55	08/00 → 01/04
1.9 D	Diesel	47	11/95 → 01/04
60 1.4	Petrol	44	11/95 → 01/04
75 1.6	Petrol	55	11/95 → 05/97
75 1.6	Petrol	55	11/95 → 09/00

CADDY II Pick-up (9U7)

1.6	Petrol	55	06/96 → 12/00
-----	--------	----	---------------

CADDY II Station wagon (9K9B)

1.4 16V	Petrol	55	08/00 → 01/04
1.6	Petrol	55	06/97 → 09/00
1.6	Petrol	55	11/95 → 05/97
1.9 D	Diesel	47	11/95 → 01/04

CORRADO (53I)

2.0 i 16V	Petrol	100	08/91 → 12/95
-----------	--------	-----	---------------

SAG178



KW



VOLKSWAGEN

GOLF I (17)

1.6 Petrol 55 01/83 → 02/84

GOLF I Cabriolet (155)

1.6 Petrol 55 08/83 → 04/92

GOLF II (19E, 1G1)

1.6 Petrol 55 08/83 → 07/92

1.8 i Cat. Petrol 66 08/87 → 10/91

1.8 Syncro Petrol 66 02/86 → 07/91

GOLF III (1H1)

1.8 Petrol 66 11/91 → 08/97

1.8 Syncro (1HX1) Petrol 66 01/93 → 08/97

1.9 D Diesel 48 11/91 → 08/97

1.9 TD, GTD Diesel 55 11/91 → 08/97

2.8 VR6 Petrol 128 01/92 → 08/97

GOLF III Cabriolet (1E7)

1.8 Petrol 66 07/93 → 05/98

GOLF III Variant (1H5)

1.8 Petrol 66 07/93 → 04/99

1.9 D Diesel 48 07/93 → 04/99

1.9 TD Diesel 55 07/93 → 04/99

GOLF IV (1J1)

1.4 16V Petrol 55 08/97 → 06/05

1.6 Petrol 74 08/97 → 05/04

1.6 Petrol 75 08/00 → 06/05

1.8 Petrol 92 08/97 → 06/05

1.8 4motion Petrol 92 05/98 → 06/05

1.9 SDI Diesel 50 08/97 → 06/05

1.9 TDI Diesel 66 10/97 → 05/04

1.9 TDI Diesel 74 09/00 → 06/05

1.9 TDI Diesel 81 08/97 → 05/04

1.9 TDI 4motion Diesel 66 07/98 → 04/02

1.9 TDI 4motion Diesel 74 09/00 → 06/05

1.9 TDI 4motion Diesel 85 09/99 → 06/01

GOLF IV Cabriolet (1E7)

1.8 Petrol 55 06/98 → 06/02

1.8 Petrol 66 06/98 → 06/02

GOLF IV Variant (1J5)

1.4 16V Petrol 55 05/99 → 06/06

1.6 Petrol 75 08/00 → 06/06

1.9 SDI Diesel 50 05/99 → 06/06

1.9 TDI Diesel 66 05/99 → 05/06

1.9 TDI Diesel 81 05/99 → 06/01

1.9 TDI Diesel 74 09/00 → 06/06

1.9 TDI Diesel 85 08/99 → 06/01

SAG178



KW



VOLKSWAGEN

GOLF IV Variant (1J5)

1.9 TDI 4motion Diesel 66 05/99 → 04/02

1.9 TDI 4motion Diesel 74 09/00 → 06/06

1.9 TDI 4motion Diesel 85 05/99 → 06/01

JETTA I (16)

1.6 Petrol 55 08/82 → 07/83

JETTA II (19E, 1G2, 165)

1.6 Petrol 55 01/84 → 07/92

1.8 Cat. Petrol 66 08/87 → 10/91

LUPO (6X1, 6E1)

1.0 Petrol 37 10/98 → 05/00

1.0 Petrol 37 09/98 → 07/05

1.4 Petrol 44 10/00 → 07/05

1.4 16V Petrol 55 09/98 → 07/05

1.4 16V Petrol 74 08/99 → 07/05

1.4 FSI Petrol 77 02/01 → 07/05

1.6 GTI Petrol 92 09/00 → 07/05

NEW BEETLE (9C1, 1C1)

1.4 Petrol 55 11/01 → 09/10

1.9 TDI Diesel 66 01/98 → 06/04

1.9 TDI Diesel 74 02/01 → 09/10

NEW BEETLE Cabriolet (1Y7)

1.4 Petrol 55 01/03 → 09/10

1.9 TDI Diesel 74 06/03 → 09/10

2.0 Petrol 85 09/02 → 10/10

PASSAT (3A2, 35I)

1.6 Petrol 53 02/88 → 09/91

1.6 Petrol 55 02/88 → 12/88

1.8 Petrol 55 08/90 → 08/96

1.8 Petrol 66 02/88 → 08/96

1.9 D Diesel 50 05/89 → 10/93

1.9 TD Diesel 55 03/91 → 08/96

2.0 Petrol 85 02/90 → 08/96

2.0 16V Petrol 100 08/88 → 09/93

PASSAT (3B2)

1.9 TDI Diesel 85 08/98 → 11/00

1.9 TDI 4motion Diesel 85 08/99 → 11/00

PASSAT Variant (3A5, 35I)

1.6 Petrol 53 04/88 → 09/91

1.6 Petrol 55 04/88 → 12/88

1.8 Petrol 55 08/90 → 05/97

1.8 Petrol 66 02/88 → 05/97

1.9 D Diesel 50 05/89 → 10/93

1.9 TD Diesel 55 03/91 → 05/97

2.0 Petrol 85 02/90 → 05/97

SAG178

VOLKSWAGEN
PASSAT Variant (3A5, 35I)

2.0	Petrol	85	10/93 → 10/96
2.0 16V	Petrol	100	08/88 → 09/93

PASSAT Variant (3B5)

1.9 TDI	Diesel	85	08/98 → 11/00
1.9 TDI 4motion	Diesel	85	08/99 → 11/00

POLO (6N1)

100 1.4 16V	Petrol	74	04/96 → 10/99
45 1.0	Petrol	33	10/94 → 09/96
55 1.3	Petrol	40	10/94 → 07/95
55 1.4	Petrol	40	08/95 → 10/99
60 1.4	Petrol	44	07/95 → 10/99
75 1.6	Petrol	55	10/94 → 10/99

POLO (6N2)

1.4 16V	Petrol	55	10/99 → 09/01
1.4 16V	Petrol	74	10/99 → 09/01
1.6 16V GTI	Petrol	92	10/99 → 09/01

POLO (9N_)

1.4 16V	Petrol	74	10/01 → 05/08
1.9 TDI	Diesel	96	11/03 → 11/09

POLO CLASSIC (6KV2)

1.9 SDI	Diesel	48	06/96 → 09/01
110 1.9 TDI	Diesel	81	06/98 → 01/02
54 1.4	Petrol	40	01/98 → 08/99
60 1.4	Petrol	44	12/95 → 09/01
68 1.9 SDI	Diesel	50	08/99 → 01/02
75 1.4 16V	Petrol	55	10/99 → 09/01
75 1.6	Petrol	55	11/95 → 09/97
75 1.6	Petrol	55	11/95 → 09/01
90 1.8	Petrol	66	01/97 → 09/01

POLO Furgonato (6NF)

1.4	Petrol	44	05/98 → 12/99
-----	--------	----	---------------

POLO Tre volumi (9A4)

1.9 TDI	Diesel	74	09/02 →
---------	--------	----	---------

POLO Variant (6KV5)

1.4	Petrol	44	05/97 → 09/01
1.4 16V	Petrol	55	10/99 → 09/01
1.6	Petrol	55	05/97 → 09/01
1.8	Petrol	66	05/97 → 09/01
1.9 SDI	Diesel	50	08/99 → 09/01
1.9 TDI	Diesel	81	06/98 → 09/01

SCIROCCO (53B)

1.6	Petrol	55	01/83 → 12/89
-----	--------	----	---------------

SAG178

VOLKSWAGEN
SHARAN (7M8, 7M9, 7M6)

1.8 T 20V	Petrol	110	09/97 → 03/10
1.9 TDI	Diesel	96	11/02 → 03/10
1.9 TDI	Diesel	85	04/00 → 03/10
1.9 TDI 4motion	Diesel	85	04/00 → 03/10
2.0 LPG	Petrol/ LPG	85	04/06 → 03/10
2.8 VR6	Petrol	128	09/95 → 04/00

TRANSPORTER IV Autobus (70XB, 70XC, 7DB, 7DW)

1.9 D	Diesel	44	09/90 → 12/95
1.9 TD	Diesel	50	10/92 → 04/03
2.0	Petrol	62	09/90 → 04/03
2.4 D	Diesel	55	08/97 → 04/03
2.4 D	Diesel	57	09/90 → 04/98
2.4 D Syncro	Diesel	57	10/92 → 09/98
2.5	Petrol	81	11/90 → 04/03
2.5 Syncro	Petrol	81	11/92 → 04/03
2.5 TDI	Diesel	65	05/98 → 04/03
2.5 TDI	Diesel	75	09/95 → 04/03
2.8 VR 6	Petrol	103	11/95 → 04/00

TRANSPORTER IV Furgonato (70XA)

2.4 D	Diesel	55	08/97 → 04/03
2.5	Petrol	85	08/96 → 04/03
2.5 Syncro	Petrol	85	08/96 → 04/03
2.5 TDI	Diesel	65	12/98 → 04/03
2.5 TDI	Diesel	75	09/95 → 04/03
2.5 TDI Syncro	Diesel	75	09/95 → 04/03
2.8 VR6	Petrol	103	05/96 → 05/00

TRANSPORTER IV Pianale piatto/Telaio (70XD)

2.0	Petrol	62	07/90 → 04/03
2.4 D	Diesel	55	08/97 → 04/03
2.4 D Syncro	Diesel	57	10/92 → 09/98
2.5	Petrol	81	11/90 → 04/03
2.5	Petrol	85	08/96 → 04/03
2.5 Syncro	Petrol	81	10/92 → 04/03
2.5 Syncro	Petrol	85	08/96 → 04/03
2.5 TDI	Diesel	65	05/98 → 04/03
2.5 TDI	Diesel	75	09/95 → 04/03
2.5 TDI Syncro	Diesel	75	05/98 → 04/03

VENTO (1H2)

1.8	Petrol	66	11/91 → 09/98
1.9 D	Diesel	48	11/91 → 09/98
1.9 TD	Diesel	55	11/91 → 09/98
2.8 VR6	Petrol	128	01/92 → 09/98

SAG179

H1 **SENSORE GIRI / FASE - ALBERO MOTORE**
CRANKSHAFT POSITION SENSOR

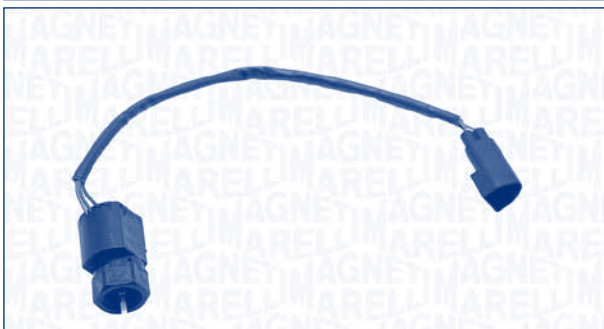

FORD

FOCUS (DAW, DBW)

1.4 16V	Petrol	55	10/98 → 11/04	ENGINE: FXDA, FXDC, FXDB, FXDD
1.6 16V	Petrol	74	10/98 → 11/04	ENGINE: FYDA, FYDC, FYDB, FYDD, FYDH
1.8 16V	Petrol	85	10/98 → 11/04	ENGINE: EYDC, EYDB, EYDD, EYDE, EYDF, EYDG, EYDI, EYDJ, EYDL
1.8 DI / TDDi	Diesel	55	08/99 → 11/04	ENGINE: BHDA, BHDB
1.8 TDCi	Diesel	74	08/02 → 11/04	ENGINE: FFDA
1.8 TDCi	Diesel	85	03/01 → 11/04	ENGINE: F9DA, F9DB
1.8 Turbo DI / TDDi	Diesel	66	10/98 → 11/04	ENGINE: C9DC, C9DA, C9DB
2.0 16V	Petrol	96	10/98 → 11/04	ENGINE: EDDC, Eddb, EDDd, EDDF

FOCUS Station wagon (DNW)

1.4 16V	Petrol	55	02/99 → 11/04	ENGINE: FXDA, FXDC, FXDB, FXDD
1.6 16V	Petrol	74	02/99 → 11/04	ENGINE: FYDA, FYDC, FYDB, FYDD, FYDH
1.8 16V	Petrol	85	02/99 → 11/04	ENGINE: EYDC, EYDB, EYDD, EYDE, EYDF, EYDG, EYDI, EYDJ, EYDL
1.8 TDCi	Diesel	74	08/02 → 11/04	ENGINE: FFDA
1.8 DI / TDDi	Diesel	55	08/99 → 11/04	ENGINE: BHDA, BHDB
1.8 TDCi	Diesel	85	03/01 → 11/04	ENGINE: F9DA, F9DB
1.8 Turbo DI / TDDi	Diesel	66	02/99 → 11/04	ENGINE: C9DC, C9DA, C9DB

FOCUS Tre volumi (DFW)

2.0 16V	Petrol	96	02/99 → 11/04	ENGINE: EDDC, Eddb, EDDd, EDDF
---------	--------	----	---------------	--------------------------------

SAG179



FORD

FOCUS Tre volumi (DFW)

1.4 16V	Petrol	55	02/99 → 11/04	ENGINE: FXDA, FXDC, FXDB, FXDD
1.6 16V	Petrol	74	02/99 → 11/04	ENGINE: FYDA, FYDC, FYDB, FYDD, FYDH
1.8 16V	Petrol	85	02/99 → 11/04	ENGINE: EYDC, EYDB, EYDD, EYDE, EYDF, EYDG, EYDI, EYDJ, EYDL
1.8 TDCi	Diesel	74	08/02 → 11/04	ENGINE: FFDA
1.8 TDCi	Diesel	85	03/01 → 11/04	ENGINE: F9DA, F9DB
1.8 Turbo DI / TDDi	Diesel	55	08/01 → 03/05	ENGINE: BHDA, BHDB
1.8 Turbo DI / TDDi	Diesel	66	02/99 → 11/04	ENGINE: C9DC, C9DA, C9DB
2.0 16V	Petrol	96	02/99 → 11/04	ENGINE: EDDC, Eddb, EDDd, EDDF

KA (RB_)

1.0 i	Petrol	48	09/99 → 11/08	
1.3 i	Petrol	36	06/98 → 11/08	ENGINE: JJD, JJF, JJG, JJH, JJJ
1.3 i	Petrol	51	08/02 → 11/08	ENGINE: A9A, A9B
1.6 i	Petrol	70	07/03 → 11/08	ENGINE: CDB, CDC, CCA

KA Van (RB)

1.3 i	Petrol	44	05/02 → 05/05	ENGINE: J4D, J4K, J4M, J4N, J4P, J4S, BAA
-------	--------	----	---------------	---

TOURNEO CONNECT

1.8 TDCi	Diesel	81	08/06 →	ENGINE: RWPA, RWPC, RWPD
1.8 Turbo Di	Diesel	66	06/02 →	ENGINE: HCPA, HCPB, RWPE, RWPF, P9PA, P9PB, P9PC, P9PD, R3PA

TRANSIT CONNECT (P65_, P70_, P80_)

1.8 Di	Diesel	55	06/02 →	ENGINE: P7PA, P7PB, R2PA, BHPA
1.8 TDCi	Diesel	66	06/02 →	ENGINE: HCPA, HCPB, RWPE, RWPF, P9PA, P9PB, P9PC, P9PD, R3PA
1.8 TDCi	Diesel	81	08/06 →	ENGINE: RWPA, RWPC, RWPD

SEN8D
H1 **SENSORE GIRI / FASE - ALBERO MOTORE**
CRANKSHAFT POSITION SENSOR

ALFA ROMEO
164 (164)

2.0 Turbo Petrol 128 10/87 → 09/98

FIAT
ARGENTA (132A)

2000 i.e. Petrol 90 01/83 → 07/86

CINQUECENTO (170)

0.7 i (170AD) Petrol 22 07/94 → 01/98

CROMA (154)

1600 Petrol 61 12/85 → 12/90

2000 CHT (154.AC) Petrol 66 12/85 → 02/89

2000 i.e. (154.AD) Petrol 88 01/88 → 09/92

2000 i.e. (154.AM) Petrol 83 03/86 → 09/90

2000 i.e. (154.AM, 154.LM) Petrol 85 01/91 → 08/96

2000 i.e. Turbo (154.AM) Petrol 114 12/85 → 06/90

2000 i.e. Turbo (154.AM, 154.LM) Petrol 110 06/87 → 08/96

REGATA (138)

100 Super 1.6 Petrol 74 01/89 → 12/90

70 1.3 Petrol 48 09/83 → 07/89

75 i.e. 1.5 Petrol 55 07/85 → 07/89

85 1.5 Petrol 58 05/85 → 12/87

85 Super 1.5 Petrol 60 09/83 → 04/85

REGATA Weekend

75 1.5 Petrol 55 09/84 → 07/89

RITMO I (138A)

105 Sport 1.6 Petrol 77 05/81 → 12/82

125 TC Abarth 2.0 Petrol 92 11/81 → 09/82

75 i.e. 1.5 Petrol 55 10/85 → 05/87

85 1.5 Petrol 63 01/81 → 09/82

SEN8D

FIAT
RITMO II (138A)

105 1.6 Petrol 77 01/83 → 12/87

130 TC Abarth 2.0 Petrol 96 04/83 → 12/87

60 1.1 Petrol 43 04/85 → 12/87

60 1.1 Petrol 40 10/82 → 10/85

85 1.5 Petrol 60 01/83 → 12/87

TEMPRA (159)

1.8 i.e. (159.AN) Petrol 81 01/92 → 08/96

TEMPRA S.W. (159)

1.8 i.e. (159.AN) Petrol 81 01/92 → 08/96

UNO (146A/E)

1.3 Turbo i.e. Petrol 73 01/87 → 12/87

1.3 Turbo i.e. Petrol 74 09/89 → 03/91

1.3 Turbo i.e. Petrol 77 04/85 → 08/89

1.4 Turbo i.e. Petrol 82 09/89 → 09/93

45 0.9 Petrol 33 03/83 → 09/92

75 i.e. 1.5 Petrol 55 10/85 → 12/93

LANCIA
DELTA I (831AB0)

1.5 (831AB.025) Petrol 63 09/79 → 12/92

1.6 GT Petrol 77 11/82 → 04/86

2.0 16V HF Evo Integrale (831AB.027) Petrol 155 06/93 → 01/94

2.0 16V HF Integrale (831AB.026) Petrol 144 03/89 → 09/91

2.0 HF Integrale (831AB.024) Petrol 133 10/87 → 02/89

2.0 HF Integrale (831AB.024S, 831AB.028) Petrol 130 01/87 → 12/92

PRISMA (831AB0)

1.6 Petrol 77 01/83 → 04/86

2.0 i.e. Trazione integrale Petrol 85 01/88 → 12/89

THEMA (834)

2000 i.e. Petrol 83 03/86 → 09/88

2000 i.e. (834BV) Petrol 85 09/87 → 05/92

2000 i.e. 16V (834AI) Petrol 104 02/89 → 05/92

2000 i.e. 16V Turbo (834AL) Petrol 130 04/89 → 05/92

2000 i.e. Turbo (834C) Petrol 122 11/84 → 12/87

SEN8D



LANCIA

THEMA SW (834)

2000 i.e. 16V (834Al)	Petrol	104	02/89 → 05/92
-----------------------	--------	-----	---------------

Y10 (156)

1.0 Turbo (156D)	Petrol	62	03/85 → 02/89
------------------	--------	----	---------------

MASERATI

228

2.8 i	Petrol	184	01/88 → 12/90
-------	--------	-----	---------------

420/430 (69, 78, AF3)

420 i	Petrol	138	01/87 → 12/88
-------	--------	-----	---------------

BITURBO (70, 77)

2.24V	Petrol	180	03/89 → 12/94
-------	--------	-----	---------------

4.24V	Petrol	180	04/90 → 12/94
-------	--------	-----	---------------

BITURBO Coupé

2.0	Petrol	136	01/86 → 04/87
-----	--------	-----	---------------

Si 2.0	Petrol	151	09/87 → 12/88
--------	--------	-----	---------------

BITURBO Spider

2.0	Petrol	136	01/86 → 04/87
-----	--------	-----	---------------

GHIBLI II

2.0 24V Biturbo	Petrol	225	01/93 →
-----------------	--------	-----	---------

QUATTROPORTE IV

2.0 Biturbo	Petrol	211	01/97 →
-------------	--------	-----	---------

2.8 Biturbo	Petrol	209	01/97 →
-------------	--------	-----	---------

SHAMAL

3.2	Petrol	240	12/89 → 11/95
-----	--------	-----	---------------

SEN8D3

H1 **SENSORE GIRI / FASE - ALBERO MOTORE**
CRANKSHAFT POSITION SENSOR



FIAT

CINQUECENTO (170)

0.9 i.e. S (170AF, 170CF)	Petrol	29	07/91 → 01/98
---------------------------	--------	----	---------------

SEN8D3



FIAT

PANDA (141A_)

900	Petrol	29	04/92 → 12/96
-----	--------	----	---------------

SEICENTO (187)

0.9 (187AXA, 187AXA1A)	Petrol	29	01/98 → 01/10
------------------------	--------	----	---------------

SEN8E

H1 **SENSORE GIRI / FASE - ALBERO MOTORE**
CRANKSHAFT POSITION SENSOR



ALFA ROMEO

33 (907A)

1.4 i.e. (907.A3A, 907.A3B)	Petrol	65	01/92 → 09/94
-----------------------------	--------	----	---------------

1.4 i.e. (907.A3A, 907.A3B)	Petrol	66	01/92 → 09/94
-----------------------------	--------	----	---------------

33 Sportwagon (907B)

1.4 i.e.	Petrol	65	01/92 → 09/94
----------	--------	----	---------------

1.4 i.e.	Petrol	66	01/92 → 09/94
----------	--------	----	---------------

1.4 i.e. 4x4	Petrol	66	01/92 → 09/94
--------------	--------	----	---------------

FIAT

CROMA (154)

2000 i.e. (154.AM, 154.LM)	Petrol	85	10/87 → 08/96
----------------------------	--------	----	---------------

REGATA (138)

100 Super 1.6	Petrol	74	10/83 → 12/90
---------------	--------	----	---------------

SEN8I
H1 **SENSORE GIRI / FASE - ALBERO MOTORE**
CRANKSHAFT POSITION SENSOR

KW

ALFA ROMEO
155 (167)

2.0 16V Turbo Q4 Petrol 140 01/93 → 12/97

2.0 16V Turbo Q4 (167.A2B, 167.A2C, 167.A2E) Petrol 137 01/93 → 12/97

FIAT
COUPE (FA/175)

2.0 16V Petrol 102 11/93 → 08/96

2.0 16V Turbo Petrol 140 11/93 → 08/96

TEMPRA (159)

1.8 i.e. (159.AN) Petrol 77 03/92 → 08/96

2.0 i.e. (159.AP) Petrol 83 01/93 → 08/96

TEMPRA S.W. (159)

1.8 i.e. (159.AN) Petrol 77 03/92 → 12/93

2.0 i.e. 4x4 (159.AP) Petrol 83 03/92 → 03/95

TIPO (160)

2.0 i.e. (160.AT, 160.AJ) Petrol 83 01/93 → 04/95

LANCIA
DEDRA (835)

1.8 i.e. (835BD, 835AD) Petrol 77 09/89 → 07/99

2.0 16V (835ED) Petrol 102 07/94 → 07/99

2.0 HF Integrale (835AP) Petrol 124 11/90 → 07/94

2.0 i.e. (835AL) Petrol 83 09/89 → 07/99

2.0 i.e. Turbo (835AR) Petrol 119 04/91 → 07/99

DEDRA SW (835)

2.0 16V (835ED) Petrol 102 07/94 → 07/99

2.0 Integrale (835ED) Petrol 102 07/94 → 07/99

SEN8I

KW

LANCIA
DELTA II (836)

2.0 16V (836AA, 836CA) Petrol 102 06/93 → 08/99

2.0 16V Turbo (836AB) Petrol 137 06/93 → 08/99

SEN8I3
H1 **SENSORE GIRI / FASE - ALBERO MOTORE**
CRANKSHAFT POSITION SENSOR

KW

ALFA ROMEO
145 (930)

1.4 i.e. Petrol 66 07/94 → 12/96

146 (930)

1.4 i.e. Petrol 66 12/94 → 12/96

FIAT
TEMPRA (159)

1.8 i.e. (159.AV) Petrol 76 09/93 → 08/96

1.8 i.e. (159.BY) Petrol 74 10/94 → 08/96

TEMPRA S.W. (159)

1.8 i.e. (159.AV) Petrol 76 09/93 → 08/96

1.8 i.e. (159.BY) Petrol 74 10/94 → 08/96

TIPO (160)

1.8 i.e. Petrol 66 09/93 → 04/95

1.8 i.e. (160.ED) Petrol 76 04/93 → 04/95

1.8 i.e. (160.EQ, 160.AM) Petrol 74 10/94 → 04/95

LANCIA
DEDRA (835)

1.8 i.e. (835FA) Petrol 74 07/94 → 07/99

DEDRA SW (835)

1.8 i.e. (835FA) Petrol 74 07/94 → 07/99

SEN8I3



LANCIA

DELTA II (836)

1.8 i.e. (836AE)	Petrol	76	06/93 → 08/99
1.8 i.e. (836AG, 836AL)	Petrol	66	07/94 → 08/99

SEN8K3

H1 **SENSORE GIRI / FASE - ALBERO MOTORE**
CRANKSHAFT POSITION SENSOR



SEAT

MARBELLA (28)

0.9 Cat.	Petrol	30	11/96 → 10/98
----------	--------	----	---------------

SEN8M

H1 **SENSORE GIRI / FASE - ALBERO MOTORE**
CRANKSHAFT POSITION SENSOR



FIAT

FIORINO Furgonato (146)

75 i.e. 1.6	Petrol	55	10/93 → 05/01
-------------	--------	----	---------------

TEMPRA (159)

1.4 i.e. (159.AC, 159.AX)	Petrol	51	03/92 → 08/96
1.6	Petrol	63	03/90 → 04/93
1.6 i.e. (159.AE)	Petrol	57	06/90 → 07/92

SEN8M



FIAT

TEMPRA S.W. (159)

1.4 i.e. (159.AC, 159.AX)	Petrol	51	10/92 → 08/96
1.6	Petrol	63	12/90 → 04/93
1.6 i.e. (159.AE)	Petrol	57	10/90 → 08/96

TIPO (160)

1.4 i.e. (160.AP, 160.AD, 160.EA)	Petrol	51	05/89 → 04/95
1.6 i.e.	Petrol	66	02/88 → 05/91

UNO (146A/E)

70 i.e. 1.4	Petrol	51	09/89 → 12/93
-------------	--------	----	---------------

LANCIA

DEDRA (835)

1.6 i.e. (835AB)	Petrol	57	08/89 → 03/93
------------------	--------	----	---------------

DELTA II (836)

1.4 i.e. (836AF, 836AH)	Petrol	51	10/94 → 08/99
-------------------------	--------	----	---------------

SEN8U

H1 **SENSORE GIRI / FASE - ALBERO MOTORE**
CRANKSHAFT POSITION SENSOR



ALFA ROMEO

145 (930)

1.9 JTD	Diesel	77	02/99 → 01/01
1.9 TD	Diesel	66	10/94 → 02/99

146 (930)

1.9 JTD	Diesel	77	02/99 → 01/01
1.9 TD	Diesel	66	12/94 → 02/99

155 (167)

1.9 TD (167.A3)	Diesel	66	04/93 → 12/97
-----------------	--------	----	---------------

FIAT

PALIO Weekend (178DX)

1.7 TD (178DX.H1A)	Diesel	51	04/96 → 03/01
--------------------	--------	----	---------------

SEN8U

KW

FIAT
PUNTO (176)

1.7 D	Diesel	42	04/94 → 09/97
1.7 TD	Diesel	51	01/94 → 09/99
1.7 TD	Diesel	52	01/94 → 09/99

PUNTO Van (176L)

1.7 D	Diesel	42	04/96 → 02/00
1.7 TD	Diesel	52	04/96 → 02/00

LANCIA
DEDRA (835)

1.9 TDS (835EE, 835EF)	Diesel	66	04/89 → 07/99
------------------------	--------	----	---------------

DEDRA SW (835)

1.9 TDS (835EE, 835EF)	Diesel	66	07/94 → 07/99
------------------------	--------	----	---------------

DELTA II (836)

1.9 TD (836AM, 836AN)	Diesel	66	10/94 → 08/99
-----------------------	--------	----	---------------

SAC001
H2
**SENSORE POSIZIONE ALBERO A CAM
CAMSHAFT POSITION SENSOR**

KW

FORD
FIESTA V (JH_, JD_)

ST150	Petrol	110	03/05 → 06/08	ENGINE: DURATECDOHCEFI
-------	--------	-----	---------------	---------------------------

FOCUS C-MAX

1.8	Petrol	88	10/03 → 03/07
1.8	Petrol	92	04/04 → 03/07
1.8 Flexifuel	Petrol/ Ethanol	92	01/06 → 03/07

FOCUS II (DA_)

1.8 Flexifuel	Petrol/ Ethanol	92	01/06 →
---------------	--------------------	----	---------

SAC001

KW

FORD
FOCUS II Station wagon (DA_)

1.8 Flexifuel	Petrol/ Ethanol	92	01/06 →
---------------	--------------------	----	---------

FOCUS II Tre volumi (DA_)

1.8 Flexifuel	Petrol/ Ethanol	92	06/06 →
2.0	Petrol	107	04/05 →

MONDEO III (B5Y)

1.8 16V	Petrol	81	11/00 → 08/07	ENGINE: DURATECDOHCEFI
1.8 16V	Petrol	92	11/00 → 08/07	ENGINE: DURATECDOHCEFI
2.0 16V	Petrol	107	11/00 → 08/07	ENGINE: DURATECDOHCEFI

MONDEO III Station wagon (BWY)

1.8 16V	Petrol	81	11/00 → 08/07	ENGINE: DURATECDOHCEFI
1.8 16V	Petrol	92	11/00 → 08/07	ENGINE: DURATECDOHCEFI
2.0 16V	Petrol	107	11/00 → 08/07	ENGINE: DURATECDOHCEFI

MONDEO III Tre volumi (B4Y)

1.8 16V	Petrol	81	11/00 → 08/07	ENGINE: DURATECDOHCEFI
1.8 16V	Petrol	92	11/00 → 08/07	ENGINE: DURATECDOHCEFI
2.0 16V	Petrol	107	11/00 → 08/07	ENGINE: DURATECDOHCEFI

SAC002

H2

**SENSORE POSIZIONE ALBERO A CAM
CAMSHAFT POSITION SENSOR**



KW



FORD

ESCORT CLASSIC (AAL, ABL)

1.6 16V	Petrol	66	10/98 → 07/00
---------	--------	----	---------------

ESCORT CLASSIC Turnier (ANL)

1.6 16V	Petrol	66	02/99 → 07/00
---------	--------	----	---------------

ESCORT V (GAL)

1.8 16V XR3i	Petrol	77	02/92 → 12/92	ENGINE: ZETEC-EDOHCEFI
--------------	--------	----	---------------	---------------------------

1.8 16V XR3i	Petrol	96	02/92 → 12/92	ENGINE: ZETEC-EDOHCEFI
--------------	--------	----	---------------	---------------------------

ESCORT V Cabriolet (ALL)

1.8 16V XR3i	Petrol	77	02/92 → 12/92	ENGINE: ZETEC-EDOHCEFI
--------------	--------	----	---------------	---------------------------

1.8 16V XR3i	Petrol	96	02/92 → 12/92	ENGINE: ZETEC-EDOHCEFI
--------------	--------	----	---------------	---------------------------

ESCORT V Station wagon (GAL, AVL)

1.8 16V	Petrol	77	02/92 → 12/92	ENGINE: ZETEC-EDOHCEFI
---------	--------	----	---------------	---------------------------

ESCORT VI (GAL)

1.6 i 16V	Petrol	65	01/94 → 01/95
-----------	--------	----	---------------

1.6 i 16V	Petrol	66	09/92 → 01/95
-----------	--------	----	---------------

1.8 16V XR3i	Petrol	96	09/92 → 01/95	ENGINE: ZETEC-EDOHCEFI
--------------	--------	----	---------------	---------------------------

1.8 i 16V	Petrol	77	09/92 → 01/95
-----------	--------	----	---------------

1.8 XR3i 16V 4x4	Petrol	77	08/93 → 01/95	ENGINE: ZETEC-EDOHCEFI
------------------	--------	----	---------------	---------------------------

1.8 XR3i 16V 4x4	Petrol	96	08/93 → 01/95	ENGINE: ZETEC-EDOHCEFI
------------------	--------	----	---------------	---------------------------

ESCORT VI Cabriolet (ALL)

1.6 16V XR3i	Petrol	66	12/92 → 01/95
--------------	--------	----	---------------

1.8 16V XR3i	Petrol	77	12/92 → 01/95	ENGINE: ZETEC-EDOHCEFI
--------------	--------	----	---------------	---------------------------

1.8 16V XR3i	Petrol	96	12/92 → 01/95	ENGINE: ZETEC-EDOHCEFI
--------------	--------	----	---------------	---------------------------

SAC002



KW



FORD

ESCORT VI Station wagon (GAL)

1.6 i 16V	Petrol	66	09/92 → 01/95
-----------	--------	----	---------------

1.8 i 16V	Petrol	77	01/93 → 01/95
-----------	--------	----	---------------

1.8 i 16V	Petrol	96	02/93 → 01/95
-----------	--------	----	---------------

ESCORT VI Tre volumi (GAL)

1.6 i 16V	Petrol	66	08/93 → 01/95
-----------	--------	----	---------------

1.8 i 16V	Petrol	77	08/93 → 01/95
-----------	--------	----	---------------

ESCORT VII (GAL, AAL, ABL)

1.6 16V	Petrol	66	01/95 → 10/98
---------	--------	----	---------------

1.6 16V 4x4	Petrol	66	01/95 → 10/98
-------------	--------	----	---------------

1.8 16V	Petrol	77	01/95 → 08/95	ENGINE: ZETEC-EDOHCEFI
---------	--------	----	---------------	---------------------------

1.8 16V	Petrol	85	01/95 → 10/98	ENGINE: ZETEC-EDOHCEFI
---------	--------	----	---------------	---------------------------

ESCORT VII Cabriolet (ALL)

1.6 16V XR3i	Petrol	65	02/95 → 12/96
--------------	--------	----	---------------

1.6 16V XR3i	Petrol	66	02/95 → 09/99
--------------	--------	----	---------------

1.8 16V XR3i	Petrol	85	10/95 → 08/98	ENGINE: ZETEC-EDOHCEFI
--------------	--------	----	---------------	---------------------------

ESCORT VII Station wagon (GAL, ANL)

1.6 16V	Petrol	66	01/95 → 02/99
---------	--------	----	---------------

1.8 16V	Petrol	77	01/95 → 08/95	ENGINE: ZETEC-EDOHCEFI
---------	--------	----	---------------	---------------------------

1.8 16V	Petrol	85	01/95 → 02/99	ENGINE: ZETEC-EDOHCEFI
---------	--------	----	---------------	---------------------------

ESCORT VII Tre volumi (GAL, AFL)

1.6 i 16V	Petrol	66	01/95 → 02/99
-----------	--------	----	---------------

1.8 16V	Petrol	77	01/95 → 08/95
---------	--------	----	---------------

1.8 16V	Petrol	85	01/95 → 02/99	ENGINE: ZETEC-EDOHCEFI
---------	--------	----	---------------	---------------------------

FIESTA III (GFJ)

1.6 i 16V	Petrol	65	01/94 → 12/95
-----------	--------	----	---------------

1.8 16V	Petrol	77	02/92 → 12/95	ENGINE: ZETEC-EDOHCEFI
---------	--------	----	---------------	---------------------------

1.8 XR2i 16V	Petrol	96	02/92 → 12/95	ENGINE: ZETEC-EDOHCEFI
--------------	--------	----	---------------	---------------------------

FOCUS (DAW, DBW)

1.8 16V	Petrol	85	10/98 → 11/04	ENGINE: ZETEC-EDOHCEFI
---------	--------	----	---------------	---------------------------

2.0 16V	Petrol	96	10/98 → 11/04	ENGINE: ZETEC-EDOHCEFI
---------	--------	----	---------------	---------------------------

RS	Petrol	158	10/02 → 11/04
----	--------	-----	---------------

SAC002

FORD
FOCUS Station wagon (DNW)

1.8 16V	Petrol	85	02/99 → 11/04	ENGINE: ZETEC-EDOHCEFI
---------	--------	----	---------------	---------------------------

2.0 16V	Petrol	96	02/99 → 11/04	ENGINE: ZETEC-EDOHCEFI
---------	--------	----	---------------	---------------------------

FOCUS Tre volumi (DFW)

1.8 16V	Petrol	85	02/99 → 11/04	ENGINE: ZETEC-EDOHCEFI
---------	--------	----	---------------	---------------------------

2.0 16V	Petrol	96	02/99 → 11/04	ENGINE: ZETEC-EDOHCEFI
---------	--------	----	---------------	---------------------------

MAVERICK

2.0 16V	Petrol	91	02/01 →	ENGINE: ZETEC-EDOHCEFI
---------	--------	----	---------	---------------------------

MONDEO I (GBP)

1.6 i 16V	Petrol	65	07/94 → 08/96	
-----------	--------	----	---------------	--

1.6 i 16V	Petrol	66	02/93 → 08/96	
-----------	--------	----	---------------	--

1.8 i 16V	Petrol	82	07/94 → 08/96	
-----------	--------	----	---------------	--

1.8 i 16V	Petrol	85	02/93 → 08/96	
-----------	--------	----	---------------	--

1.8 i 16V 4x4	Petrol	85	02/93 → 08/96	ENGINE: ZETEC-EDOHCEFI
---------------	--------	----	---------------	---------------------------

2.0 i 16V	Petrol	100	02/93 → 08/96	ENGINE: ZETEC-EDOHCEFI
-----------	--------	-----	---------------	---------------------------

2.0 i 16V	Petrol	97	12/94 → 08/96	ENGINE: ZETEC-EDOHCEFI
-----------	--------	----	---------------	---------------------------

MONDEO I Station wagon (BNP)

1.6 i 16V	Petrol	65	07/94 → 08/96	
-----------	--------	----	---------------	--

1.6 i 16V	Petrol	66	04/93 → 08/96	
-----------	--------	----	---------------	--

1.8 i 16V	Petrol	82	07/94 → 08/96	
-----------	--------	----	---------------	--

1.8 i 16V	Petrol	85	04/93 → 08/96	
-----------	--------	----	---------------	--

1.8 i 16V 4x4	Petrol	85	04/93 → 08/96	ENGINE: ZETEC-EDOHCEFI
---------------	--------	----	---------------	---------------------------

2.0 i 16V	Petrol	100	04/93 → 08/96	ENGINE: ZETEC-EDOHCEFI
-----------	--------	-----	---------------	---------------------------

2.0 i 16V 4x4	Petrol	100	04/93 → 08/96	ENGINE: ZETEC-EDOHCEFI
---------------	--------	-----	---------------	---------------------------

MONDEO I Tre volumi (GBP)

1.6 i 16V	Petrol	65	07/94 → 08/96	
-----------	--------	----	---------------	--

1.6 i 16V	Petrol	66	02/93 → 08/96	
-----------	--------	----	---------------	--

1.8 i 16V	Petrol	82	01/94 → 08/96	
-----------	--------	----	---------------	--

1.8 i 16V	Petrol	85	02/93 → 08/96	
-----------	--------	----	---------------	--

2.0 i 16V	Petrol	100	02/93 → 08/96	ENGINE: ZETEC-EDOHCEFI
-----------	--------	-----	---------------	---------------------------

2.0 i 16V 4x4	Petrol	97	12/94 → 08/96	ENGINE: ZETEC-EDOHCEFI
---------------	--------	----	---------------	---------------------------

SAC002

FORD
MONDEO II (BAP)

1.6 i 16V	Petrol	70	05/98 → 11/00	
-----------	--------	----	---------------	--

MONDEO II Station wagon (BNP)

1.6 i 16V	Petrol	70	05/98 → 11/00	
-----------	--------	----	---------------	--

MONDEO II Tre volumi (BFP)

1.6 i 16V	Petrol	70	05/98 → 11/00	
-----------	--------	----	---------------	--

ORION III (GAL)

1.6 i 16V	Petrol	66	07/92 → 12/93	
-----------	--------	----	---------------	--

1.8 i 16V	Petrol	77	02/92 → 12/93	ENGINE: ZETEC-EDOHCEFI
-----------	--------	----	---------------	------------------------

TRANSIT CONNECT (P65_, P70_, P80_)

1.8 16V	Petrol	85	06/02 →	ENGINE: ZETEC-EDOHCEFI
---------	--------	----	---------	------------------------

SAC003
H2
**SENSORE POSIZIONE ALBERO A CAM
CAMSHAFT POSITION SENSOR**

FORD
ESCORT VII (GAL, AAL, ABL)

1.3	Petrol	44	01/95 → 10/98	ENGINE: EFIZETEC-S
-----	--------	----	---------------	--------------------

ESCORT VII Station wagon (GAL, ANL)

1.3	Petrol	44	01/95 → 01/99	ENGINE: EFIZETEC-S
-----	--------	----	---------------	--------------------

ESCORT VII Tre volumi (GAL, AFL)

1.3	Petrol	44	01/95 → 02/99	ENGINE: EFIZETEC-S
-----	--------	----	---------------	--------------------

FIESTA IV (JA_, JB_)

1.25 i 16V	Petrol	55	08/95 → 01/02	ENGINE: ZETEC-S
------------	--------	----	---------------	-----------------

1.3 i	Petrol	37	08/95 → 01/02	ENGINE: EFIZETEC-S
-------	--------	----	---------------	--------------------

1.3 i	Petrol	44	08/95 → 01/02	ENGINE: EFIZETEC-S
-------	--------	----	---------------	--------------------

1.6 16V Sport	Petrol	76	02/00 → 01/02	ENGINE: ZETECEFI
---------------	--------	----	---------------	------------------

FOCUS (DAW, DBW)

1.4 16V	Petrol	55	10/98 → 11/04	ENGINE: ZETEC-S
---------	--------	----	---------------	-----------------

1.6 16V	Petrol	74	10/98 → 11/04	ENGINE: ZETECEFI
---------	--------	----	---------------	------------------

SAC003



FORD

FOCUS Station wagon (DNW)

1.4 16V	Petrol	55	02/99 → 11/04	ENGINE: ZETEC-S
1.6 16V	Petrol	74	02/99 → 11/04	ENGINE: ZETECEFI

FOCUS Tre volumi (DFW)

1.4 16V	Petrol	55	02/99 → 11/04	ENGINE: ZETEC-S
1.6 16V	Petrol	74	02/99 → 11/04	ENGINE: ZETECEFI

KA (RB_)

1.3 i	Petrol	36	06/98 → 11/08	ENGINE: EFIZETEC-S
-------	--------	----	---------------	--------------------

PUMA (EC_)

1.4 16V	Petrol	66	11/97 → 10/00	ENGINE: ZETEC-S
1.6 16V	Petrol	76	08/00 → 06/02	ENGINE: ZETECEFI

SCORPIO II (GFR, GGR)

2.0 i	Petrol	85	10/94 → 08/98	
2.0 i 16V	Petrol	100	10/94 → 08/98	

SCORPIO II Station wagon (GNR, GGR)

2.0 i	Petrol	85	10/94 → 08/98	
2.0 i 16V	Petrol	100	10/94 → 08/98	

TRANSIT Autobus (FD_-, FB_-, FS_-, FZ_-, FC_)

2.3 16V [RWD] (F_B_, F_C_, F_A_)	Petrol	107	08/00 → 05/06	
-------------------------------------	--------	-----	---------------	--

TRANSIT Furgonato (E_)

2.0 (EAL, EAS)	Petrol	84	06/94 → 03/00	
----------------	--------	----	---------------	--

TRANSIT Furgonato (FA_)

2.3 16V [RWD] (FAA_, FAB_, FAC_)	Petrol	107	04/01 → 05/06	
-------------------------------------	--------	-----	---------------	--

TRANSIT Pianale piatto/Telaio (E_)

2.0 (EME/L/S, ENE/L/S)	Petrol	84	08/94 → 03/00	
------------------------	--------	----	---------------	--

TRANSIT Pianale piatto/Telaio (FM_-, FN_)

2.3 16V (F_A_, F_B_, F_C_, F_D_)	Petrol	107	04/01 → 05/06	
----------------------------------	--------	-----	---------------	--

SAC004

H2 **SENSORE POSIZIONE ALBERO A CAM**
CAMSHAFT POSITION SENSOR

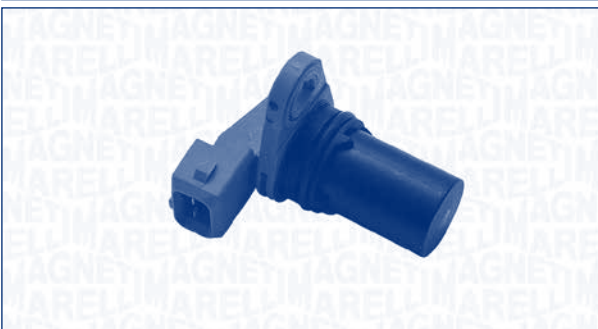

FORD

FIESTA IV (JA_, JB_)

1.25 i 16V	Petrol	55	08/95 → 01/02	
------------	--------	----	---------------	--

FOCUS (DAW, DBW)

1.4 16V	Petrol	55	10/98 → 11/04	
---------	--------	----	---------------	--

FOCUS Station wagon (DNW)

1.4 16V	Petrol	55	02/99 → 11/04	
---------	--------	----	---------------	--

FOCUS Tre volumi (DFW)

1.4 16V	Petrol	55	02/99 → 11/04	
---------	--------	----	---------------	--

SAC011

H2 **SENSORE POSIZIONE ALBERO A CAM**
CAMSHAFT POSITION SENSOR



AUDI

A1 (8X1, 8XF)

1.2 TFSI	Petrol	63	05/10 →	
1.4 TFSI	Petrol	136	01/11 →	
1.4 TFSI	Petrol	90	05/10 →	

A1 Sportback (8XA, 8XK)

1.2 TFSI	Petrol	63	01/12 →	
1.4 TFSI	Petrol	136	11/11 →	
1.4 TFSI	Petrol	90	11/11 →	

A2 (8Z0)

1.6 FSI	Petrol	81	05/02 → 08/05	
---------	--------	----	---------------	--

SAC011

AUDI
A3 (8P1)

1.2 TSI	Petrol	77	04/10 → 08/12
1.4 TFSI	Petrol	92	09/07 → 08/12
1.6 FSI	Petrol	85	08/03 → 09/07
3.2 V6 quattro	Petrol	184	07/03 → 05/09

A3 Cabriolet (8P7)

1.2 TFSI	Petrol	77	03/10 → 05/13
1.4 TFSI	Petrol	92	02/11 → 05/13

A3 Sportback (8PA)

1.2 TSI	Petrol	77	04/10 → 03/13
1.4 TFSI	Petrol	92	09/07 → 03/13
1.6 FSI	Petrol	85	09/04 → 09/07
3.2 V6 quattro	Petrol	184	09/04 → 05/09

A8 (4H_)

6.3 W12 quattro	Petrol	368	01/11 →
-----------------	--------	-----	---------

Q7 (4L)

3.6 FSI	Petrol	206	08/06 → 05/10
---------	--------	-----	---------------

TT (8J3)

3.2 V6 quattro	Petrol	184	08/06 → 06/10
----------------	--------	-----	---------------

TT Roadster (8J9)

3.2 V6 quattro	Petrol	184	03/07 → 06/10
----------------	--------	-----	---------------

SEAT
ALHAMBRA (710)

1.4 TSI	Petrol	110	06/10 →
---------	--------	-----	---------

ALTEA (5P1)

1.4 TSI	Petrol	92	11/07 →
---------	--------	----	---------

ALTEA XL (5P5, 5P8)

1.4 TSI	Petrol	92	11/07 →
---------	--------	----	---------

CORDOBA (6L2)

1.2	Petrol	47	10/02 → 06/06
1.2 12V	Petrol	51	05/06 → 11/09
1.4 16V	Petrol	55	09/02 → 12/07
1.4 16V	Petrol	74	10/02 → 12/05

IBIZA IV (6L1)

1.2	Petrol	44	06/07 → 05/08
1.2	Petrol	47	02/02 → 06/06
1.2 12V	Petrol	51	05/06 → 11/09
1.6	Petrol	74	02/03 → 11/09
1.6 16V	Petrol	77	11/06 → 11/09

IBIZA V (6J5)

1.2	Petrol	44	07/09 →
1.2	Petrol	51	03/08 →
1.4 TSI	Petrol	110	06/09 →
1.6	Petrol	77	05/08 →

SAC011

SEAT
IBIZA V (6J5)

1.6 LPG	Petrol/ LPG	60	05/11 →
---------	----------------	----	---------

IBIZA V SPORTCOUPE (6J1)

1.2	Petrol	44	07/09 →
1.2	Petrol	51	07/08 →
1.4 TSI	Petrol	110	06/09 →
1.4 TSI Cupra	Petrol	132	06/09 →
1.6	Petrol	77	07/08 →
1.6 LPG	Petrol/ LPG	60	05/11 →

IBIZA V ST (6J8)

1.2	Petrol	44	05/10 →
1.2	Petrol	51	05/10 →
1.6	Petrol	77	02/12 →

LEON (1M1)

1.4 16V	Petrol	55	11/99 → 06/06
1.4 TSI	Petrol	92	11/07 →

TOLEDO II (1M2)

1.4 16V	Petrol	55	11/99 → 05/06
---------	--------	----	---------------

SKODA
FABIA

1.2	Petrol	44	12/06 →
1.2	Petrol	51	01/07 →
1.2 12V	Petrol	44	11/11 →
1.2 TSI	Petrol	63	03/10 →
1.2 TSI	Petrol	77	03/10 →
1.4 TSI RS	Petrol	132	05/10 →

FABIA (6Y2)

1.2	Petrol	40	08/02 → 03/08
1.2	Petrol	47	01/03 → 03/08

FABIA Combi

1.2	Petrol	44	10/07 →
1.2	Petrol	51	10/07 →
1.2 12V	Petrol	44	11/11 →
1.2 TSI	Petrol	63	03/10 →
1.2 TSI	Petrol	77	03/10 →
1.4 TSI RS	Petrol	132	05/10 →

FABIA Combi (6Y5)

1.2	Petrol	40	07/01 → 12/07
1.2	Petrol	47	01/03 → 12/07

FABIA Praktik

1.2	Petrol	40	07/01 → 12/07
1.2	Petrol	47	01/03 → 12/07

SAC011



KW



SKODA

FABIA Tre volumi (6Y3)

1.2	Petrol	40	07/01 → 12/07
1.2	Petrol	47	01/03 → 12/07

OCTAVIA (1Z3)

1.2 TSI	Petrol	77	02/10 →
1.4 TSI	Petrol	90	11/08 →
1.6 FSI	Petrol	85	05/04 → 10/08

OCTAVIA Combi (1Z5)

1.2 TSI	Petrol	77	02/10 →
1.4 TSI	Petrol	90	11/08 →
1.6 FSI	Petrol	85	09/04 → 10/08

ROOMSTER (5J)

1.2	Petrol	47	05/06 → 01/07
1.2	Petrol	51	01/07 →
1.2 TSI	Petrol	63	03/10 →
1.2 TSI	Petrol	77	03/10 →
1.4	Petrol	63	09/06 →
1.6	Petrol	77	09/06 → 12/10

ROOMSTER Praktik (5J)

1.2	Petrol	51	03/07 →
1.2 TSI	Petrol	63	03/10 →
1.4	Petrol	63	03/07 →

SUPERB (3T4)

1.4 TSI	Petrol	92	07/08 →
3.6 V6 4x4	Petrol	191	11/08 →

SUPERB Station wagon (3T5)

1.4 TSI	Petrol	92	10/09 →
3.6 V6 4x4	Petrol	191	10/09 →

YETI (5L)

1.2 TSI	Petrol	77	09/09 →
1.4 TSI	Petrol	90	06/10 →

VOLKSWAGEN

BEETLE (5C1)

1.2 TSI	Petrol	77	07/11 →
1.4 TSI	Petrol	118	10/11 →

BORA (1J2)

1.6 FSI	Petrol	81	01/02 → 05/05
---------	--------	----	---------------

BORA Station wagon (1J6)

1.6 FSI	Petrol	81	01/02 → 05/05
---------	--------	----	---------------

CADDY II Furgonato (9K9A)

60 1.4	Petrol	44	11/95 → 01/04
--------	--------	----	---------------

CADDY II Station wagon (9K9B)

1.4	Petrol	44	11/95 → 01/04
-----	--------	----	---------------

SAC011



KW



VOLKSWAGEN

CADDY III Furgonato (2KA, 2KH, 2CA, 2CH)

1.2 TSI	Petrol	63	09/10 →
1.2 TSI	Petrol	77	09/10 →

CADDY III Station wagon (2KB, 2KJ, 2CB, 2CJ)

1.2 TSI	Petrol	63	09/10 →
1.2 TSI	Petrol	77	09/10 →

CC (358)

3.6 FSI 4motion	Petrol	220	11/11 →
-----------------	--------	-----	---------

EOS (1F7, 1F8)

1.4 TSI	Petrol	118	05/08 → 11/10
1.4 TSI	Petrol	90	11/07 → 11/10
1.6 FSI	Petrol	85	06/06 → 05/08
3.2 V6	Petrol	184	06/08 → 05/09
3.6 V6	Petrol	191	05/09 → 11/10

FOX (5Z1, 5Z3)

1.2	Petrol	40	04/05 →
1.2	Petrol	44	09/10 → 12/11
1.4	Petrol	55	04/05 →

GOLF IV (1J1)

1.6 FSI	Petrol	81	01/02 → 06/05
---------	--------	----	---------------

GOLF IV Variant (1J5)

1.6 FSI	Petrol	81	01/02 → 06/06
---------	--------	----	---------------

GOLF PLUS (5M1, 521)

1.4 FSI	Petrol	66	07/05 →
1.4 TSI	Petrol	103	05/06 → 06/08
1.4 TSI	Petrol	118	06/08 →
1.4 TSI	Petrol	125	05/06 → 06/08
1.4 TSI	Petrol	90	06/07 →
1.6 FSI	Petrol	85	01/05 → 05/08

GOLF V (1K1)

1.4 FSI	Petrol	66	10/03 → 07/06
1.4 TSI	Petrol	103	05/06 → 11/08
1.4 TSI	Petrol	125	11/05 → 11/08
1.4 TSI	Petrol	90	08/07 → 11/08
1.6 FSI	Petrol	85	10/03 → 07/08
3.2	Petrol	184	09/05 → 11/08
3.2 R32 4motion	Petrol	184	11/05 → 11/08

GOLF V Variant (1K5)

1.4 TSI	Petrol	103	06/07 → 07/09
1.4 TSI	Petrol	125	06/07 → 07/09
1.4 TSI	Petrol	118	07/08 → 07/09
1.4 TSI	Petrol	90	06/07 → 07/09

SAC011

VOLKSWAGEN
GOLF VI (5K1)

1.2 TSI	Petrol	63	05/10 → 11/12
1.2 TSI	Petrol	77	05/09 → 11/12
1.4	Petrol	59	10/08 → 11/12
1.4 TSI	Petrol	118	10/08 → 11/12
1.4 TSI	Petrol	90	10/08 → 11/12

GOLF VI Cabriolet (517)

1.2 TSI	Petrol	77	03/11 → 11/13
1.4 TSI	Petrol	118	03/11 →
1.4 TSI	Petrol	90	11/11 →

GOLF VI Variant (AJ5)

1.2 TSI	Petrol	77	08/09 → 07/13
1.4 TSI	Petrol	90	07/09 → 07/13
1.4 TSI	Petrol	118	07/09 → 07/13

JETTA III (1K2)

1.4 TSI	Petrol	118	07/08 → 10/10
1.4 TSI	Petrol	125	07/06 → 10/10
1.4 TSI	Petrol	103	07/06 → 06/08
1.4 TSI	Petrol	90	05/07 → 12/07
1.6 FSI	Petrol	85	09/05 → 10/10

JETTA IV (162, 163)

1.4 TSI	Petrol	118	04/11 →
1.4 TSI	Petrol	90	05/11 →

LUPO (6X1, 6E1)

1.0	Petrol	37	09/98 → 07/05
1.4	Petrol	44	10/00 → 07/05
1.4 FSI	Petrol	77	02/01 → 07/05

PASSAT (362)

1.4 TSI	Petrol	90	08/10 →
---------	--------	----	---------

1.4 TSI EcoFuel	Petrol/ CNG	110	08/10 →
-----------------	----------------	-----	---------

PASSAT (3C2)

1.4 TSI	Petrol	90	05/07 → 07/10
1.4 TSI EcoFuel	BiFuel	110	01/09 → 07/10
1.6 FSI	Petrol	85	03/05 → 06/08
3.2 FSI 4motion	Petrol	184	11/05 → 07/10
3.6 R36 4motion	Petrol	220	04/07 → 07/10

PASSAT CC (357)

1.4 TSI MultiFuel	Petrol/ Ethanol	118	01/11 → 01/12
3.6 FSI 4motion	Petrol	220	06/08 → 05/10

PASSAT Variant (365)

1.4 TSI	Petrol	90	08/10 →
1.4 TSI EcoFuel	BiFuel	110	08/10 →

SAC011

VOLKSWAGEN
PASSAT Variant (3C5)

1.4 TSI	Petrol	90	05/07 → 11/10
1.4 TSI EcoFuel	Petrol/ CNG	110	01/09 → 11/10
1.6 FSI	Petrol	85	08/05 → 06/08
3.2 FSI 4motion	Petrol	184	11/05 → 11/10
3.6 R36 4motion	Petrol	220	04/07 → 11/10

PHAETON (3D_)

6.0 W12 4motion	Petrol	331	05/05 →
-----------------	--------	-----	---------

POLO (6N1)

55 1.4	Petrol	40	01/98 → 10/99
60 1.4	Petrol	44	07/95 → 10/99

POLO (6N2)

1.0	Petrol	37	10/99 → 09/01
1.4	Petrol	40	10/99 → 09/01
1.4	Petrol	44	10/99 → 09/01

POLO (6R, 6C)

1.2	Petrol	44	06/09 →
1.2	Petrol	51	06/09 →
1.2 TSI	Petrol	77	11/09 →
1.4 BiFuel	Petrol/ LPG	60	03/10 → 01/11
1.4 GTi	Petrol	132	05/10 →
1.6 Bifuel	Petrol/ LPG	60	01/11 →

POLO (9N_)

1.2	Petrol	40	01/02 → 05/07
1.2	Petrol	44	05/07 → 11/09
1.2 12V	Petrol	47	10/01 → 07/07
1.2 12V	Petrol	51	05/07 → 11/09
1.4 16V	Petrol	55	10/01 → 05/08
1.4 FSI	Petrol	63	02/02 → 07/06
1.6 16V	Petrol	77	05/06 → 11/09

POLO CLASSIC (6KV2)

60 1.4	Petrol	44	12/95 → 09/01
--------	--------	----	---------------

POLO Tre volumi

1.6	Petrol	63	11/10 → 04/12
1.6	Petrol	77	05/10 →

POLO Tre volumi (9A4)

1.4	Petrol	55	07/03 →
1.6	Petrol	74	09/02 → 05/05

POLO Variant (6KV5)

1.4	Petrol	40	12/98 → 09/01
1.4	Petrol	44	05/97 → 09/01
1.9 TDI	Diesel	66	05/97 → 09/01

SAC011



VOLKSWAGEN

SCIROCCO (137, 138)

1.4 TSI	Petrol	118	05/08 →
1.4 TSI	Petrol	90	08/08 →

SHARAN (7N)

1.4 TSI	Petrol	110	05/10 →
---------	--------	-----	---------

TIGUAN (5N_)

1.4 TSI	Petrol	110	05/08 →
1.4 TSI	Petrol	118	05/11 →
1.4 TSI	Petrol	90	08/10 →
1.4 TSI 4motion	Petrol	110	09/07 →
1.4 TSI 4motion	Petrol	118	05/11 →

TOUAREG (7LA, 7L6, 7L7)

3.6 V6 FSI	Petrol	206	10/05 → 05/10
------------	--------	-----	---------------

TOUAREG (7P5)

3.6 V6 FSI	Petrol	183	08/10 →
3.6 V6 FSI	Petrol	206	04/10 →

TOURAN (1T1, 1T2)

1.4 FSI	Petrol	125	11/06 → 05/10
1.4 TSI	Petrol	103	02/06 → 05/10
1.4 TSI EcoFuel	Petrol/ CNG	110	05/09 → 05/10
1.6 FSI	Petrol	85	02/03 → 01/07

TOURAN (1T3)

1.2 TSI	Petrol	77	05/10 →
---------	--------	----	---------

SAC012

H2 **SENSORE POSIZIONE ALBERO A CAM**
CAMSHAFT POSITION SENSOR



MERCEDES-BENZ

CLASSE A (W168)

A 140 (168.031, 168.131)	Petrol	60	01/01 → 08/04
A 140 (168.031, 168.131)	Petrol	60	07/97 → 08/04

SAC012



MERCEDES-BENZ

CLASSE A (W168)

A 160 (168.033, 168.133)	Petrol	75	07/97 → 08/04
A 160 CDI (168.006)	Diesel	55	02/01 → 08/04
A 160 CDI (168.007)	Diesel	44	07/98 → 02/01
A 170 CDI (168.008)	Diesel	66	07/98 → 02/01
A 170 CDI (168.009, 168.109)	Diesel	70	02/01 → 08/04
A 190 (168.032, 168.132)	Petrol	92	03/99 → 08/04
A 210 (168.035, 168.135)	Petrol	103	03/02 → 08/04

CLASSE A (W169)

A 150 (169.031, 169.331)	Petrol	70	09/04 → 06/12
A 160 (169.031, 169.331)	Petrol	70	04/09 → 06/12
A 160 CDI (169.006, 169.306)	Diesel	60	09/04 → 08/05 ENGINE: → 30134434
A 170 (169.032, 169.332)	Petrol	85	09/04 → 06/12
A 180 (169.032, 169.332)	Petrol	85	04/09 → 06/12
A 180 CDI (169.007, 169.307)	Diesel	80	09/04 → 08/05 ENGINE: → 30134434
A 200 (169.033, 169.333)	Petrol	100	09/04 → 06/12
A 200 CDI (169.008, 169.308)	Diesel	103	09/04 → 08/05 ENGINE: → 30134434
A 200 CDI (169.308)	Diesel	100	09/04 → 06/12
A 200 TURBO (169.034, 169.334)	Petrol	142	09/05 → 06/12

CLASSE B (W245)

B 150 (245.231)	Petrol	70	03/05 → 11/11
B 160 (245.231)	Petrol	70	04/09 → 11/11
B 170 (245.232)	Petrol	85	03/05 → 11/11

SAC012

MERCEDES-BENZ
CLASSE B (W245)

B 170 NGT (245.233)	BiFuel	85	04/08 → 11/11	
B 180 (245.232)	Petrol	85	04/09 → 11/11	
B 180 CDI (245.207)	Diesel	80	03/05 → 08/05	ENGINE: → 30134434
B 180 NGT (245.233)	BiFuel	85	04/08 → 11/11	
B 200 (245.233)	Petrol	100	03/05 → 11/11	
B 200 CDI	Diesel	100	03/05 → 11/11	
B 200 CDI (245.208)	Diesel	103	03/05 → 08/05	ENGINE: → 30134434
B 200 TURBO (245.234)	Petrol	142	03/05 → 11/11	

CLASSE C (W202)

C 200 CDI (202.134)	Diesel	75	03/98 → 05/00	
C 220 CDI (202.133)	Diesel	92	09/97 → 05/00	

CLASSE C (W203)

C 180 Kompressor (203.046)	Petrol	105	05/02 → 02/07	
C 200 CDI	Diesel	75	02/01 → 11/05	ENGINE: → 30497543
C 200 CDI (203.004)	Diesel	85	09/00 → 02/07	
C 200 CDI (203.007)	Diesel	90	04/03 → 11/05	ENGINE: → 30497543
C 200 CGI Kompressor (203.043)	Petrol	125	07/03 → 07/04	
C 200 Kompressor (203.042)	Petrol	120	05/02 → 02/07	
C 220 CDI (203.006)	Diesel	105	05/00 → 02/07	
C 220 CDI (203.006)	Diesel	100	05/00 → 02/07	
C 220 CDI (203.008)	Diesel	110	02/03 → 11/05	ENGINE: → 30497543
C 230 (203.052)	Petrol	150	01/05 → 02/07	
C 230 Kompressor (203.040)	Petrol	141	02/04 → 02/07	
C 240 (203.061)	Petrol	125	05/00 → 12/05	
C 240 4-matic (203.081)	Petrol	125	07/02 → 12/05	

SAC012

MERCEDES-BENZ
CLASSE C (W203)

C 270 CDI (203.016)	Diesel	125	12/00 → 02/07	
C 280 (203.054)	Petrol	170	01/05 → 02/07	
C 280 4-matic (203.092)	Petrol	170	01/05 → 02/07	
C 30 CDI AMG (203.018)	Diesel	170	01/03 → 02/07	
C 32 AMG Kompressor (203.065)	Petrol	260	02/01 → 12/04	
C 320 (203.064)	Petrol	160	05/00 → 07/05	
C 320 4-matic (203.084)	Petrol	160	07/02 → 07/05	
C 320 CDI (203.020)	Diesel	165	01/05 → 10/05	ENGINE: → 40086332
C 350 (203.056)	Petrol	200	01/05 → 02/07	
C 350 4-matic (203.087)	Petrol	200	01/05 → 02/07	
C 55 AMG (203.076)	Petrol	270	02/04 → 02/07	

CLASSE C (W204)

C 180 Kompressor (204.044, 204.045)	Petrol	115	01/08 →	
C 180 Kompressor (204.046)	Petrol	115	01/07 →	
C 200 CDI (204.007)	Diesel	100	01/07 →	
C 200 CGI (204.048)	Petrol	135	01/07 →	
C 200 Kompressor (204.041)	Petrol	135	01/07 →	
C 220 CDI	Diesel	120	04/07 → 11/08	
C 220 CDI (204.008)	Diesel	125	01/07 →	
C 230 (204.052)	Petrol	150	01/07 →	
C 230 4-matic (204.085)	Petrol	150	07/07 →	
C 250 CGI (204.047)	Petrol	150	07/09 →	
C 280 (204.054)	Petrol	170	01/07 →	
C 280 4-matic (204.081)	Petrol	170	07/07 →	
C 300 (204.054)	Petrol	170	07/09 →	

SAC012



MERCEDES-BENZ

CLASSE C (W204)

C 300 4-matic (204.081)	Petrol	170	07/07 →	
C 320 CDI (204.022)	Diesel	165	01/07 →	
C 320 CDI 4-matic (204.089)	Diesel	165	07/07 →	
C 350 (204.056)	Petrol	200	01/07 →	
C 350 4-matic (204.087)	Petrol	200	07/07 →	
C 350 CDI (204.022)	Diesel	165	07/09 →	
C 350 CDI (204.023)	Diesel	195	06/11 →	
C 350 CDI (204.025)	Diesel	170	10/09 →	
C 350 CDI 4-matic (204.089)	Diesel	165	07/09 →	
C 350 CDI 4-matic (204.092)	Diesel	170	10/09 →	
C 350 CGI (204.065)	Petrol	215	09/08 →	
C 63 AMG (204.077)	Petrol	358	01/11 →	

CLASSE C Coupé (C204)

C 180 (204.349)	Petrol	115	06/11 →	
C 250 (204.347)	Petrol	150	06/11 →	
C 63 AMG (204.377)	Petrol	336	06/11 →	
C 63 AMG (204.377)	Petrol	358	01/12 →	
C 63 AMG (204.377)	Petrol	380	01/12 →	

CLASSE C Sportcoupe (CL203)

C 160 Kompressor (203.730)	Petrol	90	09/04 → 07/06	
C 180 Kompressor (203.746)	Petrol	105	05/02 → 05/08	
C 200 CDI (203.707)	Diesel	90	03/03 → 11/05	ENGINE: → 30497543
C 200 CGI Kompressor (203.743)	Petrol	125	03/03 → 05/08	
C 200 Kompressor (203.742)	Petrol	120	08/02 → 04/05	

SAC012



MERCEDES-BENZ

CLASSE C Sportcoupe (CL203)

C 220	Petrol	120	05/02 → 04/05	
C 220 CDI (203.706)	Diesel	105	03/01 → 05/08	
C 220 CDI (203.708)	Diesel	110	02/04 → 11/05	ENGINE: → 30497543
C 230 (203.752)	Petrol	150	01/05 → 05/08	
C 230 Kompressor (203.740)	Petrol	141	05/02 → 05/08	
C 30 CDI AMG (203.718)	Diesel	170	09/02 → 05/08	
C 320 (203.764)	Petrol	160	09/02 → 05/08	
C 350 (203.756)	Petrol	200	01/05 → 05/08	

CLASSE C Station wagon (S202)

C 200 T CDI (202.194)	Diesel	75	03/98 → 03/01	
C 220 T CDI (202.193)	Diesel	92	09/97 → 03/01	
C 240 T (202.086)	Petrol	125	06/97 → 09/00	
C 240 T (202.088)	Petrol	125	09/00 → 03/01	
C 250 T Turbo-D (202.188)	Diesel	110	06/96 → 03/01	
C 280 T (202.089)	Petrol	145	06/97 → 03/01	
C 43 AMG (202.093)	Petrol	225	08/97 → 03/01	

CLASSE C T-Model (S203)

C 180 Kompressor (203.246)	Petrol	105	05/02 → 08/07	
C 200 CDI (203.204)	Diesel	85	03/01 → 08/07	
C 200 CDI (203.204, 203.207)	Diesel	75	03/01 → 11/05	ENGINE: → 30497543
C 200 CDI (203.207)	Diesel	90	04/03 → 11/05	ENGINE: → 30497543
C 200 CGI Kompressor (203.243)	Petrol	125	07/03 → 08/07	
C 200 Kompressor (203.242)	Petrol	120	05/02 → 08/07	
C 220 CDI (203.206)	Diesel	105	03/01 → 08/07	

SAC012

MERCEDES-BENZ
CLASSE C T-Model (S203)

C 220 CDI (203.208)	Diesel	110	02/04 → 11/05	ENGINE: → 30497543
C 230 (203.252)	Petrol	150	01/05 → 08/07	
C 230 Kompressor (203.240)	Petrol	141	02/04 → 07/05	
C 240 (203.261)	Petrol	125	03/01 → 12/05	
C 240 4-matic (203.281)	Petrol	125	07/02 → 12/05	
C 270 CDI (203.216)	Diesel	125	03/01 → 08/07	
C 280 (203.254)	Petrol	170	01/05 → 08/07	
C 280 4-matic (203.292)	Petrol	170	01/05 → 08/07	
C 30 CDI AMG (203.218)	Diesel	170	01/03 → 08/07	
C 32 AMG Kompressor (203.265)	Petrol	260	03/01 → 12/04	
C 320 (203.264, 203.764)	Petrol	160	03/01 → 08/07	
C 320 4-matic (203.284)	Petrol	160	07/02 → 07/05	
C 320 CDI (203.220)	Diesel	165	06/05 → 08/07	
C 350 (203.256)	Petrol	200	01/05 → 08/07	
C 350 4-matic (203.287)	Petrol	200	04/05 → 08/07	
C 55 AMG (203.276)	Petrol	270	02/04 → 08/07	

CLASSE C T-Model (S204)

C 180 Kompressor (204.245)	Petrol	115	01/08 →	
C 180 Kompressor (204.246)	Petrol	115	08/07 →	
C 200 CDI (204.207)	Diesel	100	11/07 →	
C 200 Kompressor (204.241)	Petrol	135	08/07 →	
C 220 CDI	Diesel	120	08/07 → 11/08	
C 220 CDI (204.208)	Diesel	125	11/07 →	
C 230 (204.252)	Petrol	150	11/07 →	
C 250 CGI (204.247)	Petrol	150	07/09 →	

SAC012

MERCEDES-BENZ
CLASSE C T-Model (S204)

C 280 (204.254)	Petrol	170	11/07 →	
C 320 CDI (204.222)	Diesel	165	11/07 →	
C 320 CDI 4-matic (204.289)	Diesel	165	05/08 →	
C 350 (204.256)	Petrol	200	11/07 →	
C 350 CDI (204.223)	Diesel	195	06/11 →	
C 350 CDI (204.225)	Diesel	170	10/09 →	
C 350 CDI 4-matic (204.292)	Diesel	170	10/09 →	
C 63 AMG (204.277)	Petrol	336	02/08 →	
C 63 AMG (204.277)	Petrol	358	01/12 →	

CLASSE CLC (CL203)

CLC 160 (203.731)	Petrol	95	02/09 → 06/11	
CLC 180 Kompressor (203.746)	Petrol	105	05/08 → 06/11	
CLC 200 CDI (203.707)	Diesel	90	05/08 → 06/11	
CLC 200 Kompressor (203.741)	Petrol	135	05/08 → 06/11	
CLC 220 CDI (203.708)	Diesel	110	05/08 → 06/11	
CLC 230 (203.752)	Petrol	150	05/08 → 06/11	
CLC 350 (203.756)	Petrol	200	05/08 → 06/11	

CLASSE E (W210)

E 200 CDI (210.007)	Diesel	75	06/98 → 03/02	
E 200 CDI (210.007)	Diesel	85	07/99 → 03/02	
E 220 CDI	Diesel	100	07/99 → 03/02	
E 220 CDI (210.006)	Diesel	105	07/99 → 03/02	
E 220 CDI (210.006)	Diesel	92	06/98 → 07/99	
E 240 (210.061)	Petrol	125	06/97 → 08/00	

SAC012



MERCEDES-BENZ

CLASSE E (W210)

E 240 (210.062)	Petrol	125	08/00 → 03/02	
E 270 CDI (210.016)	Diesel	125	07/99 → 03/02	
E 320 CDI (210.026)	Diesel	145	07/99 → 03/02	
E 420 (210.072)	Petrol	205	01/96 → 06/97	
E 430 (210.070)	Petrol	205	06/97 → 03/02	
E 430 4-matic (210.083)	Petrol	205	09/99 → 03/02	
E 50 AMG (210.072)	Petrol	255	09/96 → 08/97	
E 55 AMG (210.074)	Petrol	260	08/97 → 03/02	
E 55 AMG 4-matic (210.074)	Petrol	260	03/01 → 03/02	

CLASSE E (W211)

E 200 CDI (211.004)	Diesel	75	07/02 → 11/05	ENGINE: → 30497543
E 200 CDI (211.004)	Diesel	90	07/02 → 11/05	ENGINE: → 30497543
E 200 CDI (211.007)	Diesel	100	04/06 → 12/08	
E 200 CGI	Petrol	125	11/02 → 06/05	
E 200 Kompressor (211.041)	Petrol	135	04/06 → 12/08	
E 200 Kompressor (211.042)	Petrol	120	11/02 → 07/06	
E 200 NGT (211.041)	BiFuel	120	03/04 → 12/08	
E 220 CDI	Diesel	120	03/03 → 12/08	
E 220 CDI (211.006)	Diesel	100	03/02 → 12/08	
E 220 CDI (211.006)	Diesel	110	03/02 → 11/05	ENGINE: → 30497543
E 220 CDI (211.008)	Diesel	125	04/06 → 12/08	
E 230 (211.052)	Petrol	150	09/07 → 12/08	
E 240 (211.061)	Petrol	130	03/02 → 07/06	
E 240 4-matic (211.080)	Petrol	130	08/03 → 07/05	

SAC012



MERCEDES-BENZ

CLASSE E (W211)

E 270 CDI (211.016)	Diesel	130	03/02 → 12/08	
E 270 CDI (211.016)	Diesel	120	03/02 → 12/08	
E 280 (211.054)	Petrol	170	03/05 → 12/08	
E 280 4-matic (211.092)	Petrol	170	01/06 → 12/08	
E 280 CDI (211.020)	Diesel	140	03/05 → 10/05	ENGINE: → 40086332
E 280 CDI (211.023)	Diesel	130	05/04 → 12/08	
E 280 CDI 4-matic	Diesel	140	03/05 → 10/05	ENGINE: → 40086332
E 300 BlueTEC	Diesel	155	09/07 → 12/08	
E 320 (211.065)	Petrol	165	03/02 → 07/04	
E 320 4-matic (211.082)	Petrol	165	08/03 → 07/04	
E 320 CDI (211.022)	Diesel	165	03/05 → 10/05	ENGINE: → 40086332
E 320 CDI (211.026)	Diesel	150	11/02 → 12/08	
E 320 CDI 4-matic	Diesel	165	03/05 → 12/08	
E 350 (211.056)	Petrol	200	03/05 → 12/08	
E 350 4-matic (211.087)	Petrol	200	03/05 → 12/08	
E 350 CGI (211.057)	Petrol	215	09/07 → 12/08	
E 400 CDI (211.028)	Diesel	191	02/03 → 12/08	
E 420 CDI (211.029)	Diesel	231	01/06 → 12/08	
E 500 (211.070)	Petrol	225	03/02 → 06/05	
E 500 (211.072)	Petrol	285	04/06 → 12/08	
E 500 4-matic (211.083)	Petrol	225	10/03 → 12/06	
E 500 4-matic (211.090)	Petrol	285	04/06 → 12/08	
E 55 AMG Kompressor (211.076)	Petrol	350	10/02 → 07/06	
E 63 AMG (211.077, 211.177)	Petrol	378	08/06 → 12/08	

SAC012

MERCEDES-BENZ
CLASSE E (W212)

E 200 CGI (212.048, 212.148)	Petrol	135	08/09 →	
E 200 NGT (212.041)	BiFuel	120	03/11 →	
E 250 CGI (212.047, 212.147)	Petrol	150	01/09 →	
E 300 (212.054)	Petrol	170	01/09 →	
E 300 CDI (212.020)	Diesel	150	03/11 →	
E 300 CDI / BlueTEC (212.020, 212.021)	Diesel	170	03/11 →	
E 350 4-matic (212.087)	Petrol	200	01/09 → 08/11	
E 350 BlueTEC (212.024)	Diesel	155	01/09 →	
E 350 CDI (212.023)	Diesel	195	03/11 →	
E 350 CDI (212.025)	Diesel	170	01/09 →	
E 350 CDI 4-matic (212.089)	Diesel	170	09/09 →	
E 350 CDI 4-matic (212.093)	Diesel	195	03/11 →	
E 350 CGI (212.057)	Petrol	215	01/09 → 08/11	

CLASSE E Cabriolet (A207)

E 200 CGI (207.448)	Petrol	135	01/10 →	
E 250 CGI (207.447)	Petrol	150	01/10 →	
E 350 CDI	Diesel	195	04/11 →	
E 350 CDI (207.422)	Diesel	170	01/10 →	
E 350 CGI (207.457)	Petrol	215	01/10 →	
E 500 (207.472)	Petrol	285	01/10 →	

SAC012

MERCEDES-BENZ
CLASSE E Coupé (C207)

E 200 CGI (207.348)	Petrol	135	01/10 →	
E 250 CGI (207.347)	Petrol	150	01/09 →	
E 350	Petrol	200	05/11 →	
E 350 CDI	Diesel	195	04/11 →	
E 350 CDI (207.322)	Diesel	170	01/09 →	
E 350 CGI (207.357)	Petrol	215	01/09 →	

CLASSE E Station wagon (S210)

E 220 T CDI (210.206)	Diesel	105	07/99 → 03/03	
E 220 T CDI (210.206)	Diesel	92	06/98 → 07/99	
E 240 T (210.261)	Petrol	125	10/97 → 03/03	
E 240 T (210.262)	Petrol	125	08/00 → 03/03	
E 270 T CDI (210.216)	Diesel	125	07/99 → 03/03	
E 280 T (210.263)	Petrol	150	11/97 → 03/03	
E 320 T CDI (210.226)	Diesel	145	07/99 → 03/03	
E 420 T (210.272)	Petrol	205	06/96 → 06/97	
E 430 T (210.270)	Petrol	205	11/97 → 03/03	
E 430 T 4-matic (210.283)	Petrol	205	09/99 → 03/03	
E 55 T AMG (210.274)	Petrol	260	11/97 → 03/03	
E 55 T AMG 4-matic (210.283)	Petrol	260	03/01 → 03/03	

CLASSE E T-Model (S211)

350 CGI (211.257)	Petrol	215	05/06 → 07/09	
E 200 CDI (211.207)	Diesel	100	04/06 → 07/09	
E 200 Kompressor (211.241)	Petrol	135	04/06 → 07/09	
E 200 T Kompressor (211.242)	Petrol	120	03/03 → 07/06	
E 220 CDI (211.206)	Diesel	100	03/03 → 11/05	ENGINE: → 30497543
E 220 T CDI	Diesel	120	03/03 → 07/09	
E 220 T CDI (211.206)	Diesel	110	03/03 → 11/05	ENGINE: → 30497543

SAC012



KW



MERCEDES-BENZ

CLASSE E T-Model (S211)

E 220 T CDI (211.208)	Diesel	125	04/06 → 07/09	
E 230 T (211.252)	Petrol	150	05/07 → 07/09	
E 240 T (211.261)	Petrol	130	06/03 → 07/09	
E 240 T 4-matic (211.280)	Petrol	130	07/03 → 07/09	
E 270 T CDI (211.216)	Diesel	130	03/03 → 07/09	
E 280 T (211.254)	Petrol	170	03/05 → 07/09	
E 280 T 4-matic (211.292)	Petrol	170	03/05 → 07/09	
E 280 T CDI (211.220)	Diesel	140	03/05 → 10/05	ENGINE: → 40086332
E 280 T CDI (211.223)	Diesel	130	05/04 → 07/09	
E 280 T CDI 4-matic (211.284)	Diesel	140	03/05 → 10/05	ENGINE: → 40086332
E 320 T (211.265)	Petrol	165	03/03 → 07/09	
E 320 T 4-matic (211.282)	Petrol	165	07/03 → 07/09	
E 320 T CDI (211.222)	Diesel	165	03/05 → 10/05	ENGINE: → 40086332
E 320 T CDI (211.226)	Diesel	150	03/03 → 07/09	
E 320 T CDI 4-matic (211.289)	Diesel	165	03/05 → 10/05	ENGINE: → 40086332
E 350 T (211.256)	Petrol	200	03/05 → 07/09	
E 350 T 4-matic (211.287)	Petrol	200	03/05 → 07/09	
E 500 T (211.270)	Petrol	225	10/03 → 07/09	
E 500 T (211.272)	Petrol	285	04/06 → 07/09	
E 500 T 4-matic (211.283)	Petrol	225	10/03 → 07/09	
E 500 T 4-matic (211.290)	Petrol	285	04/06 → 07/09	
E 55 T AMG Kompressor (211.276)	Petrol	350	07/03 → 07/09	

CLASSE E T-Model (S212)

E 200 CGI (212.248)	Petrol	135	11/09 →	
E 250 CGI (212.247)	Petrol	150	11/09 →	

SAC012



KW



MERCEDES-BENZ

CLASSE E T-Model (S212)

E 300 CDI (212.220)	Diesel	150	03/11 →	
E 350 (212.256)	Petrol	200	08/09 →	
E 350 4-matic (212.287)	Petrol	200	11/09 →	
E 350 BlueTEC (212.224)	Diesel	155	11/09 →	
E 350 CDI (212.223)	Diesel	195	07/11 →	
E 350 CDI (212.225)	Diesel	170	11/09 →	
E 350 CDI 4-matic (212.289)	Diesel	170	11/09 →	
E 350 CDI 4-matic (212.293)	Diesel	195	07/11 →	
E 350 CGI (212.257)	Petrol	215	11/09 →	

CLASSE G (W463)

G 270 CDI (463.322, 463.323)	Diesel	115	10/01 →	
G 400 CDI (463.332, 463.333)	Diesel	184	12/00 →	

CLASSE G Cabrio (W463)

G 400 CDI (463.309)	Diesel	184	12/00 →	
---------------------	--------	-----	---------	--

CLASSE GL (X164)

GL 320 CDI / 350 BlueTEC 4-matic (164.824, 164.825)	Diesel	155	12/09 →	
GL 320 CDI 4-matic (164.822)	Diesel	165	09/06 → 05/09	
GL 350 CDI (164.823)	Diesel	195	10/10 →	
GL 350 CDI 4-matic (164.822)	Diesel	165	05/09 →	
GL 420 CDI 4-matic (164.828)	Diesel	225	09/06 → 05/09	
GL 450 4-matic (164.871)	Petrol	250	09/06 →	
GL 500 4-matic (164.886)	Petrol	285	09/06 →	

SAC012

MERCEDES-BENZ
CLASSE GLK (X204)

280 4-matic (204.981)	Petrol	170	06/08 → 06/09	
300 4-matic (204.981)	Petrol	170	07/09 → 04/11	
320 CDI 4-matic (204.983)	Diesel	165	06/08 →	
350 (204.956)	Petrol	200	04/09 →	
350 4-matic (204.987)	Petrol	200	06/08 → 04/11	
350 CDI 4-matic (204.992)	Diesel	165	07/09 → 01/10	
350 CDI 4-matic (204.992)	Diesel	170	02/10 → 05/10	
350 CDI 4-matic (204.993)	Diesel	195	07/12 →	

CLASSE M (W163)

ML 270 CDI (163.113)	Diesel	120	12/99 → 06/05	
ML 320 (163.154)	Petrol	160	02/98 → 08/02	
ML 350	Petrol	173	02/03 → 06/05	
ML 350 (163.157)	Petrol	180	08/02 → 06/05	
ML 400 CDI (163.128)	Diesel	184	09/01 → 06/05	
ML 430 (163.172)	Petrol	200	11/98 → 06/05	
ML 500 (163.175)	Petrol	215	09/01 → 06/05	
ML 55 AMG (163.174)	Petrol	255	02/00 → 06/05	

CLASSE M (W164)

ML 280 CDI 4-matic (164.120)	Diesel	140	07/05 → 10/05	ENGINE: → 40086332
ML 300 CDI 4-matic (164.120)	Diesel	140	07/09 →	
ML 300 CDI 4-matic (164.121)	Diesel	150	02/10 →	
ML 320 CDI 4-matic (164.122)	Diesel	165	07/05 → 10/05	ENGINE: → 40086332
ML 350 4-matic (164.186)	Petrol	200	07/05 →	
ML 350 CDI 4-matic	Diesel	155	09/09 →	
ML 350 CDI 4-matic (164.122)	Diesel	165	07/09 →	
ML 350 CDI 4-matic (164.125)	Diesel	170	02/10 →	

SAC012

MERCEDES-BENZ
CLASSE M (W164)

ML 420 CDI 4-matic (164.128)	Diesel	225	02/06 → 09/09	
ML 500 4-matic (164.175)	Petrol	225	07/05 → 12/07	

CLASSE M (W166)

ML 350 BlueTec 4-matic (166.024)	Diesel	190	06/11 →	
----------------------------------	--------	-----	---------	--

CLASSE R (W251, V251)

R 280 (251.054, 251.154)	Petrol	170	01/07 →	
R 280 4-matic (251.062)	Petrol	170	05/07 →	
R 280 CDI (251.121, 251.026, 251.126)	Diesel	140	05/06 →	
R 280 CDI 4-matic (251.020)	Diesel	140	05/06 →	
R 300 (251.054, 251.154)	Petrol	170	07/09 →	
R 300 CDI (251.021, 251.121, 251.026, 251.126)	Diesel	140	07/09 →	
R 300 CDI 4-matic (251.020)	Diesel	140	07/09 →	
R 320 CDI 4-matic (251.022, 251.122)	Diesel	165	01/06 →	
R 350 (251.056, 251.156)	Petrol	200	01/07 →	
R 350 4-matic (251.065, 251.165)	Petrol	200	01/06 →	
R 350 CDI 4-matic (251.022, 251.122)	Diesel	165	07/09 →	
R 350 CDI 4-matic (251.124, 251.125)	Diesel	155	01/06 →	
R 500 4-matic (251.072, 251.172)	Petrol	285	01/07 →	
R 500 4-matic (251.075, 251.175)	Petrol	225	01/06 →	

SAC012



KW



MERCEDES-BENZ

CLASSE S (W220)

S 280 (220.063, 220.163)	Petrol	150	02/99 → 08/05	
S 320 (220.065, 220.165)	Petrol	165	02/99 → 08/02	
S 320 CDI (220.025, 220.125)	Diesel	150	09/02 → 08/05	
S 320 CDI (220.026, 220.126)	Diesel	145	08/99 → 09/02	
S 350 (220.067, 220.167)	Petrol	180	09/02 → 08/05	
S 350 4-matic (220.087, 220.187)	Petrol	180	06/03 → 08/05	
S 400 CDI (220.028, 220.128)	Diesel	184	06/00 → 08/05	
S 400 CDI (220.028, 220.128)	Diesel	191	06/03 → 08/05	
S 430 (220.070, 220.170)	Petrol	205	10/98 → 08/05	
S 430 4-matic (220.083, 220.183)	Petrol	205	09/02 → 08/05	
S 500 (220.075, 220.175, 220.875)	Petrol	225	10/98 → 08/05	
S 500 4-matic (220.084, 220.184)	Petrol	225	09/02 → 08/05	
S 55 AMG (220.073, 220.173)	Petrol	265	09/99 → 08/02	
S 55 AMG Kompressor (220.074, 220.174)	Petrol	368	09/02 → 08/05	
S 65 AMG (220.179)	Petrol	450	02/05 → 08/05	ENGINE: 40013259 →

CLASSE S (W221)

S 320 CDI (221.022, 221.122)	Diesel	173	12/05 → 06/09	
S 320 CDI 4-matic (221.080, 221.180)	Diesel	173	10/06 →	
S 350 (221.056, 221.156)	Petrol	200	10/05 →	
S 350 4-matic (221.087, 221.187)	Petrol	200	02/08 →	
S 350 BlueTec (221.026, 221.126)	Diesel	190	04/11 →	

SAC012



KW



MERCEDES-BENZ

CLASSE S (W221)

S 350 BlueTEC 4-matic (221.083, 221.183)	Diesel	190	04/11 →	
S 400 Hybrid (221.095, 221.195)	Hybrid	205	01/09 →	
S 420 CDI / S 450 CDI (221.028, 221.128)	Diesel	235	10/06 →	
S 450 (221.070, 221.170)	Petrol	250	12/05 →	
S 450 4-matic (221.084, 221.184)	Petrol	250	12/05 →	
S 500 (221.071, 221.171)	Petrol	285	10/05 →	
S 500 4-matic (221.086, 221.186)	Petrol	285	06/06 →	
S 63 AMG (221.077, 221.177)	Petrol	386	10/06 →	
S 65 AMG (221.179)	Petrol	450	12/05 →	
S 65 AMG (221.179)	Petrol	463	04/11 →	

CLASSE S Coupé (C215)

CL 500 (215.375)	Petrol	225	09/99 → 03/06	
CL 55 AMG (215.373)	Petrol	265	04/00 → 07/02	
CL 55 AMG Kompressor (215.374)	Petrol	368	06/02 → 03/06	

CLASSE S Coupé (C216)

CL 500 (216.371)	Petrol	285	06/06 →	
CL 500 4-matic (216.386)	Petrol	285	02/08 →	
CL 63 AMG (216.377)	Petrol	386	10/06 →	

CLASSE V (638/2)

V 200 CDI (638.294)	Diesel	75	03/99 → 07/03	
V 220 CDI (638.294)	Diesel	90	03/99 → 07/03	

CLK (C208)

320 (208.365)	Petrol	160	06/97 → 06/02	
430 (208.370)	Petrol	205	07/98 → 06/02	
55AMG (208.374)	Petrol	255	08/99 → 06/02	

SAC012

MERCEDES-BENZ
CLK (C209)

200 CGI (209.343)	Petrol	125	07/03 → 05/09	
200 Kompressor (209.341)	Petrol	135	05/07 → 05/09	
200 Kompressor (209.342)	Petrol	120	09/02 → 05/09	
220 CDI (209.308)	Diesel	110	01/05 → 11/05	ENGINE: → 30497543
240 (209.361)	Petrol	125	06/02 → 05/09	
270 CDI (209.316)	Diesel	125	10/02 → 05/09	
280 (209.354)	Petrol	170	01/05 → 05/09	
320 (209.365)	Petrol	160	06/02 → 05/09	
320 CDI (209.320)	Diesel	165	01/05 → 10/05	ENGINE: → 40086332
350 (209.356)	Petrol	200	01/05 → 05/09	
500 (209.372)	Petrol	285	06/06 → 05/09	
500 (209.375)	Petrol	225	06/02 → 05/09	
55 AMG (209.376)	Petrol	270	09/02 → 05/09	
DTM AMG	Petrol	428	06/04 → 05/09	

CLK Cabriolet (A208)

320 (208.465)	Petrol	160	06/98 → 03/02	
430 (208.470)	Petrol	205	08/99 → 03/02	
55 AMG (208.474)	Petrol	255	01/00 → 03/02	

CLK Cabriolet (A209)

CLK 200 Kompressor (209.441)	Petrol	135	05/07 → 03/10	
CLK 200 Kompressor (209.442)	Petrol	120	02/03 → 03/10	
CLK 240 (209.461)	Petrol	125	02/03 → 03/10	
CLK 280 (209.454)	Petrol	170	01/05 → 03/10	
CLK 320 (209.465)	Petrol	160	02/03 → 03/10	
CLK 320 CDI (209.420)	Diesel	165	03/05 → 03/10	
CLK 350 (209.456)	Petrol	200	01/05 → 03/10	
CLK 500 (209.472)	Petrol	285	06/06 → 03/10	
CLK 500 (209.475)	Petrol	225	02/03 → 03/10	
CLK 55 AMG (209.476)	Petrol	270	02/03 → 03/10	
CLK AMG DTM	Petrol	428	06/04 → 10/05	

SAC012

MERCEDES-BENZ
CLS (C218)

CLS 350 CDI (218.323)	Diesel	195	01/11 →	
CLS 350 CDI 4-matic (218.393)	Diesel	195	09/11 →	

CLS (C219)

CLS 280 (219.354)	Petrol	170	07/08 → 12/10	
CLS 300 (219.354)	Petrol	170	04/09 → 12/10	
CLS 320 CDI (219.322)	Diesel	165	01/05 → 10/05	ENGINE: → 40086332
CLS 350 (219.356)	Petrol	200	10/04 → 12/10	
CLS 350 (219.357)	Petrol	215	04/06 → 12/10	
CLS 350 CDI (219.322)	Diesel	165	04/09 → 12/10	
CLS 350 CGI (219.357)	Petrol	215	04/09 → 12/10	
CLS 500 (219.372)	Petrol	285	04/06 → 12/10	
CLS 500 (219.375)	Petrol	225	10/04 → 12/10	
CLS 55 AMG (219.376)	Petrol	350	01/05 → 12/10	

SL (R230)

280	Petrol	170	03/08 → 01/12	
300	Petrol	170	04/09 → 01/12	
350	Petrol	200	03/06 → 01/12	
350	Petrol	232	04/08 → 01/12	
500	Petrol	285	03/06 → 01/12	
600	Petrol	380	01/07 → 01/12	
350 (230.467)	Petrol	180	03/03 → 01/12	
500 (230.475)	Petrol	225	10/01 → 01/12	
55 AMG	Petrol	380	03/06 → 01/12	
55 AMG (230.474)	Petrol	350	10/01 → 06/02	
55 AMG Kompressor (230.474)	Petrol	368	06/02 → 01/12	
600 (230.476)	Petrol	368	03/05 → 01/12	
65 AMG (230.479)	Petrol	450	03/05 → 01/12	
65 AMG Black Series	Petrol	493	07/08 → 01/12	

SAC012



KW



MERCEDES-BENZ

SL (R230)

65 AMG Black Series (230.479) Petrol 493 07/08 → 01/12

SLK (R170)

32 AMG Kompressor (170.466) Petrol 260 03/01 → 04/04

320 (170.465) Petrol 160 03/00 → 04/04

SLK (R171)

200 Kompressor (171.442) Petrol 120 03/04 → 02/11

200 Kompressor (171.445) Petrol 135 01/08 → 02/11

280 (171.454) Petrol 170 01/05 → 02/11

300 (171.454) Petrol 170 04/09 → 02/11

350 (171.456) Petrol 200 06/04 → 02/11

350 (171.458) Petrol 224 01/08 → 02/11

55AMG (171.473) Petrol 265 06/04 → 02/11

SLK (R172)

200 (172.448) Petrol 135 02/11 →

SLR (R199)

5.4 (199.376) Petrol 460 04/04 →

5.4 722 Edition Petrol 478 10/06 →

SLR ROADSTER (R199)

5.4 Petrol 460 04/07 →

5.4 Petrol 478 10/06 →

SLS AMG (C197)

6.2 (197.377) Petrol 420 03/10 →

SLS AMG Cabriolet (A197)

6.2 (197.477) Petrol 420 06/11 →

SPRINTER 2-t Autobus (901, 902)

208 CDI Diesel 60 04/00 → 05/06

SPRINTER 2-t Autobus (901, 902)

211 CDI Diesel 80 04/00 → 05/06

213 CDI Diesel 95 04/00 → 05/06

216 CDI Diesel 115 04/00 → 05/06

SPRINTER 2-t Furgonato (901, 902)

208 CDI Diesel 60 04/00 → 05/06

211 CDI Diesel 80 04/00 → 05/06

213 CDI Diesel 95 04/00 → 05/06

216 CDI Diesel 115 04/00 → 05/06

SPRINTER 2-t Pianale piatto/Telaio (901, 902)

208 CDI Diesel 60 04/00 → 05/06

211 CDI Diesel 80 04/00 → 05/06

213 CDI Diesel 95 04/00 → 05/06

SAC012



KW



MERCEDES-BENZ

SPRINTER 2-t Pianale piatto/Telaio (901, 902)

216 CDI Diesel 115 04/00 → 05/06

SPRINTER 3,5-t Autobus (906)

311 CDI (906.731, 906.733, 906.735) Diesel 80 06/06 →

311 CDI 4x4 (906.731, 906.733, 906.735) Diesel 80 02/08 →

315 CDI (906.731, 906.733, 906.735) Diesel 110 06/06 →

315 CDI 4x4 (906.731, 906.733, 906.735) Diesel 110 02/08 →

316 (906.733, 906.735) Petrol 115 03/09 →

316NGT (906.733, 906.735) Petrol/CNG 115 03/09 →

318 CDI (906.731, 906.733, 906.735) Diesel 135 02/08 →

318 CDI 4x4 (906.731, 906.733, 906.735) Diesel 135 02/08 →

324 (906.733, 906.735) Petrol 190 06/06 →

SPRINTER 3,5-t Furgonato (906)

309 CDI (906.631, 906.633, 906.635, 906.637) Diesel 65 06/06 →

311 CDI (906.631, 906.633, 906.635, 906.637) Diesel 80 06/06 →

311 CDI 4x4 (906.631, 906.633, 906.635, 906.637) Diesel 80 02/08 →

313 CDI (906.631, 906.633, 906.635, 906.637) Diesel 95 06/06 →

315 CDI (906.631, 906.633, 906.635, 906.637) Diesel 110 06/06 →

315 CDI 4x4 (906.631, 906.633, 906.635, 906.637) Diesel 110 02/08 →

316 (906.663, 906.635) Petrol 115 09/08 →

SAC012

MERCEDES-BENZ
SPRINTER 3,5-t Furgonato (906)

316 NGT (906.633, 906.635)	Petrol/ CNG	115	03/09 →	
318 CDI (906.631, 906.633, 906.635, 906.637)	Diesel	135	06/06 →	
318 CDI 4x4 (906.631, 906.633, 906.635, 906.637)	Diesel	135	02/08 →	
319 CDI / BlueTEC (906.631, 906.633, 906.635, 906.637)	Diesel	140	03/09 →	
324 (906.633, 906.635, 906.637)	Petrol	190	06/06 →	

SPRINTER 3,5-t Pianale piatto/Telaio (906)

309 CDI (906.131, 906.133, 906.135, 906.231, 906.233...)	Diesel	65	06/06 →	
311 CDI (906.131, 906.133, 906.135, 906.231, 906.233...)	Diesel	80	06/06 →	
311 CDI 4x4 (906.131, 906.133, 906.135, 906.231...)	Diesel	80	02/08 →	
313 CDI (906.131, 906.133, 906.135, 906.231, 906.233...)	Diesel	95	06/06 →	
315 CDI (906.131, 906.133, 906.135, 906.231, 906.233...)	Diesel	110	06/06 →	
315 CDI 4x4 (906.131, 906.133, 906.135, 906.231...)	Diesel	110	02/08 →	
316 (906.133, 906.135, 906.233, 906.235)	Petrol	115	09/08 →	

SAC012

MERCEDES-BENZ
SPRINTER 3,5-t Pianale piatto/Telaio (906)

316 NGT (906.133, 906.135, 906.233, 906.235)	Petrol/ CNG	115	03/09 →	
318 CDI (906.131, 906.133, 906.135, 906.231, 906.233...)	Diesel	135	06/06 →	
318 CDI 4x4 (906.131, 906.133, 906.135, 906.231...)	Diesel	135	02/08 →	
319 CDI / BlueTEC (906.131, 906.133, 906.135, 906.231...)	Diesel	140	03/09 →	
319 CDI 4x4 (906.131, 906.133, 906.135, 906.231, 906.235)	Diesel	140	05/11 →	
324 (906.133, 906.135, 906.233, 906.235)	Petrol	190	06/06 →	

SPRINTER 3-t Autobus (903)

308 CDI	Diesel	60	04/00 → 05/06	
311 CDI	Diesel	80	04/00 → 05/06	
311 CDI 4x4	Diesel	80	08/02 → 05/06	
313 CDI	Diesel	95	04/00 → 05/06	
313 CDI 4x4	Diesel	95	08/02 → 05/06	
316 CDI	Diesel	115	04/00 → 05/06	
316 CDI 4x4	Diesel	115	08/02 → 05/06	

SPRINTER 3-t Autobus (906)

211 CDI (906.711, 906.713)	Diesel	80	06/06 →	
215 CDI (906.711, 906.713)	Diesel	110	06/06 →	
216 (906.713)	Petrol	115	03/09 →	
224 (906.713)	Petrol	190	06/06 →	

SPRINTER 3-t Furgonato (903)

308 CDI	Diesel	60	04/00 → 05/06	
311 CDI	Diesel	80	04/00 → 05/06	
311 CDI 4x4	Diesel	80	08/02 → 05/06	
313 CDI	Diesel	95	04/00 → 05/06	

SAC012



KW



MERCEDES-BENZ

SPRINTER 3-t Furgonato (903)

313 CDI 4x4	Diesel	95	08/02 → 05/06
316 CDI	Diesel	115	04/00 → 05/06
316 CDI 4x4	Diesel	115	08/02 → 05/06

SPRINTER 3-t Furgonato (906)

209 CDI (906.611, 906.613)	Diesel	65	06/06 →
211 CDI (906.611, 906.613)	Diesel	80	06/06 →
213 CDI (906.611, 906.613)	Diesel	95	06/06 →
215 CDI (906.611, 906.613)	Diesel	110	06/06 →
216 (906.613)	Petrol	115	09/08 →
218 CDI (906.611, 906.613)	Diesel	135	06/06 →
224 (906.613)	Petrol	190	06/06 →

SPRINTER 3-t Pianale piatto/Telaio (903)

308 CDI	Diesel	60	04/00 → 05/06
311 CDI	Diesel	80	04/00 → 05/06
311 CDI 4x4	Diesel	80	08/02 → 05/06
313 CDI	Diesel	95	04/00 → 05/06
313 CDI 4x4	Diesel	95	08/02 → 05/06
316 CDI	Diesel	115	04/00 → 05/06
316 CDI 4x4	Diesel	115	08/02 → 05/06

SPRINTER 3-t Pianale piatto/Telaio (906)

209 CDI (906.111, 906.113, 906.211, 906.213)	Diesel	65	06/06 →
211 CDI (906.111, 906.113, 906.211, 906.213)	Diesel	80	06/06 →
213 CDI (906.111, 906.113, 906.211, 906.213)	Diesel	95	06/06 →
215 CDI (906.111, 906.113, 906.211, 906.213)	Diesel	110	06/06 →
216 (906.113, 906.213)	Petrol	115	09/08 →
218 CDI (906.111, 906.113, 906.211, 906.213)	Diesel	135	06/06 →
224 (906.113, 906.213)	Petrol	190	06/06 →

SAC012



KW



MERCEDES-BENZ

SPRINTER 4,6-t Furgonato (906)

413 CDI (906.653, 906.655, 906.657)	Diesel	95	06/06 →
419 CDI (906.653, 906.655, 906.657)	Diesel	140	03/09 →
424 (906.953, 906.655, 906.657)	Petrol	190	06/06 →

SPRINTER 4,6-t Pianale piatto/Telaio (906)

413 CDI (906.153, 906.155, 906.253, 906.255)	Diesel	95	06/06 →
415 CDI (906.153, 906.155, 906.253, 906.255)	Diesel	110	06/06 → 12/10
418 CDI (906.153, 906.155, 906.253, 906.255)	Diesel	135	06/06 → 12/10
419 CDI (906.153, 906.155, 906.253, 906.255)	Diesel	140	03/09 →
424 (906.153, 906.155, 906.253, 906.255)	Petrol	190	06/06 →

SPRINTER 4-t Autobus (904)

408 CDI	Diesel	60	04/00 → 05/06
411 CDI	Diesel	80	04/00 → 05/06
413 CDI	Diesel	95	04/00 → 05/06
416 CDI	Diesel	115	04/00 → 05/06

SPRINTER 4-t Furgonato (904)

408 CDI	Diesel	60	04/00 → 05/06
411 CDI	Diesel	80	04/00 → 05/06
411 CDI 4x4	Diesel	80	04/00 → 05/06
413 CDI	Diesel	95	04/00 → 05/06
413 CDI 4x4	Diesel	95	04/00 → 05/06
416 CDI	Diesel	115	04/00 → 05/06
416 CDI 4x4	Diesel	115	04/00 → 05/06

SPRINTER 4-t Pianale piatto/Telaio (904)

408 CDI	Diesel	60	04/00 → 05/06
411 CDI	Diesel	80	04/00 → 05/06
411 CDI 4x4	Diesel	80	04/00 → 05/06
413 CDI	Diesel	95	04/00 → 05/06
413 CDI 4x4	Diesel	95	04/00 → 05/06
416 CDI	Diesel	115	04/00 → 05/06
416 CDI 4x4	Diesel	115	04/00 → 05/06

SAC012

MERCEDES-BENZ
SPRINTER 5-t Furgonato (906)

509 CDI (906.653, 906.655, 906.657)	Diesel	65	06/06 →	
511 CDI (906.653, 906.655, 906.657)	Diesel	80	06/06 →	
513 CDI (906.653, 906.655, 906.657)	Diesel	95	03/09 →	
515 CDI (906.653, 906.655, 906.657)	Diesel	110	06/06 →	
518 CDI (906.653, 906.655, 906.657)	Diesel	135	06/06 →	
519 CDI / BlueTEC (906.653, 906.655, 906.657)	Diesel	140	03/09 →	
524 (906.653, 906.655, 906.657)	Petrol	190	06/06 →	

SPRINTER 5-t Pianale piatto/Telaio (905)

616 CDI (905.612, 905.613, 905.622, 905.623)	Diesel	115	04/01 → 05/06	
--	--------	-----	---------------	--

SPRINTER 5-t Pianale piatto/Telaio (906)

509 CDI (906.153, 906.155, 906.253, 906.255)	Diesel	65	06/06 →	
510 CDI (906.153, 906.155, 906.253, 906.255)	Diesel	70	03/09 →	
511 CDI (906.153, 906.155, 906.253, 906.255)	Diesel	80	06/06 →	
513 CDI (906.135, 906.155, 906.253, 906.255)	Diesel	95	03/09 →	
515 CDI (906.153, 906.155, 906.253, 906.255)	Diesel	110	06/06 →	
516 (906.153, 906.155, 906.253, 906.255)	Petrol	115	03/09 →	
516 NGT (906.153, 906.155, 906.253, 906.255)	Petrol/ CNG	115	03/09 →	
518 CDI (906.153, 906.155, 906.253, 906.255)	Diesel	135	06/06 →	

SAC012

MERCEDES-BENZ
SPRINTER 5-t Pianale piatto/Telaio (906)

519 CDI / BlueTEC (906.153, 906.155, 906.253, 906.255)	Diesel	140	03/09 →	
524 (906.153, 906.155, 906.253, 906.255)	Petrol	190	06/06 →	

SPRINTER Ribaltabile (905)

616 CDI (905.612, 905.622, 905.623)	Diesel	115	04/01 →	
-------------------------------------	--------	-----	---------	--

VANEO (414)

1.6 (414.700)	Petrol	60	02/02 → 07/05	
1.6 (414.700)	Petrol	75	02/02 → 07/05	
1.7 CDI (414.700)	Diesel	55	02/02 → 07/05	
1.7 CDI (414.700)	Diesel	67	02/02 → 07/05	
1.9 (414.700)	Petrol	92	02/02 → 07/05	

VIANO (W639)

3,0	Petrol	140	09/03 →	
3.2	Petrol	160	09/03 →	
3.5	Petrol	190	09/07 →	
3.7	Petrol	170	06/04 → 07/09	
CDI 2.0	Diesel	80	09/03 →	
CDI 2.0	Diesel	85	08/05 →	
CDI 2.0 4-matic	Diesel	80	07/05 →	
CDI 2.2	Diesel	110	09/03 →	
CDI 2.2 4-matic	Diesel	110	03/06 →	
CDI 3.0	Diesel	150	03/06 →	

VITO / MIXTO Furgonato (W639)

119	Petrol	140	09/03 → 07/08	
122	Petrol	160	09/03 → 09/04	
126	Petrol	190	09/07 →	
109 CDI	Diesel	65	09/03 → 07/06	
109 CDI	Diesel	70	08/06 →	
111 CDI	Diesel	80	09/03 → 08/07	
111 CDI	Diesel	85	09/07 →	
111 CDI 4x4	Diesel	80	09/07 →	
115 CDI	Diesel	110	09/03 →	
115 CDI 4x4	Diesel	110	07/06 →	
120 CDI	Diesel	150	07/06 →	
123 (639.603)	Petrol	170	06/04 → 07/08	

VITO Autobus (638)

108 CDI 2.2 (638.194)	Diesel	60	03/99 → 07/03	
110 CDI 2.2 (638.194)	Diesel	75	03/99 → 07/03	

SAC012



MERCEDES-BENZ

VITO Autobus (638)

112 CDI 2.2 (638.194)	Diesel	90	03/99 → 07/03
--------------------------	--------	----	---------------

VITO Autobus (W639)

119	Petrol	140	09/03 → 07/08
122	Petrol	160	09/03 → 09/04
123	Petrol	170	06/04 → 07/08
126	Petrol	190	09/07 →
109 CDI	Diesel	65	09/03 → 07/06
109 CDI	Diesel	70	09/06 →
109 CDI 4x4	Diesel	70	09/07 →
111 CDI	Diesel	80	09/03 → 08/07
111 CDI (639.701)	Diesel	85	09/07 →
111 CDI 4x4	Diesel	80	09/07 →
115 CDI	Diesel	110	09/03 →
115 CDI 4x4	Diesel	110	09/07 →
120 CDI	Diesel	150	07/06 →

VITO Furgonato (638)

108 CDI 2.2 (638.094)	Diesel	60	03/99 → 07/03
110 CDI 2.2 (638.094)	Diesel	75	03/99 → 07/03
112 CDI 2.2 (638.094)	Diesel	90	03/99 → 07/03

SAC014

H2 **SENSORE POSIZIONE ALBERO A CAM**
CAMSHAFT POSITION SENSOR



AUDI

A2 (8Z0)

1.4	Petrol	55	02/00 → 08/05
-----	--------	----	---------------

SEAT

ALTEA (5P1)

1.4 16V	Petrol	63	05/06 →
---------	--------	----	---------

SAC014



SEAT

ALTEA XL (5P5, 5P8)

1.4 16V	Petrol	63	10/06 →
---------	--------	----	---------

AROSA (6H)

1.4 16V	Petrol	74	01/00 → 06/04
---------	--------	----	---------------

CORDOBA (6K2)

1.4 16V	Petrol	55	05/00 → 10/02
1.4 16V	Petrol	74	02/00 → 10/02

CORDOBA (6L2)

1.4 16V	Petrol	74	10/02 → 11/09
---------	--------	----	---------------

CORDOBA Vario (6K5)

1.4 16V	Petrol	55	06/99 → 12/02
---------	--------	----	---------------

IBIZA III (6K1)

1.4 16V	Petrol	55	05/00 → 02/02	CHASSIS: → 6K1158800
1.4 16V	Petrol	74	08/99 → 02/02	CHASSIS: → 6K1158800

IBIZA IV (6L1)

1.4 16V	Petrol	55	02/02 → 12/07
1.4 16V	Petrol	63	05/06 → 11/09
1.4 16V	Petrol	74	02/02 → 11/09

IBIZA V (6J5)

1.4	Petrol	63	03/08 →
-----	--------	----	---------

IBIZA V SPORTCOUPE (6J1)

1.4	Petrol	63	07/08 →
-----	--------	----	---------

IBIZA V ST (6J8)

1.4	Petrol	63	03/10 →
-----	--------	----	---------

INCA (6K9)

1.4 16V	Petrol	55	04/00 → 06/03
---------	--------	----	---------------

LEON (1M1)

1.6 16 V	Petrol	77	09/00 → 06/06
----------	--------	----	---------------

LEON (1P1)

1.4 16V	Petrol	63	06/06 →
2.0 TFSI	Petrol	155	06/09 →

TOLEDO II (1M2)

1.4 16V	Petrol	55	07/99 → 05/06
1.6 16V	Petrol	77	09/00 → 05/06

SKODA

FABIA

1.4	Petrol	63	01/07 →
-----	--------	----	---------

FABIA (6Y2)

1.4 16V	Petrol	55	12/99 → 03/08
1.4 16V	Petrol	74	12/99 → 03/08

FABIA Combi

1.4	Petrol	63	10/07 →
-----	--------	----	---------

SAC014

KW

SKODA
FABIA Combi (6Y5)

1.4 16V	Petrol	55	05/00 → 12/07
1.4 16V	Petrol	74	04/00 → 12/07
1.4 16V	Petrol	59	05/06 → 12/07

FABIA Tre volumi (6Y3)

1.4 16V	Petrol	55	10/99 → 12/07
1.4 16V	Petrol	74	12/99 → 12/07
1.4 16V	Petrol	59	05/06 → 12/07

OCTAVIA (1U2)

1.4 16V	Petrol	55	09/00 → 12/10
---------	--------	----	---------------

OCTAVIA (1Z3)

1.4	Petrol	55	05/04 → 05/06
1.4	Petrol	59	05/06 →

OCTAVIA Combi (1U5)

1.4 16V	Petrol	55	08/00 → 12/10
---------	--------	----	---------------

OCTAVIA Combi (1Z5)

1.4	Petrol	59	05/06 →
-----	--------	----	---------

VOLKSWAGEN
BORA (1J2)

1.4 16V	Petrol	55	03/00 → 05/05
1.6 16V	Petrol	77	05/00 → 05/05

BORA Station wagon (1J6)

1.4 16V	Petrol	55	09/01 → 05/05
1.6 16V	Petrol	77	02/00 → 05/05

CADDY II Furgonato (9K9A)

1.4	Petrol	55	08/00 → 01/04
-----	--------	----	---------------

CADDY II Station wagon (9K9B)

1.4 16V	Petrol	55	08/00 → 01/04
---------	--------	----	---------------

CADDY III Furgonato (2KA, 2KH, 2CA, 2CH)

1.4	Petrol	55	03/04 → 05/06
1.4 16V	Petrol	59	05/06 → 08/10

CADDY III Station wagon (2KB, 2KJ, 2CB, 2CJ)

1.4	Petrol	55	03/04 → 05/06
1.4 16V	Petrol	59	05/06 → 08/10

GOLF IV (1J1)

1.4 16V	Petrol	55	08/97 → 06/05
1.6 16V	Petrol	77	02/00 → 06/05

GOLF IV Variant (1J5)

1.4 16V	Petrol	55	05/99 → 06/06
1.6 16V	Petrol	77	02/00 → 06/06

GOLF PLUS (5M1, 521)

1.4 16V	Petrol	55	01/05 →
1.4 16V	Petrol	59	05/06 →

SAC014

KW

VOLKSWAGEN
GOLF V (1K1)

1.4 16V	Petrol	55	10/03 → 05/06
---------	--------	----	---------------

GOLF VI Variant (AJ5)

1.4 16V	Petrol	59	05/06 → 11/08
---------	--------	----	---------------

GOLF V Variant (1K5)

1.4	Petrol	59	08/07 → 07/09
1.4	Petrol	59	07/09 → 07/13

LUPO (6X1, 6E1)

1.4 16V	Petrol	55	09/98 → 07/05
1.4 16V	Petrol	74	08/99 → 07/05

NEW BEETLE (9C1, 1C1)

1.4	Petrol	55	11/01 → 09/10
-----	--------	----	---------------

NEW BEETLE Cabriolet (1Y7)

1.4	Petrol	55	01/03 → 09/10
-----	--------	----	---------------

POLO (6N1)

100 1.4 16V	Petrol	74	04/96 → 10/99
120 1.6 16V GTI	Petrol	88	09/98 → 10/99

POLO (6N2)

1.4 16V	Petrol	55	10/99 → 09/01
1.4 16V	Petrol	74	10/99 → 09/01

POLO (6R, 6C)

1.4	Petrol	63	06/09 →
-----	--------	----	---------

POLO (9N_)

1.4 16V	Petrol	59	05/06 → 11/09
1.4 16V	Petrol	74	10/01 → 05/08

POLO CLASSIC (6KV2)

75 1.4 16V	Petrol	55	10/99 → 09/01
------------	--------	----	---------------

POLO Tre volumi (9A4)

1.4	Petrol	74	11/03 →
-----	--------	----	---------

POLO Variant (6KV5)

1.4 16V	Petrol	55	10/99 → 09/01
---------	--------	----	---------------

SAC015

H2 **SENSORE POSIZIONE ALBERO A CAM**
CAMSHAFT POSITION SENSOR

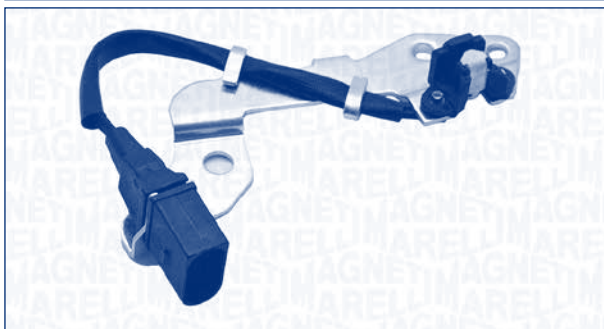

AUDI

A3 (8L1)

1.6 Petrol 75 08/00 → 05/03

A4 (8D2, B5)

1.6 Petrol 74 11/94 → 10/00

A4 Avant (8D5, B5)

1.6 Petrol 74 11/94 → 09/01

SEAT

CORDOBA (6K2)

1.6 Petrol 74 06/99 → 10/02

CORDOBA (6L2)

2.0 Petrol 85 09/02 → 11/09

CORDOBA Vario (6K5)

1.6 Petrol 74 06/99 → 12/02

IBIZA III (6K1)

1.6 Petrol 74 08/99 → 02/02

IBIZA IV (6L1)

2.0 Petrol 85 04/02 → 11/09

LEON (1M1)

1.6 Petrol 74 11/99 → 06/06

TOLEDO II (1M2)

1.6 Petrol 74 04/99 → 09/00

SKODA

FABIA (6Y2)

2.0 Petrol 85 12/99 → 03/08

FABIA Combi (6Y5)

2.0 Petrol 85 04/00 → 12/07

FABIA Tre volumi (6Y3)

2.0 Petrol 85 12/99 → 12/07

OCTAVIA (1U2)

1.6 Petrol 75 11/00 → 12/10 CHASSIS:
→ 1U38668598

2.0 Petrol 85 04/99 → 05/07

SAC015



SKODA

OCTAVIA Combi (1U5)

1.6 Petrol 74 07/98 → 12/07

1.6 Petrol 75 09/00 → 12/10 CHASSIS:
→ 1U38668597

2.0 Petrol 85 04/99 → 05/07

SUPERB (3U4)

2.0 Petrol 85 12/01 → 03/08

VOLKSWAGEN

BORA (1J2)

1.6 Petrol 75 08/00 → 05/05

1.6 Petrol 74 10/98 → 05/05

2.0 Petrol 85 10/98 → 05/05

2.3 V5 Petrol 125 10/00 → 05/05

2.3 V5 4motion Petrol 125 10/00 → 05/05

2.8 V6 4motion Petrol 150 03/99 → 05/05

BORA Station wagon (1J6)

1.6 Petrol 75 08/00 → 05/05

1.6 Petrol 74 05/99 → 05/05

2.0 Petrol 85 05/99 → 05/05

2.3 V5 Petrol 125 10/00 → 05/05

2.3 V5 4motion Petrol 125 10/00 → 05/05

2.8 V6 4motion Petrol 150 05/99 → 05/05

CADDY III Furgonato (2KA, 2KH, 2CA, 2CH)

2.0 EcoFuel Petrol/
CNG 80 04/06 →

CADDY III Station wagon (2KB, 2KJ, 2CB, 2CJ)

2.0 EcoFuel Petrol/
CNG 80 04/06 →

GOLF IV (1J1)

1.6 Petrol 75 08/00 → 06/05

1.6 Petrol 74 08/97 → 05/04

2.0 Petrol 85 07/98 → 05/04

2.0 4motion Petrol 85 10/00 → 06/05

GOLF IV Variant (1J5)

1.6 Petrol 75 08/00 → 06/06

1.6 Petrol 74 05/99 → 04/02

2.0 Petrol 85 05/99 → 06/06

2.0 4motion Petrol 85 10/00 → 06/06

2.0 Bi-Fuel BiFuel 85 02/02 → 06/06

MULTIVAN V (7HM, 7HN, 7HF, 7EF, 7EM, 7EN)

2.0 Petrol 85 11/03 →

NEW BEETLE (9C1, 1C1)

1.6 Petrol 74 10/99 → 09/00

2.0 Petrol 85 01/98 → 09/10

SAC015

VOLKSWAGEN
NEW BEETLE Cabriolet (1Y7)

2.0	Petrol	85	09/02 → 10/10
-----	--------	----	---------------

PASSAT (3B3)

1.6	Petrol	75	11/00 → 05/05	CHASSIS: → 3B2240126
-----	--------	----	---------------	-------------------------

2.0 4motion	Petrol	85	11/00 → 05/05
-------------	--------	----	---------------

PASSAT Variant (3B6)

1.6	Petrol	75	11/00 → 05/05	CHASSIS: → 3B2240126
-----	--------	----	---------------	-------------------------

2.0	Petrol	85	11/00 → 05/05
-----	--------	----	---------------

2.0 4motion	Petrol	85	11/00 → 05/05
-------------	--------	----	---------------

POLO (9N_)

1.8 GTI	Petrol	110	09/05 → 11/09
---------	--------	-----	---------------

1.8 GTi Cup Edition	Petrol	132	05/06 → 11/09
---------------------	--------	-----	---------------

POLO CLASSIC (6KV2)

100 1.6	Petrol	74	12/95 → 09/01
---------	--------	----	---------------

POLO Variant (6KV5)

1.6	Petrol	74	05/97 → 09/01
-----	--------	----	---------------

SHARAN (7M8, 7M9, 7M6)

2.0	Petrol	85	09/95 → 03/10
-----	--------	----	---------------

TOURAN (1T1, 1T2)

2.0 EcoFuel	Petrol/ CNG	80	02/06 → 05/09
-------------	----------------	----	---------------

TRANSPORTER V Autobus (7HB, 7HJ, 7EB, 7EJ, 7EF)

2.0	Petrol	85	11/03 →
-----	--------	----	---------

TRANSPORTER V Furgonato (7HA, 7HH, 7EA, 7EH)

2.0	Petrol	85	11/03 →
-----	--------	----	---------

TRANSPORTER V Pianale piatto/Telaio (7JD, 7JE, 7JL, 7JY, 7JZ)

2.0	Petrol	85	11/03 →
-----	--------	----	---------

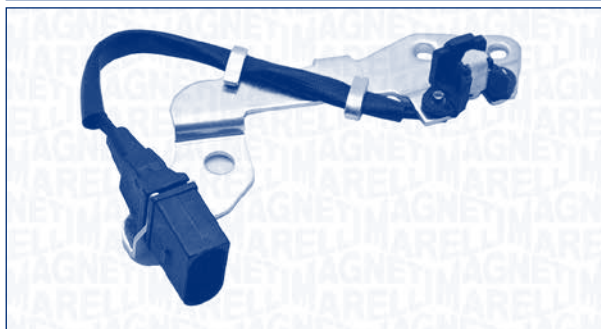
SAC015-1
**H2 SENSORE POSIZIONE ALBERO A CAM
CAMSHAFT POSITION SENSOR**

AUDI
A3 (8L1)

1.6	Petrol	75	08/00 → 05/03
-----	--------	----	---------------

A4 (8D2, B5)

1.6	Petrol	74	11/94 → 10/00
-----	--------	----	---------------

A4 Avant (8D5, B5)

1.6	Petrol	74	11/94 → 09/01
-----	--------	----	---------------

SEAT
CORDOBA (6K2)

1.6	Petrol	74	06/99 → 10/02
-----	--------	----	---------------

CORDOBA (6L2)

2.0	Petrol	85	09/02 → 11/09
-----	--------	----	---------------

CORDOBA Vario (6K5)

1.6	Petrol	74	06/99 → 12/02
-----	--------	----	---------------

IBIZA III (6K1)

1.6	Petrol	74	08/99 → 02/02
-----	--------	----	---------------

IBIZA IV (6L1)

2.0	Petrol	85	04/02 → 11/09
-----	--------	----	---------------

LEON (1M1)

1.6	Petrol	74	11/99 → 06/06
-----	--------	----	---------------

TOLEDO II (1M2)

1.6	Petrol	74	04/99 → 09/00
-----	--------	----	---------------

SKODA
FABIA (6Y2)

2.0	Petrol	85	12/99 → 03/08
-----	--------	----	---------------

FABIA Combi (6Y5)

2.0	Petrol	85	04/00 → 12/07
-----	--------	----	---------------

FABIA Tre volumi (6Y3)

2.0	Petrol	85	12/99 → 12/07
-----	--------	----	---------------

OCTAVIA (1U2)

1.6	Petrol	75	11/00 → 12/10	CHASSIS: → 1U38668598
-----	--------	----	---------------	--------------------------

2.0	Petrol	85	04/99 → 05/07
-----	--------	----	---------------

SAC015-1



KW



SKODA

OCTAVIA Combi (1U5)

1.6	Petrol	74	07/98 → 12/07	
1.6	Petrol	75	09/00 → 12/10	CHASSIS: → 1U38668597
2.0	Petrol	85	04/99 → 05/07	

SUPERB (3U4)

2.0	Petrol	85	12/01 → 03/08	
-----	--------	----	---------------	--

VOLKSWAGEN

BORA (1J2)

1.6	Petrol	74	10/98 → 05/05	
1.6	Petrol	75	08/00 → 05/05	
2.0	Petrol	85	10/98 → 05/05	
2.3 V5	Petrol	125	10/00 → 05/05	
2.3 V5 4motion	Petrol	125	10/00 → 05/05	
2.8 V6 4motion	Petrol	150	03/99 → 05/05	

BORA Station wagon (1J6)

1.6	Petrol	74	05/99 → 05/05	
1.6	Petrol	75	08/00 → 05/05	
2.0	Petrol	85	05/99 → 05/05	
2.3 V5	Petrol	125	10/00 → 05/05	
2.3 V5 4motion	Petrol	125	10/00 → 05/05	
2.8 V6 4motion	Petrol	150	05/99 → 05/05	

CADDY III Furgonato (2KA, 2KH, 2CA, 2CH)

2.0 EcoFuel	Petrol/ CNG	80	04/06 →	
-------------	----------------	----	---------	--

CADDY III Station wagon (2KB, 2KJ, 2CB, 2CJ)

2.0 EcoFuel	Petrol/ CNG	80	04/06 →	
-------------	----------------	----	---------	--

GOLF IV (1J1)

1.6	Petrol	75	08/00 → 06/05	
1.6	Petrol	74	08/97 → 05/04	
2.0	Petrol	85	07/98 → 05/04	
2.0 4motion	Petrol	85	10/00 → 06/05	

GOLF IV Variant (1J5)

1.6	Petrol	75	08/00 → 06/06	
1.6	Petrol	74	05/99 → 04/02	
2.0	Petrol	85	05/99 → 06/06	
2.0 4motion	Petrol	85	10/00 → 06/06	
2.0 Bi-Fuel	BiFuel	85	02/02 → 06/06	

MULTIVAN V (7HM, 7HN, 7HF, 7EF, 7EM, 7EN)

2.0	Petrol	85	11/03 →	
-----	--------	----	---------	--

NEW BEETLE (9C1, 1C1)

1.6	Petrol	74	10/99 → 09/00	
2.0	Petrol	85	01/98 → 09/10	

SAC015-1



KW



VOLKSWAGEN

NEW BEETLE Cabriolet (1Y7)

2.0	Petrol	85	09/02 → 10/10	
-----	--------	----	---------------	--

PASSAT (3B3)

1.6	Petrol	75	11/00 → 05/05	CHASSIS: → 3B2240126
2.0 4motion	Petrol	85	11/00 → 05/05	

PASSAT Variant (3B6)

1.6	Petrol	75	11/00 → 05/05	CHASSIS: → 3B2240126
2.0	Petrol	85	11/00 → 05/05	
2.0 4motion	Petrol	85	11/00 → 05/05	

POLO (9N_)

1.8 GTI	Petrol	110	09/05 → 11/09	
1.8 GTi Cup Edition	Petrol	132	05/06 → 11/09	

POLO CLASSIC (6KV2)

100 1.6	Petrol	74	12/95 → 09/01	
---------	--------	----	---------------	--

POLO Variant (6KV5)

1.6	Petrol	74	05/97 → 09/01	
-----	--------	----	---------------	--

SHARAN (7M8, 7M9, 7M6)

2.0	Petrol	85	09/95 → 03/10	
-----	--------	----	---------------	--

TOURAN (1T1, 1T2)

2.0 EcoFuel	Petrol/ CNG	80	02/06 → 05/09	
-------------	----------------	----	---------------	--

TRANSPORTER V Autobus (7HB, 7HJ, 7EB, 7EJ, 7EF)

2.0	Petrol	85	11/03 →	
-----	--------	----	---------	--

TRANSPORTER V Furgonato (7HA, 7HH, 7EA, 7EH)

2.0	Petrol	85	11/03 →	
-----	--------	----	---------	--

TRANSPORTER V Pianale piatto/Telaio (7JD, 7JE, 7JL, 7JY, 7JZ)

2.0	Petrol	85	11/03 →	
-----	--------	----	---------	--

SAC016
H2 **SENSORE POSIZIONE ALBERO A CAM**
CAMSHAFT POSITION SENSOR

DAEWOO
KORANDO (KJ)

2.3 Petrol 105 01/99 → 05/05

KORANDO Cabrio (KJ)

2.0 16V Petrol 94 02/99 → 02/01

2.3 Petrol 105 02/99 → 05/05

MUSSO (FJ)

2.3 Petrol 103 01/99 → 05/05

MERCEDES-BENZ
CLASSE C (W202)

C 180 (202.018) Petrol 89 11/94 → 05/00

C 180 (202.018) Petrol 90 09/95 → 05/00

C 200 (202.020) Petrol 100 01/94 → 05/00

C 200 Kompressor (202.025) Petrol 132 10/95 → 05/00

C 230 Kompressor (202.024) Petrol 142 10/95 → 05/00

C 280 (202.028) Petrol 142 05/93 → 05/00

CLASSE C Station wagon (S202)

C 180 T (202.078) Petrol 90 06/96 → 09/00

C 200 T (202.080) Petrol 100 06/96 → 03/01

C 200 T Kompressor (202.082) Petrol 141 11/96 → 03/01

C 230 T Kompressor (202.085) Petrol 142 06/97 → 09/00

CLASSE E (W210)

E 200 (210.035) Petrol 100 06/95 → 08/00

E 200 Kompressor (210.045) Petrol 137 06/97 → 03/02

E 230 (210.037) Petrol 110 06/95 → 06/97

E 280 (210.053) Petrol 142 01/96 → 06/97

SAC016

MERCEDES-BENZ
CLASSE E Station wagon (S210)

E 200 T (210.235) Petrol 100 06/96 → 08/00

E 200 T Kompressor (210.245) Petrol 137 06/97 → 03/03

E 230 T (210.237) Petrol 110 06/96 → 06/97

CLASSE M (W163)

ML 230 (163.136) Petrol 110 02/98 → 06/05

CLASSE S (W140)

300 SE,SEL/S320 (140.032, 140.033) Petrol 170 03/91 → 10/98

CLASSE V (638/2)

V 200 (638.214, 638.294) Petrol 95 02/97 → 07/03

CLK (C208)

200 (208.335) Petrol 100 06/97 → 06/02

200 Kompressor (208.345) Petrol 141 06/97 → 06/00

230 Kompressor (208.347) Petrol 142 06/97 → 06/00

CLK Cabriolet (A208)

200 Kompressor (208.445) Petrol 141 03/98 → 06/00

SPRINTER 2-t Autobus (901, 902)

214 Petrol 105 02/95 → 05/06

SPRINTER 2-t Furgonato (901, 902)

214 Petrol 105 02/95 → 05/06

SPRINTER 2-t Pianale piatto/Telaio (901, 902)

214 Petrol 105 02/95 → 05/06

SPRINTER 3-t Autobus (903)

314 Petrol 105 02/95 → 05/06

314 4x4 Petrol 105 08/02 → 05/06

SPRINTER 3-t Furgonato (903)

314 Petrol 105 02/95 → 05/06

314 4x4 Petrol 105 08/02 → 05/06

SPRINTER 3-t Pianale piatto/Telaio (903)

314 Petrol 105 02/95 → 05/06

314 4x4 Petrol 105 08/02 → 05/06

SPRINTER 4-t Autobus (904)

414 Petrol 105 02/96 → 05/06

SPRINTER 4-t Furgonato (904)

414 Petrol 105 02/96 → 05/06

414 4x4 Petrol 105 05/97 → 05/06

SAC016



MERCEDES-BENZ

SPRINTER 4-t Pianale piatto/Telaio (904)

414	Petrol	105	02/96 → 05/06
414 4x4	Petrol	105	05/97 → 05/06

VITO Autobus (638)

113 2.0 (638.114, 638.194)	Petrol	95	02/96 → 07/03
----------------------------	--------	----	---------------

VITO Furgonato (638)

113 2.0 (638.014, 638.094)	Petrol	95	03/97 → 07/03
114 2.3 (638.034, 638.094)	Petrol	105	03/97 → 07/03

SAC017

H2 **SENSORE POSIZIONE ALBERO A CAM**
CAMSHAFT POSITION SENSOR



BMW

3 (E30)

318 is	Petrol	100	09/89 → 08/91
--------	--------	-----	---------------

SAC018

H2 **SENSORE POSIZIONE ALBERO A CAM**
CAMSHAFT POSITION SENSOR



HYUNDAI

H-1 / STAREX

2.5 TD 4WD	Diesel	73	03/01 → 04/04
2.5 TD 4WD	Diesel	74	11/01 → 04/04

SAC019

H2 **SENSORE POSIZIONE ALBERO A CAM**
CAMSHAFT POSITION SENSOR



SUBARU

OUTBACK (BL, BP)

3.0 Trazione integrale AWD	Petrol	180	11/03 → 08/05
----------------------------	--------	-----	---------------

SAC020
H2 **SENSORE POSIZIONE ALBERO A CAM**
CAMSHAFT POSITION SENSOR

KW

FORD
FOCUS Station wagon (DNW)

ST170 Petrol 127 08/02 → 11/04

SAC021
H2 **SENSORE POSIZIONE ALBERO A CAM**
CAMSHAFT POSITION SENSOR

KW

OPEL
OMEGA B (25_, 26_, 27_)

2.6 V6 Petrol 132 09/00 → 07/03

3.2 V6 Petrol 160 02/01 → 07/03

OMEGA B Station wagon (21_, 22_, 23_)

2.6 V6 Petrol 132 09/00 → 07/03

3.2 V6 Petrol 160 02/01 → 07/03

SIGNUM

3.2 V6 Petrol 155 05/03 →

VECTRA B (36_)

2.6 i V6 Petrol 125 09/00 → 04/02

VECTRA B 2 volumi /Coda spiovente (38_)

2.6 i V6 Petrol 125 09/00 → 07/03

VECTRA B Station wagon (31_)

2.6 i V6 Petrol 125 09/00 → 07/03

VECTRA C

3.2 V6 Petrol 155 08/02 →

SAC021

KW

OPEL
VECTRA C GTS

3.2 V6 Petrol 155 08/02 →

VECTRA C Station wagon

3.2 V6 Petrol 155 10/03 →

SAC023
H2 **SENSORE POSIZIONE ALBERO A CAM**
CAMSHAFT POSITION SENSOR

KW

FORD
GALAXY (WA6)

2.3 Petrol 118 07/07 →

MONDEO IV (BA7)

2.3 Petrol 118 07/07 →

MONDEO IV Tre volumi (BA7)

2.3 Petrol 118 07/07 →

MONDEO IV Turnier (BA7)

2.3 Petrol 118 07/07 →

S-MAX (WA6)

2.3 Petrol 118 07/07 →

SAC024

H2 **SENSORE POSIZIONE ALBERO A CAM**
CAMSHAFT POSITION SENSOR



FIAT

BRAVO I (182)

2.0 HGT 20V (182AQ)	Petrol	113	11/98 → 10/01
---------------------	--------	-----	---------------

COUPE (FA/175)

2.0 20V	Petrol	113	04/98 → 08/00
---------	--------	-----	---------------

MAREA (185)

2.0 150 20V	Petrol	110	01/01 → 05/02
-------------	--------	-----	---------------

2.0 155 20V	Petrol	113	04/99 → 01/01
-------------	--------	-----	---------------

MAREA Weekend (185)

2.0 150 20V	Petrol	110	01/01 → 05/02
-------------	--------	-----	---------------

2.0 155 20V	Petrol	113	04/99 → 02/03
-------------	--------	-----	---------------

STILO (192)

2.4 20V (192_XD1A)	Petrol	125	10/01 → 12/03
--------------------	--------	-----	---------------

LANCIA

LYBRA (839AX)

2.0 20V (839AXC11, 839AXC1A)	Petrol	113	07/99 → 09/00
------------------------------	--------	-----	---------------

2.0 20V (839AXH1A)	Petrol	110	09/00 → 10/05
--------------------	--------	-----	---------------

LYBRA SW (839BX)

2.0 20V (839BXC11, 839BXC1A)	Petrol	113	07/99 → 09/00
------------------------------	--------	-----	---------------

2.0 20V (839BXH1A)	Petrol	110	09/00 → 10/05
--------------------	--------	-----	---------------

THESIS (841AX)

2.0 Turbo (841AXA1B03)	Petrol	136	07/02 → 07/09
------------------------	--------	-----	---------------

2.4 (841AXB1B00)	Petrol	125	07/02 → 07/09
------------------	--------	-----	---------------

SAC025

H2 **SENSORE POSIZIONE ALBERO A CAM**
CAMSHAFT POSITION SENSOR



OPEL

CALIBRA A (85_)

2.5 i V6	Petrol	125	04/93 → 07/97	CHASSIS: S1035179 →, R9003233
----------	--------	-----	---------------	-------------------------------

VECTRA A (86_, 87_)

2.5 V6	Petrol	125	02/93 → 11/95	CHASSIS: S1035179 →
--------	--------	-----	---------------	---------------------

VECTRA A 2 volumi /Coda spiovente (88_, 89_)

2.5 V6	Petrol	125	02/93 → 11/95	CHASSIS: S1035179 →
--------	--------	-----	---------------	---------------------

VECTRA B (36_)

2.5 i V6	Petrol	125	10/95 → 09/00
----------	--------	-----	---------------

i 500 2.5	Petrol	143	05/98 → 09/00
-----------	--------	-----	---------------

VECTRA B 2 volumi /Coda spiovente (38_)

2.5 i V6	Petrol	125	10/95 → 09/00
----------	--------	-----	---------------

VECTRA B Station wagon (31_)

i 500 2.5	Petrol	143	05/98 → 09/00
-----------	--------	-----	---------------

SAAB

900 II

2.5 -24 V6	Petrol	125	07/93 → 08/94	ENGINE: 55899 →
------------	--------	-----	---------------	-----------------

900 II Cabriolet

2.5 -24 V6	Petrol	125	12/93 → 08/94	ENGINE: 55899 →
------------	--------	-----	---------------	-----------------

VAUXHALL

CAVALIER Mk III (87)

2.5 V6	Petrol	125	08/88 → 06/94	CHASSIS: S1035179 →
--------	--------	-----	---------------	---------------------

CAVALIER Mk III 2 volumi /Coda spiovente

2.5 V6	Petrol	125	09/88 → 06/94	CHASSIS: S1035179 →
--------	--------	-----	---------------	---------------------

VECTRA (B)

2.5 i GSi	Petrol	143	03/98 → 07/00
-----------	--------	-----	---------------

2.5 i V6	Petrol	125	09/95 → 08/00
----------	--------	-----	---------------

VECTRA (B) 2 volumi /Coda spiovente

2.5 i GSi	Petrol	143	03/98 → 07/00
-----------	--------	-----	---------------

2.5 i V6	Petrol	125	09/95 → 08/00	CHASSIS: S1035179 →
----------	--------	-----	---------------	---------------------

VECTRA (B) Station wagon

2.5 i GSi	Petrol	143	05/98 → 09/99
-----------	--------	-----	---------------

2.5 i V6	Petrol	125	11/96 → 08/00
----------	--------	-----	---------------

SAC026
H2 **SENSORE POSIZIONE ALBERO A CAM**
CAMSHAFT POSITION SENSOR

KIA
SPORTAGE (K00)

2.0	Petrol	87	10/00 → 08/03
2.0 4WD	Petrol	87	10/00 → 08/03
2.0 i 16V	Petrol	94	10/99 → 08/03
2.0 TD 4WD	Diesel	61	10/97 → 08/03

SAC028
H2 **SENSORE POSIZIONE ALBERO A CAM**
CAMSHAFT POSITION SENSOR

HONDA
ACCORD VI (CG, CK)

2.0 i	Petrol	108	10/98 → 01/01
-------	--------	-----	---------------

ACCORD VI Coupé (CG)

2.0 i 16V	Petrol	108	02/98 → 06/03
-----------	--------	-----	---------------

ACCORD VI Hatchback (CH)

2.0 (CH7)	Petrol	108	12/99 → 12/02
-----------	--------	-----	---------------

SAC029
H2 **SENSORE POSIZIONE ALBERO A CAM**
CAMSHAFT POSITION SENSOR

ALFA ROMEO
147 (937)

3.2 GTA	Petrol	184	02/03 → 03/10
---------	--------	-----	---------------

156 (932)

2.5 V6 24V (932A11_)	Petrol	141	01/02 → 09/05
3.2 GTA (932AXB)	Petrol	184	03/02 → 09/05

156 Sportwagon (932)

2.5 V6 24V (932B11_)	Petrol	141	01/02 → 05/06
3.2 GTA (932BxB)	Petrol	184	03/02 → 05/06

164 (164)

3.0 24V Q4 (164.K1M, 164.K1C)	Petrol	170	02/94 → 09/98
3.0 24V QV (164.H1)	Petrol	171	09/92 → 09/98

166 (936)

2.0 V6 (936A3_)	Petrol	151	09/98 → 10/00
2.5 V6 24V (936A2_)	Petrol	140	09/98 → 10/00
2.5 V6 24V (936A21_)	Petrol	138	10/00 → 06/07
3.0 V6 24V (936A1_)	Petrol	166	09/98 → 10/00
3.0 V6 24V (936A11_)	Petrol	162	10/00 → 06/07
3.2 V6 24V	Petrol	176	10/03 → 06/07

GT (937)

3.2 GTA	Petrol	176	11/03 → 09/10
---------	--------	-----	---------------

SAC029



ALFA ROMEO

GTV (916C_)

3.0 V6 24V (916.C1B_) Petrol 160 10/00 → 10/05

3.2 V6 24V Petrol 176 06/03 → 10/05

SPIDER (916S_)

3.0 V6 (916S1) Petrol 141 06/95 → 09/00

3.0 V6 (916S1B00) Petrol 160 09/94 → 08/00

3.2 V6 24V Petrol 176 06/03 → 04/05

LANCIA

KAPPA (838A)

3.0 24V (838AD1AA, 838AD11A, 838XD1AA, 838ZD1AA) Petrol 150 11/94 → 12/00

THESES (841AX)

3.0 V6 (841AXC1101) Petrol 158 07/02 → 07/09

3.2 V6 Petrol 169 05/03 → 07/09

SAC030

H2 **SENSORE POSIZIONE ALBERO A CAM**
CAMSHAFT POSITION SENSOR



KIA

MAGENTIS (GD)

2.0 Petrol 100 05/01 →

SORENTO I (JC)

2.4 Petrol 102 08/02 →

VOLVO

S40 I (VS)

1.8 i Petrol 90 06/01 → 12/03

1.8 i Petrol 92 03/98 → 12/03

V40 Station wagon (VW)

1.8 i Petrol 90 06/01 → 06/04

1.8 i Petrol 92 03/98 → 06/04

SAC031

H2 **SENSORE POSIZIONE ALBERO A CAM**
CAMSHAFT POSITION SENSOR



MERCEDES-BENZ

CLASSE C (W204)

C 180 CGI (204.049) Petrol 115 01/07 →

CLASSE C T-Model (S204)

C 180 CGI (204.249) Petrol 115 11/09 →

CLASSE GL (X164)

GL 450 CDI 4-matic (164.828) Diesel 225 05/09 →

CLASSE M (W164)

ML 450 CDI 4-matic (164.128) Diesel 225 09/09 →

SAC032

H2 **SENSORE POSIZIONE ALBERO A CAM**
CAMSHAFT POSITION SENSOR



OPEL

ASTRA G 2 volumi /Coda spiovente (F48_, F08_)

2.0 16V Petrol 100 02/98 → 01/05

2.0 16V OPC Petrol 118 11/99 → 09/02

ASTRA G Station wagon (F35_)

2.0 16V Petrol 100 02/98 → 07/04

SAC032

KW

OPEL
ASTRA G Tre volumi (F69_)

2.0 16V Petrol 100 09/98 → 01/05

OMEGA B (25_, 26_, 27_)

2.2 16V Petrol 106 09/99 → 07/03

OMEGA B Station wagon (21_, 22_, 23_)

2.2 16V Petrol 106 09/99 → 07/03

VAUXHALL
ASTRA Mk IV (G) 2 volumi /Coda spiovente

2.0 16V Petrol 100 02/98 → 05/05

ASTRA Mk IV (G) Station wagon

2.0 16V Petrol 100 02/98 → 05/05

ASTRA Mk IV (G) Tre volumi

2.0 16V Petrol 100 09/98 → 05/05

OMEGA (B)

2.2 16V Petrol 106 01/94 → 06/03

OMEGA (B) Station wagon

2.2 16V Petrol 106 02/94 → 06/03

SAC033
H2
**SENSORE POSIZIONE ALBERO A CAM
CAMSHAFT POSITION SENSOR**

KW

FORD
MONDEO IV (BA7)

2.5 Petrol 162 03/07 →

MONDEO IV Tre volumi (BA7)

2.5 Petrol 162 03/07 →

MONDEO IV Turnier (BA7)

2.5 Petrol 162 03/07 →

S-MAX (WA6)

2.5 ST Petrol 162 05/06 →

SAC034
H2
**SENSORE POSIZIONE ALBERO A CAM
CAMSHAFT POSITION SENSOR**

KW

BMW
3 (E36)

318 is Petrol 103 03/93 → 09/93

3 Coupé (E36)

318 is Petrol 103 03/92 → 09/93

5 (E34)

530 i V8 Petrol 160 09/92 → 09/95

540 i V8 Petrol 210 09/92 → 09/95

5 Touring (E34)

530 i V8 Petrol 160 09/92 → 01/97

540 i Petrol 210 09/93 → 01/97

7 (E32)

730 i,iL V8 Petrol 160 04/92 → 09/94

740 i,iL V8 Petrol 210 04/92 → 09/94

7 (E38)

730 i,iL Petrol 155 10/94 → 11/01

730 i,iL Petrol 160 10/94 → 11/01

740 i,iL Petrol 210 10/94 → 11/01

8 (E31)

840 i Petrol 210 02/93 → 02/96

SAC035

H2

**SENSORE POSIZIONE ALBERO A CAM
CAMSHAFT POSITION SENSOR**



KW



OPEL

ASTRA G 2 volumi /Coda spiovente (F48_, F08_)

2.0 OPC	Petrol	141	09/02 → 01/05
2.0 OPC	Petrol	147	11/02 → 01/05

ASTRA G Cabriolet (F67)

2.0 16V Turbo	Petrol	147	11/02 → 10/05
2.0 OPC	Petrol	141	03/02 → 10/05

ASTRA G Coupé (F07_)

2.0 16V Turbo	Petrol	140	09/00 → 08/01
2.0 16V Turbo	Petrol	141	08/01 → 05/05
2.0 16V Turbo	Petrol	147	11/02 → 05/05

ASTRA G Station wagon (F35_)

2.0 OPC	Petrol	141	09/02 → 07/04
2.0 OPC	Petrol	147	11/02 → 07/04

ASTRA H (L48)

2.0 Turbo	Petrol	125	03/04 →
2.0 Turbo	Petrol	147	09/04 →
2.0 Turbo	Petrol	177	03/05 →

ASTRA H GTC (L08)

2.0 Turbo	Petrol	125	03/05 →
2.0 Turbo	Petrol	147	03/05 →
2.0 Turbo	Petrol	177	08/05 →

ASTRA H Station wagon (L35)

2.0 Turbo	Petrol	125	08/04 →
2.0 Turbo	Petrol	147	09/04 →

ASTRA H TwinTop (L67)

2.0 Turbo	Petrol	125	09/05 →
2.0 Turbo	Petrol	147	09/05 →

SPEEDSTER

2.0 Turbo	Petrol	147	04/03 →
-----------	--------	-----	---------

ZAFIRA A (F75_)

2.0 OPC	Petrol	141	09/01 → 06/05
2.0 OPC	Petrol	147	11/02 → 06/05

SAC035



KW



OPEL

ZAFIRA B (A05)

2.0	Petrol	147	07/05 →
2.0	Petrol	177	01/06 →

VAUXHALL

ASTRA Mk IV (G) 2 volumi /Coda spiovente

2.0 SRI Turbo	Petrol	141	07/02 → 05/05
---------------	--------	-----	---------------

ASTRA Mk IV (G) Cabriolet

2.0 Turbo	Petrol	141	03/02 → 10/05
-----------	--------	-----	---------------

ASTRA Mk IV (G) Coupé (F67)

2.0 16V Turbo	Petrol	140	09/00 → 08/05
---------------	--------	-----	---------------

ASTRA Mk V (H) 2 volumi /Coda spiovente

2.0 Turbo	Petrol	125	01/04 → 05/09
2.0 Turbo	Petrol	147	01/04 → 05/09
2.0 Turbo	Petrol	177	01/04 → 05/09

ASTRA Mk V (H) Sport Hatch

2.0 Turbo	Petrol	125	02/05 → 11/10
-----------	--------	-----	---------------

ASTRA Mk V (H) Station wagon

2.0 Turbo	Petrol	125	08/04 → 10/10
2.0 Turbo	Petrol	147	08/04 → 10/10

ASTRA TwinTop Mk V (H)

2.0	Petrol	125	02/06 → 11/10
-----	--------	-----	---------------

SINTRA

2.2 i 16 V	Petrol	104	11/96 → 04/99
------------	--------	-----	---------------

VX220

2.0 i Turbo	Petrol	147	03/01 → 07/05
-------------	--------	-----	---------------

ZAFIRA Mk I (A) (F75)

2.0 GSI Turbo	Petrol	141	09/01 → 06/05
---------------	--------	-----	---------------

ZAFIRA Mk II (B) (M75)

2.0	Petrol	147	07/05 →
2.0	Petrol	176	01/06 →

SAC036
H2 **SENSORE POSIZIONE ALBERO A CAM**
CAMSHAFT POSITION SENSOR

CHEVROLET
EVANDA

2.0 Petrol 96 03/05 →

LACETTI (J200)

1.8 Petrol 90 03/05 →

NUBIRA Station wagon

1.8 Petrol 90 03/05 →

NUBIRA Tre volumi

1.8 Petrol 90 03/05 →

TACUMA

2.0 Petrol 89 03/05 →

2.0 Petrol 90 08/05 →

DAEWOO
EVANDA (KLAL)

2.0 Petrol 96 08/02 →

LACETTI 2 volumi /Coda spiovente (KLAN)

1.8 Petrol 90 02/04 →

LACETTI Tre volumi (J200)

1.8 CDX Petrol 90 08/03 → 12/04

LEGANZA (KLAV)

2.0 16V Petrol 98 06/97 → 12/02

2.0 16V Petrol 93 07/00 → 04/04

2.2 16V Petrol 100 04/99 → 12/02

NUBIRA Tre volumi (KLAN)

1.8 Petrol 90 07/03 →

NUBIRA Wagon (KLAN)

1.8 Petrol 90 07/03 →

TACUMA (KLAU)

2.0 Petrol 94 09/00 →

2.0 Petrol 89 09/01 →

OPEL
FRONTERA B (6B_)

 2.2 i (6B_ZC,
6B_VF, 6B_66,
6B_76) Petrol 100 10/98 →

SAC037
H2 **SENSORE POSIZIONE ALBERO A CAM**
CAMSHAFT POSITION SENSOR

SUBARU
JUSTY III (G3X)

1.3 Petrol 69 09/03 →

SUZUKI
GRAND VITARA I (FT, GT)

1.6 Petrol 69 03/01 → 09/02

IGNIS II

1.5 Petrol 73 09/03 →

1.5 4x4 Petrol 73 09/03 →

SAC038
H2 **SENSORE POSIZIONE ALBERO A CAM**
CAMSHAFT POSITION SENSOR

IVECO
DAILY III Cassone / Furgonato / Promiscuo

 29 L 10 V
(ALJA43A2,
ALJA42A2,
ALJA41A2) Diesel 70 09/02 →

 29 L 12 V
(ALKA41A2,
ALLA52A2,
ALKA42A2) Diesel 85 09/02 →

SAC032



IVECO

DAILY III Cassone / Furgonato / Promiscuo

35 C 12 V, 35 S 12 V (AGKA43A2, AGKB43A2, AGKB46A2...)	Diesel	85	09/02 →
--	--------	----	---------

35 S 10 (ANJA41A1, ANJA42A2, ANJA42AB, ANJA43A, ANJAV1A...)	Diesel	70	09/02 →
--	--------	----	---------

DAILY III Pianale piatto/Telaio

29 L 10 (ALJAV1A1, ALJA41AA, ALJA41A1, AHJA64A1...)	Diesel	70	09/02 →
---	--------	----	---------

29 L 12 (ALKA41A1, AHKA64A1, ALLA51A1)	Diesel	85	09/02 →
---	--------	----	---------

29 L 14 (AHRA11C1B1, AHRA14C1B1, AHRA64C1B1)	Diesel	100	11/05 →
---	--------	-----	---------

35 C 10 V, 35 S 10 V (AMJA11A1, AMJA14A1, AMJA64A1...)	Diesel	70	09/02 →
--	--------	----	---------

35 C 12 , 35 S 12 (AEKA14A1, AEKA14AA, AEKA64A1...)	Diesel	85	09/02 →
--	--------	----	---------

SAC039

H2 **SENSORE POSIZIONE ALBERO A CAM**
CAMSHAFT POSITION SENSOR

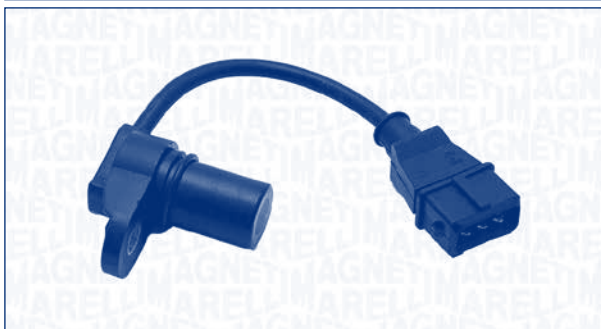

HYUNDAI

COUPE (RD)

1.6 16V	Petrol	85	03/98 → 04/02
---------	--------	----	---------------

1.6 i 16V	Petrol	84	12/96 → 04/02
-----------	--------	----	---------------

LANTRA II (J-2)

1.6 16V	Petrol	84	11/95 → 09/00
---------	--------	----	---------------

1.6 i	Petrol	66	11/95 → 09/00
-------	--------	----	---------------

1.8 16V	Petrol	94	11/95 → 09/00
---------	--------	----	---------------

LANTRA II Wagon (J-2)

2.0 16V	Petrol	102	12/96 → 10/00
---------	--------	-----	---------------

SAC040

H2 **SENSORE POSIZIONE ALBERO A CAM**
CAMSHAFT POSITION SENSOR



AUDI

A8 (4D2, 4D8)

6.0 W12 quattro	Petrol	309	01/01 → 09/02
-----------------	--------	-----	---------------

A8 (4E_)

6.0 W12 quattro	Petrol	331	12/03 → 07/10
-----------------	--------	-----	---------------

TT (8N3)

3.2 VR6 quattro	Petrol	184	07/03 → 06/06
-----------------	--------	-----	---------------

TT Roadster (8N9)

3.2 VR6 quattro	Petrol	184	07/03 → 06/06
-----------------	--------	-----	---------------

SAC040

KW

FORD
GALAXY (WGR)

2.8 i V6	Petrol	128	11/95 → 04/00
2.8 i V6 4x4	Petrol	128	04/96 → 04/00
2.8 V6	Petrol	150	04/00 → 05/06

SEAT
ALHAMBRA (7V8, 7V9)

2.8 V6	Petrol	150	06/00 → 03/10
2.8 V6 4motion	Petrol	150	06/00 → 03/10

LEON (1M1)

2.8 Cupra 4	Petrol	150	02/01 → 06/06
-------------	--------	-----	---------------

TOLEDO II (1M2)

2.3 V5	Petrol	110	04/99 → 05/01
2.3 V5 20V	Petrol	125	05/01 → 05/06

VOLKSWAGEN
BORA (1J2)

2.3 V5	Petrol	110	10/98 → 10/00
2.3 V5 4motion	Petrol	110	12/98 → 10/00

BORA Station wagon (1J6)

2.3 V5	Petrol	110	05/99 → 10/00
2.3 V5 4motion	Petrol	110	05/99 → 10/00

EOS (1F7, 1F8)

3.2 V6	Petrol	184	06/06 → 05/09
--------	--------	-----	---------------

GOLF III (1H1)

2.9 VR6 Syncro (1HX1)	Petrol	140	10/94 → 08/97
-----------------------	--------	-----	---------------

GOLF III Variant (1H5)

2.9 VR6	Petrol	140	10/94 → 04/99
---------	--------	-----	---------------

GOLF IV (1J1)

2.3 V5	Petrol	110	08/97 → 10/00
2.3 V5	Petrol	125	10/00 → 06/05
2.3 V5 4motion	Petrol	125	10/00 → 06/05
2.8 V6 4motion	Petrol	150	03/99 → 06/05
3.2 R32 4motion	Petrol	177	09/02 → 06/05

GOLF IV Variant (1J5)

2.3 V5	Petrol	110	05/99 → 06/06
2.3 V5	Petrol	125	10/00 → 06/06
2.3 V5 4motion	Petrol	125	10/00 → 06/06
2.8 V6 4motion	Petrol	150	05/99 → 06/06

MULTIVAN V (7HM, 7HN, 7HF, 7EF, 7EM, 7EN)

3.2 V6	Petrol	170	02/04 → 06/04
3.2 V6	Petrol	173	02/04 → 11/09
3.2 V6 4motion	Petrol	173	07/04 → 11/09

SAC040

KW

VOLKSWAGEN
NEW BEETLE (9C1, 1C1)

2.3 V5	Petrol	125	10/00 → 09/10
RSI 3.2 4motion (1C9)	Petrol	165	04/00 → 05/01

PASSAT (3B2)

2.3 VR5 Syncro/4motion	Petrol	110	10/97 → 11/00
------------------------	--------	-----	---------------

PASSAT (3B3)

2.3 V5	Petrol	125	11/00 → 05/05
2.3 V5 4motion	Petrol	125	11/00 → 05/05
4.0 W8 4motion	Petrol	202	09/01 → 09/04

PASSAT Variant (3B5)

2.3 VR5 Syncro/4motion	Petrol	110	10/97 → 11/00
------------------------	--------	-----	---------------

PASSAT Variant (3B6)

2.3 VR5	Petrol	125	11/00 → 05/05
2.3 VR5 4motion	Petrol	125	11/00 → 05/05
4.0 W8 4motion	Petrol	202	09/01 → 09/04

PHAETON (3D_)

3.2 V6	Petrol	177	04/02 →
6.0 W12 4motion	Petrol	309	04/02 →

SHARAN (7M8, 7M9, 7M6)

2.8 V6 24V	Petrol	150	04/00 → 03/10
2.8 V6 24V 4motion	Petrol	150	04/00 → 03/10
2.8 VR6	Petrol	128	09/95 → 04/00

TOUAREG (7LA, 7L6, 7L7)

3.2 V6	Petrol	162	10/02 → 11/06
3.2 V6	Petrol	177	11/04 → 11/06

SAC041

H2 **SENSORE POSIZIONE ALBERO A CAM**
CAMSHAFT POSITION SENSOR



HYUNDAI

i30 (FD)

1.4	Petrol	80	10/07 → 11/11
1.6	Petrol	90	10/07 → 11/11

KIA

CEE'D 2 volumi /Coda spiovente (ED)

1.4	Petrol	80	12/06 →
1.6	Petrol	90	12/06 →

CEE'D SW (ED)

1.4	Petrol	80	09/07 →
1.6	Petrol	90	09/07 →

CERATO Tre volumi (LD)

1.6	Petrol	90	05/06 →
-----	--------	----	---------

SAC042

H2 **SENSORE POSIZIONE ALBERO A CAM**
CAMSHAFT POSITION SENSOR



BMW

3 (E36)

320 i	Petrol	110	09/90 → 09/92
-------	--------	-----	---------------

3 Coupé (E36)

320 i	Petrol	110	03/92 → 09/92
-------	--------	-----	---------------

SAC042



BMW

5 (E34)

520 i 24V	Petrol	110	09/89 → 09/92
525 i 24V	Petrol	141	09/89 → 09/92
525 iX 24V	Petrol	141	10/91 → 09/92

5 Touring (E34)

520 i	Petrol	110	11/91 → 09/92
525 i	Petrol	141	11/91 → 09/92
525 ix	Petrol	141	02/92 → 09/92

SAC043

H2 **SENSORE POSIZIONE ALBERO A CAM**
CAMSHAFT POSITION SENSOR



DAEWOO

KORANDO (KJ)

3.2 4x4	Petrol	156	01/99 →
---------	--------	-----	---------

MUSSO (FJ)

3.2 4x4	Petrol	162	01/99 →
---------	--------	-----	---------

MERCEDES-BENZ

CABRIOLET (A124)

300 CE-24 (124.061)	Petrol	162	04/92 → 06/93
---------------------	--------	-----	---------------

CLASSE C (W202)

C 220 (202.022)	Petrol	110	03/93 → 05/00
C 36 AMG (202.028)	Petrol	206	05/94 → 05/00

CLASSE E (W124)

E 220 (124.022)	Petrol	110	06/93 → 06/95
E 280 (124.028)	Petrol	145	06/93 → 06/95
E 280 (124.029)	Petrol	142	06/93 → 06/95
E 320 (124.032)	Petrol	162	06/93 → 06/95
E 420 (124.034)	Petrol	205	06/93 → 06/95
E 500 (124.036)	Petrol	235	06/93 → 06/95
E 60 AMG (124.036)	Petrol	280	05/94 → 06/95

SAC043

MERCEDES-BENZ
CLASSE E Cabriolet (A124)

E 320 (124.066) Petrol 162 06/93 → 03/98

E 36 AMG (124.066) Petrol 200 05/94 → 03/98

CLASSE E Coupé (C124)

E 320 (124.052) Petrol 162 06/93 → 06/97

E 36 AMG (124.052) Petrol 200 05/94 → 06/97

CLASSE E Station wagon (S124)

E 220 T (124.082) Petrol 110 06/93 → 06/96

E 280 T (124.088) Petrol 142 06/93 → 06/96

E 280 T (124.088) Petrol 145 06/93 → 06/96

E 320 T (124.092) Petrol 162 06/93 → 06/96

E 36 T AMG (124.092) Petrol 200 05/94 → 06/96

CLASSE G (W463)

G 320 (463.230, 463.231) Petrol 155 09/94 → 12/97

G 36 AMG (463.230) Petrol 200 01/95 →

CLASSE G Cabrio (W463)

320 GE (463.208) Petrol 155 09/94 → 11/97

CLASSE S (W140)

300 SE 2.8 (140.028) Petrol 145 01/93 → 10/98

400 SE, SEL/ S420 (140.042, 140.043) Petrol 210 02/91 → 10/98

500 SE, SEL (140.050, 140.051) Petrol 240 02/91 → 10/98

S 280 (140.028) Petrol 142 02/93 → 10/98

S 420 (140.042) Petrol 205 01/93 → 10/98

S 500 (140.050, 140.051) Petrol 235 01/93 → 10/98

CLASSE S Coupé (C140)

SEC/CL 420 (140.063) Petrol 205 10/94 → 02/99

SEC/CL 500 (140.070) Petrol 235 10/92 → 02/99

COUPE (C124)

220 CE (124.042) Petrol 110 10/92 → 05/93

320 CE (124.052) Petrol 162 10/92 → 05/93

KOMBI Station wagon (S124)

220 TE (124.082) Petrol 110 10/92 → 05/93

280 TE (124.088) Petrol 145 10/92 → 06/93

SAC043

MERCEDES-BENZ
KOMBI Station wagon (S124)

300 TE-24 (124.091) Petrol 162 09/89 → 08/92

320 TE (124.092) Petrol 162 10/92 → 06/93

SL (R129)

280 (129.058) Petrol 142 08/93 → 10/01

300 SL-24 (129.061) Petrol 170 03/89 → 07/93

320 (129.063) Petrol 170 09/93 → 10/01

500 (129.067) Petrol 235 09/92 → 10/01

500 SL (129.066) Petrol 240 09/89 → 08/92

Tre volumi (W124)

220 E (124.022) Petrol 110 10/92 → 06/93

280 E (124.028) Petrol 145 10/92 → 06/93

300 E-24 (124.031) Petrol 162 09/88 → 08/92

320 E (124.032) Petrol 162 10/92 → 06/93

400 E 4.2 (124.034) Petrol 205 10/92 → 06/93

500 E (124.036) Petrol 240 01/91 → 06/93

SSANGYONG
KORANDO (KJ)

3.2 Petrol 156 01/99 →

KORANDO Cabrio (KJ)

3.2 Petrol 156 01/99 →

SAC044
**H2 SENSORE POSIZIONE ALBERO A CAM
CAMSHAFT POSITION SENSOR**

MAZDA
3 (BK)

1.4 Petrol 62 10/03 → 06/09

1.6 Petrol 77 10/03 → 06/09

2.0 Petrol 110 10/03 → 06/09

SAC044



MAZDA

2.0 MZR-CD	Diesel	105	12/06 → 06/09
2.3 MPS	Petrol	191	12/06 → 06/09

3 Tre volumi (BK)

2.0 MZR-CD	Diesel	105	12/06 →
------------	--------	-----	---------

SAC045

H2 **SENSORE POSIZIONE ALBERO A CAM**
CAMSHAFT POSITION SENSOR



HYUNDAI

ACCENT I (X-3)

1.3	Petrol	44	10/94 → 01/00
1.3	Petrol	55	10/94 → 01/00
1.3 i 12V	Petrol	62	10/94 → 01/00
1.5 i 12V	Petrol	65	10/94 → 01/00
1.5 i 16V	Petrol	73	12/95 → 01/00

ACCENT Tre volumi (X-3)

1.3	Petrol	44	10/94 → 01/00
1.3	Petrol	55	10/94 → 01/00
1.3 i 12V	Petrol	62	10/94 → 01/00
1.5 i 12V	Petrol	65	10/94 → 01/00
1.5 i 16V	Petrol	73	10/95 → 01/00

S COUPE (SLC)

1.5 i	Petrol	65	04/94 → 05/96
1.5 i Turbo	Petrol	85	04/94 → 05/96

SAC046

H2 **SENSORE POSIZIONE ALBERO A CAM**
CAMSHAFT POSITION SENSOR

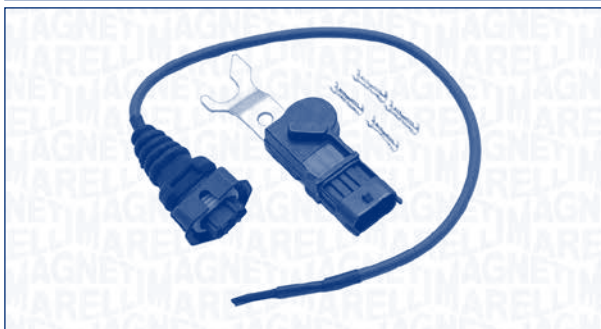

OPEL

ASTRA F (56_, 57_)

1.8 i 16V	Petrol	85	11/94 → 09/98
1.8 i 16V	Petrol	92	06/93 → 10/94
2.0 i 16V	Petrol	100	02/95 → 09/98

ASTRA F 2 volumi /Coda spiovente (53_, 54_, 58_, 59_)

1.8 i 16V	Petrol	85	09/94 → 01/98
1.8 i 16V	Petrol	92	06/93 → 08/94
2.0 i 16V	Petrol	100	02/95 → 01/98

ASTRA F Cabriolet (53_B)

1.8 i 16V	Petrol	85	11/94 → 03/01
-----------	--------	----	---------------

ASTRA F Station wagon (51_, 52_)

1.8 i 16V	Petrol	85	07/94 → 01/98
1.8 i 16V	Petrol	92	06/93 → 01/98
2.0 i 16V	Petrol	100	02/95 → 01/98

CALIBRA A (85_)

2.0 i 16V	Petrol	100	02/94 → 07/97
2.0 i 16V 4x4	Petrol	100	02/94 → 07/97

OMEGA B (25_, 26_, 27_)

2.0 16V	Petrol	100	03/94 → 09/99
---------	--------	-----	---------------

OMEGA B Station wagon (21_, 22_, 23_)

2.0 16V	Petrol	100	03/94 → 09/99
---------	--------	-----	---------------

VECTRA B (36_)

2.0 i 16V	Petrol	100	10/95 → 09/00
-----------	--------	-----	---------------

VECTRA B 2 volumi /Coda spiovente (38_)

2.0 i 16V	Petrol	100	10/95 → 09/00
-----------	--------	-----	---------------

VAUXHALL

ASTRA Mk III (F)

1.8 i 16V	Petrol	85	01/94 → 12/96
1.8 i 16V	Petrol	92	06/93 → 10/94
2.0 i 16V	Petrol	100	02/95 → 09/98

ASTRA Mk III (F) 2 volumi /Coda spiovente

1.8 i 16V	Petrol	85	09/94 → 02/98
1.8 i 16V	Petrol	92	09/94 → 02/98
2.0 i 16V	Petrol	100	01/94 → 02/98

SAC046

KW

OPEL
ASTRA Mk III (F) Cabriolet

1.8 16V	Petrol	85	11/94 → 03/01
---------	--------	----	---------------

ASTRA Mk III (F) Station wagon

1.8 i 16V	Petrol	85	09/94 → 02/98
-----------	--------	----	---------------

1.8 i 16V	Petrol	92	09/94 → 02/98
-----------	--------	----	---------------

2.0 i 16V	Petrol	100	01/94 → 02/98
-----------	--------	-----	---------------

VECTRA (B)

2.0 i 16V	Petrol	100	10/95 → 01/01
-----------	--------	-----	---------------

VECTRA (B) 2 volumi /Coda spiovente

2.0 i 16V	Petrol	100	10/95 → 01/01
-----------	--------	-----	---------------

VECTRA (B) Station wagon

2.0 i 16V	Petrol	100	10/95 → 01/01
-----------	--------	-----	---------------

SAC047
H2
**SENSORE POSIZIONE ALBERO A CAM
CAMSHAFT POSITION SENSOR**

KW

VOLKSWAGEN
TIGUAN (5N_)

2.0 TDi	Diesel	103	03/08 →
---------	--------	-----	---------

2.0 TDI 4motion	Diesel	103	09/07 →
-----------------	--------	-----	---------

SAC048
H2
**SENSORE POSIZIONE ALBERO A CAM
CAMSHAFT POSITION SENSOR**

KW

SMART
CABRIO (450)

0.6 (450.400, S1OLD2)	Petrol	45	01/01 → 01/04
-----------------------	--------	----	---------------

0.6 (450.433, S1OLA1)	Petrol	40	03/00 → 01/04
-----------------------	--------	----	---------------

0.8 CDI (450.401, 450.402, 450.403, S1OLC1)	Diesel	30	03/01 → 01/04
---	--------	----	---------------

CITY-COUPE (450)

0.6 (450.333, 450.335)	Petrol	45	01/01 → 01/04
------------------------	--------	----	---------------

0.6 (450.341, S1CLA1)	Petrol	40	07/98 → 01/04
-----------------------	--------	----	---------------

0.6 (450.342, S1CLB1)	Petrol	33	07/98 → 01/04
-----------------------	--------	----	---------------

0.8 CDI (450.300, 450.301, 450.302, 450.303, 450.306...)	Diesel	30	11/99 → 01/04
--	--------	----	---------------

SAC049

H2 **SENSORE POSIZIONE ALBERO A CAM**
CAMSHAFT POSITION SENSOR

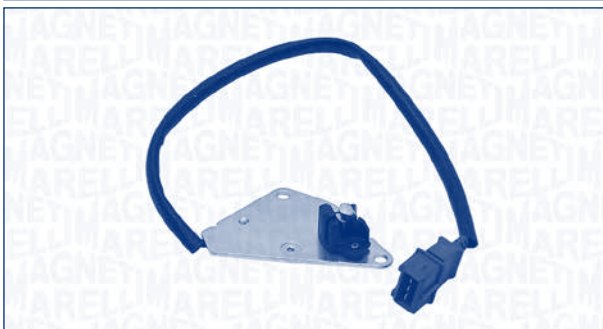

ALFA ROMEO

145 (930)

2.0 16V T.S. Petrol 110 10/95 → 04/98

146 (930)

2.0 16V T.S. Petrol 110 10/95 → 04/98

155 (167)

2.0 T.S. 16V (167.A2G) Petrol 110 03/95 → 10/97

156 (932)

1.6 16V T.SPARK (932A4) Petrol 88 09/97 → 12/01

156 Sportwagon (932)

1.6 16V T.SPARK (932A4) Petrol 88 05/00 → 12/01

GTV (916C_)

2.0 T.SPARK 16V (916.C2_, 916C2C00) Petrol 110 06/95 → 02/98

SPIDER (916S_)

2.0 T.SPARK 16V (916S2C00) Petrol 110 06/95 → 02/98

FIAT

BARCETTA (183)

1.8 16V Petrol 96 04/95 → 05/98

BRAVA (182)

1.8 GT 16V (182.BC) Petrol 83 11/98 → 07/99

BRAVO I (182)

1.8 GT (182.AC) Petrol 83 11/98 → 07/99

2.0 HGT 20V (182.AD) Petrol 108 10/95 → 07/98

SAC049



LANCIA

KAPPA (838A)

2.0 20V (838AA1AA) Petrol 107 10/94 → 06/96

2.0 20V Turbo (838AM1AA) Petrol 162 06/98 → 12/00

2.4 20V (838AC1AA, 838AC11A) Petrol 129 08/94 → 06/98

KAPPA Coupé (838)

2.0 20V Petrol 114 07/96 → 06/98

2.0 20V Turbo (838CM) Petrol 162 06/98 → 06/00

KAPPA SW (838B)

2.0 20V Turbo (838BM1AA) Petrol 162 06/98 → 12/00

SAC050

H2 **SENSORE POSIZIONE ALBERO A CAM**
CAMSHAFT POSITION SENSOR



BMW

3 (E36)

316 i Petrol 75 07/93 → 09/95

318 i Petrol 85 10/93 → 09/95

318 is Petrol 103 10/93 → 02/98

3 Cabriolet (E36)

318 i Petrol 85 01/94 → 09/95

3 Compact (E36)

316 i Petrol 75 03/94 → 09/95

318 ti Petrol 103 11/94 → 08/95

3 Coupé (E36)

316 i Petrol 75 09/93 → 09/95

318 is Petrol 103 10/93 → 10/95

5 (E34)

518 i Petrol 85 09/90 → 09/95

SAC050

BMW
5 Touring (E34)

518 g	BiFuel	85	11/95 → 06/96
518 i	Petrol	85	09/94 → 01/97

SAC051
H2 **SENSORE POSIZIONE ALBERO A CAM**
CAMSHAFT POSITION SENSOR

CHEVROLET
AVEO Tre volumi (T250, T255)

1.2	Petrol	53	03/06 → 12/07
1.4	Petrol	69	03/06 → 12/07

LACETTI (J200)

1.4 16V	Petrol	70	03/05 →
1.6	Petrol	80	03/05 →
1.8	Petrol	89	08/05 →

DAEWOO
KALOS (KLAS)

1.2	Petrol	53	04/03 →
1.4 16V	Petrol	69	04/03 →

NUBIRA Tre volumi (KLAJ)

1.6 16V	Petrol	76	07/00 →
2.0 16V	Petrol	93	12/00 →

TACUMA (KLAU)

1.8	Petrol	72	09/00 →
1.8	Petrol	74	09/00 →

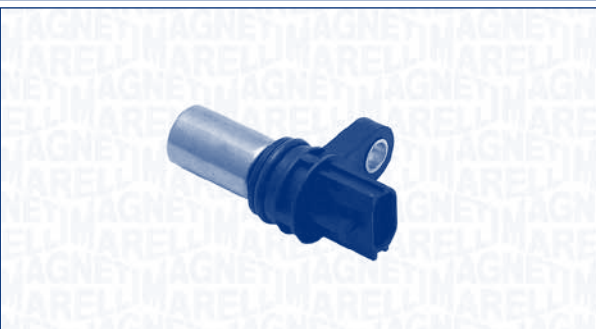
SAC052
H2 **SENSORE POSIZIONE ALBERO A CAM**
CAMSHAFT POSITION SENSOR

NISSAN
PRIMERA (P12)

2.0	Petrol	103	03/02 →
-----	--------	-----	---------

PRIMERA Hatchback (P12)

2.0	Petrol	103	07/02 →
-----	--------	-----	---------

PRIMERA Station wagon (WP12)

2.0	Petrol	103	03/02 →
-----	--------	-----	---------

X-TRAIL (T30)

2.0	Petrol	103	07/01 →
-----	--------	-----	---------

2.0 4x4	Petrol	103	07/01 →
---------	--------	-----	---------

2.5 4x4	Petrol	121	09/02 →
---------	--------	-----	---------

X-TRAIL (T31)

2.5 4x4	Petrol	124	06/07 →
---------	--------	-----	---------

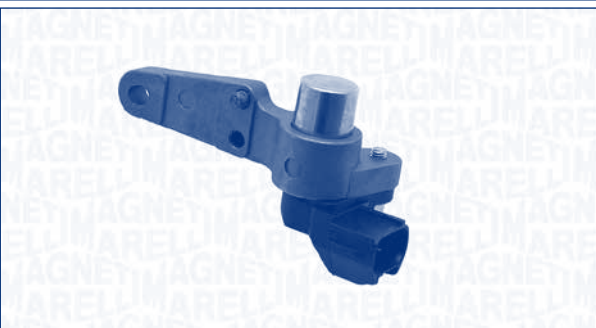
SAC053
H2 **SENSORE POSIZIONE ALBERO A CAM**
CAMSHAFT POSITION SENSOR

TOYOTA
AVENSIS (_T22_)

2.0 (ST220_)	Petrol	94	09/97 → 10/00
--------------	--------	----	---------------

AVENSIS Liftback (_T22_)

2.0 (ST220_)	Petrol	94	09/97 → 10/00
--------------	--------	----	---------------

AVENSIS Station Wagon (_T22_)

2.0 (ST220_)	Petrol	94	09/97 → 10/00
--------------	--------	----	---------------

SAC053



TOYOTA

RAV 4 I (SXA1_)

2.0 4WD Petrol 95 06/94 → 06/00

RAV 4 I Cabrio (SXA1_)

2.0 16V 4WD Petrol 94 12/97 → 06/00

SAC054

H2 **SENSORE POSIZIONE ALBERO A CAM**
CAMSHAFT POSITION SENSOR



FIAT

DUCATO Autobus (244, Z_)

2.3 JTD Diesel 81 04/02 →

DUCATO Autobus (250)

120 Multijet 2,3 D Diesel 88 07/06 →

DUCATO Furgonato (244)

2.3 JTD Diesel 81 04/02 →

DUCATO Furgonato (250)

120 Multijet 2,3 D Diesel 88 07/06 →

DUCATO Pianale piatto/Telaio (244)

2.3 JTD Diesel 81 04/02 → 07/06

DUCATO Pianale piatto/Telaio (250)

120 Multijet 2,3 D Diesel 88 07/06 →

130 Multijet 2,3 D Diesel 96 01/07 →

SAC055

H2 **SENSORE POSIZIONE ALBERO A CAM**
CAMSHAFT POSITION SENSOR



LEXUS

GS (JZS147)

300 Petrol 156 03/93 → 08/97

GS (UZS161, JZS160)

300 Petrol 161 10/00 → 03/05

430 Petrol 208 11/00 → 03/05

300 T3 Petrol 163 08/97 → 10/00

IS I (JCE1_, GXE1_)

200 Petrol 114 04/99 → 07/05

300 Petrol 157 09/01 → 07/05

LS (UCF10)

400 Petrol 180 12/89 → 12/94

LS (UCF20)

400 Petrol 194 12/94 → 08/97

400 Petrol 203 09/98 → 10/00

400 Petrol 209 09/97 → 10/00

LS (UCF30)

430 Petrol 207 10/00 → 08/06

SC (UZZ40_)

430 Petrol 210 05/01 → 07/10

TOYOTA

HILUX III Pick-up (TGN1_, GGN2_, GGN1_, KUN2_, KUN1_)

2.5 D 4WD Diesel 75 08/05 →

3.0 D-4D 4WD Diesel 126 12/07 →

LAND CRUISER (KDJ12_, GRJ12_)

3.0 D-4D (KDJ120, KDJ150, KDJ125) Diesel 120 01/03 → 02/10

4.0 (GRJ12, GRJ125) Petrol 183 01/03 →

LAND CRUISER 80 (_J8_)

4.5 24V (FZJ80_) Petrol 151 08/92 → 12/97

LAND CRUISER 90 (_J9_)

3.0 D-4D (KDJ90, KDJ95, KDJ 125) Diesel 120 10/00 →

SAC055

TOYOTA
SUPRA (JZA80)

3.0 i Bi-Turbo Petrol 243 05/93 → 08/02

SAC056
H2
**SENSORE POSIZIONE ALBERO A CAM
CAMSHAFT POSITION SENSOR**

HONDA
CIVIC VII Coupé (EM2)

1.7 i Petrol 88 05/01 → 12/05

1.7 i VTEC Petrol 92 05/01 → 12/05

CIVIC VII Hatchback (EU, EP, EV)

1.4 i Petrol 55 02/01 → 09/05

1.4 iS (EP1) Petrol 66 02/01 → 09/05

1.6 i Petrol 81 02/01 → 09/05

FR-V (BE)

1.7 Petrol 92 08/04 →

STREAM (RN)

1.7 16V Petrol 92 05/01 →

SAC057
H2
**SENSORE POSIZIONE ALBERO A CAM
CAMSHAFT POSITION SENSOR**

OPEL
ASTRA G 2 volumi /Coda spiovente (F48_, F08_)

1.6 Petrol 76 12/02 → 12/09

ASTRA G Cabriolet (F67)

1.6 Petrol 76 01/03 → 10/05

ASTRA G Coupé (F07_)

1.6 16V Petrol 76 03/00 → 05/05

ASTRA G Station wagon (F35_)

1.6 Petrol 76 12/02 → 07/09

ASTRA G Tre volumi (F69_)

1.6 Petrol 76 12/02 → 12/09

ASTRA H (L48)

1.6 Petrol 77 03/04 →

ASTRA H GTC (L08)

1.6 Petrol 77 03/05 →

ASTRA H Station wagon (L35)

1.6 Petrol 77 08/04 →

ASTRA H TwinTop (L67)

1.6 Petrol 77 09/05 →

MERIVA

1.6 Petrol 77 01/06 → 05/10

VECTRA C

1.6 Petrol 77 01/06 →

VECTRA C GTS

1.6 Petrol 77 01/06 →

ZAFIRA B (A05)

1.6 Petrol 77 07/05 →

SAC058

H2 **SENSORE POSIZIONE ALBERO A CAM**
CAMSHAFT POSITION SENSOR



HYUNDAI

ACCENT III (MC)

1.5 CRDi GLS Diesel 81 11/05 → 11/10

ACCENT Tre volumi (MC)

1.5 CRDi GLS Diesel 81 11/05 → 11/10

GETZ (TB)

1.5 CRDi Diesel 65 08/05 → 06/09

1.5 CRDi GLS Diesel 81 08/05 → 06/09

i10 (PA)

1.1 CRDi Diesel 55 01/08 →

i30 (FD)

1.6 CRDi Diesel 85 10/07 → 11/11

MATRIX (FC)

1.5 CRDi Diesel 75 12/04 → 08/10

1.5 CRDi VGT Diesel 81 08/05 → 08/10

KIA

CEE'D 2 volumi /Coda spiovente (ED)

1.6 CRDi 115 Diesel 85 12/06 →

1.6 CRDi 90 Diesel 66 12/06 →

CEE'D SW (ED)

1.6 CRDi 115 Diesel 85 09/07 →

1.6 CRDi 90 Diesel 66 09/07 →

CERATO (LD)

1.5 CRDi Diesel 75 07/05 →

1.6 CRDi Diesel 85 06/05 →

CERATO Tre volumi (LD)

1.5 CRDi Diesel 75 07/05 →

1.6 CRDi Diesel 85 06/05 →

PICANTO (BA)

1.1 CRDi Diesel 55 11/05 →

RIO II (JB)

1.5 CRDi Diesel 81 03/05 →

RIO II Tre volumi (JB)

1.5 CRDi Diesel 81 03/05 →

SAC059

H2 **SENSORE POSIZIONE ALBERO A CAM**
CAMSHAFT POSITION SENSOR



ALFA ROMEO

145 (930)

1.8 i.e. 16V Petrol 106 03/98 → 01/01

2.0 16V Quadrifoglio Petrol 114 03/98 → 01/01

146 (930)

1.8 i.e. 16V T.S. Petrol 106 03/98 → 01/01

2.0 16V Quadrifoglio Petrol 114 03/98 → 01/01

147 (937)

1.6 16V T.SPARK (937AXB1A) Petrol 88 01/01 → 03/10

1.6 16V T.SPARK ECO (937AXA1A) Petrol 77 01/01 → 03/10

2.0 16V T.SPARK (937AXC1_) Petrol 110 01/01 → 03/10

156 (932)

1.6 16V T.SPARK (932A4) Petrol 88 01/02 → 09/05

1.8 16V T.SPARK (932A3) Petrol 106 09/97 → 10/00

1.8 16V T.SPARK (932A31_) Petrol 103 10/00 → 09/05

2.0 16V T.SPARK (932A2) Petrol 114 09/97 → 10/00

2.0 16V T.SPARK (932A21_) Petrol 110 10/00 → 03/02

2.0 JTS (932AXA) Petrol 122 03/02 → 09/05

156 Sportwagon (932)

1.6 16V T.SPARK (932A4) Petrol 88 01/02 → 05/06

1.8 16V T.SPARK (932A3) Petrol 106 05/00 → 10/00

1.8 16V T.SPARK (932B31_) Petrol 103 10/00 → 05/06

SAC059

ALFA ROMEO
156 Sportwagon (932)

2.0 16V T.SPARK (932A2)	Petrol	114	05/00 → 06/02
-------------------------	--------	-----	---------------

2.0 16V T.SPARK (932B21_)	Petrol	110	10/00 → 03/02
---------------------------	--------	-----	---------------

2.0 JTS (932BXA)	Petrol	122	03/02 → 05/06
------------------	--------	-----	---------------

166 (936)

2.0 T.Spark (936A3A_)	Petrol	114	09/98 → 10/00
-----------------------	--------	-----	---------------

2.0 T.Spark (936A3B_)	Petrol	110	10/00 → 06/07
-----------------------	--------	-----	---------------

GT (937)

1.8 TS	Petrol	103	11/03 → 09/10
--------	--------	-----	---------------

2.0 JTS	Petrol	121	11/03 → 09/10
---------	--------	-----	---------------

GTV (916C_)

1.8 16V (916C3)	Petrol	106	05/98 → 12/00
-----------------	--------	-----	---------------

2.0 JTS	Petrol	121	04/03 → 10/05
---------	--------	-----	---------------

2.0 T.SPARK 16V (916.C2_, 916C2C00)	Petrol	110	03/98 → 09/00
-------------------------------------	--------	-----	---------------

SPIDER (916S_)

1.8 16V (916S3)	Petrol	106	05/98 → 12/00
-----------------	--------	-----	---------------

2.0 JTS	Petrol	121	04/03 → 04/05
---------	--------	-----	---------------

2.0 T.SPARK 16V (916S2B)	Petrol	114	05/98 → 08/00
--------------------------	--------	-----	---------------

2.0 T.SPARK 16V (916S2C00)	Petrol	110	03/98 → 04/05
----------------------------	--------	-----	---------------

SAC060
H2 **SENSORE POSIZIONE ALBERO A CAM**
CAMSHAFT POSITION SENSOR

TOYOTA
AVENSIS (_T22_)

1.8 VVT-i	Petrol	95	10/00 → 02/03
-----------	--------	----	---------------

SAC060

TOYOTA
AVENSIS (T25_)

1.8	Petrol	95	04/03 → 11/08
-----	--------	----	---------------

AVENSIS Liftback (_T22_)

1.8 VVT-i	Petrol	95	10/00 → 02/03
-----------	--------	----	---------------

AVENSIS Station Wagon (_T22_)

1.8 VVT-i	Petrol	95	10/00 → 02/03
-----------	--------	----	---------------

AVENSIS Station wagon (T25)

1.8	Petrol	95	04/03 → 11/08
-----	--------	----	---------------

AVENSIS Tre volumi (T25)

1.8	Petrol	95	04/03 → 11/08
-----	--------	----	---------------

CELICA (ZZT23_)

1.8 16V TS (ZZT231_)	Petrol	141	08/99 → 09/05
----------------------	--------	-----	---------------

1.8 16V VT-i (ZZT230_)	Petrol	105	08/99 → 07/05
------------------------	--------	-----	---------------

COROLLA Verso (ZDE12_, CDE12_)

1.8 VVT-i	Petrol	99	01/02 → 05/04
-----------	--------	----	---------------

COROLLA Verso (ZER_, ZZE12_, R1_)

1.8	Petrol	95	04/04 → 03/09
-----	--------	----	---------------

MR 2 III (ZZW3_)

1.8 16V VT-i (ZZW30)	Petrol	103	10/99 → 06/07
----------------------	--------	-----	---------------

RAV 4 II (CLA2_, XA2_, ZCA2_, ACA2_)

1.8 VVTi	Petrol	92	08/00 → 11/05
----------	--------	----	---------------

SAC061
H2 **SENSORE POSIZIONE ALBERO A CAM**
CAMSHAFT POSITION SENSOR

OPEL
VECTRA A (86_, 87_)

2.0 i 16V	Petrol	100	06/94 → 11/95
-----------	--------	-----	---------------

2.0 i 16V 4x4	Petrol	100	06/94 → 11/95
---------------	--------	-----	---------------

VECTRA A 2 volumi /Coda spiovente (88_, 89_)

2.0 i 16V	Petrol	100	06/94 → 11/95
-----------	--------	-----	---------------

SAC061



OPEL

VECTRA B (36_)

1.8 i 16V	Petrol	85	10/95 → 09/00	ENGINE: → 25037067
2.2 i 16V	Petrol	108	09/00 → 04/02	

VECTRA B 2 volumi /Coda spiovente (38_)

1.8 i 16V	Petrol	85	10/95 → 09/00	ENGINE: → 25037067
2.2 i 16V	Petrol	108	09/00 → 07/03	

VAUXHALL

CAVALIER Mk III (87)

2.0 SRi 16V	Petrol	100	09/93 → 11/95	
-------------	--------	-----	---------------	--

CAVALIER Mk III 2 volumi /Coda spiovente

2.0 i 16V	Petrol	100	09/93 → 11/95	
-----------	--------	-----	---------------	--

VECTRA (B)

1.8 i 16V	Petrol	85	10/95 → 09/00	ENGINE: → 25037067
2.2 i 16V	Petrol	108	08/95 → 10/01	ENGINE: → 25037067

VECTRA (B) 2 volumi /Coda spiovente

1.8 i 16V	Petrol	85	10/95 → 09/00	ENGINE: → 25037067
2.2 i 16V	Petrol	108	09/00 → 07/03	ENGINE: → 25037067

VECTRA (B) Station wagon

1.8 i 16V	Petrol	85	11/96 → 09/00	ENGINE: → 25037067
-----------	--------	----	---------------	--------------------

SAC062

H2 **SENSORE POSIZIONE ALBERO A CAM**
CAMSHAFT POSITION SENSOR

ALFA ROMEO

159 (939)

1.8 MPI	Petrol	103	03/07 → 11/11	
---------	--------	-----	---------------	--

159 Sportwagon (939)

1.8 MPI	Petrol	103	03/07 → 11/11	
---------	--------	-----	---------------	--

FIAT

CROMA (194)

1.8 16V	Petrol	103	12/05 →	
---------	--------	-----	---------	--

SAC062



OPEL

ASTRA H (L48)

1.6	Petrol	85	12/06 →	
1.8	Petrol	103	01/06 →	

ASTRA H GTC (L08)

1.6	Petrol	85	12/06 →	
1.8	Petrol	103	01/06 →	

ASTRA H Station wagon (L35)

1.6	Petrol	85	12/06 →	
1.8	Petrol	103	08/05 →	

ASTRA H TwinTop (L67)

1.6	Petrol	85	12/06 →	
1.8	Petrol	103	09/05 →	

SIGNUM

1.8	Petrol	103	09/05 →	
2.2 direct	Petrol	114	05/03 →	

VECTRA C

1.8	Petrol	103	01/06 →	
2.2 direct	Petrol	114	10/03 →	

VECTRA C GTS

1.8	Petrol	103	01/06 →	
2.2 direct	Petrol	114	10/03 →	

VECTRA C Station wagon

1.8	Petrol	103	01/06 →	
2.2 direct	Petrol	114	10/03 →	

ZAFIRA B (A05)

1.6	Petrol	85	01/08 →	
1.8	Petrol	103	07/05 →	
2.2	Petrol	110	07/05 →	

SAC063
H2 **SENSORE POSIZIONE ALBERO A CAM**
CAMSHAFT POSITION SENSOR

OPEL
ASTRA G 2 volumi /Coda spiovente (F48_, F08_)

1.6 Petrol 62 09/00 → 01/05

ASTRA G Furgonato (F70)

1.6 Petrol 62 09/00 → 04/05

ASTRA G Station wagon (F35_)

1.6 Petrol 62 09/00 → 07/04

ASTRA G Tre volumi (F69_)

1.6 Petrol 62 09/00 → 01/05

COMBO Cassone / Furgonato / Promiscuo

1.6 Petrol 64 10/01 →

COMBO Tour

1.6 Petrol 64 10/01 →

MERIVA

1.6 Petrol 64 05/03 → 05/10

VAUXHALL
ASTRA Mk IV (G) 2 volumi /Coda spiovente

1.6 Petrol 62 09/00 → 05/05

ASTRA Mk IV (G) Station wagon

1.6 Petrol 62 03/98 → 04/04

ASTRA Mk IV (G) Tre volumi

1.6 Petrol 62 09/00 → 05/05

ASTRAVAN Mk IV (G)

1.6 i Petrol 62 09/00 → 08/06

COMBO Mk II (C) Cassone / Furgonato / Promiscuo (F25)

1.6 Petrol 64 10/01 → 11/11

MERIVA Mk I (A)

1.6 i Petrol 64 01/03 → 06/10

SAC064
H2 **SENSORE POSIZIONE ALBERO A CAM**
CAMSHAFT POSITION SENSOR

CITROËN
XANTIA (X1)

2.0 i 16V Petrol 110 06/94 → 01/98

2.0 i 16V Petrol 112 03/93 → 01/98

XSARA (N1)

1.4 i Petrol 55 04/97 → 03/05

2.0 16V Petrol 120 04/97 → 09/00

XSARA Break (N2)

1.4 i Petrol 55 10/97 → 08/05

XSARA Coupé (N0)

1.4 i Petrol 55 03/98 → 03/05

2.0 i 16V Petrol 120 02/98 → 03/05

ZX (N2)

2.0 i 16V Petrol 112 07/92 → 10/94

2.0 i 16V Petrol 110 06/94 → 06/97

PEUGEOT
306 (7B, N3, N5)

1.4 SL Petrol 55 05/97 → 05/01

2.0 S16 Petrol 110 06/94 → 05/01

2.0 S16 Petrol 112 06/94 → 05/01

306 2 volumi /Coda spiovente (7A, 7C, N3, N5)

1.4 Petrol 55 05/97 → 05/01

2.0 S16 Petrol 110 06/94 → 05/01

2.0 S16 Petrol 112 05/93 → 05/01

306 Break (7E, N3, N5)

1.4 Petrol 55 03/97 → 04/02

405 II (4B)

2.0 16V Petrol 110 06/94 → 10/95

2.0 MI-16 Petrol 112 08/92 → 10/95

2.0 T 16 X4 Petrol 144 08/92 → 10/95

RANCH MPV / Space wagon (5F)

1.4 Petrol 55 06/96 →

SAC065

H2

**SENSORE POSIZIONE ALBERO A CAM
CAMSHAFT POSITION SENSOR**



TOYOTA

YARIS (SCP1_, NLP1_, NCP1_)

1.0 16V Petrol 48 03/03 → 09/05

1.3 Petrol 64 04/02 → 09/05

YARIS (SCP9_, NSP9_, KSP9_, NCP9_, ZSP9_)

1.3 VVT-i Petrol 64 08/05 →

SAC066

H2

**SENSORE POSIZIONE ALBERO A CAM
CAMSHAFT POSITION SENSOR**

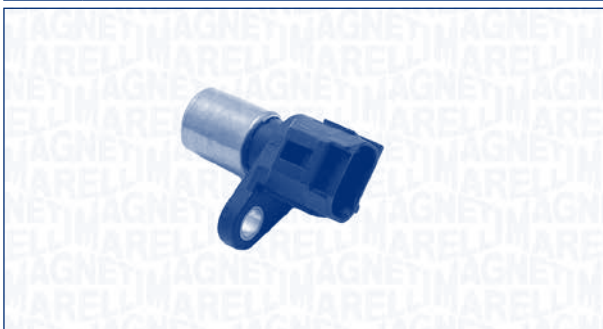

LEXUS

RX (MCU15)

300 AWD Petrol 148 10/00 → 05/03

TOYOTA

AVENSIS (_T22_)

2.0 D-4D (CDT220_) Diesel 81 10/99 → 02/03

AVENSIS (T25_)

2.0 D-4D Diesel 85 04/03 → 11/08

AVENSIS Liftback (_T22_)

2.0 D-4D (CDT220_) Diesel 81 10/99 → 02/03

SAC066



TOYOTA

AVENSIS Station Wagon (_T22_)

2.0 D-4D (CDT220_) Diesel 81 10/99 → 02/03

AVENSIS Station wagon (T25)

2.0 D-4D Diesel 85 04/03 → 11/08

AVENSIS Tre volumi (T25)

2.0 D-4D Diesel 85 04/03 → 11/08

AVENSIS VERSO (_CLM2_, _ACM2_)

2.0 D-4D Diesel 85 08/01 → 08/05

CAMRY (MCV3_, ACV3_, _XV3_)

3.0 V6 Petrol 137 11/01 → 11/06

COROLLA (_E11_)

2.0 D-4D Diesel 66 09/00 → 11/01

COROLLA (ZZE12_, NDE12_, ZDE12_)

2.0 D-4D Diesel 66 01/02 → 12/06

2.0 D-4D Diesel 81 01/02 → 12/06

2.0 D-4D Diesel 85 05/03 → 02/07

COROLLA Compact (_E11_)

2.0 D-4D Diesel 66 09/00 → 01/02

COROLLA Liftback (_E11_)

2.0 D-4D Diesel 66 09/00 → 01/02

COROLLA Station wagon (_E12J_, _E12T_)

2.0 D-4D Diesel 66 01/02 → 02/07

2.0 D-4D Diesel 85 04/04 → 02/07

COROLLA Tre volumi (_E12J_, _E12T_)

2.0 D-4D Diesel 66 08/02 → 07/07

COROLLA Verso (ZDE12_, CDE12_)

2.0 D-4D Diesel 66 01/02 → 05/04

COROLLA Verso (ZER_, ZZE12_, R1_)

2.0 D-4D Diesel 85 04/04 → 03/09

COROLLA Wagon (_E11_)

2.0 D-4D Diesel 66 09/00 → 10/01

PREVIA (MCR3_, ACR3_, CLR3_)

2.0 D-4D Diesel 85 03/01 → 01/06

RAV 4 II (CLA2_, XA2_, ZCA2_, ACA2_)

2.0 D-4D 4WD Diesel 85 09/01 → 11/05

SAC067
H2 **SENSORE POSIZIONE ALBERO A CAM**
CAMSHAFT POSITION SENSOR

KW

SEAT
LEON (1M1)

1.6 Petrol 75 10/05 → 06/06

SAC068
H2 **SENSORE POSIZIONE ALBERO A CAM**
CAMSHAFT POSITION SENSOR

KW

ALFA ROMEO
147 (937)

1.9 JTD 16V Diesel 100 10/04 → 03/10

1.9 JTD 16V Diesel 103 11/02 → 03/10

1.9 JTD 16V Diesel 93 09/03 → 09/04

1.9 JTDM 16V Diesel 110 09/04 → 03/10

156 (932)

1.9 JTD 16V Diesel 103 11/02 → 09/05

2.4 JTD Diesel 129 10/03 → 09/05

156 Sportwagon (932)

1.9 JTD 16V Diesel 103 11/02 → 05/06

1.9 JTD 16V Q4 Diesel 110 07/04 → 05/06

2.4 JTD Diesel 129 10/03 → 05/06

159 (939)

1.9 JTDM 16V Diesel 110 09/05 → 11/11

2.4 JTDM Diesel 147 09/05 → 11/11

SAC068

KW

ALFA ROMEO
159 Sportwagon (939)

1.9 JTDM 16V Diesel 110 03/06 → 11/11

2.4 JTDM Diesel 147 03/06 → 11/11

GT (937)

1.9 JTD Diesel 110 11/03 → 09/10

FIAT
CROMA (194)

1.9 D Multijet Diesel 110 06/05 →

2.4 D Multijet Diesel 147 06/05 →

STILO (192)

1.9 D Multijet Diesel 110 09/05 → 11/06

1.9 JTD Diesel 103 01/04 → 11/06

STILO Multi Wagon (192)

1.9 JTD Diesel 103 01/04 → 08/08

LANCIA
THEESIS (841AX)

2.4 JTD Diesel 129 05/03 → 07/09

OPEL
ASTRA H (L48)

1.9 CDTI Diesel 110 09/04 →

1.9 CDTI 16V Diesel 88 04/04 →

ASTRA H GTC (L08)

1.9 CDTI Diesel 110 03/05 →

1.9 CDTI 16V Diesel 88 03/05 →

ASTRA H Station wagon (L35)

1.9 CDTI Diesel 110 09/04 →

1.9 CDTI 16V Diesel 88 08/04 →

ASTRA H TwinTop (L67)

1.9 CDTI Diesel 110 09/05 →

SIGNUM

1.9 CDTI Diesel 110 04/04 →

VECTRA C

1.9 CDTI Diesel 110 04/04 →

VECTRA C GTS

1.9 CDTI Diesel 110 04/04 →

VECTRA C Station wagon

1.9 CDTI Diesel 110 04/04 →

ZAFIRA B (A05)

1.9 CDTI Diesel 110 07/05 →

SAAB
9-3 (YS3F)

1.9 TiD Diesel 110 09/04 →

9-3 Cabriolet (YS3F)

1.9 TiD Diesel 110 01/06 →

SAC068



SAAB

9-3 Station wagon

1.9 T1D Diesel 110 03/05 →

9-5 (YS3E)

1.9 T1D Diesel 110 01/06 →

9-5 Station wagon (YS3E)

1.9 T1D Diesel 110 01/06 →

VAUXHALL

ASTRA Mk V (H) 2 volumi /Coda spiovente

1.9 CDTI Diesel 110 01/04 → 05/09

1.9 CDTI 16V Diesel 88 01/04 → 05/09

ASTRA Mk V (H) Sport Hatch

1.9 CDTI Diesel 110 02/05 → 11/10

1.9 CDTI Diesel 88 02/05 → 11/10

ASTRA Mk V (H) Station wagon

1.9 CDTI Diesel 110 08/04 → 03/09

1.9 CDTI Diesel 88 08/04 → 03/09

SIGNUM

1.9 CDTI 16V Diesel 110 04/04 → 03/08

VECTRA Mk II (C)

1.9 CDTI 16V Diesel 110 04/04 → 08/08

VECTRA Mk II (C) GTS

1.9 CDTI 16V Diesel 110 04/04 → 07/08

VECTRA Mk II (C) Station wagon

1.9 CDTI 16V Diesel 110 04/04 → 07/08

ZAFIRA Mk II (B) (M75)

1.9 CDTI Diesel 110 07/05 →

SAC069

H2 **SENSORE POSIZIONE ALBERO A CAM**
CAMSHAFT POSITION SENSOR



HONDA

CIVIC I Tre volumi (SF)

1300 L Petrol 33 09/80 → 09/83

SAC069



HONDA

CIVIC VII Hatchback (EU, EP, EV)

2.0 Type-R Petrol 147 09/01 → 09/05

CIVIC VII Tre volumi (ES)

1.3 IMA Petrol 61 01/04 → 09/05

CR-V II (RD_)

2.0 Petrol 110 07/02 → 09/06

FR-V (BE)

2.0 Petrol 110 02/05 →

JAZZ II (GD)

1.4 Petrol 61 03/02 → 07/08

STREAM (RN)

2.0 16V Petrol 115 05/01 →

SAC070

H2 **SENSORE POSIZIONE ALBERO A CAM**
CAMSHAFT POSITION SENSOR

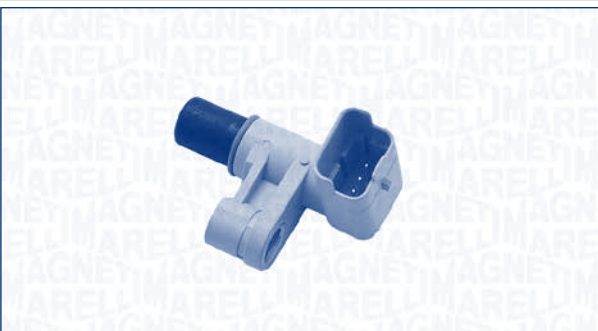

CITROËN

C4 Coupé (LA_)

2.0 16V Petrol 100 11/04 →

2.0 16V Petrol 130 11/04 →

C4 I (LC_)

2.0 16V Petrol 100 11/04 →

2.0 16V Petrol 103 11/04 →

2.0 16V Petrol 130 11/04 →

C5 I (DC_)

1.8 16V (DC6FZB, DC6FZE) Petrol 85 03/01 → 08/04

2.0 16V (DCRFNC, DCRFNF) Petrol 100 03/01 → 08/04

C5 I Break (DE_)

1.8 16V (DE6FZB, DE6FZE) Petrol 85 06/01 → 08/04

SAC070

CITROËN
C5 I Break (DE_)

2.0 16V (DERFNF, DERFNC, RERFNC)	Petrol	100	06/01 → 08/04
---	--------	-----	---------------

C5 II (RC_)

1.8 16V	Petrol	92	09/05 →
---------	--------	----	---------

1.8 16V (RC6FZB)	Petrol	85	09/04 →
------------------	--------	----	---------

2.0 16V (RCRFJB, RCRFJC)	Petrol	103	09/04 →
-----------------------------	--------	-----	---------

C5 II Break (RE_)

1.8 16V	Petrol	92	09/05 →
---------	--------	----	---------

1.8 16V (REGFZB)	Petrol	85	09/04 →
------------------	--------	----	---------

2.0 16V (RERFJB, RERFJC)	Petrol	103	09/04 →
-----------------------------	--------	-----	---------

C8 (EA_, EB_)

2.0	Petrol	100	07/02 →
-----	--------	-----	---------

2.0 16V	Petrol	103	09/05 →
---------	--------	-----	---------

2.2	Petrol	116	07/02 →
-----	--------	-----	---------

EVASION (22, U6)

2.0 16V	Petrol	100	05/00 → 07/02
---------	--------	-----	---------------

JUMPER Autobus (230P)

2.0	Petrol	80	02/94 → 04/02
-----	--------	----	---------------

JUMPER Autobus (244, Z_)

2.0	Petrol	81	04/02 →
-----	--------	----	---------

2.0 bivalent	Petrol/ CNG	81	02/03 →
--------------	----------------	----	---------

JUMPER Furgonato (230L)

2.0	Petrol	80	03/94 → 04/02
-----	--------	----	---------------

JUMPER Furgonato (244)

2.0	Petrol	81	04/02 →
-----	--------	----	---------

2.0 bivalent	Petrol/ CNG	81	02/03 →
--------------	----------------	----	---------

JUMPER Pianale piatto/Telaio (230)

2.0	Petrol	80	03/94 → 04/02
-----	--------	----	---------------

JUMPY (U6U)

2.0	Petrol	100	04/00 → 12/06
-----	--------	-----	---------------

2.0 i 16V	Petrol	102	03/00 →
-----------	--------	-----	---------

JUMPY Furgonato (BS_, BT_, BY_, BZ_)

2.0 i 16V	Petrol	102	03/00 →
-----------	--------	-----	---------

XSARA (N1)

1.8 VTS	Petrol	85	09/00 → 10/04
---------	--------	----	---------------

2.0 16V	Petrol	100	09/00 → 03/05
---------	--------	-----	---------------

XSARA Break (N2)

2.0 16V	Petrol	100	09/00 → 08/05
---------	--------	-----	---------------

SAC070

CITROËN
XSARA Coupé (N0)

2.0 16V	Petrol	100	09/00 → 03/05
---------	--------	-----	---------------

XSARA PICASSO (N68)

1.8 16V	Petrol	85	02/00 →
---------	--------	----	---------

2.0 16V	Petrol	100	01/03 →
---------	--------	-----	---------

FIAT
DUCATO Autobus (230)

2.0 4x4	Petrol	80	11/94 → 11/01
---------	--------	----	---------------

2.0 Panorama/ Combinato	Petrol	80	03/94 → 04/02
----------------------------	--------	----	---------------

DUCATO Autobus (244, Z_)

2.0	Petrol	81	04/02 →
-----	--------	----	---------

2.0 Bipower	Petrol/ CNG	81	11/02 →
-------------	----------------	----	---------

DUCATO Furgonato (230L)

2.0	Petrol	80	03/94 → 04/02
-----	--------	----	---------------

DUCATO Furgonato (244)

2.0	Petrol	81	04/02 →
-----	--------	----	---------

DUCATO Furgonato (244)

2.0 Bipower	Petrol/ CNG	81	11/02 →
-------------	----------------	----	---------

DUCATO Pianale piatto/Telaio (230)

2.0	Petrol	80	06/98 → 04/02
-----	--------	----	---------------

SCUDO Combinato (220P)

2.0 16V	Petrol	100	09/02 → 12/06
---------	--------	-----	---------------

SCUDO Furgonato (220L)

2.0	Petrol	100	05/00 → 12/06
-----	--------	-----	---------------

ULYSSE (179AX)

2.0	Petrol	100	08/02 → 06/11
-----	--------	-----	---------------

LANCIA
PHEDRA (179)

2.0 (179AXA11)	Petrol	100	09/02 → 11/10
----------------	--------	-----	---------------

PEUGEOT
206 2 volumi /Coda spiovente (2A/C)

2.0 RC	Petrol	130	07/03 →
--------	--------	-----	---------

2.0 S16	Petrol	100	06/99 →
---------	--------	-----	---------

206 CC (2D)

2.0 S16	Petrol	100	09/00 →
---------	--------	-----	---------

206 SW (2E/K)

2.0 16V	Petrol	100	07/02 →
---------	--------	-----	---------

307 (3A/C)

2.0 16V	Petrol	100	08/00 →
---------	--------	-----	---------

2.0 16V	Petrol	103	03/05 →
---------	--------	-----	---------

2.0 16V	Petrol	130	06/05 →
---------	--------	-----	---------

SAC070



KW



PEUGEOT

307 Break (3E)

2.0	Petrol	100	03/02 →
2.0 16V	Petrol	103	03/05 →
2.0 16V	Petrol	130	06/05 →

307 CC (3B)

2.0 16V	Petrol	103	03/05 →
2.0 16V	Petrol	130	10/03 →
2.0 16V	Petrol	100	10/03 →

307 SW (3H)

2.0 16V	Petrol	100	03/02 →
2.0 16V	Petrol	103	03/05 →

406 (8B)

1.8 16V	Petrol	85	10/00 → 05/04
2.0 16V	Petrol	100	08/00 → 06/04
2.2	Petrol	116	07/00 → 05/04

406 Break (8E/F)

1.8 16V	Petrol	85	10/00 → 10/04
2.0 16V	Petrol	100	10/00 → 10/04
2.2	Petrol	116	07/00 → 10/04

406 Coupé (8C)

2.0 16V	Petrol	100	10/00 → 12/04
2.2	Petrol	116	03/02 → 12/04

407 (6D_)

1.8	Petrol	85	05/04 →
1.8 16V	Petrol	92	09/05 →
2.0	Petrol	100	05/04 →
2.0 16V	Petrol	103	09/05 →
2.2	Petrol	116	05/04 →
2.2 16V	Petrol	120	09/05 →

407 Coupé (6C_)

2.2 16V	Petrol	120	10/05 →
---------	--------	-----	---------

407 SW (6E_)

1.8	Petrol	85	05/04 →
1.8 16V	Petrol	92	09/05 →
2.0	Petrol	100	05/04 →
2.0 16V	Petrol	103	09/05 →
2.2	Petrol	116	05/04 →
2.2 16V	Petrol	120	09/05 →

607 (9D, 9U)

2.0	Petrol	100	02/00 →
2.2 16V	Petrol	120	09/05 →
2.2 16V	Petrol	116	02/00 →

806 (221)

2.0 16V	Petrol	100	09/00 → 08/02
---------	--------	-----	---------------

SAC070



KW



PEUGEOT

807 (E)

2.0	Petrol	100	06/02 →
2.0 16V	Petrol	103	09/05 →
2.2	Petrol	116	06/02 →

BOXER Autobus (230P)

2.0 i	Petrol	80	03/94 → 04/02
-------	--------	----	---------------

BOXER Autobus (244, Z_)

2.0	Petrol	81	04/02 →
-----	--------	----	---------

BOXER Furgonato (230L)

2.0 i	Petrol	80	06/94 → 04/02
-------	--------	----	---------------

BOXER Furgonato (244)

2.0	Petrol	81	04/02 →
-----	--------	----	---------

BOXER Pianale piatto/Telaio (ZCT_)

2.0	Petrol	81	12/01 → 04/02
2.0 i	Petrol	80	06/94 → 04/02

EXPERT (224)

2.0	Petrol	100	07/00 →
-----	--------	-----	---------

EXPERT Furgonato (222)

2.0	Petrol	100	09/02 →
-----	--------	-----	---------

SAC071

H2

SENSORE POSIZIONE ALBERO A CAM
CAMSHAFT POSITION SENSOR

KW



OPEL

ASTRA G 2 volumi /Coda spiovente (F48_, F08_)

1.8 16V	Petrol	92	09/00 → 01/05
1.8 16V	Petrol	85	02/98 → 09/00

ASTRA G Cabriolet (F67)

1.8 16V	Petrol	92	03/01 → 10/05
---------	--------	----	---------------

ASTRA G Coupé (F07_)

1.8 16V	Petrol	92	09/00 → 05/05
1.8 16V	Petrol	85	03/00 → 10/00

SAC071

OPEL
ASTRA G Station wagon (F35_)

1.8 16V	Petrol	92	09/00 → 07/04
1.8 16V	Petrol	85	02/98 → 09/00

ASTRA G Tre volumi (F69_)

1.8 16V	Petrol	92	06/00 → 01/05
1.8 16V	Petrol	85	09/98 → 09/00

ASTRA H (L48)

1.8	Petrol	92	03/04 →
-----	--------	----	---------

ASTRA H GTC (L08)

1.8	Petrol	92	03/05 →
-----	--------	----	---------

ASTRA H Station wagon (L35)

1.8	Petrol	92	08/04 →
-----	--------	----	---------

ASTRA H TwinTop (L67)

1.8	Petrol	92	09/05 →
-----	--------	----	---------

CORSA C (F08, F68)

1.8	Petrol	92	09/00 → 12/09
-----	--------	----	---------------

MERIVA

1.8	Petrol	92	05/03 → 05/10
-----	--------	----	---------------

SIGNUM

1.8	Petrol	90	05/03 →
-----	--------	----	---------

TIGRA TwinTop

1.8	Petrol	92	06/04 →
-----	--------	----	---------

VECTRA B (36_)

1.8 i 16V	Petrol	92	09/00 → 04/02
-----------	--------	----	---------------

VECTRA B 2 volumi /Coda spiovente (38_)

1.8 i 16V	Petrol	92	09/00 → 07/03
-----------	--------	----	---------------

VECTRA B Station wagon (31_)

1.8 i 16V	Petrol	92	09/00 → 07/03
-----------	--------	----	---------------

VECTRA C

1.8	Petrol	81	04/02 →
-----	--------	----	---------

1.8 16V	Petrol	90	04/02 →
---------	--------	----	---------

VECTRA C GTS

1.8 16V	Petrol	90	08/02 →
---------	--------	----	---------

VECTRA C Station wagon

1.8	Petrol	90	10/03 →
-----	--------	----	---------

ZAFIRA A (F75_)

1.8 16V	Petrol	92	09/00 → 06/05
---------	--------	----	---------------

1.8 16V	Petrol	85	04/99 → 09/00
---------	--------	----	---------------

VAUXHALL
ASTRA Mk IV (G) 2 volumi /Coda spiovente

1.8 16V	Petrol	92	09/00 → 05/05
---------	--------	----	---------------

1.8 16V	Petrol	85	02/98 → 09/00
---------	--------	----	---------------

ASTRA Mk IV (G) Cabriolet

1.8 16V	Petrol	92	03/01 → 10/05
---------	--------	----	---------------

SAC071

VAUXHALL
ASTRA Mk IV (G) Coupé (F67)

1.8 16V	Petrol	92	09/00 → 08/05
---------	--------	----	---------------

1.8 16V	Petrol	85	03/00 → 08/05
---------	--------	----	---------------

1.8 16V Dualfuel	Petrol/ LPG	87	09/02 → 08/05
------------------	----------------	----	---------------

ASTRA Mk IV (G) Station wagon

1.8 16V	Petrol	92	09/00 → 05/05
---------	--------	----	---------------

1.8 16V	Petrol	85	02/98 → 08/00
---------	--------	----	---------------

1.8 16V Dualfuel	Petrol/ LPG	87	09/02 → 05/05
------------------	----------------	----	---------------

ASTRA Mk IV (G) Tre volumi

1.8 16V	Petrol	92	02/98 → 07/04
---------	--------	----	---------------

1.8 16V	Petrol	85	02/98 → 07/04
---------	--------	----	---------------

1.8 16V Dualfuel	Petrol/ LPG	87	02/98 → 07/04
------------------	----------------	----	---------------

ASTRA Mk V (H) 2 volumi /Coda spiovente

1.8	Petrol	92	01/04 → 05/09
-----	--------	----	---------------

ASTRA Mk V (H) Station wagon

1.8	Petrol	92	10/04 → 03/09
-----	--------	----	---------------

CORSA Mk II (C) (W5L, F08)

1.8 16V	Petrol	92	08/00 → 09/06
---------	--------	----	---------------

MERIVA Mk I (A)

1.8 i 16V	Petrol	92	05/03 → 08/05
-----------	--------	----	---------------

TIGRA TwinTop

1.8	Petrol	92	06/04 → 08/09
-----	--------	----	---------------

VECTRA (B)

1.8 i 16V	Petrol	92	09/00 → 03/02
-----------	--------	----	---------------

VECTRA (B) 2 volumi /Coda spiovente

1.8 i 16V	Petrol	92	09/00 → 07/03
-----------	--------	----	---------------

VECTRA (B) Station wagon

1.8 i 16V	Petrol	92	09/00 → 03/02
-----------	--------	----	---------------

VECTRA Mk II (C)

1.8 16V	Petrol	90	04/02 → 07/08
---------	--------	----	---------------

VECTRA Mk II (C)

1.8 16V Dualfuel	Petrol/ LPG	90	04/02 → 07/08
------------------	----------------	----	---------------

VECTRA Mk II (C) GTS

1.8 16V	Petrol	90	08/02 → 07/08
---------	--------	----	---------------

1.8 16V Dualfuel	BiFuel	90	08/02 → 07/08
------------------	--------	----	---------------

VECTRA Mk II (C) Station wagon

1.8 16V	Petrol	90	10/03 → 08/05
---------	--------	----	---------------

ZAFIRA Mk I (A) (F75)

1.8 16V	Petrol	85	05/99 → 08/00
---------	--------	----	---------------

1.8 16V	Petrol	92	09/00 → 08/05
---------	--------	----	---------------

SAC072

H2

SENSORE POSIZIONE ALBERO A CAM
CAMSHAFT POSITION SENSOR

KW



CITROËN

C3 II

1.4 VTi 95 Petrol 70 11/09 →

1.6 VTi 120 Petrol 88 11/09 →

C3 Picasso

1.6 VTi 120 Petrol 88 02/09 →

C4 Coupé (LA_)

1.6 THP 150 Petrol 110 07/08 →

C4 Grand Picasso I (UA_)

1.6 16V Petrol 110 10/08 →

1.6 16V Petrol 103 07/08 → 11/09

C4 I (LC_)

1.6 THP 140 Petrol 103 07/08 → 07/09

1.6 THP 150 Petrol 110 07/08 →

C4 Picasso I (UD_)

1.6 16V Petrol 110 07/08 →

1.6 THP 140 Petrol 103 07/08 → 11/09

C5 III (RD_)

1.6 THP 155 Petrol 115 09/09 →

C5 III Break (TD_)

1.6 THP 155 Petrol 115 09/09 →

DS3

1.4 VTi 95 Petrol 70 04/10 →

1.6 THP 155 Petrol 115 04/10 →

1.6 VTi 120 Petrol 88 04/10 →

MINI

MINI (R56)

Cooper Petrol 88 10/06 → 08/10

Cooper Petrol 90 03/10 →

Cooper S Petrol 128 10/06 → 07/10

Cooper S Petrol 135 03/10 →

John Cooper Works Petrol 155 07/08 →

One Petrol 55 03/09 → 02/10

One Petrol 70 03/07 → 02/10

SAC072



KW



MINI

MINI (R56)

One Petrol 72 03/10 →

MINI Cabriolet (R57)

Cooper Petrol 88 03/09 → 06/10

Cooper Petrol 90 03/10 →

Cooper S Petrol 128 03/09 → 07/10

John Cooper Works Petrol 155 03/09 →

MINI CLUBMAN (R55)

Cooper Petrol 88 10/07 → 07/10

Cooper Petrol 90 03/10 →

Cooper S Petrol 128 10/07 → 07/10

Cooper S Petrol 135 03/10 →

MINI CLUBMAN (R55)

John Cooper Works Petrol 155 07/08 →

One Petrol 72 03/10 →

PEUGEOT

207 (WA_, WC_)

1.6 16V RC Petrol 128 04/07 →

1.6 16V Turbo Petrol 110 07/06 →

1.6 16V VTi Petrol 88 02/07 → 06/09

207 CC (WD_)

1.6 16V Turbo Petrol 110 02/07 →

3008

1.6 THP Petrol 110 06/09 →

1.6 THP Petrol 115 06/09 →

1.6 VTi Petrol 88 06/09 →

308 (4A_, 4C_)

1.6 16V Petrol 110 09/07 →

1.6 16V Petrol 128 03/08 →

1.6 16V Petrol 103 11/07 →

308 CC

1.6 16V Petrol 103 06/09 →

1.6 16V Petrol 110 06/09 →

1.6 16V Petrol 88 06/09 →

1.6 16V Petrol 115 09/09 →

308 SW

1.4 16V Petrol 72 12/09 →

1.4 16V Petrol 70 05/08 →

1.6 16V Petrol 103 05/08 →

1.6 16V Petrol 110 05/08 →

1.6 16V Petrol 128 05/08 →

1.6 16V Petrol 88 05/08 →

SAC072

PEUGEOT
5008

1.6 16V	Petrol	115	09/09 →
1.6 16V	Petrol	88	09/09 →

RANCH Furgonato

1.6	Petrol	72	11/10 →
-----	--------	----	---------

RCZ

1.6 16V	Petrol	115	03/10 →
1.6 16V	Petrol	147	06/10 →

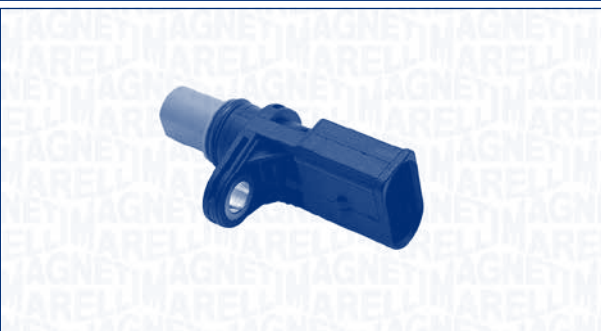
SAC073
H2 **SENSORE POSIZIONE ALBERO A CAM**
CAMSHAFT POSITION SENSOR

AUDI
A3 (8P1)

1.9 TDI	Diesel	77	05/03 → 05/10
2.0 FSI	Petrol	110	05/03 → 06/08
2.0 TDi	Diesel	100	05/03 → 08/12
2.0 TDI 16V	Diesel	103	05/03 → 08/12
2.0 TDI 16V quattro	Diesel	103	08/04 → 08/12
2.0 TFSI	Petrol	147	09/04 → 08/12

A4 (8E2, B6)

2.0 FSI	Petrol	110	07/02 → 12/04
3.0	Petrol	160	04/01 → 12/04
3.0	Petrol	162	11/00 → 12/04
3.0 quattro	Petrol	160	04/01 → 12/04
3.0 quattro	Petrol	162	11/00 → 12/04
S4 quattro	Petrol	253	03/03 → 12/04

A4 (8EC, B7)

2.0 TFSI	Petrol	147	11/04 → 06/08
2.0 TFSI	Petrol	162	06/05 → 06/08
2.0 TFSI quattro	Petrol	147	11/04 → 06/08
2.0 TFSI quattro	Petrol	162	06/05 → 06/08

SAC073

AUDI
A4 Avant (8E5, B6)

2.0 FSI	Petrol	110	07/02 → 12/04
3.0	Petrol	160	04/01 → 12/04
3.0	Petrol	162	09/01 → 12/04
3.0 quattro	Petrol	160	04/01 → 12/04
3.0 quattro	Petrol	162	09/01 → 12/04

A4 Avant (8ED, B7)

2.0 TFSI	Petrol	147	11/04 → 06/08
2.0 TFSI quattro	Petrol	147	11/04 → 06/08

A4 Cabriolet (8H7, B6, 8HE, B7)

3.0	Petrol	162	04/02 → 12/05
3.0 quattro	Petrol	162	05/03 → 12/05
S4 quattro	Petrol	253	03/04 → 03/09

A6 (4B2, C5)

3.0	Petrol	162	08/01 → 01/05
3.0 quattro	Petrol	162	08/01 → 01/05

A6 (4F2, C6)

2.0 TFSI	Petrol	125	06/05 → 03/11
4.2 quattro	Petrol	246	05/04 → 05/06

A6 Avant (4B5, C5)

3.0	Petrol	162	08/01 → 01/05
3.0 quattro	Petrol	162	08/01 → 01/05

A6 Avant (4F5, C6)

2.0 TFSI	Petrol	125	06/05 → 08/11
4.2 quattro	Petrol	246	03/05 → 05/06

A8 (4E_)

3.0	Petrol	160	07/03 → 05/06
3.0	Petrol	162	07/03 → 05/05

ALLROAD (4BH, C5)

4.2 V8 quattro	Petrol	220	07/02 → 08/05
----------------	--------	-----	---------------

SEAT
ALTEA (5P1)

2.0 FSI	Petrol	110	05/04 → 03/09
---------	--------	-----	---------------

TOLEDO III (5P2)

2.0 FSI	Petrol	110	10/04 → 05/09
---------	--------	-----	---------------

SKODA
OCTAVIA (1Z3)

1.9 TDI	Diesel	77	06/04 → 12/10
2.0 FSI	Petrol	110	11/04 →
2.0 TDI 16V	Diesel	103	02/04 →

OCTAVIA Combi (1Z5)

1.9 TDI	Diesel	77	09/04 → 12/10
1.9 Tdi 4x4	Diesel	77	11/04 → 12/10
2.0 FSI	Petrol	110	11/04 →
2.0 FSI 4x4	Petrol	110	11/04 →

SAC073



SKODA

OCTAVIA Combi (1Z5)

2.0 TDI 16V Diesel 103 02/04 →

VOLKSWAGEN

GOLF PLUS (5M1, 521)

2.0 FSI Petrol 110 05/05 → 06/08

GOLF V (1K1)

2.0 FSI Petrol 110 01/04 → 11/08

2.0 GTI Petrol 147 10/04 → 02/09

JETTA III (1K2)

2.0 FSI Petrol 110 08/05 → 10/10

2.0 TFSI Petrol 147 10/05 → 10/10

PASSAT (3C2)

2.0 FSI Petrol 110 03/05 → 07/10

PASSAT Variant (3C5)

2.0 FSI Petrol 110 08/05 → 11/10

TOURAN (1T1, 1T2)

2.0 FSI Petrol 110 10/03 → 11/05

SAC074

H2 **SENSORE POSIZIONE ALBERO A CAM**
CAMSHAFT POSITION SENSOR



FORD

C-MAX (DM2)

1.8 TDCi Diesel 85 02/07 → ENGINE: KKDA

FIESTA IV (JA_, JB_)

1.8 Di Diesel 55 04/00 → 01/02 ENGINE: RTN,RTP,RTQ

FOCUS (DAW, DBW)

1.8 DI / TDDi Diesel 55 08/99 → 11/04 ENGINE: BHDA,BHDB

1.8 TDCi Diesel 74 08/02 → 11/04 ENGINE: FFDA

1.8 TDCi Diesel 85 03/01 → 11/04 ENGINE: F9DA,F9DB

1.8 Turbo DI / TDDi Diesel 66 10/98 → 11/04 ENGINE: C9DA,C9DB

FOCUS II (DA_)

1.8 TDCi Diesel 85 01/05 → ENGINE: KKDA, KKDB

SAC074



FORD

FOCUS II Tre volumi (DA_)

1.8 TDCi Diesel 85 04/05 → ENGINE: KKDA, KKDB

FOCUS Station wagon (DNW)

1.8 TDCi Diesel 74 08/02 → 11/04 ENGINE: FFDA

1.8 TDCi Diesel 85 03/01 → 11/04 ENGINE: F9DA,F9DB

FOCUS Tre volumi (DFW)

1.8 TDCi Diesel 74 08/02 → 11/04 ENGINE: FFDA

1.8 TDCi Diesel 85 03/01 → 11/04 ENGINE: F9DA,F9DB

GALAXY (WA6)

1.8 TDCi Diesel 74 05/06 → ENGINE: FFWA

1.8 TDCi Diesel 92 05/06 → ENGINE: QYWA

MONDEO IV (BA7)

1.8 TDCi Diesel 74 03/07 → ENGINE: FFBA

MONDEO IV Tre volumi (BA7)

1.8 TDCi Diesel 74 03/07 → ENGINE: FFBA

MONDEO IV Turnier (BA7)

1.8 TDCi Diesel 74 03/07 → ENGINE: FFBA

S-MAX (WA6)

1.8 TDCi Diesel 92 05/06 → ENGINE: QYWA

TRANSIT CONNECT (P65_, P70_, P80_)

1.8 Di Diesel 55 06/02 → ENGINE: P7PA, P7PB, R2PA, BHPA

1.8 TDCi Diesel 66 06/02 → ENGINE: HCPA, HCPB, RWPE, RWPF, P9PA, P9PB, P9PC, P9PD, R3PA

1.8 TDCi Diesel 81 08/06 → ENGINE: RWPA, RWPC, RWPD

SAC075

H2 **SENSORE POSIZIONE ALBERO A CAM**
CAMSHAFT POSITION SENSOR



AUDI

A3 (8P1)

1.6 Petrol 75 05/03 → 08/12

SAC075

KW

AUDI
A3 Sportback (8PA)

1.6 Petrol 75 09/04 → 03/13

A4 (8E2, B6)

1.6 Petrol 75 11/00 → 12/04

A4 (8EC, B7)

1.6 Petrol 75 11/04 → 06/08

A4 Avant (8E5, B6)

1.6 Petrol 75 09/01 → 12/04

A4 Avant (8ED, B7)

1.6 Petrol 75 11/04 → 06/08

SEAT
ALTEA (5P1)

1.6 Petrol 75 03/04 →

TOLEDO III (5P2)

1.6 Petrol 75 10/04 → 05/09

SKODA
OCTAVIA (1Z3)

1.6 Petrol 75 06/04 →

OCTAVIA Combi (1Z5)

1.6 Petrol 75 09/04 →

VOLKSWAGEN
CADDY III Furgonato (2KA, 2KH, 2CA, 2CH)

1.6 Petrol 75 04/04 →

CADDY III Station wagon (2KB, 2KJ, 2CB, 2CJ)

1.6 Petrol 75 04/04 →

GOLF PLUS (5M1, 521)

1.6 Petrol 75 05/05 →

GOLF V (1K1)

1.6 Petrol 75 01/04 → 11/08

JETTA III (1K2)

1.6 Petrol 75 10/05 → 10/10

NEW BEETLE (9C1, 1C1)

1.6 Petrol 75 06/00 → 09/10

NEW BEETLE Cabriolet (1Y7)

1.6 Petrol 75 01/03 → 09/10

PASSAT (3C2)

1.6 Petrol 75 05/05 → 07/10

PASSAT Variant (3C5)

1.6 Petrol 75 08/05 → 11/10

TOURAN (1T1, 1T2)

1.6 Petrol 75 07/03 → 05/10

SAC076
H2
**SENSORE POSIZIONE ALBERO A CAM
CAMSHAFT POSITION SENSOR**

KW

BMW
3 (E46)

320 i Petrol 110 03/98 → 09/00

320 i Petrol 125 09/00 → 02/05

323 i Petrol 125 03/98 → 09/00

325 i Petrol 141 09/00 → 02/05

325 xi Petrol 141 09/00 → 02/05

328 i Petrol 142 02/98 → 06/00

330 i Petrol 170 06/00 → 02/05

330 xi Petrol 170 06/00 → 02/05

3 Cabriolet (E46)

320 Ci Petrol 125 09/00 →

323 Ci Petrol 125 04/00 → 09/00

330 Ci Petrol 170 06/00 →

3 Compact (E46)

325 ti Petrol 141 06/01 → 02/05

3 Coupé (E46)

320 Ci Petrol 110 08/99 → 09/00

320 Ci Petrol 125 09/00 →

323 Ci Petrol 125 04/99 → 09/00

325 Ci Petrol 141 09/00 →

328 Ci Petrol 142 04/99 → 06/00

330 xi Petrol 170 06/00 →

3 Touring (E46)

320 i Petrol 110 10/99 → 09/00

320 i Petrol 125 09/00 → 02/05

325 i Petrol 141 09/00 → 02/05

325 xi Petrol 141 09/00 → 02/05

328 i Petrol 142 10/99 → 06/00

330 i Petrol 170 06/00 → 02/05

330 xi Petrol 170 06/00 → 02/05

5 (E39)

520 i Petrol 125 09/00 → 06/03

520 i Petrol 110 01/96 → 09/00

523 i Petrol 125 11/95 → 09/00

SAC076



BMW

5 (E39)

525 i	Petrol	141	09/00 → 06/03
528 i	Petrol	142	11/95 → 09/00
530 i	Petrol	170	09/00 → 06/03

5 (E60)

520 i	Petrol	125	07/03 → 03/10
525 i	Petrol	141	09/03 → 03/10
530 i	Petrol	170	07/03 → 03/10

5 Touring (E39)

520 i	Petrol	125	09/00 → 05/04
525 i	Petrol	141	09/00 → 05/04
528 i	Petrol	142	01/97 → 09/00
530 i	Petrol	170	09/00 → 05/04

5 Touring (E61)

525 i	Petrol	141	06/04 →
-------	--------	-----	---------

7 (E65, E66, E67)

730 i, Li	Petrol	170	03/03 →
-----------	--------	-----	---------

X3 (E83)

2.5 i	Petrol	141	01/04 →
3.0 i xDrive	Petrol	170	01/04 →

X5 (E53)

3.0 i	Petrol	170	05/00 →
-------	--------	-----	---------

Z3 (E36)

2.0	Petrol	110	04/99 → 01/03
2.2	Petrol	125	08/00 → 01/03
3.0	Petrol	170	06/00 → 01/03

Z3 Coupé (E36)

2.8	Petrol	141	07/97 → 06/00
3.0	Petrol	170	06/00 → 06/03

Z4 (E85)

2.2 i	Petrol	125	10/03 →
2.5 i	Petrol	141	02/03 →
3.0 i	Petrol	170	02/03 →

SAC077

H2

**SENSORE POSIZIONE ALBERO A CAM
CAMSHAFT POSITION SENSOR**



NISSAN

PRIMASTAR Autobus (X83)

dCi 120	Diesel	84	09/06 →
dCi 90	Diesel	66	09/06 →

PRIMASTAR Furgonato (X83)

dCi 120	Diesel	84	09/06 →
dCi 90	Diesel	66	09/06 →

QASHQAI / QASHQAI +2 (J10, JJ10)

2.0 dCi	Diesel	110	02/07 →
2.0 dCi Trazione integrale	Diesel	110	02/07 →

X-TRAIL (T31)

2.0 dCi	Diesel	110	06/07 →
2.0 dCi	Diesel	127	06/07 →

OPEL

VIVARO Combi (J7)

2.0 CDTi	Diesel	66	08/06 →
2.0 CDTi	Diesel	84	08/06 →

VIVARO Furgonato (F7)

2.0 CDTi	Diesel	66	08/06 →
2.0 CDTi	Diesel	84	08/06 →

VIVARO Pianale piatto/Telaio (E7)

2.0 CDTi	Diesel	66	01/06 →
2.0 CDTi	Diesel	84	08/06 →

RENAULT

ESPACE IV (JK0/1_)

2.0 dCi (JK01, JK02, JK1J, JK1K)	Diesel	110	01/06 →
2.0 dCi (JK03, JK04)	Diesel	127	01/06 →

GRAND SCÉNIC II (JM0/1_)

2.0 dCi (JM1K)	Diesel	110	09/05 →
----------------	--------	-----	---------

GRAND SCÉNIC III (JZ0/1_)

2.0 dCi (JZ0L)	Diesel	118	04/09 →
2.0 dCi (JZ0Y)	Diesel	110	02/09 →

SAC077

KW

RENAULT
KOLEOS (HY_)

2.0 dCi (HY0K) Diesel 110 09/08 →

2.0 dCi 4x4 (HY0B) Diesel 127 09/08 →

2.0 dCi 4x4 (HY0K) Diesel 110 09/08 →

LAGUNA Coupé (DT0/1)

2.0 dCi Diesel 127 09/08 →

2.0 dCi (DT01, DT09, DT12, DT1D) Diesel 110 09/08 →

LAGUNA II (BG0/1_)

2.0 dCi (BG14, BG1S) Diesel 127 01/06 →

2.0 dCi (BG1T) Diesel 110 08/05 →

LAGUNA II Grandtour (KG0/1_)

2.0 dCi (KG1S) Diesel 127 01/06 →

2.0 dCi (KG1T) Diesel 110 08/05 →

LAGUNA III (BT0/1)

2.0 dCi (BT01, BT09, BT12, BT1S) Diesel 110 10/07 →

2.0 dCi (BT08, BT0K, BT0J, BT14, BT1A, BT1D) Diesel 96 10/07 →

2.0 dCi (BT0M, BT0N, BT19) Diesel 127 01/08 →

2.0 dCi GT (BT1E, BT1N) Diesel 131 03/08 →

LAGUNA III Sportour (KT0/1)

2.0 dCi (KT01, KT08, KT0K, KT0J, KT1A, KT1D) Diesel 96 10/07 →

2.0 dCi (KT01, KT09, KT12, KT1S) Diesel 110 10/07 →

2.0 dCi (KT0M, KT0N, KT19) Diesel 127 01/08 →

2.0 dCi GT (KT11, KT1E, KT1N) Diesel 131 03/08 →

SAC077

KW

RENAULT
MEGANE II (BM0/1_, CM0/1_)

2.0 dCi Diesel 127 01/07 →

2.0 dCi (BM1K, CM1K) Diesel 110 09/05 →

MEGANE II Coupé-Cabriolet (EM0/1_)

2.0 dCi Diesel 110 09/05 →

MEGANE II Station wagon (KM0/1_)

2.0 dCi Diesel 110 09/05 →

MEGANE III 2 volumi /Coda spiovente (BZ0_)

1.9 dCi (BZ0N, BZ0J) Diesel 96 11/08 →

MEGANE III Coupé (DZ0/1_)

1.9 dCi (DZ0N, DZ0J, DZ1J, DZ1K) Diesel 96 11/08 →

2.0 dCi (DZ0L) Diesel 118 04/09 →

2.0 dCi (DZ0Y) Diesel 110 04/09 →

MEGANE III Grandtour (KZ0/1)

1.9 dCi (KZ0J, KZ0N, KZ1S) Diesel 96 05/09 →

2.0 dCi (KZ0L) Diesel 118 04/09 →

SCÉNIC II (JM0/1_)

2.0 dCi (JM1K) Diesel 110 09/05 →

SCÉNIC III (JZ0/1_)

1.9 dCi Diesel 96 02/09 →

2.0 dCi (JZ0L) Diesel 118 04/09 →

2.0 dCi (JZ0Y) Diesel 110 02/09 →

TRAFIC II Autobus (JL)

2.0 dCi 115 (JL0H) Diesel 84 08/06 →

2.0 dCi 90 (JL0H) Diesel 66 08/06 →

TRAFIC II Furgonato (FL)

2.0 dCi 115 (FL01, FL0U) Diesel 84 08/06 →

2.0 dCi 90 (FL0H) Diesel 66 08/06 →

TRAFIC II Pianale piatto/Telaio (EL)

2.0 dCi 115 (EL0H) Diesel 84 08/06 →

2.0 dCi 90 (EL0H) Diesel 66 08/06 →

VEL SATIS (BJ0_)

2.0 dCi (BJ03, BJ0B) Diesel 127 01/06 →

SAC078

H2 **SENSORE POSIZIONE ALBERO A CAM**
CAMSHAFT POSITION SENSOR



TOYOTA

AURIS (NRE15_, ZZE15_, ADE15_, ZRE15_, NDE15_)

1.4 D-4D	Diesel	66	03/07 →
2.0 D-4D	Diesel	93	03/07 →
2.2 D	Diesel	130	03/07 →

AVENSIS (T25_)

2.0 D-4D	Diesel	93	03/06 → 11/08
2.2 D-4D	Diesel	110	10/05 → 11/08
2.2 D-CAT	Diesel	130	07/05 → 11/08

AVENSIS Station wagon (T25)

2.0 D-4D	Diesel	93	03/06 → 11/08
2.2 D-4D	Diesel	110	10/05 → 11/08
2.2 D-CAT	Diesel	130	07/05 → 11/08

AVENSIS Station wagon (ZRT27, ADT27)

2.0 D-4D	Diesel	93	02/09 →
2.2 D-4D	Diesel	110	02/09 →
2.2 D-4D	Diesel	130	02/09 →

AVENSIS Tre volumi (T25)

2.0 D-4D	Diesel	93	03/06 → 11/08
2.2 D-4D	Diesel	110	10/05 → 11/08
2.2 D-CAT	Diesel	130	07/05 → 11/08

AVENSIS Tre volumi (ZRT27, ADT27)

2.0 D-4D	Diesel	93	02/09 →
2.2 D-4D	Diesel	110	02/09 →
2.2 D-4D	Diesel	130	02/09 →

COROLLA (ZZE12_, NDE12_, ZDE12_)

1.4 D	Diesel	66	07/04 → 02/07
-------	--------	----	---------------

COROLLA Station wagon (_E12J_, _E12T_)

1.4 D4-D	Diesel	66	07/04 → 02/07
----------	--------	----	---------------

COROLLA Tre volumi (_E12J_, _E12T_)

1.4 D-4D	Diesel	66	07/04 → 07/07
----------	--------	----	---------------

COROLLA Verso (ZER_, ZZE12_, R1_)

2.2 D-4D	Diesel	100	10/05 → 03/09
2.2 D-4D	Diesel	130	10/05 → 03/09

SAC078



TOYOTA

IQ (KPJ1_, NGJ1_, KGJ1_, NUJ1_)

1.4 D-4D	Diesel	66	01/09 →
----------	--------	----	---------

LAND CRUISER (VDJ20_, UZJ20_)

4.5 D V8 (VDJ200)	Diesel	210	01/08 →
-------------------	--------	-----	---------

RAV 4 III (ACA3_, ACE_, ALA3_, GSA3_, ZSA3_)

2.2 D-4D 4WD	Diesel	100	03/06 →
2.2 D-CAT 4WD	Diesel	130	03/06 →

URBAN CRUISER (NSP1_, NLP1_, ZSP1_, NCP11_)

1.4 D-4D	Diesel	66	04/09 →
1.4 D-4D 4WD	Diesel	66	04/09 →

YARIS (SCP9_, NSP9_, KSP9_, NCP9_, ZSP9_)

1.4 D-4D	Diesel	66	08/05 →
----------	--------	----	---------

SAC079

H2 **SENSORE POSIZIONE ALBERO A CAM**
CAMSHAFT POSITION SENSOR



ALFA ROMEO

MITO (955)

1.4	Petrol	58	09/08 →
1.4	Petrol	57	03/11 →

FIAT

500 (312)

1.2	Petrol	51	10/07 →
-----	--------	----	---------

DOBLO (119)

1.4	Petrol	57	10/05 →
-----	--------	----	---------

DOBLO Cargo (223)

1.4	Petrol	57	10/05 →
-----	--------	----	---------

IDEA

1.4 16V	Petrol	70	01/04 →
---------	--------	----	---------

PUNTO / GRANDE PUNTO (199)

1.2	Petrol	48	10/05 →
1.4	Petrol	57	10/05 →

SAC079

FORD
KA (RU8)

1.2	Petrol	51	10/08 →
-----	--------	----	---------

SAC080
H2
**SENSORE POSIZIONE ALBERO A CAM
CAMSHAFT POSITION SENSOR**

OPEL
ASTRA G 2 volumi /Coda spiovente (F48_, F08_)

1.4 16V	Petrol	66	02/98 → 01/05
---------	--------	----	---------------

1.6 16V	Petrol	74	02/98 → 01/05
---------	--------	----	---------------

ASTRA G Cabriolet (F67)

1.6 16V	Petrol	74	03/01 → 10/05
---------	--------	----	---------------

ASTRA G Station wagon (F35_)

1.4 16V	Petrol	66	06/98 → 07/04
---------	--------	----	---------------

1.6 16V	Petrol	74	02/98 → 07/04
---------	--------	----	---------------

1.6 CNG	Petrol/ CNG	71	03/03 → 07/04
---------	----------------	----	---------------

ASTRA G Tre volumi (F69_)

1.4 16V	Petrol	66	09/98 → 01/05
---------	--------	----	---------------

1.6 16V	Petrol	74	09/98 → 01/05
---------	--------	----	---------------

COMBO Cassone / Furgonato / Promiscuo

1.6 CNG 16V	Petrol/ CNG	71	04/05 →
-------------	----------------	----	---------

COMBO Tour

1.6 CNG	Petrol/ CNG	71	04/05 →
---------	----------------	----	---------

CORSA C (F08, F68)

1.4	Petrol	66	09/00 → 12/09
-----	--------	----	---------------

MERIVA

1.6 16V	Petrol	74	05/03 → 01/06
---------	--------	----	---------------

VECTRA B (36_)

1.6 i 16V	Petrol	74	10/95 → 04/02
-----------	--------	----	---------------

SAC080

OPEL
VECTRA B 2 volumi /Coda spiovente (38_)

1.6 i 16V	Petrol	74	10/95 → 07/02
-----------	--------	----	---------------

VECTRA C

1.6 16V	Petrol	74	06/04 →
---------	--------	----	---------

VECTRA C GTS

1.6	Petrol	74	08/05 →
-----	--------	----	---------

VECTRA C Station wagon

1.6 16V	Petrol	74	06/04 →
---------	--------	----	---------

ZAFIRA A (F75_)

1.6 16V	Petrol	74	04/99 → 06/05
---------	--------	----	---------------

1.6 CNG	Petrol/ CNG	71	09/01 → 06/05
---------	----------------	----	---------------

ZAFIRA B (A05)

1.6 CNG	Petrol/ CNG	69	01/06 →
---------	----------------	----	---------

VAUXHALL
MERIVA Mk I (A)

1.6 i 16V	Petrol	74	01/03 → 09/05
-----------	--------	----	---------------

VECTRA (B)

1.6 i 16V	Petrol	74	08/95 → 10/01
-----------	--------	----	---------------

VECTRA (B) 2 volumi /Coda spiovente

1.6 i 16V	Petrol	74	08/95 → 10/01
-----------	--------	----	---------------

VECTRA (B) Station wagon

1.6 i 16V	Petrol	74	11/96 → 03/02
-----------	--------	----	---------------

VECTRA Mk II (C)

1.6 16V	Petrol	74	06/04 → 07/08
---------	--------	----	---------------

VECTRA Mk II (C) GTS

1.6 16V	Petrol	74	06/04 → 07/08
---------	--------	----	---------------

VECTRA Mk II (C) Station wagon

1.6 16V	Petrol	74	06/04 → 07/08
---------	--------	----	---------------

ZAFIRA Mk I (A) (F75)

1.6 16V	Petrol	74	04/99 → 08/05
---------	--------	----	---------------

SAC082

H2

**SENSORE POSIZIONE ALBERO A CAM
CAMSHAFT POSITION SENSOR**



KW



OPEL

ASTRA F (56_, 57_)

1.4 i 16V Petrol 66 02/96 → 09/98

1.6 i 16V Petrol 74 08/94 → 09/98

ASTRA F 2 volumi /Coda spiovente (53_, 54_, 58_, 59_)

1.6 i 16V Petrol 74 08/94 → 01/98

ASTRA F Cabriolet (53_B)

1.4 i 16V Petrol 66 01/96 → 03/01

ASTRA F CLASSIC 2 volumi /Coda spiovente

1.6 i 16V Petrol 74 01/98 → 08/02

ASTRA F CLASSIC Station wagon

1.6 i 16V Petrol 74 01/98 → 01/05

ASTRA F CLASSIC Tre volumi

1.6 i 16V Petrol 74 01/98 → 08/02

ASTRA F Station wagon (51_, 52_)

1.4 i 16V Petrol 66 02/96 → 01/98

1.6 i 16V Petrol 74 08/94 → 01/98

COMBO (71_)

1.4 16V Petrol 66 08/99 → 10/01

CORSA B (73_, 78_, 79_)

1.4 i 16V Petrol 63 08/97 → 09/00

1.4 i 16V Petrol 66 09/94 → 09/00

1.6 GSI 16V Petrol 80 03/93 → 09/00

1.6 i 16V Petrol 74 08/97 → 09/00

1.6 i 16V Petrol 78 09/94 → 09/00

TIGRA (95_)

1.4 16V Petrol 63 08/97 → 12/00

1.4 16V Petrol 66 07/94 → 12/00

1.6 16V Petrol 74 08/97 → 08/98

1.6 16V Petrol 78 07/94 → 08/98

VAUXHALL

ASTRA Mk III (F)

1.4 i 16V Petrol 66 02/96 → 09/98

1.6 i 16V Petrol 74 08/94 → 09/98

SAC082



KW



VAUXHALL

ASTRA Mk III (F) 2 volumi /Coda spiovente

1.4 i 16V Petrol 66 02/96 → 02/98

ASTRA Mk III (F) Cabriolet

1.4 i 16V Petrol 66 01/96 → 03/01

ASTRA Mk III (F) Station wagon

1.4 i 16V Petrol 66 02/96 → 01/98

1.6 i 16V Petrol 74 01/94 → 02/98

ASTRA Mk IV (G) 2 volumi /Coda spiovente

1.4 16V Petrol 66 02/98 → 05/05

1.6 16V Petrol 74 02/98 → 05/05

ASTRA Mk IV (G) Tre volumi

1.4 16V Petrol 66 09/98 → 05/05

1.6 16V Petrol 74 09/98 → 05/05

TIGRA Mk I (F07)

1.4 16V Petrol 66 07/94 → 12/00

1.6 16V Petrol 78 07/94 → 12/00

SAC083

H2

**SENSORE POSIZIONE ALBERO A CAM
CAMSHAFT POSITION SENSOR**



KW



FORD

MONDEO III (B5Y)

2.0 16V DI / TDDi / TDCi Diesel 66 03/06 → 08/07

2.0 16V TDDi / TDCi Diesel 85 09/02 → 08/07

2.0 TDCi Diesel 96 05/02 → 08/07

2.2 TDCi Diesel 110 09/04 → 08/07

2.2 TDCi Diesel 114 09/04 → 08/07

MONDEO III Station wagon (BWY)

2.0 16V DI / TDDi / TDCi Diesel 66 03/06 → 08/07

2.0 16V TDDi / TDCi Diesel 85 09/02 → 08/07

SAC083

FORD
MONDEO III Station wagon (BWY)

2.0 TDCi	Diesel	96	05/02 → 08/07
2.2 TDCi	Diesel	110	09/04 → 08/07
2.2 TDCi	Diesel	114	09/04 → 08/07

MONDEO III Tre volumi (B4Y)

2.0 16V DI / TDDi / TDCi	Diesel	66	03/06 → 08/07
2.0 16V TDDi / TDCi	Diesel	85	09/02 → 08/07
2.0 TDCi	Diesel	96	05/02 → 08/07
2.2 TDCi	Diesel	110	09/04 → 08/07
2.2 TDCi	Diesel	114	09/04 → 08/07

TRANSIT Autobus

2.2 TDCi	Diesel	63	04/06 →
2.2 TDCi	Diesel	81	04/06 →
2.2 TDCi	Diesel	96	04/06 →
2.2 TDCi	Diesel	103	10/07 → ENGINE: PGFA
2.2 TDCi	Diesel	74	10/11 →
2.2 TDCi	Diesel	85	10/08 → ENGINE: QVFA
2.2 TDCi	Diesel	92	10/11 →
2.2 TDCi (RWD)	Diesel	74	10/11 →
2.2 TDCi (RWD)	Diesel	92	10/11 →
2.2 TDCi [RWD]	Diesel	100	10/11 →
2.4 TDCi	Diesel	74	04/06 →
2.4 TDCi	Diesel	85	04/06 →
2.4 TDCi	Diesel	103	04/06 →
2.4 TDCi 4x4	Diesel	103	11/06 →
3.2 TDCi	Diesel	147	02/08 → ENGINE: 32DDOP

TRANSIT Autobus (FD_-, FB_-, FS_-, FZ_-, FC_-,)

2.0 TDCi (F_F-, F_E-, F_G-)	Diesel	92	08/02 → 05/06
2.4 TDCi	Diesel	101	03/04 → 05/06

TRANSIT Furgonato

2.2 TDCi	Diesel	63	04/06 →
2.2 TDCi	Diesel	81	04/06 →
2.2 TDCi	Diesel	96	04/06 →
2.2 TDCi	Diesel	103	10/07 → ENGINE: C22DD0P,PGFA
2.2 TDCi	Diesel	74	10/11 →
2.2 TDCi	Diesel	85	10/08 → ENGINE: C22DD0P,QVFA
2.2 TDCi	Diesel	92	10/11 →
2.2 TDCi (RWD)	Diesel	114	10/11 →
2.2 TDCi (RWD)	Diesel	74	10/11 →
2.2 TDCi (RWD)	Diesel	92	10/11 →

SAC083

FORD
TRANSIT Furgonato

2.2 TDCi 4x4	Diesel	92	10/11 →
2.3 16V	Petrol	107	04/06 → ENGINE: GZFA
2.4 TDCi	Diesel	74	04/06 →
2.4 TDCi	Diesel	85	04/06 →
2.4 TDCi	Diesel	103	04/06 →
2.4 TDCi 4x4	Diesel	103	11/06 →
3.2 TDCi	Diesel	147	09/07 → ENGINE: 32DDOP

TRANSIT Furgonato (FA_-,)

2.0 TDCi	Diesel	92	08/02 → 05/06
2.4 TDCi	Diesel	101	03/04 → 05/06

TRANSIT Pianale piatto/Telaio

2.2 TDCi	Diesel	63	04/06 →
2.2 TDCi	Diesel	81	04/06 →
2.2 TDCi	Diesel	96	04/06 →
2.2 TDCi	Diesel	92	10/11 →
2.2 TDCi	Diesel	103	10/07 → ENGINE: PGFA
2.2 TDCi	Diesel	74	10/11 →
2.2 TDCi	Diesel	85	10/08 → ENGINE: QVFA
2.2 TDCi (RWD)	Diesel	114	10/11 →
2.2 TDCi (RWD)	Diesel	74	10/11 →
2.2 TDCi (RWD)	Diesel	92	10/11 →
2.2 TDCi 4x4	Diesel	92	10/11 →
2.3 16V	Petrol	107	04/06 → ENGINE: GZFB
2.4 TDCi	Diesel	74	04/06 →
2.4 TDCi	Diesel	85	04/06 →
2.4 TDCi	Diesel	103	04/06 →
2.4 TDCi 4x4	Diesel	103	11/06 → ENGINE: HPFB
3.2 TDCi	Diesel	147	09/07 → ENGINE: 32DDOP

TRANSIT Pianale piatto/Telaio (FM_-, FN_-,)

2.0 TDCi (F_E-, F_F-)	Diesel	92	08/02 → 05/06
2.4 TDCi	Diesel	101	03/04 → 05/06

TRANSIT TOURNEO

2.2 TDCi	Diesel	103	10/07 →
2.2 TDCi	Diesel	81	07/06 →
2.2 TDCi	Diesel	96	07/06 →
2.2 TDCi	Diesel	85	10/08 →

LAND ROVER
DEFENDER Cabrio (LD)

2.4 Td4 4x4	Diesel	90	05/07 →
-------------	--------	----	---------

DEFENDER Pick-up (LD_)

2.4 Td4 4x4	Diesel	90	05/07 → ENGINE: 25P
-------------	--------	----	---------------------

DEFENDER Station Wagon (LD)

2.4 Td4 4x4	Diesel	90	05/07 → ENGINE: 23P,25P
-------------	--------	----	-------------------------

SAC084

H2 **SENSORE POSIZIONE ALBERO A CAM**
CAMSHAFT POSITION SENSOR



AUDI

A3 (8L1)

1.8 T	Petrol	132	12/98 → 05/03
1.8 T quattro	Petrol	132	10/98 → 05/03
1.8 T quattro	Petrol	110	12/96 → 05/03
S3 quattro	Petrol	154	03/99 → 04/02
S3 quattro	Petrol	165	10/01 → 05/03

A4 (8D2, B5)

1.8	Petrol	92	01/95 → 11/00
1.8 quattro	Petrol	92	01/95 → 11/00
1.8 T	Petrol	110	01/95 → 11/00
1.8 T	Petrol	132	12/97 → 11/00
1.8 T quattro	Petrol	110	01/95 → 11/00
1.8 T quattro	Petrol	132	12/97 → 11/00
2.4	Petrol	120	08/97 → 06/00
2.4	Petrol	121	03/97 → 11/00
2.4 quattro	Petrol	120	08/97 → 11/00
2.4 quattro	Petrol	121	03/97 → 11/00
2.8	Petrol	142	10/96 → 06/00
2.8 quattro	Petrol	142	10/96 → 08/01
S4 quattro	Petrol	195	09/97 → 09/01

A4 (8E2, B6)

1.8 T	Petrol	110	11/00 → 07/02
1.8 T	Petrol	120	07/02 → 12/04
1.8 T	Petrol	140	11/02 → 12/04
1.8 T quattro	Petrol	110	11/00 → 07/02
1.8 T quattro	Petrol	120	07/02 → 12/04
1.8 T quattro	Petrol	140	11/02 → 12/04
2.0	Petrol	96	11/00 → 12/04
2.4	Petrol	125	09/01 → 12/04

A4 (8EC, B7)

1.8 T	Petrol	120	11/04 → 06/08
1.8 T quattro	Petrol	120	11/04 → 06/08
2.0	Petrol	96	11/04 → 06/08

SAC084



AUDI

A4 Avant (8D5, B5)

1.8	Petrol	92	02/96 → 07/99
1.8 quattro	Petrol	92	01/96 → 09/01
1.8 T	Petrol	110	03/96 → 09/01
1.8 T	Petrol	132	12/97 → 09/01
1.8 T quattro	Petrol	132	12/97 → 09/01
1.8 T quattro	Petrol	110	01/96 → 09/01
2.4	Petrol	120	08/98 → 06/00
2.4	Petrol	121	03/97 → 09/01
2.4 quattro	Petrol	120	08/97 → 09/01
2.4 quattro	Petrol	121	03/97 → 09/01
2.8	Petrol	142	10/96 → 09/01
2.8 quattro	Petrol	142	10/96 → 09/01
RS4 quattro	Petrol	280	05/00 → 09/01
S4 quattro	Petrol	195	09/97 → 09/01

A4 Avant (8E5, B6)

1.8 T	Petrol	110	09/01 → 07/02
1.8 T	Petrol	120	07/02 → 12/04
1.8 T	Petrol	140	11/02 → 12/04
1.8 T quattro	Petrol	110	09/01 → 07/02
1.8 T quattro	Petrol	120	07/02 → 12/04
1.8 T quattro	Petrol	140	11/02 → 12/04
2.0	Petrol	96	09/01 → 12/04
2.4	Petrol	125	09/01 → 12/04

A4 Avant (8ED, B7)

1.8 T	Petrol	120	11/04 → 06/08
1.8 T quattro	Petrol	120	11/04 → 06/08
2.0	Petrol	96	11/04 → 06/08

A4 Cabriolet (8H7, B6, 8HE, B7)

1.8 T	Petrol	120	07/02 → 03/09
1.8 T quattro	Petrol	120	05/03 → 03/09
2.0	Petrol	96	09/04 → 12/05
2.4	Petrol	125	04/02 → 12/05

A6 (4A, C4)

1.8	Petrol	92	12/95 → 10/97
1.8 quattro	Petrol	92	12/95 → 10/97
2.0 16V	Petrol	103	06/94 → 10/97
2.0 16V quattro	Petrol	103	06/94 → 10/97
2.8	Petrol	142	12/95 → 10/97
2.8 quattro	Petrol	142	12/95 → 10/97

A6 (4B2, C5)

1.8	Petrol	92	12/97 → 01/05
1.8 T	Petrol	132	12/97 → 10/00
1.8 T quattro	Petrol	132	12/97 → 10/00
1.8 T quattro	Petrol	110	02/97 → 01/05

SAC084

KW

AUDI
A6 (4B2, C5)

2.0	Petrol	96	08/01 → 01/05
2.4	Petrol	125	08/01 → 01/05
2.4	Petrol	115	04/98 → 04/01
2.4	Petrol	100	07/98 → 01/05
2.4	Petrol	120	02/97 → 01/05
2.4	Petrol	121	02/97 → 05/01
2.4 quattro	Petrol	125	08/01 → 01/05
2.4 quattro	Petrol	115	08/98 → 07/99
2.4 quattro	Petrol	120	02/97 → 05/00
2.4 quattro	Petrol	121	02/97 → 05/01
2.7 T	Petrol	169	02/99 → 05/01
2.7 T quattro	Petrol	169	12/97 → 08/00
2.7 T quattro	Petrol	184	08/01 → 01/05
2.8	Petrol	132	10/97 → 05/00
2.8	Petrol	140	07/99 → 04/01
2.8	Petrol	142	02/97 → 04/01
2.8 quattro	Petrol	142	02/97 → 05/01
3.0	Petrol	162	08/01 → 05/04
3.0 quattro	Petrol	162	08/01 → 05/04
4.2 quattro	Petrol	220	04/99 → 05/04
RS6 quattro	Petrol	331	07/02 → 01/05
S6 quattro	Petrol	250	09/99 → 01/05

A6 Avant (4A, C4)

1.8	Petrol	92	12/95 → 12/97
1.8 quattro	Petrol	92	12/95 → 12/97
2.0 16V	Petrol	103	06/94 → 12/97
2.0 16V quattro	Petrol	103	06/94 → 12/97
2.8	Petrol	142	12/95 → 12/97
2.8 quattro	Petrol	142	12/95 → 12/97

A6 Avant (4B5, C5)

1.8	Petrol	92	12/97 → 04/01
1.8 T	Petrol	132	04/99 → 10/00
1.8 T	Petrol	110	02/98 → 04/01
1.8 T quattro	Petrol	132	12/97 → 10/00
1.8 T quattro	Petrol	110	02/98 → 01/05
2.0	Petrol	96	08/01 → 01/05
2.4	Petrol	125	08/01 → 01/05
2.4	Petrol	100	07/98 → 01/05
2.4	Petrol	115	04/98 → 07/98
2.4	Petrol	120	12/97 → 04/01

SAC084

KW

AUDI
A6 Avant (4B5, C5)

2.4	Petrol	121	12/97 → 05/01
2.4 quattro	Petrol	125	08/01 → 01/05
2.4 quattro	Petrol	115	08/98 → 05/01
2.4 quattro	Petrol	120	12/97 → 05/01
2.4 quattro	Petrol	121	12/97 → 05/01
2.7 T	Petrol	169	02/99 → 05/01
2.7 T quattro	Petrol	184	08/01 → 01/05
2.7 T quattro	Petrol	169	12/97 → 08/00
2.8	Petrol	140	07/99 → 04/01
2.8	Petrol	142	12/97 → 01/05
2.8	Petrol	132	12/97 → 05/00
2.8 quattro	Petrol	142	12/97 → 01/05
4.2 quattro	Petrol	220	11/98 → 01/05
RS6 plus quattro	Petrol	353	04/04 → 01/05
RS6 quattro	Petrol	331	07/02 → 01/05
S6 quattro	Petrol	250	09/99 → 01/05

A8 (4D2, 4D8)

2.8	Petrol	142	04/96 → 09/02
2.8 quattro	Petrol	142	04/96 → 09/02
3.7	Petrol	169	07/95 → 12/98
3.7	Petrol	191	11/98 → 09/02
3.7 quattro	Petrol	191	11/98 → 09/02
3.7 quattro	Petrol	169	07/95 → 11/98
4.2 quattro	Petrol	180	03/94 → 07/96
4.2 quattro	Petrol	220	03/94 → 11/98
S 8 quattro	Petrol	265	06/99 → 09/02

A8 (4E_)

3.7 quattro	Petrol	206	10/02 → 05/06
4.2 quattro	Petrol	246	10/02 → 07/10

ALLROAD (4BH, C5)

2.7 T quattro	Petrol	184	05/00 → 08/05
---------------	--------	-----	---------------

TT (8N3)

1.8 T	Petrol	110	09/02 → 06/06
1.8 T	Petrol	132	10/98 → 06/06
1.8 T quattro	Petrol	132	10/98 → 06/06
1.8 T quattro	Petrol	165	10/98 → 06/06

TT Roadster (8N9)

1.8 T	Petrol	110	01/01 → 06/06
1.8 T	Petrol	132	10/99 → 06/06
1.8 T quattro	Petrol	132	02/00 → 06/06
1.8 T quattro	Petrol	165	10/99 → 06/06

SAC084



KW



SEAT

ALHAMBRA (7V8, 7V9)

1.8 T 20V Petrol 110 05/98 → 03/10

CORDOBA (6K2)

1.8 T 20V Cupra Petrol 115 07/00 → 10/02

IBIZA III (6K1)

1.8 T 20V Cupra Petrol 115 07/00 → 02/02

IBIZA IV (6L1)

1.8 T Cupra R Petrol 132 01/04 → 02/08

1.8 T FR Petrol 110 12/03 → 05/08

LEON (1M1)

1.8 20V Petrol 92 11/99 → 07/04

1.8 20V T Petrol 132 11/99 → 06/06

1.8 20V T 4 Petrol 132 11/99 → 06/06

1.8 T Cupra R Petrol 165 07/03 → 06/06

1.8 T Cupra R Petrol 154 02/02 → 05/03

TOLEDO II (1M2)

1.8 20V Petrol 92 04/99 → 05/02

1.8 20VT Petrol 132 05/01 → 05/02

SKODA

OCTAVIA (1U2)

1.8 T Petrol 110 08/97 → 12/10

1.8 T 4x4 Petrol 110 05/01 → 05/06

RS 1.8 T Petrol 132 05/01 → 09/04

OCTAVIA Combi (1U5)

1.8 20V Petrol 92 07/98 → 04/99

1.8 T Petrol 110 07/98 → 09/04

1.8 T 4x4 Petrol 110 05/01 → 09/04

RS 1.8 T Petrol 132 08/02 → 09/04

SUPERB (3U4)

1.8 T Petrol 110 12/01 → 03/08

2.8 V6 Petrol 142 12/01 → 03/08

VOLKSWAGEN

BORA (1J2)

1.8 Petrol 92 10/98 → 05/05

1.8 4motion Petrol 92 02/99 → 05/05

1.8 T Petrol 110 05/00 → 05/05

1.8 T Petrol 132 03/02 → 05/03

BORA Station wagon (1J6)

1.8 4motion Petrol 92 05/99 → 10/00

1.8 T Petrol 110 05/00 → 05/05

1.8 T Petrol 132 05/02 → 05/03

SAC084



KW



VOLKSWAGEN

GOLF IV (1J1)

1.8 Petrol 92 08/97 → 06/05

1.8 4motion Petrol 92 05/98 → 06/05

1.8 T Petrol 110 08/97 → 06/05

1.8 T GTI Petrol 132 08/01 → 06/05

GOLF IV Variant (1J5)

1.8 4motion Petrol 92 05/99 → 10/00

1.8 T Petrol 110 05/00 → 05/03

NEW BEETLE (9C1, 1C1)

1.8 T Petrol 110 10/99 → 09/10

1.8 T Petrol 132 11/01 → 06/05

NEW BEETLE Cabriolet (1Y7)

1.8 T Petrol 110 01/03 → 09/10

PASSAT (3B2)

1.8 Syncro/4motion Petrol 92 10/96 → 11/00

2.8 V6 Petrol 132 05/97 → 09/99

2.8 V6 Petrol 140 09/99 → 11/00

PASSAT (3B3)

1.8 T 20V Petrol 110 11/00 → 05/05

2.0 Petrol 96 11/01 → 05/05

2.8 4motion Petrol 142 11/00 → 05/05

PASSAT Variant (3B5)

1.8 Syncro/4motion Petrol 92 06/97 → 11/00

2.8 V6 Petrol 132 09/97 → 09/99

2.8 V6 Syncro/4motion Petrol 142 06/97 → 11/00

PASSAT Variant (3B6)

1.8 T 20V Petrol 110 11/00 → 05/05

2.0 Petrol 96 11/01 → 05/05

2.8 4motion Petrol 142 11/00 → 05/05

PHAETON (3D_)

4.2 V8 4motion Petrol 246 05/03 →

SHARAN (7M8, 7M9, 7M6)

1.8 T 20V Petrol 110 09/97 → 03/10

TOUAREG (7LA, 7L6, 7L7)

4.2 V8 Petrol 228 12/02 → 11/06

SAC085
H2 **SENSORE POSIZIONE ALBERO A CAM**
CAMSHAFT POSITION SENSOR

AUDI
A3 (8P1)

2.0 TDi	Diesel	125	03/06 → 08/12
2.0 TDi quattro	Diesel	100	05/03 → 06/08
2.0 TDi quattro	Diesel	125	03/06 → 08/12

A3 Sportback (8PA)

2.0 TDi	Diesel	125	03/06 → 03/13
2.0 TDi 16V	Diesel	103	09/04 → 03/13
2.0 TDi 16V quattro	Diesel	103	11/05 → 03/13
2.0 TDi quattro	Diesel	125	03/06 → 03/13

A4 (8EC, B7)

2.0 TDi	Diesel	100	11/04 → 06/08
2.0 TDi	Diesel	125	06/06 → 06/08
2.0 TDi 16V	Diesel	103	11/04 → 06/08
2.0 TDi quattro	Diesel	125	06/06 → 06/08

A4 Avant (8ED, B7)

2.0 TDi	Diesel	100	11/04 → 06/08
2.0 TDi	Diesel	125	06/06 → 06/08
2.0 TDi 16V	Diesel	103	11/04 → 06/08
2.0 TDi quattro	Diesel	125	06/06 → 06/08

A4 Cabriolet (8H7, B6, 8HE, B7)

2.0 TFSI 16V	Petrol	147	01/06 → 03/09
--------------	--------	-----	---------------

A6 (4F2, C6)

2.0 TDi	Diesel	103	07/04 → 10/08
2.0 TDi	Diesel	100	07/04 → 03/11

A6 Avant (4F5, C6)

2.0 TDi	Diesel	100	06/05 → 08/11
2.0 TDi	Diesel	103	06/05 → 10/08
2.0 TDi	Diesel	89	09/05 → 06/06

MITSUBISHI
GRANDIS (NA_W)

2.0 DI-D	Diesel	100	09/05 →
----------	--------	-----	---------

OUTLANDER II (CW_W)

2.0 DI-D	Diesel	103	02/07 → 11/12
----------	--------	-----	---------------

SAC085

SEAT
ALTEA (5P1)

2.0 TDi	Diesel	100	03/04 → 05/09
2.0 TDi	Diesel	125	03/06 →
2.0 TDi 16V	Diesel	103	03/04 →

ALTEA XL (5P5, 5P8)

2.0 TDi	Diesel	125	06/07 →
2.0 TDi 16V	Diesel	103	10/06 →
2.0 TDi 4x4	Diesel	125	06/07 →

LEON (1P1)

2.0 TDi	Diesel	125	05/06 →
2.0 TDi	Diesel	100	07/05 → 05/10
2.0 TDi 16V	Diesel	103	07/05 →

TOLEDO III (5P2)

2.0 TDi	Diesel	100	09/04 → 05/09
2.0 TDi	Diesel	125	01/06 → 05/09
2.0 TDi 16V	Diesel	103	04/04 → 05/09

SKODA
OCTAVIA (1Z3)

2.0 TDi	Diesel	100	02/04 → 05/10
---------	--------	-----	---------------

OCTAVIA Combi (1Z5)

2.0 TDi 16V	Diesel	100	02/04 → 05/10
-------------	--------	-----	---------------

VOLKSWAGEN
GOLF PLUS (5M1, 521)

2.0 TDi	Diesel	100	05/05 →
2.0 TDi 16V	Diesel	103	01/05 →

GOLF V (1K1)

2.0 TDi	Diesel	100	10/03 → 11/08
2.0 TDi	Diesel	125	11/05 → 11/08
2.0 TDi 16V	Diesel	103	10/03 → 11/08
2.0 TDi 16V 4motion	Diesel	103	08/04 → 11/08

GOLF V Variant (1K5)

2.0 TDi	Diesel	100	06/07 → 07/09
2.0 TDi 16V	Diesel	103	06/07 → 07/09
2.0 TDi 4motion	Diesel	100	06/07 → 07/09

JETTA III (1K2)

2.0 TDi	Diesel	100	09/05 → 10/10
---------	--------	-----	---------------

PASSAT (3C2)

2.0 TDi	Diesel	100	03/05 → 11/10
2.0 TDi	Diesel	125	08/05 → 07/10
2.0 TDi 16V	Diesel	103	03/05 → 07/10
2.0 TDi 16V 4motion	Diesel	103	03/05 → 08/10

SAC085



VOLKSWAGEN

PASSAT Variant (3C5)

2.0 TDi	Diesel	100	08/05 → 11/10
2.0 TDi	Diesel	125	08/05 → 11/10
2.0 TDi	Diesel	90	08/05 → 02/06
2.0 TDI 16V	Diesel	103	08/05 → 11/10
2.0 TDI 16V 4motion	Diesel	103	08/05 → 11/10

TOURAN (1T1, 1T2)

2.0 TDi	Diesel	100	02/03 → 05/10
2.0 TDi	Diesel	125	12/05 → 05/10
2.0 TDI 16V	Diesel	103	08/03 → 05/10

SAC086

H2 **SENSORE POSIZIONE ALBERO A CAM**
CAMSHAFT POSITION SENSOR



DAIHATSU

YRV (M2)

1.3	Petrol	64	02/01 →
1.3 4WD	Petrol	64	02/01 →

TOYOTA

AVENSIS (_T22_)

1.6 (AT220_)	Petrol	74	09/97 → 10/00
1.6 (AT220_)	Petrol	81	09/97 → 10/00
1.8 (AT221_)	Petrol	81	09/97 → 10/00

AVENSIS Liftback (_T22_)

1.6 (AT220_)	Petrol	74	09/97 → 10/00
1.6 (AT220_)	Petrol	81	09/97 → 10/00
1.8 (AT221_)	Petrol	81	09/97 → 10/00

AVENSIS Station Wagon (_T22_)

1.6 (AT220_)	Petrol	74	09/97 → 10/00
1.6 (AT220_)	Petrol	81	09/97 → 10/00
1.8 (AT221_)	Petrol	81	09/97 → 10/00

PRIUS 2 volumi /Coda spiovente (NHW20_)

1.5	Petrol	57	08/03 → 03/09
-----	--------	----	---------------

SAC086



TOYOTA

PRIUS Tre volumi (NHW11_)

1.5	Petrol	53	05/00 → 01/04
-----	--------	----	---------------

YARIS (SCP1_, NLP1_, NCP1_)

1.0 16V	Petrol	50	04/99 → 09/05
1.3 16V	Petrol	63	11/99 → 09/05
1.5 TS	Petrol	77	01/03 → 09/05
1.5 VVT-i TS	Petrol	78	04/01 → 09/05

YARIS VERSO (_NLP2_, _NCP2_)

1.3 (NCP22)	Petrol	62	08/99 → 09/05
1.3 (NCP22)	Petrol	63	08/99 → 09/05
1.5 (NCP21)	Petrol	77	05/03 → 09/05
1.5 (NCP21)	Petrol	78	03/00 → 09/05

SAC088

H2 **SENSORE POSIZIONE ALBERO A CAM**
CAMSHAFT POSITION SENSOR



ALFA ROMEO

145 (930)

1.9 JTD	Diesel	77	02/99 → 12/00
1.9 TD	Diesel	66	05/98 → 02/99

146 (930)

1.9 JTD	Diesel	77	02/99 → 12/00
1.9 TD	Diesel	66	05/98 → 02/99

147 (937)

1.9 JTD	Diesel	74	06/03 → 03/10
1.9 JTD (937AXD1A)	Diesel	85	04/01 → 03/10
1.9 JTD 8V	Diesel	88	07/05 → 03/10

156 (932)

1.9 JTD (932A2B, 932A2C)	Diesel	85	01/02 → 09/05
1.9 JTD (932A2B_)	Diesel	81	10/00 → 05/01
1.9 JTD (932B2)	Diesel	77	09/97 → 10/00

SAC088

ALFA ROMEO
156 (932)

2.4 JTD (932A1B__)	Diesel	103	10/00 → 12/01
--------------------	--------	-----	---------------

2.4 JTD (932AXC)	Diesel	110	03/02 → 09/05
------------------	--------	-----	---------------

2.4 JTD (932B1)	Diesel	100	09/97 → 09/03
-----------------	--------	-----	---------------

156 Sportwagon (932)

1.9 JTD (932B2)	Diesel	77	05/00 → 10/00
-----------------	--------	----	---------------

1.9 JTD (932B2B, 932B2C)	Diesel	85	01/02 → 05/06
--------------------------	--------	----	---------------

1.9 JTD (932B2B__)	Diesel	81	10/00 → 05/01
--------------------	--------	----	---------------

2.4 JTD (932B1)	Diesel	100	05/00 → 09/03
-----------------	--------	-----	---------------

2.4 JTD (932B1B__)	Diesel	103	10/00 → 12/01
--------------------	--------	-----	---------------

2.4 JTD (932BXC)	Diesel	110	03/02 → 05/06
------------------	--------	-----	---------------

159 (939)

1.9 JTDM 8V	Diesel	85	09/05 → 11/11
-------------	--------	----	---------------

1.9 JTDM 8V	Diesel	88	09/05 → 11/11
-------------	--------	----	---------------

159 Sportwagon (939)

1.9 JTDM 8V	Diesel	88	03/06 → 11/11
-------------	--------	----	---------------

1.9 JTDM 8V	Diesel	85	03/06 → 11/11
-------------	--------	----	---------------

166 (936)

2.4 JTD	Diesel	110	04/02 → 06/07
---------	--------	-----	---------------

2.4 JTD (936A2A__)	Diesel	100	09/98 → 10/00
--------------------	--------	-----	---------------

2.4 JTD (936A2B__)	Diesel	103	10/00 → 06/07
--------------------	--------	-----	---------------

FIAT
BRAVA (182)

1.9 JTD	Diesel	74	09/00 → 10/01
---------	--------	----	---------------

1.9 JTD 105	Diesel	77	12/98 → 10/01
-------------	--------	----	---------------

BRAVO I (182)

1.9 JTD	Diesel	74	09/00 → 10/01
---------	--------	----	---------------

1.9 JTD 105	Diesel	77	12/98 → 10/01
-------------	--------	----	---------------

DOBLO (119)

1.9 D Multijet	Diesel	88	10/05 →
----------------	--------	----	---------

1.9 JTD	Diesel	77	07/03 →
---------	--------	----	---------

1.9 JTD (223AXE1A)	Diesel	74	10/01 →
--------------------	--------	----	---------

DOBLO Cargo (223)

1.9 JTD	Diesel	77	07/03 →
---------	--------	----	---------

1.9 JTD (223ZXE1A)	Diesel	74	10/01 →
--------------------	--------	----	---------

SAC088

FIAT
IDEA

1.9 JTD	Diesel	74	01/04 →
---------	--------	----	---------

MAREA (185)

1.9 JTD 105	Diesel	77	04/99 → 01/01
-------------	--------	----	---------------

1.9 JTD 110	Diesel	81	01/01 → 05/02
-------------	--------	----	---------------

2.4 JTD 130	Diesel	96	04/99 → 05/02
-------------	--------	----	---------------

MAREA Weekend (185)

1.9 JTD 105	Diesel	77	04/99 → 05/02
-------------	--------	----	---------------

1.9 JTD 110	Diesel	81	01/01 → 05/02
-------------	--------	----	---------------

2.4 JTD 130	Diesel	96	04/99 → 05/02
-------------	--------	----	---------------

MULTIPLA (186)

1.9 JTD (186AXE1A)	Diesel	88	04/02 → 06/10
--------------------	--------	----	---------------

1.9 JTD 105 (186AXB1A)	Diesel	77	04/99 → 06/10
------------------------	--------	----	---------------

1.9 JTD 110	Diesel	81	03/01 → 07/02
-------------	--------	----	---------------

1.9 JTD 115	Diesel	85	07/02 → 06/10
-------------	--------	----	---------------

PALIO Weekend (178DX)

1.9 JTD	Diesel	59	09/01 →
---------	--------	----	---------

PUNTO (188)

1.9 JTD	Diesel	63	10/01 →
---------	--------	----	---------

1.9 JTD	Diesel	74	06/03 →
---------	--------	----	---------

1.9 JTD 80 (188.237, .257, .337, .357)	Diesel	59	09/99 → 06/03
--	--------	----	---------------

PUNTO / GRANDE PUNTO (199)

1.9 D Multijet	Diesel	88	10/05 →
----------------	--------	----	---------

1.9 D Multijet	Diesel	96	10/05 →
----------------	--------	----	---------

PUNTO Van (188AX)

1.9 JTD	Diesel	63	02/00 → 06/03
---------	--------	----	---------------

SEDICI

1.9 D Multijet 4x4	Diesel	88	06/06 →
--------------------	--------	----	---------

STILO (192)

1.9 D Multijet	Diesel	88	09/05 → 11/06
----------------	--------	----	---------------

1.9 D Multijet	Diesel	74	09/05 → 11/06
----------------	--------	----	---------------

1.9 JTD (192_XE1A)	Diesel	85	10/01 → 11/06
--------------------	--------	----	---------------

1.9 JTD (192_XF1A)	Diesel	59	02/02 → 11/06
--------------------	--------	----	---------------

1.9 JTD (192AXS1B, 192BXS1B)	Diesel	66	09/04 → 11/06
------------------------------	--------	----	---------------

SAC088



KW



FIAT

STILO Multi Wagon (192)

1.9 D Multijet	Diesel	88	09/05 → 08/08
1.9 D Multijet	Diesel	74	09/05 → 08/08
1.9 JTD	Diesel	59	01/03 → 08/08
1.9 JTD	Diesel	85	01/03 → 08/08

STRADA Pick-up (178E)

1.9 JTD	Diesel	59	04/03 →
---------	--------	----	---------

LANCIA

KAPPA (838A)

2.4 JTD (838AL1AA)	Diesel	100	06/98 → 10/01
-----------------------	--------	-----	---------------

KAPPA SW (838B)

2.4 JTD (838BL1AA)	Diesel	100	06/98 → 10/01
-----------------------	--------	-----	---------------

LYBRA (839AX)

1.9 JTD	Diesel	85	05/01 → 10/05
1.9 JTD (839AXD1A)	Diesel	77	07/99 → 09/00
1.9 JTD (839AXI1A)	Diesel	81	09/00 → 05/01
2.4 JTD	Diesel	110	05/02 → 10/05
2.4 JTD (839AXE1A)	Diesel	99	07/99 → 02/01
2.4 JTD (839AXL1A)	Diesel	103	09/00 → 05/02

LYBRA SW (839BX)

1.9 JTD	Diesel	85	05/01 → 10/05
1.9 JTD (839BXD1A)	Diesel	77	07/99 → 09/00
1.9 JTD (839BXI1A)	Diesel	81	09/00 → 05/01
2.4 JTD	Diesel	110	05/02 → 10/05
2.4 JTD (839BXE1A)	Diesel	99	10/99 → 09/00
2.4 JTD (839BXL1A)	Diesel	103	09/00 → 10/05

MUSA (350)

1.9 D Multijet	Diesel	74	10/04 →
----------------	--------	----	---------

THESIS (841AX)

2.4 JTD (841AXD1B02)	Diesel	110	07/02 → 07/09
-------------------------	--------	-----	---------------

SAC088



KW



OPEL

ASTRA H (L48)

1.9 CDTI	Diesel	74	09/05 →
----------	--------	----	---------

ASTRA H GTC (L08)

1.9 CDTI	Diesel	74	01/06 →
----------	--------	----	---------

ASTRA H Station wagon (L35)

1.9 CDTI	Diesel	74	09/05 →
----------	--------	----	---------

SIGNUM

1.9 CDTI	Diesel	88	04/04 →
----------	--------	----	---------

1.9 CDTI	Diesel	74	08/05 →
----------	--------	----	---------

VECTRA C

1.9 CDTI	Diesel	74	10/05 →
----------	--------	----	---------

1.9 CDTI	Diesel	88	04/04 →
----------	--------	----	---------

VECTRA C GTS

1.9 CDTI	Diesel	74	10/05 →
----------	--------	----	---------

1.9 CDTI	Diesel	88	04/04 →
----------	--------	----	---------

VECTRA C Station wagon

1.9 CDTI	Diesel	74	10/05 →
----------	--------	----	---------

1.9 CDTI	Diesel	88	04/04 →
----------	--------	----	---------

ZAFIRA B (A05)

1.9 CDTI	Diesel	74	07/05 →
----------	--------	----	---------

1.9 CDTI	Diesel	88	07/05 →
----------	--------	----	---------

SUZUKI

SX4 (GY)

1.9 DDiS	Diesel	88	06/06 →
----------	--------	----	---------

1.9 DDiS 4x4	Diesel	88	06/06 →
--------------	--------	----	---------

VAUXHALL

ASTRA Mk V (H) 2 volumi /Coda spiovente

1.9 CDTI	Diesel	88	01/04 → 05/09
----------	--------	----	---------------

ASTRA Mk V (H) Station wagon

1.9 CDTI	Diesel	88	08/04 → 03/09
----------	--------	----	---------------

SIGNUM

1.9 CDTI	Diesel	88	04/04 → 03/08
----------	--------	----	---------------

VECTRA Mk II (C)

1.9 CDTI	Diesel	88	04/02 → 09/08
----------	--------	----	---------------

VECTRA Mk II (C) GTS

1.9 CDTI	Diesel	88	08/02 → 07/08
----------	--------	----	---------------

VECTRA Mk II (C) Station wagon

1.9 CDTI	Diesel	88	04/04 → 07/08
----------	--------	----	---------------

ZAFIRA Mk II (B) (M75)

1.9 CDTI	Diesel	88	07/05 →
----------	--------	----	---------

SAC089
H2 **SENSORE POSIZIONE ALBERO A CAM**
CAMSHAFT POSITION SENSOR

KW

FORD
FIESTA IV (JA_, JB_)

1.6 16V Sport Petrol 76 02/00 → 01/02

MERCEDES-BENZ
CLK (C208)

200 (208.335) Petrol 100 11/99 → 06/02

200 Kompressor (208.345) Petrol 141 11/99 → 06/00

230 Kompressor (208.347) Petrol 142 12/99 → 06/00

320 (208.365) Petrol 160 12/99 → 06/02

CLK Cabriolet (A208)

200 (208.435) Petrol 100 11/99 → 03/02

SAC090
H2 **SENSORE POSIZIONE ALBERO A CAM**
CAMSHAFT POSITION SENSOR

KW

FORD
FOCUS II (DA_)

2.5 RS Petrol 224 01/09 →

2.5 RS 500 Petrol 257 05/10 → 07/11

KUGA I

2.5 4x4 Petrol 147 03/09 →

SAC090

KW

FORD
MONDEO IV (BA7)

2.5 Petrol 162 03/07 → 08/09

MONDEO IV Tre volumi (BA7)

2.5 Petrol 162 03/07 → 08/09

MONDEO IV Turnier (BA7)

2.5 Petrol 162 03/07 → 08/09

VOLVO
C30

2.4 i Petrol 125 10/06 → 12/10

D5 Diesel 120 10/06 → 12/10

D5 Diesel 132 10/06 → 12/10

T5 Petrol 162 10/06 → 05/07

T5 Petrol 169 06/07 → 12/12

C70 I Cabriolet

2.0 T Petrol 120 01/02 → 10/05

2.3 T5 Petrol 180 07/02 → 10/05

2.3 T5 Petrol 176 01/02 → 10/05

2.4 T Petrol 147 07/02 → 10/05

2.5 T Petrol 142 05/01 → 10/05

C70 I Coupé

2.0 T Petrol 120 01/02 → 09/02

2.3 T-5 Petrol 176 01/02 → 09/02

2.5 T Petrol 142 01/02 → 09/02

C70 II Cabriolet

2.4 Petrol 103 03/06 →

2.4 i Petrol 125 03/06 → 12/10

D5 Diesel 132 03/06 → 12/10

T5 Petrol 162 03/06 → 02/07

T5 Petrol 169 03/07 →

S40 II (MS)

2.4 Petrol 103 01/04 →

2.4 Petrol 125 01/04 →

2.4 AWD Petrol 125 08/06 →

2.4 D5 Diesel 132 03/06 →

T5 Petrol 162 01/04 →

T5 Petrol 169 03/07 →

T5 AWD Petrol 162 04/04 →

T5 AWD Petrol 169 03/07 →

S60 I

2.0 T Petrol 132 01/02 → 04/10

2.3 T5 Petrol 195 01/02 → 09/02

2.4 Petrol 103 01/02 → 04/10

2.4 Petrol 125 01/02 → 04/10

 2.4 Bifuel (CNG) Petrol/
CNG 103 06/02 → 04/10

SAC090



VOLVO

S60 I

2.4 D	Diesel	120	09/05 → 01/09
2.4 D	Diesel	93	09/05 → 04/10
2.4 D5	Diesel	136	09/05 → 04/10
2.4 T	Petrol	147	01/02 → 04/10
2.4 T AWD	Petrol	147	11/01 → 04/10
2.4 T5	Petrol	191	04/04 → 04/10
2.5 T	Petrol	154	02/04 → 04/10
2.5 T AWD	Petrol	154	04/04 → 04/10
R 2,5 T AWD	Petrol	221	03/03 → 04/10
T5	Petrol	184	01/02 → 04/10

S60 II

D3	Diesel	120	04/10 → 04/12
D5	Diesel	151	04/10 → 05/11
D5 AWD	Diesel	151	04/10 → 05/11

S80 I (TS, XY)

2.0 T	Petrol	132	01/02 → 07/06
2.4	Petrol	103	01/02 → 07/06
2.4	Petrol	125	01/02 → 07/06
2.4 Bifuel (CNG)	Petrol/ CNG	103	01/02 → 07/06
2.4 T	Petrol	147	01/02 → 07/06
2.4 T5 AWD	Petrol	147	01/02 → 09/03
2.5 T	Petrol	154	03/03 → 07/06
2.5 T AWD	Petrol	154	07/03 → 07/06
3.0	Petrol	144	10/01 → 07/06
3.0 T6	Petrol	200	01/02 → 07/06

S80 II (AS)

2.4 D	Diesel	120	08/06 → 03/11
2.4 D	Diesel	129	01/10 → 03/11
2.5 T	Petrol	147	08/06 → 12/09
2.5 T	Petrol	170	01/10 → 12/12
2.5 T FlexFuel	BiFuel	147	05/08 → 03/12
2.5 T FlexFuel	BiFuel	170	01/10 → 12/11
4.4 V8 AWD	Petrol	232	08/06 → 03/12
D3 / D4	Diesel	120	09/10 → 12/11
D5	Diesel	136	08/06 → 05/09
D5	Diesel	151	01/10 → 12/11
D5 AWD	Diesel	136	03/08 → 05/09
D5 AWD	Diesel	151	01/10 → 12/11

V50 (MW)

2.4	Petrol	103	04/04 →
2.4	Petrol	125	04/04 →
2.4 AWD	Petrol	125	08/06 →
2.4 D5	Diesel	132	03/06 →

SAC090



VOLVO

V50 (MW)

2.4 Tdi	Diesel	120	05/07 →
T5	Petrol	162	04/04 →
T5	Petrol	169	03/07 →
T5 AWD	Petrol	162	04/04 →
T5 AWD	Petrol	169	03/07 →

V70 II (SW)

2.0 T	Petrol	132	01/02 → 08/07
2.3	Petrol	195	01/02 → 09/04
2.3 T5	Petrol	184	01/02 → 08/07
2.4	Petrol	103	01/02 → 08/07
2.4	Petrol	125	01/02 → 08/07
2.4 Bifuel (CNG)	Petrol/ CNG	103	01/02 → 08/07
2.4 D	Diesel	96	12/01 → 08/07
2.4 D	Diesel	93	08/05 → 08/07
2.4 D5	Diesel	120	01/02 → 08/07
2.4 D5	Diesel	136	12/05 → 08/07
2.4 D5 AWD	Diesel	120	03/03 → 08/07
2.4 D5 AWD	Diesel	136	12/05 → 08/07
2.4 T	Petrol	147	01/02 → 08/07
2.4 T AWD	Petrol	147	01/02 → 08/07
2.4 T5	Petrol	191	04/04 → 08/07
2.5 T	Petrol	154	04/04 → 08/07
2.5 T AWD	Petrol	154	09/02 → 08/07
2.5 TDI	Diesel	103	01/02 → 08/07
R 2,5 T AWD	Petrol	221	03/03 → 08/07

V70 III (BW)

2.4 D	Diesel	120	08/07 → 12/10
2.4 D	Diesel	129	10/09 → 12/10
2.5 T	Petrol	147	08/07 → 12/09
2.5 T	Petrol	170	01/10 → 12/12
2.5 T FlexiFuel	BiFuel	147	05/08 → 05/09
2.5 T FlexiFuel	BiFuel	170	10/09 → 11/12
D3 / D4	Diesel	120	03/10 → 12/11
D5	Diesel	136	08/07 → 12/09
D5	Diesel	151	12/09 → 11/12
D5 AWD	Diesel	136	10/07 → 03/10
D5 AWD	Diesel	151	12/09 → 11/12

XC60

2.4 D	Diesel	129	07/09 →
2.4 D / D3 / D4 AWD	Diesel	120	05/08 →
D3 / D4	Diesel	120	03/10 → 12/11
D5 AWD	Diesel	136	05/08 → 12/09

SAC090

VOLVO
XC60

D5 AWD	Diesel	151	07/09 →
--------	--------	-----	---------

XC70 CROSS COUNTRY

2.4 D5 AWD	Diesel	136	12/05 → 08/07
------------	--------	-----	---------------

2.4 T XC AWD	Petrol	147	01/02 → 09/02
--------------	--------	-----	---------------

2.4 T XC AWD	Petrol	142	05/01 → 09/02
--------------	--------	-----	---------------

2.5 T XC AWD	Petrol	154	09/02 → 08/07
--------------	--------	-----	---------------

XC70 II

2.4 D	Diesel	129	01/10 → 12/10
-------	--------	-----	---------------

2.4 D / D4 AWD	Diesel	120	08/07 → 12/11
----------------	--------	-----	---------------

D3	Diesel	120	08/11 → 12/11
----	--------	-----	---------------

D3 AWD	Diesel	120	08/11 → 12/11
--------	--------	-----	---------------

D5 AWD	Diesel	136	08/07 → 04/09
--------	--------	-----	---------------

D5 AWD	Diesel	151	12/09 → 12/12
--------	--------	-----	---------------

XC90 I

2.5 T	Petrol	154	10/02 →
-------	--------	-----	---------

D5	Diesel	136	05/06 →
----	--------	-----	---------

D5	Diesel	147	01/11 →
----	--------	-----	---------

T6	Petrol	200	10/02 →
----	--------	-----	---------

V8	Petrol	232	01/05 →
----	--------	-----	---------

SAC091

DAIHATSU
SIRION (M3_)

1.0	Petrol	51	01/05 →
-----	--------	----	---------

1.3	Petrol	64	01/05 →
-----	--------	----	---------

1.3	Petrol	67	03/08 →
-----	--------	----	---------

1.3 4WD	Petrol	64	02/06 →
---------	--------	----	---------

1.3 4WD	Petrol	67	03/08 →
---------	--------	----	---------

TERIOS (J1)

1.3	Petrol	63	09/01 → 10/05
-----	--------	----	---------------

1.3 4WD	Petrol	63	10/00 → 10/05
---------	--------	----	---------------

YRV (M2)

1.3	Petrol	64	02/01 → 07/05
-----	--------	----	---------------

1.3 4WD	Petrol	64	02/01 → 07/05
---------	--------	----	---------------

1.3 GTi	Petrol	95	07/02 → 07/05
---------	--------	----	---------------

PEUGEOT
107

1.0	Petrol	50	06/05 →
-----	--------	----	---------

TOYOTA
AYGO (WNB1_, KGB1_)

1.0 (KGB10)	Petrol	50	07/05 →
-------------	--------	----	---------

YARIS (SCP9_, NSP9_, KSP9_, NCP9_, ZSP9_)

1.0 VVT-i	Petrol	51	08/05 →
-----------	--------	----	---------

SAC091
H2
**SENSORE POSIZIONE ALBERO A CAM
CAMSHAFT POSITION SENSOR**

CITROËN
C1 (PM_, PN_)

1.0	Petrol	50	06/05 →
-----	--------	----	---------

DAIHATSU
COPEN

1.3	Petrol	64	03/06 →
-----	--------	----	---------

SIRION (M1)

1.3 Sport	Petrol	75	08/00 → 07/04
-----------	--------	----	---------------

1.3 Sport 4WD	Petrol	75	08/00 → 07/04
---------------	--------	----	---------------

SAC092
H2
**SENSORE POSIZIONE ALBERO A CAM
CAMSHAFT POSITION SENSOR**

ALFA ROMEO
159 (939)

1.9 JTS	Petrol	118	09/05 → 11/11
---------	--------	-----	---------------

2.2 JTS	Petrol	136	09/05 → 11/11
---------	--------	-----	---------------

159 Sportwagon (939)

1.9 JTS	Petrol	118	03/06 → 11/11
---------	--------	-----	---------------

2.2 JTS	Petrol	136	03/06 → 11/11
---------	--------	-----	---------------

BRERA

2.2 JTS	Petrol	136	01/06 →
---------	--------	-----	---------

SAC092



KW



ALFA ROMEO

SPIDER (939)

2.2 JTS Petrol 136 09/06 →

FORD

FOCUS C-MAX

1.6 Ti Petrol 85 08/04 → 03/07

MONDEO IV (BA7)

1.6 Ti Petrol 81 03/07 →

1.6 Ti Petrol 92 03/07 →

MONDEO IV Tre volumi (BA7)

1.6 Ti Petrol 81 03/07 →

1.6 Ti Petrol 92 03/07 →

MONDEO IV Turnier (BA7)

1.6 Ti Petrol 81 03/07 →

1.6 Ti Petrol 92 03/07 →

LAND ROVER

RANGE ROVER III (LM)

3.6 TD 8 4x4 Diesel 200 04/06 → 08/12

RANGE ROVER SPORT (LS)

3.6 TD 8 4x4 Diesel 200 04/06 →

OPEL

AGILA (A) (H00)

1.0 Petrol 44 08/03 → 12/07

1.2 16V Twinport Petrol 59 07/04 → 12/07

ASTRA G 2 volumi /Coda spiovente (F48_, F08_)

1.4 Petrol 66 09/07 → 12/09

ASTRA G Station wagon (F35_)

1.4 Petrol 66 09/07 → 12/09

ASTRA G Tre volumi (F69_)

1.4 Petrol 66 09/07 → 12/09

ASTRA GTC J

1.6 Petrol 132 10/11 →

ASTRA H (L48)

1.2 Petrol 59 08/05 →

1.4 Petrol 66 03/04 →

1.4 LPG Petrol/LPG 66 08/09 →

1.6 Turbo Petrol 132 02/07 →

ASTRA H GTC (L08)

1.2 Petrol 59 08/05 →

1.4 Petrol 66 03/05 →

1.6 Turbo Petrol 132 02/07 →

ASTRA H Station wagon (L35)

1.4 Petrol 66 08/04 →

1.6 Turbo Petrol 132 02/07 →

SAC092



KW



OPEL

ASTRA H TwinTop (L67)

1.6 Turbo Petrol 132 02/07 →

ASTRA J

1.6 Turbo Petrol 132 12/09 →

ASTRA J Sports Tourer

1.6 Turbo Petrol 132 10/10 →

ASTRA J Tre volumi

1.6 Turbo Petrol 132 06/12 →

COMBO Cassone / Furgonato / Promiscuo

1.4 16V Petrol 66 08/05 →

COMBO Tour

1.4 Petrol 66 10/04 →

CORSA C (F08, F68)

1.0 Petrol 44 06/03 → 12/09

1.2 Twinport Petrol 59 07/04 → 12/09

1.4 Twinport Petrol 66 06/03 → 12/09

CORSA C Furgonato (F08, W5L)

1.2 Petrol 59 07/05 →

1.4 Petrol 66 08/03 →

CORSA D

1.0 Petrol 44 07/06 →

1.2 Petrol 59 07/06 →

1.2 LPG Petrol/LPG 59 09/09 →

1.4 Petrol 66 07/06 →

1.4 LPG Petrol/LPG 66 07/06 →

1.6 Turbo Petrol 141 02/07 →

1.6 Turbo Petrol 110 02/07 →

CORSA D Van

1.2 Petrol 59 07/09 →

INSIGNIA

1.6 Turbo Petrol 132 07/08 →

INSIGNIA Sports Tourer

1.6 Turbo Petrol 132 01/09 →

INSIGNIA Tre volumi

1.6 Turbo Petrol 132 01/09 →

MERIVA

1.4 16V Twinport Petrol 66 07/04 → 05/10

1.4 16V Twinport Petrol/LPG 66 07/04 → 05/10

1.6 Turbo Petrol 132 09/05 → 05/10

TIGRA TwinTop

1.4 Petrol 66 06/04 →

SAC092

VAUXHALL
AGILA Mk I (A)

1.0 12V	Petrol	44	02/00 → 11/06
1.2 16V Twinport	Petrol	59	07/04 → 11/06

ASTRA Mk V (H) 2 volumi /Coda spiovente

1.2	Petrol	59	08/05 → 05/09
1.4	Petrol	66	01/04 → 05/09

ASTRA Mk V (H) Sport Hatch

1.4 i 16V	Petrol	66	03/05 → 11/10
1.6	Petrol	132	10/06 → 11/10

ASTRA Mk V (H) Station wagon

1.2	Petrol	59	08/05 → 10/10
1.4	Petrol	66	08/04 → 03/09
1.6	Petrol	132	08/04 → 03/09

ASTRA TwinTop Mk V (H)

1.6	Petrol	132	10/06 → 11/10
-----	--------	-----	---------------

ASTRAVAN Mk V (H)

1.4 i	Petrol	66	03/05 →
-------	--------	----	---------

COMBO Mk II (C) Cassone / Furgonato / Promiscuo (F25)

1.4 i 16V	Petrol	66	01/04 → 11/11
-----------	--------	----	---------------

COMBO TOUR Mk II (C) (F25)

1.4	Petrol	66	10/04 → 09/10
-----	--------	----	---------------

CORSA Mk II (C) (W5L, F08)

1.0 12V	Petrol	44	11/03 → 10/06
1.2 Twinport	Petrol	59	07/04 → 10/06

CORSA Mk III (D) (L_8)

1.2	Petrol	59	11/06 →
1.2 LPG	Petrol/ LPG	59	09/09 →
1.4	Petrol	66	07/06 →
1.4 LPG	Petrol/ LPG	66	07/06 →
1.6 VXR	Petrol	141	02/07 →

CORSAVAN Mk II (C)

1.4	Petrol	66	11/03 → 06/06
1.2	Petrol	59	07/09 →

MERIVA Mk I (A)

1.4 16V Twinport	Petrol	66	01/03 → 10/09
1.6 Turbo	Petrol	132	05/06 → 06/10

TIGRA TwinTop

1.4	Petrol	66	06/04 → 08/09
-----	--------	----	---------------

SAC092

VOLVO
C30

1.8	Petrol	92	10/06 → 12/12
1.8 FlexFuel	BiFuel	92	01/07 → 12/12
2.0	Petrol	107	10/06 → 12/12
2.0 FlexFuel	BiFuel	107	01/10 → 12/12

S40 II (MS)

1.8	Petrol	92	04/04 →
1.8 FlexFuel	BiFuel	92	01/06 →
2.0	Petrol	107	10/06 →
2.0 F	BiFuel	107	10/06 →

S80 II (AS)

2.0	Petrol	107	01/08 →
2.0 FlexFuel	BiFuel	107	01/08 →

V50 (MW)

1.8	Petrol	92	04/04 →
1.8 FlexFuel	BiFuel	92	01/05 →
2.0	Petrol	107	10/06 →
2.0 FlexFuel	BiFuel	107	01/10 →

V70 III (BW)

2.0	Petrol	107	10/07 →
2.0 Flexifuel	BiFuel	107	01/08 →

SAC093
H2 **SENSORE POSIZIONE ALBERO A CAM**
CAMSHAFT POSITION SENSOR

FIAT
500 (312)

1.3 D Multijet	Diesel	55	10/07 →
----------------	--------	----	---------

DOBLO (119)

1.3 D Multijet	Diesel	62	10/05 →
----------------	--------	----	---------

DOBLO Cargo (223)

1.3 D Multijet	Diesel	55	10/05 → 01/10
1.3 JTD 16V	Diesel	51	05/04 → 12/06

SAC093



KW



FIAT

IDEA

1.3 D Multijet Diesel 66 10/05 →

1.3 JTD Diesel 51 01/04 →

LINEA (323)

1.3 D Multijet Diesel 66 06/07 →

PANDA (169)

1.3 D Multijet Diesel 51 09/03 →

1.3 D Multijet 4x4 Diesel 51 10/04 →

PUNTO (188)

1.3 JTD 16V Diesel 51 06/03 →

PUNTO / GRANDE PUNTO (199)

1.3 D Multijet Diesel 66 10/05 →

1.3 D Multijet Diesel 55 10/05 →

PUNTO Van (188AX)

1.3 JTD Diesel 51 06/03 → 10/05

STRADA Pick-up (178E)

1.3 D Multijet Diesel 62 05/06 →

LANCIA

MUSA (350)

1.3 D Multijet Diesel 51 10/04 →

1.3 D Multijet Diesel 66 09/06 →

YPSILON (843)

1.3 D Multijet Diesel 55 09/06 → 12/11

1.3 D Multijet Diesel 66 09/06 → 12/11

1.3 JTD Diesel 51 10/03 → 12/11

OPEL

AGILA (A) (H00)

1.3 CDTI Diesel 51 08/03 → 12/07

AGILA (B) (H08)

1.3 CDTI Diesel 55 04/08 →

ASTRA H (L48)

1.3 CDTI Diesel 66 08/05 →

ASTRA H GTC (L08)

1.3 CDTI Diesel 66 04/05 →

ASTRA H Station wagon (L35)

1.3 CDTI Diesel 66 08/05 →

COMBO Cassone / Furgonato / Promiscuo

1.3 CDTI 16V Diesel 51 08/05 →

1.3 CDTI 16V Diesel 55 10/05 →

COMBO Tour

1.3 CDTI 16V Diesel 51 10/04 →

1.3 CDTI 16V Diesel 55 10/05 →

CORSA C (F08, F68)

1.3 CDTI Diesel 51 06/03 → 12/09

SAC093



KW



OPEL

CORSA C Furgonato (F08, W5L)

1.3 CDTI 16V Diesel 51 08/05 →

CORSA D

1.3 CDTI Diesel 55 07/06 →

1.3 CDTI Diesel 66 07/06 →

MERIVA

1.3 CDTI Diesel 51 04/05 → 05/10

1.3 CDTI Diesel 55 09/03 → 05/10

TIGRA TwinTop

1.3 CDTI Diesel 51 06/04 →

SUZUKI

IGNIS II

1.3 DDiS Diesel 51 09/03 →

SWIFT III (MZ, EZ)

1.3 DDiS Diesel 51 08/05 →

1.3 DDiS Diesel 55 08/05 →

WAGON R+ (MM)

1.3 DDiS Diesel 51 09/03 →

VAUXHALL

AGILA Mk II (B)

1.3 CDTI Diesel 55 01/08 →

ASTRA Mk V (H) 2 volumi /Coda spiovente

1.3 CDTI Diesel 66 01/04 → 05/09

ASTRA Mk V (H) Station wagon

1.3 CDTI Diesel 66 08/04 → 03/09

COMBO Mk II (C) Cassone / Furgonato / Promiscuo (F25)

1.3 CDTI 16V Diesel 55 10/05 → 11/11

CORSA Mk II (C) (W5L, F08)

1.3 CDTI 16V Diesel 52 08/00 → 09/06

CORSA Mk III (D) (L_8)

1.3 CDTI Diesel 55 11/06 →

1.3 CDTI Diesel 66 11/06 →

CORSAVAN Mk II (C)

1.3 CDTI 16V Diesel 52 04/04 → 06/06

MERIVA Mk I (A)

1.3 CDTI Diesel 55 01/03 → 10/09

TIGRA TwinTop

1.3 CDTI Diesel 51 06/04 → 08/09

SAC094
H2 **SENSORE POSIZIONE ALBERO A CAM**
CAMSHAFT POSITION SENSOR

KW

FIAT
DOBLO (119)

1.2 (223AXA1A) Petrol 48 03/01 →

DOBLO Cargo (223)

1.2 (223ZX1A) Petrol 48 03/01 →

PANDA (141A_)

1100 Petrol 40 12/00 → 09/03

PUNTO (188)

1.2 60 (188.030, .050, .130, .150, .230, .250) Petrol 44 09/99 → 06/03

FORD
MONDEO III (B5Y)

1.8 SCi Petrol 96 06/03 → 08/07

MONDEO III Station wagon (BWY)

1.8 SCi Petrol 96 06/03 → 08/07

MONDEO III Tre volumi (B4Y)

1.8 SCi Petrol 96 06/03 → 08/07

HONDA
ACCORD VII (CL)

2.2 i-CTDi Diesel 103 01/04 →

ACCORD VII Tourer (CM)

2.2 i-CTDi Diesel 103 01/04 →

CIVIC VII Hatchback (EU, EP, EV)

1.7 CTDi Diesel 74 01/02 → 09/05

MINI
MINI (R50, R53)

One D Diesel 55 06/03 → 09/06

One D Diesel 65 06/03 → 09/06

NISSAN
MICRA II (K11)

1.0 i 16V Petrol 40 07/00 → 09/00

1.0 i 16V Petrol 44 09/00 → 02/03

1.4 i 16V Petrol 60 09/00 → 02/03

SAC094

KW

OPEL
ASTRA G 2 volumi /Coda spiovente (F48_, F08_)

1.7 CDTI Diesel 59 04/03 → 12/09

ASTRA G Station wagon (F35_)

1.7 CDTI Diesel 59 04/03 → 07/09

ASTRA G Tre volumi (F69_)

1.7 CDTI Diesel 59 04/03 → 12/09

ASTRA H (L48)

1.7 CDTI Diesel 59 03/04 →

1.7 CDTI Diesel 74 03/04 →

ASTRA H GTC (L08)

1.7 CDTI Diesel 74 03/05 →

ASTRA H Station wagon (L35)

1.7 CDTI Diesel 59 08/04 →

1.7 CDTI Diesel 74 08/04 →

PORSCHE
BOXSTER (986)

2.7 Petrol 168 07/02 → 12/04

S 3,2 Petrol 191 07/02 → 12/04

CARRERA GT

5.7 Petrol 450 10/04 → 12/06

TOYOTA
YARIS (SCP1_, NLP1_, NCP1_)

1.4 D-4D Diesel 55 12/01 → 09/05

YARIS VERSO (_NLP2_, _NCP2_)

1.4 D-4D (NLP22) Diesel 55 12/01 → 09/05

VAUXHALL
ASTRA Mk IV (G) 2 volumi /Coda spiovente

1.7 CDTI 16V Diesel 59 04/03 → 05/05

ASTRA Mk IV (G) Station wagon

1.7 CDTI 16V Diesel 59 04/03 → 05/05

ASTRA Mk IV (G) Tre volumi

1.7 CDTI 16V Diesel 59 04/03 → 05/05

ASTRA Mk V (H) 2 volumi /Coda spiovente

1.7 CDTI Diesel 59 01/04 → 05/09

1.7 CDTI Diesel 74 01/04 → 05/09

ASTRA Mk V (H) Sport Hatch

1.7 CDTI Diesel 74 02/05 → 11/10

ASTRA Mk V (H) Station wagon

1.7 CDTI Diesel 74 08/04 → 03/09

VOLVO
S60 I

2.4 D Diesel 96 12/01 → 04/10

2.4 D5 Diesel 120 07/01 → 04/10

SAC094



VOLVO

S80 I (TS, XY)

2.4 D	Diesel	96	10/01 → 07/06
2.4 D5	Diesel	120	08/01 → 07/06

V70 II (SW)

2.4 D5	Diesel	120	08/01 → 08/07
--------	--------	-----	---------------

XC70 CROSS COUNTRY

2.4 D5 XC AWD	Diesel	120	09/02 → 08/07
---------------	--------	-----	---------------

XC90 I

D5	Diesel	120	01/03 →
----	--------	-----	---------

SAC095

H2

**SENSORE POSIZIONE ALBERO A CAM
CAMSHAFT POSITION SENSOR**

ALFA ROMEO

MITO (955)

1.4 TB	Petrol	114	09/08 →
--------	--------	-----	---------

FIAT

500 (312)

1.4	Petrol	74	10/07 →
-----	--------	----	---------

BRAVO II (198)

1.4	Petrol	66	04/07 →
-----	--------	----	---------

IDEA

1.4	Petrol	57	10/05 →
-----	--------	----	---------

LINEA (323)

1.4	Petrol	57	06/07 →
-----	--------	----	---------

1.4 T-Jet	Petrol	88	09/07 →
-----------	--------	----	---------

PANDA (169)

1.1	Petrol	40	10/03 →
-----	--------	----	---------

1.2 Bi-Power / Natural Power	BiFuel	44	01/07 →
---------------------------------	--------	----	---------

SAC095



FIAT

PUNTO (188)

1.2 16V 80 (188, 233, .235, .253, .255, .333, .353, .639...)	Petrol	59	12/01 →
---	--------	----	---------

1.2 60 (188.030, .050, .130, .150, .230, .250)	Petrol	44	07/03 →
--	--------	----	---------

1.2 Natural Power	BiFuel	44	09/03 →
-------------------	--------	----	---------

PUNTO / GRANDE PUNTO (199)

1.4 Abarth	Petrol	114	12/07 →
------------	--------	-----	---------

1.4 T-Jet	Petrol	88	09/07 →
-----------	--------	----	---------

SEICENTO (187)

1.1 (187AXB, 187AXB1A)	Petrol	40	09/00 → 01/10	CHASSIS: 1219711 →
---------------------------	--------	----	---------------	--------------------

STILO (192)

1.2 16V (192_XA1B)	Petrol	59	02/02 → 12/03	CHASSIS: 819154 →
-----------------------	--------	----	---------------	-------------------

1.4 16V	Petrol	66	03/05 → 11/06
---------	--------	----	---------------

1.4 16V	Petrol	70	01/04 → 11/06
---------	--------	----	---------------

STILO Multi Wagon (192)

1.4 16V	Petrol	66	03/05 → 08/08
---------	--------	----	---------------

1.4 16V	Petrol	70	01/04 → 08/08
---------	--------	----	---------------

LANCIA

DELTA III (844)

1.4	Petrol	110	09/08 →
-----	--------	-----	---------

1.4	Petrol	88	09/08 →
-----	--------	----	---------

YPSILON (843)

1.2	Petrol	44	10/03 → 12/11
-----	--------	----	---------------

1.4	Petrol	57	10/06 → 12/11
-----	--------	----	---------------

SAC096
H2 **SENSORE POSIZIONE ALBERO A CAM**
CAMSHAFT POSITION SENSOR

CITROËN
BERLINGO (B9)

1.6 HDi 110	Diesel	80	04/08 →
1.6 HDi 75	Diesel	55	04/08 →
1.6 HDi 90	Diesel	66	04/08 →

BERLINGO (MF)

1.6 HDi 75 (MF9HW)	Diesel	55	07/05 →
1.6 HDi 90 (MF9HX)	Diesel	66	07/05 →

BERLINGO Furgonato (B9)

1.6 HDi 110	Diesel	80	04/08 →
1.6 HDi 75	Diesel	55	04/08 →
1.6 HDi 90	Diesel	66	04/08 →

BERLINGO Furgonato (M_)

1.6 HDi 75 (MB9HW)	Diesel	55	07/05 →
1.6 HDi 90 (MB9HX, MC9HX)	Diesel	66	07/05 →

C2 (JM_)

1.6 HDi	Diesel	80	09/05 →
---------	--------	----	---------

C3 I (FC_)

1.4 16V HDi	Diesel	66	02/02 →
1.6 16V HDi	Diesel	66	10/05 →
1.6 16V HDi	Diesel	80	09/05 →

C4 Coupé (LA_)

1.6 HDi	Diesel	66	11/04 →
1.6 HDi	Diesel	80	11/04 →
2.0 HDi	Diesel	100	11/04 →

C4 Grand Picasso I (UA_)

1.6 HDi	Diesel	80	10/06 →
2.0 HDi 138	Diesel	100	10/06 →

C4 I (LC_)

1.6 HDi	Diesel	66	11/04 →
1.6 HDi	Diesel	80	11/04 →

SAC096

CITROËN
C4 I (LC_)

2.0 HDi	Diesel	100	11/04 →
---------	--------	-----	---------

C4 Picasso I (UD_)

1.6 HDi	Diesel	80	02/07 →
2.0 HDi 138	Diesel	100	02/07 →

C5 II (RC_)

1.6 HDi (RC8HZB)	Diesel	80	09/04 →
------------------	--------	----	---------

C5 II Break (RE_)

1.6 HDi (RE8HZB)	Diesel	80	09/04 →
------------------	--------	----	---------

C5 III (RD_)

1.6 HDi	Diesel	80	02/08 →
2.0 HDi	Diesel	100	02/08 →
2.2 HDi	Diesel	125	02/08 →

C5 III Break (TD_)

1.6 HDi	Diesel	80	02/08 →
2.0 HDi	Diesel	100	02/08 →
2.2 HDi	Diesel	125	02/08 →

C6 (TD_)

2.2 HDi	Diesel	125	06/06 →
---------	--------	-----	---------

C8 (EA_, EB_)

2.0 HDi	Diesel	88	02/07 →
2.0 HDi 135	Diesel	100	03/06 →
2.2 HDi	Diesel	125	06/06 →

C-CROSSER (EP_)

2.2 HDi	Diesel	115	02/07 →
---------	--------	-----	---------

JUMPY

1.6 HDi 90 16V	Diesel	66	01/07 →
2.0 HDi 120	Diesel	88	01/07 →
2.0 HDi 140	Diesel	100	01/07 →

JUMPY Furgonato

2.0 HDi 120	Diesel	88	01/07 →
2.0 HDi 140	Diesel	100	01/07 →

XSARA PICASSO (N68)

1.6 HDi	Diesel	66	09/05 →
1.6 HDi	Diesel	80	05/04 →

FIAT
SCUDO (270_)

1.6 D Multijet	Diesel	66	01/07 →
2.0 D Multijet	Diesel	100	01/07 →
2.0 D Multijet	Diesel	88	01/07 →

SCUDO Furgonato (270_)

1.6 D Multijet	Diesel	66	01/07 →
2.0 D Multijet	Diesel	100	01/07 →
2.0 D Multijet	Diesel	88	01/07 →

SAC096



KW



FIAT

SCUDO Pianale piatto/Telaio (270_)

1.6 D Multijet Diesel 66 01/07 →

2.0 D Multijet Diesel 100 01/07 →

ULYSSE (179AX)

2.0 D Multijet Diesel 100 05/06 → 06/11

2.0 D Multijet Diesel 88 05/06 → 06/11

2.2 D Multijet Diesel 125 03/08 → 06/11

FORD

C-MAX (DM2)

2.0 TDCi Diesel 81 02/08 →

FIESTA V (JH_, JD_)

1.6 TDCi Diesel 66 11/04 → 06/08

FOCUS C-MAX

1.6 TDCi Diesel 80 10/03 → 03/07

2.0 TDCi Diesel 100 10/03 → 03/07

FUSION (JU_)

1.6 TDCi Diesel 66 11/04 →

GALAXY (WA6)

2.0 TDCi Diesel 103 05/06 →

2.0 TDCi Diesel 85 11/07 →

2.0 TDCi Diesel 96 05/06 →

KUGA I

2.0 TDCi Diesel 100 03/08 →

2.0 TDCi 4x4 Diesel 100 03/08 →

MONDEO IV (BA7)

2.0 TDCi Diesel 103 03/07 →

2.0 TDCi Diesel 85 11/07 →

2.0 TDCi Diesel 96 03/07 →

MONDEO IV Tre volumi (BA7)

2.0 TDCi Diesel 103 03/07 →

2.0 TDCi Diesel 85 11/07 →

2.0 TDCi Diesel 96 03/07 →

MONDEO IV Turnier (BA7)

2.0 TDCi Diesel 103 03/07 →

2.0 TDCi Diesel 85 11/07 →

2.0 TDCi Diesel 96 03/07 →

S-MAX (WA6)

2.0 TDCi Diesel 103 05/06 →

2.0 TDCi Diesel 85 11/07 →

2.0 TDCi Diesel 96 05/06 →

LANCIA

PHEDRA (179)

2.0 D Multijet Diesel 100 07/06 → 11/10

2.0 JTD Diesel 88 06/06 → 11/10

SAC096



KW



MAZDA

3 (BK)

1.6 DI Turbo Diesel 80 06/04 → 06/09

3 Tre volumi (BK)

1.6 DI Turbo Diesel 80 06/04 →

PEUGEOT

1007 (KM_)

1.6 HDi Diesel 80 06/07 →

206 2 volumi /Coda spiovente (2A/C)

1.6 HDi 110 Diesel 80 05/04 →

2.0 HDi 90 Diesel 66 12/99 →

206 CC (2D)

1.6 HDi 110 Diesel 80 04/05 →

206 SW (2E/K)

1.6 HDi 110 Diesel 80 05/04 →

2.0 HDi Diesel 66 07/02 →

207 (WA_, WC_)

1.6 HDi Diesel 66 02/06 →

1.6 HDi Diesel 80 02/06 →

207 CC (WD_)

1.6 HDi Diesel 80 02/07 →

207 SW (WK_)

1.6 HDi Diesel 80 06/07 →

1.6 HDi Diesel 66 06/07 →

307 (3A/C)

1.6 HDi Diesel 66 04/05 →

1.6 HDi 110 Diesel 80 02/04 →

307 Break (3E)

1.6 HDi Diesel 66 04/05 →

1.6 HDi 110 Diesel 80 02/04 →

307 SW (3H)

1.6 HDi 110 Diesel 80 02/04 →

308 (4A_, 4C_)

1.6 HDi Diesel 66 09/07 →

1.6 HDi Diesel 80 09/07 →

2.0 HDi Diesel 100 09/07 →

308 SW

1.6 HDi Diesel 66 09/07 →

1.6 HDi Diesel 80 09/07 →

2.0 HDi Diesel 100 09/07 →

4007 (GP_)

2.2 HDi Diesel 115 02/07 →

407 (6D_)

1.6 HDi 110 Diesel 80 05/04 →

2.0 HDi 135 Diesel 100 05/04 →

2.2 HDi 170 Diesel 125 05/06 →

SAC096

PEUGEOT
407 Coupé (6C_)

2.0 HDi Diesel 100 10/05 →

407 SW (6E_)

1.6 HDi 110 Diesel 80 05/04 →

2.0 HDi 135 Diesel 100 05/04 →

2.2 HDi 170 Diesel 125 05/06 →

607 (9D, 9U)

2.0 HDi Diesel 100 09/05 →

2.2 HDi Diesel 125 05/06 →

807 (E)

2.0 HDi Diesel 79 06/02 →

2.0 HDi Diesel 100 06/06 →

2.2 HDi Diesel 125 06/06 →

EXPERT Furgonato (VF3A_, VF3U_, VF3X_)

1.6 HDi 90 16V Diesel 66 01/07 →

2.0 HDi 120 Diesel 88 01/07 →

2.0 HDi 140 Diesel 100 01/07 →

EXPERT Pianale piatto/Telaio

1.6 HDi 90 Diesel 66 01/07 →

2.0 HDi 120 Diesel 88 01/07 →

2.0 HDi 140 Diesel 100 01/07 →

EXPERT Tepee (VF3V_)

1.6 HDi 90 16V Diesel 66 01/07 →

2.0 HDi 120 Diesel 88 01/07 →

2.0 HDi 140 Diesel 100 01/07 →

RANCH

1.6 HDi Diesel 55 04/08 →

1.6 HDi Diesel 66 04/08 →

1.6 HDi Diesel 80 04/08 →

RANCH Furgonato

1.6 HDi Diesel 55 04/08 →

1.6 HDi Diesel 66 04/08 →

1.6 HDi Diesel 80 04/08 →

RANCH Furgonato (5)

1.6 HDi 75 Diesel 55 02/06 →

1.6 HDi 90 Diesel 66 02/06 →

RANCH MPV / Space wagon (5F)

1.6 HDi 75 Diesel 55 02/06 →

1.6 HDi 90 Diesel 66 02/06 →

VOLVO
C30

1.6 D Diesel 80 10/06 → 12/12

2.0 D Diesel 100 10/06 → 12/12

C70 II Cabriolet

2.0 D Diesel 100 01/08 →

SAC096

VOLVO
S40 II (MS)

1.6 D Diesel 81 01/05 →

2.0 D Diesel 100 01/04 →

V50 (MW)

1.6 D Diesel 81 01/05 →

2.0 D Diesel 100 04/04 →

V70 III (BW)

2.0 D Diesel 100 10/07 →

SAC097
H2 **SENSORE POSIZIONE ALBERO A CAM**
CAMSHAFT POSITION SENSOR

FORD
COURIER Furgonato (J5_, J3_)

1.3 Petrol 44 02/96 → ENGINE: J4C

ESCORT VII (GAL, AAL, ABL)

1.3 Petrol 44 01/95 → 10/98 ENGINE: J6A, J4B

ESCORT VII Station wagon (GAL, ANL)

1.3 Petrol 44 01/95 → 01/99 ENGINE: J6A, J4B

ESCORT VII Tre volumi (GAL, AFL)

1.3 Petrol 44 01/95 → 02/99 ENGINE: J6A, J4B

FIESTA IV (JA_, JB_)

1.0 i Petrol 48 09/99 → 01/02

1.0 i Petrol 38 02/97 → 09/99 ENGINE: ZH10JRB

1.25 i 16V Petrol 55 08/95 → 11/99 ENGINE: DHA, DHB, DHC, DHD, DHE, DHF, DHG

1.3 i Petrol 37 08/95 → 01/02 ENGINE: JJA, JJC, JJE, JJJ, JJK, JJM

1.3 i Petrol 44 08/95 → 01/02 ENGINE: JBC, J4C, J4J, J4L, J4Q, J4R, J4T

1.6 16V Sport Petrol 76 02/00 → 01/02 ENGINE: L1T, L1V

SAC097



KW



FORD

FOCUS (DAW, DBW)

1.4 16V	Petrol	55	10/98 → 11/04	ENGINE: FXDA, FXDC, FXDB, FXDD
1.6 16V	Petrol	74	10/98 → 11/04	ENGINE: FYDA, FYDC, FYDB, FYDD, FYDH

FOCUS Station wagon (DNW)

1.4 16V	Petrol	55	02/99 → 11/04	ENGINE: FXDA, FXDC, FXDB, FXDD
1.6 16V	Petrol	74	02/99 → 11/04	ENGINE: FYDA, FYDC, FYDB, FYDD, FYDH

FOCUS Tre volumi (DFW)

1.4 16V	Petrol	55	02/99 → 11/04	ENGINE: FXDA, FXDC, FXDB, FXDD
1.6 16V	Petrol	74	02/99 → 11/04	ENGINE: FYDA, FYDC, FYDB, FYDD, FYDH

GALAXY (WGR)

2.3 16V	Petrol	103	09/01 → 05/06	ENGINE: E5SB
---------	--------	-----	---------------	--------------

KA (RB_)

1.0 i	Petrol	48	09/99 → 11/08	
1.0 i	Petrol	38	07/97 → 09/99	ENGINE: ZH10JRB
1.3 i	Petrol	36	06/98 → 11/08	ENGINE: JJD, JJF, JJG, JJH, JJJ

PUMA (EC_)

1.4 16V	Petrol	66	11/97 → 10/00	ENGINE: FHD, FHF
1.6 16V	Petrol	76	08/00 → 06/02	ENGINE: L1W

SCORPIO II (GFR, GGR)

2.0 i	Petrol	85	10/94 → 08/98	ENGINE: NSD
2.0 i 16V	Petrol	100	10/94 → 08/98	ENGINE: N3A

SCORPIO II Station wagon (GNR, GGR)

2.0 i	Petrol	85	10/94 → 08/98	ENGINE: NSD
2.0 i 16V	Petrol	100	10/94 → 08/98	ENGINE: N3A

TRANSIT Autobus (E_ _)

2.0 (EBL, EBS, ECL, EDS, EDL, EGL, ESS, ESL, EUS)	Petrol	84	09/95 → 03/00	ENGINE: NSF, NSG
2.0 CNG	Petrol/CNG	84	06/94 → 03/00	ENGINE: NSH

TRANSIT Autobus (FD_ _, FB_ _, FS_ _, FZ_ _, FC_ _)

2.0 DI (F_E_, F_F_, F_G_)	Diesel	55	08/00 → 05/06	ENGINE: D3FA
2.0 DI (F_E_, F_F_, F_G_)	Diesel	74	08/00 → 05/06	ENGINE: ABFA

SAC097



KW



FORD

TRANSIT Autobus (FD_ _, FB_ _, FS_ _, FZ_ _, FC_ _)

2.3 16V [RWD] (F_B_, F_C_, F_A_)	Petrol	107	08/00 → 05/06	ENGINE: E5FC, E5FA
2.4 DI (F_B_, F_C_, F_A_)	Diesel	66	01/00 → 05/06	ENGINE: D2FB, D2FA, D2FE
2.4 DI [RWD] (F_B_, F_C_)	Diesel	55	01/00 → 05/06	ENGINE: F4FA
2.4 DI [RWD] (F_B_, F_C_, F_A_)	Diesel	88	01/00 → 05/06	ENGINE: D4FA

TRANSIT Furgonato (E_ _)

2.0 (EAL, EAS)	Petrol	84	06/94 → 03/00	ENGINE: NSF, NSG
----------------	--------	----	---------------	------------------

TRANSIT Furgonato (FA_ _)

2.0 DI (FAE_, FAF_, FAG_)	Diesel	55	08/00 → 05/06	ENGINE: D3FA
2.0 DI (FAE_, FAF_, FAG_)	Diesel	74	08/00 → 05/06	ENGINE: ABFA
2.3 16V [RWD] (FAA_, FAB_, FAC_)	Petrol	107	04/01 → 05/06	ENGINE: E5FC, E5FA
2.4 DI (FAA_, FAB_, FAC_, FAD_)	Diesel	66	01/00 → 05/06	ENGINE: D2FB, D2FA, D2FE
2.4 DI [RWD] (FAA_, FAB_, FAC_, FAD_)	Diesel	55	01/00 → 05/06	ENGINE: F4FA
2.4 DI [RWD] (FAA_, FAB_, FAC_, FAD_)	Diesel	88	01/00 → 05/06	ENGINE: D4FA

TRANSIT Pianale piatto/Telaio (E_ _)

2.0 (EME/L/S, ENE/L/S)	Petrol	84	08/94 → 03/00	ENGINE: NSF, NSG
------------------------	--------	----	---------------	------------------

TRANSIT Pianale piatto/Telaio (FM_ _, FN_ _)

2.0 DI (F_E_, F_F_)	Diesel	55	08/00 → 05/06	ENGINE: D3FA
2.0 DI (F_E_, F_F_)	Diesel	74	08/00 → 05/06	ENGINE: ABFA
2.3 16V (F_A_, F_B_, F_C_, F_D_)	Petrol	107	04/01 → 05/06	ENGINE: E5FC, E5FA
2.4 DI (F_A_, F_B_, F_C_, F_D_)	Diesel	55	01/00 → 05/06	ENGINE: F4FA

SAC097

FORD
TRANSIT Pianale piatto/Telaio (FM_-, FN_-)

2.4 DI (F_A_, F_B_, F_C_, F_D_)	Diesel	66	01/00 → 05/06	ENGINE: D2FB,D2FA,D2FE
2.4 DI (F_A_, F_B_, F_C_, F_D_)	Diesel	88	01/00 → 05/06	ENGINE: D4FA

MAZDA
121 III (JASM, JBSM)

1.25	Petrol	55	03/96 → 04/03	ENGINE: DHF,DHG
1.3	Petrol	37	03/96 → 04/03	ENGINE: JJK,JJM
1.3	Petrol	44	03/96 → 04/03	ENGINE: J4R,J4T

SAC098
H2 **SENSORE POSIZIONE ALBERO A CAM**
CAMSHAFT POSITION SENSOR

FORD
COUGAR (EC_)

2.5 V6 24V	Petrol	125	06/00 → 12/01
------------	--------	-----	---------------

MONDEO I (GBP)

2.5 i 24V	Petrol	125	07/94 → 08/96
-----------	--------	-----	---------------

MONDEO I Station wagon (BNP)

2.5 i 24V	Petrol	125	07/94 → 08/96
-----------	--------	-----	---------------

MONDEO I Tre volumi (GBP)

2.5 i 24V	Petrol	125	07/94 → 08/96
-----------	--------	-----	---------------

MONDEO II (BAP)

2.5 ST 200	Petrol	151	05/99 → 11/00
------------	--------	-----	---------------

MONDEO II Station wagon (BNP)

2.5 24V	Petrol	125	10/99 → 11/00
---------	--------	-----	---------------

MONDEO III (B5Y)

3.0 V6 24V	Petrol	150	09/04 → 08/07
------------	--------	-----	---------------

ST220	Petrol	166	04/02 → 08/07
-------	--------	-----	---------------

SAC098

FORD
MONDEO III Station wagon (BWY)

3.0 V6 24V	Petrol	150	09/04 → 08/07
ST220	Petrol	166	04/02 → 08/07

MONDEO III Tre volumi (B4Y)

3.0 V6 24V	Petrol	150	09/04 → 08/07
ST220	Petrol	166	04/02 → 08/07

SAC099
H2 **SENSORE POSIZIONE ALBERO A CAM**
CAMSHAFT POSITION SENSOR

FORD
B-MAX

1.6 TDCi	Diesel	70	10/12 →	ENGINE: T3JB
----------	--------	----	---------	--------------

ECOSPORT

5.9 24V DIESEL AWD	Diesel	66	10/13 →	ENGINE: UGJE
--------------------	--------	----	---------	--------------

FIESTA Van

1.4 TDCi	Diesel	51	07/10 →	ENGINE: F6JD,KVJA
----------	--------	----	---------	-------------------

1.6 TDCi	Diesel	70	02/10 →	ENGINE: TZJA,TZJB
----------	--------	----	---------	-------------------

FIESTA VI

1.4 TDCi	Diesel	51	07/10 →	ENGINE: F6JD,KVJA
----------	--------	----	---------	-------------------

1.6 TDCi	Diesel	70	02/10 →	ENGINE: TZJA,TZJB,T3JA
----------	--------	----	---------	------------------------

FOCUS III Turnier

1.6 TDCi	Diesel	70	05/11 →	ENGINE: T3DA,T3DB
----------	--------	----	---------	-------------------

1.6 TDCi	Diesel	85	05/11 →	ENGINE: T1DA,T1DB
----------	--------	----	---------	-------------------

MONDEO IV Tre volumi (BA7)

1.6 TDCi	Diesel	85	12/10 →	ENGINE: T1BA,T1BB,T1BC
----------	--------	----	---------	------------------------

SAC100

H2 **SENSORE POSIZIONE ALBERO A CAM**
CAMSHAFT POSITION SENSOR



CITROËN

C1 (PM_, PN_)

1.4 HDi Diesel 40 06/05 →

C2 (JM_)

1.4 HDi Diesel 50 09/03 →

C3 I (FC_)

1.4 HDi Diesel 50 02/02 →

C3 Pluriel (HB_)

1.4 HDi Diesel 50 04/04 →

XSARA (N1)

1.4 HDi Diesel 50 01/03 → 03/05

XSARA Break (N2)

1.4 HDi Diesel 50 01/03 → 08/05

XSARA Coupé (N0)

1.4 HDi Diesel 50 01/03 → 03/05

PEUGEOT

1007 (KM_)

1.4 HDi Diesel 50 04/05 →

107

1.4 HDi Diesel 40 06/05 →

206 2 volumi /Coda spiovente (2A/C)

1.4 HDi eco 70 Diesel 50 09/01 →

206 SW (2E/K)

1.4 HDi Diesel 50 07/02 →

207 (WA_, WC_)

1.4 HDi Diesel 50 02/06 →

307 (3A/C)

1.4 HDi Diesel 50 10/01 →

307 Break (3E)

1.4 HDi Diesel 50 03/02 →

SAG015

H2 **SENSORE POSIZIONE ALBERO A CAM**
CAMSHAFT POSITION SENSOR



AUDI

A3 (8L1)

1.9 TDI Diesel 96 08/00 → 05/03

1.9 TDI Diesel 74 10/00 → 05/03

1.9 TDI quattro Diesel 96 08/00 → 05/03

FORD

GALAXY (WGR)

1.9 TDI Diesel 66 03/95 → 05/06

1.9 TDI Diesel 85 04/00 → 05/06

1.9 TDI Diesel 110 06/05 → 05/06

1.9 TDI Diesel 96 06/05 → 05/06

SEAT

ALHAMBRA (7V8, 7V9)

1.9 TDI Diesel 85 06/00 → 03/10

1.9 TDI 4motion Diesel 85 01/01 → 03/10

IBIZA IV (6L1)

1.9 TDI Cupra R Diesel 118 03/04 → 02/08

LEON (1M1)

1.9 TDI Diesel 110 02/01 → 06/06

1.9 TDI Diesel 96 05/03 → 06/06

1.9 TDI Diesel 74 10/05 → 06/06

1.9 TDI Syncro Diesel 110 05/02 → 06/06

TOLEDO II (1M2)

1.9 TDI Diesel 96 05/03 → 05/06

1.9 TDI Diesel 110 10/00 → 05/06

SKODA

FABIA (6Y2)

1.9 TDI Diesel 74 01/00 → 03/08

1.9 TDI RS Diesel 96 06/03 → 03/08

FABIA Combi (6Y5)

1.9 TDI Diesel 74 04/00 → 12/07

FABIA Tre volumi (6Y3)

1.9 TDI Diesel 74 01/00 → 12/07

SAG015

SKODA
OCTAVIA (1U2)

1.9 TDI	Diesel	96	12/02 → 09/04
1.9 TDI	Diesel	74	10/05 → 12/10

OCTAVIA Combi (1U5)

1.9 TDI	Diesel	96	12/02 → 09/04
1.9 TDI	Diesel	74	08/00 → 12/10
1.9 Tdi 4x4	Diesel	74	09/00 → 01/06

VOLKSWAGEN
BORA (1J2)

1.9 TDI	Diesel	110	05/00 → 05/05
1.9 TDI	Diesel	96	11/00 → 05/05
1.9 TDI	Diesel	85	12/98 → 01/02
1.9 TDI	Diesel	74	09/00 → 05/05
1.9 TDI 4motion	Diesel	110	05/00 → 05/05
1.9 TDI 4motion	Diesel	96	11/00 → 05/05
1.9 TDI 4motion	Diesel	85	02/99 → 06/01
1.9 TDI 4motion	Diesel	74	09/00 → 05/05

BORA Station wagon (1J6)

1.9 TDI	Diesel	110	05/01 → 05/05
1.9 TDI	Diesel	96	11/00 → 05/05
1.9 TDI	Diesel	85	05/99 → 06/01
1.9 TDI	Diesel	74	09/00 → 05/05
1.9 TDI 4motion	Diesel	110	05/01 → 05/05
1.9 TDI 4motion	Diesel	96	11/00 → 05/05
1.9 TDI 4motion	Diesel	85	05/99 → 06/01
1.9 TDI 4motion	Diesel	74	09/00 → 05/05

GOLF IV (1J1)

1.9 TDI	Diesel	110	05/00 → 06/05
1.9 TDI	Diesel	96	11/00 → 06/05
1.9 TDI	Diesel	74	09/00 → 06/05
1.9 TDI	Diesel	85	12/98 → 06/01
1.9 TDI 4motion	Diesel	110	02/00 → 06/05
1.9 TDI 4motion	Diesel	96	11/00 → 06/05
1.9 TDI 4motion	Diesel	85	09/99 → 06/01
1.9 TDI 4motion	Diesel	74	09/00 → 06/05

GOLF IV Variant (1J5)

1.9 TDI	Diesel	96	11/00 → 06/06
1.9 TDI	Diesel	85	08/99 → 06/01
1.9 TDI	Diesel	74	09/00 → 06/06
1.9 TDI 4motion	Diesel	96	11/00 → 06/06
1.9 TDI 4motion	Diesel	85	05/99 → 06/01
1.9 TDI 4motion	Diesel	74	09/00 → 06/06

MULTIVAN V (7HM, 7HN, 7HF, 7EF, 7EM, 7EN)

1.9 TDI	Diesel	77	04/03 → 11/09
---------	--------	----	---------------

SAG015

VOLKSWAGEN
NEW BEETLE (9C1, 1C1)

1.9 TDI	Diesel	77	07/05 → 09/10
1.9 TDI	Diesel	74	06/03 → 09/10

NEW BEETLE Cabriolet (1Y7)

1.9 TDI	Diesel	77	07/05 → 09/10
1.9 TDI	Diesel	74	12/04 → 09/10

SHARAN (7M8, 7M9, 7M6)

1.9 TDI	Diesel	110	06/05 → 03/10
1.9 TDI	Diesel	66	06/05 → 03/10
1.9 TDI	Diesel	85	06/05 → 03/10
1.9 TDI	Diesel	96	06/05 → 03/10
1.9 TDI 4motion	Diesel	85	06/05 → 03/10

TRANSPORTER V Autobus (7HB, 7HJ, 7EB, 7EJ, 7EF)

1.9 TDI	Diesel	63	04/03 → 11/09
1.9 TDI	Diesel	77	04/03 → 11/09

TRANSPORTER V Furgonato (7HA, 7HH, 7EA, 7EH)

1.9 TDI	Diesel	63	04/03 → 11/09
1.9 TDI	Diesel	77	04/03 → 11/09

TRANSPORTER V Pianale piatto/Telaio (7JD, 7JE, 7JL, 7JY, 7JZ)

1.9 TDI	Diesel	63	04/03 → 11/09
1.9 TDI	Diesel	77	04/03 → 11/09

SAG016
H2 **SENSORE POSIZIONE ALBERO A CAM**
CAMSHAFT POSITION SENSOR

FORD
FIESTA V (JH_, JD_)

ST150	Petrol	110	03/05 → 06/08
-------	--------	-----	---------------

FOCUS C-MAX

1.8	Petrol	88	10/03 → 03/07
1.8	Petrol	92	04/04 → 03/07
1.8 Flexifuel	Petrol/ Ethanol	92	01/06 → 03/07

SAG016



FORD

FOCUS C-MAX

2.0 Petrol 107 03/04 → 03/07

FOCUS II (DA_)

1.8 Flexifuel Petrol/Ethanol 92 01/06 →

2.0 Petrol 107 11/04 →

FOCUS II Cabriolet

2.0 Petrol 107 10/06 →

FOCUS II Station wagon (DA_)

1.8 Flexifuel Petrol/Ethanol 92 01/06 →

2.0 Petrol 107 11/04 →

FOCUS II Tre volumi (DA_)

1.8 Flexifuel Petrol/Ethanol 92 06/06 →

2.0 Petrol 107 04/05 →

MONDEO III (B5Y)

1.8 16V Petrol 81 11/00 → 08/07

1.8 16V Petrol 92 11/00 → 08/07

2.0 16V Petrol 107 11/00 → 08/07

2.0 16V DI / TDDi / TDCi Diesel 66 11/00 → 08/07

MONDEO III Station wagon (BWY)

1.8 16V Petrol 81 11/00 → 08/07

1.8 16V Petrol 92 11/00 → 08/07

2.0 16V Petrol 107 11/00 → 08/07

MONDEO III Tre volumi (B4Y)

1.8 16V Petrol 81 11/00 → 08/07

1.8 16V Petrol 92 11/00 → 08/07

2.0 16V Petrol 107 11/00 → 08/07

S-MAX (WA6)

2.0 Petrol 107 05/06 →

GRUPPO I - GROUP I

BAE403B

**BOBINA D'ACCENSIONE
IGNITION COIL**



FIAT

DOBLO (119)

1.6 Petrol 68 09/02 → ENGINE: 182B6000

1.6 16V (223AXD1A) Petrol 76 10/01 → ENGINE: 182B600

1.6 Natural Power BiFuel 76 09/02 → ENGINE: 182B6000

DOBLO Cargo (223)

1.6 16V (223ZXD1A) Petrol 76 10/01 → ENGINE: 182B600

1.6 Natural Power BiFuel 76 09/02 → ENGINE: 182B6000

PALIO Weekend (178DX)

1.6 16V (178DYC1A06) Petrol 76 02/01 → ENGINE: 182B6000

STILO (192)

1.6 16V (192_XB1A) Petrol 76 10/01 → 11/06 ENGINE: 182B600

STILO Multi Wagon (192)

1.6 16V Petrol 76 01/03 → 08/08 ENGINE: 182B600

BAE403C
**BOBINA D'ACCENSIONE
IGNITION COIL**

FIAT
BRAVO II (198)

1.4 Petrol 66 04/07 →

IDEA

1.4 16V Petrol 70 01/04 → ENGINE: 843A1000

PANDA (169)

1.4 Petrol 74 10/06 →

PUNTO (188)

1.4 Petrol 70 09/03 → ENGINE: 188A5000

PUNTO / GRANDE PUNTO (199)

1.4 16V Petrol 70 10/05 →

STILO (192)

1.2 16V (192_XA1B) Petrol 59 02/02 → 11/06 ENGINE: 188A5000

1.4 16V Petrol 70 01/04 → 11/06 ENGINE: 843A1000

STILO Multi Wagon (192)

1.4 16V Petrol 66 03/05 → 08/08

1.4 16V Petrol 70 01/04 → 08/08

LANCIA
MUSA (350)

1.4 Petrol 70 10/04 →

YPSILON (843)

1.4 16V Petrol 70 10/03 → 12/11 ENGINE: 843A1000

BAE403D
**BOBINA D'ACCENSIONE
IGNITION COIL**

FIAT
STILO (192)

2.4 20V (192_XD1A) Petrol 125 10/01 → 11/06 ENGINE: 192A2000

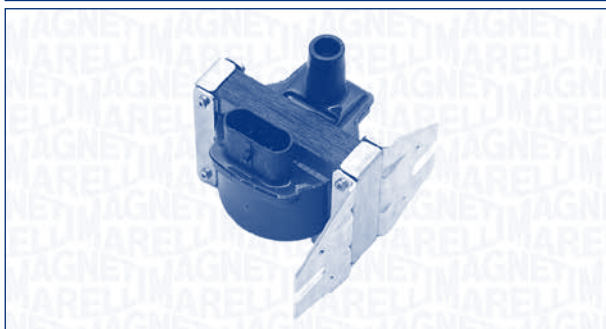
BAE504D
**BOBINA D'ACCENSIONE
IGNITION COIL**

FIAT
CROMA (154)

2000 CHT (154.AC) Petrol 66 12/85 → 02/89

2000 i.e. (154.AD) Petrol 88 03/87 → 09/92

2000 i.e. (154.AM) Petrol 83 03/86 → 09/90

2000 i.e. (154.AM, 154.LM) Petrol 85 10/87 → 12/93

FIORINO Furgonato (146)

75 i.e. 1.6 Petrol 55 10/93 → 05/01

REGATA (138)

75 i.e. 1.5 Petrol 55 07/85 → 07/89

RITMO I (138A)

75 i.e. 1.5 Petrol 55 10/85 → 05/87

BAE504D



FIAT

TEMPRA (159)

1.4 i.e. (159.AC)	Petrol	57	03/91 → 08/96
1.4 i.e. (159.AC, 159.AX)	Petrol	51	03/92 → 08/96
1.6	Petrol	63	03/90 → 04/93
1.6 i.e. (159.AE)	Petrol	57	06/90 → 07/92

TEMPRA S.W. (159)

1.4 i.e. (159.AC)	Petrol	57	03/91 → 08/96
1.4 i.e. (159.AC, 159.AX)	Petrol	51	10/92 → 08/96
1.6	Petrol	63	12/90 → 04/93
1.6 i.e. (159.AE)	Petrol	57	10/90 → 08/96

TIPO (160)

1.4 i.e. (160.AP, 160.AD, 160.EA)	Petrol	51	05/89 → 04/95
1.6 i.e.	Petrol	66	02/88 → 05/91

UNO (146A/E)

70 i.e. 1.4	Petrol	51	09/89 → 12/93
-------------	--------	----	---------------

LANCIA

DEDRA (835)

1.6 i.e. (835AB)	Petrol	57	08/89 → 03/93
------------------	--------	----	---------------

DELTA II (836)

1.4 i.e. (836AF, 836AH)	Petrol	51	10/94 → 08/99
-------------------------	--------	----	---------------

THEMA (834)

2000 i.e.	Petrol	83	03/86 → 09/88
2000 i.e. (834BV)	Petrol	85	09/87 → 05/92

Y10 (156)

1.3 i.e. Fire (156AB)	Petrol	56	11/87 → 05/93
1.3 i.e. Fire (156AF)	Petrol	53	02/89 → 12/95

BAE504F

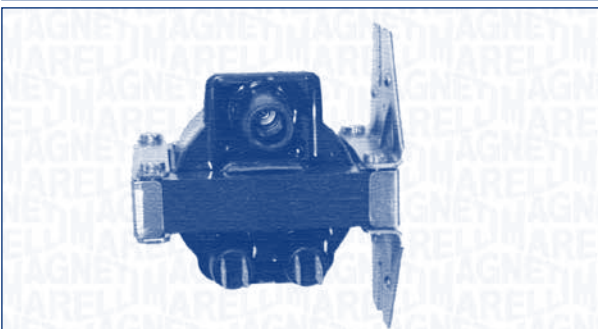
BOBINA D'ACCENSIONE
IGNITION COIL

FIAT

CROMA (154)

1600	Petrol	61	01/88 → 12/90
2000 i.e. (154.AM, 154.LM)	Petrol	85	10/87 → 08/96

DELTA I (831AB0)

1.5 (831AB.025)	Petrol	63	09/79 → 12/92
-----------------	--------	----	---------------

PRISMA (831AB0)

1.5	Petrol	63	01/83 → 04/86
-----	--------	----	---------------

MASERATI

BITURBO (70, 77)

2.24V	Petrol	180	03/89 → 12/94
4.24V	Petrol	180	04/90 → 12/94

BAE504L

BOBINA D'ACCENSIONE
IGNITION COIL

RENAULT

CLIO I (B/C57_, 5/357_)

1.2 (B/C57R)	Petrol	40	01/91 → 01/96	ENGINE: C3G700
--------------	--------	----	---------------	----------------

RAPID Furgonato (F40_, G40_)

1.2 (F406, G40A)	Petrol	40	09/91 → 03/98	ENGINE: C3G
------------------	--------	----	---------------	-------------

TWINGO I (C06_)

1.2 (C063, C064)	Petrol	40	03/93 → 10/96
------------------	--------	----	---------------

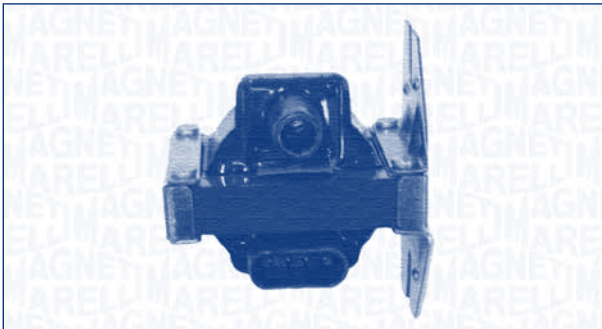
BAE506D
**BOBINA D'ACCENSIONE
IGNITION COIL**

FIAT
PANDA (141A_)

1000	Petrol	37	01/86 → 12/92
------	--------	----	---------------

TIPO (160)

1.4 (160.AC)	Petrol	52	07/87 → 12/89
--------------	--------	----	---------------

UNO (146A/E)

45 i.e. 1.0	Petrol	33	01/86 → 12/94
-------------	--------	----	---------------

50 i.e. 1.1	Petrol	36	06/92 → 12/93
-------------	--------	----	---------------

60 1.1 (146A.EG)	Petrol	43	05/85 → 08/89
------------------	--------	----	---------------

LANCIA
Y10 (156)

1.0 Fire	Petrol	37	01/86 → 02/90
----------	--------	----	---------------

1.0 Fire (156AE) Cat.	Petrol	33	10/87 → 02/92
--------------------------	--------	----	---------------

1.0 Fire (156B, 156AD)	Petrol	32	01/86 → 06/91
---------------------------	--------	----	---------------

1.0 Fire Trazione integrale	Petrol	37	12/87 → 02/90
--------------------------------	--------	----	---------------

1.0 Fire Trazione integrale (156AE)	Petrol	33	12/87 → 02/92
---	--------	----	---------------

1.1 i.e. Fire (156AG)	Petrol	37	07/89 → 09/95
--------------------------	--------	----	---------------

BAE506F
**BOBINA D'ACCENSIONE
IGNITION COIL**

FIAT
DUNA (146 B)

60 1.1	Petrol	43	01/89 → 12/91
--------	--------	----	---------------

70 1.3	Petrol	49	01/89 → 12/91
--------	--------	----	---------------

DUNA Weekend (146 B)

60 1.1	Petrol	43	01/89 → 12/91
--------	--------	----	---------------

70 1.3	Petrol	49	01/89 → 12/91
--------	--------	----	---------------

PANDA (141A_)

1000 4x4	Petrol	37	01/86 → 12/92
----------	--------	----	---------------

REGATA (138)

70 1.3	Petrol	48	01/86 → 07/89
--------	--------	----	---------------

LANCIA
DELTA I (831AB0)

1.3	Petrol	58	01/86 → 08/92
-----	--------	----	---------------

1.3 (831AB.011)	Petrol	55	01/86 → 08/92
-----------------	--------	----	---------------

PRISMA (831AB0)

1.3	Petrol	58	01/86 → 02/92
-----	--------	----	---------------

BAE507AK
**BOBINA D'ACCENSIONE
IGNITION COIL**

PEUGEOT
309 I (10C, 10A)

1.3	Petrol	47	10/85 → 07/89	ENGINE: G1A
-----	--------	----	---------------	-------------

BAE507AK



PEUGEOT

309 I (10C, 10A)

1.4	Petrol	49	03/89 → 07/89	ENGINE: TU3M(KDY,Z)
1.4	Petrol	55	03/89 → 07/89	ENGINE: TU3M(KDY,Z)
1.4	Petrol	62	03/89 → 07/89	ENGINE: TU3M(KDY,Z)

BAE507BK

**BOBINA D'ACCENSIONE
IGNITION COIL**

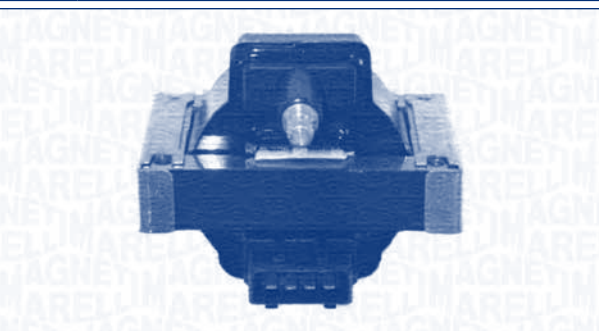

CITROËN

AX (ZA- _)

11	Petrol	44	09/86 → 12/97	ENGINE: TU1M(HDZ) H1B
14	Petrol	49	06/88 → 12/89	ENGINE: K2AK2B
14	Petrol	55	04/87 → 04/97	ENGINE: TU3M,Z(KDX,Y,Z)

XM (Y3)

2.0	Petrol	84	05/89 → 04/94	ENGINE: XU10J2(RFZ)
2.0 i	Petrol	79	05/89 → 04/94	ENGINE: XU10J2(RFZ)
2.0 i	Petrol	89	05/89 → 06/94	ENGINE: XU10J2(RFZ)

XM Break (Y3)

2.0 i	Petrol	89	11/91 → 04/94	ENGINE: XU10J2(RFZ)
2.0 i (Y3A)	Petrol	79	11/91 → 04/94	ENGINE: XU10J2(RFZ)

PEUGEOT

106 I (1A, 1C)

1.1	Petrol	44	09/91 → 04/96	ENGINE: TU1M(CDY)
1.4	Petrol	55	09/91 → 04/96	ENGINE: TU3M(KDY)-TU3MC(KDX)
1.4	Petrol	69	09/91 → 04/96	ENGINE: TU3M(KDY)-TU3MC(KDX)

BAE507BK



CITROËN

605 (6B)

2.0	Petrol	79	02/90 → 09/99	ENGINE: XU10J2Z(RFZ)
2.0	Petrol	84	06/89 → 09/99	ENGINE: XU10J2Z(RFZ)
2.0	Petrol	89	06/89 → 09/99	ENGINE: XU10J2Z(RFZ)

BAE608F

**BOBINA D'ACCENSIONE
IGNITION COIL**

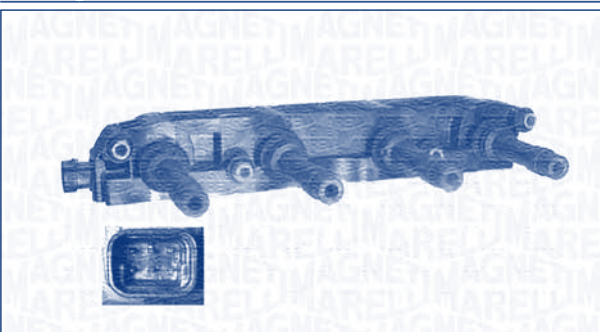

OPEL

ASTRA G 2 volumi /Coda spiovente (F48_, F08_)

1.4 16V	Petrol	66	02/98 → 01/05	ENGINE: X14XE-Z14XE
1.6 16V	Petrol	74	02/98 → 01/05	ENGINE: C16SEL-X16XEL-Z16XE

ASTRA G Cabriolet (F67)

1.6 16V	Petrol	74	03/01 → 10/05	ENGINE: C16SEL-X16XEL-Z16XE
---------	--------	----	---------------	-----------------------------

ASTRA G Station wagon (F35_)

1.4 16V	Petrol	66	06/98 → 07/04	ENGINE: X14XE-Z14XE
1.6 16V	Petrol	74	02/98 → 07/04	ENGINE: C16SEL-X16XEL-Z16XE
1.6 CNG	Petrol/CNG	71	03/03 → 07/04	ENGINE: Z16YNG

ASTRA G Tre volumi (F69_)

1.4 16V	Petrol	66	09/98 → 01/05	ENGINE: X14XE-Z14XE
1.6 16V	Petrol	74	09/98 → 01/05	ENGINE: C16SEL-X16XEL-Z16XE

CORSA C Furgonato (F08, W5L)

1.2 16V	Petrol	55	09/00 →	ENGINE: Z14XE
---------	--------	----	---------	---------------

BAE608F

OPEL
MERIVA

1.6 16V	Petrol	74	05/03 → 01/06	ENGINE: Z16XE
---------	--------	----	---------------	---------------

VECTRA B (36_)

1.6 i	Petrol	55	10/95 → 04/02	ENGINE: Z16XE-Y16XE-X16XEL
-------	--------	----	---------------	----------------------------

1.6 i	Petrol	55	10/95 → 04/02	ENGINE: Z16XE-Y16XE-X16XEL
-------	--------	----	---------------	----------------------------

VECTRA B 2 volumi /Coda spiovente (38_)

1.6 i	Petrol	55	10/95 → 07/03	ENGINE: Z16XE-Y16XE-X16XEL
-------	--------	----	---------------	----------------------------

1.6 i	Petrol	55	10/95 → 07/03	ENGINE: Z16XE-Y16XE-X16XEL
-------	--------	----	---------------	----------------------------

VECTRA B Station wagon (31_)

1.6 i	Petrol	55	11/96 → 06/00	ENGINE: Z16XE-Y16XE-X16XEL
-------	--------	----	---------------	----------------------------

VECTRA C

1.6 16V	Petrol	74	06/04 →	ENGINE: Z16XE
---------	--------	----	---------	---------------

VECTRA C GTS

1.6	Petrol	74	08/05 →	ENGINE: Z16XE
-----	--------	----	---------	---------------

VECTRA C Station wagon

1.6 16V	Petrol	74	06/04 →	ENGINE: Z16XE
---------	--------	----	---------	---------------

ZAFIRA A (F75_)

1.6 16V	Petrol	74	04/99 → 06/05	ENGINE: Z16XE-Z16XEL
---------	--------	----	---------------	----------------------

1.6 CNG	Petrol/ CNG	71	09/01 → 06/05	ENGINE: Z16YNG
---------	----------------	----	---------------	----------------

VAUXHALL
ASTRA Mk IV (G) 2 volumi /Coda spiovente

1.4 16V	Petrol	66	02/98 → 05/05	ENGINE: X14XE-Z14XE
---------	--------	----	---------------	---------------------

1.6 16V	Petrol	74	02/98 → 05/05	ENGINE: C16SEL-X16XEL-Z16XE
---------	--------	----	---------------	-----------------------------

ASTRA Mk IV (G) Station wagon

1.4 16V	Petrol	66	02/98 → 05/05	ENGINE: X14XE-Z14XE
---------	--------	----	---------------	---------------------

1.6 16V	Petrol	74	03/98 → 04/04	ENGINE: C16SEL-X16XEL-Z16XE
---------	--------	----	---------------	-----------------------------

1.6 Dualfuel	Petrol/ LPG	63	08/02 → 04/04	ENGINE: Z16YNG
--------------	----------------	----	---------------	----------------

ASTRA Mk IV (G) Tre volumi

1.4 16V	Petrol	66	09/98 → 05/05	ENGINE: X14XE-Z14XE
---------	--------	----	---------------	---------------------

1.6 16V	Petrol	74	09/98 → 05/05	ENGINE: C16SEL-X16XEL-Z16XE
---------	--------	----	---------------	-----------------------------

BAE608F

VAUXHALL
CORSA Mk II (C) (W5L, F08)

1.2 16V	Petrol	55	09/00 → 10/06	ENGINE: Z14XE
---------	--------	----	---------------	---------------

MERIVA Mk I (A)

1.6 i 16V	Petrol	74	04/03 → 09/05	ENGINE: Z16XE
-----------	--------	----	---------------	---------------

VECTRA (B)

1.6 i	Petrol	55	09/95 → 10/01	ENGINE: X16XEL-Y16XE-Z16XE
-------	--------	----	---------------	----------------------------

VECTRA (B) 2 volumi /Coda spiovente

1.6 i	Petrol	55	09/95 → 10/01	ENGINE: X16XEL-Y16XE-Z16XE
-------	--------	----	---------------	----------------------------

VECTRA (B) Station wagon

1.6 i	Petrol	55	11/96 → 03/02	ENGINE: X16XEL-Y16XE
-------	--------	----	---------------	----------------------

ZAFIRA Mk I (A) (F75)

1.6 16V	Petrol	74	04/99 → 08/05	ENGINE: X16XEL-Z16XE
---------	--------	----	---------------	----------------------

BAE608G
**BOBINA D'ACCENSIONE
IGNITION COIL**

OPEL
ASTRA G 2 volumi /Coda spiovente (F48_, F08_)

1.6	Petrol	62	09/00 → 01/05	ENGINE: Z16SE
-----	--------	----	---------------	---------------

ASTRA G Furgonato (F70)

1.6	Petrol	62	09/00 → 04/05	ENGINE: Z16SE
-----	--------	----	---------------	---------------

ASTRA G Station wagon (F35_)

1.6	Petrol	62	09/00 → 07/04	ENGINE: Z16SE
-----	--------	----	---------------	---------------

ASTRA G Tre volumi (F69_)

1.6	Petrol	62	09/00 → 01/05	ENGINE: Z16SE
-----	--------	----	---------------	---------------

COMBO Cassone / Furgonato / Promiscuo

1.6	Petrol	64	10/01 →	ENGINE: Z16SE
-----	--------	----	---------	---------------

COMBO Tour

1.6	Petrol	64	10/01 →	ENGINE: Z16SE
-----	--------	----	---------	---------------

BAE608G



OPEL

MERIVA

1.6 Petrol 64 05/03 → 05/10 ENGINE: Z16SE

VAUXHALL

ASTRA Mk IV (G) 2 volumi /Coda spiovente

1.6 Petrol 62 09/00 → 05/05 ENGINE: Z16SE

ASTRA Mk IV (G) Station wagon

1.6 Petrol 62 08/00 → 04/04 ENGINE: Z16SE

ASTRA Mk IV (G) Tre volumi

1.6 Petrol 62 09/00 → 05/05 ENGINE: Z16SE

COMBO Mk II (C) Cassone / Furgonato / Promiscuo (F25)

1.6 Petrol 64 10/01 → 11/11 ENGINE: Z16SE

MERIVA Mk I (A)

1.6 i Petrol 64 04/03 → 06/10 ENGINE: Z16SE

BAE608H

**BOBINA D'ACCENSIONE
IGNITION COIL**

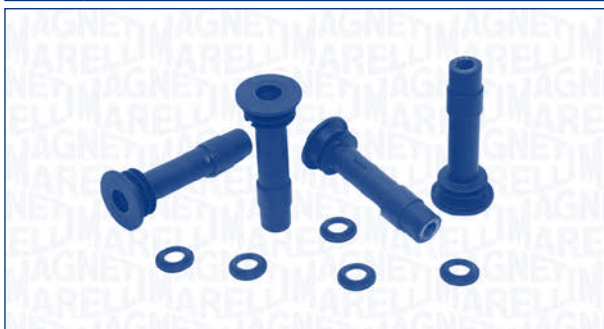

OPEL

ASTRA G 2 volumi /Coda spiovente (F48_, F08_)

1.4 16V Petrol 66 02/98 → 01/05

1.6 16V Petrol 74 02/98 → 01/05

ASTRA G Cabriolet (F67)

1.6 16V Petrol 74 03/01 → 10/05

ASTRA G Station wagon (F35_)

1.4 16V Petrol 66 06/98 → 07/04

1.6 16V Petrol 74 02/98 → 07/04

ASTRA G Tre volumi (F69_)

1.4 16V Petrol 66 09/98 → 01/05

1.6 16V Petrol 74 09/98 → 01/05

VECTRA B (36_)

1.6 i 16V Petrol 74 10/95 → 04/02

VECTRA B 2 volumi /Coda spiovente (38_)

1.6 i 16V Petrol 74 10/95 → 07/02

BAE608H



OPEL

ZAFIRA A (F75_)

1.6 16V Petrol 74 04/99 → 06/05

1.6 CNG Petrol/CNG 71 09/01 → 06/05

VAUXHALL

ASTRA Mk IV (G) 2 volumi /Coda spiovente

1.4 16V Petrol 66 02/98 → 05/05

1.6 16V Petrol 74 02/98 → 05/05

ASTRA Mk IV (G) Station wagon

1.4 16V Petrol 66 02/98 → 05/05

1.6 16V Petrol 74 03/98 → 04/04

ASTRA Mk IV (G) Tre volumi

1.4 16V Petrol 66 09/98 → 05/05

1.6 16V Petrol 74 09/98 → 05/05

VECTRA (B)

1.6 i 16V Petrol 74 09/95 → 10/01

VECTRA (B) 2 volumi /Coda spiovente

1.6 i 16V Petrol 74 09/95 → 10/01

VECTRA (B) Station wagon

1.6 i 16V Petrol 74 11/96 → 03/02

ZAFIRA Mk I (A) (F75)

1.6 16V Petrol 74 04/99 → 08/05

BAE608I

**BOBINA D'ACCENSIONE
IGNITION COIL**

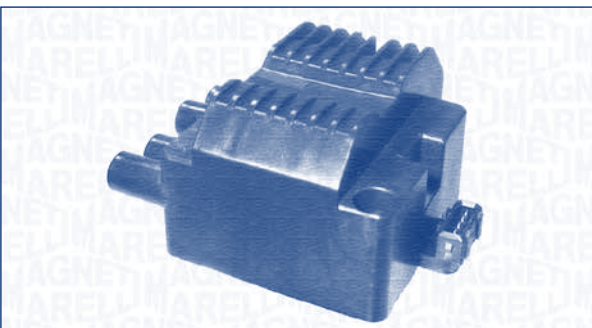

OPEL

ASTRA F (56_, 57_)

1.4 Petrol 55 09/91 → 09/93 ENGINE: 14NV

1.4 Petrol 60 09/92 → 09/98 ENGINE: 14SE-C14SE-X14NZ

1.4 i Petrol 44 09/91 → 09/98 ENGINE: C14NZ

1.4 i 16V Petrol 66 02/96 → 09/98 ENGINE: X14XE

BAE608I

OPEL
ASTRA F (56_, 57_)

1.4 Si	Petrol	60	03/92 → 09/98	ENGINE: 14SE-C14SE-X14NZ
1.6	Petrol	55	09/95 → 09/98	ENGINE: 16NZR- C16NZ-X16SZR-
1.6 i	Petrol	52	05/93 → 07/96	ENGINE: X16SZ
1.6 i	Petrol	55	03/92 → 08/94	ENGINE: 16NZR- C16NZ-X16SZR-
1.6 i	Petrol	55	08/96 → 09/98	ENGINE: 16NZR- C16NZ-X16SZR-
1.6 i 16V	Petrol	74	08/94 → 09/98	ENGINE: C16SE-X16XEL
1.6 Si	Petrol	74	05/92 → 12/94	ENGINE: C16SE-X16XEL

ASTRA F 2 volumi /Coda spiovente (53_, 54_, 58_, 59_)

1.4	Petrol	55	09/91 → 09/93	ENGINE: 14NV
1.4	Petrol	60	09/92 → 01/98	ENGINE: 14SE-C14SE-X14NZ
1.4 i	Petrol	44	03/92 → 01/98	ENGINE: C14NZ
1.4 i 16V	Petrol	66	01/96 → 01/98	ENGINE: X14XE
1.4 Si	Petrol	60	03/92 → 01/98	ENGINE: 14SE-C14SE-X14NZ
1.6 i	Petrol	52	05/93 → 07/96	ENGINE: X16SZ
1.6 i	Petrol	55	09/91 → 01/98	ENGINE: 16NZR- C16NZ-X16SZR-
1.6 i 16V	Petrol	74	08/94 → 01/98	ENGINE: C16SE-X16XEL
1.6 Si	Petrol	74	03/92 → 12/94	ENGINE: C16SE-X16XEL

ASTRA F Cabriolet (53_B)

1.4 i 16V	Petrol	66	01/96 → 03/01	ENGINE: X14XE
1.4 Si	Petrol	60	05/93 → 03/01	ENGINE: 14SE- C14SE-X14NZ
1.6 i	Petrol	52	03/93 → 08/96	ENGINE: X16SZ
1.6 i	Petrol	55	01/96 → 03/01	ENGINE: 16NZR- C16NZ-X16SZR-

ASTRA F CLASSIC 2 volumi /Coda spiovente

1.6 i	Petrol	55	01/98 → 08/02	ENGINE: X16SZR
1.6 i 16V	Petrol	74	01/98 → 08/02	ENGINE: X16XEL

ASTRA F CLASSIC Station wagon

1.6 i	Petrol	55	01/98 → 01/05	ENGINE: X16SZR
1.6 i 16V	Petrol	74	01/98 → 01/05	ENGINE: X16XEL

BAE608I

OPEL
ASTRA F CLASSIC Tre volumi

1.6 i	Petrol	55	01/98 → 08/02	ENGINE: 16NZR- C16NZ-X16SZR-
1.6 i 16V	Petrol	74	01/98 → 08/02	ENGINE: X16XEL

ASTRA F Station wagon (51_, 52_)

1.4	Petrol	55	09/91 → 09/93	ENGINE: 14NV
1.4	Petrol	60	09/92 → 01/98	ENGINE: 14SE-C14SE-X14NZ
1.4 i 16V	Petrol	66	02/96 → 01/98	ENGINE: X14XE
1.4 Si	Petrol	60	03/92 → 01/98	ENGINE: 14SE-C14SE-X14NZ
1.6	Petrol	55	09/95 → 01/98	ENGINE: 16NZR- C16NZ-X16SZR-
1.6 i	Petrol	52	05/93 → 07/96	ENGINE: X16SZ
1.6 i	Petrol	55	09/91 → 01/98	ENGINE: 16NZR- C16NZ-X16SZR-
1.6 i 16V	Petrol	74	08/94 → 01/98	ENGINE: C16SE-X16XEL
1.6 Si	Petrol	74	03/92 → 12/94	ENGINE: C16SE-X16XEL

ASTRA F Van (55_)

1.4 i	Petrol	44	10/91 → 01/99	ENGINE: C14NZ
1.6 i	Petrol	52	02/93 → 07/96	ENGINE: X16SZ
1.6 i	Petrol	55	10/91 → 04/93	ENGINE: 16NZR- C16NZ-X16SZR-

ASTRA G 2 volumi /Coda spiovente (F48_, F08_)

1.6	Petrol	55	02/98 → 09/00	ENGINE: 16NZR- C16NZ-X16SZR-
-----	--------	----	---------------	---------------------------------

COMBO (71_)

1.2	Petrol	33	07/94 → 10/01	ENGINE: X12SZ
1.4	Petrol	44	07/94 → 10/01	ENGINE: X14SZ
1.4	Petrol	60	07/94 → 10/01	ENGINE: C14SE

CORSA A 2 volumi /Coda spiovente (93_, 94_, 98_, 99_)

1.4 Si	Petrol	60	09/91 → 03/93	ENGINE: C14SE
--------	--------	----	---------------	---------------

CORSA B (73_, 78_, 79_)

1.2 i	Petrol	33	03/93 → 09/00	ENGINE: X12SZ
1.2 i	Petrol	33	03/93 → 09/00	ENGINE: X12SZ
1.4 i	Petrol	44	03/93 → 09/00	ENGINE: X14SZ
1.4 i 16V	Petrol	63	08/97 → 09/00	ENGINE: C14SEL
1.4 i 16V	Petrol	66	09/94 → 09/00	ENGINE: X14XE
1.6 i 16V	Petrol	74	08/97 → 09/00	ENGINE: C16SEL-X16XE
1.6 i 16V	Petrol	78	09/94 → 09/00	ENGINE: C16XE

CORSA B Furgonato (73_)

1.4 i	Petrol	44	08/99 → 09/00	ENGINE: X14SZ
-------	--------	----	---------------	---------------

BAE608I



KW



OPEL

TIGRA (95_)

1.4 16V	Petrol	63	08/97 → 12/00	ENGINE: C14SEL
1.4 16V	Petrol	66	07/94 → 12/00	ENGINE: X14XE
1.6 16V	Petrol	74	08/97 → 08/98	ENGINE: C16SEL
1.6 16V	Petrol	78	07/94 → 08/98	ENGINE: X16XE

VECTRA A (86_, 87_)

1.6 i	Petrol	52	09/93 → 11/95	ENGINE: X16SZ
-------	--------	----	---------------	---------------

VECTRA B (36_)

1.6 i	Petrol	55	10/95 → 04/02	ENGINE: X16SZR-X16XEL
1.6 i	Petrol	55	10/95 → 04/02	ENGINE: X16SZR-X16XEL

VECTRA B 2 volumi /Coda spiovente (38_)

1.6 i	Petrol	55	10/95 → 07/03	ENGINE: X16SZR-X16XEL
1.6 i	Petrol	55	10/95 → 07/03	ENGINE: 16SZR-X16XEL

VECTRA B Station wagon (31_)

1.6 i	Petrol	55	11/96 → 06/00	ENGINE: X16SZR-X16XEL
-------	--------	----	---------------	--------------------------

VAUXHALL

ASTRA Mk III (F)

1.4 i	Petrol	44	04/92 → 09/98	ENGINE: C14NZ
1.4 i	Petrol	60	04/92 → 09/98	ENGINE: 14SE- C14SE-X14NZ
1.4 i 16V	Petrol	66	02/96 → 09/98	ENGINE: X14XE
1.6 i	Petrol	52	08/94 → 07/96	ENGINE: X16SZ
1.6 i	Petrol	55	03/92 → 09/98	ENGINE: 16NZR- C16NZ
1.6 i	Petrol	74	05/92 → 12/94	ENGINE: C16SE
1.6 i 16V	Petrol	74	08/94 → 09/98	ENGINE: X16XEL

ASTRA Mk III (F) 2 volumi /Coda spiovente

1.4 i	Petrol	44	09/91 → 02/98	ENGINE: C14NZ
1.4 i 16V	Petrol	66	02/96 → 02/98	ENGINE: X14XE
1.4 S	Petrol	55	09/91 → 02/98	ENGINE: 14NV
1.6 i	Petrol	52	07/94 → 02/98	ENGINE: X16SZ
1.6 i	Petrol	55	09/91 → 02/98	ENGINE: C16SE
1.6 i	Petrol	74	03/92 → 02/98	ENGINE: C16SE

ASTRA Mk III (F) Station wagon

1.4 i	Petrol	44	09/91 → 02/98	ENGINE: C14NZ
1.4 i	Petrol	60	03/91 → 02/98	ENGINE: 14SE- C14SE-X14NZ
1.4 i 16V	Petrol	66	02/96 → 01/98	ENGINE: X14XE
1.4 S	Petrol	55	09/91 → 02/98	ENGINE: 14NV
1.6 i	Petrol	52	07/94 → 02/98	ENGINE: X16SZ

BAE608I



KW



VAUXHALL

ASTRA Mk III (F) Station wagon

1.6 i	Petrol	55	09/91 → 02/98	ENGINE: C16SE
1.6 i 16V	Petrol	74	01/94 → 02/98	ENGINE: X16XEL
1.6 Si	Petrol	74	03/91 → 12/94	ENGINE: C16SE

ASTRA Mk IV (G) 2 volumi /Coda spiovente

1.6	Petrol	55	02/98 → 09/00	ENGINE: X16SZR
-----	--------	----	---------------	----------------

ASTRA Mk IV (G) Station wagon

1.6	Petrol	55	03/98 → 09/00	ENGINE: X16SZR
-----	--------	----	---------------	----------------

ASTRA Mk IV (G) Tre volumi

1.6	Petrol	55	09/98 → 09/00	ENGINE: X16SZR
-----	--------	----	---------------	----------------

ASTRAVAN Mk III (F)

1.6 i	Petrol	55	01/91 → 08/98	ENGINE: C16SE
-------	--------	----	---------------	---------------

ASTRAVAN Mk IV (G)

1.6 i	Petrol	55	08/98 → 09/00	ENGINE: X16SZR
-------	--------	----	---------------	----------------

CAVALIER Mk III (87)

1.6 i	Petrol	52	09/93 → 11/95	ENGINE: X16SZ
-------	--------	----	---------------	---------------

CAVALIER Mk III 2 volumi /Coda spiovente

1.6 i	Petrol	52	09/93 → 11/95	ENGINE: X16SZ
-------	--------	----	---------------	---------------

CORSAVAN Mk I (B)

1.4 i	Petrol	44	01/94 → 09/00	ENGINE: X14SZ
-------	--------	----	---------------	---------------

NOVA 2 volumi /Coda spiovente

1.6 GSI	Petrol	74	05/88 → 03/92	ENGINE: E16SE
---------	--------	----	---------------	---------------

TIGRA Mk I (F07)

1.4 16V	Petrol	66	07/94 → 12/00	ENGINE: X14XE
1.6 16V	Petrol	78	07/94 → 12/00	ENGINE: X16XE

VECTRA (B)

1.6 i	Petrol	55	09/95 → 10/01	ENGINE: X16SZR-X16XEL
-------	--------	----	---------------	--------------------------

VECTRA (B) 2 volumi /Coda spiovente

1.6 i	Petrol	55	09/95 → 10/01	ENGINE: X16SZR-X16XEL
-------	--------	----	---------------	--------------------------

VECTRA (B) Station wagon

1.6 i	Petrol	55	11/96 → 03/02	ENGINE: X16SZR-X16XEL
-------	--------	----	---------------	--------------------------

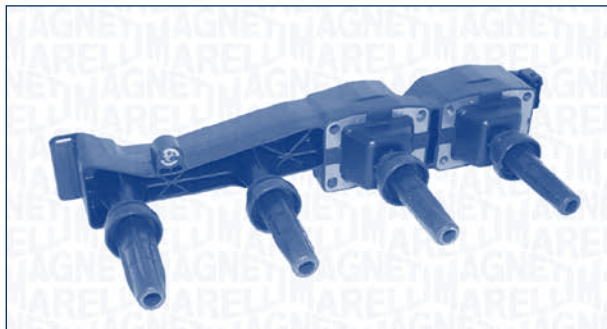
BAE608L
**BOBINA D'ACCENSIONE
IGNITION COIL**

OPEL
ASTRA F CLASSIC Station wagon

1.6 i 16V	Petrol	74	02/04 → 01/05	ENGINE: Z16XEP
-----------	--------	----	---------------	----------------

ASTRA G 2 volumi /Coda spiovente (F48_, F08_)

1.6 16V	Petrol	74	03/00 → 01/05	ENGINE: Z16XEP
---------	--------	----	---------------	----------------

ASTRA G Cabriolet (F67)

1.6 16V	Petrol	74	03/01 → 10/05	ENGINE: Z16XEP
---------	--------	----	---------------	----------------

ASTRA G Coupé (F07_)

1.6 16V	Petrol	76	03/00 → 05/05	ENGINE: Z16XEP
---------	--------	----	---------------	----------------

ASTRA G Station wagon (F35_)

1.6 16V	Petrol	74	03/00 → 07/04	ENGINE: Z16XEP
---------	--------	----	---------------	----------------

ASTRA G Tre volumi (F69_)

1.6 16V	Petrol	74	09/98 → 01/05	ENGINE: Z16XEP
---------	--------	----	---------------	----------------

ASTRA H (L48)

1.6	Petrol	77	03/04 →	ENGINE: Z16XEP
-----	--------	----	---------	----------------

ASTRA H GTC (L08)

1.6	Petrol	77	03/05 →	ENGINE: Z16XEP
-----	--------	----	---------	----------------

ASTRA H Station wagon (L35)

1.6	Petrol	77	08/04 →	ENGINE: Z16XEP
-----	--------	----	---------	----------------

ASTRA H TwinTop (L67)

1.6	Petrol	77	09/05 →	ENGINE: Z16XEP
-----	--------	----	---------	----------------

ZAFIRA B (A05)

1.6	Petrol	77	07/05 →	ENGINE: Z16XEP
-----	--------	----	---------	----------------

1.8	Petrol	103	07/05 →	ENGINE: Z18XER
-----	--------	-----	---------	----------------

VAUXHALL
ASTRA Mk IV (G) 2 volumi /Coda spiovente

1.6 16V	Petrol	74	03/00 → 05/05	ENGINE: Z16XEP
---------	--------	----	---------------	----------------

ASTRA Mk IV (G) Cabriolet

1.6 16V	Petrol	74	03/01 → 10/05	ENGINE: Z16XEP
---------	--------	----	---------------	----------------

ASTRA Mk IV (G) Station wagon

1.6 16V	Petrol	74	03/00 → 04/04	ENGINE: Z16XEP
---------	--------	----	---------------	----------------

ASTRA Mk IV (G) Tre volumi

1.6 16V	Petrol	74	03/00 → 05/05	ENGINE: Z16XEP
---------	--------	----	---------------	----------------

ASTRA Mk V (H) 2 volumi /Coda spiovente

1.6	Petrol	77	02/04 → 05/09	ENGINE: Z16XEP
-----	--------	----	---------------	----------------

BAE608L

VAUXHALL
ASTRA Mk V (H) Sport Hatch

1.6	Petrol	77	02/05 → 11/10	ENGINE: Z16XEP
-----	--------	----	---------------	----------------

ASTRA Mk V (H) Station wagon

1.6	Petrol	77	08/04 → 03/09	ENGINE: Z16XEP
-----	--------	----	---------------	----------------

ZAFIRA Mk II (B) (M75)

1.6	Petrol	77	07/05 →	ENGINE: Z16XEP
-----	--------	----	---------	----------------

1.8	Petrol	103	04/05 →	ENGINE: Z18XER
-----	--------	-----	---------	----------------

BAE608M
**BOBINA D'ACCENSIONE
IGNITION COIL**

DAEWOO
LANOS (KLAT)

1.4	Petrol	55	05/97 →	ENGINE: A14SMS
-----	--------	----	---------	----------------

1.5	Petrol	63	05/97 →	ENGINE: A15SMS
-----	--------	----	---------	----------------

1.6 16V	Petrol	78	05/97 →	ENGINE: A16DMS
---------	--------	----	---------	----------------

LANOS Tre volumi (KLAT)

1.4	Petrol	55	05/97 →	ENGINE: A14SMS
-----	--------	----	---------	----------------

1.5	Petrol	63	05/97 →	ENGINE: A15SMS
-----	--------	----	---------	----------------

1.6 16V	Petrol	78	05/97 →	ENGINE: A16DMS
---------	--------	----	---------	----------------

LEGANZA (KLAV)

2.0 16V	Petrol	98	06/97 → 12/02	ENGINE: X20SED
---------	--------	----	---------------	----------------

2.2 16V	Petrol	100	04/99 → 12/02	ENGINE: T22SED
---------	--------	-----	---------------	----------------

NUBIRA (KLAJ)

1.6 16V	Petrol	78	05/97 →	ENGINE: A16DMS
---------	--------	----	---------	----------------

2.0 16V	Petrol	98	05/97 →	ENGINE: X20SED
---------	--------	----	---------	----------------

NUBIRA Tre volumi (KLAJ)

1.6 16V	Petrol	78	05/97 →	ENGINE: A16DMS
---------	--------	----	---------	----------------

2.0 16V	Petrol	98	05/97 →	ENGINE: X20SED
---------	--------	----	---------	----------------

NUBIRA Wagon (KLAJ)

1.6 16V	Petrol	78	05/97 →	ENGINE: A16DMS
---------	--------	----	---------	----------------

2.0 16V	Petrol	98	05/97 →	ENGINE: X20SED
---------	--------	----	---------	----------------

BAE608M



KW



OPEL

FRONTERA B (6B_)

2.2 i (6B_ZC, 6B_VF, 6B_66, 6B_76)	Petrol	100	10/98 →	ENGINE: X22SE-Y22SE
------------------------------------	--------	-----	---------	---------------------

VAUXHALL

FRONTERA Mk II (B)

2.2 i	Petrol	100	10/98 → 10/04	ENGINE: X22SE-Y22SE
-------	--------	-----	---------------	---------------------

BAE608N

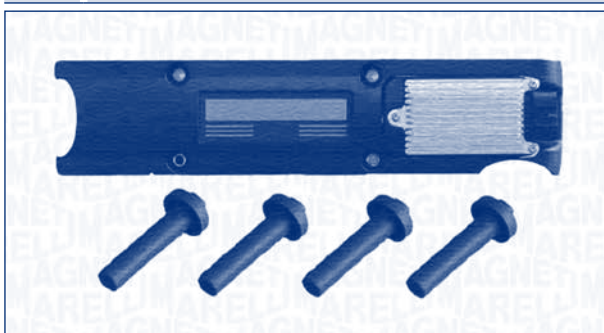
BOBINA D'ACCENSIONE
IGNITION COIL

KW



FIAT

CROMA (194)

2.2 16V	Petrol	108	06/05 →	
---------	--------	-----	---------	--

OPEL

ASTRA G 2 volumi /Coda spiovente (F48_, F08_)

2.2 16V	Petrol	108	06/00 → 01/05	ENGINE: Z22SE
---------	--------	-----	---------------	---------------

ASTRA G Cabriolet (F67)

2.2 16V	Petrol	108	03/01 → 10/05	ENGINE: Z22SE
---------	--------	-----	---------------	---------------

ASTRA G Coupé (F07_)

2.2 16V	Petrol	108	09/00 → 05/05	ENGINE: Z22SE
---------	--------	-----	---------------	---------------

ASTRA G Station wagon (F35_)

2.2 16V	Petrol	108	03/01 → 07/04	ENGINE: Z22SE
---------	--------	-----	---------------	---------------

ASTRA G Tre volumi (F69_)

2.2 16V	Petrol	108	03/01 → 01/05	ENGINE: Z22SE
---------	--------	-----	---------------	---------------

SPEEDSTER

2.2	Petrol	108	09/00 →	ENGINE: Z22SE
-----	--------	-----	---------	---------------

VECTRA B (36_)

2.2 i 16V	Petrol	108	09/00 → 04/02	ENGINE: Z22SE
-----------	--------	-----	---------------	---------------

VECTRA B 2 volumi /Coda spiovente (38_)

2.2 i 16V	Petrol	108	09/00 → 07/03	ENGINE: Z22SE
-----------	--------	-----	---------------	---------------

BAE608N



KW



OPEL

VECTRA B Station wagon (31_)

2.2 i 16V	Petrol	108	09/00 → 07/03	ENGINE: Z22SE
-----------	--------	-----	---------------	---------------

VECTRA C

2.2 16V	Petrol	108	04/02 →	ENGINE: Z22SE
---------	--------	-----	---------	---------------

2.2 direct	Petrol	114	10/03 →	ENGINE: Z22SE
------------	--------	-----	---------	---------------

VECTRA C GTS

2.2 16V	Petrol	108	08/02 →	ENGINE: Z22SE
---------	--------	-----	---------	---------------

2.2 direct	Petrol	114	10/03 →	ENGINE: Z22SE
------------	--------	-----	---------	---------------

VECTRA C Station wagon

2.2 direct	Petrol	114	10/03 →	ENGINE: Z22SE
------------	--------	-----	---------	---------------

ZAFIRA A (F75_)

2.2 16V	Petrol	108	09/00 → 06/05	ENGINE: Z22SE
---------	--------	-----	---------------	---------------

VAUXHALL

ASTRA Mk IV (G) 2 volumi /Coda spiovente

2.2 16V	Petrol	108	03/01 → 05/05	ENGINE: Z22SE
---------	--------	-----	---------------	---------------

ASTRA Mk IV (G) Coupé (F67)

2.2 16V	Petrol	108	03/00 → 08/05	ENGINE: Z22SE
---------	--------	-----	---------------	---------------

ASTRA Mk IV (G) Station wagon

2.2 16V	Petrol	108	03/01 → 05/05	ENGINE: Z22SE
---------	--------	-----	---------------	---------------

ASTRA Mk IV (G) Tre volumi

2.2 16V	Petrol	108	03/01 → 05/05	ENGINE: Z22SE
---------	--------	-----	---------------	---------------

VECTRA (B)

2.2 i 16V	Petrol	108	08/00 → 10/01	ENGINE: Z22SE
-----------	--------	-----	---------------	---------------

VECTRA (B) 2 volumi /Coda spiovente

2.2 i 16V	Petrol	108	09/00 → 07/03	ENGINE: Z22SE
-----------	--------	-----	---------------	---------------

VECTRA (B) Station wagon

2.2 i 16V	Petrol	108	08/00 → 10/01	ENGINE: Z22SE
-----------	--------	-----	---------------	---------------

VECTRA Mk II (C)

2.2 16V	Petrol	108	03/02 → 10/08	ENGINE: Z22SE
---------	--------	-----	---------------	---------------

2.2 direct	Petrol	114	09/03 → 10/08	ENGINE: Z22SE
------------	--------	-----	---------------	---------------

VECTRA Mk II (C) GTS

2.2 16V	Petrol	108	08/02 → 07/08	ENGINE: Z22SE
---------	--------	-----	---------------	---------------

2.2 direct	Petrol	114	10/03 → 08/05	ENGINE: Z22SE
------------	--------	-----	---------------	---------------

VECTRA Mk II (C) Station wagon

2.2 direct	Petrol	114	10/03 → 07/08	ENGINE: Z22SE
------------	--------	-----	---------------	---------------

ZAFIRA Mk I (A) (F75)

2.2 16V	Petrol	108	08/00 → 08/04	ENGINE: Z22SE
---------	--------	-----	---------------	---------------

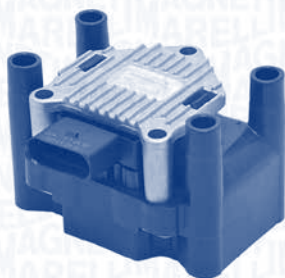
BAE680AA
**BOBINA D'ACCENSIONE
IGNITION COIL**

KW

AUDI
A2 (8Z0)

1.4	Petrol	55	02/00 → 08/05
-----	--------	----	---------------

A4 (8D2, B5)

1.6	Petrol	74	11/94 → 10/00
-----	--------	----	---------------

SEAT
ALTEA (5P1)

1.6	Petrol	75	03/04 →
-----	--------	----	---------

CORDOBA (6K1, 6K2)

1.0 i	Petrol	37	09/96 → 06/99
-------	--------	----	---------------

1.4 i	Petrol	44	06/94 → 06/99
-------	--------	----	---------------

1.6 i	Petrol	55	05/94 → 06/99
-------	--------	----	---------------

2.0 i	Petrol	85	02/93 → 06/99
-------	--------	----	---------------

IBIZA III (6K1)

1.0	Petrol	37	08/99 → 02/02
-----	--------	----	---------------

1.4 16V	Petrol	55	05/00 → 02/02
---------	--------	----	---------------

1.6	Petrol	74	08/99 → 02/02
-----	--------	----	---------------

IBIZA IV (6L1)

1.6	Petrol	74	02/03 → 11/09
-----	--------	----	---------------

LEON (1M1)

1.4 16V	Petrol	55	11/99 → 06/06
---------	--------	----	---------------

1.6 16 V	Petrol	77	09/00 → 06/06
----------	--------	----	---------------

1.8 20V	Petrol	92	11/99 → 06/06
---------	--------	----	---------------

TOLEDO II (1M2)

1.4 16V	Petrol	55	07/99 → 05/06
---------	--------	----	---------------

1.6	Petrol	74	04/99 → 09/00
-----	--------	----	---------------

1.8 20V	Petrol	92	04/99 → 05/06
---------	--------	----	---------------

SKODA
FABIA (6Y2)

1.4 16V	Petrol	55	12/99 → 03/08
---------	--------	----	---------------

2.0	Petrol	85	12/99 → 03/08
-----	--------	----	---------------

OCTAVIA (1U2)

1.4	Petrol	44	04/99 → 03/01
-----	--------	----	---------------

2.0	Petrol	85	04/99 → 05/07
-----	--------	----	---------------

BAE680AA

KW

SKODA
SUPERB (3U4)

2.0	Petrol	85	12/01 → 03/08
-----	--------	----	---------------

VOLKSWAGEN
BORA (1J2)

1.4 16V	Petrol	55	03/00 → 05/05
---------	--------	----	---------------

BORA (1J2)

1.6	Petrol	75	08/00 → 05/05
-----	--------	----	---------------

1.6	Petrol	74	10/98 → 05/05
-----	--------	----	---------------

1.8	Petrol	92	10/98 → 05/05
-----	--------	----	---------------

CADDY II Furgonato (9K9A)

60 1.4	Petrol	44	11/95 → 01/04
--------	--------	----	---------------

CADDY II Station wagon (9K9B)

1.6	Petrol	55	11/95 → 05/97
-----	--------	----	---------------

GOLF IV (1J1)

1.4 16V	Petrol	55	08/97 → 06/05
---------	--------	----	---------------

1.6 16V	Petrol	77	02/00 → 06/05
---------	--------	----	---------------

1.8	Petrol	92	08/97 → 06/05
-----	--------	----	---------------

LUPO (6X1, 6E1)

1.0	Petrol	37	09/98 → 07/05
-----	--------	----	---------------

1.4 16V	Petrol	55	09/98 → 07/05
---------	--------	----	---------------

1.6 GTI	Petrol	92	09/00 → 07/05
---------	--------	----	---------------

NEW BEETLE (9C1, 1C1)

1.6	Petrol	74	10/99 → 09/00
-----	--------	----	---------------

PASSAT (3B2)

2.0	Petrol	88	04/00 → 11/00
-----	--------	----	---------------

POLO (6N2)

1.0	Petrol	37	10/99 → 09/01
-----	--------	----	---------------

1.4	Petrol	44	10/99 → 09/01
-----	--------	----	---------------

1.6 16V GTI	Petrol	92	10/99 → 09/01
-------------	--------	----	---------------

SHARAN (7M8, 7M9, 7M6)

2.0	Petrol	85	09/95 → 03/10
-----	--------	----	---------------

TOURAN (1T1, 1T2)

1.6	Petrol	75	07/03 → 05/10
-----	--------	----	---------------

TRANSPORTER V Autobus (7HB, 7HJ, 7EB, 7EJ, 7EF)

2.0	Petrol	85	11/03 →
-----	--------	----	---------

BAE680AB

**BOBINA D'ACCENSIONE
IGNITION COIL**

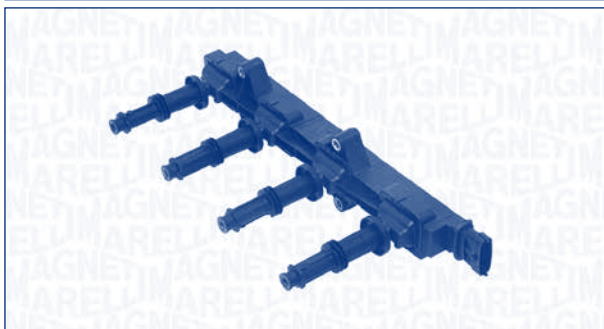

BMW

3 (E36)

316 i	Petrol	75	09/93 → 02/98
318 i	Petrol	85	10/93 → 02/98
318 is	Petrol	103	10/93 → 12/96
318 is	Petrol	103	09/95 → 02/98

3 (E46)

316 i	Petrol	77	04/00 → 09/02
316 i	Petrol	77	09/98 → 09/02
318 i	Petrol	87	04/98 → 09/01

3 Cabriolet (E36)

318 i	Petrol	85	01/94 → 04/99
-------	--------	----	---------------

3 Compact (E36)

316 g	BiFuel	75	03/94 → 08/00
316 i	Petrol	77	12/98 → 08/00
316 i	Petrol	75	03/94 → 08/00
318 ti	Petrol	103	11/94 → 08/95
318 ti	Petrol	103	12/95 → 08/00

3 Coupé (E36)

316 i	Petrol	75	09/93 → 04/99
318 is	Petrol	103	03/92 → 10/95
318 is	Petrol	103	09/95 → 04/99

3 Coupé (E46)

316 Ci	Petrol	77	04/00 → 09/02
318 Ci	Petrol	87	11/99 → 09/01

3 Touring (E36)

316 i	Petrol	75	01/96 → 10/99
318 i	Petrol	85	07/95 → 10/99

3 Touring (E46)

318 i	Petrol	87	10/99 → 09/01
318 i	Petrol	85	10/99 → 09/01

5 (E34)

518 i	Petrol	85	09/90 → 09/95
-------	--------	----	---------------

BAE680AB



BMW

5 Touring (E34)

518 g	BiFuel	85	11/95 → 06/96
518 i	Petrol	85	09/94 → 12/96

Z3 (E36)

1.8	Petrol	85	10/95 → 10/98
1.9	Petrol	103	10/95 → 03/99
1.9	Petrol	85	01/99 → 09/02
1.9	Petrol	87	09/98 → 09/02

BAE680AC

**BOBINA D'ACCENSIONE
IGNITION COIL**

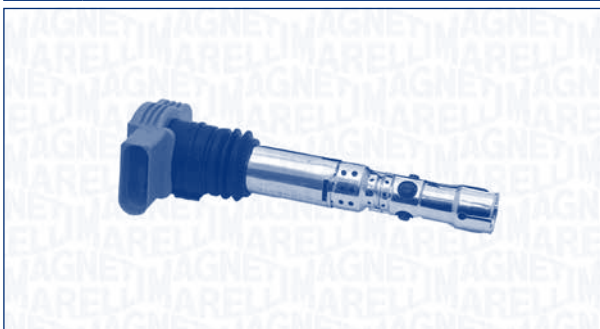

AUDI

A4 (8E2, B6)

3.0	Petrol	162	11/00 → 12/04
-----	--------	-----	---------------

A4 Cabriolet (8H7, B6, 8HE, B7)

2.0	Petrol	96	09/04 → 12/05
3.0 quattro	Petrol	162	05/03 → 12/05

A6 (4B2, C5)

3.0	Petrol	162	08/01 → 01/05
-----	--------	-----	---------------

A6 Avant (4B5, C5)

3.0	Petrol	162	08/01 → 01/05
-----	--------	-----	---------------

A8 (4E_)

3.0	Petrol	160	07/03 → 05/06
-----	--------	-----	---------------

BAE680AE
**BOBINA D'ACCENSIONE
IGNITION COIL**

FORD
ESCORT VII (GAL, AAL, ABL)

1.3	Petrol	44	01/95 → 10/98
1.4	Petrol	55	01/95 → 10/98
1.6 16V	Petrol	66	01/95 → 10/98
1.8 16V	Petrol	85	01/95 → 10/98

FIESTA III (GFJ)

1.1	Petrol	37	03/89 → 12/95
1.4	Petrol	52	03/89 → 12/95
1.6 i 16V	Petrol	65	01/94 → 12/95
1.8 16V	Petrol	77	02/92 → 12/95

FIESTA IV (JA_, JB_)

1.25 i 16V	Petrol	55	08/95 → 01/02
1.3 i	Petrol	37	08/95 → 01/02

KA (RB_)

1.3 i	Petrol	36	06/98 → 11/08
-------	--------	----	---------------

MONDEO I (GBP)

1.6 i 16V	Petrol	65	07/94 → 08/96
1.8 i 16V	Petrol	82	07/94 → 08/96
2.0 i 16V	Petrol	97	12/94 → 08/96

ORION III (GAL)

1.6 i 16V	Petrol	66	07/92 → 12/93
1.8 i 16V	Petrol	77	02/92 → 12/93

PUMA (EC_)

1.4 16V	Petrol	66	11/97 → 10/00
---------	--------	----	---------------

TOURNEO CONNECT

1.8 16V	Petrol	85	06/02 →
---------	--------	----	---------

MAZDA
121 III (JASM, JBMS)

1.3	Petrol	37	03/96 → 04/03
-----	--------	----	---------------

BAE680AF
**BOBINA D'ACCENSIONE
IGNITION COIL**

CITROËN
BX Break (XB-_)

16	Petrol	65	07/94 → 12/94
----	--------	----	---------------

JUMPER Autobus (230P)

2.0	Petrol	80	02/94 → 02/02
-----	--------	----	---------------

JUMPER Autobus (244, Z_)

2.0	Petrol	81	04/02 → 05/06
2.0 bivalent	Petrol/ CNG	81	02/03 → 05/06

JUMPER Furgonato (230L)

2.0	Petrol	80	03/94 → 02/02
2.0 4x4	Petrol	80	10/96 → 01/02

JUMPER Furgonato (244)

2.0	Petrol	81	04/02 → 05/06
2.0 bivalent	Petrol/ CNG	81	02/03 → 05/06

JUMPER Pianale piatto/Telaio (230)

2.0	Petrol	80	03/94 → 02/02
-----	--------	----	---------------

SAXO (S0, S1)

1.0 X	Petrol	37	05/98 → 06/03
1.1 X,SX	Petrol	44	05/96 → 09/03
1.6	Petrol	66	02/96 → 06/03

XANTIA (X1)

1.6 i	Petrol	65	03/93 → 01/98
1.8 i	Petrol	66	04/97 → 01/98
1.8 i	Petrol	74	03/93 → 01/98
2.0 i	Petrol	89	03/93 → 01/98
2.0 Turbo	Petrol	108	06/95 → 01/98

XANTIA (X2)

1.8 i	Petrol	66	01/98 → 12/01
2.0 i	Petrol	89	01/98 → 12/01
2.0 Turbo	Petrol	108	01/98 → 12/01

BAE680AF



KW



CITROËN

XANTIA Break (X1)

1.8 i	Petrol	66	04/97 → 01/98
1.8 i	Petrol	74	09/95 → 01/98
2.0 i	Petrol	89	09/95 → 01/98
2.0 Turbo	Petrol	108	09/95 → 01/98

XANTIA Break (X2)

1.8 i	Petrol	66	01/98 → 12/01
2.0 i	Petrol	89	01/98 → 12/01
2.0 Turbo	Petrol	108	01/98 → 12/01

XM (Y4)

2.0 Turbo	Petrol	108	07/94 → 09/95
-----------	--------	-----	---------------

XSARA (N1)

1.4 i	Petrol	55	07/97 → 06/98
1.6 i	Petrol	65	07/97 → 06/98
1.8 i	Petrol	66	07/97 → 08/00
1.8 i Aut.	Petrol	74	07/97 → 08/00

XSARA Break (N2)

1.4 i	Petrol	55	04/98 → 06/98
1.6 i	Petrol	65	10/97 → 06/98
1.8 i	Petrol	66	04/98 → 08/00
1.8 i Aut.	Petrol	74	04/98 → 08/00

XSARA Coupé (N0)

1.4 i	Petrol	55	03/98 → 06/98
1.6 i	Petrol	65	02/98 → 06/98
1.8 i	Petrol	66	02/98 → 08/00
1.8 i	Petrol	74	02/98 → 08/00

ZX (N2)

1.6	Petrol	66	07/94 → 10/97
1.6 i	Petrol	65	03/91 → 12/94
1.8	Petrol	76	07/94 → 10/97
1.8 i	Petrol	74	07/92 → 06/97
1.9	Petrol	93	03/91 → 06/97
1.9	Petrol	96	03/91 → 09/93
2.0	Petrol	90	07/94 → 10/97
2.0 i	Petrol	89	07/92 → 06/97

ZX Break (N2)

1.6 i	Petrol	65	10/93 → 10/97
1.8 i	Petrol	74	10/93 → 10/97

FIAT

DUCATO Autobus (230)

2.0 4x4	Petrol	80	11/94 → 11/01
2.0 Panorama/ Combinato	Petrol	80	03/94 → 03/02

DUCATO Autobus (244, Z_)

2.0	Petrol	81	04/02 → 08/06
-----	--------	----	---------------

BAE680AF



KW



FIAT

DUCATO Autobus (244, Z_)

2.0 4x4	Petrol	81	05/02 → 07/06
2.0 Bipower	Petrol/ CNG	81	11/02 → 08/06

DUCATO Furgonato (230L)

2.0	Petrol	80	03/94 → 03/02
2.0 4x4	Petrol	80	11/94 → 03/02

DUCATO Furgonato (244)

2.0	Petrol	81	04/02 → 08/06
2.0 4x4	Petrol	81	05/02 → 07/06
2.0 Bipower	Petrol/ CNG	81	11/02 → 08/06

DUCATO Pianale piatto/Telaio (230)

2.0	Petrol	80	06/98 → 03/02
-----	--------	----	---------------

ULYSSE (220)

1.8 (220.BB5)	Petrol	73	05/97 → 05/00
2.0 (220.AC5)	Petrol	89	09/94 → 05/00
2.0 Turbo (220.AD5)	Petrol	108	09/94 → 05/00

LANCIA

ZETA (220)

2.0 Turbo (220AD5, 220CD5)	Petrol	108	02/98 → 06/99
----------------------------------	--------	-----	---------------

PEUGEOT

106 II (1)

1.0 i	Petrol	37	01/97 → 05/05
1.1 i	Petrol	40	01/97 → 05/05

205 I Cabriolet (741B, 20D)

1.1 CJ	Petrol	44	10/89 → 12/94	CHASSIS: S24902801 →
1.6 CJ	Petrol	65	08/92 → 12/94	

205 II (20A/C)

1.1	Petrol	44	07/89 → 01/96	CHASSIS: S24902801 →
1.4	Petrol	55	01/96 → 07/98	ENGINE: 18081179 →
1.6	Petrol	66	11/90 → 07/92	
1.6 Aut.	Petrol	65	11/90 → 09/98	

306 (7B, N3, N5)

1.1	Petrol	44	01/96 → 04/97
1.4 SL	Petrol	55	06/94 → 05/01
1.6 SR	Petrol	65	05/97 → 06/98
1.8	Petrol	74	10/95 → 04/97
1.8 ST	Petrol	74	06/94 → 05/01
2.0 ST	Petrol	89	07/94 → 04/97

BAE680AF

PEUGEOT
306 2 volumi /Coda spiovente (7A, 7C, N3, N5)

1.1	Petrol	44	01/96 → 04/97
1.4	Petrol	55	09/96 → 04/97
1.6	Petrol	65	05/97 → 06/98
1.8	Petrol	74	05/93 → 04/97
1.8	Petrol	74	05/97 → 04/99
2.0 XSi	Petrol	89	08/93 → 04/97

306 Break (7E, N3, N5)

1.4	Petrol	55	05/97 → 06/98
1.6	Petrol	65	05/97 → 06/98
1.8	Petrol	74	05/97 → 03/02

306 Cabriolet (7D, N3, N5)

1.8	Petrol	74	03/94 → 04/97
1.8	Petrol	74	05/97 → 04/99
2.0	Petrol	89	03/94 → 04/97

309 II (3C, 3A)

1.6	Petrol	65	01/91 → 12/93
-----	--------	----	---------------

405 I (15B)

1.6	Petrol	65	09/90 → 12/92
1.9	Petrol	93	09/90 → 12/92
1.9 4x4	Petrol	93	09/90 → 07/92

405 I Break (15E)

1.6	Petrol	65	09/90 → 08/92
-----	--------	----	---------------

405 II (4B)

1.6	Petrol	65	08/92 → 10/95
1.8	Petrol	74	08/92 → 10/95
2.0	Petrol	89	08/92 → 10/95
2.0 X4	Petrol	89	08/92 → 10/95

405 II Break (4E)

1.6	Petrol	65	08/92 → 10/96
1.8	Petrol	74	08/92 → 10/96
2.0	Petrol	89	08/92 → 10/96
2.0 4x4	Petrol	89	08/92 → 10/96

406 (8B)

1.6	Petrol	65	11/95 → 05/04
1.8	Petrol	66	09/97 → 03/99
1.8	Petrol	74	10/96 → 03/99

406 Break (8E/F)

1.8	Petrol	66	09/97 → 06/04
1.8	Petrol	74	10/96 → 03/99

605 (6B)

2.0	Petrol	89	10/90 → 06/94
2.0 Turbo	Petrol	104	07/92 → 06/94
2.0 Turbo	Petrol	108	07/94 → 05/99

BAE680AF

PEUGEOT
806 (221)

2.0	Petrol	89	06/94 → 08/02
2.0 Turbo	Petrol	108	06/94 → 08/02

BOXER Autobus (230P)

2.0 i	Petrol	80	03/94 → 02/02
-------	--------	----	---------------

BOXER Autobus (244, Z_)

2.0	Petrol	81	04/02 → 05/06
-----	--------	----	---------------

BOXER Furgonato (230L)

2.0 4x4	Petrol	80	03/96 → 09/98
2.0 i	Petrol	80	06/94 → 02/02

BOXER Furgonato (244)

2.0	Petrol	81	04/02 → 05/06
-----	--------	----	---------------

BOXER Pianale piatto/Telaio (ZCT_)

2.0	Petrol	81	02/02 → 04/02
2.0 i	Petrol	80	06/94 → 02/02

EXPERT (224)

1.8	Petrol	74	10/96 → 09/00
-----	--------	----	---------------

EXPERT Furgonato (222)

1.8	Petrol	74	10/96 → 09/00
-----	--------	----	---------------

RANCH MPV / Space wagon (5F)

1.1	Petrol	44	07/96 → 08/02
1.4	Petrol	55	07/96 → 06/98
1.8	Petrol	66	05/97 → 08/02

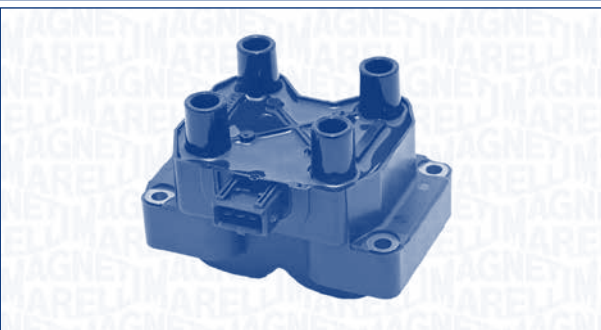
BAE680AG
**BOBINA D'ACCENSIONE
IGNITION COIL**

ALFA ROMEO
155 (167)

1.7 T.S.	Petrol	83	04/93 → 04/96
1.7 T.S. (167.A4D, 167.A4H)	Petrol	85	04/93 → 04/96
1.8 T.S.	Petrol	95	02/92 → 06/93

BAE680AG



KW



ALFA ROMEO

155 (167)

1.8 T.S. Sport (167.A4A, 167.A4C, 167.A4E)	Petrol	93	02/92 → 04/96
---	--------	----	---------------

2.0 T.S. (167.A2)	Petrol	106	02/92 → 04/93
-------------------	--------	-----	---------------

2.0 T.S. (167.A2A)	Petrol	104	04/93 → 02/95
--------------------	--------	-----	---------------

164 (164)

2.0 T.S. (164.H3)	Petrol	106	09/92 → 09/98
-------------------	--------	-----	---------------

DACIA

1309 Pick-up

1.6	Petrol	53	02/97 → 08/01
-----	--------	----	---------------

NOVA

1.6	Petrol	53	05/96 → 09/00
-----	--------	----	---------------

FERRARI

348 Spider

3.4	Petrol	235	03/93 → 04/94
-----	--------	-----	---------------

348 tb/GTB

3.4	Petrol	221	02/90 → 04/94
-----	--------	-----	---------------

3.4	Petrol	235	10/93 → 04/94
-----	--------	-----	---------------

F355 BERLINETTA

3.5	Petrol	280	05/94 → 03/99
-----	--------	-----	---------------

F355 GTS

3.5 Spider	Petrol	280	07/94 → 12/00
------------	--------	-----	---------------

MONDIAL

3.4 T	Petrol	221	03/89 → 12/93
-------	--------	-----	---------------

MONDIAL Cabriolet

3.4 T	Petrol	221	01/89 → 12/93
-------	--------	-----	---------------

FIAT

BRAVA (182)

1.2 16V 80	Petrol	59	10/00 → 09/01
------------	--------	----	---------------

1.2 16V 80	Petrol	60	12/98 → 12/02
------------	--------	----	---------------

1.4 (182.BG)	Petrol	55	10/95 → 10/98
--------------	--------	----	---------------

BRAVO I (182)

1.2 16V 80	Petrol	59	10/00 → 09/01
------------	--------	----	---------------

1.2 16V 80	Petrol	60	12/98 → 10/00
------------	--------	----	---------------

1.4 (182.AG)	Petrol	55	10/95 → 10/98
--------------	--------	----	---------------

FIORINO Furgonato (146)

75 i.e. 1.6	Petrol	55	06/95 → 05/01
-------------	--------	----	---------------

FIORINO Pick up (146)

1.4	Petrol	49	06/95 → 05/01
-----	--------	----	---------------

1.6	Petrol	55	06/95 → 05/01
-----	--------	----	---------------

MAREA (185)

1.2 16V	Petrol	60	03/99 → 05/02
---------	--------	----	---------------

BAE680AG



KW



FIAT

MAREA Weekend (185)

1.2 16V	Petrol	60	03/99 → 05/02
---------	--------	----	---------------

PALIO (178BX)

1.2	Petrol	59	10/01 →
-----	--------	----	---------

PUNTO (176)

1.4 GT Turbo	Petrol	98	01/94 → 09/96
--------------	--------	----	---------------

PUNTO (188)

1.2 16V 80 (188.233, .235, .253, .255, .333, .353, .639...)	Petrol	59	09/99 → 12/10
--	--------	----	---------------

SCUDO Furgonato (220L)

1.6	Petrol	58	02/96 → 05/00
-----	--------	----	---------------

SIENA (178_)

1.2	Petrol	59	01/02 →
-----	--------	----	---------

TEMPRA (159)

1.4 i.e. (159.AC, 159.AX)	Petrol	51	03/95 → 08/96
------------------------------	--------	----	---------------

1.6 i.e. (159.AS, 159.AT)	Petrol	55	04/93 → 08/96
------------------------------	--------	----	---------------

TEMPRA S.W. (159)

1.4 i.e. (159.AC, 159.AX)	Petrol	51	03/95 → 08/96
------------------------------	--------	----	---------------

1.6 i.e. (159.AS, 159.AT)	Petrol	55	04/93 → 08/96
------------------------------	--------	----	---------------

TIPO (160)

1.4 i.e. (160.AP, 160.AD, 160.EA)	Petrol	51	10/93 → 04/95
--------------------------------------	--------	----	---------------

1.6 i.e. (160.A1, 160.EC, 160.EB)	Petrol	55	03/93 → 04/95
--------------------------------------	--------	----	---------------

UNO (146A/E)

1.6 R	Petrol	66	10/94 → 12/95
-------	--------	----	---------------

INNOCENTI

ELBA (146)

1.4 i.e. (146EN, 146EQ)	Petrol	49	06/95 → 12/96
----------------------------	--------	----	---------------

1.6 i.e. (146EO, 146ER)	Petrol	55	03/95 → 12/96
----------------------------	--------	----	---------------

LANCIA

DEDRA (835)

1.6 i.e. (835AN)	Petrol	55	04/93 → 10/94
------------------	--------	----	---------------

DELTA II (836)

1.4 i.e. (836AF, 836AH)	Petrol	51	10/94 → 08/99
----------------------------	--------	----	---------------

1.6 i.e. (836AD)	Petrol	55	06/93 → 08/99
------------------	--------	----	---------------

BAE680AG

LANCIA
KAPPA (838A)

2.0 16V Turbo (838AB1AA)	Petrol	151	02/95 → 06/98
-----------------------------	--------	-----	---------------

THEMA (834)

2000 i.e. (834BV)	Petrol	85	05/92 → 05/92
-------------------	--------	----	---------------

THEMA SW (834)

2000 16V (834FA)	Petrol	112	05/92 → 07/94
---------------------	--------	-----	---------------

Y (840A)

1.2 16V (840AG1A)	Petrol	59	10/00 → 06/03
----------------------	--------	----	---------------

1.4 12V (840AC)	Petrol	55	03/96 → 06/00
-----------------	--------	----	---------------

Y10 (156)

1.1 Avenue (156AG)	Petrol	40	01/95 → 12/95
-----------------------	--------	----	---------------

1.1 Avenue Trazione integrale (156AG)	Petrol	40	01/95 → 12/95
---	--------	----	---------------

1.1 i.e. Fire (156AG)	Petrol	37	09/92 → 09/95
--------------------------	--------	----	---------------

1.1 i.e. Fire Trazione integrale (156AG)	Petrol	37	09/92 → 12/95
--	--------	----	---------------

LAND ROVER
DISCOVERY II (LJ, LT)

4.0 V8 4x4	Petrol	136	11/98 → 06/04
------------	--------	-----	---------------

RANGE ROVER II (LP)

3.9 4x4	Petrol	140	07/94 → 03/02
---------	--------	-----	---------------

4.0 4x4	Petrol	136	06/98 → 03/02
---------	--------	-----	---------------

4.6 4x4	Petrol	160	06/98 → 03/02
---------	--------	-----	---------------

4.6 4x4	Petrol	165	07/94 → 03/02
---------	--------	-----	---------------

PROTON
GEN 2 (CM_)

1.3	Petrol	70	06/04 →
-----	--------	----	---------

1.6	Petrol	82	06/04 →
-----	--------	----	---------

JUMBUCK Pick-up

1.5	Petrol	64	05/02 → 01/07
-----	--------	----	---------------

PERSONA Tre volumi

1.6	Petrol	82	03/08 →
-----	--------	----	---------

SAGA II Tre volumi

1.3	Petrol	70	04/10 →
-----	--------	----	---------

SATRIA (C9_M)

1.3	Petrol	55	07/96 →
-----	--------	----	---------

BAE680AG

PROTON
SATRIA NEO

1.3	Petrol	70	02/07 → 09/08
-----	--------	----	---------------

1.6	Petrol	81	02/07 →
-----	--------	----	---------

WIRA

1.3	Petrol	55	08/00 →
-----	--------	----	---------

1.5	Petrol	64	08/00 →
-----	--------	----	---------

WIRA 2 volumi /Coda spiovente

1.3	Petrol	55	08/00 →
-----	--------	----	---------

1.5	Petrol	64	08/00 →
-----	--------	----	---------

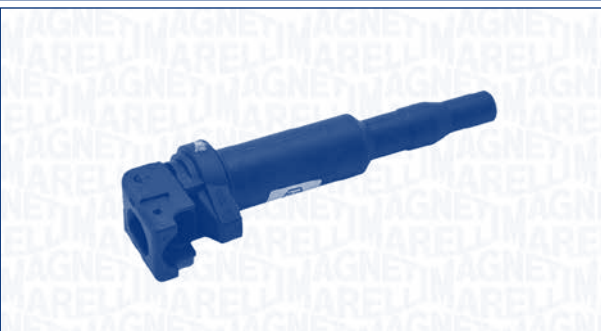
BAE680AH
**BOBINA D'ACCENSIONE
IGNITION COIL**

ALPINA
B7 (E65)

4.4	Petrol	368	12/03 → 06/08
-----	--------	-----	---------------

BMW
1 (E81)

116 i	Petrol	85	09/07 → 12/11
-------	--------	----	---------------

120 i	Petrol	115	05/07 → 10/11
-------	--------	-----	---------------

3 (E46)

316 i	Petrol	85	06/02 → 02/05
-------	--------	----	---------------

316 i	Petrol	85	03/03 → 02/05
-------	--------	----	---------------

318 i	Petrol	105	03/03 → 02/05
-------	--------	-----	---------------

320 i	Petrol	125	10/02 → 02/05
-------	--------	-----	---------------

325 i	Petrol	141	09/00 → 02/05
-------	--------	-----	---------------

325 xi	Petrol	141	09/00 → 02/05
--------	--------	-----	---------------

330 i	Petrol	170	06/00 → 02/05
-------	--------	-----	---------------

330 xi	Petrol	170	06/00 → 02/05
--------	--------	-----	---------------

3 (E90)

316 i	Petrol	85	02/06 → 10/11
-------	--------	----	---------------

318 i	Petrol	95	09/05 → 03/07
-------	--------	----	---------------

320 i	Petrol	110	03/05 → 03/07
-------	--------	-----	---------------

BAE680AH



KW



BMW

3 (E90)

320 i	Petrol	115	03/07 → 12/11
320 si	Petrol	127	05/06 → 09/06

3 Cabriolet (E46)

318 Ci	Petrol	105	03/03 → 03/04
318 Ci	Petrol	110	02/05 → 08/06
320 Ci	Petrol	125	10/02 → 08/06
325 Ci	Petrol	141	09/00 →
330 Ci	Petrol	170	06/00 →
M3 3.2	Petrol	252	04/01 →

3 Cabriolet (E93)

320 i	Petrol	110	03/07 → 08/07
-------	--------	-----	---------------

3 Compact (E46)

316 ti	Petrol	85	03/03 → 12/04
316 ti	Petrol	85	06/02 → 12/04
318 ti	Petrol	105	03/03 → 12/04
325 ti	Petrol	141	10/02 → 12/04

3 Coupé (E46)

316 Ci	Petrol	85	06/02 → 05/06
318 Ci	Petrol	105	03/03 → 03/04
318 Ci	Petrol	110	03/05 → 05/06
320 Ci	Petrol	125	10/02 → 05/06
325 Ci	Petrol	141	09/00 →
330 Ci	Petrol	170	06/00 →
M3 3.2	Petrol	252	06/00 →
M3 CSL	Petrol	265	06/03 → 12/03

3 Coupé (E92)

320 i	Petrol	110	03/07 → 06/07
-------	--------	-----	---------------

3 Touring (E46)

316 i	Petrol	85	03/03 → 02/05
318 i	Petrol	105	03/03 → 02/05
320 i	Petrol	125	10/02 → 02/05
325 i	Petrol	141	09/00 → 02/05
325 xi	Petrol	141	09/00 → 02/05
330 i	Petrol	170	10/02 → 02/05
330 xi	Petrol	170	10/02 → 02/05

3 Touring (E91)

318 i	Petrol	95	03/06 → 03/10
320 i	Petrol	110	09/05 → 05/12

5 (E39)

520 i	Petrol	125	10/02 → 06/03
525 i	Petrol	141	09/00 → 06/03
530 i	Petrol	170	09/00 → 06/03

BAE680AH



KW



BMW

5 (E60)

520 i	Petrol	125	07/03 → 03/05
525 i	Petrol	141	09/03 → 03/10
530 i	Petrol	170	07/03 → 03/10
540 i	Petrol	225	09/05 → 02/10
545 i	Petrol	245	09/03 → 03/10
550 i	Petrol	270	07/05 → 03/10

5 Touring (E39)

520 i	Petrol	125	10/02 → 05/04
525 i	Petrol	141	09/00 → 05/04
530 i	Petrol	170	10/02 → 05/04

5 Touring (E61)

525 i	Petrol	141	06/04 → 03/05
545 i	Petrol	245	06/04 → 09/05
550 i	Petrol	270	09/05 → 08/10

6 (E63)

645 Ci	Petrol	245	01/04 →
650 i	Petrol	270	07/05 →

6 Cabriolet (E64)

645 Ci	Petrol	245	04/04 →
650 i	Petrol	270	07/05 →

7 (E65, E66, E67)

760	Petrol	320	02/03 → 08/05
730 i,Li	Petrol	170	03/03 → 03/05
735 i	Petrol	225	04/05 → 10/08
735 i,Li	Petrol	200	11/01 → 03/05
740 i,Li	Petrol	225	07/05 → 10/08
745 i,Li	Petrol	245	11/01 →
750 i,Li	Petrol	270	07/05 →

X1 (E84)

sDrive 18 i	Petrol	110	03/10 →
-------------	--------	-----	---------

X3 (E83)

2.0 i	Petrol	110	09/05 → 08/08
2.5 i	Petrol	141	01/04 →
3.0 i xDrive	Petrol	170	01/04 →
xDrive 20 i	Petrol	110	09/08 → 08/10

X5 (E53)

3.0 i	Petrol	170	05/00 →
4.4 i	Petrol	235	12/03 →
4.8 is	Petrol	265	04/04 →

X5 (E70)

4.8 i xDrive	Petrol	261	02/07 → 09/08
xDrive 48 i	Petrol	261	09/08 →

Z3 (E36)

M 3.2	Petrol	239	06/01 → 01/03
-------	--------	-----	---------------

BAE680AH

KW

BMW
Z3 Coupé (E36)

M	Petrol	239	06/01 → 06/03
---	--------	-----	---------------

Z4 (E85)

2.0 i	Petrol	110	04/05 → 03/09
-------	--------	-----	---------------

2.2 i	Petrol	125	10/03 → 11/05
-------	--------	-----	---------------

2.5 i	Petrol	141	02/03 →
-------	--------	-----	---------

M	Petrol	252	03/06 →
---	--------	-----	---------

Z4 Coupé (E86)

M	Petrol	252	03/06 →
---	--------	-----	---------

Z8 (E52)

4.9	Petrol	294	06/00 → 06/03
-----	--------	-----	---------------

ROLLS-ROYCE
PHANTOM

6.75	Petrol	338	03/03 →
------	--------	-----	---------

PHANTOM Coupé

6.75 V12	Petrol	338	09/08 →
----------	--------	-----	---------

PHANTOM Drophead Coupe

6.75 V12	Petrol	338	06/07 →
----------	--------	-----	---------

BAE680AI
**BOBINA D'ACCENSIONE
IGNITION COIL**

KW

OPEL
AGILA (A) (H00)

1.0 12V	Petrol	43	09/00 → 08/03
---------	--------	----	---------------

CORSA C (F08, F68)

1.0	Petrol	43	09/00 → 08/03
-----	--------	----	---------------

VAUXHALL
AGILA Mk I (A)

1.0 12V	Petrol	43	09/00 → 08/03
---------	--------	----	---------------

CORSA Mk II (C) (W5L, F08)

1.0 12V	Petrol	43	09/00 → 08/03
---------	--------	----	---------------

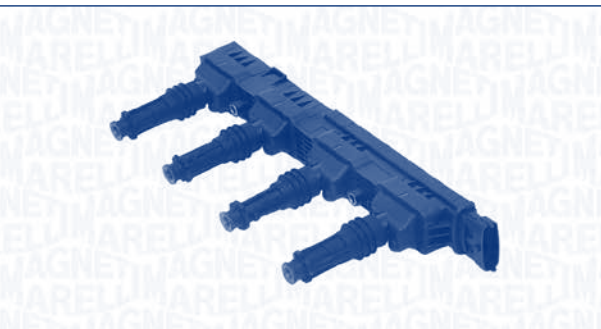
BAE680AJ
**BOBINA D'ACCENSIONE
IGNITION COIL**

KW

OPEL
AGILA (A) (H00)

1.2 16V	Petrol	55	09/00 → 06/04
---------	--------	----	---------------

ASTRA G 2 volumi /Coda spiovente (F48_, F08_)

1.2 16V	Petrol	48	02/98 → 09/00
---------	--------	----	---------------

1.2 16V	Petrol	55	09/00 → 09/03
---------	--------	----	---------------

ASTRA G Station wagon (F35_)

1.2 16V	Petrol	48	02/98 → 09/00
---------	--------	----	---------------

1.2 16V	Petrol	55	09/00 → 09/03
---------	--------	----	---------------

ASTRA G Tre volumi (F69_)

1.2 16V	Petrol	48	09/98 → 09/00
---------	--------	----	---------------

1.2 16V	Petrol	55	09/00 → 09/03
---------	--------	----	---------------

CORSA B (73_, 78_, 79_)

1.2 i 16V	Petrol	48	03/98 → 08/00
-----------	--------	----	---------------

CORSA C (F08, F68)

1.2	Petrol	55	09/00 → 12/09
-----	--------	----	---------------

CORSA C Furgonato (F08, W5L)

1.2 16V	Petrol	55	09/00 →
---------	--------	----	---------

VAUXHALL
AGILA Mk I (A)

1.2 16V	Petrol	55	09/00 → 06/04
---------	--------	----	---------------

ASTRA Mk IV (G) 2 volumi /Coda spiovente

1.2 16V	Petrol	55	09/00 → 05/05
---------	--------	----	---------------

1.2 16V	Petrol	48	02/98 → 08/00
---------	--------	----	---------------

ASTRA Mk IV (G) Station wagon

1.2 16V	Petrol	55	09/00 → 05/05
---------	--------	----	---------------

1.2 16V	Petrol	48	02/98 → 08/00
---------	--------	----	---------------

ASTRA Mk IV (G) Tre volumi

1.2 16V	Petrol	55	09/00 → 05/05
---------	--------	----	---------------

1.2 16V	Petrol	48	09/98 → 08/00
---------	--------	----	---------------

CORSA Mk I (B)

1.2 i 16V	Petrol	48	03/98 → 08/00
-----------	--------	----	---------------

BAE680AJ



OPEL

CORSA Mk II (C) (W5L, F08)

1.2 16V	Petrol	55	09/00 → 08/04
1.2 16V Dualfuel	Petrol/ LPG	55	08/01 → 08/04

CORSAVAN Mk II (C)

1.2 16V	Petrol	55	09/00 → 08/04
1.2 16V Dualfuel	Petrol/ LPG	55	08/01 → 08/04

BAE680AK

**BOBINA D'ACCENSIONE
IGNITION COIL**

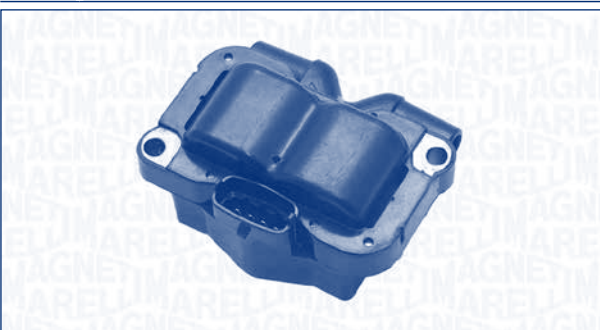

SMART

CABRIO (450)

0.6 (450.433, S10LA1)	Petrol	40	03/00 → 01/04
-----------------------	--------	----	---------------

CITY-COUPÉ (450)

0.6 (450.341, S1CLA1)	Petrol	40	07/98 → 01/04
0.7 (450.314)	Petrol	55	01/03 → 01/04
0.7 (450.336, 450.352, 450.353)	Petrol	45	01/03 → 01/04
0.7 (450.347)	Petrol	37	01/03 → 01/04

FORTWO Cabrio (450)

0.7 (450.452)	Petrol	55	01/04 → 01/07
---------------	--------	----	---------------

FORTWO Coupé (450)

0.7 (450.314)	Petrol	55	01/04 → 01/07
---------------	--------	----	---------------

ROADSTER Coupé (452)

0.7 (452.334)	Petrol	60	04/03 → 11/05
---------------	--------	----	---------------

BAE680AL

**BOBINA D'ACCENSIONE
IGNITION COIL**



OPEL

AGILA (A) (H00)

1.2 16V Twinport	Petrol	59	07/04 → 12/07
------------------	--------	----	---------------

ASTRA G 2 volumi /Coda spiovente (F48_, F08_)

1.4	Petrol	66	09/07 → 06/09
-----	--------	----	---------------

ASTRA G Station wagon (F35_)

1.4	Petrol	66	09/07 → 07/09
-----	--------	----	---------------

ASTRA G Tre volumi (F69_)

1.4	Petrol	66	09/07 → 06/09
-----	--------	----	---------------

ASTRA H (L48)

1.2	Petrol	59	03/07 → 03/09
1.4	Petrol	55	09/04 → 10/04
1.4	Petrol	59	09/04 → 10/04
1.4	Petrol	66	03/04 → 03/10
1.4 LPG	Petrol/ LPG	66	08/09 → 03/10

ASTRA H GTC (L08)

1.2	Petrol	59	03/07 → 03/09
1.4	Petrol	55	09/05 → 02/09
1.4	Petrol	66	03/05 → 03/09

ASTRA H Station wagon (L35)

1.4	Petrol	55	09/04 → 09/05
1.4	Petrol	66	08/04 → 03/10

COMBO Cassone / Furgonato / Promiscuo

1.4 16V	Petrol	66	08/05 → 01/12
---------	--------	----	---------------

COMBO Tour

1.4	Petrol	66	10/04 → 01/12
-----	--------	----	---------------

CORSA C (F08, F68)

1.2 Twinport	Petrol	59	07/04 → 09/06
1.4 Twinport	Petrol	66	09/03 → 09/06

CORSA C Furgonato (F08, W5L)

1.2	Petrol	59	07/05 → 09/06
1.4	Petrol	66	09/03 → 09/06

BAE680AL

OPEL
CORSA D

1.2	Petrol	59	07/06 →
1.2 LPG	Petrol/ LPG	59	09/09 →
1.4	Petrol	66	07/06 → 11/10
1.4 LPG	Petrol/ LPG	66	09/09 → 11/10

CORSA D Van

1.2	Petrol	59	07/09 →
-----	--------	----	---------

MERIVA

1.4 16V Twinport	Petrol	66	07/04 → 03/10
1.4 16V Twinport LPG	Petrol/ LPG	66	07/04 → 03/10

TIGRA TwinTop

1.4	Petrol	66	06/04 → 12/09
-----	--------	----	---------------

VAUXHALL
AGILA Mk I (A)

1.2 16V Twinport	Petrol	59	07/04 → 11/06
------------------	--------	----	---------------

ASTRA Mk V (H) 2 volumi /Coda spiovente

1.2	Petrol	59	03/07 → 03/09
1.4	Petrol	55	09/04 → 12/05
1.4	Petrol	66	03/04 → 05/09

ASTRA Mk V (H) Sport Hatch

1.4	Petrol	55	09/05 → 02/09
1.4 i 16V	Petrol	66	06/05 → 03/09

ASTRA Mk V (H) Station wagon

1.2	Petrol	59	03/07 → 03/09
1.4	Petrol	66	08/04 → 03/09
1.4	Petrol	55	09/04 → 12/05

ASTRAVAN Mk V (H)

1.4 i	Petrol	66	03/05 → 03/10
-------	--------	----	---------------

COMBO Mk II (C) Cassone / Furgonato / Promiscuo (F25)

1.4 16V	Petrol	66	01/04 → 05/07
1.4 i 16V	Petrol	66	01/04 → 11/11

COMBO TOUR Mk II (C) (F25)

1.4	Petrol	66	10/04 → 09/10
-----	--------	----	---------------

CORSA Mk II (C) (W5L, F08)

1.2 Twinport	Petrol	59	09/04 → 09/06
--------------	--------	----	---------------

CORSA Mk III (D) (L_8)

1.2	Petrol	59	11/06 →
1.2 LPG	Petrol/ LPG	59	12/09 →
1.4	Petrol	66	07/06 → 11/10

BAE680AL

OPEL
CORSA Mk III (D) (L_8)

1.4 LPG	Petrol/ LPG	66	12/09 → 11/10
---------	----------------	----	---------------

CORSAVAN Mk III (D)

1.2	Petrol	59	07/09 →
-----	--------	----	---------

MERIVA Mk I (A)

1.4 16V Twinport	Petrol	66	07/04 → 10/09
------------------	--------	----	---------------

TIGRA TwinTop

1.4	Petrol	66	06/04 → 08/09
-----	--------	----	---------------

BAE680AM
**BOBINA D'ACCENSIONE
IGNITION COIL**

FIAT
BRAVA (182)

2.0	Petrol	113	11/98 → 08/00
-----	--------	-----	---------------

BRAVO I (182)

2.0 HGT 20V (182AQ)	Petrol	113	11/98 → 09/01
------------------------	--------	-----	---------------

COUPE (FA/175)

2.0 20V	Petrol	113	04/98 → 08/00
---------	--------	-----	---------------

MAREA (185)

2.0 150 20V	Petrol	110	01/01 → 05/02
2.0 155 20V	Petrol	113	04/99 → 01/01

MAREA Weekend (185)

2.0 150 20V	Petrol	110	01/01 → 05/02
2.0 155 20V	Petrol	113	04/99 → 02/03

LANCIA
LYBRA (839AX)

2.0 20V (839AXC11, 839AXC1A)	Petrol	113	10/99 → 09/00
2.0 20V (839AXH1A)	Petrol	110	10/00 → 09/05

BAE680AM



LANCIA

LYBRA SW (839BX)

2.0 20V (839BXC11, 839BXC1A)	Petrol	113	10/99 → 09/00
------------------------------------	--------	-----	---------------

2.0 20V (839BXH1A)	Petrol	110	10/00 → 09/05
-----------------------	--------	-----	---------------

THEISIS (841AX)

2.0 Turbo (841AXA1B03)	Petrol	136	07/02 → 07/09
---------------------------	--------	-----	---------------

2.4 (841AXB1B00)	Petrol	125	07/02 → 07/09
---------------------	--------	-----	---------------

BAE680AN

**BOBINA D'ACCENSIONE
IGNITION COIL**

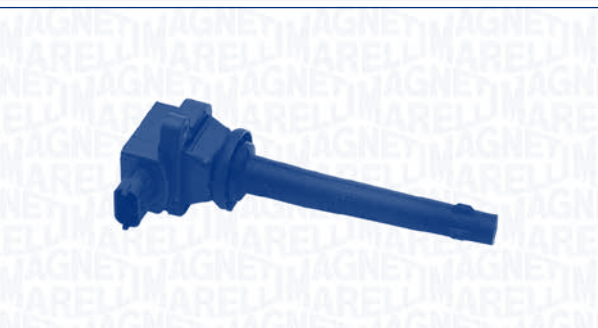

NISSAN

MICRA II (K11)

1.0 i 16V	Petrol	40	07/00 → 09/00
-----------	--------	----	---------------

1.0 i 16V	Petrol	44	09/00 → 10/02
-----------	--------	----	---------------

1.4 i 16V	Petrol	60	09/00 → 10/02
-----------	--------	----	---------------

BAE680AO

**BOBINA D'ACCENSIONE
IGNITION COIL**



TOYOTA

COROLLA (_E11_)

1.4 16V (ZZE111_)	Petrol	71	02/00 → 09/01
-------------------	--------	----	---------------

COROLLA Compact (_E11_)

1.4 (ZZE111_)	Petrol	71	02/00 → 07/01
---------------	--------	----	---------------

COROLLA Liftback (_E11_)

1.4 (ZZE111_)	Petrol	71	02/00 → 11/01
---------------	--------	----	---------------

COROLLA Wagon (_E11_)

1.4 16V (ZZE111_)	Petrol	71	02/00 → 09/01
-------------------	--------	----	---------------

BAE680AP

**BOBINA D'ACCENSIONE
IGNITION COIL**

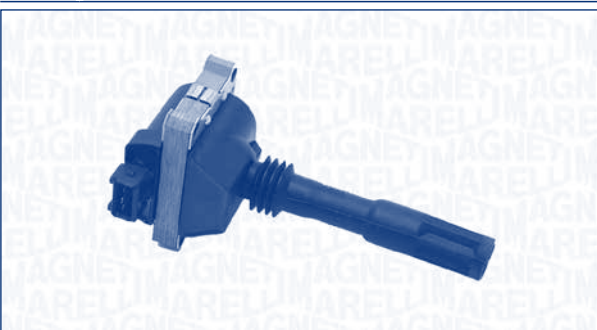

ALFA ROMEO

147 (937)

3.2 GTA	Petrol	184	02/03 → 03/10
---------	--------	-----	---------------

156 (932)

2.5 V6 24V (932A1)	Petrol	140	10/97 → 09/00
-----------------------	--------	-----	---------------

2.5 V6 24V (932A11_)	Petrol	141	01/02 → 09/05
-------------------------	--------	-----	---------------

3.2 GTA (932AXB)	Petrol	184	03/02 → 09/05
---------------------	--------	-----	---------------

BAE680AP

ALFA ROMEO
156 Sportwagon (932)

2.5 V6 24V (932A1)	Petrol	140	06/00 → 09/00
2.5 V6 24V (932B11_)	Petrol	141	10/00 → 10/05
3.2 GTA (932BXX)	Petrol	184	03/02 → 10/05

164 (164)

3.0	Petrol	145	10/94 → 08/95
3.0	Petrol	168	04/93 → 02/95
3.0	Petrol	170	03/95 → 08/97
3.0 24V (164.K1)	Petrol	155	09/92 → 09/98
3.0 24V Q4 (164.K1M, 164.K1C)	Petrol	170	02/94 → 09/98
3.0 24V QV (164.H1)	Petrol	171	09/92 → 09/98
3.0 24V QV Trazione integrale	Petrol	171	12/93 → 10/97

166 (936)

2.5 V6 24V (936A2_)	Petrol	140	09/98 → 10/00
2.5 V6 24V (936A21_)	Petrol	138	10/00 → 06/07
3.0 V6 24V (936A1_)	Petrol	166	10/98 → 09/00
3.0 V6 24V (936A11_)	Petrol	162	10/00 → 06/07
3.2 V6 24V	Petrol	176	10/03 → 06/07

GT (937)

3.2 GTA	Petrol	176	11/03 → 09/10
---------	--------	-----	---------------

GTV (916C_)

3.0 V6 24V (916.C1B_)	Petrol	160	10/00 → 10/05
3.2 V6 24V	Petrol	176	04/03 → 10/05

SPIDER (916S_)

3.0 V6 (916S1B00)	Petrol	160	09/94 → 08/00
3.2 V6 24V	Petrol	176	04/03 → 04/05

BAE680AP

LANCIA
KAPPA (838A)

3.0 24V (838AD1AA, 838AD11A, 838XD1AA, 838ZD1AA)	Petrol	150	11/94 → 06/98
--	--------	-----	---------------

THESIS (841AX)

3.0 V6 (841AXC1101)	Petrol	158	07/02 → 07/03
3.2 V6	Petrol	169	08/03 → 07/09

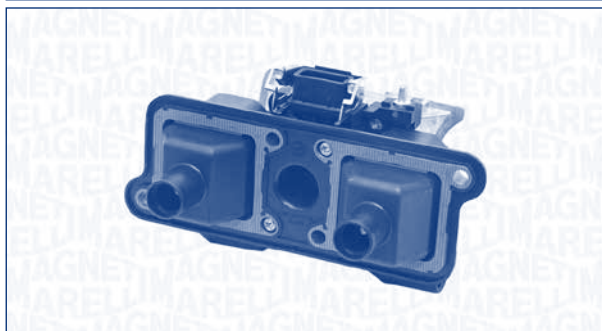
BAE680AQ
**BOBINA D'ACCENSIONE
IGNITION COIL**

AUDI
A4 (8D2, B5)

1.8	Petrol	92	01/95 → 10/00
1.8	Petrol	85	04/95 → 06/00
1.8 quattro	Petrol	92	01/95 → 10/00
1.8 quattro	Petrol	85	07/95 → 11/00

A4 Avant (8D5, B5)

1.8	Petrol	85	07/95 → 12/98
1.8	Petrol	92	02/96 → 09/01
1.8 quattro	Petrol	85	07/95 → 09/01
1.8 quattro	Petrol	92	01/96 → 09/01

A6 (4A, C4)

1.8	Petrol	92	12/95 → 10/97
1.8 quattro	Petrol	92	12/95 → 10/97

A6 (4B2, C5)

1.8	Petrol	85	05/97 → 05/00
1.8 T quattro	Petrol	110	11/98 → 05/01

A6 Avant (4A, C4)

1.8	Petrol	92	12/95 → 10/97
1.8 quattro	Petrol	92	07/96 → 10/97

BAE680AQ



AUDI

A6 Avant (4B5, C5)

1.8	Petrol	85	02/98 → 05/00
1.8 T	Petrol	110	11/98 → 04/01

VOLKSWAGEN

PASSAT (3B2)

1.8	Petrol	85	01/97 → 11/00
1.8 Syncro/4motion	Petrol	92	06/97 → 11/00

PASSAT Variant (3B5)

1.8	Petrol	85	06/97 → 11/00
1.8 Syncro/4motion	Petrol	92	08/97 → 08/00

BAE680AR

BOBINA D'ACCENSIONE
IGNITION COIL

VOLVO

C70 I Cabriolet

2.0 T	Petrol	120	03/00 → 10/05
2.0 T	Petrol	166	08/98 → 07/00
2.3 T5	Petrol	176	08/98 → 07/02
2.3 T5	Petrol	180	07/02 → 10/05
2.4 T	Petrol	147	07/02 → 10/05
2.5	Petrol	125	03/99 → 07/00
2.5 T	Petrol	142	03/98 → 10/05

C70 I Coupé

2.0 T	Petrol	120	03/00 → 07/02
2.0 T	Petrol	166	08/98 → 07/00
2.3 T-5	Petrol	176	03/97 → 09/02
2.5	Petrol	121	03/99 → 07/00
2.5	Petrol	125	05/99 → 07/00
2.5 T	Petrol	142	03/97 → 09/02

BAE680AR



VOLVO

S60 I

2.0 T	Petrol	132	07/00 → 07/04
2.3 T5	Petrol	195	07/00 → 09/02
2.4	Petrol	125	11/00 → 04/10
2.4	Petrol	103	11/00 → 07/09
2.4 Bifuel (CNG)	Petrol/ CNG	103	06/02 → 07/08
2.4 T	Petrol	147	11/00 → 04/10
2.4 T AWD	Petrol	147	11/01 → 04/10
2.5 T	Petrol	154	02/04 → 04/10
2.5 T AWD	Petrol	154	04/04 → 04/10
R 2,5 T AWD	Petrol	221	09/03 → 08/04
T5	Petrol	184	11/00 → 04/10

S70 (LS)

2.0	Petrol	120	08/98 → 07/00
2.3	Petrol	195	04/99 → 07/00
2.3 T5 AWD	Petrol	177	11/96 → 09/98
2.4	Petrol	103	08/99 → 07/00
2.4 AWD	Petrol	125	08/99 → 07/00
2.4 T5 AWD	Petrol	142	11/96 → 04/99
2.5	Petrol	121	06/98 → 11/00
2.5 Bifuel	Petrol/ CNG	103	08/99 → 07/00

S80 I (TS, XY)

2.0	Petrol	120	08/98 → 07/00
2.0 T	Petrol	132	12/99 → 07/04
2.0 T	Petrol	166	08/98 → 07/00
2.3 R	Petrol	195	04/00 → 07/05
2.4	Petrol	103	01/99 → 07/06
2.4	Petrol	125	01/99 → 07/06
2.4 Bifuel (CNG)	Petrol/ CNG	103	09/01 → 07/06
2.4 T	Petrol	147	08/00 → 07/03
2.4 T5 AWD	Petrol	147	08/00 → 07/03
2.5 T	Petrol	154	03/03 → 07/06
2.5 T AWD	Petrol	154	07/03 → 07/06
2.8 T6	Petrol	200	05/98 → 07/01
2.9	Petrol	147	03/99 → 07/06
2.9	Petrol	150	06/98 → 07/99
3.0	Petrol	144	06/01 → 07/06
3.0 T6	Petrol	200	06/01 → 07/06

V70 I (LV)

2.0	Petrol	120	08/98 → 03/00
2.3 AWD	Petrol	177	08/98 → 09/98
2.3 AWD	Petrol	195	12/98 → 02/00

BAE680AR

VOLVO
V70 I (LV)

2.3 T-5 AWD	Petrol	176	08/98 → 03/00
2.4	Petrol	103	08/99 → 03/00
2.4 Bifuel	BiFuel	103	08/99 → 03/00
2.4 Turbo AWD	Petrol	195	05/99 → 02/00
2.5	Petrol	121	06/98 → 03/00
2.5 AWD	Petrol	195	03/99 → 03/00

V70 II (SW)

2.0 T	Petrol	132	07/01 → 07/04
2.3	Petrol	195	10/00 → 07/04
2.3 T5	Petrol	184	03/00 → 08/07
2.4	Petrol	125	03/00 → 08/07
2.4	Petrol	103	03/00 → 07/07
2.4	Petrol	121	03/00 → 09/03
2.4 Bifuel (CNG)	Petrol/ CNG	103	09/01 → 07/06
2.4 T	Petrol	147	03/00 → 08/07
2.4 T AWD	Petrol	147	09/01 → 08/07
2.5 T	Petrol	154	04/04 → 08/07
2.5 T AWD	Petrol	154	09/02 → 08/07

XC70 CROSS COUNTRY

2.4 T XC AWD	Petrol	147	03/00 → 09/02
2.4 T XC AWD	Petrol	142	11/97 → 09/02
2.5 T XC AWD	Petrol	154	09/02 → 08/07

XC90 I

2.5 T	Petrol	154	10/02 →
T6	Petrol	200	10/02 →

BAE680AS
**BOBINA D'ACCENSIONE
IGNITION COIL**

NISSAN
LIVINA /GRAND LIVINA (L10)

1.6	Petrol	80	05/10 →
-----	--------	----	---------

BAE680AS

NISSAN
MICRA C+C (K12)

1.6 160 SR	Petrol	81	09/05 → 10/10
------------	--------	----	---------------

MICRA III (K12)

160 SR	Petrol	81	06/05 → 06/10
--------	--------	----	---------------

NOTE (E11)

1.6	Petrol	81	03/06 →
-----	--------	----	---------

NV200 Furgonato

1.6 16V	Petrol	81	02/10 →
---------	--------	----	---------

QASHQAI / QASHQAI +2 (J10, JJ10)

1.6	Petrol	84	02/07 →
-----	--------	----	---------

TIIDA 2 volumi /Coda spiovente (C11X)

1.6	Petrol	81	09/07 →
-----	--------	----	---------

1.8	Petrol	93	09/07 → 03/10
-----	--------	----	---------------

TIIDA Tre volumi (SC11X)

1.6	Petrol	81	09/07 →
-----	--------	----	---------

1.8	Petrol	93	09/07 → 03/10
-----	--------	----	---------------

X-TRAIL (T31)

2.0	Petrol	104	06/07 →
-----	--------	-----	---------

2.0	Petrol	103	06/08 →
-----	--------	-----	---------

2.0 FWD	Petrol	103	06/08 → 07/10
---------	--------	-----	---------------

2.0 FWD	Petrol	104	04/07 → 07/10
---------	--------	-----	---------------

BAE680AT
**BOBINA D'ACCENSIONE
IGNITION COIL**

ALFA ROMEO
156 (932)

2.0 JTS (932AXA)	Petrol	122	03/02 → 09/05
------------------	--------	-----	---------------

156 Sportwagon (932)

2.0	Petrol	119	03/02 → 12/05
-----	--------	-----	---------------

2.0 JTS (932BXA)	Petrol	122	03/02 → 12/05
------------------	--------	-----	---------------

GT (937)

2.0 JTS	Petrol	121	11/03 → 09/10
---------	--------	-----	---------------

2.0 JTS	Petrol	119	12/06 → 09/10
---------	--------	-----	---------------

BAE680AT**ALFA ROMEO****GTV (916C_)**

2.0 JTS Petrol 121 04/03 → 10/05

SPIDER (916S_)

2.0 JTS Petrol 121 04/03 → 04/05

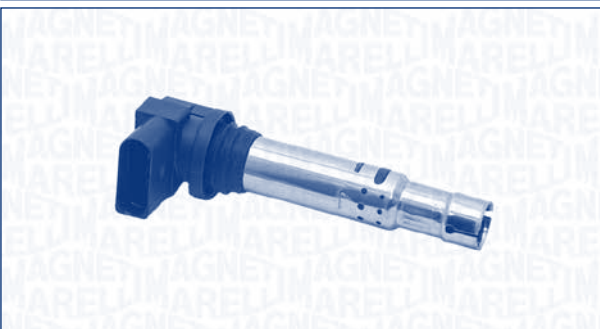
BAE680AU**BOBINA D'ACCENSIONE
IGNITION COIL****AUDI****A2 (8Z0)**

1.6 FSI Petrol 81 05/02 → 08/05

A3 (8P1)

1.6 FSI Petrol 85 08/03 → 09/07

A3 Sportback (8PA)

1.6 FSI Petrol 85 09/04 → 09/07

SEAT**CORDOBA (6L2)**

1.2 Petrol 47 10/02 → 06/06

1.4 16V Petrol 55 09/02 → 12/07

IBIZA IV (6L1)

1.2 12V Petrol 51 05/06 → 11/09

1.4 16V Petrol 55 02/02 → 12/07

TOLEDO II (1M2)

1.6 16V Petrol 77 09/00 → 05/06

SKODA**FABIA (6Y2)**

1.2 Petrol 40 08/02 → 03/08

OCTAVIA (1Z3)

1.4 Petrol 59 06/04 →

1.6 FSI Petrol 85 02/04 → 10/08

BAE680AU**VOLKSWAGEN****BORA (1J2)**

1.6 16V Petrol 77 05/00 → 05/05

1.6 FSI Petrol 81 01/02 → 05/05

CADDY III Furgonato (2KA, 2KH, 2CA, 2CH)

1.4 Petrol 55 03/04 → 05/06

GOLF PLUS (5M1, 521)

1.4 FSI Petrol 66 07/05 →

1.6 FSI Petrol 85 01/05 → 05/08

GOLF V (1K1)

1.4 16V Petrol 55 10/03 → 05/06

1.6 FSI Petrol 85 10/03 → 07/08

JETTA III (1K2)

1.4 TSI Petrol 103 07/06 → 10/10

1.4 TSI Petrol 125 07/06 → 10/10

1.6 FSI Petrol 85 09/05 → 10/10

LUPO (6X1, 6E1)

1.4 16V Petrol 74 08/99 → 07/05

NEW BEETLE (9C1, 1C1)

1.4 Petrol 55 11/01 → 09/10

NEW BEETLE Cabriolet (1Y7)

1.4 Petrol 55 01/03 → 09/10

PASSAT (3C2)

1.6 FSI Petrol 85 03/05 → 06/08

POLO (9N_)

1.2 Petrol 40 01/02 → 05/07

1.4 16V Petrol 55 10/01 → 05/08

TOURAN (1T1, 1T2)

1.4 FSI Petrol 125 11/06 → 05/10

1.6 FSI Petrol 85 02/03 → 01/07

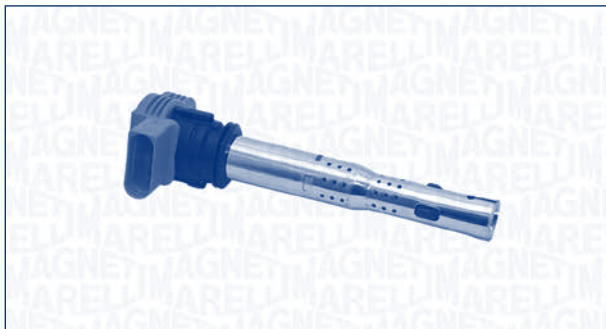
BAE680AV
**BOBINA D'ACCENSIONE
IGNITION COIL**

AUDI
A4 (8EC, B7)

3.2 FSI	Petrol	188	01/05 → 06/08
---------	--------	-----	---------------

A6 (4F2, C6)

2.4	Petrol	130	05/04 → 10/08
-----	--------	-----	---------------

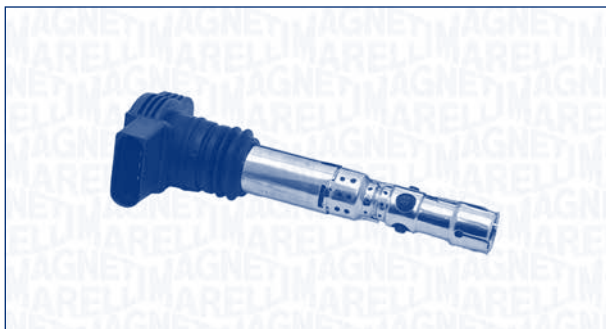
3.2 FSI	Petrol	188	05/04 → 05/09
---------	--------	-----	---------------

BAE680AW
**BOBINA D'ACCENSIONE
IGNITION COIL**

AUDI
A3 (8L1)

S3 quattro	Petrol	165	10/01 → 05/03
------------	--------	-----	---------------

A4 (8E2, B6)

1.8 T	Petrol	110	11/00 → 07/02
-------	--------	-----	---------------

1.8 T quattro	Petrol	120	07/02 → 12/04
---------------	--------	-----	---------------

2.0	Petrol	96	11/00 → 12/04
-----	--------	----	---------------

A4 Cabriolet (8H7, B6, 8HE, B7)

1.8 T quattro	Petrol	120	05/03 → 03/09
---------------	--------	-----	---------------

A6 (4B2, C5)

1.8	Petrol	92	07/97 → 01/05
-----	--------	----	---------------

1.8 T quattro	Petrol	110	02/97 → 01/05
---------------	--------	-----	---------------

2.7 T quattro	Petrol	184	08/01 → 01/05
---------------	--------	-----	---------------

BAE680AW

AUDI
TT (8N3)

1.8 T	Petrol	110	09/02 → 06/06
-------	--------	-----	---------------

1.8 T	Petrol	132	10/98 → 06/06
-------	--------	-----	---------------

SEAT
CORDOBA (6K2)

1.8 T 20V Cupra	Petrol	115	07/00 → 10/02
-----------------	--------	-----	---------------

IBIZA III (6K1)

1.8 T 20V Cupra	Petrol	115	07/00 → 02/02
-----------------	--------	-----	---------------

IBIZA IV (6L1)

1.8 T Cupra R	Petrol	132	01/04 → 02/08
---------------	--------	-----	---------------

1.8 T FR	Petrol	110	12/03 → 05/08
----------	--------	-----	---------------

LEON (1M1)

1.8 20V T	Petrol	132	11/99 → 06/06
-----------	--------	-----	---------------

1.8 T Cupra R	Petrol	154	02/02 → 06/06
---------------	--------	-----	---------------

SKODA
OCTAVIA (1U2)

1.8 T 4x4	Petrol	110	05/01 → 05/06
-----------	--------	-----	---------------

SUPERB (3U4)

1.8 T	Petrol	110	12/01 → 03/08
-------	--------	-----	---------------

VOLKSWAGEN
NEW BEETLE (9C1, 1C1)

1.8 T	Petrol	110	10/99 → 09/10
-------	--------	-----	---------------

NEW BEETLE Cabriolet (1Y7)

1.8 T	Petrol	110	01/03 → 09/10
-------	--------	-----	---------------

PASSAT (3B3)

1.8 T 20V	Petrol	110	11/00 → 05/05
-----------	--------	-----	---------------

2.0	Petrol	96	11/01 → 05/05
-----	--------	----	---------------

BAE680AX
**BOBINA D'ACCENSIONE
IGNITION COIL**

VOLKSWAGEN
BORA (1J2)

2.0	Petrol	85	10/98 → 05/05
-----	--------	----	---------------

BAE680AW



AUDI

GOLF IV (1J1)

2.0 Petrol 85 07/98 → 05/04

NEW BEETLE (9C1, 1C1)

2.0 Petrol 85 01/98 → 09/10

NEW BEETLE Cabriolet (1Y7)

2.0 Petrol 85 09/02 → 10/10

BAE680AY

**BOBINA D'ACCENSIONE
IGNITION COIL**



CITROËN

XANTIA (X1)

1.8 i 16V Petrol 81 06/95 → 01/98

2.0 i 16V Petrol 97 06/95 → 01/98

XM (Y4)

2.0 i 16V Petrol 97 05/94 → 10/00

PEUGEOT

306 2 volumi /Coda spiovente (7A, 7C, N3, N5)

2.0 16V Petrol 97 03/97 → 05/01

406 (8B)

1.8 16V Petrol 81 11/95 → 10/00

2.0 16V Petrol 97 11/95 → 05/04

406 Coupé (8C)

2.0 16V Petrol 97 03/97 → 12/04

605 (6B)

2.0 16V Petrol 97 07/94 → 09/99

BAE680AZ

**BOBINA D'ACCENSIONE
IGNITION COIL**

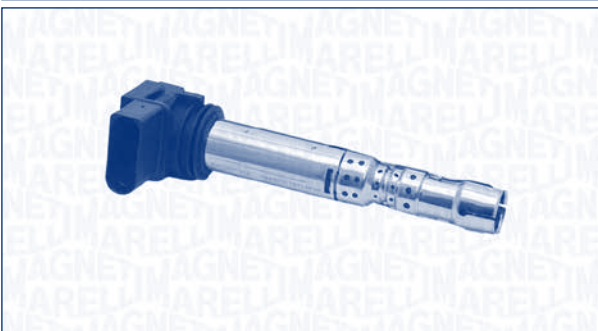

VOLKSWAGEN

PASSAT Variant (3B6)

4.0 W8 4motion Petrol 202 09/01 → 09/04

PHAETON (3D_)

6.0 W12 4motion Petrol 309 04/02 →

TOUAREG (7LA, 7L6, 7L7)

3.2 V6 Petrol 162 10/02 → 11/06

BAE680BA

**BOBINA D'ACCENSIONE
IGNITION COIL**

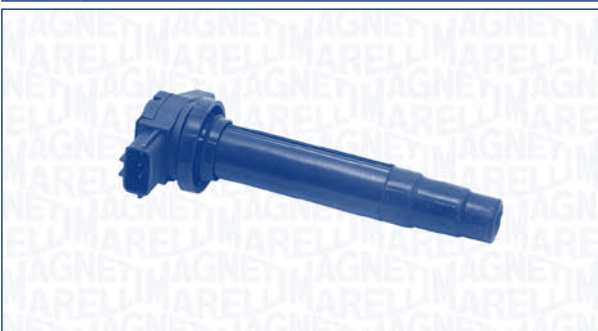

NISSAN

ALMERA II (N16)

1.5 Petrol 66 07/00 →

1.8 Petrol 84 07/00 →

PRIMERA (P12)

1.8 Petrol 85 03/02 →

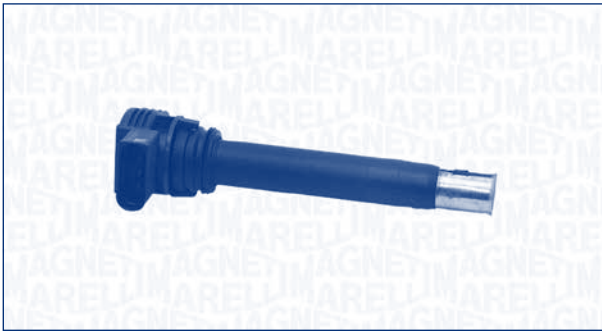
BAE680BB
**BOBINA D'ACCENSIONE
IGNITION COIL**

AUDI
A1 (8X1, 8XF)

2.0 TFSI quattro	Petrol	188	03/12 →
------------------	--------	-----	---------

A3 (8P1)

1.8 TFSI	Petrol	118	11/06 → 08/12
1.8 TFSI quattro	Petrol	118	07/08 → 08/12
2.0 FSI	Petrol	110	05/03 → 06/08
2.0 TFSI	Petrol	147	09/04 → 08/12
2.0 TFSI quattro	Petrol	147	09/04 → 08/12
S3 quattro	Petrol	188	02/07 → 08/12
S3 quattro	Petrol	195	11/06 → 08/12

A3 Cabriolet (8P7)

1.8 TFSI	Petrol	118	04/08 → 05/13
2.0 TFSI	Petrol	147	04/08 → 05/13

A3 Sportback (8PA)

1.8 TFSI	Petrol	118	11/06 → 03/13
1.8 TFSI quattro	Petrol	118	07/08 → 03/13
2.0 FSI	Petrol	110	09/04 → 06/08
2.0 TFSI	Petrol	147	09/04 → 03/13
2.0 TFSI quattro	Petrol	147	09/04 → 03/13
RS3 quattro	Petrol	250	01/11 → 12/12
S3 quattro	Petrol	188	07/08 → 03/13
S3 quattro	Petrol	195	07/08 → 03/13

A4 (8EC, B7)

2.0 TFSI	Petrol	125	03/07 → 06/08
2.0 TFSI	Petrol	147	11/04 → 06/08
2.0 TFSI	Petrol	162	06/05 → 06/08
2.0 TFSI quattro	Petrol	147	11/04 → 06/08
2.0 TFSI quattro	Petrol	162	06/05 → 06/08
RS4 quattro	Petrol	309	09/05 → 06/08

A4 (8K2, B8)

1.8 TFSI	Petrol	88	01/08 →
1.8 TFSI	Petrol	118	11/07 → 03/12
1.8 TFSI quattro	Petrol	118	09/08 → 03/12
2.0 TDi	Diesel	120	08/08 → 02/10

BAE680BB

AUDI
A4 (8K2, B8)

2.0 TFSI	Petrol	132	06/08 →
2.0 TFSI	Petrol	155	06/08 →
2.0 TFSI flexible fuel	Petrol/ Ethanol	132	11/09 →
2.0 TFSI flexible fuel quattro	Petrol/ Ethanol	132	11/09 →
2.0 TFSI quattro	Petrol	155	06/08 →

A4 Allroad (8KH, B8)

2.0 TFSI quattro	Petrol	155	04/09 →
------------------	--------	-----	---------

A4 Avant (8ED, B7)

2.0 TFSI	Petrol	125	03/07 → 06/08
2.0 TFSI	Petrol	147	11/04 → 06/08
2.0 TFSI	Petrol	162	06/05 → 06/08
2.0 TFSI quattro	Petrol	147	11/04 → 06/08
2.0 TFSI quattro	Petrol	162	06/05 → 06/08
RS4 quattro	Petrol	309	09/05 → 06/08

A4 Avant (8K5, B8)

1.8 TFSI	Petrol	118	11/07 →
1.8 TFSI	Petrol	88	04/08 →
1.8 TFSI quattro	Petrol	118	09/08 →
2.0 TFSI	Petrol	132	06/08 →
2.0 TFSI	Petrol	155	06/08 →
2.0 TFSI flexible fuel	Petrol/ Ethanol	132	11/09 →
2.0 TFSI flexible fuel quattro	Petrol/ Ethanol	132	11/09 →
2.0 TFSI quattro	Petrol	155	06/08 →

A4 Cabriolet (8H7, B6, 8HE, B7)

2.0	Petrol	147	11/05 → 03/09
2.0 TFSI 16V	Petrol	147	01/06 → 03/09
RS4 quattro	Petrol	309	06/06 → 03/09

A5 (8T3)

1.8 TFSI	Petrol	118	05/09 →
1.8 TFSI	Petrol	125	10/07 → 11/08
2.0 TFSI	Petrol	132	11/08 →
2.0 TFSI	Petrol	155	06/08 → 05/13
2.0 TFSI quattro	Petrol	155	06/08 →
RS 5 quattro	Petrol	331	03/10 →

A5 Cabriolet (8F7)

1.8 TFSI	Petrol	118	09/09 →
2.0 TFSI	Petrol	132	03/09 →
2.0 TFSI	Petrol	155	03/09 →
2.0 TFSI quattro	Petrol	155	03/09 →

BAE680BB



KW



AUDI

A5 Sportback (8TA)

1.8 TFSI	Petrol	118	11/09 → 09/11
2.0 TFSI	Petrol	132	09/09 →
2.0 TFSI	Petrol	155	09/09 → 05/13
2.0 TFSI quattro	Petrol	155	09/09 →

A6 (4F2, C6)

2.0 TFSI	Petrol	125	06/05 → 03/11
----------	--------	-----	---------------

A6 (4G2, C7, 4GC)

2.0 TFSI	Petrol	132	05/11 →
2.0 TFSI	Petrol	155	03/11 → 05/13
2.0 TFSI hybrid	Hybrid	155	11/11 →

A6 Avant (4F5, C6)

2.0 TFSI	Petrol	125	06/05 → 08/11
2.4	Petrol	130	03/05 → 10/08
2.4 quattro	Petrol	130	03/05 → 10/08

A6 Avant (4G5, C7, 4GD)

2.0 TFSI	Petrol	132	06/11 →
----------	--------	-----	---------

A8 (4H_)

2.0 TFSI hybrid	Hybrid	155	02/12 →
-----------------	--------	-----	---------

Q3 (8U)

2.0 TFSI quattro	Petrol	125	06/11 →
2.0 TFSI quattro	Petrol	155	06/11 →

Q5 (8R)

2.0 TFSI hybrid quattro	Hybrid	155	06/11 →
2.0 TFSI quattro	Petrol	155	11/08 →
3.2 FSI quattro	Petrol	199	11/08 → 08/09

R8

5.2 FSI quattro	Petrol	412	11/10 → 10/12
-----------------	--------	-----	---------------

TT (8J3)

1.8 TFSI	Petrol	118	06/08 →
2.0 quattro	Petrol	195	05/08 →
2.0 TFSI	Petrol	147	08/06 → 06/10
2.0 TFSI quattro	Petrol	147	06/08 → 06/10
2.0 TFSI quattro	Petrol	200	05/08 →
2.5 TFSI RS quattro	Petrol	250	07/09 →
2.5 TFSI RS quattro	Petrol	265	05/11 →

TT Roadster (8J9)

1.8 TFSI	Petrol	118	06/08 →
2.0 quattro	Petrol	195	05/08 →
2.0 TFSI	Petrol	147	03/07 → 06/10
2.0 TFSI quattro	Petrol	147	06/08 → 06/10
2.0 TFSI quattro	Petrol	200	05/08 →

BAE680BB



KW



AUDI

TT Roadster (8J9)

2.5 TFSI quattro	Petrol	265	03/12 →
2.5 TFSI RS quattro	Petrol	250	07/09 →

SEAT

ALTEA (5P1)

1.8 TFSI	Petrol	118	01/07 →
2.0 TFSI	Petrol	147	05/06 → 03/09

ALTEA XL (5P5, 5P8)

2.0 TFSI 4x4	Petrol	147	06/07 → 05/09
2.0 TFSI 4x4	Petrol	155	07/09 →

EXEO (3R2)

1.8 TSI	Petrol	118	05/10 →
1.8 TSI	Petrol	88	09/10 →
2.0 TFSI	Petrol	147	03/09 →
2.0 TFSI	Petrol	155	05/10 →

EXEO ST (3R5)

1.8 TSI	Petrol	118	05/10 →
1.8 TSI	Petrol	88	09/10 →
2.0 TFSI	Petrol	147	06/09 →
2.0 TFSI	Petrol	155	05/10 →

LEON (1P1)

1.8 TSI	Petrol	118	06/07 →
2.0 Cupra R	Petrol	195	09/09 → 12/12
2.0 TFSI	Petrol	147	05/05 → 03/09
2.0 TFSI	Petrol	155	06/09 →
2.0 TFSI	Petrol	177	11/06 →
2.0 TFSI	Petrol	136	09/05 → 05/06

CHASSIS:
→ 1Pxx9xx024388

TOLEDO III (5P2)

2.0 TFSI	Petrol	147	11/05 → 05/09
----------	--------	-----	---------------

SKODA

OCTAVIA (1Z3)

1.8 TSI	Petrol	118	06/07 →
2.0 RS	Petrol	147	11/08 →

OCTAVIA Combi (1Z5)

1.8 TSI	Petrol	118	06/07 →
1.8 TSI 4x4	Petrol	118	11/09 →
2.0 RS	Petrol	147	11/08 →

SUPERB (3T4)

1.8 TSI	Petrol	118	03/08 → 05/09
---------	--------	-----	---------------

YETI (5L)

1.8 TSI 4x4	Petrol	112	08/11 →
1.8 TSI 4x4	Petrol	118	08/11 →

BAE680BB

VOLKSWAGEN
AMAROK (2H_, S1B)

2.0 TSI Petrol 118 12/10 →

BEETLE (5C1)

2.0 TSI Petrol 147 04/11 →

CC (358)

1.8 TSI Petrol 118 11/11 →

2.0 TSI Petrol 155 11/11 →

EOS (1F7, 1F8)

2.0 FSI Petrol 110 05/06 → 05/08

2.0 TFSI Petrol 147 03/06 →

2.0 TSI Petrol 155 11/09 →

GOLF PLUS (5M1, 521)

2.0 FSI Petrol 110 05/05 → 06/08

GOLF V (1K1)

2.0 FSI Petrol 110 01/04 → 11/08

2.0 FSI 4motion Petrol 110 08/04 → 10/08

2.0 GTI Petrol 147 10/04 → 02/09

2.0 GTI Petrol 169 09/06 → 11/08

GOLF V Variant (1K5)

2.0 Petrol 147 06/07 → 07/09

GOLF VI (5K1)

1.8 TSI Petrol 118 06/09 → 01/11

2.0 GTI Petrol 155 04/09 → 11/12

2.0 GTI Petrol 173 05/11 → 11/12

2.0 R 4motion Petrol 199 11/09 → 11/12

2.0 R 4motion Petrol 188 11/09 → 11/12

GOLF VI Cabriolet (517)

2.0 GTI Petrol 155 05/12 →

JETTA III (1K2)

2.0 FSI Petrol 110 08/05 → 06/08

2.0 TFSI Petrol 147 10/05 → 10/10

2.5 FSI Petrol 125 07/08 → 10/10

2.5 FSI Petrol 110 01/06 → 06/08

JETTA IV (162, 163)

2.0 TSI Petrol 147 12/10 →

MULTIVAN V (7HM, 7HN, 7HF, 7EF, 7EM, 7EN)

2.0 TSI Petrol 150 05/11 →

2.0 TSI Petrol 110 07/12 →

2.0 TSI 4motion Petrol 150 07/11 →

NEW BEETLE (9C1, 1C1)

2.5 Petrol 110 07/05 → 09/10

NEW BEETLE Cabriolet (1Y7)

2.5 Petrol 110 07/05 → 09/10

BAE680BB

VOLKSWAGEN
PASSAT (362)

1.8 TSI Petrol 112 02/11 →

1.8 TSI Petrol 118 08/10 →

2.0 TSI Petrol 155 11/10 →

PASSAT (3C2)

1.8 TSI Petrol 112 11/09 → 05/10

1.8 TSI Petrol 118 05/08 → 07/10

2.0 FSI Petrol 110 03/05 → 07/10

2.0 FSI Petrol 125 08/07 → 07/10

2.0 FSI Petrol 147 07/05 → 07/10

2.0 FSI 4motion Petrol 110 09/05 → 07/10

PASSAT ALLTRACK (365)

2.0 TSI 4motion Petrol 155 01/12 →

PASSAT CC (357)

1.8 TSI Petrol 118 06/08 → 11/10

1.8 TSI Petrol 112 11/09 → 05/10

2.0 TSI Petrol 147 06/08 → 01/12

2.0 TSI Petrol 155 11/10 → 05/12

PASSAT Variant (365)

1.8 TSI Petrol 112 02/11 →

1.8 TSI Petrol 118 08/10 →

2.0 TSI Petrol 155 11/10 →

PASSAT Variant (3C5)

1.8 TSI Petrol 112 11/09 → 11/10

1.8 TSI Petrol 118 05/07 → 11/10

2.0 FSI Petrol 110 08/05 → 11/10

2.0 FSI Petrol 147 08/05 → 11/10

2.0 FSI Petrol 125 08/07 → 11/10

2.0 FSI 4motion Petrol 110 09/05 → 11/10

SCIROCCO (137, 138)

2.0 R Petrol 195 11/09 →

2.0 R Petrol 188 11/09 →

2.0 TSI Petrol 155 11/09 → 05/11

2.0 TSI Petrol 147 08/08 → 11/09

TIGUAN (5N_)

2.0 TFSI 4motion Petrol 125 09/07 →

2.0 TFSI 4motion Petrol 147 09/07 →

2.0 TSI 4motion Petrol 132 05/11 →

2.0 TSI 4motion Petrol 155 05/11 →

TOUAREG (7LA, 7L6, 7L7)

4.2 V8 FSI Petrol 257 06/06 → 05/10

TOURAN (1T1, 1T2)

2.0 FSI Petrol 110 10/03 → 11/05

BAE680BB



VOLKSWAGEN

TRANSPORTER V Autobus (7HB, 7HJ, 7EB, 7EJ, 7EF)

2.0 TSI Petrol 150 05/11 →

2.0 TSI Petrol 110 07/12 →

2.0 TSI 4motion Petrol 150 07/11 →

TRANSPORTER V Furgonato (7HA, 7HH, 7EA, 7EH)

2.0 TSI Petrol 150 05/11 →

2.0 TSI Petrol 110 07/12 →

2.0 TSI 4motion Petrol 150 07/11 →

TRANSPORTER V Pianale piatto/Telaio (7JD, 7JE, 7JL, 7JY, 7JZ)

2.0 TSI Petrol 110 07/12 →

BAE680BC

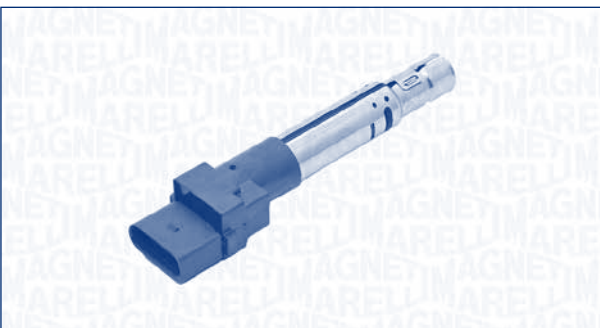
BOBINA D'ACCENSIONE
IGNITION COIL

AUDI

A3 (8P1)

3.2 V6 quattro Petrol 184 07/03 → 05/09

Q7 (4L)

3.6 FSI Petrol 206 08/06 → 05/10

TT (8N3)

3.2 VR6 quattro Petrol 184 07/03 → 06/06

SEAT

LEON (1M1)

2.8 Cupra 4 Petrol 150 02/01 → 06/06

VOLKSWAGEN

EOS (1F7, 1F8)

3.2 V6 Petrol 184 06/06 → 05/09

GOLF V (1K1)

3.2 R32 4motion Petrol 184 11/05 → 11/08

PHAETON (3D_)

3.2 V6 Petrol 177 04/02 →

TOUAREG (7LA, 7L6, 7L7)

3.6 V6 FSI Petrol 206 10/05 → 05/10

BAE680BD

BOBINA D'ACCENSIONE
IGNITION COIL

CITROËN

C5 I (DC_)

3.0 V6 (DCXFXC, DCXFXF) Petrol 152 03/01 → 08/04

C5 I Break (DE_)

3.0 V6 (DEXFXC, DEXFXF) Petrol 152 06/01 → 08/04

C5 II (RC_)

3.0 V6 (RCXFUF) Petrol 152 09/04 →

C5 II Break (RE_)

3.0 Petrol 173 09/04 →

3.0 V6 (REXFUF) Petrol 152 09/04 →

C5 III (RD_)

3.0 V6 Petrol 155 02/08 →

C5 III Break (TD_)

3.0 V6 Petrol 155 02/08 →

C6 (TD_)

3.0 V6 Petrol 155 09/05 →

C8 (EA_, EB_)

3.0 V6 Petrol 150 07/02 →

FIAT

ULYSSE (179AX)

3.0 Petrol 150 08/02 → 06/11

LANCIA

PHEDRA (179)

3.0 V6 Petrol 150 09/02 → 11/10

PEUGEOT

406 (8B)

3.0 V6 Petrol 152 03/00 → 05/04

406 Break (8E/F)

3.0 V6 Petrol 152 03/00 → 10/04

406 Coupé (8C)

3.0 V6 Petrol 152 03/00 → 12/04

407 (6D_)

3.0 Petrol 155 05/04 →

BAE680BD

PEUGEOT
407 Coupé (6C_)

3.0 V6 Petrol 155 10/05 →

407 SW (6E_)

3.0 Petrol 155 05/04 →

607 (9D, 9U)

3.0 V6 24V Petrol 152 02/00 →

3.0 V6 24V Petrol 155 03/04 →

807 (E)

3.0 V6 Petrol 150 06/02 →

RENAULT
AVANTIME (DE0_)

3.0 V6 (DE04, DE0T) Petrol 152 09/01 → 05/03

CLIO II (BB0/1/2_, CB0/1/2_)

3.0 V6 Sport (CB1A) Petrol 166 11/00 → 12/02

3.0 V6 Sport (CB1H, CB1U, CB2S) Petrol 187 12/02 →

LAGUNA II (BG0/1_)

3.0 V6 24V (BG01, BG02, BG0D, BG0Y) Petrol 152 03/01 →

LAGUNA II Grandtour (KG0/1_)

3.0 V6 24V (KG0D) Petrol 152 03/01 →

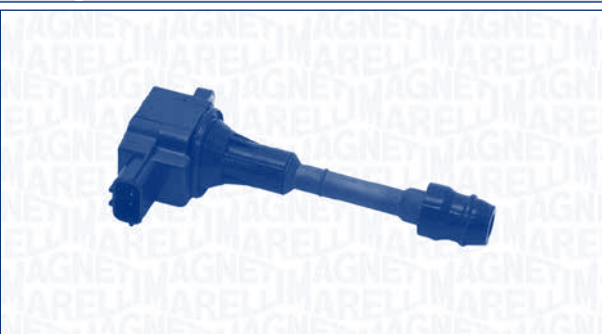
BAE680BE
**BOBINA D'ACCENSIONE
IGNITION COIL**

NISSAN
PRIMERA (P12)

2.0 Petrol 103 03/02 →

BAE680BE

NISSAN
X-TRAIL (T30)

2.0 Petrol 103 07/01 →

2.5 4x4 Petrol 121 09/02 →

BAE680BF
**BOBINA D'ACCENSIONE
IGNITION COIL**

VOLVO
850 (LS)

2.0 Petrol 93 08/94 → 12/96

2.5 Petrol 125 08/91 → 12/96

C70 I Cabriolet

2.0 Petrol 132 03/98 → 10/05

C70 I Coupé

2.0 Petrol 132 03/97 → 09/02

2.0 T Petrol 166 03/97 → 09/02

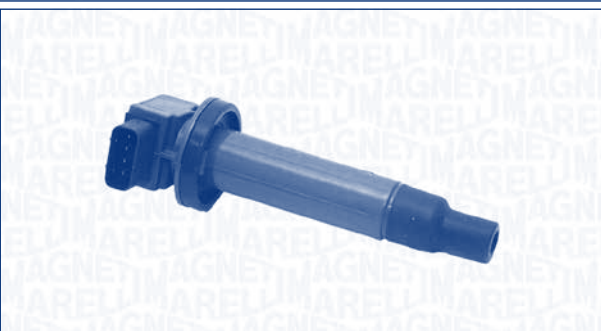
BAE680BH
**BOBINA D'ACCENSIONE
IGNITION COIL**

TOYOTA
PRIUS 2 volumi /Coda spiovente (NHW20_)

1.5 Petrol 57 08/03 → 03/09

BAE680BH



TOYOTA

PRIUS Tre volumi (NHW11_)

1.5 Petrol 53 05/00 → 01/04

YARIS (SCP1_, NLP1_, NCP1_)

1.0 16V Petrol 48 03/03 → 09/05

1.3 16V Petrol 63 11/99 → 09/05

1.5 VVT-i TS Petrol 78 04/01 → 09/05

YARIS VERSO (_NLP2_, _NCP2_)

1.3 (NCP22) Petrol 63 08/99 → 09/05

1.5 (NCP21) Petrol 78 03/00 → 09/05

BAE680BJ



VAUXHALL

OMEGA (B) Station wagon

2.6 V6 Petrol 132 09/00 → 06/03

3.2 V6 Petrol 160 02/01 → 06/03

VECTRA (B)

2.6 i V6 Petrol 125 09/00 → 08/01

VECTRA (B) 2 volumi /Coda spiovente

2.6 i V6 Petrol 125 09/00 → 08/01

VECTRA (B) Station wagon

2.6 i V6 Petrol 125 09/00 → 08/01

BAE680BJ

**BOBINA D'ACCENSIONE
IGNITION COIL**

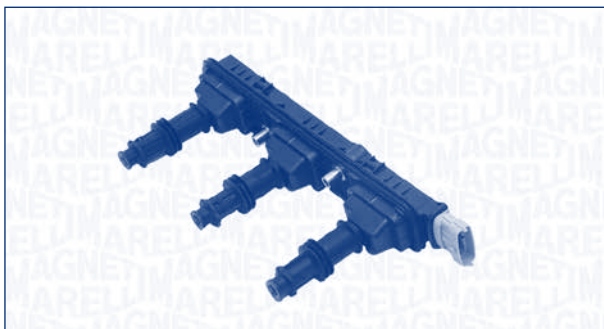

CADILLAC

CTS

3.2 Petrol 160 09/02 → 08/04

OPEL

OMEGA B (25_, 26_, 27_)

2.6 V6 Petrol 132 09/00 → 07/03

3.2 V6 Petrol 160 02/01 → 07/03

OMEGA B Station wagon (21_, 22_, 23_)

2.6 V6 Petrol 132 09/00 → 07/03

3.2 V6 Petrol 160 02/01 → 07/03

VECTRA B (36_)

2.6 i V6 Petrol 125 09/00 → 04/02

VECTRA B 2 volumi /Coda spiovente (38_)

2.6 i V6 Petrol 125 09/00 → 09/02

VECTRA B Station wagon (31_)

2.6 i V6 Petrol 125 09/00 → 09/02

VAUXHALL

OMEGA (B)

2.6 V6 Petrol 132 09/00 → 07/03

3.2 V6 Petrol 160 02/01 → 07/03

BAE680BK

**BOBINA D'ACCENSIONE
IGNITION COIL**

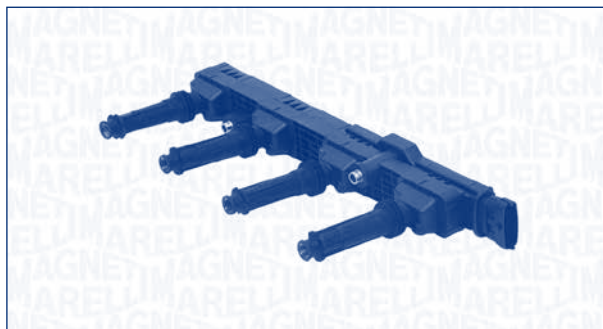

OPEL

OMEGA B (25_, 26_, 27_)

2.2 16V Petrol 106 09/99 → 07/03

OMEGA B Station wagon (21_, 22_, 23_)

2.2 16V Petrol 106 09/99 → 07/03

VAUXHALL

OMEGA (B)

2.2 16V Petrol 106 09/99 → 06/03

OMEGA (B) Station wagon

2.2 16V Petrol 106 09/99 → 06/03

BAE680BL
**BOBINA D'ACCENSIONE
IGNITION COIL**

OPEL
ASTRA G 2 volumi /Coda spiovente (F48_, F08_)

2.0 OPC Petrol 141 09/02 → 01/04

2.0 OPC Petrol 147 11/02 → 01/04

ASTRA G Cabriolet (F67)

2.0 16V Turbo Petrol 147 11/02 → 08/05

2.0 OPC Petrol 141 03/02 → 08/05

ASTRA G Coupé (F07_)

2.0 16V Turbo Petrol 140 09/00 → 08/01

2.0 16V Turbo Petrol 141 08/01 → 02/05

2.0 16V Turbo Petrol 147 11/02 → 02/05

ASTRA G Station wagon (F35_)

2.0 OPC Petrol 141 09/02 → 06/04

2.0 OPC Petrol 147 11/02 → 06/04

ASTRA H (L48)

2.0 Turbo Petrol 125 03/04 → 02/09

2.0 Turbo Petrol 147 09/04 → 03/10

2.0 Turbo Petrol 177 09/05 → 03/10

ASTRA H GTC (L08)

2.0 Turbo Petrol 125 03/05 → 02/09

2.0 Turbo Petrol 147 03/05 → 09/09

2.0 Turbo Petrol 177 08/05 → 03/09

ASTRA H Station wagon (L35)

2.0 Turbo Petrol 125 08/04 → 02/09

2.0 Turbo Petrol 147 09/04 → 03/10

ASTRA H TwinTop (L67)

2.0 Turbo Petrol 125 09/05 → 02/09

2.0 Turbo Petrol 147 09/05 → 10/10

SPEEDSTER

2.0 Turbo Petrol 147 04/03 → 09/06

ZAFIRA A (F75_)

2.0 OPC Petrol 141 09/01 → 06/05

2.0 OPC Petrol 147 11/02 → 06/05

BAE680BL

OPEL
ZAFIRA B (A05)

2.0 Petrol 147 07/05 →

2.0 Petrol 177 01/06 →

VAUXHALL
ASTRA Mk IV (G) 2 volumi /Coda spiovente

2.0 SRI Turbo Petrol 141 07/02 → 05/05

ASTRA Mk IV (G) Cabriolet

2.0 Petrol 147 09/02 → 08/05

2.0 Turbo Petrol 141 03/02 → 08/05

ASTRA Mk IV (G) Coupé (F67)

2.0 Petrol 147 08/02 → 05/05

2.0 16V Turbo Petrol 140 09/00 → 08/05

ASTRA Mk V (H) 2 volumi /Coda spiovente

2.0 Turbo Petrol 125 03/04 → 02/09

2.0 Turbo Petrol 147 03/04 → 05/09

2.0 Turbo Petrol 177 03/05 → 05/09

ASTRA Mk V (H) Sport Hatch

2.0 Turbo Petrol 125 06/05 → 02/09

2.0 VXR Petrol 176 02/09 → 03/09

ASTRA Mk V (H) Station wagon

2.0 Turbo Petrol 125 08/04 → 02/09

2.0 Turbo Petrol 147 08/04 → 03/10

ASTRA TwinTop Mk V (H)

2.0 Petrol 125 02/06 → 02/09

2.0 Turbo Petrol 147 01/06 → 12/09

VX220

2.0 i Turbo Petrol 147 04/03 → 07/05

ZAFIRA Mk I (A) (F75)

2.0 Petrol 147 06/02 → 06/05

2.0 GSI Turbo Petrol 141 09/01 → 06/05

ZAFIRA Mk II (B) (M75)

2.0 Petrol 147 07/05 →

2.0 Petrol 176 01/06 →

BAE680BM

BOBINA D'ACCENSIONE
IGNITION COIL

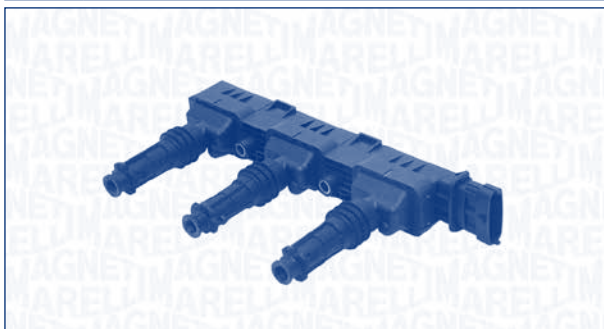

KW



OPEL

SIGNUM

2.2 direct Petrol 114 05/03 → 09/08

VECTRA C

2.2 16V Petrol 108 04/02 → 09/05

2.2 direct Petrol 114 10/03 → 10/08

VECTRA C GTS

2.2 direct Petrol 114 10/03 → 10/08

VECTRA C Station wagon

2.2 direct Petrol 114 10/03 → 10/08

ZAFIRA B (A05)

2.2 Petrol 110 07/05 →

VAUXHALL

SIGNUM

2.2 i Petrol 114 05/03 → 05/08

VECTRA Mk II (C)

2.2 direct Petrol 114 09/03 → 10/08

VECTRA Mk II (C) GTS

2.2 direct Petrol 114 10/03 → 08/05

VECTRA Mk II (C) Station wagon

2.2 direct Petrol 114 10/03 → 07/08

ZAFIRA Mk II (B) (M75)

2.2 Petrol 110 07/05 →

BAE680BN

BOBINA D'ACCENSIONE
IGNITION COIL

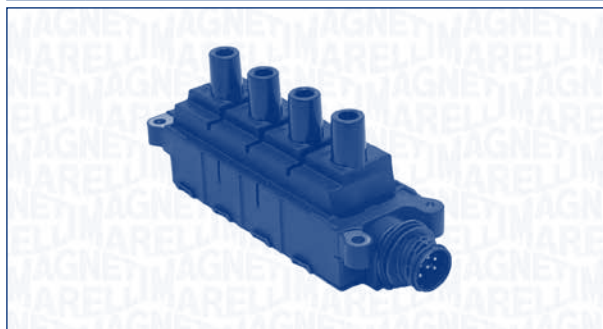

KW



OPEL

AGILA (A) (H00)

1.0 Petrol 44 08/03 → 12/07

CORSA C (F08, F68)

1.0 Petrol 44 09/03 → 09/06

CORSA D

1.0 Petrol 44 07/06 → 10/09

VAUXHALL

AGILA Mk I (A)

1.0 12V Petrol 44 08/03 → 11/06

CORSA Mk II (C) (W5L, F08)

1.0 12V Petrol 44 11/03 → 08/05

CORSA Mk III (D) (L_8)

1.0 Petrol 44 11/06 → 10/09

BAE680BO

BOBINA D'ACCENSIONE
IGNITION COIL



KW



FORD

FIESTA V (JH_, JD_)

ST150 Petrol 110 03/05 → 06/08

MONDEO III (B5Y)

1.8 16V Petrol 81 03/05 → 03/07

1.8 16V Petrol 92 03/05 → 03/07

BAE680BO

FORD
MONDEO III (B5Y)

2.0 16V	Petrol	107	03/05 → 03/07
---------	--------	-----	---------------

MONDEO III Station wagon (BWY)

1.8 16V	Petrol	81	03/05 → 03/07
---------	--------	----	---------------

1.8 16V	Petrol	92	03/05 → 03/07
---------	--------	----	---------------

2.0 16V	Petrol	107	03/05 → 03/07
---------	--------	-----	---------------

MONDEO III Tre volumi (B4Y)

1.8 16V	Petrol	81	03/05 → 03/07
---------	--------	----	---------------

1.8 16V	Petrol	92	03/05 → 03/07
---------	--------	----	---------------

2.0 16V	Petrol	107	03/05 → 03/07
---------	--------	-----	---------------

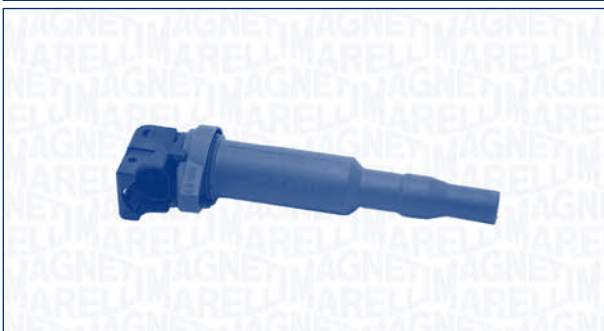
BAE680BP
**BOBINA D'ACCENSIONE
IGNITION COIL**

BMW
3 (E90)

323 i	Petrol	130	04/06 → 04/06
-------	--------	-----	---------------

325 i	Petrol	160	03/05 → 04/06
-------	--------	-----	---------------

325 xi	Petrol	160	09/05 → 04/06
--------	--------	-----	---------------

330 i	Petrol	190	01/05 → 12/11
-------	--------	-----	---------------

330 i	Petrol	200	09/07 → 12/11
-------	--------	-----	---------------

330 xi	Petrol	190	01/05 → 12/11
--------	--------	-----	---------------

3 Touring (E91)

323 i	Petrol	130	04/06 → 04/06
-------	--------	-----	---------------

325 i	Petrol	160	09/05 → 04/06
-------	--------	-----	---------------

325 xi	Petrol	160	09/05 → 04/06
--------	--------	-----	---------------

330 i	Petrol	190	09/05 → 04/06
-------	--------	-----	---------------

330 xi	Petrol	190	09/05 → 04/06
--------	--------	-----	---------------

5 (E60)

523 i	Petrol	130	07/05 → 04/06
-------	--------	-----	---------------

525 i	Petrol	160	07/05 → 04/06
-------	--------	-----	---------------

525 xi	Petrol	160	07/05 → 04/06
--------	--------	-----	---------------

530 i	Petrol	190	07/05 → 03/10
-------	--------	-----	---------------

530 xi	Petrol	190	07/05 → 03/10
--------	--------	-----	---------------

BAE680BP

BMW
5 Touring (E61)

523 i	Petrol	130	07/05 → 04/06
-------	--------	-----	---------------

525 i	Petrol	160	07/05 → 04/06
-------	--------	-----	---------------

525 xi	Petrol	160	07/05 → 04/06
--------	--------	-----	---------------

530 i	Petrol	190	07/05 → 04/06
-------	--------	-----	---------------

530 xi	Petrol	190	07/05 →
--------	--------	-----	---------

6 (E63)

630 i	Petrol	190	09/04 → 04/06
-------	--------	-----	---------------

6 Cabriolet (E64)

630 i	Petrol	190	09/04 → 04/06
-------	--------	-----	---------------

7 (E65, E66, E67)

730 i,Li	Petrol	190	04/05 → 04/06
----------	--------	-----	---------------

Z4 (E85)

2.5 i	Petrol	130	02/06 → 04/06
-------	--------	-----	---------------

2.5 si	Petrol	160	02/06 → 04/06
--------	--------	-----	---------------

3.0 si	Petrol	195	01/06 →
--------	--------	-----	---------

Z4 Coupé (E86)

3.0 si	Petrol	195	03/06 →
--------	--------	-----	---------

BAE680BQ
**BOBINA D'ACCENSIONE
IGNITION COIL**

ALFA ROMEO
GIULIETTA (940)

1.4 BiFuel	BiFuel	88	12/11 →
------------	--------	----	---------

1.4 TB	Petrol	88	05/10 →
--------	--------	----	---------

MITO (955)

1.4	Petrol	88	10/08 →
-----	--------	----	---------

1.4 BiFuel	Petrol/ LPG	88	07/11 →
------------	----------------	----	---------

1.4 TB	Petrol	114	09/08 →
--------	--------	-----	---------

BAE680BQ



FIAT

500 (312)

1.4 Abarth	Petrol	99	08/08 →
1.4 Abarth	Petrol	132	08/08 → 12/12

500 C (312)

1.4 Abarth	Petrol	103	09/09 →
------------	--------	-----	---------

BRAVO II (198)

1.4 T-Jet	Petrol	110	09/07 →
1.4 T-Jet	Petrol	88	09/07 →

DOBLO Cassone / Furgonato / Promiscuo (263)

1.4	Petrol	88	10/11 →
1.4 Natural Power	BiFuel	88	06/10 →

DOBLO Combi (152, 263)

1.4	Petrol	88	10/11 →
1.4 Natural Power	BiFuel	88	06/10 →

LINEA (323)

1.4 T-Jet	Petrol	88	09/07 →
-----------	--------	----	---------

PUNTO / GRANDE PUNTO (199)

1.4 Abarth	Petrol	114	12/07 →
1.4 Abarth	Petrol	132	12/07 →
1.4 T-Jet	Petrol	88	09/07 → 12/09

LANCIA

DELTA III (844)

1.4	Petrol	88	09/08 →
1.4	Petrol	110	09/08 → 07/10
1.4 BiFuel	Petrol/ LPG	88	07/11 →

BAE680BR

**BOBINA D'ACCENSIONE
IGNITION COIL**

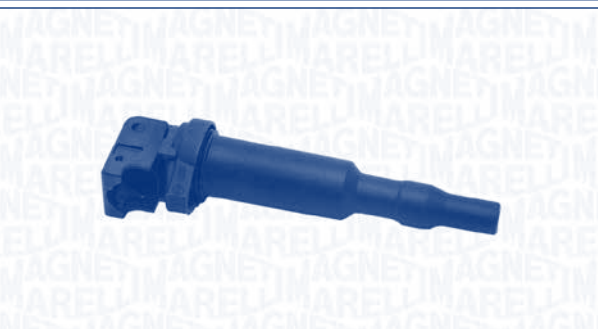

ALPINA

B7 (F01, F02)

4.4 BiTurbo	Petrol	373	09/09 → 08/11
-------------	--------	-----	---------------

BAE680BR



ALPINA

B7 (F01, F02)

4.4 BiTurbo Trazione integrale	Petrol	373	09/10 → 08/11
--------------------------------------	--------	-----	---------------

BMW

1 (E81)

130 i	Petrol	190	09/09 → 12/11
130 i	Petrol	195	09/06 → 09/12

1 Cabriolet (E88)

125 i	Petrol	160	03/08 →
135 i	Petrol	225	03/08 →

1 Coupé (E82)

125 i	Petrol	160	03/08 →
135 i	Petrol	225	10/07 →
M	Petrol	250	04/11 → 06/12

3 (E90)

323 i	Petrol	130	05/06 → 12/11
325 i	Petrol	160	01/05 → 12/11
325 xi	Petrol	160	01/05 → 12/11
330 xi	Petrol	190	05/06 → 09/07
335 i	Petrol	225	09/06 → 12/11
335 i xDrive	Petrol	225	09/08 → 12/11
335 xi	Petrol	225	09/07 → 12/11

3 Cabriolet (E93)

323 i	Petrol	130	03/07 →
325 i	Petrol	160	03/07 →
330 i	Petrol	190	03/07 →
335 i	Petrol	225	03/07 →

3 Coupé (E92)

323 i	Petrol	130	06/06 →
325 i	Petrol	160	09/06 →
325 xi	Petrol	160	09/06 →
330 i	Petrol	190	09/06 →
330 xi	Petrol	190	09/06 → 09/07
330 xi	Petrol	200	09/06 → 09/07
335 i	Petrol	225	09/06 →
335 i xDrive	Petrol	225	09/08 →
335 xi	Petrol	225	09/06 →

3 Touring (E91)

323 i	Petrol	130	05/06 → 06/07
325 i	Petrol	160	09/05 →
325 xi	Petrol	160	09/05 →
330 i	Petrol	190	09/05 →
330 xi	Petrol	190	05/06 → 09/07
335 i	Petrol	225	09/06 → 02/10

BAE680BR

BMW

335 i xDrive	Petrol	225	09/08 → 02/10
335 xi	Petrol	225	09/07 → 08/08
5 (E60)			
523 i	Petrol	130	07/05 → 03/10
525 i	Petrol	160	07/05 → 03/10
525 xi	Petrol	160	05/06 → 03/07
5 (F10, F18)			
528 i	Petrol	190	03/10 →
550 i	Petrol	300	03/10 →
550 i xDrive	Petrol	300	09/10 →
M	Petrol	412	09/11 →
5 Gran Turismo (F07)			
550 i	Petrol	300	10/09 →
550 i xDrive	Petrol	300	09/10 →
5 Touring (E61)			
523 i	Petrol	130	07/05 →
525 i	Petrol	160	07/05 →
525 xi	Petrol	160	05/06 → 03/07
530 i	Petrol	190	07/05 →
530 i	Petrol	200	01/07 →
5 Touring (F11)			
550i	Petrol	300	03/11 →
6 (E63)			
630 i	Petrol	190	09/04 →
6 Cabriolet (E64)			
630 i	Petrol	190	09/04 →
6 Cabriolet (F12)			
650 i	Petrol	300	03/11 → 06/12
650i xDrive	Petrol	300	09/11 → 06/12
M	Petrol	412	03/12 →
6 Coupé (F13)			
650 i	Petrol	300	10/11 → 06/12
650i xDrive	Petrol	300	10/11 → 06/12
M	Petrol	412	09/12 →
7 (E65, E66, E67)			
730 i, Li	Petrol	190	03/05 →
7 (F01, F02, F03, F04)			
730 i	Petrol	190	05/09 →
740 i	Petrol	240	10/08 →
750 i	Petrol	300	10/08 →
750 i xDrive	Petrol	300	09/09 →
760 i	Petrol	400	09/09 →
ActiveHybrid	Hybrid	330	10/10 →

BAE680BR

BMW

X1 (E84)			
xDrive 25 i	Petrol	160	03/10 →
xDrive 28 i	Petrol	190	10/09 → 08/11
X3 (E83)			
2.5 si	Petrol	160	09/06 →
3.0 si	Petrol	200	09/06 →
xDrive 25 i	Petrol	160	09/08 → 08/10
xDrive 30 i	Petrol	200	09/08 →
X3 (F25)			
xDrive 28 i	Petrol	190	04/11 →
X5 (E70)			
3.0 si	Petrol	200	02/07 → 09/08
M	Petrol	408	09/09 →
xDrive 30 i	Petrol	200	09/08 → 03/10
xDrive 50 i	Petrol	300	06/10 →
X6 (E71, E72)			
35 i	Petrol	225	05/08 →
50 i	Petrol	300	05/08 →
M	Petrol	408	09/09 →
xDrive 35 i	Petrol	225	09/08 →
xDrive 50 i	Petrol	300	09/08 →
Z4 (E85)			
2.5 i	Petrol	130	01/06 →
2.5 si	Petrol	160	01/06 →
Z4 (E89)			
sDrive 23 i	Petrol	150	05/09 → 08/11
sDrive 30 i	Petrol	190	05/09 →
sDrive 35 i	Petrol	225	05/09 →
sDrive 35 is	Petrol	250	09/10 →
CITROËN			
BERLINGO (B9)			
1.6 VTi 120	Petrol	88	11/09 →
1.6 VTi 95	Petrol	72	07/10 →
BERLINGO Furgonato (B9)			
1.6 VTi 120	Petrol	88	11/09 →
1.6 VTi 95	Petrol	72	07/10 →
C3 II			
1.4 VTi 95	Petrol	70	11/09 →
1.6 VTi 120	Petrol	88	11/09 →
C3 Picasso			
1.4 VTi 95	Petrol	70	02/09 →
1.6 VTi 120	Petrol	88	02/09 →
C4 Coupé (LA_)			
1.6 VTi 120	Petrol	88	07/08 → 07/10

BAE680BR



KW



CITROËN

C4 Grand Picasso I (UA_)

1.6 VTi 120 Petrol 88 07/08 →

C4 I (LC_)

1.6 VTi 120 Petrol 88 07/08 → 09/10

C4 II (B7)

1.4 VTi 95 Petrol 70 09/10 →

1.6 VTi 120 Petrol 88 09/10 →

1.6 VTi 120 LPG Petrol/
LPG 88 09/11 →

C4 Picasso I (UD_)

1.6 VTi 120 Petrol 88 07/08 →

C5 III (RD_)

1.6 VTi 120 Petrol 88 09/10 →

C5 III Break (TD_)

1.6 VTi 120 Petrol 88 09/10 →

DS3

1.4 VTi 95 Petrol 70 04/10 →

1.6 VTi 120 Petrol 88 04/10 →

MINI

MINI (R56)

Cooper Petrol 88 10/06 →

Cooper Petrol 90 03/10 →

Cooper Petrol 85 03/10 →

One Petrol 55 03/09 → 02/10

One Petrol 70 03/07 → 02/10

One Petrol 72 03/10 →

One Petrol 55 03/10 →

MINI Cabriolet (R57)

Cooper Petrol 88 03/09 →

Cooper Petrol 90 03/10 →

Cooper Petrol 85 03/09 →

One Petrol 72 03/10 →

MINI CLUBMAN (R55)

Cooper Petrol 88 10/07 →

Cooper Petrol 90 03/10 →

Cooper Petrol 85 03/10 →

One Petrol 72 03/10 →

One Petrol 70 03/09 → 02/10

MINI COUNTRYMAN (R60)

Cooper Petrol 85 06/10 →

Cooper Petrol 90 06/10 →

One Petrol 72 09/10 →

MINI Coupé (R58)

Cooper Petrol 85 09/11 →

Cooper Petrol 90 09/11 →

BAE680BR



KW



MINI

MINI Roadster (R59)

Cooper Petrol 85 02/12 →

Cooper Petrol 90 02/12 →

PEUGEOT

207 (WA_, WC_)

1.4 16V Petrol 70 06/07 → 04/12

1.6 16V VTi Petrol 88 03/07 → 12/11

207 CC (WD_)

1.6 16V Petrol 88 03/07 →

207 SW (WK_)

1.4 16V Petrol 70 06/07 →

1.6 16V Petrol 88 06/07 →

208

1.4 Petrol 70 03/12 →

1.6 Petrol 88 03/12 →

3008

1.6 VTi Petrol 88 06/09 →

308 (4A_, 4C_)

1.4 16V Petrol 70 09/07 → 03/10

1.4 16V Petrol 72 04/10 →

1.6 16V Petrol 88 09/07 →

308 CC

1.6 16V Petrol 88 06/09 →

308 SW

1.4 16V Petrol 70 05/08 → 03/10

1.4 16V Petrol 72 04/10 →

1.6 16V Petrol 88 05/08 →

5008

1.6 16V Petrol 88 09/09 →

508

1.6 VTi Petrol 85 11/10 →

508 SW

1.6 VTi Petrol 85 11/10 →

RANCH

1.6 Petrol 88 04/10 →

1.6 Petrol 72 08/10 →

RANCH Furgonato

1.6 Petrol 72 11/10 →

1.6 Petrol 88 04/10 →

ROLLS-ROYCE

GHOST

6.6 V12 Petrol 420 12/09 →

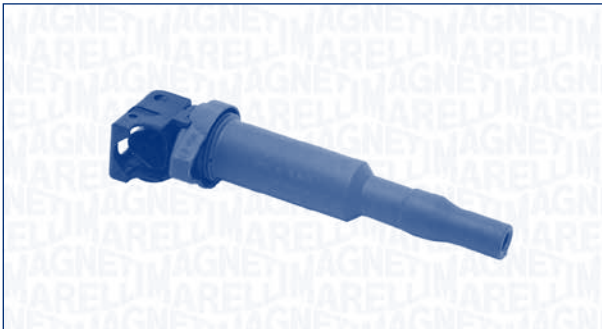
BAE680BS
**BOBINA D'ACCENSIONE
IGNITION COIL**

KW

BMW
1 (E81)

116 i	Petrol	90	09/07 → 11/11
116 i	Petrol	90	03/09 → 12/11
118 i	Petrol	105	05/07 → 12/11
118 i	Petrol	95	05/07 → 12/11
120 i	Petrol	110	05/07 → 12/11
120 i	Petrol	120	05/07 → 12/11
120 i	Petrol	125	05/07 → 12/11

1 Cabriolet (E88)

118 i	Petrol	105	03/08 → 02/12
120 i	Petrol	120	03/08 → 02/12
120 i	Petrol	125	03/08 → 02/12

1 Coupé (E82)

120 i	Petrol	125	09/09 → 02/12
-------	--------	-----	---------------

3 (E90)

316 i	Petrol	90	09/07 → 10/11
318 i	Petrol	105	09/07 → 10/11
320 i	Petrol	125	09/07 → 12/11
325 i	Petrol	160	09/07 → 12/11
325 i xDrive	Petrol	160	09/08 → 10/11
325 xi	Petrol	160	09/07 → 08/08
330 i	Petrol	200	09/07 → 10/11
330 i xDrive	Petrol	200	09/08 → 10/11
330 xi	Petrol	200	09/07 → 08/08

3 Cabriolet (E93)

318i	Petrol	105	03/10 → 02/12
320 i	Petrol	125	03/07 → 02/12
325 i	Petrol	160	03/07 → 02/12
330 i	Petrol	200	03/07 → 02/12

3 Coupé (E92)

318i	Petrol	105	03/10 → 02/12
320 i	Petrol	125	03/07 → 02/12
325 i	Petrol	160	09/07 → 02/12
325 i xDrive	Petrol	160	09/08 → 02/12

BAE680BS

KW

BMW
3 Coupé (E92)

325 xi	Petrol	160	09/07 → 08/08
330 i	Petrol	200	09/07 → 02/12
330 i xDrive	Petrol	200	09/08 → 02/12
330 xi	Petrol	200	09/07 → 08/08

3 Touring (E91)

316 i	Petrol	90	09/08 → 02/12
318 i	Petrol	105	09/07 → 02/12
318i	Petrol	100	09/07 → 02/12
320 i	Petrol	125	09/07 → 02/12
325 i	Petrol	160	09/07 → 02/12
325 i xDrive	Petrol	160	09/08 → 02/12
325 xi	Petrol	160	09/07 → 08/08
325i	Petrol	155	01/12 → 02/12
330 i	Petrol	200	09/07 → 02/12
330 i xDrive	Petrol	200	09/08 → 02/12
330 xi	Petrol	200	09/07 → 08/08

5 (E60)

520 i	Petrol	125	09/07 → 02/10
523 i	Petrol	140	03/07 → 02/10
525 i	Petrol	160	03/07 → 02/10
525 i xDrive	Petrol	160	09/08 → 02/10
525 xi	Petrol	160	03/07 → 08/08
530 i	Petrol	200	03/07 → 02/10
530 i xDrive	Petrol	200	09/08 → 02/10
530 xi	Petrol	200	03/07 → 08/08

5 (F10, F18)

523 i	Petrol	150	03/10 → 08/11
528 i	Petrol	190	03/10 → 08/11
530i	Petrol	200	09/11 → 02/12

5 Touring (E61)

520 i	Petrol	125	09/07 → 08/10
523 i	Petrol	140	03/07 → 08/10
525 i	Petrol	160	03/07 → 08/10
525 i xDrive	Petrol	160	09/08 → 08/10
525 xi	Petrol	160	03/07 → 08/08
530 i	Petrol	200	03/07 → 08/10
530 i xDrive	Petrol	200	09/08 → 08/10
530 xi	Petrol	200	03/07 → 08/08

5 Touring (F11)

523 i	Petrol	150	09/10 → 08/11
528 i	Petrol	190	09/10 → 08/11
530i	Petrol	200	09/11 → 02/12

6 (E63)

630 i	Petrol	200	09/07 → 07/10
-------	--------	-----	---------------

BAE680BS



BMW

6 Cabriolet (E64)

630 i Petrol 200 09/07 → 07/10

BAE680BT

**BOBINA D'ACCENSIONE
IGNITION COIL**

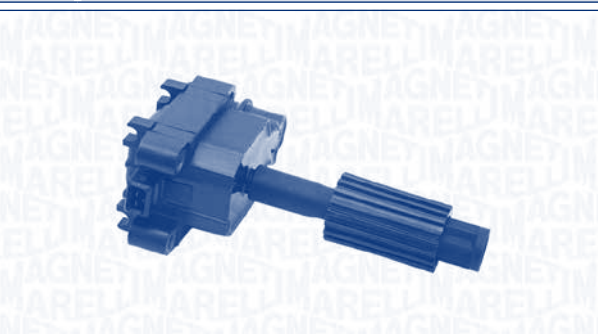

FORD

ESCORT V (GAL)

RS 2000 Petrol 110 05/91 → 12/92

ESCORT VI (GAL)

RS 2000 Petrol 110 09/92 → 12/94

RS 2000 4x4 Petrol 110 08/93 → 12/94

ESCORT VII (GAL, AAL, ABL)

RS 2000 Petrol 110 02/95 → 08/96

RS 2000 4x4 Petrol 110 02/95 → 08/96

SCORPIO II (GFR, GGR)

2.0 i 16V Petrol 100 10/94 → 04/96

SCORPIO II Station wagon (GNR, GGR)

2.0 i 16V Petrol 100 10/94 → 04/96

TRANSIT Autobus (FD __, FB __, FS __, FZ __, FC __)

2.3 16V [RWD]
(F_B_, F_C_,
F_A_) Petrol 107 12/00 → 05/06

TRANSIT Furgonato (FA __)

2.3 Petrol 105 08/01 → 03/06

2.3 Petrol 107 03/01 → 03/06

2.3 16V [RWD]
(FAA_, FAB_,
FAC_) Petrol 107 04/01 → 05/06

TRANSIT Pianale piatto/Telaio (FM __, FN __)

2.3 16V (F_A_,
F_B_, F_C_,
F_D_) Petrol 107 04/01 → 05/06

BAE680BU

**BOBINA D'ACCENSIONE
IGNITION COIL**

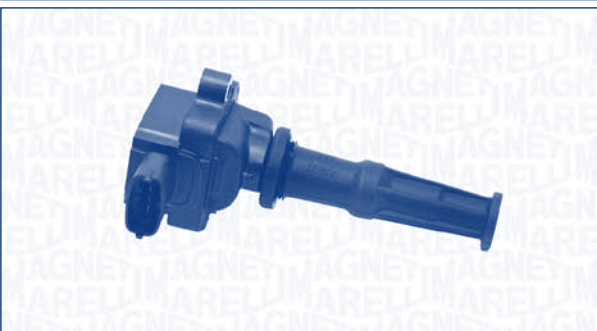

FORD

MONDEO III (B5Y)

1.8 SCi Petrol 96 06/03 → 03/07

MONDEO III Station wagon (BWY)

1.8 SCi Petrol 96 06/03 → 03/07

MONDEO III Tre volumi (B4Y)

1.8 SCi Petrol 96 06/03 → 03/07

BAE680BV

**BOBINA D'ACCENSIONE
IGNITION COIL**



VOLVO

C30

2.4 i Petrol 125 10/06 → 07/10

T5 Petrol 162 10/06 → 07/07

C70 II Cabriolet

2.4 Petrol 103 03/06 → 07/10

2.4 i Petrol 125 03/06 → 07/10

T5 Petrol 169 03/07 →

T5 Petrol 162 03/06 →

S40 II (MS)

2.4 Petrol 125 01/04 →

2.4 Petrol 103 01/04 → 07/10

T5 Petrol 162 01/04 →

BAE680BV

BMW
S40 II (MS)

T5	Petrol	169	03/07 →
T5 AWD	Petrol	162	04/04 →
T5 AWD	Petrol	169	03/07 →

S60 I

2.0 T	Petrol	132	08/04 → 07/09
2.4	Petrol	125	09/04 → 08/05
2.4 AWD	Petrol	191	02/04 → 04/10
2.4 T5	Petrol	191	04/04 → 04/10
2.5 T	Petrol	154	09/04 → 07/09
2.5 T AWD	Petrol	154	09/04 → 07/09
R 2,5 T AWD	Petrol	221	03/03 → 04/10

S80 I (TS, XY)

2.0 T	Petrol	132	08/04 → 07/06
2.4 LTP	Petrol	132	06/04 → 07/06

S80 II (AS)

2.5 T	Petrol	147	03/06 → 07/09
2.5 T	Petrol	170	01/10 → 07/12
2.5 T FlexFuel	BiFuel	147	05/08 → 07/10
2.5 T FlexFuel	BiFuel	170	01/10 → 07/12

V40 2 volumi /Coda spiovente

T4	Petrol	132	07/13 →
T4 AWD	Petrol	132	09/13 →
T5 AWD	Petrol	157	03/13 →

V50 (MW)

2.4	Petrol	125	04/04 →
2.4	Petrol	103	04/04 → 07/10
T5	Petrol	162	04/04 →
T5	Petrol	169	03/07 →
T5 AWD	Petrol	162	04/04 →
T5 AWD	Petrol	169	03/07 →

V70 II (SW)

2.0 T	Petrol	132	08/04 → 07/07
2.4 T5	Petrol	191	04/04 → 08/07
2.5 T	Petrol	154	09/06 → 07/07
R 2,5 T AWD	Petrol	221	03/03 → 08/07

V70 III (BW)

2.5 T	Petrol	147	08/07 → 07/10
2.5 T	Petrol	170	01/10 → 07/12
2.5 T FlexiFuel	BiFuel	147	05/08 → 07/09
2.5 T FlexiFuel	BiFuel	170	10/09 → 12/11

XC70 CROSS COUNTRY

2.5 T XC AWD	Petrol	154	09/04 → 07/07
--------------	--------	-----	---------------

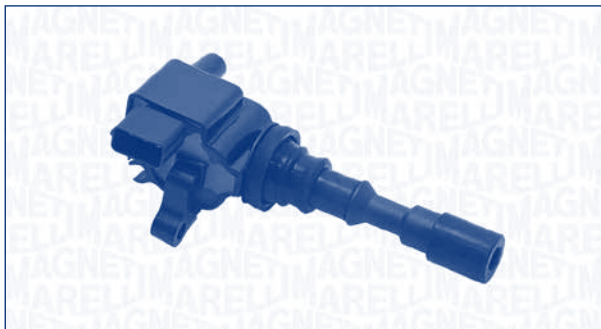
BAE680BX
**BOBINA D'ACCENSIONE
IGNITION COIL**

HYUNDAI
TERRACAN (HP)

3.5 i V6 4WD	Petrol	143	12/01 → 12/06
--------------	--------	-----	---------------

XG (XG)

350	Petrol	145	10/02 → 12/05
-----	--------	-----	---------------

KIA
CARNIVAL / GRAND CARNIVAL III (VQ)

2.7 V6	Petrol	139	06/06 →
--------	--------	-----	---------

OPIRUS (GH)

3.5	Petrol	149	09/03 →
-----	--------	-----	---------

SORENTO I (JC)

3.5 V6	Petrol	143	08/02 →
--------	--------	-----	---------

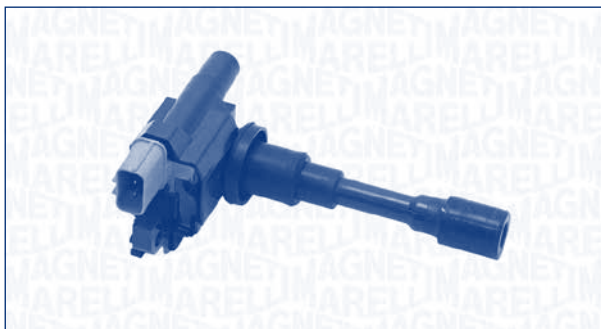
BAE680BY
**BOBINA D'ACCENSIONE
IGNITION COIL**

SUBARU
JUSTY III (G3X)

1.5	Petrol	73	09/03 →
-----	--------	----	---------

SUZUKI
ALTO IV (FF)

1.1	Petrol	46	06/02 → 12/08
-----	--------	----	---------------

BAE680BY



SUZUKI

BALENO (EG)

1.3 i 16V	Petrol	63	07/95 → 05/02
1.6 i 16V	Petrol	72	07/95 → 05/02
1.6 i 16V 4x4	Petrol	72	07/95 → 05/02

BALENO 2 volumi /Coda spiovente (EG)

1.3 i 16V	Petrol	63	07/95 → 05/02
1.6 i 16V	Petrol	72	07/95 → 05/02
1.6 i 16V 4x4	Petrol	72	07/95 → 05/02

BALENO Station wagon (EG)

1.3 16V	Petrol	63	03/97 → 05/02
---------	--------	----	---------------

CARRY Furgonato (FD)

1.3	Petrol	58	03/99 →
1.3 16 V	Petrol	58	03/00 →

IGNIS (FH)

1.3	Petrol	61	10/00 → 09/03
1.3 4WD	Petrol	61	10/00 → 09/03

IGNIS II

1.3	Petrol	69	09/03 →
1.5	Petrol	73	09/03 →
1.5 4x4	Petrol	73	09/03 →
1.5 Sport	Petrol	80	12/03 →

JIMNY (FJ)

1.3 16V	Petrol	60	02/01 →
---------	--------	----	---------

SWIFT III (MZ, EZ)

1.3	Petrol	68	02/05 →
1.5	Petrol	75	02/05 →

SX4 (GY)

1.5	Petrol	73	06/06 →
-----	--------	----	---------

WAGON R+ (MM)

1.3	Petrol	69	09/03 →
-----	--------	----	---------

BAE680BZ

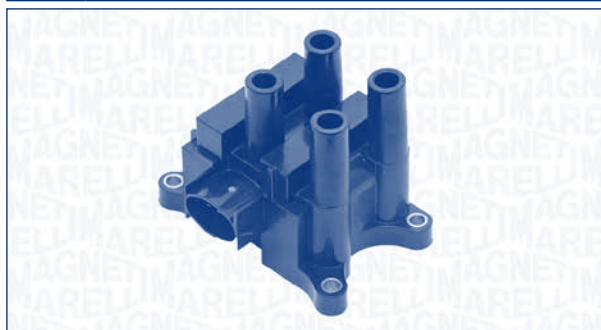
BOBINA D'ACCENSIONE
IGNITION COIL

FORD

COUGAR (EC_)

2.0 16V	Petrol	96	08/98 → 12/01
---------	--------	----	---------------

COURIER Furgonato (J5_, J3_)

1.3	Petrol	44	02/96 →
-----	--------	----	---------

ESCORT VII Station wagon (GAL, ANL)

1.3	Petrol	44	01/95 → 01/99
-----	--------	----	---------------

ESCORT VII Tre volumi (GAL, AFL)

1.3	Petrol	44	01/95 → 02/99
-----	--------	----	---------------

FIESTA V (JH_, JD_)

1.3	Petrol	44	11/01 → 06/08
1.3	Petrol	51	11/01 → 06/08
1.4 16V	Petrol	59	11/01 → 06/08
1.6 16V	Petrol	74	11/01 → 06/08

FIESTA Van

1.3	Petrol	51	10/03 →
-----	--------	----	---------

FOCUS (DAW, DBW)

1.4 16V	Petrol	55	10/98 → 11/04
1.6 16V	Petrol	74	10/98 → 11/04
1.8 16V	Petrol	85	10/98 → 11/04
2.0 16V	Petrol	96	10/98 → 11/04
RS	Petrol	158	10/02 → 11/04
ST170	Petrol	127	03/02 → 11/04

FOCUS Station wagon (DNW)

1.6 16V	Petrol	74	02/99 → 11/04
1.8 16V	Petrol	85	02/99 → 11/04
2.0 16V	Petrol	96	02/99 → 11/04

FOCUS Tre volumi (DFW)

1.6 16V	Petrol	74	02/99 → 11/04
1.8 16V	Petrol	85	02/99 → 11/04
2.0 16V	Petrol	96	02/99 → 11/04

FUSION (JU_)

1.4	Petrol	59	08/02 →
1.6	Petrol	74	08/02 →

BAE680BZ

KW

FORD
GALAXY (WGR)

2.3 16V Petrol 103 09/01 → 05/06

KA (RB_)

1.3 i Petrol 51 08/02 → 11/08

MAVERICK

2.0 16V Petrol 91 02/01 →

MONDEO II (BAP)

1.6 i 16V Petrol 70 05/98 → 11/00

MONDEO II Station wagon (BNP)

1.6 i 16V Petrol 70 05/98 → 11/00

MONDEO III (B5Y)

1.8 16V Petrol 81 11/00 → 08/07

1.8 16V Petrol 92 11/00 → 08/07

2.0 16V Petrol 107 11/00 → 08/07

MONDEO III Station wagon (BWY)

1.8 16V Petrol 81 11/00 → 08/07

1.8 16V Petrol 92 11/00 → 08/07

2.0 16V Petrol 107 11/00 → 08/07

MONDEO III Tre volumi (B4Y)

1.8 16V Petrol 81 11/00 → 08/07

1.8 16V Petrol 92 11/00 → 08/07

2.0 16V Petrol 107 11/00 → 08/07

STREET KA (RL2)

1.6 Petrol 70 05/03 → 07/05

MAZDA
121 III (JASM, JB5M)

1.25 Petrol 55 03/96 → 04/03

1.3 Petrol 44 03/96 → 04/03

2 (DY)

1.25 Petrol 55 04/03 →

1.4 Petrol 59 04/03 →

1.6 Petrol 74 04/03 →

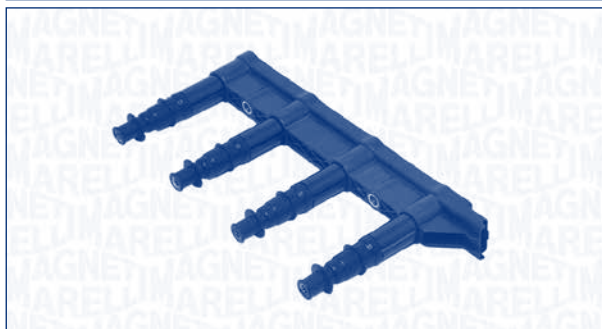
BAE680CA
**BOBINA D'ACCENSIONE
IGNITION COIL**

KW

CITROËN
C2 (JM_)

1.4 16V Petrol 65 06/06 →

C3 I (FC_)

1.4 16V Petrol 65 12/03 →

C4 I (LC_)

1.4 16V Petrol 65 11/04 →

PEUGEOT
1007 (KM_)

1.4 16V Petrol 65 10/05 →

206 2 volumi /Coda spiovente (2A/C)

1.4 16V Petrol 65 10/03 →

206 SW (2E/K)

1.4 16V Petrol 65 10/03 →

207 (WA_, WC_)

1.4 16V Petrol 65 02/06 →

307 (3A/C)

1.4 16V Petrol 65 11/03 →

307 Break (3E)

1.4 16V Petrol 65 11/03 →

307 SW (3H)

1.4 16V Petrol 65 11/03 →

BAE680CB

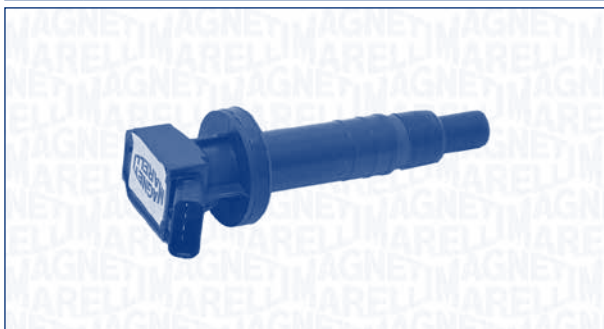
BOBINA D'ACCENSIONE
IGNITION COIL

CITROËN

C1 (PM_, PN_)

1.0 Petrol 50 06/05 →

PEUGEOT

107

1.0 Petrol 50 06/05 →

TOYOTA

AVENSIS (_T22_)

1.6 VVT-i Petrol 81 10/00 → 02/03

1.8 VVT-i Petrol 95 10/00 → 02/03

AVENSIS (T25_)

1.6 VVT-i Petrol 81 04/03 → 11/08

1.8 Petrol 95 04/03 → 11/08

AVENSIS Liftback (_T22_)

1.6 VVT-i Petrol 81 10/00 → 02/03

1.8 VVT-i Petrol 95 10/00 → 02/03

AVENSIS Station Wagon (_T22_)

1.6 VVT-i Petrol 81 10/00 → 02/03

1.8 VVT-i Petrol 95 10/00 → 02/03

AVENSIS Station wagon (T25)

1.6 VVT-i Petrol 81 04/03 → 11/08

1.8 Petrol 95 04/03 → 11/08

AVENSIS Tre volumi (T25)

1.6 VVT-i Petrol 81 04/03 → 11/08

1.8 Petrol 95 04/03 → 11/08

AYGO (WNB1_, KGB1_)

1.0 (KGB10) Petrol 50 07/05 →

COROLLA (_E11_)

1.6 16V (ZZE112_) Petrol 81 02/00 → 11/01

COROLLA (ZZE12_, NDE12_, ZDE12_)

1.4 VVT-i Petrol 71 01/02 → 12/06

1.6 VVT-i Petrol 81 01/02 → 12/06

COROLLA Compact (_E11_)

1.6 (ZZE112_) Petrol 81 02/00 → 01/02

BAE680CB



TOYOTA

COROLLA Liftback (_E11_)

1.6 (ZZE112_) Petrol 81 02/00 → 01/02

COROLLA Station wagon (_E12J_, _E12T_)

1.4 VVT-i Petrol 71 01/02 → 02/07

1.6 VVT-i Petrol 81 01/02 → 02/07

COROLLA Tre volumi (_E12J_, _E12T_)

1.4 VVT-i Petrol 71 08/02 → 07/07

1.6 VVT-i Petrol 81 08/02 → 07/07

COROLLA Verso (ZDE12_, CDE12_)

1.6 VVT-i Petrol 81 01/02 → 05/04

1.8 VVT-i Petrol 99 01/02 → 05/04

COROLLA Verso (ZER_, ZZE12_, R1_)

1.6 Petrol 81 04/04 → 03/09

1.8 Petrol 95 04/04 → 03/09

COROLLA Wagon (_E11_)

1.6 16V (ZZE112_) Petrol 81 02/00 → 10/01

MR 2 III (ZZW3_)

1.8 16V VT-i (ZZW30) Petrol 103 10/99 → 06/07

RAV 4 II (CLA2_, XA2_, ZCA2_, ACA2_)

1.8 VVTi Petrol 92 08/00 → 11/05

YARIS (SCP9_, NSP9_, KSP9_, NCP9_, ZSP9_)

1.0 VVT-i Petrol 51 08/05 →

BAE680CC

BOBINA D'ACCENSIONE
IGNITION COIL

TOYOTA

AVENSIS VERSO (_CLM2_, _ACM2_)

2.0 VVT-i Petrol 110 08/01 → 11/09

CAMRY (MCV3_, ACV3_, _XV3_)

2.4 VVT-i Petrol 112 11/01 → 11/06

BAE680CC

TOYOTA
PREVIA (MCR3_, ACR3_, CLR3_)

2.4 Petrol 115 08/00 → 01/06

RAV 4 II (CLA2_, XA2_, ZCA2_, ACA2_)

2.0 VVT-i 4WD Petrol 110 06/00 → 11/05

RAV 4 III (ACA3_, ACE_, ALA3_, GSA3_, ZSA3_)

2.0 VVT-i 4WD Petrol 112 03/06 →

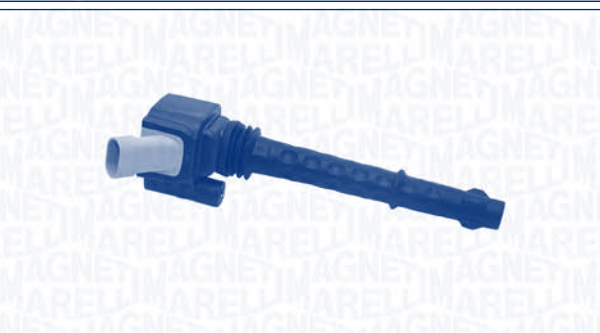
BAE680CD
**BOBINA D'ACCENSIONE
IGNITION COIL**

ALFA ROMEO
GIULIETTA (940)

1.4 TB Petrol 125 05/10 →

MITO (955)

1.4 TB Petrol 125 10/09 →

1.4 TB Petrol 99 10/09 →

FIAT
BRAVO II (198)

1.4 16V Petrol 103 03/10 →

PUNTO (199)

1.4 Turbo Multi Air Petrol 99 03/12 →

PUNTO EVO (199)

1.4 16V Petrol 99 12/09 → 12/11

1.4 Abarth Petrol 120 06/10 →

LANCIA
DELTA III (844)

1.4 16V Petrol 103 08/10 →

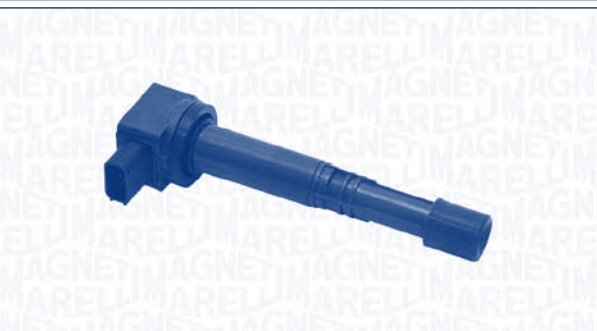
BAE680CE
**BOBINA D'ACCENSIONE
IGNITION COIL**

HONDA
ACCORD VII (CL)

2.0 (CL7) Petrol 114 02/03 →

2.4 (CL9) Petrol 140 02/03 →

ACCORD VII Tourer (CM)

2.0 (CM1) Petrol 114 04/03 →

2.4 (CM2) Petrol 140 04/03 →

CIVIC VII Hatchback (EU, EP, EV)

2.0 i Sport Petrol 118 09/01 → 09/05

2.0 Type-R Petrol 147 09/01 → 09/05

CR-V II (RD_)

2.0 Petrol 110 07/02 → 09/06

2.0 i 4WD Petrol 110 01/07 →

FR-V (BE)

2.0 Petrol 110 02/05 →

STREAM (RN)

2.0 16V Petrol 115 05/01 →

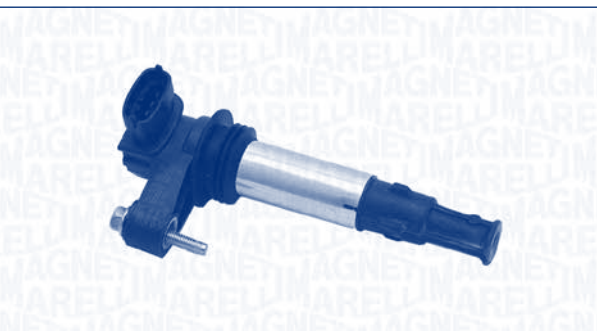
BAE680CF
**BOBINA D'ACCENSIONE
IGNITION COIL**

CADILLAC
CTS

2.8 Petrol 158 03/05 → 09/07

BAE680CF



CADILLAC

CTS

3.6	Petrol	189	03/05 → 09/07
3.6	Petrol	229	01/08 → 08/09
3.6 AWD	Petrol	229	01/08 → 08/09

CTS Coupé

3.6	Petrol	229	01/08 → 08/09
-----	--------	-----	---------------

SRX

3.6	Petrol	190	07/04 → 12/08
-----	--------	-----	---------------

3.6 Trazione posteriore	Petrol	190	01/04 → 12/08
-------------------------	--------	-----	---------------

STS

3.6	Petrol	189	05/05 →
-----	--------	-----	---------

OPEL

SIGNUM

2.8 V6 Turbo	Petrol	169	09/05 → 09/07
--------------	--------	-----	---------------

2.8 V6 Turbo	Petrol	184	01/06 → 09/08
--------------	--------	-----	---------------

VECTRA C

2.8 V6 Turbo	Petrol	169	08/05 → 09/07
--------------	--------	-----	---------------

2.8 V6 Turbo	Petrol	184	08/06 → 10/08
--------------	--------	-----	---------------

2.8 V6 Turbo	Petrol	188	08/05 → 10/08
--------------	--------	-----	---------------

VECTRA C GTS

2.8 V6 Turbo	Petrol	169	08/05 → 09/07
--------------	--------	-----	---------------

2.8 V6 Turbo	Petrol	184	08/06 → 10/08
--------------	--------	-----	---------------

2.8 V6 Turbo	Petrol	188	09/05 → 10/08
--------------	--------	-----	---------------

2.8 V6 Turbo	Petrol	206	08/06 → 10/08
--------------	--------	-----	---------------

VECTRA C Station wagon

2.8 V6 Turbo	Petrol	169	08/05 → 09/07
--------------	--------	-----	---------------

VECTRA C Station wagon

2.8 V6 Turbo	Petrol	184	01/07 → 10/08
--------------	--------	-----	---------------

2.8 V6 Turbo	Petrol	188	08/05 → 10/08
--------------	--------	-----	---------------

2.8 V6 Turbo	Petrol	206	01/07 → 10/08
--------------	--------	-----	---------------

SAAB

9-3 (YS3F)

2.8 Turbo V6	Petrol	184	03/05 →
--------------	--------	-----	---------

2.8 Turbo V6	Petrol	188	12/07 →
--------------	--------	-----	---------

2.8 Turbo V6	Petrol	203	04/08 → 06/12
--------------	--------	-----	---------------

2.8 Turbo V6 XWD	Petrol	206	05/08 →
------------------	--------	-----	---------

9-3 Cabriolet (YS3F)

2.8 Turbo V6	Petrol	184	02/06 →
--------------	--------	-----	---------

2.8 Turbo V6	Petrol	188	12/07 →
--------------	--------	-----	---------

2.8 Turbo V6	Petrol	203	02/09 → 06/12
--------------	--------	-----	---------------

2.8 Turbo V6	Petrol	206	02/09 → 06/12
--------------	--------	-----	---------------

BAE680CF



SAAB

9-3 Station wagon

2.8 Turbo V6	Petrol	184	03/05 →
--------------	--------	-----	---------

2.8 Turbo V6	Petrol	188	12/07 →
--------------	--------	-----	---------

2.8 Turbo V6	Petrol	203	05/08 → 06/12
--------------	--------	-----	---------------

2.8 Turbo V6 XWD	Petrol	206	05/08 →
------------------	--------	-----	---------

VAUXHALL

SIGNUM

2.8 V6 Turbo	Petrol	169	08/05 → 09/07
--------------	--------	-----	---------------

VECTRA Mk II (C)

2.8 V6 Turbo	Petrol	169	09/05 → 09/07
--------------	--------	-----	---------------

2.8 V6 Turbo	Petrol	184	08/06 → 07/08
--------------	--------	-----	---------------

2.8 V6 Turbo	Petrol	188	09/05 → 07/08
--------------	--------	-----	---------------

2.8 V6 Turbo	Petrol	206	10/06 → 08/08
--------------	--------	-----	---------------

VECTRA Mk II (C) GTS

2.8 V6 Turbo	Petrol	169	09/05 → 09/07
--------------	--------	-----	---------------

2.8 V6 Turbo	Petrol	184	08/06 → 07/08
--------------	--------	-----	---------------

2.8 V6 Turbo	Petrol	188	09/05 → 07/08
--------------	--------	-----	---------------

VECTRA Mk II (C) Station wagon

2.8 V6 Turbo	Petrol	169	09/05 → 09/07
--------------	--------	-----	---------------

2.8 V6 Turbo	Petrol	188	08/06 → 07/08
--------------	--------	-----	---------------

2.8 V6 Turbo	Petrol	206	01/07 → 07/08
--------------	--------	-----	---------------

BAE680CG

BOBINA D'ACCENSIONE
IGNITION COIL

TOYOTA

CELICA (ZZT23_)

1.8 16V TS (ZZT231_)	Petrol	141	08/99 → 09/05
----------------------	--------	-----	---------------

1.8 16V VT-i (ZZT230_)	Petrol	105	08/99 → 07/05
------------------------	--------	-----	---------------

COROLLA (ZZE12_, NDE12_, ZDE12_)

1.8 VVTL-i TS	Petrol	141	01/02 → 02/07
---------------	--------	-----	---------------

1.8 VVTL-i TS	Petrol	165	02/05 → 02/07
---------------	--------	-----	---------------

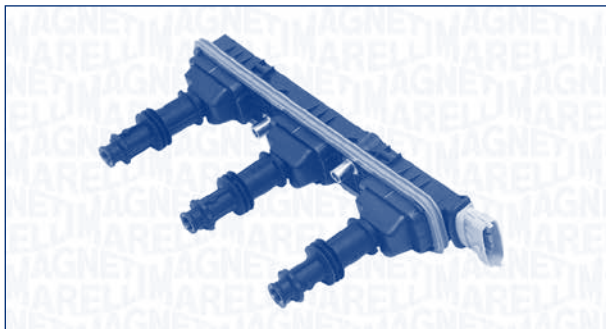
BAE680CH
**BOBINA D'ACCENSIONE
IGNITION COIL**

OPEL
SIGNUM

3.2 V6 Petrol 155 05/03 → 09/05

VECTRA C

3.2 V6 Petrol 155 08/02 → 09/05

VECTRA C GTS

3.2 V6 Petrol 155 08/02 → 09/05

VECTRA C Station wagon

3.2 V6 Petrol 155 10/03 → 09/05

VAUXHALL
SIGNUM

3.2 V6 Petrol 155 05/03 → 09/05

VECTRA Mk II (C)

3.2 V6 Petrol 155 06/03 → 09/05

VECTRA Mk II (C) GTS

3.2 V6 Petrol 155 08/02 → 09/05

VECTRA Mk II (C) Station wagon

3.2 V6 Petrol 155 10/03 → 08/05

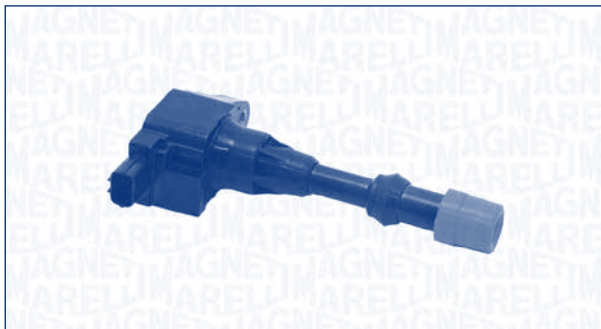
BAE680CI
**BOBINA D'ACCENSIONE
IGNITION COIL**

HONDA
CIVIC VIII Hatchback (FN, FK)

1.4 Petrol 61 01/06 →

JAZZ II (GD)

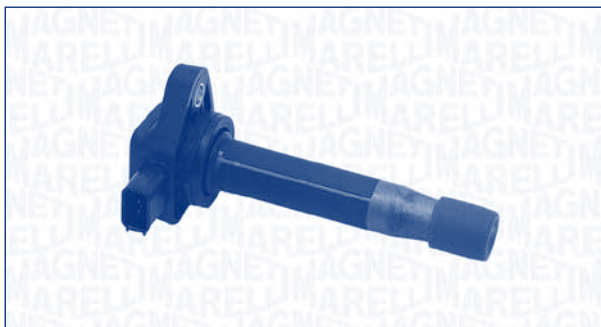
1.2 Petrol 57 03/02 → 07/08

BAE680CK
**BOBINA D'ACCENSIONE
IGNITION COIL**

HONDA
ACCORD VI Coupé (CG)

3.0 V6 24V Petrol 147 02/98 → 06/03

CIVIC VII Coupé (EM2)

1.6 i Petrol 81 02/01 → 12/05

1.7 i Petrol 88 05/01 → 12/05

1.7 i VTEC Petrol 92 05/01 → 12/05

CIVIC VII Hatchback (EU, EP, EV)

1.4 i Petrol 55 02/01 → 09/05

1.4 iS (EP1) Petrol 66 02/01 → 09/05

1.6 i Petrol 81 02/01 → 09/05

CIVIC VII Tre volumi (ES)

1.4 (ES4) Petrol 66 12/00 → 09/05

1.6 Petrol 81 02/01 → 09/05

BAE680CK



CADILLAC

FR-V (BE)

1.7 Petrol 92 08/04 →

LEGEND IV (KB_)

3.5 V6 4WD Petrol 217 05/06 →

STREAM (RN)

1.7 16V Petrol 92 05/01 →

BAE680CL

**BOBINA D'ACCENSIONE
IGNITION COIL**

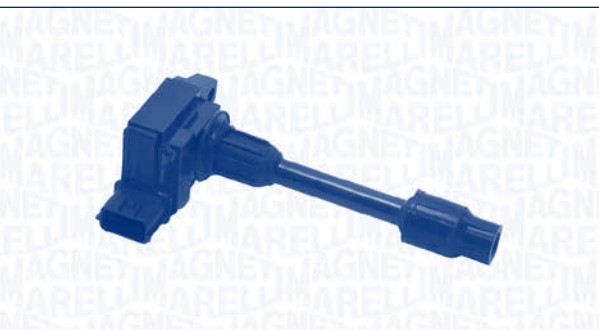

NISSAN

MAXIMA II (J30)

3.0 i Petrol 125 10/88 → 06/94

BAE680CM

**BOBINA D'ACCENSIONE
IGNITION COIL**

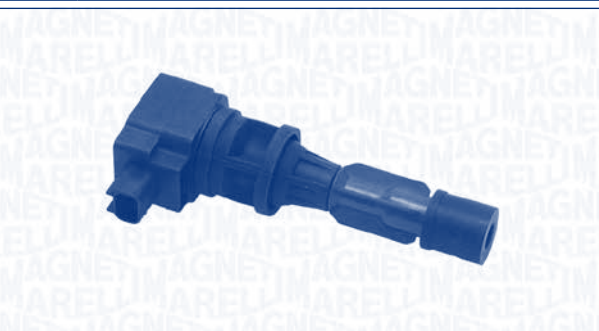

FORD

GALAXY (WA6)

2.3 Petrol 118 07/07 →

MONDEO IV (BA7)

2.3 Petrol 118 07/07 →

BAE680CM



SAAB

MONDEO IV Tre volumi (BA7)

2.3 Petrol 118 07/07 →

MONDEO IV Turnier (BA7)

2.3 Petrol 118 07/07 →

S-MAX (WA6)

2.3 Petrol 118 07/07 →

BAE680CN

**BOBINA D'ACCENSIONE
IGNITION COIL**



SEAT

Mii (KF1_)

1.0 Petrol 44 10/11 →

1.0 Petrol 55 10/11 →

SKODA

CITIGO

1.0 Petrol 44 10/11 →

1.0 Petrol 55 10/11 →

VOLKSWAGEN

UP

1.0 Petrol 44 08/11 →

1.0 Petrol 55 08/11 →

BAE680CO
**BOBINA D'ACCENSIONE
IGNITION COIL**

KW

AUDI
A4 (8K2, B8)

1.8 TFSI Petrol 125 11/11 →

1.8 TFSI quattro Petrol 125 11/11 →

A4 Avant (8K5, B8)

1.8 TFSI Petrol 125 11/11 →

1.8 TFSI quattro Petrol 125 11/11 →

A5 Sportback (8TA)

1.8 TFSI Petrol 125 08/11 →

BAE680CP
**BOBINA D'ACCENSIONE
IGNITION COIL**

KW

RENAULT
GRAND SCÉNIC III (JZ0/1_)

1.4 16V (JZ0F) Petrol 96 02/09 →

MEGANE CC (EZ0/1_)

1.4 TCe (EZ0F, EZ1V) Petrol 96 06/10 →

MEGANE III 2 volumi /Coda spiovente (BZ0_)

1.4 TCe (BZ0F, BZ1V) Petrol 96 04/09 →

BAE680CP

KW

RENAULT
MEGANE III Coupé (DZ0/1_)

1.4 TCe (DZ0F, DZ1V) Petrol 96 04/09 →

MEGANE III Grandtour (KZ0/1)

1.4 TCe (KZ0F, KZ1V) Petrol 96 05/09 →

SCÉNIC III (JZ0/1_)

1.4 16V (JZ0F) Petrol 96 02/09 →

BAE680CQ
**BOBINA D'ACCENSIONE
IGNITION COIL**

KW

MERCEDES-BENZ
CLASSE C (W203)

C 230 (203.052) Petrol 150 06/06 → 02/07 ENGINE: 30417697 →

C 280 (203.054) Petrol 170 06/06 → 02/07 ENGINE: 30417697 →

C 280 4-matic (203.092) Petrol 170 06/06 → 02/07 ENGINE: 30417697 →

C 350 (203.056) Petrol 200 06/06 → 02/07 ENGINE: 30417697 →

C 350 4-matic (203.087) Petrol 200 06/06 → 02/07 ENGINE: 30417697 →

CLASSE C (W204)

C 230 (204.052) Petrol 150 01/07 →

C 230 4-matic (204.085) Petrol 150 07/07 →

C 280 (204.054) Petrol 170 01/07 →

C 280 4-matic (204.081) Petrol 170 07/07 →

C 300 (204.054) Petrol 170 07/09 →

C 300 4-matic (204.081) Petrol 170 07/07 →

C 350 (204.056) Petrol 200 01/07 →

C 350 4-matic (204.087) Petrol 200 07/07 →

BAE680CQ



MERCEDES-BENZ

CLASSE C Sportcoupe (CL203)

C 230 (203.752)	Petrol	150	06/06 → 05/08	ENGINE: 30417697 →
-----------------	--------	-----	---------------	--------------------

CLASSE C T-Model (S203)

C 230 (203.252)	Petrol	150	06/06 → 08/07	ENGINE: 30417697 →
-----------------	--------	-----	---------------	--------------------

C 280 (203.254)	Petrol	170	06/06 → 08/07	ENGINE: 30417697 →
-----------------	--------	-----	---------------	--------------------

C 280 4-matic (203.292)	Petrol	170	06/06 → 08/07	ENGINE: 30417697 →
-------------------------	--------	-----	---------------	--------------------

C 350 (203.256)	Petrol	200	06/06 → 08/07	ENGINE: 30417697 →
-----------------	--------	-----	---------------	--------------------

C 350 4-matic (203.287)	Petrol	200	06/06 → 08/07	ENGINE: 30417697 →
-------------------------	--------	-----	---------------	--------------------

CLASSE C T-Model (S204)

C 230 (204.252)	Petrol	150	08/07 →	
-----------------	--------	-----	---------	--

C 280 (204.254)	Petrol	170	08/07 →	
-----------------	--------	-----	---------	--

C 350 (204.256)	Petrol	200	08/07 →	
-----------------	--------	-----	---------	--

CLASSE CLC (CL203)

CLC 230 (203.752)	Petrol	150	05/08 → 06/11	
-------------------	--------	-----	---------------	--

CLC 350 (203.756)	Petrol	200	05/08 → 06/11	
-------------------	--------	-----	---------------	--

CLASSE E (W211)

E 230 (211.052)	Petrol	150	09/07 → 12/08	
-----------------	--------	-----	---------------	--

E 280 (211.054)	Petrol	170	06/06 → 12/08	ENGINE: 30417697 →
-----------------	--------	-----	---------------	--------------------

E 280 4-matic (211.092)	Petrol	170	06/06 → 12/08	ENGINE: 30417697 →
-------------------------	--------	-----	---------------	--------------------

E 350 (211.056)	Petrol	200	06/06 → 12/08	ENGINE: 30417697 →
-----------------	--------	-----	---------------	--------------------

E 350 4-matic (211.087)	Petrol	200	06/06 → 12/08	ENGINE: 30417697 →
-------------------------	--------	-----	---------------	--------------------

E 500 (211.072)	Petrol	285	06/06 → 12/08	ENGINE: 30061424 →
-----------------	--------	-----	---------------	--------------------

E 500 4-matic (211.090)	Petrol	285	06/06 → 12/08	ENGINE: 30061424 →
-------------------------	--------	-----	---------------	--------------------

CLASSE E (W212)

E 350 4-matic (212.087)	Petrol	200	01/09 → 08/11	
-------------------------	--------	-----	---------------	--

E 500 (212.072)	Petrol	285	01/09 →	
-----------------	--------	-----	---------	--

E 500 4-matic (212.090)	Petrol	285	01/09 →	
-------------------------	--------	-----	---------	--

CLASSE E Cabriolet (A207)

E 500 (207.472)	Petrol	285	01/10 →	
-----------------	--------	-----	---------	--

CLASSE E Coupé (C207)

E 500 (207.372)	Petrol	285	01/09 →	
-----------------	--------	-----	---------	--

CLASSE E T-Model (S211)

E 230 T (211.252)	Petrol	150	05/07 → 07/09	
-------------------	--------	-----	---------------	--

E 280 T (211.254)	Petrol	170	06/06 → 07/09	ENGINE: 30417697 →
-------------------	--------	-----	---------------	--------------------

E 280 T 4-matic (211.292)	Petrol	170	06/06 → 07/09	ENGINE: 30417697 →
---------------------------	--------	-----	---------------	--------------------

BAE680CQ



MERCEDES-BENZ

CLASSE E T-Model (S211)

E 350 T (211.256)	Petrol	200	06/06 → 07/09	ENGINE: 30417697 →
-------------------	--------	-----	---------------	--------------------

E 350 T 4-matic (211.287)	Petrol	200	06/06 → 07/09	ENGINE: 30417697 →
---------------------------	--------	-----	---------------	--------------------

E 500 T (211.272)	Petrol	285	06/06 → 07/09	ENGINE: 30061424 →
-------------------	--------	-----	---------------	--------------------

E 500 T 4-matic (211.290)	Petrol	285	06/06 → 07/09	ENGINE: 30061424 →
---------------------------	--------	-----	---------------	--------------------

CLASSE E T-Model (S212)

E 350 4-matic (212.287)	Petrol	200	11/09 →	
-------------------------	--------	-----	---------	--

E 500 (212.272)	Petrol	285	11/09 →	
-----------------	--------	-----	---------	--

CLASSE G Cabrio (W463)

G 500	Petrol	285	12/09 →	
-------	--------	-----	---------	--

CLASSE GL (X164)

GL 450 4-matic (164.871)	Petrol	250	09/06 →	
--------------------------	--------	-----	---------	--

GL 500 4-matic (164.886)	Petrol	285	09/06 →	
--------------------------	--------	-----	---------	--

CLASSE GLK (X204)

280 4-matic (204.981)	Petrol	170	06/08 → 06/09	
-----------------------	--------	-----	---------------	--

300 4-matic (204.981)	Petrol	170	07/09 → 04/11	
-----------------------	--------	-----	---------------	--

350 4-matic (204.987)	Petrol	200	06/08 → 04/11	
-----------------------	--------	-----	---------------	--

CLASSE M (W164)

ML 350 4-matic (164.186)	Petrol	200	06/06 →	ENGINE: 30417697 →
--------------------------	--------	-----	---------	--------------------

ML 500 4-matic (164.172)	Petrol	285	12/07 →	
--------------------------	--------	-----	---------	--

CLASSE R (W251, V251)

R 280 (251.054, 251.154)	Petrol	170	01/07 →	
--------------------------	--------	-----	---------	--

R 280 4-matic (251.062)	Petrol	170	05/07 →	
-------------------------	--------	-----	---------	--

R 300 (251.054, 251.154)	Petrol	170	07/09 →	
--------------------------	--------	-----	---------	--

R 350 (251.056, 251.156)	Petrol	200	01/07 →	ENGINE: 30417697 →
--------------------------	--------	-----	---------	--------------------

R 350 4-matic (251.065, 251.165)	Petrol	200	06/06 →	ENGINE: 30417697 →
----------------------------------	--------	-----	---------	--------------------

R 500 4-matic (251.072, 251.172)	Petrol	285	01/07 →	
----------------------------------	--------	-----	---------	--

BAE680CQ

MERCEDES-BENZ
CLASSE S (W221)

S 350 (221.056, 221.156) Petrol 200 06/06 → ENGINE: 30417697 →

S 350 4-matic (221.087, 221.187) Petrol 200 02/08 → ENGINE: 30417697 →

S 400 Hybrid (221.095, 221.195) Hybrid 205 01/09 →

S 450 (221.070, 221.170) Petrol 250 06/06 → ENGINE: 30061424 →

S 450 4-matic (221.084, 221.184) Petrol 250 06/06 → ENGINE: 30061424 →

S 500 (221.071, 221.171) Petrol 285 06/06 → ENGINE: 30061424 →

S 500 4-matic (221.086, 221.186) Petrol 285 06/06 → ENGINE: 30061424 →

CLASSE S Coupé (C216)

CL 500 (216.371) Petrol 285 06/06 → ENGINE: 30061424 →

CL 500 4-matic (216.386) Petrol 285 02/08 →

CLK (C209)

280 (209.354) Petrol 170 06/06 → 05/09 ENGINE: 30417697 →

350 (209.356) Petrol 200 06/06 → 05/09 ENGINE: 30417697 →

500 (209.372) Petrol 285 06/06 → 05/09 ENGINE: 30061424 →

CLK Cabriolet (A209)

CLK 280 (209.454) Petrol 170 06/06 → 03/10 ENGINE: 30417697 →

CLK 350 (209.456) Petrol 200 06/06 → 03/10 ENGINE: 30417697 →

CLK 500 (209.472) Petrol 285 06/06 → 03/10 ENGINE: 30061424

CLS (C219)

CLS 280 (219.354) Petrol 170 07/08 → 12/10

CLS 300 (219.354) Petrol 170 04/09 → 12/10

CLS 350 (219.356) Petrol 200 06/06 → 12/10 ENGINE: 30417697 →

CLS 500 (219.372) Petrol 285 06/06 → 12/10 ENGINE: 30061424 →

BAE680CQ

MERCEDES-BENZ
SL (R230)

280 Petrol 170 03/08 → 01/12

300 Petrol 170 04/09 → 01/12

350 Petrol 232 04/08 → 01/12

350 Petrol 200 06/06 → 01/12 ENGINE: 30417697 →

500 Petrol 285 06/06 → 01/12 ENGINE: 30061424 →

SLK (R171)

280 (171.454) Petrol 170 06/06 → 02/11 ENGINE: 30417697 →

300 (171.454) Petrol 170 04/09 → 02/11

350 (171.456) Petrol 200 06/06 → 02/11 ENGINE: 30417697 →

350 (171.458) Petrol 224 01/08 → 02/11

SPRINTER 3,5-t Autobus (906)

324 (906.733, 906.735) Petrol 190 06/06 →

SPRINTER 3,5-t Furgonato (906)

324 (906.633, 906.635, 906.637) Petrol 190 06/06 →

SPRINTER 3,5-t Pianale piatto/Telaio (906)

324 (906.133, 906.135, 906.233, 906.235) Petrol 190 06/06 →

SPRINTER 3-t Autobus (906)

224 (906.713) Petrol 190 06/06 →

SPRINTER 3-t Furgonato (906)

224 (906.613) Petrol 190 06/06 →

SPRINTER 3-t Pianale piatto/Telaio (906)

224 (906.113, 906.213) Petrol 190 06/06 →

SPRINTER 4,6-t Furgonato (906)

424 (906.953, 906.655, 906.657) Petrol 190 06/06 →

SPRINTER 4,6-t Pianale piatto/Telaio (906)

424 (906.153, 906.155, 906.253, 906.255) Petrol 190 06/06 →

SPRINTER 5-t Furgonato (906)

524 (906.653, 906.655, 906.657) Petrol 190 06/06 →

SPRINTER 5-t Pianale piatto/Telaio (906)

524 (906.153, 906.155, 906.253, 906.255) Petrol 190 06/06 →

BAE680CQ



MERCEDES-BENZ

VIANO (W639)

3.5 Petrol 190 09/07 →

VITO / MIXTO Furgonato (W639)

126 Petrol 190 09/07 →

VITO Autobus (W639)

126 Petrol 190 09/07 →

BAE680CR

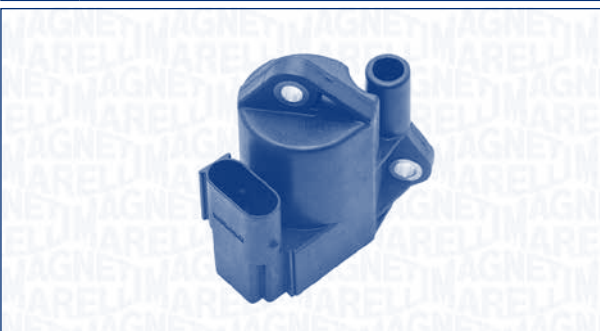
BOBINA D'ACCENSIONE
IGNITION COIL

MERCEDES-BENZ

CLASSE C (W203)

C 230 (203.052) Petrol 150 01/05 → 02/07

C 280 (203.054) Petrol 170 01/05 → 02/07

C 280 4-matic
(203.092) Petrol 170 01/05 → 02/07

C 350 (203.056) Petrol 200 01/05 → 02/07

C 350 4-matic
(203.087) Petrol 200 01/05 → 02/07

CLASSE C (W204)

C 350 CGI
(204.065) Petrol 215 09/08 →

CLASSE C Sportcoupe (CL203)

C 230 (203.752) Petrol 150 01/05 → 05/08

C 350 (203.756) Petrol 200 01/05 → 05/08

CLASSE C T-Model (S203)

C 230 (203.252) Petrol 150 01/05 → 08/07

C 280 (203.254) Petrol 170 01/05 → 08/07

C 280 4-matic
(203.292) Petrol 170 01/05 → 08/07

C 350 (203.256) Petrol 200 01/05 → 08/07

C 350 4-matic
(203.287) Petrol 200 01/05 → 08/07

BAE680CQ



MERCEDES-BENZ

CLASSE E (W211)

E 280 (211.054) Petrol 170 03/05 → 12/08

E 280 4-matic
(211.092) Petrol 170 01/06 → 12/08

E 350 (211.056) Petrol 200 03/05 → 12/08

E 350 4-matic Petrol 205 08/04 → 08/06

E 350 4-matic
(211.087) Petrol 200 03/05 → 12/08E 350 CGI
(211.057) Petrol 215 09/07 → 12/08

CLASSE E (W212)

E 350 CGI
(212.057) Petrol 215 01/09 → 08/11

CLASSE E Cabriolet (A207)

E 350 CGI
(207.457) Petrol 215 01/10 →

CLASSE E Coupé (C207)

E 350 CGI
(207.357) Petrol 215 01/09 →

CLASSE E T-Model (S211)

350 CGI (211.257) Petrol 215 05/06 → 07/09

E 280 T (211.254) Petrol 170 03/05 → 07/09

E 280 T 4-matic
(211.292) Petrol 170 03/05 → 07/09

E 350 T (211.256) Petrol 200 03/05 → 07/09

E 350 T 4-matic
(211.287) Petrol 200 03/05 → 07/09

CLASSE E T-Model (S212)

E 350 CGI
(212.257) Petrol 215 11/09 →

CLK (C209)

280 (209.354) Petrol 170 01/05 → 05/09

350 (209.356) Petrol 200 01/05 → 05/09

CLK Cabriolet (A209)

CLK 280
(209.454) Petrol 170 01/05 → 03/10CLK 350
(209.456) Petrol 200 01/05 → 03/10

CLS (C219)

CLS 350
(219.356) Petrol 200 10/04 → 12/10CLS 350
(219.357) Petrol 215 04/06 → 12/10CLS 350 CGI
(219.357) Petrol 215 04/09 → 12/10

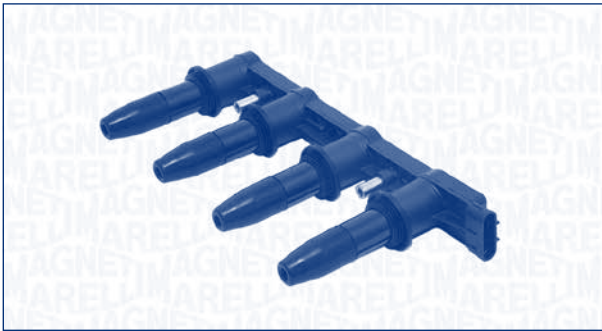
BAE680CS
**BOBINA D'ACCENSIONE
IGNITION COIL**

CHEVROLET
AVEO 2 volumi /Coda spiovente (T300)

1.6	Petrol	85	03/11 →
-----	--------	----	---------

AVEO Tre volumi (T300)

1.6	Petrol	85	03/11 →
-----	--------	----	---------

OPEL
ASTRA GTC J

1.6	Petrol	132	10/11 →
-----	--------	-----	---------

1.8	Petrol	103	10/11 →
-----	--------	-----	---------

1.6	Petrol	85	12/09 →
-----	--------	----	---------

ASTRA J

1.6 Turbo	Petrol	132	12/09 →
-----------	--------	-----	---------

ASTRA J Sports Tourer

1.6	Petrol	85	10/10 →
-----	--------	----	---------

1.6 Turbo	Petrol	132	10/10 →
-----------	--------	-----	---------

ASTRA J Tre volumi

1.6	Petrol	85	06/12 →
-----	--------	----	---------

1.6 Turbo	Petrol	132	06/12 →
-----------	--------	-----	---------

INSIGNIA

1.6	Petrol	85	07/08 →
-----	--------	----	---------

1.6 Turbo	Petrol	132	07/08 →
-----------	--------	-----	---------

1.8	Petrol	103	07/08 →
-----	--------	-----	---------

INSIGNIA Sports Tourer

1.6	Petrol	85	07/08 →
-----	--------	----	---------

1.6 Turbo	Petrol	132	01/09 →
-----------	--------	-----	---------

1.8	Petrol	103	07/08 →
-----	--------	-----	---------

INSIGNIA Tre volumi

1.6	Petrol	85	07/08 →
-----	--------	----	---------

1.6 Turbo	Petrol	132	01/09 →
-----------	--------	-----	---------

1.8	Petrol	103	07/08 →
-----	--------	-----	---------

ZAFIRA TOURER C (P12)

1.8	Petrol	85	10/11 →
-----	--------	----	---------

1.8	Petrol	103	10/11 →
-----	--------	-----	---------

1.8	Petrol	88	10/11 →
-----	--------	----	---------

BAE680CS

VAUXHALL
ASTRA GTC Mk VI (J)

1.6	Petrol	132	10/11 →
-----	--------	-----	---------

ASTRA Mk VI (J)

1.6	Petrol	85	12/09 →
-----	--------	----	---------

1.6 Turbo	Petrol	132	12/09 →
-----------	--------	-----	---------

ASTRA Mk VI (J) Sports Tourer

1.6	Petrol	85	10/10 →
-----	--------	----	---------

1.6 Turbo	Petrol	132	10/10 →
-----------	--------	-----	---------

ASTRA Mk VI (J) Tre volumi

1.6	Petrol	85	06/12 →
-----	--------	----	---------

1.6 Turbo	Petrol	132	06/12 →
-----------	--------	-----	---------

INSIGNIA

1.6	Petrol	85	07/08 →
-----	--------	----	---------

1.6 Turbo	Petrol	132	01/09 →
-----------	--------	-----	---------

1.8	Petrol	103	07/08 → 09/13
-----	--------	-----	---------------

INSIGNIA Sports Tourer

1.6	Petrol	85	07/08 →
-----	--------	----	---------

1.6 Turbo	Petrol	132	01/09 →
-----------	--------	-----	---------

1.8	Petrol	103	07/08 → 09/13
-----	--------	-----	---------------

INSIGNIA Tre volumi

1.6	Petrol	85	07/08 →
-----	--------	----	---------

1.6 Turbo	Petrol	132	01/09 →
-----------	--------	-----	---------

1.8	Petrol	103	07/08 → 09/13
-----	--------	-----	---------------

ZAFIRA Mk III (P12)

1.8	Petrol	103	10/11 →
-----	--------	-----	---------

1.8	Petrol	85	10/11 →
-----	--------	----	---------

1.8	Petrol	88	10/11 →
-----	--------	----	---------

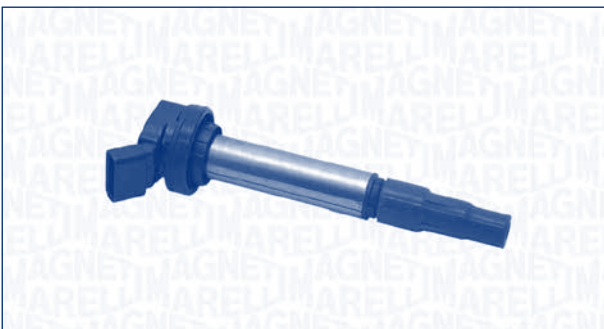
BAE680CT
**BOBINA D'ACCENSIONE
IGNITION COIL**

TOYOTA
AURIS (NRE15_, ZZE15_, ADE15_, ZRE15_, NDE15_)

1.33 Dual-VVTi	Petrol	74	05/09 →
----------------	--------	----	---------

BAE680CT



TOYOTA

AURIS (NRE15_, ZZE15_, ADE15_, ZRE15_, NDE15_)

1.6	Petrol	97	05/09 →	
1.6 VVTi	Petrol	91	03/07 →	
1.8	Petrol	108	02/09 →	

AVENSIS Station wagon (ZRT27, ADT27)

1.6	Petrol	97	02/09 →	
1.8	Petrol	108	02/09 →	
2.0	Petrol	112	02/09 →	

AVENSIS Tre volumi (ZRT27, ADT27)

1.6	Petrol	97	02/09 →	
1.8	Petrol	108	02/09 →	
2.0	Petrol	112	02/09 →	

RAV 4 III (ACA3_, ACE_, ALA3_, GSA3_, ZSA3_)

2.0	Petrol	116	12/08 →	
2.0 4WD	Petrol	116	12/08 →	

VERSO (_AUR2_, _ZGR2_)

1.6	Petrol	97	04/09 →	
1.8	Petrol	108	04/09 →	

YARIS (SCP9_, NSP9_, KSP9_, NCP9_, ZSP9_)

1.8 VVTi	Petrol	98	01/07 →	
----------	--------	----	---------	--

BAE680CU

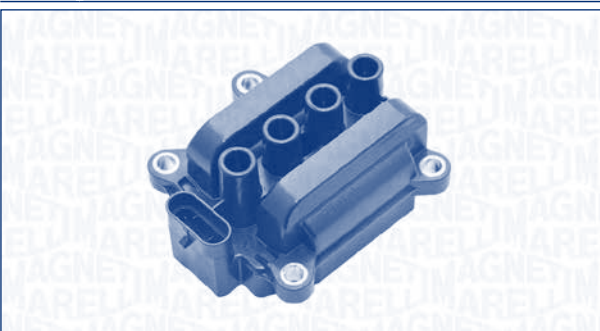
BOBINA D'ACCENSIONE
IGNITION COIL

RENAULT

CLIO Grandtour (KR0/1_)

1.2 16V Hi-Flex (KR0S)	BiFuel	55	07/08 →	
1.2 16V (KR02, KR0J)	Petrol	55	02/08 →	
1.2 16V (KR0E)	Petrol	58	02/08 →	
1.2 16V (KR0P)	Petrol	74	02/08 →	

BAE680CU



TOYOTA

CLIO III (BR0/1, CR0/1)

1.2 16V	Petrol	58	06/05 →	
1.2 16V Hi-Flex (BR1U, CR1U)	BiFuel	55	07/08 →	

1.2 16V (BR02, BR0J, BR11, CR02, CR0J, CR11)	Petrol	55	06/05 →	
--	--------	----	---------	--

1.2 16V (BR0P, CR0P)	Petrol	74	05/07 →	
----------------------	--------	----	---------	--

1.2 16V (BR0R, BR1D, BR1L, CR0R)	Petrol	48	06/05 →	
----------------------------------	--------	----	---------	--

KANGOO (KC0/1_)

1.2 16V (KC03, KC05, KC06, KC0T, KC0W)	Petrol	55	06/01 →	
--	--------	----	---------	--

KANGOO Express (FC0/1_)

1.2 16V (FC05)	Petrol	55	10/01 →	
----------------	--------	----	---------	--

MODUS / GRAND MODUS (F/JP0_)

1.2 (JP0C, JP0K, FP0C, FP0K, FP0P, JP0P, JP0T)	Petrol	55	12/04 →	
--	--------	----	---------	--

1.2 16V Hi-Flex	BiFuel	55	10/08 →	
-----------------	--------	----	---------	--

TWINGO I (C06_)

1.2 16V (C06C, C06D, C06K)	Petrol	55	01/01 →	
----------------------------	--------	----	---------	--

TWINGO II (CN0_)

1.2 16V (CN0K, CN0V)	Petrol	56	03/07 →	
----------------------	--------	----	---------	--

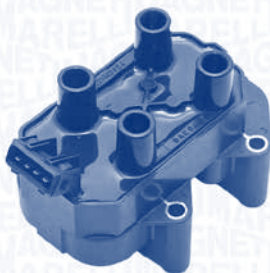
BAE680CV
**BOBINA D'ACCENSIONE
IGNITION COIL**

KW

CITROËN
AX (ZA-_)

10	Petrol	33	07/94 → 12/98
10	Petrol	37	07/94 → 12/98
11	Petrol	44	07/94 → 12/97
14	Petrol	55	07/94 → 12/96
14 4x4	Petrol	55	07/94 → 12/96

ZX (N2)

1.4 i	Petrol	55	08/92 → 08/96
-------	--------	----	---------------

ZX Break (N2)

1.4 i	Petrol	55	10/93 → 08/96
-------	--------	----	---------------

PEUGEOT
106 I (1A, 1C)

1.0	Petrol	33	07/92 → 04/96
1.0	Petrol	37	07/92 → 04/96
1.1	Petrol	44	08/92 → 04/96
1.3	Petrol	72	10/93 → 04/96
1.4	Petrol	69	09/91 → 04/96
1.4	Petrol	55	12/92 → 04/96
1.6	Petrol	65	06/93 → 04/96
1.6	Petrol	76	01/94 → 04/96

106 Van (1_)

1.0	Petrol	33	07/92 → 04/96
-----	--------	----	---------------

205 II (20A/C)

1.0	Petrol	37	08/92 → 05/97
1.4	Petrol	55	09/92 → 12/95 ENGINE: → 1808178

306 (7B, N3, N5)

1.1	Petrol	44	06/94 → 12/95
1.4 SL	Petrol	55	06/94 → 04/97
1.6 SR	Petrol	65	06/94 → 04/97

306 2 volumi /Coda spiovente (7A, 7C, N3, N5)

1.1	Petrol	44	05/93 → 12/95
1.4	Petrol	55	05/93 → 04/97
1.6	Petrol	65	05/93 → 04/97

BAE680CV

KW

PEUGEOT
405 II (4B)

1.4	Petrol	55	08/92 → 10/95
-----	--------	----	---------------

405 II Break (4E)

1.4	Petrol	55	08/92 → 10/96
-----	--------	----	---------------

ROVER
400 Tourer (XW)

2.0 i	Petrol	100	10/95 → 11/98
-------	--------	-----	---------------

600 (RH)

620 Ti Vitesse	Petrol	147	07/94 → 12/98 CHASSIS: BM246797 →
----------------	--------	-----	-----------------------------------

800 (XS)

820 16V Turbo (RS)	Petrol	132	01/96 → 01/99 CHASSIS: 230967 →
820 I/SI (RS)	Petrol	100	01/96 → 01/96 CHASSIS: 230967 →
820 Sport	Petrol	145	01/96 → 03/96 CHASSIS: 230967 →

800 2 volumi /Coda spiovente (XS)

820 16V Turbo (RS)	Petrol	132	01/96 → 01/99 CHASSIS: 230967 →
820 I/SI (XS)	Petrol	100	01/96 → 02/99 CHASSIS: 230967 →
820 Sport	Petrol	145	01/96 → 03/96 CHASSIS: 230967 →

MINI

1300	Petrol	37	04/92 → 10/96 CHASSIS: BD134455 →
1300	Petrol	37	10/92 → 09/00 CHASSIS: BD134455 →
1300	Petrol	39	01/92 → 04/95 CHASSIS: BD134455 →
1300	Petrol	39	05/96 → 10/96 CHASSIS: BD134455 →
1300	Petrol	45	01/91 → 12/91 CHASSIS: BD134455 →
1300	Petrol	46	01/92 → 09/00 CHASSIS: BD134455 →
1300	Petrol	46	10/96 → 09/00 CHASSIS: BD134455 →
1300 / Cooper	Petrol	45	06/91 → 02/94 CHASSIS: BD134455 →

MINI Cabriolet (XN)

1300	Petrol	46	09/92 → 04/95 CHASSIS: BD134455 →
1.3 S	Petrol	46	02/98 → 09/00 CHASSIS: BD134455 →

BAE680CW

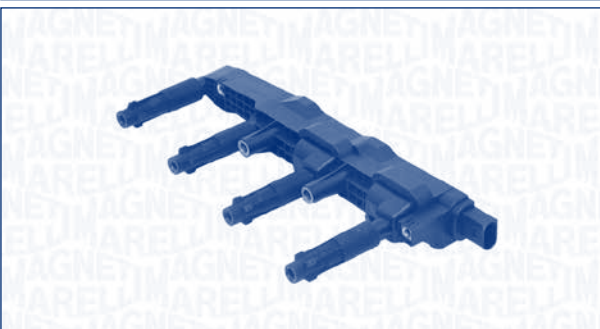
BOBINA D'ACCENSIONE
IGNITION COIL

MERCEDES-BENZ

CLASSE A (W168)

A 140 (168.031, 168.131)	Petrol	60	01/01 → 08/04
A 140 (168.031, 168.131)	Petrol	60	10/97 → 08/04
A 160 (168.033, 168.133)	Petrol	75	10/97 → 08/04
A 190 (168.032, 168.132)	Petrol	92	03/99 → 08/04
A 210 (168.035, 168.135)	Petrol	103	03/02 → 08/04

Vaneo (414)

1.6 (414.700)	Petrol	60	02/02 → 07/05
1.6 (414.700)	Petrol	75	02/02 → 07/05
1.9 (414.700)	Petrol	92	02/02 → 07/05

BAE680CX

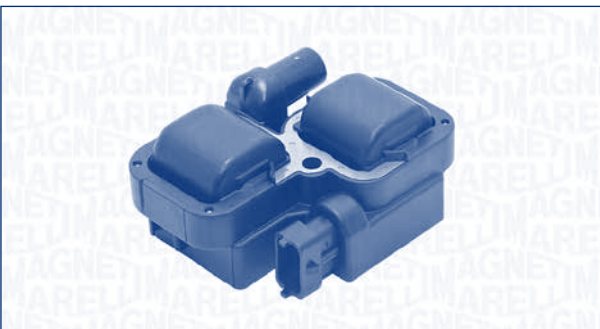
BOBINA D'ACCENSIONE
IGNITION COIL

MERCEDES-BENZ

CLASSE A (W169)

A 150 (169.031, 169.331)	Petrol	70	09/04 → 04/09
--------------------------	--------	----	---------------

BAE680CX



MERCEDES-BENZ

CLASSE A (W169)

A 160 (169.031, 169.331)	Petrol	70	04/09 → 10/11
A 170 (169.032, 169.332)	Petrol	85	09/04 → 04/09
A 180 (169.032, 169.332)	Petrol	85	04/09 → 10/11
A 200 (169.033, 169.333)	Petrol	100	09/04 → 10/11
A 200 TURBO (169.034, 169.334)	Petrol	142	09/05 → 10/10

CLASSE B (W245)

B 160 (245.231)	Petrol	70	04/09 → 04/11
B 170 (245.232)	Petrol	85	04/05 → 04/09
B 150 (245.231)	Petrol	70	04/05 → 04/09
B 170 NGT (245.233)	BiFuel	85	05/08 → 04/09
B 180 (245.232)	Petrol	85	04/09 → 04/11
B 180 NGT (245.233)	BiFuel	85	05/09 → 04/11
B 200 (245.233)	Petrol	100	04/05 → 04/11
B 200 TURBO (245.234)	Petrol	142	04/05 → 10/10

CLASSE C (W202)

C 240 (202.026)	Petrol	125	06/97 → 04/00
C 280 (202.029)	Petrol	145	06/97 → 04/00
C 43 AMG (202.033)	Petrol	225	08/97 → 05/00

CLASSE C (W203)

C 240 (203.061)	Petrol	125	05/00 → 02/07
C 240 4-matic (203.081)	Petrol	125	07/02 → 02/07
C 32 AMG Kompressor (203.065)	Petrol	260	02/01 → 02/07
C 320 (203.064)	Petrol	160	05/00 → 02/07
C 320 4-matic (203.084)	Petrol	160	07/02 → 02/07
C 55 AMG (203.076)	Petrol	270	02/04 → 02/07

CLASSE C Sportcoupe (CL203)

C 320 (203.764)	Petrol	160	09/02 → 05/08
-----------------	--------	-----	---------------

BAE680CX

MERCEDES-BENZ
CLASSE C Station wagon (S202)

C 240 T (202.086)	Petrol	125	06/97 → 09/00
C 240 T (202.088)	Petrol	125	09/00 → 02/01
C 280 T (202.089)	Petrol	145	06/97 → 02/01
C 43 AMG (202.093)	Petrol	225	10/97 → 02/01

CLASSE C T-Model (S203)

C 240 (203.261)	Petrol	125	03/01 → 08/07
C 240 4-matic (203.281)	Petrol	125	07/02 → 08/07
C 32 AMG Kompressor (203.265)	Petrol	260	03/01 → 01/04
C 320 (203.264, 203.764)	Petrol	160	03/01 → 08/07
C 320 4-matic (203.284)	Petrol	160	07/02 → 08/07
C 55 AMG (203.276)	Petrol	270	02/04 → 08/07

CLASSE E (W210)

E 240 (210.061)	Petrol	125	09/97 → 04/00
E 240 (210.062)	Petrol	125	08/00 → 03/02
E 430 (210.070)	Petrol	205	06/97 → 03/02
E 430 4-matic (210.083)	Petrol	205	05/99 → 03/02
E 55 AMG (210.074)	Petrol	260	08/97 → 03/02

CLASSE E (W211)

E 240 (211.061)	Petrol	130	03/02 → 03/05
E 240 4-matic (211.080)	Petrol	130	09/03 → 12/08
E 320 (211.065)	Petrol	165	03/02 → 12/08
E 320 4-matic (211.082)	Petrol	165	09/03 → 03/05
E 500 (211.070)	Petrol	225	03/02 → 12/08
E 500 4-matic (211.083)	Petrol	225	10/03 → 12/08
E 55 AMG Kompressor (211.076)	Petrol	350	10/02 → 12/08

BAE680CX

MERCEDES-BENZ
CLASSE E (W212)

E 300 (212.055)	Petrol	185	07/11 →
-----------------	--------	-----	---------

CLASSE E Station wagon (S210)

E 240 T (210.261)	Petrol	125	09/97 → 01/03
E 240 T (210.262)	Petrol	125	08/00 → 01/03
E 280 T (210.263)	Petrol	150	12/96 → 01/03
E 430 T (210.270)	Petrol	205	06/97 → 03/03
E 430 T 4-matic (210.283)	Petrol	205	05/99 → 01/03
E 55 T AMG (210.274)	Petrol	260	08/97 → 03/03

CLASSE E T-Model (S211)

E 240 T (211.261)	Petrol	130	03/03 → 03/05
E 240 T 4-matic (211.280)	Petrol	130	09/03 → 07/09
E 320 T (211.265)	Petrol	165	03/03 → 07/09
E 320 T 4-matic (211.282)	Petrol	165	09/03 → 03/05
E 500 T (211.270)	Petrol	225	10/03 → 03/06
E 500 T 4-matic (211.283)	Petrol	225	10/03 → 07/09
E 55 T AMG Kompressor (211.276)	Petrol	350	07/03 → 07/09

CLASSE G (W463)

G 320 (463.232, 463.233, 463.244, 463.245)	Petrol	158	07/97 → 11/97
G 500 (463.247, 463.248, 463.249, 463.240, 463.421)	Petrol	218	04/98 → 09/05
G 55 AMG (463.243, 463.246)	Petrol	260	04/99 → 03/04
G 55 AMG (463.270, 463.271)	Petrol	350	06/04 →
G 55 AMG (463.270, 463.271)	Petrol	368	08/06 →
G 55 AMG (463.270, 463.271)	Petrol	373	08/08 →

BAE680CX



KW



MERCEDES-BENZ

CLASSE G Cabrio (W463)

G 320 (463.209) Petrol 158 12/97 → 08/06

G 500 (463) Petrol 218 04/98 → 09/05

CLASSE M (W163)

ML 320 (163.154) Petrol 160 02/98 → 08/02

ML 350 Petrol 173 02/03 → 06/05

ML 350 (163.157) Petrol 180 08/02 → 01/03

ML 430 (163.172) Petrol 200 02/98 → 06/05

ML 500 (163.175) Petrol 215 09/01 → 06/05

ML 55 AMG
(163.174) Petrol 255 02/00 → 06/05

CLASSE M (W164)

ML 500 4-matic
(164.175) Petrol 225 07/05 →

CLASSE R (W251, V251)

R 500 4-matic
(251.075,
251.175) Petrol 225 01/06 →

CLASSE S (W220)

S 280 (220.063,
220.163) Petrol 150 01/99 → 08/05S 320 (220.065,
220.165) Petrol 165 10/98 → 08/02S 350 (220.067,
220.167) Petrol 180 09/02 → 08/05S 350 4-matic
(220.087, 220.187) Petrol 180 06/03 → 08/05S 430 (220.070,
220.170) Petrol 205 10/98 → 08/05S 430 4-matic
(220.083, 220.183) Petrol 205 09/02 → 08/05S 500 (220.075,
220.175, 220.875) Petrol 225 10/98 → 08/05S 500 4-matic
(220.084,
220.184) Petrol 225 09/02 → 08/05S 55 AMG
(220.073,
220.173) Petrol 265 04/99 → 08/05S 55 AMG
Kompressor
(220.074,
220.174) Petrol 368 06/02 → 08/05

BAE680CX



KW



MERCEDES-BENZ

CLASSE S Coupé (C140)

SEC/CL 500
(140.070) Petrol 235 06/96 → 02/99

CLASSE S Coupé (C215)

CL 500 (215.375) Petrol 225 03/99 → 03/06

CL 55 AMG
(215.373) Petrol 265 10/99 → 03/06CL 55 AMG
Kompressor
(215.374) Petrol 368 06/02 → 03/06

CLASSE S Coupé (C216)

CL 500 (216.371) Petrol 285 09/07 → 07/10

CLK (C208)

320 (208.365) Petrol 160 06/97 → 06/02

430 (208.370) Petrol 205 07/98 → 06/02

55 AMG
(208.374) Petrol 255 08/99 → 06/02

CLK (C209)

240 (209.361) Petrol 120 06/02 → 03/05

240 (209.361) Petrol 125 06/02 → 03/05

320 (209.365) Petrol 160 06/02 → 05/09

500 (209.375) Petrol 225 06/02 → 05/09

55 AMG
(209.376) Petrol 270 09/02 → 05/09

CLK Cabriolet (A208)

320 (208.465) Petrol 160 03/98 → 03/02

430 (208.470) Petrol 205 09/98 → 03/02

55 AMG
(208.474) Petrol 255 01/00 → 03/02

CLK Cabriolet (A209)

CLK 240
(209.461) Petrol 125 02/03 → 03/05CLK 320
(209.465) Petrol 160 02/03 → 03/10CLK 500
(209.475) Petrol 225 02/03 → 03/10CLK 55 AMG
(209.476) Petrol 270 02/03 → 03/10

CLS (C219)

CLS 500
(219.375) Petrol 225 10/04 → 12/10CLS 55 AMG
(219.376) Petrol 350 01/05 → 12/10

BAE680CX

MERCEDES-BENZ
SL (R129)

280 (129.059) Petrol 150 06/98 → 08/01

320 (129.064) Petrol 165 06/98 → 08/01

SL (R230)

350 (230.467) Petrol 180 03/03 → 12/05

500 (230.475) Petrol 225 10/01 → 01/12

55 AMG Petrol 380 03/06 → 01/12

55 AMG (230.474) Petrol 350 10/01 → 06/02

55 AMG Kompressor (230.474) Petrol 368 06/02 → 01/12

SLK (R170)

32 AMG Kompressor (170.466) Petrol 260 03/01 → 04/04

320 (170.465) Petrol 160 03/00 → 04/04

SLK (R171)

55 AMG (171.473) Petrol 265 06/04 → 02/11

SLR (R199)

5.4 (199.376) Petrol 460 04/04 →

5.4 722 Edition Petrol 478 10/06 →

SLR ROADSTER (R199)

5.4 Petrol 460 04/07 →

5.4 Petrol 478 10/06 →

VIANO (W639)

3,0 Petrol 140 09/03 → 12/07

3.2 Petrol 160 09/03 → 12/07

3.7 Petrol 170 06/04 → 08/07

VITO / MIXTO Furgonato (W639)

119 Petrol 140 10/03 → 12/10

122 Petrol 160 10/03 → 12/10

123 (639.603) Petrol 170 06/04 → 08/07

VITO Autobus (W639)

119 Petrol 140 10/03 → 12/10

122 Petrol 160 10/03 → 12/10

123 Petrol 170 06/04 → 08/07

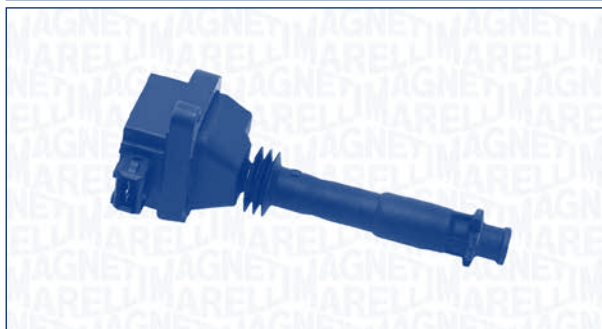
BAE680CY
**BOBINA D'ACCENSIONE
IGNITION COIL**

FIAT
BRAVO I (182)

2.0 HGT 20V (182.AD) Petrol 108 10/95 → 07/98

LANCIA
KAPPA (838A)

2.0 20V (838AA1AA) Petrol 107 11/94 → 06/96

2.0 20V Turbo (838AM1AA) Petrol 162 06/98 → 12/00

2.4 20V (838AC1AA, 838AC11A) Petrol 129 11/94 → 06/98

KAPPA Coupé (838)

2.0 20V Petrol 114 07/96 → 06/98

2.0 20V Turbo (838CM) Petrol 162 06/98 → 06/00

KAPPA SW (838B)

2.0 20V Turbo (838BM1AA) Petrol 162 06/98 → 12/00

BAE680DA

BOBINA D'ACCENSIONE
IGNITION COIL

KW



RENAULT

FLUENCE (L30_)

2.0 16V (L30C, L30G, L30T, L30V)	Petrol	103	02/10 →
--	--------	-----	---------

GRAND SCÉNIC III (JZ0/1_)

2.0 16V (JZ0G)	Petrol	103	05/09 →
----------------	--------	-----	---------

LATITUDE (L70_)

2.0 16V (L70B)	Petrol	103	02/11 →
----------------	--------	-----	---------

2.0 16V eco2	BiFuel	103	02/11 →
--------------	--------	-----	---------

MEGANE III 2 volumi /Coda spiovente (BZ0_)

2.0 CVT (BZ0G, BZ1P)	Petrol	103	02/09 →
-------------------------	--------	-----	---------

MEGANE III Coupé (DZ0/1_)

2.0 CVT (DZ0G, DZ1E)	Petrol	103	05/09 →
-------------------------	--------	-----	---------

MEGANE III Grandtour (KZ0/1)

2.0 CVT (KZ0G, KZ1P)	Petrol	103	06/09 →
-------------------------	--------	-----	---------

SCÉNIC III (JZ0/1_)

2.0 16V (JZ0G, JZ1E)	Petrol	103	05/09 →
-------------------------	--------	-----	---------

BAE680DB

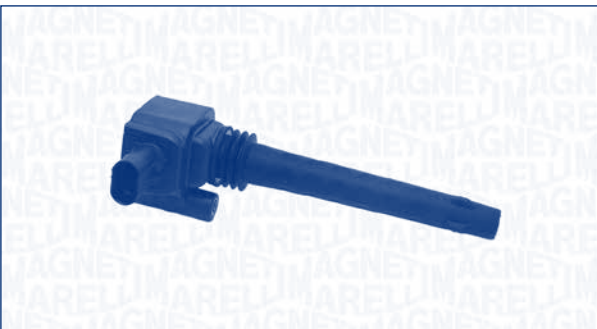
BOBINA D'ACCENSIONE
IGNITION COIL

KW



FIAT

500 (312)

0.9	Petrol	63	09/10 → 05/11
-----	--------	----	---------------

500 C (312)

0.9	Petrol	63	09/10 → 05/11
-----	--------	----	---------------

LANCIA

YPSILON (846)

0.9 Twinair	Petrol	63	06/11 →
-------------	--------	----	---------

BAE680DC

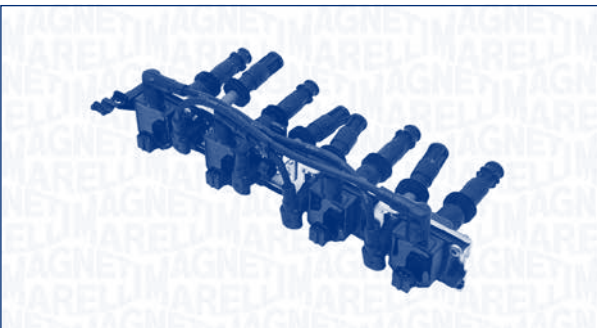
BOBINA D'ACCENSIONE
IGNITION COIL

KW



ALFA ROMEO

145 (930)

2.0 16V T.S.	Petrol	110	11/96 → 04/98
--------------	--------	-----	---------------

146 (930)

2.0 16V T.S.	Petrol	110	10/95 → 04/98
--------------	--------	-----	---------------

155 (167)

2.0 T.S. 16V (167.A2G)	Petrol	110	03/95 → 10/97
---------------------------	--------	-----	---------------

156 (932)

1.6 16V T.SPARK (932A4)	Petrol	88	10/97 → 05/99
----------------------------	--------	----	---------------

BAE680DD
**BOBINA D'ACCENSIONE
IGNITION COIL**

ALFA ROMEO
145 (930)

1.6 16V T.S. Petrol 82 02/99 → 12/00

1.8 i.e. 16V Petrol 106 05/98 → 12/00

 2.0 16V
Quadrifoglio Petrol 114 05/98 → 12/00

146 (930)

1.6 16V T.S. Petrol 82 02/99 → 12/00

1.8 i.e. 16V T.S. Petrol 106 05/98 → 12/00

 2.0 16V
Quadrifoglio Petrol 114 05/98 → 12/00

156 (932)

1.6 16V T.SPARK Petrol 82 04/98 → 09/00

 1.8 16V T.SPARK
(932A3) Petrol 106 10/97 → 09/00

 2.0 16V T.SPARK
(932A2) Petrol 114 10/97 → 09/00

2.0 Twin Spark Petrol 118 11/97 → 04/00

166 (936)

 2.0 T.Spark
(936A3A_) Petrol 114 10/98 → 09/00

GTV (916C_)

1.8 16V (916C3) Petrol 106 05/98 → 12/00

 2.0 T.SPARK
16V (916.C2_,
916C2C00) Petrol 110 06/95 → 04/98

 2.0 T.SPARK 16V
(916C2C) Petrol 114 05/98 → 07/00

SPIDER (916S_)

1.8 16V (916S3) Petrol 106 05/98 → 07/00

 2.0 T.SPARK 16V
(916S2B) Petrol 114 05/98 → 07/00

 2.0 T.SPARK 16V
(916S2C00) Petrol 110 06/95 → 04/98

BAE680DE
**BOBINA D'ACCENSIONE
IGNITION COIL**

ALFA ROMEO
147 (937)

 1.6 16V T.SPARK
(937AXB1A) Petrol 88 01/01 → 03/10

 1.6 16V T.SPARK
ECO (937AXA1A) Petrol 77 01/01 → 03/10

 2.0 16V T.SPARK
(937AXC1_) Petrol 110 01/01 → 03/10

156 (932)

 1.6 16V T.SPARK
(932A4) Petrol 88 09/00 → 09/05

 1.8 16V T.SPARK
(932A31_) Petrol 103 10/00 → 09/05

 2.0 16V T.SPARK
(932A21_) Petrol 110 10/00 → 03/02

156 Sportwagon (932)

 1.6 16V T.SPARK.
(932A4) Petrol 88 06/00 → 12/05

 1.8 16V T.SPARK
(932A3) Petrol 106 06/00 → 09/00

 1.8 16V T.SPARK
(932B31_) Petrol 103 10/00 → 12/05

 2.0 16V T.SPARK
(932A2) Petrol 114 06/00 → 09/00

 2.0 16V T.SPARK
(932B21_) Petrol 110 10/00 → 03/02

166 (936)

 2.0 T.Spark
(936A3B_) Petrol 110 10/00 → 06/07

GT (937)

1.8 TS Petrol 103 11/03 → 09/10

GTV (916C_)

 2.0 T.SPARK 16V
(916.C2_,
916C2C00) Petrol 110 08/00 → 10/05

BAE680DE



ALFA ROMEO

SPIDER (916S_)

2.0 T.SPARK 16V (916S2C00)	Petrol	110	08/00 → 04/05
-------------------------------	--------	-----	---------------

BAE680DF

BOBINA D'ACCENSIONE
IGNITION COIL

MERCEDES-BENZ

CLASSE C (W204)

C 63 AMG (204.077)	Petrol	336	02/08 →
-----------------------	--------	-----	---------

CLASSE C Coupé (C204)

C 63 AMG (204.377)	Petrol	336	06/11 →
-----------------------	--------	-----	---------

CLASSE C T-Model (S204)

C 63 AMG (204.277)	Petrol	336	02/08 →
-----------------------	--------	-----	---------

CLASSE E (W211)

E 63 AMG (211.077, 211.177)	Petrol	378	03/06 → 12/08
--------------------------------	--------	-----	---------------

CLASSE E (W212)

E 63 AMG (212.077)	Petrol	386	12/09 →
-----------------------	--------	-----	---------

CLASSE E T-Model (S211)

E 63 AMG (211.277)	Petrol	378	03/06 → 07/09
-----------------------	--------	-----	---------------

CLASSE E T-Model (S212)

E 63 AMG (212.277)	Petrol	386	08/09 →
-----------------------	--------	-----	---------

CLASSE M (W164)

ML 63 AMG 4-matic (164.177)	Petrol	375	01/06 →
--------------------------------	--------	-----	---------

BAE680DF



MERCEDES-BENZ

CLASSE R (W251, V251)

R 63 AMG (251.077, 251.177)	Petrol	375	02/06 →
--------------------------------	--------	-----	---------

CLASSE S (W221)

S 63 AMG (221.077, 221.177)	Petrol	386	10/06 →
--------------------------------	--------	-----	---------

CLASSE S Coupé (C216)

CL 63 AMG (216.377)	Petrol	386	10/06 →
------------------------	--------	-----	---------

CLK (C209)

63 AMG (209.377)	Petrol	354	04/06 → 05/09
------------------	--------	-----	---------------

63 AMG (209.377)	Petrol	373	05/07 → 05/09
------------------	--------	-----	---------------

CLK Cabriolet (A209)

CLK 63 AMG (209.477)	Petrol	354	04/06 → 03/10
-------------------------	--------	-----	---------------

CLS (C219)

CLS 63 AMG (219.377)	Petrol	378	04/06 → 12/10
-------------------------	--------	-----	---------------

SL (R230)

63 AMG (230.470)	Petrol	386	03/08 → 01/12
------------------	--------	-----	---------------

BAE680DI

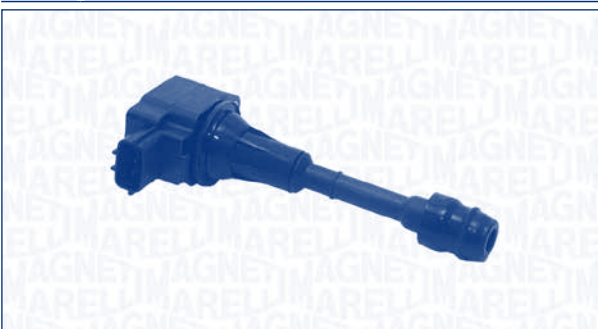
BOBINA D'ACCENSIONE
IGNITION COIL

NISSAN

X-TRAIL (T31)

2.5 4x4	Petrol	124	06/07 →
---------	--------	-----	---------

BAE680DK
**BOBINA D'ACCENSIONE
IGNITION COIL**

KW

LADA
110

1.5	Petrol	57	01/96 → 12/04
1.5 16V	Petrol	67	10/00 → 12/04
1.5 16V	Petrol	70	01/96 → 12/04
1.6	Petrol	66	01/05 →

111

1.5	Petrol	57	01/96 → 12/04
1.5 16V	Petrol	67	10/00 → 12/04
1.5 16V	Petrol	70	01/96 → 12/04
1.6	Petrol	60	01/05 →

112

1.5	Petrol	54	01/96 → 12/04
1.5	Petrol	56	10/00 → 12/04
1.5	Petrol	57	01/96 → 12/04
1.5 16V	Petrol	67	10/00 → 12/04
1.5 16V	Petrol	70	01/96 → 12/04
1.6	Petrol	60	01/05 →
1.6	Petrol	66	03/06 →

PRIORA 2 volumi /Coda spiovente (2172)

1.6	Petrol	72	12/08 →
1.6 LPG	Petrol/ LPG	71	12/08 →

PRIORA Station wagon (2171)

1.6	Petrol	60	10/09 →
1.6	Petrol	72	10/09 →

PRIORA Tre volumi (2170)

1.6	Petrol	72	12/08 →
1.6 LPG	Petrol/ LPG	71	03/09 →

SAMARA (2108, 2109, 2115)

1500	Petrol	53	01/88 →
1500	Petrol	52	02/95 → 01/04
1.5	Petrol	57	04/96 →

BAE680DK

KW

LADA
SAMARA FORMA (21099)

1500	Petrol	52	11/94 →
1.5	Petrol	57	01/00 → 01/04
1.5	Petrol	59	08/03 → 01/04

BAE680DL
**BOBINA D'ACCENSIONE
IGNITION COIL**

KW

RENAULT
GRAND SCÉNIC III (JZ0/1_)

1.6 16V (JZ0U)	Petrol	81	02/09 →	ENGINE: K4M9766,K4M858
----------------	--------	----	---------	---------------------------

MEGANE III 2 volumi /Coda spiovente (BZ0_)

1.2 TCe	Petrol	85	03/12 →	ENGINE: H5F400
---------	--------	----	---------	----------------

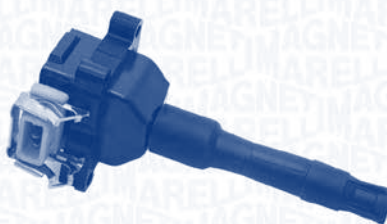
BAE680DN
**BOBINA D'ACCENSIONE
IGNITION COIL**

KW

BMW
3 (E30)

318 is	Petrol	100	09/89 → 08/91
--------	--------	-----	---------------

3 (E36)

320 i	Petrol	110	09/90 → 02/98
-------	--------	-----	---------------

BAE680DN



BMW

3 (E36)

M3 3.0 Petrol 210 08/94 → 09/95

3 Cabriolet (E36)

320 i Petrol 110 12/93 → 04/99

325 i Petrol 141 03/93 → 03/95

M3 3.0 Petrol 210 01/94 → 10/95

3 Coupé (E36)

320 i Petrol 110 03/92 → 04/99

M3 3.0 Petrol 217 01/95 → 10/95

5 (E34)

520 i 24V Petrol 110 09/89 → 09/95

525 i 24V Petrol 141 09/89 → 09/95

530 i V8 Petrol 160 09/92 → 09/95

7 (E32)

730 i,iL V8 Petrol 160 04/92 → 09/94

740 i,iL V8 Petrol 210 04/92 → 09/94

7 (E38)

730 i,iL Petrol 155 10/94 → 11/01

740 i,iL Petrol 210 10/94 → 11/01

8 (E31)

840 Ci Petrol 210 01/96 → 12/99

BAE680DO

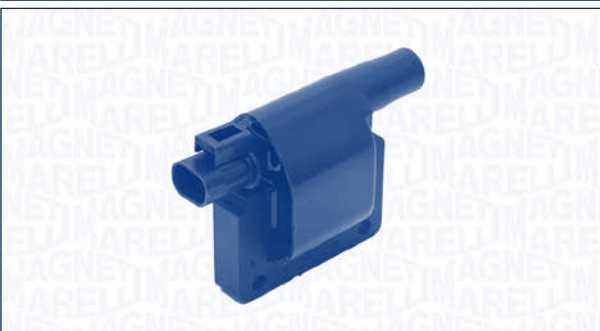
BOBINA D'ACCENSIONE
IGNITION COIL

NISSAN

100 NX (B13)

1.6 Petrol 66 03/90 → 10/94

MICRA I (K10)

1.2 Petrol 40 07/86 → 07/92

1.2 Petrol 44 07/86 → 07/92

PICK UP (D21)

2.4 i 12V Petrol 91 04/92 → 02/98

2.4 i 12V 4WD Petrol 93 04/92 → 02/98

BAE680DO



NISSAN

PRAIRIE PRO (M11)

2.0 i Petrol 72 10/88 → 04/92

PRAIRIE PRO (M11)

2.0 i 4x4 Petrol 72 10/88 → 12/92

2.4 i Petrol 98 04/92 → 07/94

2.4 i 4x4 Petrol 98 04/92 → 07/94

PRIMERA (P10)

1.6 Petrol 66 06/90 → 01/96

2.0 16V Petrol 85 06/90 → 01/96

2.0 GT Petrol 110 06/90 → 01/96

PRIMERA Hatchback (P10)

2.0 16V Petrol 85 06/90 → 01/96

2.0 16V 4x4 Petrol 85 04/91 → 06/96

PRIMERA Traveller (W10)

2.0 i Petrol 85 07/90 → 03/98

SERENA (C23M)

2.0 16V Petrol 93 11/92 → 09/01

SUNNY Furgonato (Y10)

1.6 i 16V Petrol 66 10/92 → 03/00

SUNNY II (N13)

1.6 i 12V Petrol 66 10/88 → 06/91

SUNNY II Coupé (B12)

1.6 i 12V Petrol 66 10/88 → 06/91

SUNNY II Hatchback (N13)

1.6 i 12V Petrol 66 06/86 → 10/90

SUNNY II Traveller (B12)

1.6 i 12V Petrol 66 10/88 → 06/91

1.6 i 12V 4x4 Petrol 66 10/88 → 08/90

SUNNY III (N14)

1.4 Petrol 60 10/90 → 05/95

1.4 i Petrol 55 10/90 → 05/95

1.6 i Petrol 66 10/90 → 05/95

1.6 i 16V 4WD Petrol 66 10/90 → 05/95

SUNNY III Hatchback (N14)

1.4 Petrol 60 10/90 → 05/95

1.4 i Petrol 55 10/90 → 05/95

1.6 i Petrol 66 10/90 → 05/95

2.0 GTI-R 4x4 Petrol 162 10/90 → 05/95

SUNNY III Liftback (N14)

1.4 Petrol 60 10/90 → 05/95

1.4 i Petrol 55 10/90 → 05/95

1.6 i Petrol 66 10/90 → 05/95

SUNNY III Traveller (Y10)

1.6 16V 4x4 Petrol 66 11/90 → 05/95

1.6 i Petrol 66 06/91 → 03/00

BAE680DO

NISSAN
TERRANO II (R20)

2.4 i 12V 4WD Petrol 91 02/93 → 06/96

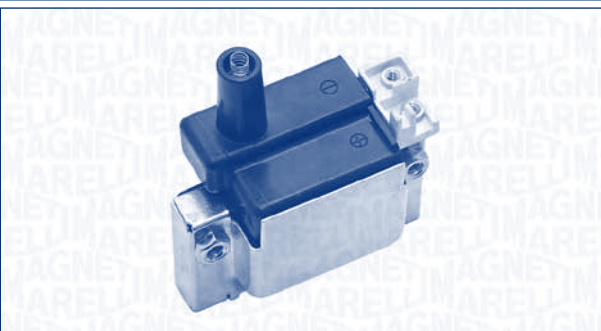
BAE680DP
**BOBINA D'ACCENSIONE
IGNITION COIL**

HONDA
ACCORD IV (CB)

2.0 16V (CB3) Petrol 81 01/90 → 03/93

2.0 i 16V (CB3) Petrol 98 01/90 → 03/93

ACCORD V (CC7, CD)

2.0 i Petrol 85 03/93 → 01/96

2.0 i S Petrol 96 03/93 → 01/96

2.3 i SR Petrol 116 03/93 → 01/96

ACCORD V Aerodeck (CE)

2.0iLS 16V (CE2) Petrol 100 09/93 → 02/98

2.2 i ES (CE1) Petrol 110 09/93 → 02/98

ACCORD V Coupé (CD7, CD9)

2.0 (CD9) Petrol 100 09/93 → 12/97

CIVIC IV Hatchback (EC, ED, EE)

1.5 i 16V Petrol 66 10/88 → 09/91

CIVIC IV Tre volumi (ED)

1.5 i 16V Petrol 66 10/87 → 09/91

CIVIC V Coupé (EJ)

1.5 i LSi (EJ2) Petrol 74 08/93 → 11/95

1.6 i (EJ6) Petrol 77 01/94 → 11/95

1.6 i Vtec Petrol 118 01/94 → 11/95

1.6 i Vtec (EJ1) Petrol 92 01/94 → 03/96

CIVIC V Hatchback (EG)

1.5 i 16V (EG4) Petrol 66 10/91 → 11/95

1.5 i 16V (EG4) Petrol 69 10/91 → 11/95

1.6 16V Vtec (EG5) Petrol 92 10/91 → 11/95

1.6 VTi 16V (EG6) Petrol 118 10/91 → 11/95

BAE680DP

HONDA
CIVIC V Tre volumi (EG, EH)

1.5 Petrol 88 06/93 → 09/95

1.5 i 16V (EG8) Petrol 69 10/91 → 11/95

1.6 (EH9) Petrol 96 10/91 → 10/93

1.6 16V Vtec (EH9) Petrol 92 10/91 → 11/95

1.6 VTi (EG9) Petrol 118 10/91 → 11/95

CIVIC VI Coupé (EJ, EM1)

1.6 i Petrol 77 03/96 → 03/00

1.6 i Vtec Petrol 92 03/96 → 03/00

CIVIC VI Fastback (MA, MB)

1.4 i (MA8, MB2) Petrol 66 09/94 → 02/01

1.5 i Vtec-E (MA9) Petrol 66 09/94 → 01/97

1.6 i (MB1) Petrol 83 09/94 → 01/97

1.6 i Vtec (MB1) Petrol 93 09/94 → 01/97

1.6 VTi Petrol 118 01/97 → 02/01

CIVIC VI Hatchback (EJ, EK)

1.4 i (EJ9) Petrol 55 11/95 → 02/01

1.4 i S (EJ9) Petrol 66 11/95 → 02/01

1.5 i (EK3) Petrol 84 11/95 → 02/01

1.6 Petrol 93 10/95 → 01/97

1.6 VTi (EK4) Petrol 118 11/95 → 02/01

CIVIC VI Tre volumi (EJ, EK)

1.4 i (EJ9) Petrol 66 11/95 → 02/01

1.5 i (EK3) Petrol 84 11/95 → 02/01

1.6 i Vtec Petrol 92 11/95 → 02/01

1.6 VTi (EK4) Petrol 118 11/95 → 02/01

CR-V I (RD)

2.0 Petrol 98 04/99 → 02/02

2.0 16V (RD1, RD3) Petrol 108 01/99 → 02/02

2.0 16V (RD1, RD3) Petrol 94 10/95 → 01/99

CRX III (EH, EG)

1.6 ESi (EH6) Petrol 92 03/92 → 12/98

1.6 i VTi (EG2) Petrol 118 03/92 → 12/98

HR-V (GH)

1.6 16V Petrol 77 03/99 →

1.6 16V 4WD Petrol 77 03/99 →

1.6 16V 4WD Petrol 91 10/99 →

LOGO (GA3)

1.3 Petrol 48 03/99 → 03/02

PRELUDE IV (BB)

2.0 i 16V (BB3) Petrol 98 02/92 → 09/96

2.2 i 16V Vtec (BB1) Petrol 136 02/93 → 09/96

2.3 i 16V (BB2) Petrol 118 02/92 → 09/96

BAE680DP



HONDA

SHUTTLE (RA)

2.2 16V	Petrol	110	10/94 → 02/98
2.3 16V	Petrol	110	10/97 → 06/04

BAE680DQ

**BOBINA D'ACCENSIONE
IGNITION COIL**



HONDA

ACCORD VI (CG, CK)

1.6 i	Petrol	85	01/00 → 12/02
1.6 LS	Petrol	79	01/00 → 12/02

ACCORD VI Hatchback (CH)

1.6	Petrol	85	12/99 → 12/02
-----	--------	----	---------------

BAE680DR

**BOBINA D'ACCENSIONE
IGNITION COIL**

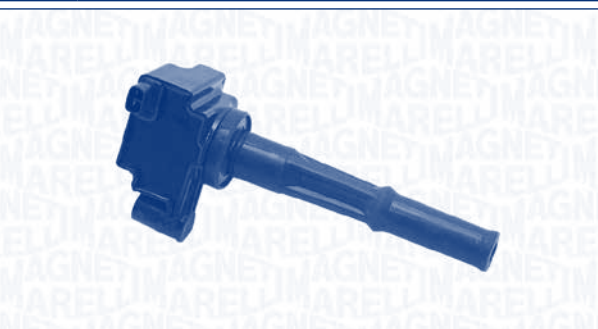

TOYOTA

4 RUNNER (RN10_, VZN13_, VZN10_, RN13_)

3.4 i	Petrol	136	11/95 → 03/96
-------	--------	-----	---------------

BAE680DS

**BOBINA D'ACCENSIONE
IGNITION COIL**



TOYOTA

CAMRY (_V2_)

2.0 (SV21_, SV25_)	Petrol	94	11/86 → 05/91
2.0 Gli 16V (SV21_, SV25_)	Petrol	89	11/86 → 05/91

CAMRY Station Wagon (_V2_)

2.0 (SV21_)	Petrol	94	11/86 → 05/91
2.0 GLi 16V (SV21_)	Petrol	89	11/86 → 05/91

CARINA II (_T17_)

2.0 GLI (ST171)	Petrol	89	12/87 → 03/92
-----------------	--------	----	---------------

CARINA II Tre volumi (_T17_)

2.0 GLI (ST171)	Petrol	89	12/87 → 03/92
-----------------	--------	----	---------------

COROLLA (_E8_)

1.6 (AE82)	Petrol	53	08/85 → 08/87
------------	--------	----	---------------

COROLLA Liftback (_E8_)

1.6 (AE82)	Petrol	54	08/85 → 08/87
------------	--------	----	---------------

LITEACE Autobus (_R2_LG)

2.2 (YR22LG)	Petrol	72	01/92 → 01/95
--------------	--------	----	---------------

LITEACE Furgonato (_R2_V)

2.2 (YR29LV)	Petrol	72	01/92 → 01/95
--------------	--------	----	---------------

MODELL F Autobus (_R2_, 31)

2.2 (YR22LG, YR31LG)	Petrol	72	08/87 → 01/90
----------------------	--------	----	---------------

TERCEL (AL2_)

1.5 4WD (AL25)	Petrol	50	05/86 → 01/88
----------------	--------	----	---------------

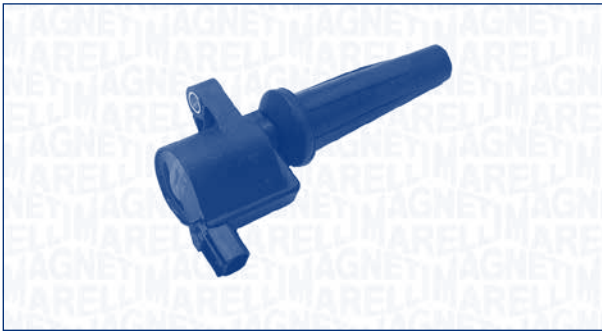
BAE680DW
**BOBINA D'ACCENSIONE
IGNITION COIL**

FORD
C-MAX (DM2)

1.8	Petrol	92	02/07 →
2.0	Petrol	107	02/07 →

FOCUS C-MAX

1.8	Petrol	88	10/03 → 03/07
1.8	Petrol	92	04/04 → 03/07
2.0	Petrol	107	03/04 → 03/07

FOCUS II (DA_)

1.8	Petrol	92	03/06 →
1.8 Flexifuel	Petrol/ Ethanol	92	01/06 →
2.0	Petrol	107	11/04 →

FOCUS II Cabriolet

2.0	Petrol	107	10/06 →
-----	--------	-----	---------

FOCUS II Station wagon (DA_)

1.8	Petrol	92	03/06 →
1.8 Flexifuel	Petrol/ Ethanol	92	01/06 →
2.0	Petrol	107	11/04 →

FOCUS II Tre volumi (DA_)

1.8	Petrol	92	03/06 →
2.0	Petrol	107	04/05 →

GALAXY (WA6)

2.0	Petrol	107	05/06 →
-----	--------	-----	---------

MAVERICK

2.3 16V	Petrol	110	03/04 →
---------	--------	-----	---------

MONDEO IV (BA7)

2.0	Petrol	107	03/07 →
-----	--------	-----	---------

MONDEO IV Tre volumi (BA7)

2.0	Petrol	107	03/07 →
-----	--------	-----	---------

MONDEO IV Turnier (BA7)

2.0	Petrol	107	03/07 →
-----	--------	-----	---------

S-MAX (WA6)

2.0	Petrol	107	05/06 →
-----	--------	-----	---------

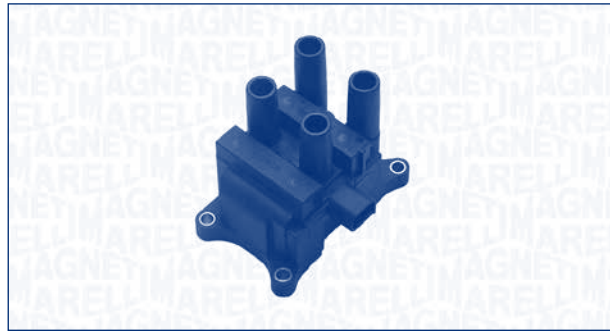
BAE680DX
**BOBINA D'ACCENSIONE
IGNITION COIL**

FORD
B-MAX

1.6 Ti	Petrol	77	10/12 →
--------	--------	----	---------

C-MAX (DM2)

1.6	Petrol	74	02/07 →
-----	--------	----	---------

C-MAX II

1.6	Petrol	63	12/10 →
-----	--------	----	---------

1.6 Flexifuel	Petrol/ Ethanol	88	02/11 →
---------------	--------------------	----	---------

FIESTA V (JH_, JD_)

1.25 16V	Petrol	51	02/05 → 06/08
----------	--------	----	---------------

1.25 16V	Petrol	55	08/07 → 06/08
----------	--------	----	---------------

1.3	Petrol	44	08/07 → 06/08
-----	--------	----	---------------

1.4 16V	Petrol	59	02/05 → 06/08
---------	--------	----	---------------

1.6 16V	Petrol	74	02/05 → 06/08
---------	--------	----	---------------

FIESTA Van

1.25	Petrol	60	01/09 →
------	--------	----	---------

FIESTA VI

1.25	Petrol	44	06/08 →
------	--------	----	---------

1.25	Petrol	60	06/08 →
------	--------	----	---------

1.4	Petrol	71	06/08 →
-----	--------	----	---------

1.4 LPG	Petrol/ LPG	71	01/09 →
---------	----------------	----	---------

1.6	Petrol	70	06/08 →
-----	--------	----	---------

1.6 Ti	Petrol	88	06/08 →
--------	--------	----	---------

1.6 Ti	Petrol	99	12/10 →
--------	--------	----	---------

FOCUS C-MAX

1.6	Petrol	74	03/05 → 03/07
-----	--------	----	---------------

1.6 Ti	Petrol	85	03/05 → 03/07
--------	--------	----	---------------

FOCUS II (DA_)

1.4	Petrol	59	03/05 →
-----	--------	----	---------

1.6	Petrol	74	03/05 →
-----	--------	----	---------

1.6 LPG	Petrol/ LPG	85	10/09 →
---------	----------------	----	---------

1.6 Ti	Petrol	85	03/05 →
--------	--------	----	---------

BAE680DX



FORD

FOCUS II Cabriolet

1.6	Petrol	74	10/06 → 10/09
-----	--------	----	---------------

FOCUS II Station wagon (DA_)

1.4	Petrol	59	03/05 →
-----	--------	----	---------

1.6	Petrol	74	03/05 →
-----	--------	----	---------

1.6 LPG	Petrol/ LPG	85	10/09 →
---------	----------------	----	---------

1.6 Ti	Petrol	85	03/05 →
--------	--------	----	---------

FOCUS II Tre volumi (DA_)

1.4	Petrol	59	04/05 → 01/08
-----	--------	----	---------------

1.6	Petrol	74	04/05 → 12/07
-----	--------	----	---------------

1.6 Ti	Petrol	85	04/05 → 12/07
--------	--------	----	---------------

FOCUS III

1.6 LPG	Petrol/ LPG	88	02/12 →
---------	----------------	----	---------

1.6 Ti	Petrol	63	08/11 →
--------	--------	----	---------

FOCUS III Tre volumi

1.6 Ti	Petrol	63	08/11 →
--------	--------	----	---------

FOCUS III Turnier

1.6 Flexifuel	Petrol/ Ethanol	88	05/11 →
---------------	--------------------	----	---------

1.6 LPG	Petrol/ LPG	88	02/12 →
---------	----------------	----	---------

1.6 Ti	Petrol	63	08/11 →
--------	--------	----	---------

FUSION (JU_)

1.25	Petrol	55	08/04 →
------	--------	----	---------

1.4	Petrol	59	03/05 →
-----	--------	----	---------

1.6	Petrol	74	03/05 →
-----	--------	----	---------

KA (RB_)

1.3 i	Petrol	51	07/07 → 11/08
-------	--------	----	---------------

1.6 i	Petrol	70	07/07 → 11/08
-------	--------	----	---------------

MONDEO IV (BA7)

1.6 Ti	Petrol	81	03/07 →
--------	--------	----	---------

1.6 Ti	Petrol	92	03/07 →
--------	--------	----	---------

MONDEO IV Tre volumi (BA7)

1.6 Ti	Petrol	81	03/07 → 08/10
--------	--------	----	---------------

1.6 Ti	Petrol	92	03/07 → 08/10
--------	--------	----	---------------

MONDEO IV Turnier (BA7)

1.6 Ti	Petrol	81	03/07 → 08/10
--------	--------	----	---------------

1.6 Ti	Petrol	92	03/07 → 08/10
--------	--------	----	---------------

MAZDA

2 (DY)

1.2	Petrol	55	02/05 →
-----	--------	----	---------

1.25	Petrol	55	02/05 →
------	--------	----	---------

1.4	Petrol	59	02/05 →
-----	--------	----	---------

BAE680DX



MAZDA

2 (DY)

1.4	Petrol	59	02/05 →
-----	--------	----	---------

1.6	Petrol	74	02/05 →
-----	--------	----	---------

1.6	Petrol	74	02/05 →
-----	--------	----	---------

VOLVO

C30

1.6	Petrol	74	10/06 → 12/12
-----	--------	----	---------------

S40 II (MS)

1.6	Petrol	74	01/05 →	CHASSIS: 106167 →
-----	--------	----	---------	-------------------

V50 (MW)

1.6	Petrol	74	01/05 →	CHASSIS: 105440 →
-----	--------	----	---------	-------------------

BAE680DY

BOBINA D'ACCENSIONE
IGNITION COIL

FORD

GALAXY (WA6)

2.0 EcoBoost	Petrol	149	03/10 → 04/11
--------------	--------	-----	---------------

MONDEO IV (BA7)

2.0 SCTi	Petrol	149	03/10 → 01/11
----------	--------	-----	---------------

MONDEO IV Turnier (BA7)

2.0 SCTi	Petrol	149	03/10 → 01/11
----------	--------	-----	---------------

S-MAX (WA6)

2.0 EcoBoost	Petrol	149	03/10 → 04/11
--------------	--------	-----	---------------

VOLVO

S60 II

2.0 T	Petrol	149	08/10 → 07/11
-------	--------	-----	---------------

T5	Petrol	177	11/10 → 07/11
----	--------	-----	---------------

V70 III (BW)

2.0 T	Petrol	149	08/10 → 07/11
-------	--------	-----	---------------

XC60

2.0 T	Petrol	149	08/10 → 07/11
-------	--------	-----	---------------

BAE680E
**BOBINA D'ACCENSIONE
IGNITION COIL**

KW

NISSAN
KUBISTAR (X76)

1.6 16V	Petrol	70	08/03 →
---------	--------	----	---------

OPEL
VIVARO Furgonato (F7)

2.0 16V	Petrol	88	08/01 →
---------	--------	----	---------

RENAULT
CLIO II (BB0/1/2_, CB0/1/2_)

1.4 (B/CB0C)	Petrol	55	09/98 → 05/05
--------------	--------	----	---------------

1.4 16V (B/CB0L)	Petrol	70	10/99 → 08/00
------------------	--------	----	---------------

1.4 16V (B/CB0P)	Petrol	72	08/00 → 05/05
------------------	--------	----	---------------

1.6 (B/CB0D)	Petrol	66	09/98 → 05/05
--------------	--------	----	---------------

1.6 16V (BB01, BB0H, BB0T, BB14, BB1D, BB1R, BB2KL...)	Petrol	79	09/98 → 05/05
--	--------	----	---------------

2.0 16V Sport (CB0M)	Petrol	124	02/00 → 05/05
----------------------	--------	-----	---------------

CLIO III (BR0/1, CR0/1)

1.4 16V	Petrol	72	06/05 →
---------	--------	----	---------

1.6 16V (BR05, BR0B, BR0Y, BR15, BR1J, BR1M, BR1Y, CR0B...)	Petrol	82	06/05 →
---	--------	----	---------

1.6 16V (BR09, BR0T, CR09, CR0T)	Petrol	65	06/05 →
----------------------------------	--------	----	---------

ESPACE III (JE0_)

2.0	Petrol	102	09/01 → 10/02
-----	--------	-----	---------------

2.0 16V (JE0N, JE0L, JE02)	Petrol	103	10/98 → 10/02
----------------------------	--------	-----	---------------

BAE680E

KW

RENAULT
ESPACE IV (JK0/1_)

2.0 (JK09)	Petrol	100	11/02 →
------------	--------	-----	---------

2.0 (JK0N, JK1D)	Petrol	125	04/05 →
------------------	--------	-----	---------

2.0 Turbo (JK0B, JK0N)	Petrol	120	11/02 →
------------------------	--------	-----	---------

GRAND SCÉNIC II (JM0/1_)

1.6	Petrol	83	04/04 →
-----	--------	----	---------

2.0	Petrol	120	04/04 →
-----	--------	-----	---------

2.0	Petrol	99	04/04 →
-----	--------	----	---------

KANGOO (KC0/1_)

1.6 16V 4x4 (KC0P, KC0S, KC0L)	Petrol	70	10/01 →
--------------------------------	--------	----	---------

KANGOO Express (FC0/1_)

1.6 16V	Petrol	70	10/01 →
---------	--------	----	---------

1.6 16V 4x4 (FC0L, FC0P, FC0S)	Petrol	70	10/01 →
--------------------------------	--------	----	---------

LAGUNA I (B56_, 556_)

1.8 16V (B563, B564)	Petrol	88	04/98 → 03/01
----------------------	--------	----	---------------

2.0 16V (556A/B)	Petrol	103	09/99 → 03/01
------------------	--------	-----	---------------

LAGUNA I Grandtour (K56_)

1.6 16V (K568)	Petrol	79	11/97 → 03/01
----------------	--------	----	---------------

1.8 16V (K563, K564)	Petrol	88	04/98 → 03/01
----------------------	--------	----	---------------

LAGUNA II (BG0/1_)

1.6 16V (BG1G, BG1H)	Petrol	82	02/05 →
----------------------	--------	----	---------

1.8 16V (BG0B, BG0C, BG0J, BG0M, BG0V)	Petrol	89	03/01 →
--	--------	----	---------

1.8 16V (BG0B, BG0M)	Petrol	88	03/01 →
----------------------	--------	----	---------

2.0 16V	Petrol	125	01/05 →
---------	--------	-----	---------

2.0 16V	Petrol	150	01/05 →
---------	--------	-----	---------

2.0 16V (BG00, BG0K, BG0P, BG0W)	Petrol	99	08/02 →
----------------------------------	--------	----	---------

2.0 16V IDE (BG0N)	Petrol	103	04/01 →
--------------------	--------	-----	---------

2.0 16V Turbo (BG0S, BG0Z, BG1L, BG1M)	Petrol	120	01/03 →
--	--------	-----	---------

BAE680E

KW

RENAULT
LAGUNA II Grandtour (KG0/1_)

1.6 16V Petrol 82 02/05 →

1.6 16V (KG0A, KG0L) Petrol 79 03/01 →

1.8 16V Petrol 89 03/01 →

1.8 16V (KG0B, KG0M) Petrol 88 03/01 →

1.8 16V (KG0J) Petrol 85 03/01 →

2.0 16V Petrol 125 01/05 →

2.0 16V Petrol 150 01/05 →

2.0 16V (KG00, KG0K, KG0W) Petrol 99 08/02 →

2.0 16V IDE (KG0N) Petrol 103 04/01 →

2.0 16V Turbo (KG0S, KG0Z, KG1L, KG1M) Petrol 120 01/03 →

MEGANE I (BA0/1_)

1.4 16V (BA0D, BA1H, BA0W, BA10) Petrol 70 03/99 → 08/03

1.4 e (BA0E, BA0V) Petrol 55 01/96 → 08/03

1.6 16V (BA11, BA04, BA0B, BA1J) Petrol 79 03/99 → 08/03

1.8 16V (BA06, BA12, BA1A, BA1M, BA1R) Petrol 85 01/01 → 08/03

MEGANE I Cabriolet (EA0/1_)

2.0 16V Petrol 102 01/02 → 08/03

MEGANE I Classic (LA0/1_)

1.6 16V (La04, LA11, LA0B, LA1C, LA1J) Petrol 79 03/99 → 08/03

MEGANE I Coach (DA0/1_)

2.0 16V Petrol 102 01/02 → 08/03

MEGANE I Grandtour (KA0/1_)

1.4 16V (KA0D, KA1H, KA0W, KA10) Petrol 70 03/99 → 08/03

1.4 e (KA0V) Petrol 55 03/99 → 08/03

1.6 16V (KA0B, KA04, KA11) Petrol 79 03/99 → 08/03

BAE680E

KW

RENAULT
MEGANE I Grandtour (KA0/1_)

1.8 16V (KA0S, KA12, KA1A, KA1M, KA1R) Petrol 85 01/01 → 08/03

MEGANE II (BM0/1_, CM0/1_)

1.4 16V (BM0B, CM0B) Petrol 72 11/02 →

1.6 16V (BM0C, CM0C) Petrol 83 11/02 →

2.0 16V Turbo Petrol 120 05/04 →

MEGANE II Coupé-Cabriolet (EM0/1_)

2.0 16V Turbo Petrol 120 05/04 →

MEGANE II Station wagon (KM0/1_)

1.4 Petrol 72 08/03 →

1.6 Petrol 83 08/03 →

2.0 Petrol 99 08/03 →

MEGANE II Tre volumi (LM0/1_)

1.4 Petrol 60 09/03 →

1.4 Petrol 72 09/03 →

1.6 Petrol 83 09/03 →

2.0 Petrol 99 09/03 →

MEGANE Scenic (JA0/1_)

1.6 16V (JA0B, JA04, JA11) Petrol 79 08/99 → 10/99

MODUS / GRAND MODUS (F/JPO_)

1.6 (JP03, JP0B, JP0U, JP0Y, JP1G) Petrol 82 12/04 →

SCÉNIC I (JA0/1_)

1.4 16V (JA0D, JA1H, Ja0W, JA10) Petrol 70 09/99 → 08/03

2.0 16V Petrol 103 09/99 → 08/03

2.0 16V (JA1B, JA1D) Petrol 102 07/00 → 08/03

2.0 16V RX4 Petrol 102 06/00 → 08/03

SCÉNIC II (JM0/1_)

1.4 (JM0B, JM0H, JM1A) Petrol 72 06/03 →

1.6 (JM0C, JM0J, JM1B) Petrol 83 06/03 →

2.0 (JM05, JM0U, JM1N, JM1U, JM2V) Petrol 99 06/03 →

2.0 16V Turbo (JM0W) Petrol 120 05/04 →

BAE680E

RENAULT
THALIA I (LB0/1/2_)

1.4 16V Petrol 72 08/00 →

1.6 16V Petrol 79 04/02 →

TRAFIC II Furgonato (FL)

2.0 (FL0A) Petrol 88 03/01 →

TRAFIC II Pianale piatto/Telaio (EL)

2.0 (EL0A) Petrol 88 03/01 →

VEL SATIS (BJ0_)

2.0 16 V Turbo Petrol 125 04/04 →

2.0 16V Turbo (BJ0K) Petrol 120 06/02 →

VAUXHALL
VIVARO Combi (J7)

2.0 16V Petrol 88 08/01 → 12/06

VIVARO Furgonato (F7)

2.0 16V Petrol 88 08/01 → 12/06

BAE680G
**BOBINA D'ACCENSIONE
IGNITION COIL**

FIAT
BARCETTA (183)

1.8 16V Petrol 96 06/98 → 05/05

BRAVA (182)

1.8 GT 16V (182.BC) Petrol 83 08/99 → 10/01

BRAVO I (182)

1.8 GT (182.AC) Petrol 83 08/99 → 10/01

PUNTO (188)

1.8 130 HGT (188.738, .718) Petrol 96 09/99 →

STILO (192)

1.8 16V (192_XC1A) Petrol 98 10/01 → 11/06

BAE680G

FIAT
STILO Multi Wagon (192)

1.8 16V Petrol 98 01/03 → 08/08

LANCIA
LYBRA (839AX)

1.8 16V (839AXB1A, 839AXG1A) Petrol 96 07/99 → 10/05

LYBRA SW (839BX)

1.8 16V (839BXB1A, 839BXG1A) Petrol 96 07/99 → 10/05

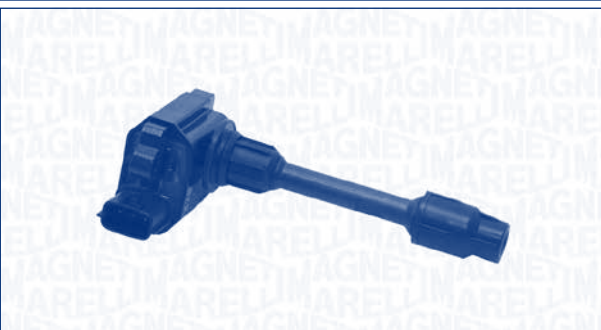
BAE680N
**BOBINA D'ACCENSIONE
IGNITION COIL**

INFINITI
I30

3.0 Petrol 142 01/97 →

NISSAN
MAXIMA QX (A32)

2.0 Petrol 103 02/95 → 08/00

2.5 V6 24V Petrol 140 02/95 → 08/00

MAXIMA QX (A33)

2.0 V6 24V Petrol 103 03/00 → 11/03

3.0 V6 24V Petrol 147 03/00 → 11/03

MAXIMA Station Wagon

2.0 QX Petrol 103 10/97 →

3.0 QX Petrol 142 10/97 →

BAE680R

**BOBINA D'ACCENSIONE
IGNITION COIL**

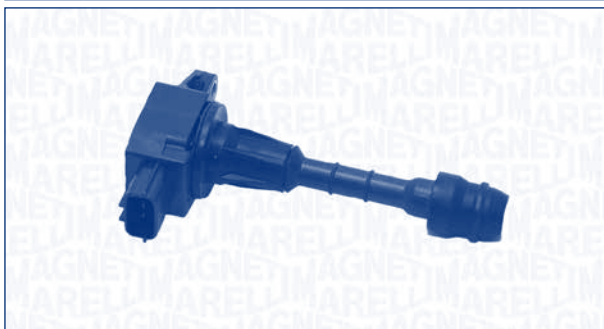

NISSAN

MICRA III (K12)

1.4 16V Petrol 65 01/03 → 06/10

BAE680S

**BOBINA D'ACCENSIONE
IGNITION COIL**

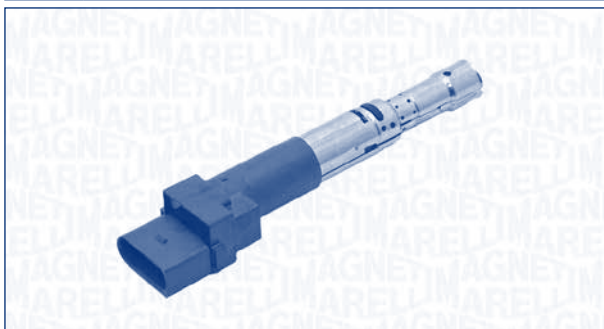

SEAT

ALHAMBRA (7V8, 7V9)

2.8 V6 Petrol 150 06/00 → 03/10

VOLKSWAGEN

BORA (1J2)

2.3 V5 Petrol 110 10/98 → 10/00

2.8 V6 4motion Petrol 150 03/99 → 05/05

GOLF IV (1J1)

2.3 V5 Petrol 125 10/00 → 06/05

2.8 V6 4motion Petrol 150 03/99 → 06/05

NEW BEETLE (9C1, 1C1)

2.3 V5 Petrol 125 10/00 → 09/10

SHARAN (7M8, 7M9, 7M6)

2.8 V6 24V Petrol 150 04/00 → 03/10

BAE680T

**BOBINA D'ACCENSIONE
IGNITION COIL**



HYUNDAI

ACCENT II (LC)

1.3 Petrol 55 01/00 → 11/05

GETZ (TB)

1.3 i Petrol 60 09/02 → 03/04

BAE680U

**BOBINA D'ACCENSIONE
IGNITION COIL**

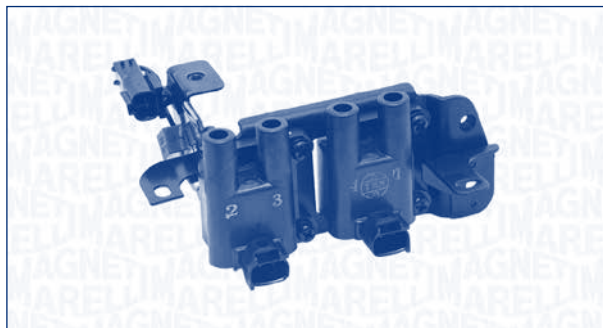

HYUNDAI

COUPE (GK)

1.6 16V Petrol 77 03/02 → 08/09

ELANTRA (XD)

1.6 Petrol 77 05/03 → 07/06

GETZ (TB)

1.6 Petrol 77 09/02 → 09/05

MATRIX (FC)

1.6 Petrol 76 06/01 → 08/10

KIA

CERATO (LD)

1.6 Petrol 77 07/04 →

RIO II (JB)

1.6 CVT Petrol 82 03/05 →

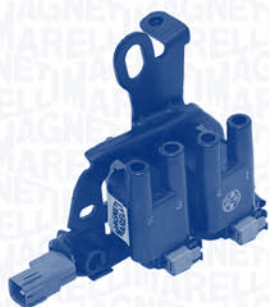
BAE680V
**BOBINA D'ACCENSIONE
IGNITION COIL**

KW

HYUNDAI
MATRIX (FC)

1.8 Petrol 90 06/01 → 08/10

TUCSON (JM)

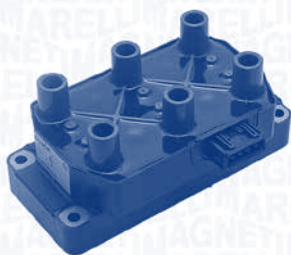
2.0 CRDi Diesel 83 08/04 → 03/10

BAE680W
**BOBINA D'ACCENSIONE
IGNITION COIL**

KW

ALFA ROMEO
155 (167)

2.5 V6 (167.A1) Petrol 121 02/92 → 04/96

2.5 V6 (167.A1C, 167.A1E) Petrol 120 10/92 → 10/97

164 (164)

3.0 Petrol 145 10/94 → 08/97

3.0 V6 (164.H1A, 164.H1B, 164.K1P) Petrol 132 09/92 → 09/98

166 (936)

2.0 V6 (936A3_) Petrol 151 10/98 → 10/00

SPIDER (916S_)

3.0 V6 (916S1) Petrol 141 06/95 → 08/00

BAE680W

KW

LANCIA
THEMA (834)

3000 V6 (834GD, 834FD) Petrol 126 08/92 → 07/94

THEMA SW (834)

3000 V6 (834GD, 834FD) Petrol 126 09/92 → 07/94

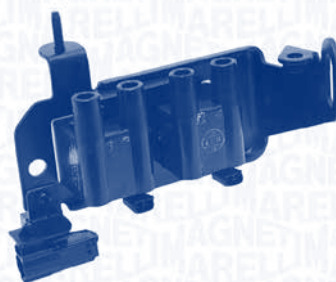
BAE680X
**BOBINA D'ACCENSIONE
IGNITION COIL**

KW

KIA
CARENS II (FJ)

1.6 Petrol 77 07/02 →

RIO Tre volumi (DC_)

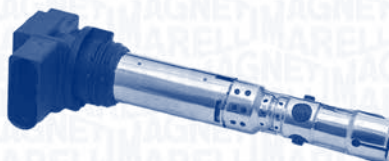
1.5 16V Petrol 72 09/00 → 02/05

BAE680Y
**BOBINA D'ACCENSIONE
IGNITION COIL**

KW

VOLKSWAGEN
FOX (5Z1, 5Z3)

1.2 Petrol 40 04/05 →

BAE680Y



VOLKSWAGEN

POLO (9N_)

1.2	Petrol	44	05/07 → 11/09
-----	--------	----	---------------

BAE680Z

**BOBINA D'ACCENSIONE
IGNITION COIL**



DACIA

LOGAN (LS_)

1.4 (LSOA, LSOC, LSOE, LSOG)	Petrol	55	09/04 →
------------------------------------	--------	----	---------

1.6 (LSOB, LSOD, LSOF, LSOH)	Petrol	64	09/04 →
------------------------------------	--------	----	---------

RENAULT

CLIO II (BB0/1/2_, CB0/1/2_)

1.2 (BB0A, BB0F, BB10, BB1K, BB28, BB2D, BB2H, CB0A...)	Petrol	43	09/98 →
---	--------	----	---------

1.4 (B/CB0C)	Petrol	55	09/98 → 05/05
--------------	--------	----	---------------

KANGOO (KC0/1_)

1.2 (KC0A, KC0K, KC0F, KC01)	Petrol	43	08/97 →
------------------------------------	--------	----	---------

MEGANE III Coupé (DZ0/1_)

2.0 TCe (DZ0K)	Petrol	132	11/08 →
----------------	--------	-----	---------

BAE700AK

**BOBINA D'ACCENSIONE
IGNITION COIL**



CITROËN

XANTIA (X1)

2.0 i 16V	Petrol	110	06/95 → 01/98	ENGINE: XU10J4R(RFV)
-----------	--------	-----	---------------	-------------------------

2.0 i 16V	Petrol	112	06/95 → 01/98	ENGINE: XU10J4R(RFV)
-----------	--------	-----	---------------	-------------------------

2.0 i 16V	Petrol	97	06/95 → 01/98	ENGINE: XU10J4R(RFV)
-----------	--------	----	---------------	-------------------------

ZX (N2)

2.0 i 16V	Petrol	110	06/94 → 06/97	ENGINE: XU10J4,Z(RFT,RFV)
-----------	--------	-----	---------------	------------------------------

2.0 i 16V	Petrol	112	07/92 → 10/94	ENGINE: XU10J4,Z(RFT,RFV)
-----------	--------	-----	---------------	------------------------------

MASERATI

GIBLI II

2.0 24V Biturbo	Petrol	225	03/94 →	ENGINE: DOHC
-----------------	--------	-----	---------	--------------

QUATTROPORTE IV

2.0 Biturbo	Petrol	211	03/94 →
-------------	--------	-----	---------

2.8 Biturbo	Petrol	209	03/94 →
-------------	--------	-----	---------

PEUGEOT

306 (7B, N3, N5)

2.0 S16	Petrol	110	06/94 → 05/01	ENGINE: XU10J4(RFT)
---------	--------	-----	---------------	------------------------

405 II (4B)

2.0 T 16 X4	Petrol	144	08/92 → 10/95	ENGINE: XU10J4TE,Z(RGZ)
-------------	--------	-----	---------------	----------------------------

BAE800B
**BOBINA D'ACCENSIONE
IGNITION COIL**

KW

ALFA ROMEO
145 (930)

1.4 i.e. Petrol 66 07/94 → 12/96

146 (930)

1.4 i.e. Petrol 66 12/94 → 12/96

155 (167)

2.0 16V Turbo Q4 Petrol 140 01/92 → 12/97

2.0 16V Turbo Q4

 (167.A2B, Petrol 137 01/92 → 12/97
167.A2C,
167.A2E)

33 (907A)

 1.4 i.e. (907.A3A, Petrol 65 01/92 → 09/94
907.A3B)

33 (907A)

 1.4 i.e. (907.A3A, Petrol 66 01/92 → 09/94
907.A3B)

33 Sportwagon (907B)

1.4 i.e. Petrol 65 01/92 → 09/94

1.4 i.e. Petrol 66 01/92 → 09/94

1.4 i.e. 4x4 Petrol 66 01/92 → 09/94

FIAT
CINQUECENTO (170)

0.7 i (170AD) Petrol 22 07/94 → 01/98

0.9 i.e. S (170AF, 170CF) Petrol 29 07/91 → 01/98

1.1 Sporting (170AH) Petrol 40 10/94 → 01/98

COUPE (FA/175)

2.0 16V Turbo Petrol 140 11/93 → 08/96

DOBLO (119)

1.2 (223AXA1A) Petrol 48 03/01 →

DOBLO Cargo (223)

1.2 (223ZX1A) Petrol 48 03/01 →

BAE800B

KW

FIAT
PALIO Weekend (178DX)

1.2 (178DX.G1A) Petrol 54 04/96 → 02/01

PANDA (141A_)

900 Petrol 29 04/92 → 12/96

1100 Petrol 37 05/91 → 12/99

1100 Petrol 40 02/95 → 08/00

1000 i.e. Cat. Petrol 33 10/87 → 08/98

1100 4x4 Petrol 40 02/95 → 07/04

1100 Trekking 4x4 Petrol 37 10/91 → 07/04

PANDA (169)

1.2 Petrol 44 09/03 →

PUNTO (176)

1.2 16V Petrol 63 04/97 → 09/99

55 1.1 Petrol 40 09/93 → 09/99

60 1.2 Petrol 44 03/94 → 09/99

75 1.2 Petrol 54 01/94 → 09/99

PUNTO (188)

 1.2 60 (188.030, Petrol 44 09/99 →
.050, .130, .150,
.230, .250)

PUNTO Cabriolet (176C)

60 1.2 Petrol 44 05/95 → 12/98

85 16V 1.2 Petrol 63 04/97 → 06/00

PUNTO Van (176L)

1.1 Petrol 40 04/96 → 02/00

SEICENTO (187)

 0.9 (187AXA, Petrol 29 01/98 → 01/10
187AXA1A)

 1.1 (187AXB, Petrol 40 01/98 → 01/10
187AXB1A)

SIENA (178_)

1.2 Petrol 54 09/98 →

STRADA Pick-up (178E)

1.2 Petrol 44 04/03 →

1.2 Petrol 54 06/99 →

TEMPRA (159)

1.8 i.e. (159.AV) Petrol 76 09/93 → 08/96

1.8 i.e. (159.BY) Petrol 74 10/94 → 08/96

TEMPRA S.W. (159)

1.8 i.e. (159.AV) Petrol 76 09/93 → 08/96

1.8 i.e. (159.BY) Petrol 74 10/94 → 08/96

BAE800B



FIAT

TIPO (160)

1.8 i.e.	Petrol	66	09/93 → 04/95
1.8 i.e. (160.ED)	Petrol	76	04/93 → 04/95
1.8 i.e. (160.EQ, 160.AM)	Petrol	74	10/94 → 04/95

LANCIA

DEDRA (835)

1.8 i.e. (835FA)	Petrol	74	07/94 → 07/99
------------------	--------	----	---------------

DEDRA SW (835)

1.8 i.e. (835FA)	Petrol	74	07/94 → 07/99
------------------	--------	----	---------------

DELTA I (831AB0)

2.0 16V HF Evo Integrale (831AB.027)	Petrol	155	06/93 → 01/94
--------------------------------------	--------	-----	---------------

DELTA II (836)

1.8 i.e. (836AE)	Petrol	76	06/93 → 08/99
1.8 i.e. (836AG, 836AL)	Petrol	66	07/94 → 08/99
2.0 16V Turbo (836AB)	Petrol	137	06/93 → 08/99

THEMA (834)

2000 i.e. 16V (834AI)	Petrol	104	02/89 → 05/92
2000 i.e. 16V Turbo (834AL)	Petrol	130	04/89 → 05/92

THEMA SW (834)

2000 i.e. 16V (834AI)	Petrol	104	02/89 → 05/92
2000 i.e. 1.6V Turbo (834AL)	Petrol	130	04/89 → 03/93
2000 Turbo	Petrol	110	01/89 → 03/92

Y (840A)

1.1 (840AE)	Petrol	40	11/95 → 09/03
1.2 (840AA, 840AF1A)	Petrol	44	03/96 → 09/03
1.2 16V (840AD)	Petrol	63	04/97 → 09/03

YPSILON (843)

1.2	Petrol	44	10/03 → 12/11
1.2	Petrol	59	10/03 → 12/11

BAE801AK

**BOBINA D'ACCENSIONE
IGNITION COIL**

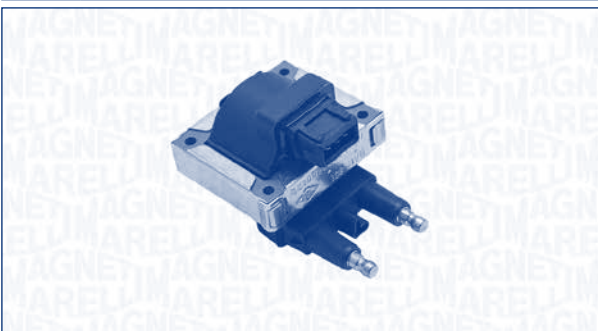

RENAULT

ESPACE II (J/S63_)

2.0 (J636)	Petrol	76	05/92 → 01/93	ENGINE: F3R728, 729, 742, 768, 769
------------	--------	----	---------------	------------------------------------

LAGUNA I (B56_, 556_)

1.8 (B56S/T/0)	Petrol	66	08/95 → 04/97	ENGINE: F3P670,678
1.8 (B56Z)	Petrol	69	08/95 → 04/97	ENGINE: F3P670,678
2.0	Petrol	70	11/93 → 04/97	ENGINE: F7R722,723
2.0 (B56C/H/N)	Petrol	83	11/93 → 04/97	ENGINE: F7R722,723
3.0 (B56E/R, B565)	Petrol	123	11/93 → 04/97	ENGINE: Z7X765-Z7X760

LAGUNA I Grandtour (K56_)

1.8 (K56S/T/0)	Petrol	66	09/95 → 04/97	ENGINE: F3P670,678
1.8 (K56Z)	Petrol	69	09/95 → 04/97	ENGINE: F3P670,678

MEGANE I Coach (DA0/1_)

2.0 i (DA0G)	Petrol	84	03/96 → 04/97	ENGINE: F3R750,751
--------------	--------	----	---------------	--------------------

BAE801EK

**BOBINA D'ACCENSIONE
IGNITION COIL**

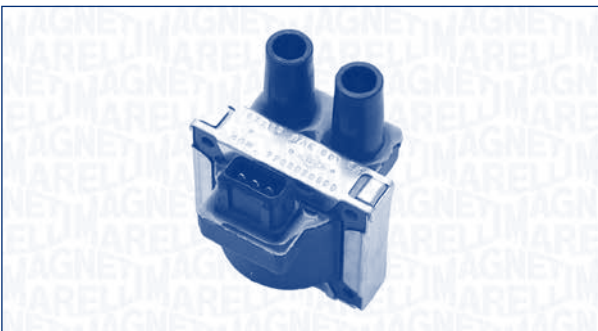

RENAULT

MEGANE I (BA0/1_)

2.0 i (BA0G)	Petrol	84	05/97 → 02/99	ENGINE: F3R796
--------------	--------	----	---------------	----------------

BAE801EK

RENAULT
MEGANE I Cabriolet (EA0/1_)

2.0 i (EA0G) Petrol 80 03/99 → 08/03 ENGINE: F3R750,751

MEGANE Scenic (JA0/1_)

2.0 i (JA0G) Petrol 80 01/99 → 09/99

SEAT
MARBELLA (28)

0.9 Cat. Petrol 29 01/90 → 11/96

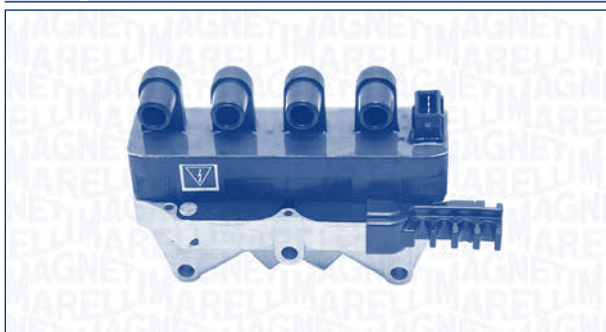
BAE920AX
**BOBINA D'ACCENSIONE
IGNITION COIL**

FIAT
BRAVA (182)

1.6 16V (182.BH) Petrol 66 10/95 → 10/01 ENGINE: 182A6000-182A4000

BRAVO I (182)

1.6 16V (182.AH) Petrol 66 10/95 → 10/01 ENGINE: 182A6000-182A4000

DOBLO (119)

1.6 Natural Power BiFuel 76 09/02 →

DOBLO Cargo (223)

1.6 Natural Power BiFuel 76 09/02 →

MAREA (185)

1.6 100 16V Bipower Petrol/CNG 76 04/99 → 05/02 ENGINE: 182A4000

MULTIPLA (186)

1.6 100 16V (186AXA1A) Petrol 76 04/99 → 06/10 ENGINE: 182A4000

1.6 16V Bipower (186AMB1A) Petrol/CNG 76 04/99 → 06/10 ENGINE: 182A4000

1.6 16V Bipower (186AXC1A) Petrol/CNG 76 10/01 → 06/10 ENGINE: 182A4000

BAE920AX

FIAT
MULTIPLA (186)

1.6 16V Blupower (186AMA1A) Bifuel 70 04/99 → 06/10 ENGINE: 182A4000

PALIO (178BX)

1.6 16V Petrol 74 04/96 → ENGINE: 178B3000

PALIO Weekend (178DX)

1.6 16V (178DX.D1A) Petrol 74 04/96 → 02/01 ENGINE: 178B3000

1.6 16V (178DYC1A06) Petrol 76 02/01 → ENGINE: 178B3000

SIENA (178_)

1.6 16V Petrol 78 09/98 → ENGINE: 178B3000

LANCIA
DEDRA (835)

1.6 16V (835EI) Petrol 76 01/96 → 07/99 ENGINE: 182A4000

DEDRA SW (835)

1.6 16V (835EI) Petrol 76 01/96 → 07/99 ENGINE: 182A4000

LYBRA (839AX)

1.6 16V (839AXA1A) Petrol 76 07/99 → 10/05 ENGINE: 182B6000

LYBRA SW (839BX)

1.6 16V (839BXA1A) Petrol 76 07/99 → 10/05 ENGINE: 182B6000

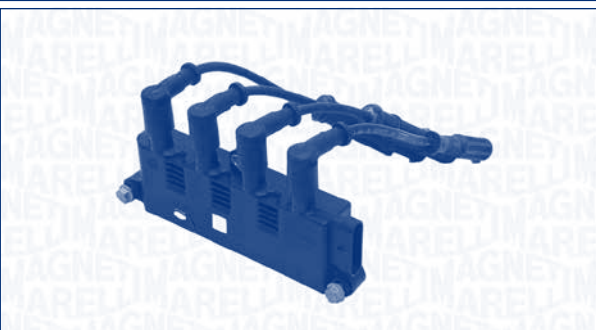
BAE940A
**BOBINA D'ACCENSIONE
IGNITION COIL**

FIAT
500 (312)

1.2 Petrol 51 10/07 →

DOBLO (119)

1.4 Petrol 57 10/05 → ENGINE: 831A1000

DOBLO Cargo (223)

1.4 Petrol 57 10/05 → ENGINE: 831A1000

BAE940A



kw



FIAT

IDEA

1.4 Petrol 57 10/05 →

LINEA (323)

1.4 Petrol 57 06/07 →

PALIO (178BX)

1.4 Petrol 51 04/96 →

PUNTO / GRANDE PUNTO (199)

1.2 Petrol 48 10/05 → ENGINE: 831A1000

1.4 Petrol 57 10/05 → ENGINE: 831A1000

SIENA (178_)

1.4 Petrol 51 04/96 →

1.4 Cat. Petrol 51 04/96 →

LANCIA

MUSA (350)

1.4 Petrol 57 09/05 → ENGINE: 831A1000

YPSILON (843)

1.4 Petrol 57 02/06 → 12/11

BAE960AE

**BOBINA D'ACCENSIONE
IGNITION COIL**

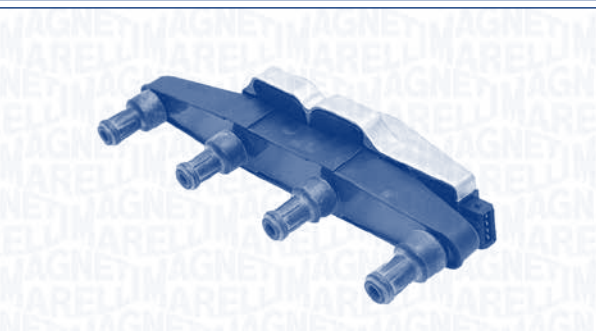

kw



SKODA

FELICIA II (6U1)

1.3 Petrol 40 01/98 → 06/01 ENGINE: AMG-AMJ

1.3 Petrol 43 01/98 → 06/01 ENGINE: AMG-AMJ

1.3 Petrol 50 01/98 → 06/01 ENGINE: AMG-AMJ

FELICIA II Station wagon (6U5)

1.3 Petrol 50 01/98 → 06/01 ENGINE: AMG-AMJ

1.6 Petrol 55 01/98 → 06/01 ENGINE: AMG-AMJ

BAE961AE

**BOBINA D'ACCENSIONE
IGNITION COIL**

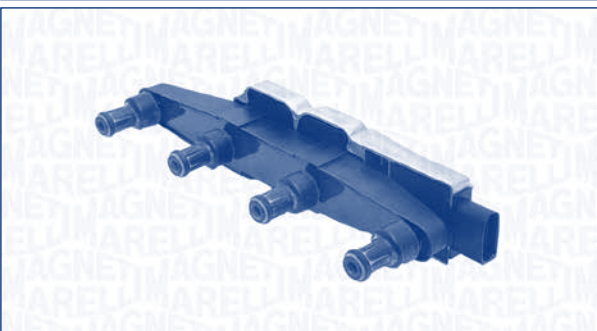

kw



SKODA

FABIA (6Y2)

1.0 Petrol 37 01/00 → 08/02 ENGINE: ARV-AQV-ATY

1.4 Petrol 50 08/99 → 05/03 ENGINE: AME-AQW-ATZ

FABIA Combi (6Y5)

1.4 Petrol 50 04/00 → 05/03 ENGINE: AME-AQW-ATZ

FABIA Praktik

1.4 Petrol 50 07/01 → 05/03 ENGINE: AME-AQW-ATZ

FABIA Tre volumi (6Y3)

1.4 Petrol 50 07/01 → 05/03 ENGINE: AME-AQW-ATZ

OCTAVIA (1U2)

1.4 Petrol 44 04/99 → 03/01 ENGINE: AMD

OCTAVIA (1Z3)

1.4 Petrol 55 05/04 → 05/06 ENGINE: AMD

VOLKSWAGEN

LUPO (6X1, 6E1)

1.0 Petrol 37 01/99 → 07/05 ENGINE: AER-AHT-ALD-ALL-ANV-AUC

BK2A
**BOBINA D'ACCENSIONE
IGNITION COIL**

KW

ALFA ROMEO
ALFASUD (901)

1.2 (901.D0, 901.D1)	Petrol	46	06/72 → 09/84
1.2 (901.D5)	Petrol	44	03/80 → 12/83
1.2 ti	Petrol	50	11/73 → 12/83
1.3 (901.F0)	Petrol	50	01/78 → 02/80
1.3 SC/ti Super	Petrol	55	09/77 → 12/83
1.3 Super (901.F2)	Petrol	51	01/79 → 12/83
1.3 ti (901.G0)	Petrol	55	09/77 → 12/83
1.3 ti (901.G4)	Petrol	63	03/80 → 12/83
1.5 ti	Petrol	70	03/80 → 12/83
1.5 ti (901.F1, 901.F4, 901.G1)	Petrol	61	01/79 → 12/83

ALFASUD Giardinetta (904)

1.2	Petrol	46	01/78 → 12/81
1.3	Petrol	48	01/78 → 07/79
1.3	Petrol	51	03/80 → 12/81

ALFASUD Sprint (902.A)

1.4	Petrol	55	05/78 → 02/80
1.4	Petrol	63	07/79 → 12/89
1.5 (902.A1)	Petrol	61	05/78 → 12/81
1.5 (902.A5)	Petrol	70	07/79 → 12/83

ARNA (920)

1.3 TI (920.A1B)	Petrol	63	03/83 → 12/85
------------------	--------	----	---------------

FIAT
124 Spider

1500 Sport (BS)	Petrol	66	01/66 → 12/72
1600 Sport (BS1)	Petrol	74	11/69 → 08/73
1600 Sport (BS1)	Petrol	80	01/69 → 12/74
1800 Sport (CS1)	Petrol	87	01/72 → 12/77

BK2A

KW

FIAT
127

0.9	Petrol	29	06/71 → 05/83	CHASSIS: 1221151 →
1.0	Petrol	37	04/77 → 12/86	
1.0 Sport	Petrol	51	07/78 → 02/82	
1.3 Sport	Petrol	55	12/81 → 05/83	

128

1.1	Petrol	33	02/75 → 09/81
1.1	Petrol	40	03/69 → 12/84
1.3 Sport	Petrol	44	08/74 → 12/84

128 Coupé

1.3 Berlinetta (AC)	Petrol	54	06/75 → 12/79
---------------------	--------	----	---------------

131

1.3 Mirafiori	Petrol	40	10/74 → 09/81
1.3 Super Mirafiori	Petrol	57	03/78 → 12/80
1.6	Petrol	63	11/76 → 12/84
1.6 (S)	Petrol	55	10/74 → 12/80
1.6 Super	Petrol	71	03/78 → 01/84

850 Coupé

0.9 Sport	Petrol	38	02/68 → 10/72
-----------	--------	----	---------------

850 Spider

0.9 Sport	Petrol	38	03/68 → 12/72
-----------	--------	----	---------------

FIORINO (127)

1050	Petrol	37	01/80 → 12/87
------	--------	----	---------------

PANDA (141A_)

900	Petrol	33	10/80 → 06/94
1000	Petrol	32	01/86 → 04/92
1000	Petrol	37	01/85 → 12/92
1000 4x4	Petrol	32	01/86 → 07/89
1000 4x4	Petrol	33	10/87 → 05/91
750 (141AA)	Petrol	25	01/86 → 01/95
950 4x4	Petrol	35	09/83 → 12/85

PANDA Van (141_)

750	Petrol	25	01/86 → 07/92
1000	Petrol	32	01/86 → 02/92

REGATA (138)

70 1.3	Petrol	48	09/83 → 12/85
85 1.5	Petrol	58	05/85 → 12/87

REGATA Weekend

70 1.3	Petrol	50	01/84 → 12/85
75 1.5	Petrol	55	09/84 → 12/85

BK2A



FIAT

RITMO I (138A)

60 1.0	Petrol	44	09/78 → 09/82
65 1.3	Petrol	48	01/78 → 09/82
75 1.3	Petrol	55	01/81 → 09/82

RITMO II (138A)

60 1.1	Petrol	43	04/85 → 12/87
60 1.1	Petrol	40	10/82 → 10/85
70 1.3	Petrol	50	01/83 → 04/85
85 1.5	Petrol	60	01/83 → 12/87

UNO (146A/E)

55 1.1	Petrol	40	01/83 → 08/89
70 1.3	Petrol	50	01/83 → 04/85

X 1/9 (128 AS)

1.3	Petrol	54	10/75 → 06/78
1.3	Petrol	55	05/73 → 12/79
1.5	Petrol	56	06/85 → 12/89
1.5	Petrol	63	11/78 → 12/89

LANCIA

A 112

0.9 Junior (A112B/2)	Petrol	29	03/81 → 06/86
1.0 LX	Petrol	35	03/84 → 12/86

DELTA I (831AB0)

1.3	Petrol	58	09/83 → 12/86
1.3 (831AB.011)	Petrol	55	09/79 → 12/86

RENAULT

4 (112_)

1.1 (1128, S128)	Petrol	25	06/78 → 06/90
------------------	--------	----	---------------

SUPER 5 (B/C40_)

1.0 (B/C/400)	Petrol	30	10/84 → 10/88
1.1 (B/C/401)	Petrol	34	10/84 → 10/88

SEAT

131

1.5	Petrol	55	03/82 → 01/85
1.6	Petrol	71	03/82 → 01/85

FURA (025A)

0.9	Petrol	33	01/82 → 06/86
0.9	Petrol	29	03/84 → 12/86

BZ600A

**BOBINA D'ACCENSIONE
IGNITION COIL**



FIAT

126

650	Petrol	17	07/77 → 09/87
-----	--------	----	---------------

PANDA (141A_)

650	Petrol	22	01/82 → 07/04
-----	--------	----	---------------

GRUPPO J - GROUP J

SUA129

**J3
CILC COMANDO INDICATORE LIVELLO CARBURANTE
FUEL LEVEL SENDER**

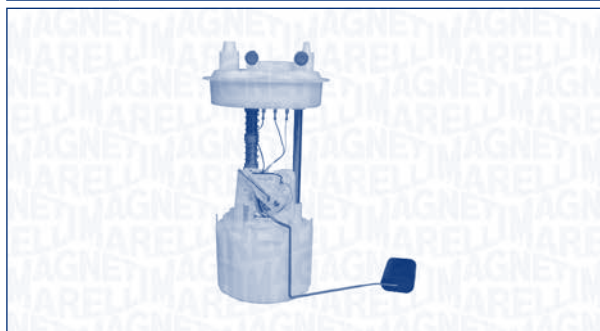

FIAT

PUNTO (176)

1.7 D	Diesel	42	04/94 → 09/97
1.7 TD	Diesel	51	01/94 → 09/99
1.7 TD	Diesel	52	01/94 → 09/99

PUNTO Van (176L)

1.7 D	Diesel	42	04/96 → 02/00
1.7 TD	Diesel	52	04/96 → 02/00

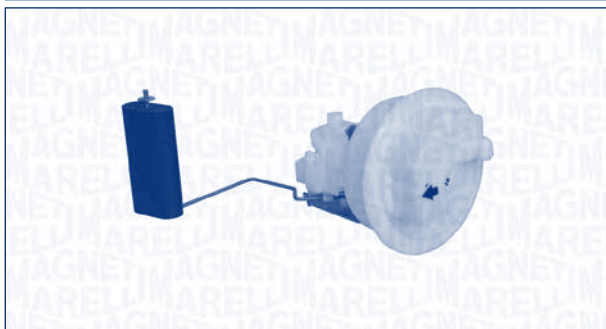
SUA138
J3
CILC | **COMANDO INDICATORE LIVELLO CARBURANTE**
FUEL LEVEL SENDER

CITROËN
ZX (N2)

1.1	Petrol	44	10/91 → 03/94
1.4 i	Petrol	55	08/92 → 06/95
1.6 i	Petrol	65	03/91 → 06/95
1.8 D	Diesel	44	06/93 → 06/95
1.8 i	Petrol	74	07/92 → 06/95
1.9 D	Diesel	47	03/91 → 06/95
1.9 D	Diesel	50	05/94 → 06/97
1.9 i	Petrol	88	03/91 → 04/94
1.9 TD	Diesel	66	07/92 → 06/95
2.0 i	Petrol	89	07/92 → 06/97
2.0 i 16V	Petrol	112	07/92 → 10/94
2.0 i 16V	Petrol	110	06/94 → 06/95

ZX Break (N2)

1.4 i	Petrol	55	10/93 → 06/95
1.6 i	Petrol	65	10/93 → 06/95
1.8 D	Diesel	44	10/93 → 10/97
1.8 i	Petrol	74	10/93 → 06/95
1.9 D	Diesel	47	05/94 → 04/97
1.9 D	Diesel	50	06/94 → 06/95
1.9 TD	Diesel	66	10/93 → 06/95

PEUGEOT
306 Cabriolet (7D, N3, N5)

1.8	Petrol	74	03/94 → 04/95
2.0	Petrol	89	03/94 → 04/95

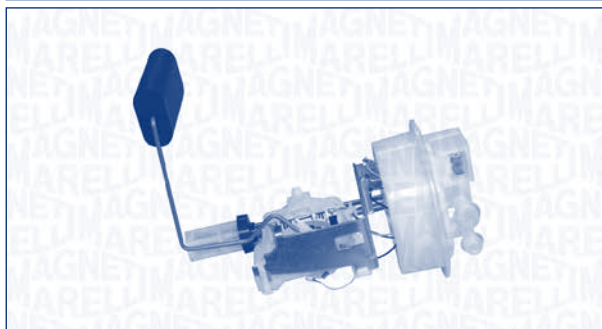
SUA139
J3
CILC | **COMANDO INDICATORE LIVELLO CARBURANTE**
FUEL LEVEL SENDER

CITROËN
ZX (N2)

1.1	Petrol	44	03/91 → 06/97
1.4	Petrol	55	03/91 → 06/97
1.4 i	Petrol	55	03/91 → 06/97
1.6 i	Petrol	65	03/91 → 06/97
1.8 i	Petrol	74	07/92 → 06/97
2.0 i 16V	Petrol	110	06/94 → 06/97

ZX Break (N2)

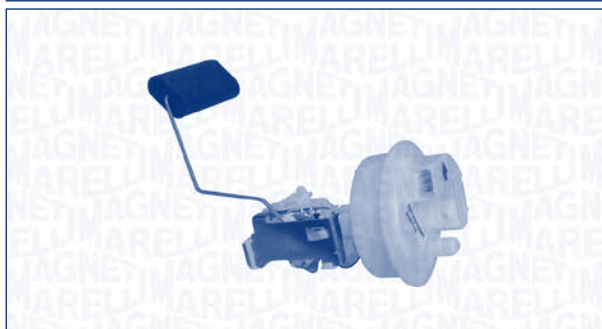
1.9 D	Diesel	47	10/93 → 10/97
1.9 D	Diesel	50	06/94 → 10/97

SUA141
J3
CILC | **COMANDO INDICATORE LIVELLO CARBURANTE**
FUEL LEVEL SENDER

PEUGEOT
306 (7B, N3, N5)

1.1	Petrol	44	06/94 → 04/97
1.4 SL	Petrol	55	06/94 → 04/97
1.6 SR	Petrol	65	06/94 → 04/97
1.8 ST	Petrol	74	06/94 → 04/97
1.9 SLD	Diesel	47	06/94 → 06/94
1.9 SLD	Diesel	50	07/96 → 04/97
1.9 SRDT	Diesel	66	06/94 → 04/97

SUA141



PEUGEOT

306 (7B, N3, N5)

2.0 S16	Petrol	110	08/94 → 04/97
2.0 S16	Petrol	112	06/94 → 04/97
2.0 ST	Petrol	89	07/94 → 04/97

306 2 volumi /Coda spiovente (7A, 7C, N3, N5)

1.1	Petrol	44	05/93 → 04/97
1.4	Petrol	55	05/93 → 04/97
1.6	Petrol	65	05/93 → 04/97
1.8	Petrol	74	05/93 → 04/97
1.8 D	Diesel	43	05/93 → 04/97
1.9 D	Diesel	50	06/94 → 05/01
1.9 D	Diesel	47	05/93 → 06/94
1.9 DT	Diesel	66	05/93 → 04/97
2.0 S16	Petrol	110	08/94 → 04/97
2.0 S16	Petrol	112	08/93 → 04/97
2.0 XSi	Petrol	89	08/93 → 04/97

SUA146

J3
CILC COMANDO INDICATORE LIVELLO CARBURANTE
FUEL LEVEL SENDER

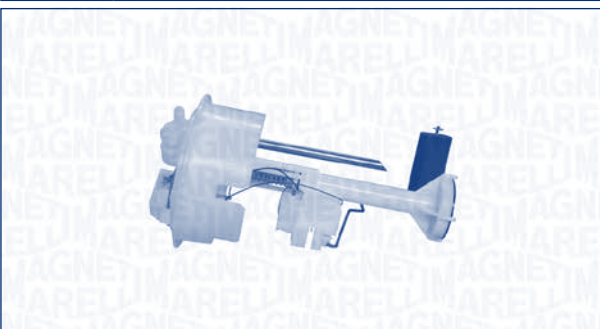

CITROËN

EVASION (22, U6)

1.9 TD	Diesel	66	11/94 → 07/02
1.9 TD	Diesel	68	10/95 → 12/98
2.0 16V	Petrol	100	05/00 → 07/02
2.0 TD	Diesel	68	05/97 → 07/02

JUMPY (U6U)

1.9 D 70	Diesel	51	04/98 →
----------	--------	----	---------

JUMPY Pianale piatto/Telaio (BU_, BV_, BW_, BX_)

1.9 TD	Diesel	68	10/99 →
--------	--------	----	---------

FIAT

ULYSSE (220)

1.9 TD (220AH5)	Diesel	66	02/95 → 08/02
-----------------	--------	----	---------------

SUA146



PEUGEOT

806 (221)

1.9 TD	Diesel	66	07/95 → 08/02
1.9 TD	Diesel	68	05/97 → 08/02
2.0 HDI 16V	Diesel	80	08/99 → 08/02

EXPERT (224)

1.9 TD	Diesel	66	02/96 →
--------	--------	----	---------

EXPERT Furgonato (222)

1.9 D	Diesel	51	02/96 →
1.9 TD	Diesel	66	02/96 →
1.9 TD	Diesel	68	02/96 →

EXPERT Pianale piatto/Telaio (223)

1.9 D	Diesel	51	02/96 →
1.9 TD	Diesel	66	02/96 →
1.9 TD	Diesel	68	02/96 →

SUA187

J3
CILC COMANDO INDICATORE LIVELLO CARBURANTE
FUEL LEVEL SENDER

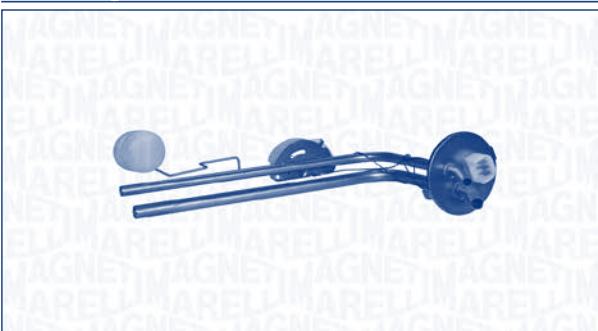

RENAULT

TRAFIC Autobus (TXW)

1.9 D	Diesel	44	06/97 → 03/01
2.5 D	Diesel	55	05/89 → 03/01

TRAFIC Furgonato (TXX)

1.9 D	Diesel	44	06/97 → 03/01
-------	--------	----	---------------

TRAFIC Pianale piatto/Telaio (PXX)

2.5 D	Diesel	51	05/89 → 03/01
-------	--------	----	---------------

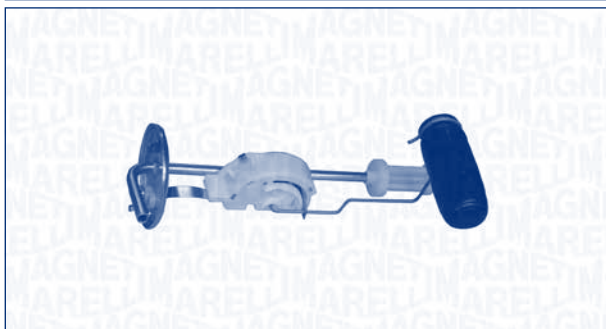
SUA188
J3
CILC **COMANDO INDICATORE LIVELLO CARBURANTE**
FUEL LEVEL SENDER

KW

CITROËN
2 CV

4	Petrol	12	03/63 → 02/70
4	Petrol	17	01/70 → 12/75
6	Petrol	18	09/75 → 06/81
6	Petrol	20	08/79 → 07/90
6	Petrol	21	02/70 → 10/85

SUA220
J3
CILC **COMANDO INDICATORE LIVELLO CARBURANTE**
FUEL LEVEL SENDER

KW

RENAULT
SUPER 5 (B/C40_)

1.6 D (B/C/404)	Diesel	40	08/85 → 06/89
-----------------	--------	----	---------------

SUPER 5 Furgonato (S40_)

1.6 D (S404)	Diesel	40	10/84 → 06/89
--------------	--------	----	---------------

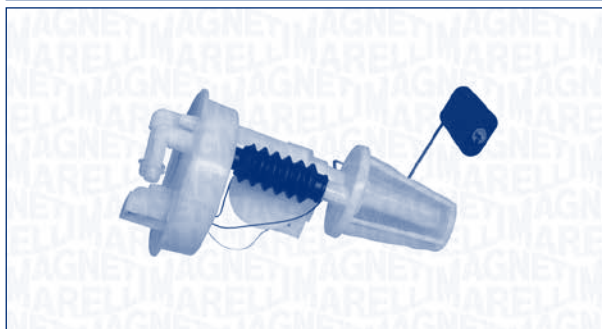
SUA230
J3
CILC **COMANDO INDICATORE LIVELLO CARBURANTE**
FUEL LEVEL SENDER

KW

PEUGEOT
405 I (15B)

1.8 Turbo Diesel	Diesel	66	03/88 → 12/92
1.9 Diesel	Diesel	51	03/88 → 12/92

405 I Break (15E)

1.8 TD	Diesel	66	10/88 → 08/92
1.9 D	Diesel	47	10/88 → 08/92
1.9 D	Diesel	51	10/88 → 08/92

405 II (4B)

1.9 D	Diesel	47	08/92 → 06/94
1.9 D	Diesel	50	07/94 → 10/95

405 II Break (4E)

1.9 D	Diesel	47	08/92 → 06/94
1.9 D	Diesel	50	07/94 → 10/96

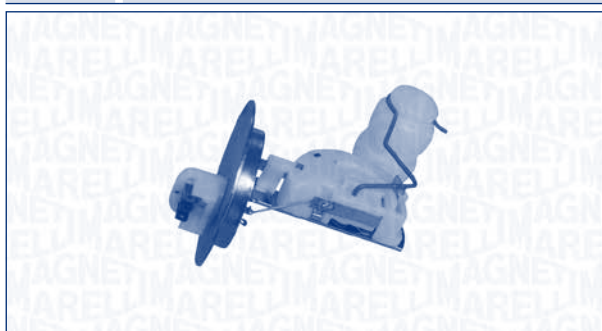
SUA239
J3
CILC **COMANDO INDICATORE LIVELLO CARBURANTE**
FUEL LEVEL SENDER

KW

RENAULT
MASTER I Autobus (T__)

28-35 2,5 TD	Diesel	72	08/89 → 07/98
28-35 2.0	Petrol	58	03/89 → 07/98
28-35 2.1 D	Diesel	44	03/89 → 07/98
28-35 2.4 D	Diesel	52	03/89 → 08/89

SUA141



RENAULT

MASTER I Autobus (T__)

28-35 2.5 D	Diesel	55	08/89 → 07/98
30 2,2	Petrol	67	08/80 → 07/98
35 2,5 TD	Diesel	69	08/89 → 07/98

MASTER I Furgonato (T__)

28-35 2,5 D	Diesel	55	08/89 → 07/98
28-35 2,5 TD	Diesel	72	08/89 → 07/98
28-35 2.0	Petrol	58	03/89 → 07/98
28-35 2.1 D	Diesel	44	03/89 → 07/98
28-35 2.4 D	Diesel	52	03/89 → 08/89
30 2,2	Petrol	67	03/89 → 07/98
35 2,5 TD	Diesel	69	08/89 → 07/98

MASTER I Pianale piatto/Telaio (P__)

28-35 2.0	Petrol	58	03/89 → 07/98
28-35 2.5 D	Diesel	52	03/89 → 07/98

SUA265

J3 CILC COMANDO INDICATORE LIVELLO CARBURANTE
FUEL LEVEL SENDER

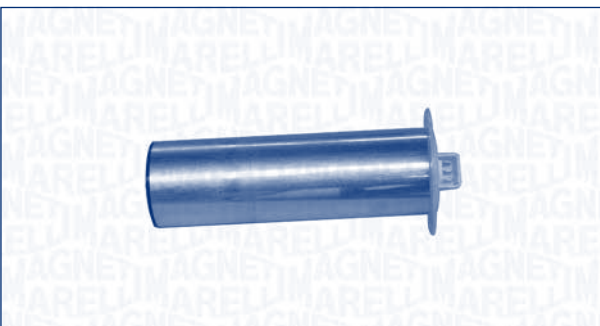

RENAULT

CLIO I (B/C57_, 5/357_)

1.9 D (B/C/S576, B/C/S57L)	Diesel	47	01/91 → 02/98
----------------------------	--------	----	---------------

CLIO I Furgonato (S57_)

1.9 D	Diesel	48	01/91 → 02/98
-------	--------	----	---------------

RAPID Furgonato (F40_, G40_)

1.6 D (F404)	Diesel	40	07/89 → 03/97
1.9 D (F40P, F40N, F40E)	Diesel	47	09/91 → 10/97

SUPER 5 (B/C40_)

1.6 D (B/C/404)	Diesel	40	07/89 → 12/96
-----------------	--------	----	---------------

SUPER 5 Furgonato (S40_)

1.6 D (S404)	Diesel	40	07/89 → 12/96
--------------	--------	----	---------------

SUA266

J3 CILC COMANDO INDICATORE LIVELLO CARBURANTE
FUEL LEVEL SENDER

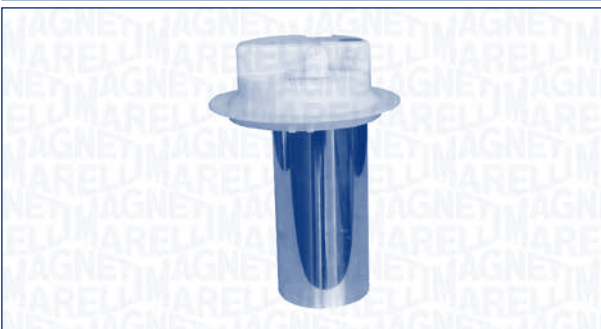

RENAULT

CLIO I (B/C57_, 5/357_)

1.1	Petrol	34	01/91 → 01/93
1.2 (5/357Y, 5/357K)	Petrol	40	01/96 → 09/98
1.2 (B/C/S577)	Petrol	40	01/96 → 12/96
1.2 (B/C/S57A, B/C57S, 5/357F, 5/357J, 5/357L, 5/357R)	Petrol	43	05/90 → 01/93

1.4	Petrol	59	01/91 → 01/93
1.4 (B57J, C57J)	Petrol	55	01/91 → 01/93
1.8 16V (C57D)	Petrol	99	07/91 → 06/94

RAPID Furgonato (F40_, G40_)

1.4 (F407) Cat.	Petrol	43	09/91 → 03/98
1.4 (F40U, F40V)	Petrol	55	09/91 → 03/98

SUA278

J3 CILC COMANDO INDICATORE LIVELLO CARBURANTE
FUEL LEVEL SENDER



RENAULT

RAPID Furgonato (F40_, G40_)

1.0	Petrol	27	07/89 → 08/91
1.1 (F401)	Petrol	33	07/89 → 08/91

SUA278

RENAULT
RAPID Furgonato (F40_, G40_)

1.1 (F40H)	Petrol	33	07/89 → 08/91
1.4 (F40M)	Petrol	44	07/89 → 08/91

SUPER 5 (B/C40_)

1.1 (B/C/401, B/C40H)	Petrol	33	07/89 → 08/90
1.2 (B/C40F)	Petrol	40	07/89 → 08/90
1.4 (B/C403)	Petrol	52	07/89 → 07/89
1.4 (B/C40J)	Petrol	49	07/89 → 07/89
1.4 (B/C40M)	Petrol	44	07/89 → 08/90

1.7 (B/C40K, B/C40G)	Petrol	64	07/89 → 03/95
----------------------	--------	----	---------------

SUPER 5 Furgonato (S40_)

1.1 (S401)	Petrol	34	07/89 → 12/96
1.2 (S40F, S407)	Petrol	44	07/89 → 12/96

SUA287

**J3
CILC** **COMANDO INDICATORE LIVELLO CARBURANTE
FUEL LEVEL SENDER**

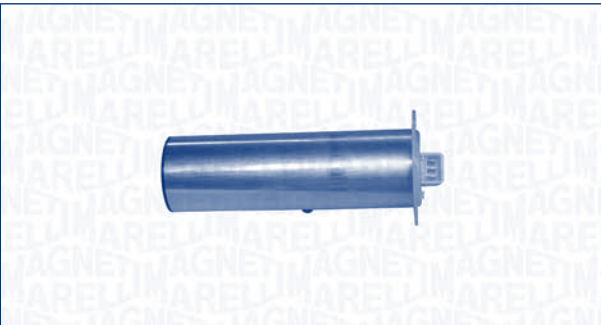
PEUGEOT
205 I (741A/C)

1.0	Petrol	33	02/83 → 10/87
1.1	Petrol	36	02/83 → 10/87
1.1	Petrol	37	02/83 → 10/87
1.4	Petrol	44	02/83 → 10/87
1.4	Petrol	53	02/83 → 10/87
1.4	Petrol	58	10/85 → 10/87
1.4	Petrol	59	02/83 → 10/87
1.6	Petrol	55	08/86 → 10/87
1.6	Petrol	55	08/86 → 10/87
1.6 GTI	Petrol	76	12/84 → 10/87
1.7 Diesel	Diesel	44	10/83 → 10/87
1.9 GTI	Petrol	94	10/86 → 10/87

SUA287

PEUGEOT
205 I Cabriolet (741B, 20D)

1.1 CJ	Petrol	44	10/89 → 12/94
1.4 CJ	Petrol	44	03/88 → 05/89
1.4 CJ	Petrol	49	03/89 → 12/94
1.4 CJ	Petrol	55	06/91 → 12/94
1.4 CT	Petrol	58	04/86 → 12/88
1.6 CJ	Petrol	65	08/92 → 12/94
1.6 CTI	Petrol	76	04/86 → 10/87
1.9 CTI	Petrol	75	10/87 → 12/94

205 II (20A/C)

1.0	Petrol	33	10/87 → 09/98
1.1	Petrol	36	10/87 → 10/90
1.1	Petrol	44	07/89 → 09/98
1.1	Petrol	40	10/87 → 10/90
1.3 Rallye	Petrol	74	10/87 → 10/90
1.4	Petrol	44	10/87 → 05/89
1.4	Petrol	49	10/87 → 10/90
1.4	Petrol	53	01/87 → 07/88
1.4	Petrol	55	07/88 → 09/98
1.4	Petrol	58	07/88 → 12/88
1.4	Petrol	62	06/87 → 12/89
1.4	Petrol	63	10/87 → 12/89
1.4 Cat.	Petrol	44	10/87 → 10/90
1.6 Aut.	Petrol	65	11/90 → 09/98
1.6 Aut.	Petrol	58	10/90 → 09/98
1.6 GTI	Petrol	76	10/88 → 12/89
1.6 GTI	Petrol	85	10/87 → 12/89
1.7 Diesel	Diesel	44	07/87 → 12/89
1.8 TD	Diesel	57	01/90 → 09/98
1.9 Diesel	Diesel	47	10/87 → 09/98
1.9 GTI	Petrol	88	10/87 → 10/94
1.9 GTI	Petrol	94	10/87 → 09/98
1.9 GTI Cat.	Petrol	75	10/87 → 07/94

309 I (10C, 10A)

1.1	Petrol	40	10/85 → 07/89
1.3	Petrol	47	10/85 → 07/89
1.4	Petrol	55	03/89 → 07/89
1.4	Petrol	49	03/89 → 07/89
1.4	Petrol	62	03/89 → 07/89
1.5	Petrol	63	06/87 → 12/89
1.6	Petrol	76	11/85 → 09/88
1.6	Petrol	53	08/87 → 07/89
1.6	Petrol	55	10/85 → 07/89
1.6	Petrol	59	10/86 → 07/89
1.6	Petrol	69	10/86 → 07/89

SUA287



PEUGEOT

309 I (10C, 10A)

1.6 Cat.	Petrol	55	09/86 → 06/88
1.9	Petrol	72	03/86 → 07/89
1.9	Petrol	80	07/88 → 07/89
1.9	Petrol	75	10/85 → 07/89
1.9 D	Diesel	47	06/86 → 07/89
1.9 GTI	Petrol	88	07/88 → 07/89
1.9 GTI	Petrol	94	10/86 → 07/89

309 II (3C, 3A)

1.1	Petrol	44	10/90 → 12/93
1.4	Petrol	55	06/90 → 12/93
1.6	Petrol	65	07/89 → 12/93
1.6	Petrol	68	07/89 → 12/93
1.6	Petrol	69	07/89 → 12/93
1.8 Diesel	Diesel	44	07/89 → 12/93
1.8 TD	Diesel	57	11/89 → 12/93
1.9	Petrol	72	08/89 → 12/93
1.9	Petrol	80	10/90 → 12/93
1.9 Diesel	Diesel	47	07/89 → 12/93
1.9 GTI	Petrol	88	07/89 → 12/93
1.9 GTI 16V	Petrol	116	02/90 → 07/90

SUA319

J3 CILC COMANDO INDICATORE LIVELLO CARBURANTE
FUEL LEVEL SENDER

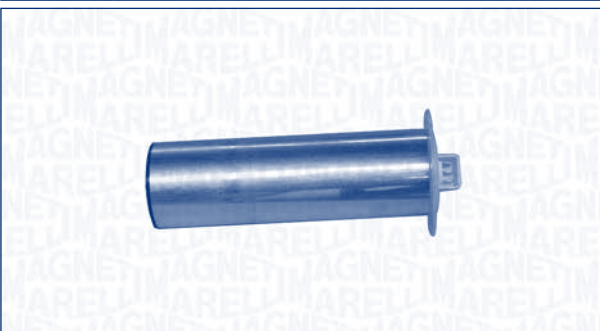

CITROËN

BX (XB-)

14	Petrol	55	01/89 → 02/93
16	Petrol	68	10/82 → 12/92
16	Petrol	76	03/86 → 02/93
14 E	Petrol	45	10/82 → 06/88
14 E	Petrol	49	09/85 → 02/93
14 E	Petrol	52	04/83 → 07/89
14 E	Petrol	53	04/83 → 02/93

SUA319



CITROËN

BX (XB-)

19 D	Diesel	47	09/83 → 12/87
19 GTi	Petrol	90	07/86 → 02/93
TRD Turbo	Diesel	66	03/88 → 02/93

BX Break (XB-)

19	Petrol	75	07/86 → 12/94
18 D	Diesel	44	10/85 → 09/93
19 Cat.	Petrol	75	07/86 → 12/94
19 D	Diesel	47	09/83 → 12/87
19 D	Diesel	51	03/87 → 12/94

SUA351

J3 CILC COMANDO INDICATORE LIVELLO CARBURANTE
FUEL LEVEL SENDER

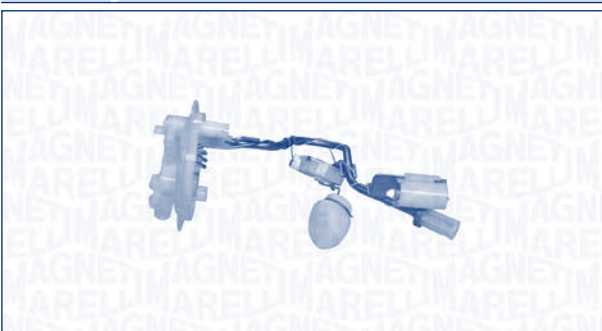

RENAULT

19 I (B/C53_)

1.2	Petrol	40	09/88 → 12/92
1.4	Petrol	59	09/88 → 12/92
1.4 (B/C532) Cat.	Petrol	43	02/91 → 04/92
1.7 (B/C53B)	Petrol	54	02/91 → 04/92
1.7 (B/C53C)	Petrol	66	02/91 → 04/92

19 I Chamade (L53_)

1.2	Petrol	40	09/88 → 12/92
1.4 (L532, L53P)	Petrol	43	09/88 → 04/92

19 I Furgonato (S53_)

1.2	Petrol	40	09/88 → 12/92
1.4	Petrol	59	09/88 → 12/92

19 II (B/C53_)

1.2	Petrol	40	04/92 → 12/95
1.4	Petrol	59	01/92 → 12/95

19 II Furgonato (S53_)

1.2	Petrol	40	03/92 → 12/95
1.4	Petrol	59	03/92 → 12/95

SUA371
**J3
CILC** COMANDO INDICATORE LIVELLO CARBURANTE
FUEL LEVEL SENDER

CITROËN
BERLINGO (MF)

1.9 D (MFWJZ) Diesel 51 07/98 → 12/00 ENGINE: XUD9

1.9 D 4WD (MFWJZ) Diesel 51 07/98 → 12/00 ENGINE: XUD9

BERLINGO Furgonato (M_)

1.9 D 70 (MBWJZ, MCWJZ) Diesel 51 04/99 → 12/00 ENGINE: XUD9

1.9 D 70 4WD (MBWJZ, MCWJZ) Diesel 51 07/98 → 12/00 ENGINE: XUD9

PEUGEOT
RANCH MPV / Space wagon (5F)

1.9 D Diesel 50 06/96 → 12/00 ENGINE: XUD9

1.9 D Diesel 51 12/98 → 12/00 ENGINE: XUD9

SUA383
**J3
CILC** COMANDO INDICATORE LIVELLO CARBURANTE
FUEL LEVEL SENDER

PEUGEOT
306 (7B, N3, N5)

1.4 SL Petrol 55 01/97 → 05/01 ENGINE: C(TU3-2)

1.9 D Diesel 51 09/98 → 05/01 ENGINE: XUD9

1.9 D Diesel 55 03/98 → 05/01 ENGINE: (DW8)

306 2 volumi /Coda spiovente (7A, 7C, N3, N5)

1.4 Petrol 55 01/98 → 05/01 ENGINE: C(TU3-2)

306 Break (7E, N3, N5)

1.4 Petrol 55 03/97 → 04/02 ENGINE: C(TU3-2)

1.9 D Diesel 50 01/98 → 04/02 ENGINE: XUD9TE

1.9 D Diesel 51 09/98 → 04/02 ENGINE: XUD9TE

1.9 D Diesel 55 03/98 → 04/02 ENGINE: (DW8)

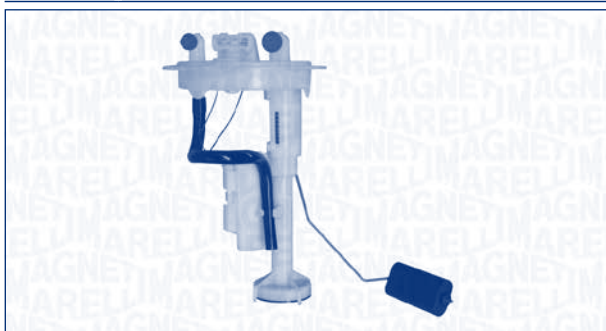
SUA382
**J3
CILC** COMANDO INDICATORE LIVELLO CARBURANTE
FUEL LEVEL SENDER

PEUGEOT
406 (8B)

1.9 D Diesel 55 10/96 → 12/97 ENGINE: (XUD9SD, XUD9TE)

2.1 TD 12V Diesel 80 01/96 → 12/97 ENGINE: (XUD11BTE)

SUA384
**J3
CILC** COMANDO INDICATORE LIVELLO CARBURANTE
FUEL LEVEL SENDER

PEUGEOT
206 2 volumi /Coda spiovente (2A/C)

1.9 D Diesel 51 09/98 → 12/00 ENGINE: DW8

SUA386

J3 CILC COMANDO INDICATORE LIVELLO CARBURANTE
FUEL LEVEL SENDER

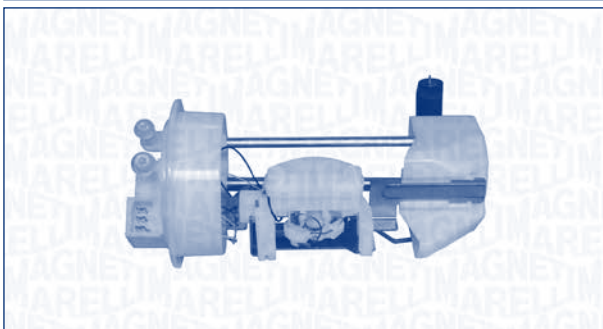

KW



PEUGEOT

106 I (1A, 1C)

1.0	Petrol	33	09/91 → 04/96	ENGINE: C(TU9)
1.0	Petrol	37	09/91 → 04/96	ENGINE: C(TU9)
1.1	Petrol	44	09/91 → 04/96	ENGINE: C(TU1)
1.4	Petrol	55	09/91 → 04/96	ENGINE: C
1.4	Petrol	69	09/91 → 04/96	ENGINE: C

SUA394

J3 CILC COMANDO INDICATORE LIVELLO CARBURANTE
FUEL LEVEL SENDER



KW



RENAULT

CLIO II (BB0/1/2_, CB0/1/2_)

1.9 D (B/CB0E)	Diesel	47	09/98 → 05/05
----------------	--------	----	---------------

CLIO II Furgonato (SB0/1/2_)

1.9 D (SB0E)	Diesel	47	09/98 →
--------------	--------	----	---------

SUA398

J3 CILC COMANDO INDICATORE LIVELLO CARBURANTE
FUEL LEVEL SENDER



KW



RENAULT

ESPACE III (JE0_)

2.2 12V TD (JE0E, JE0H, JE0P)	Diesel	83	01/97 → 10/00
-------------------------------	--------	----	---------------

SUA405

J3 CILC COMANDO INDICATORE LIVELLO CARBURANTE
FUEL LEVEL SENDER



KW



CITROËN

BERLINGO (MF)

1.9 D (MFWJZ)	Diesel	51	01/01 →	ENGINE: DW8
---------------	--------	----	---------	-------------

1.9 D 4WD (MFWJZ)	Diesel	51	01/01 →	ENGINE: DW8
-------------------	--------	----	---------	-------------

BERLINGO Furgonato (M_)

1.9 D 70 (MBWJZ, MCWJZ)	Diesel	51	01/01 →	ENGINE: DW8
-------------------------	--------	----	---------	-------------

1.9 D 70 4WD (MBWJZ, MCWJZ)	Diesel	51	01/01 →	ENGINE: DW8
-----------------------------	--------	----	---------	-------------

PEUGEOT

RANCH MPV / Space wagon (5F)

1.9 D	Diesel	50	01/01 →	ENGINE: DW8
-------	--------	----	---------	-------------

1.9 D	Diesel	51	01/01 →	ENGINE: DW8
-------	--------	----	---------	-------------

SUA411
J3
CILC COMANDO INDICATORE LIVELLO CARBURANTE
FUEL LEVEL SENDER

RENAULT
CLIO II (BB0/1/2_, CB0/1/2_)

1.5 dCi (B/CB07) Diesel 48 06/01 →

1.5 dCi (B/CB08) Diesel 60 06/01 →

SUA424
J3
CILC COMANDO INDICATORE LIVELLO CARBURANTE
FUEL LEVEL SENDER

FIAT
PUNTO (188)

 1.9 DS 60
 (188.031, .051, Diesel 44 09/99 →
 .231, .251)

PUNTO Van (188AX)

1.9 D 60 Diesel 44 02/00 → 10/09

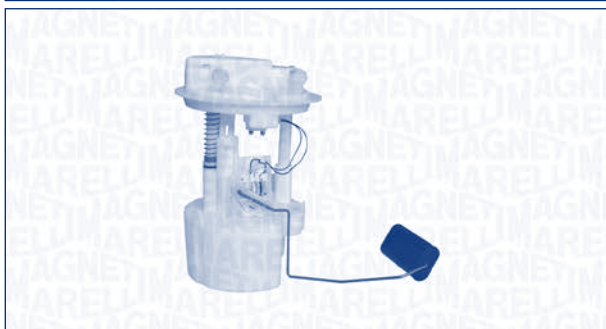
SUA412
J3
CILC COMANDO INDICATORE LIVELLO CARBURANTE
FUEL LEVEL SENDER

RENAULT
CLIO II (BB0/1/2_, CB0/1/2_)

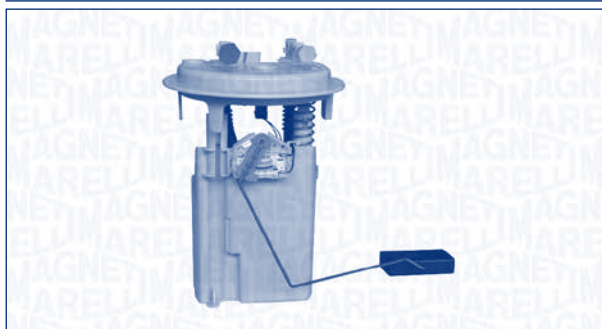
1.9 dTi (B/CB0U) Diesel 59 01/01 → 05/05

SUA456
J3
CILC COMANDO INDICATORE LIVELLO CARBURANTE
FUEL LEVEL SENDER

CITROËN
C4 Coupé (LA_)

1.6 HDi Diesel 66 11/04 →

1.6 HDi Diesel 80 11/04 →

2.0 HDi Diesel 100 11/04 →

C4 I (LC_)

1.6 HDi Diesel 80 11/04 →

2.0 HDi Diesel 100 11/04 →

C5 II (RC_)

 1.6 HDi
 (RC8HZB) Diesel 80 09/04 →

 2.0 HDi
 (RCRHRH) Diesel 100 09/04 →

SUA456



CITROËN

C5 II (RC_)

2.2 HDi Diesel 125 04/06 →

C5 II Break (RE_)

1.6 HDi (RE8HZB) Diesel 80 09/04 →

2.0 HDi (RERHRH) Diesel 100 09/04 →

2.2 HDi Diesel 125 04/06 →

PEUGEOT

307 (3A/C)

1.4 HDi Diesel 50 10/01 → 05/05

1.6 HDi Diesel 66 04/05 → 05/05

1.6 HDi 110 Diesel 80 02/04 → 05/05

2.0 HDi 135 Diesel 100 10/03 → 05/05

2.0 HDi 90 Diesel 66 08/00 →

307 CC (3B)

2.0 HDi 135 Diesel 100 06/05 →

807 (E)

2.0 HDi Diesel 100 06/06 →

SUA465

J3 CILC COMANDO INDICATORE LIVELLO CARBURANTE
FUEL LEVEL SENDER

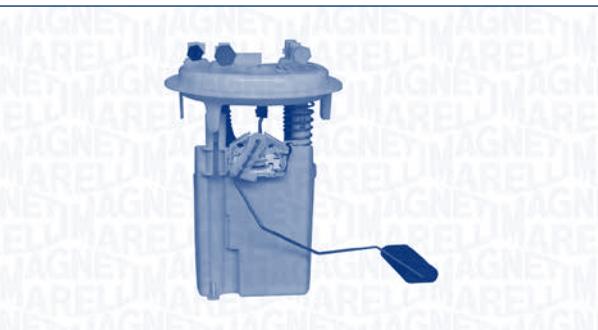

CITROËN

C5 III (RD_)

1.6 HDi Diesel 80 02/08 →

PEUGEOT

407 (6D_)

1.6 HDi 110 Diesel 80 05/04 →

2.0 HDi 135 Diesel 100 05/04 →

407 SW (6E_)

1.6 HDi 110 Diesel 80 05/04 →

2.0 HDi 135 Diesel 100 05/04 →

SUA485

J3 CILC COMANDO INDICATORE LIVELLO CARBURANTE
FUEL LEVEL SENDER



DACIA

LOGAN (LS_)

1.5 dCi (LS0J, LS0Y) Diesel 48 09/05 → ENGINE: K9K

SUA497

J3 CILC COMANDO INDICATORE LIVELLO CARBURANTE
FUEL LEVEL SENDER



CITROËN

C4 Picasso I (UD_)

2.0 HDi 138 Diesel 100 02/07 →

SUA509
J3
CILC **COMANDO INDICATORE LIVELLO CARBURANTE**
FUEL LEVEL SENDER

MERCEDES-BENZ
CLASSE A (W168)

A 160 CDI (168.006)	Diesel	55	02/01 → 08/04	
A 160 CDI (168.007)	Diesel	44	01/01 → 02/01	
A 170 CDI (168.008)	Diesel	66	01/01 → 02/01	
A 170 CDI (168.009, 168.109)	Diesel	70	02/01 → 08/04	

SUA510
J3
CILC **COMANDO INDICATORE LIVELLO CARBURANTE**
FUEL LEVEL SENDER

PEUGEOT
307 (3A/C)

1.6 HDi 110	Diesel	80	04/06 →	ENGINE: DW10ATED
2.0 HDi 110	Diesel	79	04/06 →	ENGINE: DW12TD
2.0 HDi 135	Diesel	100	04/06 →	ENGINE: DW12TD

307 CC (3B)

2.0 HDi 135	Diesel	100	07/06 →	ENGINE: DW12TD
-------------	--------	-----	---------	----------------

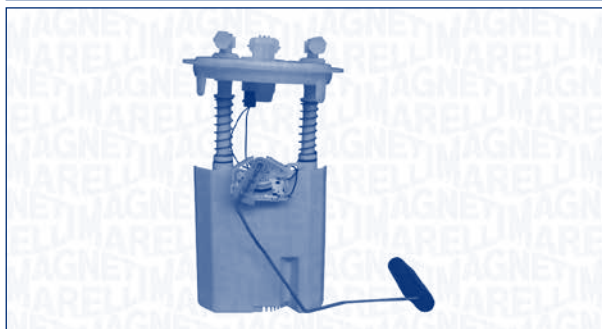
SUA511
J3
CILC **COMANDO INDICATORE LIVELLO CARBURANTE**
FUEL LEVEL SENDER

RENAULT
MODUS / GRAND MODUS (F/JP0_)

1.5 dCi (FP0F, JP0F)	Diesel	63	12/04 →	
1.5 dCi (FP0G, JP0G)	Diesel	50	12/04 →	
1.5 dCi (JP0G, JP0H)	Diesel	78	05/05 →	

SUA512
J3
CILC **COMANDO INDICATORE LIVELLO CARBURANTE**
FUEL LEVEL SENDER

CITROËN
JUMPER Autobus

2.2 HDi 100	Diesel	74	04/06 →	ENGINE: PUMA100
2.2 HDi 120	Diesel	88	04/06 →	ENGINE: PUMA120
3.0 HDi 160	Diesel	116	09/06 →	ENGINE: F30DT

JUMPER Furgonato

2.2 HDi 100	Diesel	74	04/06 →	ENGINE: PUMA100
2.2 HDi 120	Diesel	88	04/06 →	ENGINE: PUMA120
3.0 HDi 160	Diesel	116	09/06 →	ENGINE: F30DT

SUA512



CITROËN

JUMPER Pianale piatto/Telaio

2.2 HDi 100	Diesel	74	04/06 →	ENGINE: PUMA100
2.2 HDi 120	Diesel	88	04/06 →	ENGINE: PUMA120
3.0 HDi 160	Diesel	116	09/06 →	ENGINE: F30DT

JUMPY

1.6 HDi 90 16V	Diesel	66	01/07 →	ENGINE: DV6TED4
2.0 HDi 120	Diesel	88	01/07 →	ENGINE: DW10TEDA

JUMPY Furgonato

1.6 HDi 90 16V	Diesel	66	01/07 →	ENGINE: DV6TED4
2.0 HDi 120	Diesel	88	01/07 →	ENGINE: DW10TEDA

FIAT

SCUDO (270_)

1.6 D Multijet	Diesel	66	01/07 →	ENGINE: DV6TED4
2.0 D Multijet	Diesel	100	01/07 →	ENGINE: DW10TEDA

SCUDO Furgonato (270_)

1.6 D Multijet	Diesel	66	01/07 →	ENGINE: DV6TED4
2.0 D Multijet	Diesel	100	01/07 →	ENGINE: DW10TEDA

SCUDO Pianale piatto/Telaio (270_)

1.6 D Multijet	Diesel	66	01/07 →	ENGINE: DV6TED4
2.0 D Multijet	Diesel	100	01/07 →	ENGINE: DW10TEDA

PEUGEOT

BOXER Autobus

2.2 HDi 100	Diesel	74	04/06 →	ENGINE: PUMA100
2.2 HDi 120	Diesel	88	04/06 →	ENGINE: PUMA120
3.0 HDi 160	Diesel	116	04/06 →	ENGINE: F30DT

BOXER Furgonato

2.2 HDi 120	Diesel	88	04/06 →	ENGINE: PUMA120
3.0 HDi 160	Diesel	116	04/06 →	ENGINE: F30DT

BOXER Pianale piatto/Telaio

2.2 HDi 120	Diesel	88	04/06 →	ENGINE: PUMA120
3.0 HDi 160	Diesel	116	04/06 →	ENGINE: F30DT

EXPERT Furgonato (VF3A_, VF3U_, VF3X_)

1.6 HDi 90 16V	Diesel	66	01/07 →	ENGINE: DV6TED4
2.0 HDi 120	Diesel	88	01/07 →	ENGINE: DW10TEDA

EXPERT Pianale piatto/Telaio

1.6 HDi 90	Diesel	66	01/07 →	ENGINE: DV6TED4
2.0 HDi 120	Diesel	88	01/07 →	ENGINE: DW10TEDA

EXPERT Tepee (VF3V_)

1.6 HDi 90 16V	Diesel	66	01/07 →	ENGINE: DV6TED4
2.0 HDi 120	Diesel	88	01/07 →	ENGINE: DW10TEDA

SUA513

J3 CILC **COMANDO INDICATORE LIVELLO CARBURANTE FUEL LEVEL SENDER**

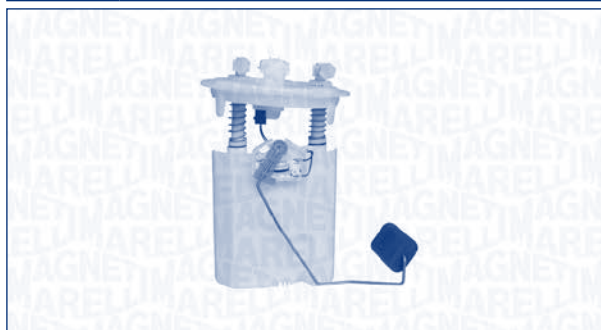

RENAULT

CLIO Grandtour (KR0/1_)

1.5 dCi (KR1C, KR1N)	Diesel	76	02/08 →	ENGINE: K9K772
----------------------	--------	----	---------	----------------

CLIO II (BB0/1/2_, CB0/1/2_)

1.5 dCi	Diesel	74	04/07 →	ENGINE: K9K712
1.5 dCi (B/C2J)	Diesel	50	04/07 →	ENGINE: K9K714
1.5 dCi (B/CB07)	Diesel	48	04/07 →	ENGINE: K9K700, K9K704
1.5 dCi (B/CB08)	Diesel	60	04/07 →	ENGINE: K9K702
1.5 dCi (B/CB3M)	Diesel	47	04/07 →	ENGINE: K9K740
1.5 dCi (B/CB3N)	Diesel	62	04/07 →	ENGINE: K9K718

CLIO II Furgonato (SB0/1/2_)

1.5 dCi	Diesel	60	04/07 →	ENGINE: K9K702, K9K710, K9K716
1.5 dCi (SB07)	Diesel	48	04/07 →	ENGINE: K9K700, K9K704

SUA514

J3 CILC **COMANDO INDICATORE LIVELLO CARBURANTE FUEL LEVEL SENDER**

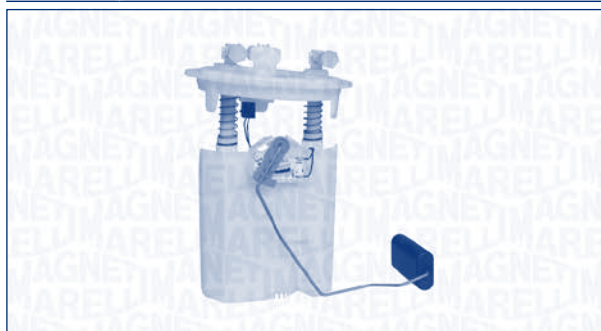

RENAULT

CLIO Grandtour (KR0/1_)

1.5 dCi (KR1C, KR1N)	Diesel	76	02/08 →	ENGINE: K9K772
----------------------	--------	----	---------	----------------

SUA514

RENAULT
CLIO II (BB0/1/2_, CB0/1/2_)

1.5 dCi	Diesel	74	04/07 →	ENGINE: K9K712
1.5 dCi (B/C2J)	Diesel	50	04/07 →	ENGINE: K9K714
1.5 dCi (B/CB07)	Diesel	48	04/07 →	ENGINE: K9K700,K9K704
1.5 dCi (B/CB08)	Diesel	60	04/07 →	ENGINE: K9K702
1.5 dCi (B/CB3M)	Diesel	47	04/07 →	ENGINE: K9K740
1.5 dCi (B/CB3N)	Diesel	62	04/07 →	ENGINE: K9K718

CLIO II Furgonato (SB0/1/2_)

1.5 dCi	Diesel	60	04/07 →	ENGINE: K9K702, K9K710, K9K716
1.5 dCi (SB07)	Diesel	48	04/07 →	ENGINE: K9K700,K9K704

SUA515

J3 CILC **COMANDO INDICATORE LIVELLO CARBURANTE
FUEL LEVEL SENDER**

MERCEDES-BENZ
CLASSE C (W203)

C 200 CGI Kompressor (203.043)	Petrol	125	09/06 → 02/07	
C 200 Kompressor (203.042)	Petrol	120	09/06 → 02/07	
C 230 Kompressor (203.040)	Petrol	141	09/06 → 02/07	
C 32 AMG Kompressor (203.065)	Petrol	260	09/06 → 02/07	

SUA516

J3 CILC **COMANDO INDICATORE LIVELLO CARBURANTE
FUEL LEVEL SENDER**

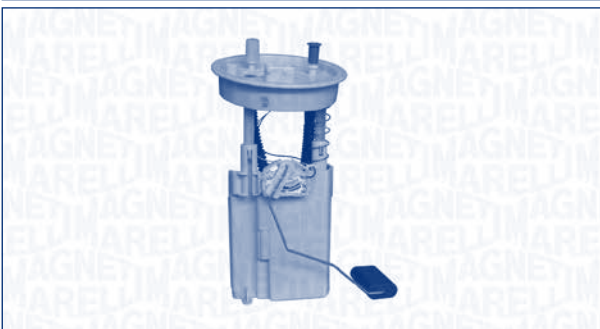
MINI
MINI (R50, R53)

One D	Diesel	55	04/07 → 09/06	
One D	Diesel	65	04/07 → 09/06	

MINI (R56)

Cooper D	Diesel	80	03/07 →	
----------	--------	----	---------	--

SUA517

J3 CILC **COMANDO INDICATORE LIVELLO CARBURANTE
FUEL LEVEL SENDER**

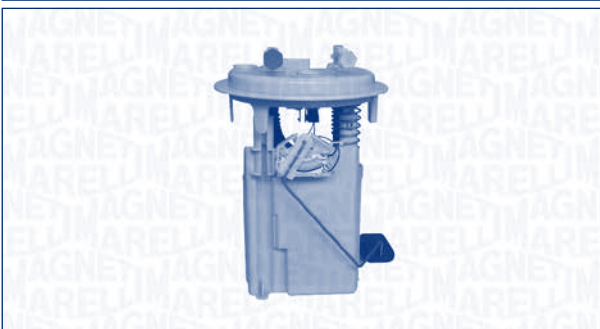
PEUGEOT
307 Break (3E)

1.6 HDi	Diesel	66	04/05 →	ENGINE: SIEMENSSYSTEM
2.0 HDi 110	Diesel	79	06/05 → 03/06	ENGINE: DW10ATED
2.0 HDi 135	Diesel	100	06/05 → 03/06	ENGINE: DW10ATED
2.0 HDi 90	Diesel	66	03/02 →	ENGINE: SIEMENSSYSTEM

307 SW (3H)

2.0 HDi 110	Diesel	79	06/05 → 03/06	ENGINE: DW10ATED
2.0 HDi 135	Diesel	100	06/05 → 03/06	ENGINE: DW10ATED
2.0 HDi 90	Diesel	66	03/02 →	ENGINE: SIEMENSSYSTEM

SUA518

J3 CILC COMANDO INDICATORE LIVELLO CARBURANTE
FUEL LEVEL SENDER

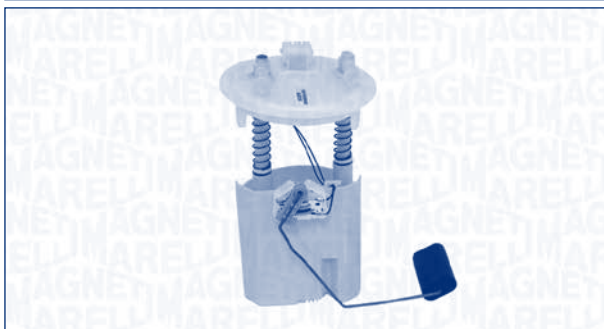

RENAULT

CLIO III (BR0/1, CR0/1)

1.5 dCi (BR0H, CR0H)	Diesel	78	06/05 →	ENGINE: DCI
1.5 dCi (BR17, CR17)	Diesel	63	06/05 →	ENGINE: DCI

SUA519

J3 CILC COMANDO INDICATORE LIVELLO CARBURANTE
FUEL LEVEL SENDER

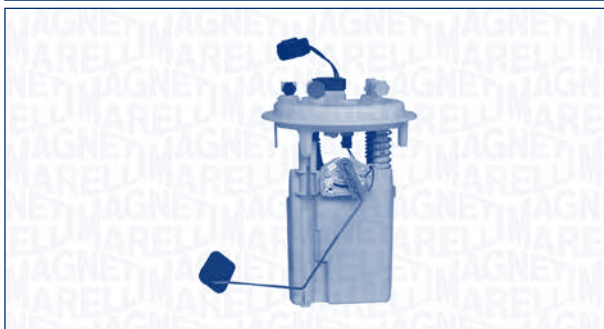

PEUGEOT

207 (WA_, WC_)

1.4 HDi	Diesel	50	02/06 →	ENGINE: DV4TD
1.6 HDi	Diesel	66	02/06 →	ENGINE: DV6ATED4
1.6 HDi	Diesel	80	02/06 →	ENGINE: DV6TED4

207 CC (WD_)

1.6 HDi	Diesel	80	02/07 →	ENGINE: DV6TED4
---------	--------	----	---------	-----------------

207 SW (WK_)

1.6 HDi	Diesel	66	06/07 →	ENGINE: DV6ATED4
1.6 HDi	Diesel	80	06/07 →	ENGINE: DV6TED4

SUA520

J3 CILC COMANDO INDICATORE LIVELLO CARBURANTE
FUEL LEVEL SENDER



PEUGEOT

207 (WA_, WC_)

1.4 HDi	Diesel	50	02/06 →	ENGINE: DV4TD
1.6 HDi	Diesel	66	02/06 →	ENGINE: DV6ATED4
1.6 HDi	Diesel	80	02/06 →	ENGINE: DV6TED4

207 CC (WD_)

1.6 HDi	Diesel	80	02/07 →	ENGINE: DV6TED4
---------	--------	----	---------	-----------------

207 SW (WK_)

1.6 HDi	Diesel	66	06/07 →	ENGINE: DV6ATED4
1.6 HDi	Diesel	80	06/07 →	ENGINE: DV6TED4

SUA552

J3 CILC COMANDO INDICATORE LIVELLO CARBURANTE
FUEL LEVEL SENDER

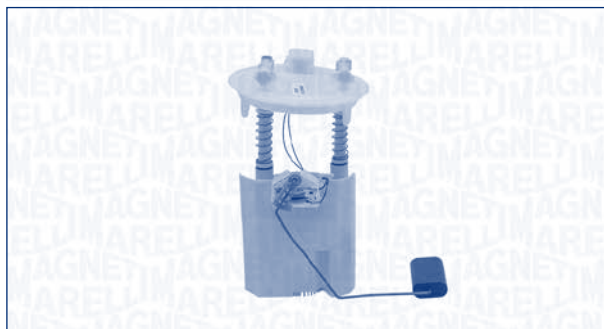

RENAULT

MODUS / GRAND MODUS (F/JP0_)

1.5 dCi (JP02)	Diesel	76	05/07 →	
----------------	--------	----	---------	--

SUA553
J3
CILC **COMANDO INDICATORE LIVELLO CARBURANTE**
FUEL LEVEL SENDER

FIAT
SCUDO (270_)

1.6 D Multijet	Diesel	66	01/07 →
----------------	--------	----	---------

SUA557
J3
CILC **COMANDO INDICATORE LIVELLO CARBURANTE**
FUEL LEVEL SENDER

PEUGEOT
508

1.6 HDi	Diesel	82	11/10 →
2.0 HDi	Diesel	103	11/10 →
2.2 HDi	Diesel	150	11/10 →

SUA554
J3
CILC **COMANDO INDICATORE LIVELLO CARBURANTE**
FUEL LEVEL SENDER

CITROËN
DS4

1.6 HDi 110	Diesel	81	04/11 →
1.6 HDi 110	Diesel	82	04/11 →

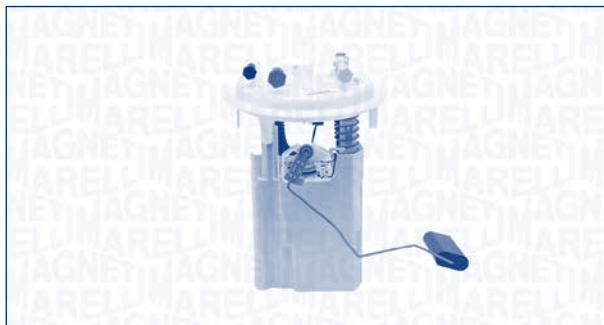
SUA558
J3
CILC **COMANDO INDICATORE LIVELLO CARBURANTE**
FUEL LEVEL SENDER

PEUGEOT
508

1.6 HDi	Diesel	82	11/10 →
2.0 HDi	Diesel	103	11/10 →
2.2 HDi	Diesel	150	11/10 →

SUA559

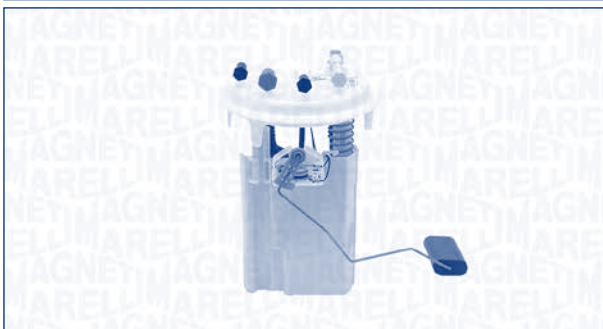
J3 CILC COMANDO INDICATORE LIVELLO CARBURANTE
FUEL LEVEL SENDER



PEUGEOT

508

1.6 HDi	Diesel	82	11/10 →
2.0 HDi	Diesel	103	11/10 →
2.2 HDi	Diesel	150	11/10 →

SUA560

J3 CILC COMANDO INDICATORE LIVELLO CARBURANTE
FUEL LEVEL SENDER



CITROËN

C1 (PM_, PN_)

1.4 HDi	Diesel	40	06/05 →
---------	--------	----	---------

PEUGEOT

107

1.4 HDi	Diesel	40	06/05 →
---------	--------	----	---------

SUA561

J3 CILC COMANDO INDICATORE LIVELLO CARBURANTE
FUEL LEVEL SENDER



DACIA

DUSTER

1.5 dCi	Diesel	79	06/10 →
---------	--------	----	---------

SUA562

J3 CILC COMANDO INDICATORE LIVELLO CARBURANTE
FUEL LEVEL SENDER



NISSAN

QASHQAI / QASHQAI +2 (J10, JJ10)

2.0 dCi Trazione integrale	Diesel	110	02/07 →
----------------------------	--------	-----	---------

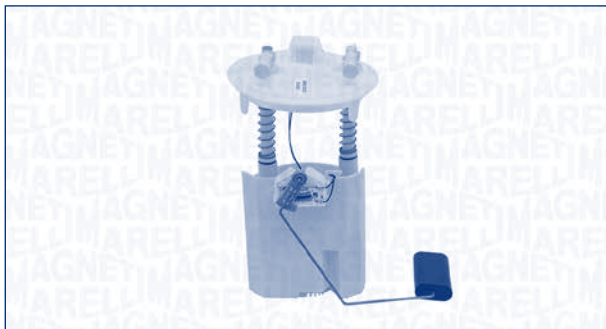
SUA563
J3
CILC COMANDO INDICATORE LIVELLO CARBURANTE
FUEL LEVEL SENDER

KW

RENAULT
TWINGO II (CN0_)

1.5 dCi (CN0E)	Diesel	47	03/07 →
----------------	--------	----	---------

SUA565
J3
CILC COMANDO INDICATORE LIVELLO CARBURANTE
FUEL LEVEL SENDER

KW

PEUGEOT
208

1.4 HDi	Diesel	50	03/12 →
1.6 HDi	Diesel	68	03/12 →
1.6 HDi	Diesel	84	03/12 →

SUA564
J3
CILC COMANDO INDICATORE LIVELLO CARBURANTE
FUEL LEVEL SENDER

KW

PEUGEOT
208

1.4 HDi	Diesel	50	03/12 →
1.6 HDi	Diesel	68	03/12 →
1.6 HDi	Diesel	84	03/12 →

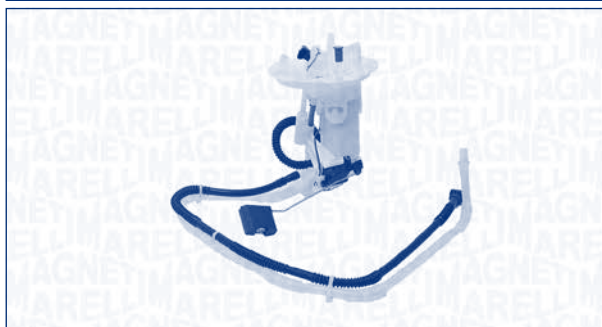
SUA566
J3
CILC COMANDO INDICATORE LIVELLO CARBURANTE
FUEL LEVEL SENDER

KW

MERCEDES-BENZ
CLASSE C (W204)

C 200 CGI (204.048)	Petrol	135	01/07 →
C 250 CGI (204.047)	Petrol	150	07/09 →

CLASSE C T-Model (S204)

C 250 CGI (204.247)	Petrol	150	07/09 →
---------------------	--------	-----	---------

CLASSE E (W212)

E 200 CGI (212.048, 212.148)	Petrol	135	08/09 →
E 250 CGI (212.047, 212.147)	Petrol	150	01/09 →

SUA566



MERCEDES-BENZ

CLASSE E Cabriolet (A207)

E 200 CGI (207.448) Petrol 135 01/10 →

E 250 CGI (207.447) Petrol 150 01/10 →

CLASSE E Coupé (C207)

E 200 CGI (207.348) Petrol 135 01/10 →

E 250 CGI (207.347) Petrol 150 01/09 →

CLASSE E T-Model (S212)

E 200 CGI (212.248) Petrol 135 11/09 →

E 250 CGI (212.247) Petrol 150 11/09 →

SUA567

J3 CILC COMANDO INDICATORE LIVELLO CARBURANTE
FUEL LEVEL SENDER

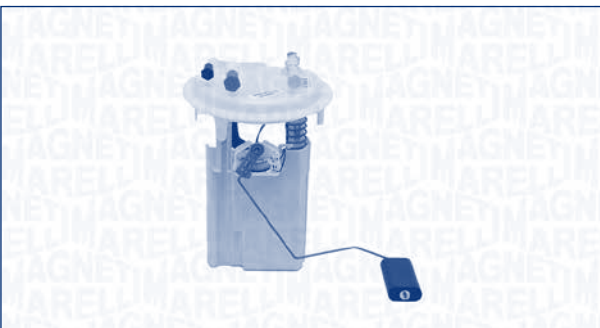

CITROËN

C4 II (B7)

1.6 HDi 110 Diesel 82 11/09 →

1.6 HDi 90 Diesel 68 11/09 →

2.0 HDi 150 Diesel 110 11/09 →

SUA568

J3 CILC COMANDO INDICATORE LIVELLO CARBURANTE
FUEL LEVEL SENDER



NISSAN

QASHQAI / QASHQAI +2 (J10, JJ10)

1.6 Petrol 84 02/07 →

SUA569

J3 CILC COMANDO INDICATORE LIVELLO CARBURANTE
FUEL LEVEL SENDER



MERCEDES-BENZ

CLASSE E (W212)

E 200 CDI / BlueTEC (212.005, 212.006) Diesel 100 01/09 →

E 220 CDI / BlueTEC (212.001, 212.002) Diesel 125 01/09 →

E 250 CDI / BlueTEC (212.003, 212.004) Diesel 150 01/09 →

E 350 BlueTEC (212.024) Diesel 155 01/09 →

E 350 CDI (212.025) Diesel 170 01/09 →

E 350 CDI 4-matic (212.089) Diesel 170 09/09 →

SUA569

MERCEDES-BENZ
CLASSE E T-Model (S212)

E 200 CDI / BlueTEC (212.205, 212.206)	Diesel	100	11/09 →	
E 220 CDI / BlueTEC (212.202, 212.201)	Diesel	125	11/09 →	
E 250 CDI / BlueTEC (212.203, 212.204)	Diesel	150	11/09 →	
E 350 BlueTEC (212.224)	Diesel	155	11/09 →	
E 350 CDI (212.225)	Diesel	170	11/09 →	
E 350 CDI 4-matic (212.289)	Diesel	170	11/09 →	

SUA570
**J3
CILC**
**COMANDO INDICATORE LIVELLO CARBURANTE
FUEL LEVEL SENDER**

MERCEDES-BENZ
CLASSE E (W212)

E 200 CDI / BlueTEC (212.005, 212.006)	Diesel	100	01/09 →	
E 220 CDI / BlueTEC (212.001, 212.002)	Diesel	125	01/09 →	
E 250 CDI / BlueTEC (212.003, 212.004)	Diesel	150	01/09 →	
E 350 BlueTEC (212.024)	Diesel	155	01/09 →	

SUA570

MERCEDES-BENZ
CLASSE E (W212)

E 350 CDI (212.025)	Diesel	170	01/09 →	
E 350 CDI 4-matic (212.089)	Diesel	170	09/09 →	
CLASSE E T-Model (S212)				
E 200 CDI / BlueTEC (212.205, 212.206)	Diesel	100	11/09 →	
E 220 CDI / BlueTEC (212.202, 212.201)	Diesel	125	11/09 →	
E 250 CDI / BlueTEC (212.203, 212.204)	Diesel	150	11/09 →	
E 350 BlueTEC (212.224)	Diesel	155	11/09 →	
E 350 CDI (212.225)	Diesel	170	11/09 →	
E 350 CDI 4-matic (212.289)	Diesel	170	11/09 →	

SUA571
**J3
CILC**
**COMANDO INDICATORE LIVELLO CARBURANTE
FUEL LEVEL SENDER**

CITROËN
C4 Picasso I (UD_)

1.6 HDi	Diesel	80	02/07 →	
---------	--------	----	---------	--

SUA572

J3 COMANDO INDICATORE LIVELLO CARBURANTE
CILC FUEL LEVEL SENDER



KW



MERCEDES-BENZ

CLASSE C (W203)

C 180 (203.035)	Petrol	95	10/00 → 05/02
C 200 Kompressor (203.045)	Petrol	120	05/00 → 06/02
C 240 (203.061)	Petrol	125	05/00 → 02/07
C 320 (203.064)	Petrol	160	05/00 → 02/07

CLASSE C Sportcoupe (CL203)

C 180 (203.735)	Petrol	95	03/01 → 05/02
C 200 Kompressor (203.745)	Petrol	120	03/01 → 05/02
C 230 Kompressor (203.747)	Petrol	145	03/01 → 05/02
C 320 (203.764)	Petrol	160	09/02 → 05/08

CLASSE C T-Model (S203)

C 180 (203.235)	Petrol	95	03/01 → 05/02
C 200 Kompressor (203.245)	Petrol	120	03/01 → 05/02
C 240 (203.261)	Petrol	125	03/01 → 08/07
C 320 (203.264, 203.764)	Petrol	160	03/01 → 08/07

VANEO (414)

1.7 CDI (414.700)	Diesel	55	02/02 → 07/05
-------------------	--------	----	---------------

SUA573

J3 COMANDO INDICATORE LIVELLO CARBURANTE
CILC FUEL LEVEL SENDER



KW



OPEL

MERIVA

1.7 CDTI	Diesel	74	09/03 → 05/10
1.7 DTI	Diesel	55	09/03 → 05/10

SUA574

J3 COMANDO INDICATORE LIVELLO CARBURANTE
CILC FUEL LEVEL SENDER



KW



MERCEDES-BENZ

CLASSE C (W203)

C 200 CDI	Diesel	75	02/01 → 02/07
C 220 CDI (203.006)	Diesel	100	05/00 → 02/07

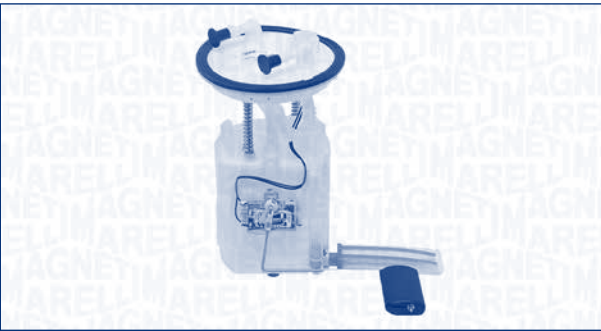
SUA575
J3
CILC **COMANDO INDICATORE LIVELLO CARBURANTE**
FUEL LEVEL SENDER

HYUNDAI
i30 (FD)

1.6 CRDi	Diesel	85	10/07 → 11/11
1.6 CRDi	Diesel	66	10/07 → 11/11

i30 CW (FD)

1.6 CRDi	Diesel	66	02/08 → 06/12
1.6 CRDi	Diesel	85	02/08 → 06/12

KIA
CEE'D 2 volumi /Coda spiovente (ED)

1.6 CRDi 115	Diesel	85	12/06 →
1.6 CRDi 128	Diesel	94	10/10 →
1.6 CRDi 90	Diesel	66	12/06 →

CEE'D SW (ED)

1.6 CRDi 115	Diesel	85	09/07 →
1.6 CRDi 128	Diesel	94	10/10 →
1.6 CRDi 90	Diesel	66	09/07 →

CERATO (LD)

1.6 CRDi	Diesel	85	06/05 →
----------	--------	----	---------

SUA576
J3
CILC **COMANDO INDICATORE LIVELLO CARBURANTE**
FUEL LEVEL SENDER

VOLKSWAGEN
TIGUAN (5N_)

2.0 TDI 4motion	Diesel	103	09/07 →
2.0 TDI 4motion	Diesel	125	09/07 →

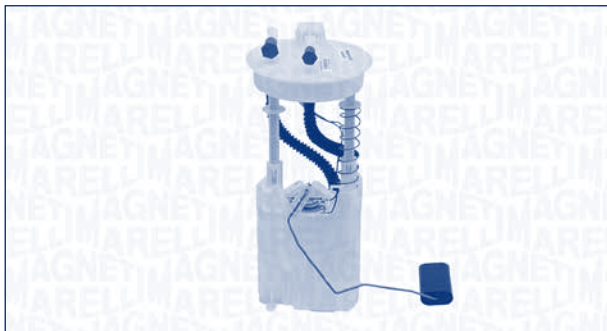
SUA577
J3
CILC **COMANDO INDICATORE LIVELLO CARBURANTE**
FUEL LEVEL SENDER

NISSAN
QASHQAI / QASHQAI +2 (J10, JJ10)

1.5 dCi	Diesel	78	02/07 →
2.0 dCi	Diesel	110	02/07 →

SUA578

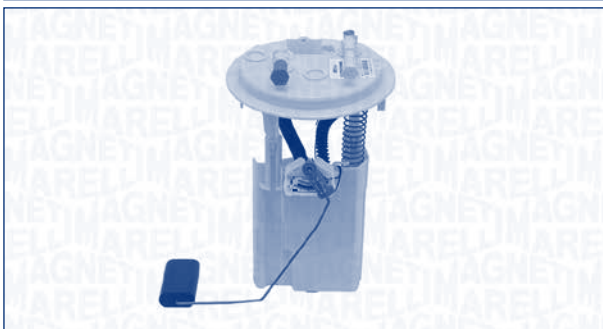
J3 CILC COMANDO INDICATORE LIVELLO CARBURANTE
FUEL LEVEL SENDER



CITROËN

C3 II

1.4 HDi 70	Diesel	50	11/09 →
1.6 HDi	Diesel	68	11/09 →
1.6 HDi 110	Diesel	82	11/09 →

DS3

1.6 HDi 110	Diesel	82	11/09 →
1.6 HDi 90	Diesel	68	11/09 →

SUA579

J3 CILC COMANDO INDICATORE LIVELLO CARBURANTE
FUEL LEVEL SENDER

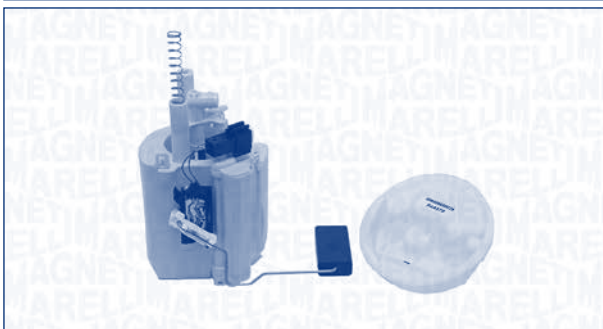

MERCEDES-BENZ

CLASSE C Sportcoupe (CL203)

C 220 CDI (203.706)	Diesel	105	03/01 → 05/08
---------------------	--------	-----	---------------

CLASSE C T-Model (S203)

C 200 CDI (203.204)	Diesel	85	03/01 → 08/07
C 220 CDI (203.206)	Diesel	105	03/01 → 08/07
C 270 CDI (203.216)	Diesel	125	03/01 → 08/07

SUA581

J3 CILC COMANDO INDICATORE LIVELLO CARBURANTE
FUEL LEVEL SENDER

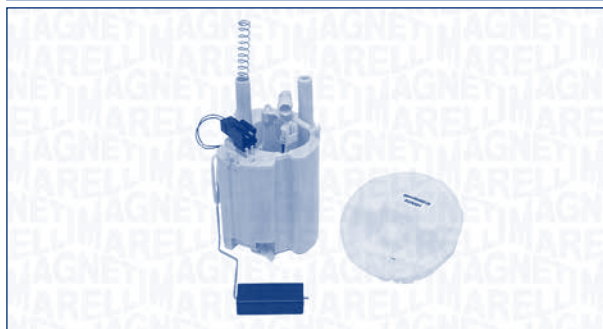

MERCEDES-BENZ

CLASSE C (W203)

C 200 CDI (203.004)	Diesel	85	09/00 → 02/07
C 220 CDI (203.006)	Diesel	105	05/00 → 02/07
C 270 CDI (203.016)	Diesel	125	12/00 → 02/07

CLK (C209)

270 CDI (209.316)	Diesel	125	10/02 → 05/09
-------------------	--------	-----	---------------

SUA582

J3 CILC COMANDO INDICATORE LIVELLO CARBURANTE
FUEL LEVEL SENDER

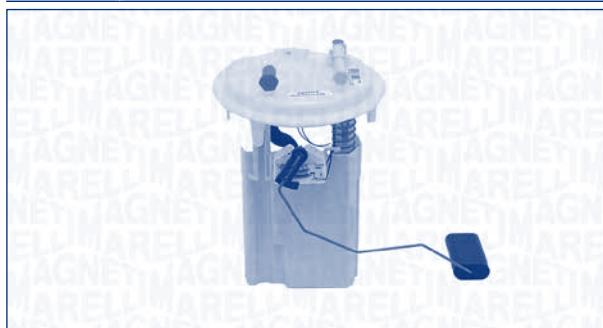

CITROËN

JUMPY

1.6 HDi 90 16V	Diesel	66	01/07 →
----------------	--------	----	---------

PEUGEOT

407 (6D_)

2.0 HDi	Diesel	103	08/08 →
---------	--------	-----	---------

407 Coupé (6C_)

2.0 HDi	Diesel	100	10/05 →
---------	--------	-----	---------

407 SW (6E_)

2.0 HDi	Diesel	103	08/08 →
---------	--------	-----	---------

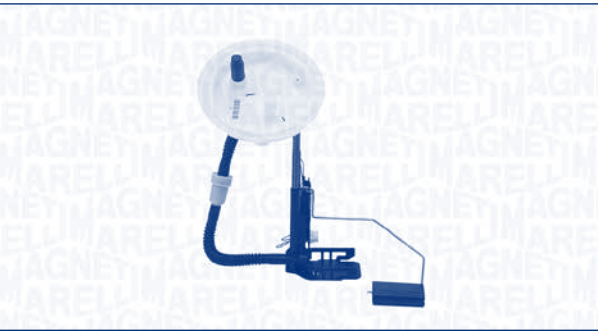
SUA583
**J3
CILC** **COMANDO INDICATORE LIVELLO CARBURANTE
FUEL LEVEL SENDER**

BMW
5 (E60)

520 d	Diesel	110	09/05 → 03/10
520 d	Diesel	120	07/05 → 03/10
525 d	Diesel	130	06/04 → 03/10
525 d	Diesel	120	12/04 → 03/10
525 d	Diesel	145	01/07 → 03/10
525 d xDrive	Diesel	145	09/08 → 03/10
525 i xDrive	Petrol	160	09/08 → 03/10
530 d	Diesel	160	07/03 → 03/10
530 d	Diesel	173	01/07 → 03/10
530 d xDrive	Diesel	173	09/08 → 03/10
530 xd	Diesel	170	07/05 → 03/10
530 xd	Diesel	173	01/07 → 03/10
535 d	Diesel	200	09/04 → 03/10
535 d	Diesel	210	01/07 → 03/10

5 Touring (E61)

520 d	Diesel	110	09/05 →
520 d	Diesel	120	07/05 →
525 d	Diesel	130	06/04 →
525 d	Diesel	145	01/07 →
525 d xDrive	Diesel	145	09/08 →
530 d	Diesel	160	06/04 →
530 d	Diesel	170	07/05 →
530 d	Diesel	173	01/07 →
530 d xDrive	Diesel	173	09/08 →
530 xd	Diesel	170	07/05 →
530 xd	Diesel	173	01/07 →
535 d	Diesel	200	09/04 →
535 d	Diesel	210	01/07 →

6 (E63)

635 d	Diesel	210	07/07 →
-------	--------	-----	---------

6 Cabriolet (E64)

635 d	Diesel	210	07/07 →
-------	--------	-----	---------

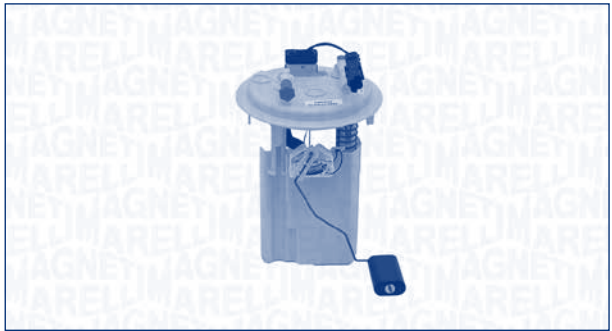
SUA584
**J3
CILC** **COMANDO INDICATORE LIVELLO CARBURANTE
FUEL LEVEL SENDER**

CITROËN
BERLINGO (B9)

1.6 HDi 110	Diesel	80	04/08 →
1.6 HDi 75	Diesel	55	04/08 →
1.6 HDi 90	Diesel	66	04/08 →

C4 Grand Picasso I (UA_)

1.6 HDi	Diesel	80	10/06 →
2.0 HDi 138	Diesel	100	10/06 →

PEUGEOT
RANCH

1.6 HDi	Diesel	55	04/08 →
---------	--------	----	---------

SUA585
**J3
CILC** **COMANDO INDICATORE LIVELLO CARBURANTE
FUEL LEVEL SENDER**

RENAULT
FLUENCE (L30_)

1.5 dCi (L30A)	Diesel	63	02/10 →
1.5 dCi (L30B)	Diesel	78	02/10 →
1.5 dCi (L30D, L30L)	Diesel	81	02/10 →
1.5 dCi (L30S)	Diesel	66	02/10 →

SUA585



RENAULT

MEGANE III 2 volumi /Coda spiovente (BZ0_)

1.5 dCi	Diesel	63	12/09 →	
1.5 dCi	Diesel	78	02/09 →	
1.5 dCi (BZ09, BZ0D)	Diesel	81	02/09 →	
1.5 dCi (BZ0C)	Diesel	66	11/08 →	
1.9 dCi (BZ0N, BZ0J)	Diesel	96	11/08 →	
2.0 dCi (BZ0L)	Diesel	118	04/09 →	
2.0 dCi (BZ0Y)	Diesel	110	10/10 →	

MEGANE III Coupé (DZ0/1_)

1.5 dCi (DZ09, DZ0D, DZ1F, DZ1G)	Diesel	81	02/09 →	
1.5 dCi (DZ0A)	Diesel	63	11/08 →	
1.5 dCi (DZ0B)	Diesel	78	02/09 →	
1.5 dCi (DZ0C, DZ1A)	Diesel	66	11/08 →	
1.9 dCi (DZ0N, DZ0J, DZ1J, DZ1K)	Diesel	96	11/08 →	
2.0 dCi (DZ0L)	Diesel	118	04/09 →	
2.0 dCi (DZ0Y)	Diesel	110	04/09 →	

MEGANE III Grandtour (KZ0/1)

1.5 dCi (KZ09, KZ0D, KZ1G, KZ1M, KZ1W)	Diesel	81	02/09 →	
1.5 dCi (KZ0C, KZ1A)	Diesel	66	05/09 →	
1.5 dCi (KZ1M, KZ1W)	Diesel	78	02/09 →	
1.9 dCi (KZ0J, KZ0N, KZ1S)	Diesel	96	05/09 →	
2.0 dCi (KZ0L)	Diesel	118	04/09 →	
2.0 dCi (KZ0Y)	Diesel	110	10/10 →	

SUA586

J3 CILC **COMANDO INDICATORE LIVELLO CARBURANTE FUEL LEVEL SENDER**



RENAULT

KANGOO (KC0/1_)

1.5 dCi	Diesel	42	07/03 →	
1.5 dCi	Diesel	50	06/05 →	
1.5 dCi	Diesel	62	06/05 →	
1.5 dCi (KC07)	Diesel	48	12/01 →	
1.5 dCi (KC08, KC09)	Diesel	60	07/02 →	

KANGOO Express (FC0/1_)

1.5 dCi	Diesel	45	10/05 →	
1.5 dCi (FC07, FC1R)	Diesel	48	12/01 →	
1.5 dCi (FC08, FC09)	Diesel	60	04/03 →	
1.5 dCi (FC1E)	Diesel	50	06/05 →	
1.5 dCi (FC1G)	Diesel	62	06/05 →	

SUA587

J3 CILC **COMANDO INDICATORE LIVELLO CARBURANTE FUEL LEVEL SENDER**



CITROËN

JUMPY

2.0 HDi 120	Diesel	88	01/07 →	
-------------	--------	----	---------	--

SUA587

FIAT
DUCATO Autobus (250)

100 Multijet 2,2 D Diesel 74 07/06 →

120 Multijet 2,3 D Diesel 88 07/06 →

160 Multijet 3,0 D Diesel 116 07/06 →

DUCATO Furgonato (250)

100 Multijet 2,2 D Diesel 74 07/06 →

120 Multijet 2,3 D Diesel 88 07/06 →

160 Multijet 3,0 D Diesel 116 07/06 →

DUCATO Pianale piatto/Telaio (250)

100 Multijet 2,2 D Diesel 74 07/06 →

120 Multijet 2,3 D Diesel 88 07/06 →

160 Multijet 3,0 D Diesel 116 07/06 →

SCUDO (270_)

2.0 D Multijet Diesel 100 01/07 →

2.0 D Multijet Diesel 88 01/07 →

SCUDO Furgonato (270_)

2.0 D Multijet Diesel 100 01/07 →

2.0 D Multijet Diesel 88 01/07 →

SCUDO Pianale piatto/Telaio (270_)

2.0 D Multijet Diesel 100 01/07 →

PEUGEOT
BOXER Autobus

2.2 HDi 100 Diesel 74 04/06 →

2.2 HDi 120 Diesel 88 04/06 →

3.0 HDi 160 Diesel 116 04/06 →

BOXER Furgonato

2.2 HDi 100 Diesel 74 04/06 →

2.2 HDi 120 Diesel 88 04/06 →

3.0 HDi 160 Diesel 116 04/06 →

BOXER Pianale piatto/Telaio

2.2 HDi 100 Diesel 74 04/06 →

2.2 HDi 120 Diesel 88 04/06 →

3.0 HDi 160 Diesel 116 04/06 →

EXPERT Furgonato (VF3A_, VF3U_, VF3X_)

2.0 HDi 120 Diesel 88 01/07 →

EXPERT Pianale piatto/Telaio

2.0 HDi 120 Diesel 88 01/07 →

EXPERT Tepee (VF3V_)

2.0 HDi 120 Diesel 88 01/07 →

SUA588
**J3
CILC** **COMANDO INDICATORE LIVELLO CARBURANTE
FUEL LEVEL SENDER**

CITROËN
JUMPY

2.0 HDi 120 Diesel 88 01/07 →

FIAT
DUCATO Autobus (250)

100 Multijet 2,2 D Diesel 74 07/06 →

120 Multijet 2,3 D Diesel 88 07/06 →

160 Multijet 3,0 D Diesel 116 07/06 →

DUCATO Furgonato (250)

100 Multijet 2,2 D Diesel 74 07/06 →

120 Multijet 2,3 D Diesel 88 07/06 →

160 Multijet 3,0 D Diesel 116 07/06 →

DUCATO Pianale piatto/Telaio (250)

100 Multijet 2,2 D Diesel 74 07/06 →

120 Multijet 2,3 D Diesel 88 07/06 →

160 Multijet 3,0 D Diesel 116 07/06 →

SCUDO (270_)

2.0 D Multijet Diesel 100 01/07 →

2.0 D Multijet Diesel 88 01/07 →

SCUDO Furgonato (270_)

2.0 D Multijet Diesel 100 01/07 →

2.0 D Multijet Diesel 88 01/07 →

SCUDO Pianale piatto/Telaio (270_)

2.0 D Multijet Diesel 100 01/07 →

PEUGEOT
BOXER Autobus

2.2 HDi 100 Diesel 74 04/06 →

2.2 HDi 120 Diesel 88 04/06 →

3.0 HDi 160 Diesel 116 04/06 →

BOXER Furgonato

2.2 HDi 100 Diesel 74 04/06 →

2.2 HDi 120 Diesel 88 04/06 →

3.0 HDi 160 Diesel 116 04/06 →

SUA588



PEUGEOT

BOXER Pianale piatto/Telaio

2.2 HDi 100	Diesel	74	04/06 →
2.2 HDi 120	Diesel	88	04/06 →
3.0 HDi 160	Diesel	116	04/06 →

EXPERT Furgonato (VF3A_, VF3U_, VF3X_)

2.0 HDi 120	Diesel	88	01/07 →
-------------	--------	----	---------

EXPERT Pianale piatto/Telaio

2.0 HDi 120	Diesel	88	01/07 →
-------------	--------	----	---------

EXPERT Tepee (VF3V_)

2.0 HDi 120	Diesel	88	01/07 →
-------------	--------	----	---------

SUA589

**J3
CILC** COMANDO INDICATORE LIVELLO CARBURANTE
FUEL LEVEL SENDER

CITROËN

JUMPY

2.0 HDi 120	Diesel	88	01/07 →
-------------	--------	----	---------

FIAT

DUCATO Autobus (250)

100 Multijet 2,2 D	Diesel	74	07/06 →
120 Multijet 2,3 D	Diesel	88	07/06 →
160 Multijet 3,0 D	Diesel	116	07/06 →

DUCATO Furgonato (250)

100 Multijet 2,2 D	Diesel	74	07/06 →
120 Multijet 2,3 D	Diesel	88	07/06 →
160 Multijet 3,0 D	Diesel	116	07/06 →

DUCATO Pianale piatto/Telaio (250)

100 Multijet 2,2 D	Diesel	74	07/06 →
120 Multijet 2,3 D	Diesel	88	07/06 →
160 Multijet 3,0 D	Diesel	116	07/06 →

SCUDO (270_)

2.0 D Multijet	Diesel	100	01/07 →
2.0 D Multijet	Diesel	88	01/07 →

SUA589



FIAT

SCUDO Furgonato (270_)

2.0 D Multijet	Diesel	100	01/07 →
2.0 D Multijet	Diesel	88	01/07 →

SCUDO Pianale piatto/Telaio (270_)

2.0 D Multijet	Diesel	100	01/07 →
----------------	--------	-----	---------

PEUGEOT

BOXER Autobus

2.2 HDi 100	Diesel	74	04/06 →
2.2 HDi 120	Diesel	88	04/06 →
3.0 HDi 160	Diesel	116	04/06 →

BOXER Furgonato

2.2 HDi 100	Diesel	74	04/06 →
2.2 HDi 120	Diesel	88	04/06 →
3.0 HDi 160	Diesel	116	04/06 →

BOXER Pianale piatto/Telaio

2.2 HDi 100	Diesel	74	04/06 →
2.2 HDi 120	Diesel	88	04/06 →

BOXER Pianale piatto/Telaio

3.0 HDi 160	Diesel	116	04/06 →
-------------	--------	-----	---------

EXPERT Furgonato (VF3A_, VF3U_, VF3X_)

2.0 HDi 120	Diesel	88	01/07 →
-------------	--------	----	---------

EXPERT Pianale piatto/Telaio

2.0 HDi 120	Diesel	88	01/07 →
-------------	--------	----	---------

EXPERT Tepee (VF3V_)

2.0 HDi 120	Diesel	88	01/07 →
-------------	--------	----	---------

SUA590

**J3
CILC** COMANDO INDICATORE LIVELLO CARBURANTE
FUEL LEVEL SENDER

MERCEDES-BENZ

CLASSE C (W203)

C 180 Kompressor (203.046)	Petrol	105	05/02 → 02/07
----------------------------	--------	-----	---------------

SUA590

MERCEDES-BENZ
CLASSE C (W203)

C 200 CGI Kompressor (203.043)	Petrol	125	07/03 → 02/07
C 200 Kompressor (203.042)	Petrol	120	05/02 → 02/07
C 230 (203.052)	Petrol	150	01/05 → 02/07
C 230 Kompressor (203.040)	Petrol	141	02/04 → 02/07
C 240 4-matic (203.081)	Petrol	125	07/02 → 02/07
C 280 (203.054)	Petrol	170	01/05 → 02/07
C 280 4-matic (203.092)	Petrol	170	01/05 → 02/07
C 32 AMG Kompressor (203.065)	Petrol	260	02/01 → 02/07
C 320 4-matic (203.084)	Petrol	160	07/02 → 02/07
C 350 (203.056)	Petrol	200	01/05 → 02/07
C 350 4-matic (203.087)	Petrol	200	01/05 → 02/07

CLASSE C Sportcoupe (CL203)

C 180 Kompressor (203.746)	Petrol	105	05/02 → 05/08
C 200 CGI Kompressor (203.743)	Petrol	125	03/03 → 05/08
C 200 Kompressor (203.742)	Petrol	120	05/02 → 05/08
C 230 (203.752)	Petrol	150	01/05 → 05/08
C 230 Kompressor (203.740)	Petrol	141	05/02 → 05/08
C 350 (203.756)	Petrol	200	01/05 → 05/08

CLASSE C T-Model (S203)

C 180 Kompressor (203.246)	Petrol	105	05/02 → 08/07
C 200 CGI Kompressor (203.243)	Petrol	125	07/03 → 08/07
C 200 Kompressor (203.242)	Petrol	120	05/02 → 08/07
C 230 (203.252)	Petrol	150	01/05 → 08/07
C 230 Kompressor (203.240)	Petrol	141	02/04 → 08/07

SUA590

MERCEDES-BENZ
CLASSE C T-Model (S203)

C 240 4-matic (203.281)	Petrol	125	07/02 → 08/07
C 280 (203.254)	Petrol	170	01/05 → 08/07
C 280 4-matic (203.292)	Petrol	170	01/05 → 08/07
C 32 AMG Kompressor (203.265)	Petrol	260	03/01 → 08/07
C 320 4-matic (203.284)	Petrol	160	07/02 → 08/07
C 350 (203.256)	Petrol	200	01/05 → 08/07
C 350 4-matic (203.287)	Petrol	200	01/05 → 08/07

CLK (C209)

200 CGI (209.343)	Petrol	125	07/03 → 05/09
200 Kompressor (209.342)	Petrol	120	09/02 → 05/09
240 (209.361)	Petrol	125	06/02 → 05/09
280 (209.354)	Petrol	170	01/05 → 05/09
320 (209.365)	Petrol	160	06/02 → 05/09
500 (209.375)	Petrol	225	06/02 → 05/09
55 AMG (209.376)	Petrol	270	09/02 → 05/09

CLK Cabriolet (A209)

CLK 200 CGI (209.443)	Petrol	125	07/03 → 03/10
CLK 200 Kompressor (209.442)	Petrol	120	02/03 → 03/10
CLK 240 (209.461)	Petrol	125	02/03 → 03/10
CLK 280 (209.454)	Petrol	170	01/05 → 03/10
CLK 320 (209.465)	Petrol	160	02/03 → 03/10
CLK 500 (209.475)	Petrol	225	02/03 → 03/10
CLK 55 AMG (209.476)	Petrol	270	02/03 → 03/10

SUA591

J3 COMANDO INDICATORE LIVELLO CARBURANTE
CILC FUEL LEVEL SENDER



CITROËN

C3 I (FC_)

1.4 16V HDi	Diesel	66	02/02 →	
1.4 HDi	Diesel	50	02/02 →	
1.6 16V	Petrol	80	02/02 →	
1.6 16V HDi	Diesel	80	09/05 →	

C3 Pluriel (HB_)

1.4 HDi	Diesel	50	04/04 →	
---------	--------	----	---------	--

SUA592

J3 COMANDO INDICATORE LIVELLO CARBURANTE
CILC FUEL LEVEL SENDER



VOLKSWAGEN

TIGUAN (5N_)

2.0 TDi	Diesel	103	03/08 →	ENGINE: CBAB,CFFB
2.0 TDi	Diesel	81	05/10 →	ENGINE: CFFD
2.0 TDi 4motion	Diesel	100	11/07 →	ENGINE: CBAA,CFFA
2.0 TDi 4motion	Diesel	103	09/07 →	ENGINE: CBAB,CFFB,CLJA
2.0 TDi 4motion	Diesel	120	02/08 → 08/09	ENGINE: CBBA
2.0 TDi 4motion	Diesel	125	09/07 →	ENGINE: CBBB,CFGB

GA2000

J2 GRUPPO ASPIRAZIONE CARBURANTE
GA(F/R) FUEL SUPPLY UNIT



CITROËN

C5 II (RC_)

2.0 16V (RCRFJB, RCRFJC)	Petrol	103	09/04 →	
3.0 V6 (RCXFUF)	Petrol	152	09/04 →	ENGINE: ES9J4S

C5 II Break (RE_)

2.0 16V (RERFJB, RERFJC)	Petrol	103	09/04 →	
3.0 V6 (REXFUF)	Petrol	152	09/04 →	ENGINE: ES9J4S

PEUGEOT

307 (3A/C)

1.4	Petrol	55	08/00 →	
1.6 16V	Petrol	80	08/00 →	
2.0 16V	Petrol	100	08/00 →	

307 Break (3E)

1.6 16V	Petrol	80	03/02 →	
2.0	Petrol	100	03/02 →	

307 CC (3B)

2.0 16V	Petrol	100	10/03 →	
---------	--------	-----	---------	--

307 SW (3H)

1.6 16V	Petrol	80	03/02 →	
2.0 16V	Petrol	100	03/02 →	

GA2002
J2
GA(R) GRUPPO ASPIRAZIONE CARBURANTE
FUEL SUPPLY UNIT

CITROËN
BERLINGO (MF)

1.6 16V (MFNFU) Petrol 80 01/01 → ENGINE: TU5JP4

XSARA PICASSO (N68)

1.6 Petrol 65 05/00 → ENGINE: TU5JP

1.6 Petrol 70 08/00 → ENGINE: TU5JP

PEUGEOT
206 2 volumi /Coda spiovente (2A/C)

1.1 i Petrol 44 09/98 → ENGINE: TU1JP

1.4 i Petrol 55 09/98 → ENGINE: TU3JP

1.6 i Petrol 65 09/98 → 12/00 ENGINE: TU5JP

2.0 S16 Petrol 99 04/99 → 10/00 ENGINE: EW10J4

206 CC (2D)

1.6 16V Petrol 80 09/00 → ENGINE: TU5JP

2.0 S16 Petrol 100 09/00 → ENGINE: EW10J4

607 (9D, 9U)

2.2 16V Petrol 116 02/00 → ENGINE: EW12J4

3.0 V6 24V Petrol 152 02/00 → ENGINE: ES8J4S

RANCH MPV / Space wagon (5F)

1.4 Petrol 55 06/96 →

1.6 16V Petrol 80 07/01 → ENGINE: TU5JP4

GA2003
J2
GA(F/R) GRUPPO ASPIRAZIONE CARBURANTE
FUEL SUPPLY UNIT

PEUGEOT
406 (8B)

1.8 16V Petrol 85 10/00 → 05/04 ENGINE: EW7J4

2.0 16V Petrol 100 01/01 → 06/04

2.0 16V Petrol 97 01/01 → 05/04

2.2 Petrol 116 01/01 → 05/04 ENGINE: EW12J4

3.0 V6 Petrol 152 01/01 → 05/04

406 Break (8E/F)

1.8 16V Petrol 85 10/00 → 10/04 ENGINE: EW7J4

2.0 16V Petrol 100 01/01 → 10/04

2.2 Petrol 116 01/01 → 10/04 ENGINE: EW12J4

3.0 V6 Petrol 152 01/01 → 10/04

406 Coupé (8C)

2.0 16V Petrol 100 01/01 → 12/04

2.0 16V Petrol 97 01/01 → 12/04

3.0 V6 Petrol 152 01/01 → 12/04

3.0 V6 24V Petrol 140 01/01 → 12/04

GA2005
J2
GA(F/R) GRUPPO ASPIRAZIONE CARBURANTE
FUEL SUPPLY UNIT

PEUGEOT
206 2 volumi /Coda spiovente (2A/C)

1.1 i Petrol 44 10/01 → ENGINE: TU1JP

GA2005



PEUGEOT

206 2 volumi /Coda spiovente (2A/C)

1.4 i	Petrol	55	10/01 →	ENGINE: TU3JP
1.6 16V	Petrol	80	10/01 →	ENGINE: TU5JP4
2.0 S16	Petrol	100	10/01 →	ENGINE: EW10J4

206 CC (2D)

1.6 16V	Petrol	80	01/01 →	ENGINE: TU5JP
2.0 S16	Petrol	100	01/01 →	ENGINE: EW10J4

206 SW (2E/K)

1.1	Petrol	44	07/02 →	ENGINE: TU1JP
1.4	Petrol	55	07/02 →	ENGINE: TU3JP
1.6 16V	Petrol	80	07/02 →	ENGINE: TU5JP
2.0 16V	Petrol	100	07/02 →	ENGINE: EW10J4

GA2006

J2 GA(F/R) GRUPPO ASPIRAZIONE CARBURANTE FUEL SUPPLY UNIT



PEUGEOT

206 2 volumi /Coda spiovente (2A/C)

1.1 i	Petrol	44	01/01 →	ENGINE: TU1JP
1.4 i	Petrol	55	01/01 →	ENGINE: TU3JP
1.6 16V	Petrol	80	01/01 →	ENGINE: TU5JP
2.0 S16	Petrol	100	01/01 →	ENGINE: EW10J4

GA2007

J2 GA(R) GRUPPO ASPIRAZIONE CARBURANTE FUEL SUPPLY UNIT



RENAULT

TWINGO I (C06_)

1.2 (C066, C068)	Petrol	43	05/96 → 01/00	ENGINE: D4F
1.2 (C067)	Petrol	40	05/96 → 01/00	ENGINE: D4F

GA2008

J2 GA(R) GRUPPO ASPIRAZIONE CARBURANTE FUEL SUPPLY UNIT



RENAULT

CLIO II (BB0/1/2_, CB0/1/2_)

1.4 (B/CB0C)	Petrol	55	09/98 → 05/05	ENGINE: K4J
1.6 (B/CB0D)	Petrol	66	09/98 → 05/05	ENGINE: K7M

GA2009
J2 **GRUPPO ASPIRAZIONE CARBURANTE**
GA(F/R) **FUEL SUPPLY UNIT**

KW

RENAULT
CLIO II (BB0/1/2_, CB0/1/2_)

 1.2 16V (BB05,
BB0W, BB11,
BB27, BB2T,
BB2U, BB2V,
CB05...)

Petrol

55

06/01 →

 1.4 16V
(B/CB0P)

Petrol

72

08/00 →

 1.6 16V (BB01,
BB0H, BB0T,
BB14, BB1D,
BB1R, BB2KL...)

Petrol

79

09/98 →

 2.0 16V Sport
(CB0M)

Petrol

124

02/00 →

GA2010

KW

RENAULT
CLIO II (BB0/1/2_, CB0/1/2_)

 1.6 16V (BB01,
BB0H, BB0T,
BB14, BB1D,
BB1R, BB2KL...)

Petrol

79

01/01 →

ENGINE: K7M

 2.0 16V Sport
(CB0M)

Petrol

124

02/00 →

ENGINE: F4R

CLIO II Furgonato (SB0/1/2_)

 1.1 (SB0A, SB0F,
SB1K, SB2D)

Petrol

43

09/98 →

ENGINE: D7F

GA2011
J2 **GRUPPO ASPIRAZIONE CARBURANTE**
GA(F/R) **FUEL SUPPLY UNIT**

KW

RENAULT
TWINGO I (C06_)

1.2 (C063, C064)

Petrol

40

03/93 →

10/96

ENGINE: D4F-D7F

TWINGO I Furgonato (S06_)

1.2 (S063, S064)

Petrol

40

03/93 →

05/96

ENGINE: D4F-D7F

GA2010
J2 **GRUPPO ASPIRAZIONE CARBURANTE**
GA(F/R) **FUEL SUPPLY UNIT**

KW

RENAULT
CLIO II (BB0/1/2_, CB0/1/2_)

1.4 (B/CB0C)

Petrol

55

01/01 → 05/05

ENGINE: E7J

GA2014

J2 GRUPPO ASPIRAZIONE CARBURANTE
GA(F/R) FUEL SUPPLY UNIT



FIAT

MULTIPLA (186)

1.6 100 16V (186AXA1A)	Petrol	76	04/99 → 12/00
---------------------------	--------	----	---------------

GA2015

J2 GRUPPO ASPIRAZIONE CARBURANTE
GA(F/R) FUEL SUPPLY UNIT

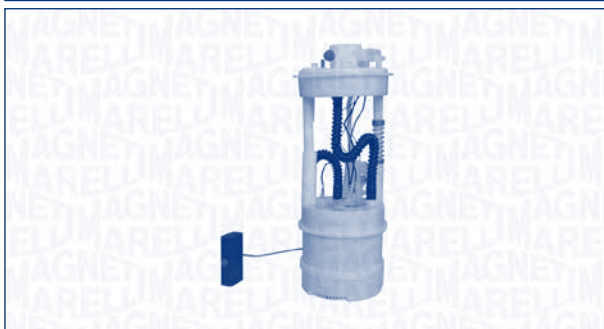

FIAT

BRAVA (182)

1.6 16V (182.BH)	Petrol	66	01/98 → 12/00
------------------	--------	----	---------------

BRAVO I (182)

1.6 16V (182.AH)	Petrol	66	01/98 → 12/00
------------------	--------	----	---------------

GA2018

J2 GRUPPO ASPIRAZIONE CARBURANTE
GA(F/R) FUEL SUPPLY UNIT



FIAT

PUNTO (188)

1.2 60 (188.030, .050, .130, .150, .230, .250)	Petrol	44	09/99 →
--	--------	----	---------

PUNTO Van (188AX)

1.2 60	Petrol	44	02/00 → 10/09
--------	--------	----	---------------

GA2020

J2 GRUPPO ASPIRAZIONE CARBURANTE
GA(F/R) FUEL SUPPLY UNIT



FIAT

BRAVA (182)

1.2 16V 80	Petrol	59	10/00 → 10/01
1.2 16V 80	Petrol	60	07/00 → 10/00
1.6 16V (182.BH)	Petrol	66	07/00 → 10/01
1.8 GT 16V (182.BC)	Petrol	83	07/00 → 10/01

BRAVO I (182)

1.2 16V 80	Petrol	59	10/00 → 10/01
1.2 16V 80	Petrol	60	07/00 → 10/00
1.6 16V (182.AH)	Petrol	66	07/00 → 10/01
1.8 GT (182.AC)	Petrol	83	07/00 → 10/01

GA2020

KW

FIAT
MAREA (185)

1.6 100 16V Bipower	Petrol/ CNG	76	10/00 → 05/02
------------------------	----------------	----	---------------

GA2021
J2 GRUPPO ASPIRAZIONE CARBURANTE
GA(F/R) FUEL SUPPLY UNIT

KW

FIAT
PANDA (141A_)

1100 4x4	Petrol	40	02/95 → 07/04	ENGINE: 176B2000
----------	--------	----	---------------	------------------

SEICENTO (187)

1.1 (187AXB, 187AXB1A)	Petrol	40	01/01 → 01/10
---------------------------	--------	----	---------------

SEICENTO Van (187)

1.1 (187CXB/C)	Petrol	40	01/01 → 01/10
----------------	--------	----	---------------

GA2022
J2 GRUPPO ASPIRAZIONE CARBURANTE
GA(F/R) FUEL SUPPLY UNIT

KW

LANCIA
Y (840A)

1.2 (840AA, 840AF1A)	Petrol	44	01/01 → 09/03
-------------------------	--------	----	---------------

GA2022

KW

LANCIA
Y (840A)

1.2 16V (840AD)	Petrol	63	01/01 → 09/03
-----------------	--------	----	---------------

1.2 16V (840AG1A)	Petrol	59	01/01 → 09/03
----------------------	--------	----	---------------

GA2023
J2 GRUPPO ASPIRAZIONE CARBURANTE
GA(F/R) FUEL SUPPLY UNIT

KW

FIAT
PANDA (141A_)

1100	Petrol	40	01/01 → 09/03
------	--------	----	---------------

GA2025
J2 GRUPPO ASPIRAZIONE CARBURANTE
GA FUEL SUPPLY UNIT

KW

CITROËN
XM (Y4)

3.0 V6	Petrol	140	04/97 → 12/99
--------	--------	-----	---------------

XM Break (Y4)

3.0 V6	Petrol	123	05/94 → 12/99
--------	--------	-----	---------------

3.0 V6	Petrol	140	04/97 → 12/99
--------	--------	-----	---------------

GA2025



PEUGEOT

605 (6B)

2.0	Petrol	79	01/94 → 09/99
2.0	Petrol	84	01/94 → 09/99
2.0	Petrol	89	01/94 → 09/99

GA2028

J2 GRUPPO ASPIRAZIONE CARBURANTE
GA(F/R) FUEL SUPPLY UNIT



NISSAN

MICRA III (K12)

1.2 16V	Petrol	48	01/03 → 06/10
1.2 16V	Petrol	59	01/03 → 06/10
1.4 16V	Petrol	65	01/03 → 06/10

GA2031

J2 GRUPPO ASPIRAZIONE CARBURANTE
GA(F/R) FUEL SUPPLY UNIT



RENAULT

CLIO III (BR0/1, CR0/1)

1.2 16V	Petrol	58	06/05 →	ENGINE: D4F
---------	--------	----	---------	-------------

GA2031



RENAULT

CLIO III (BR0/1, CR0/1)

1.2 16V (BR02, BR0J, BR11, CR02, CR0J, CR11)	Petrol	55	06/05 →	ENGINE: D4F
1.2 16V (BR0R, BR1D, BR1L, CR0R)	Petrol	48	06/05 →	ENGINE: D4F
1.4 16V	Petrol	72	06/05 →	ENGINE: K4J
1.6 16V (BR05, BR0B, BR0Y, BR15, BR1J, BR1M, BR1Y, CR0B...)	Petrol	82	06/05 →	ENGINE: K4M
1.6 16V (BR09, BR0T, CR09, CR0T)	Petrol	65	06/05 →	ENGINE: K4M

GA2032

J2 GRUPPO ASPIRAZIONE CARBURANTE
GA(F/R) FUEL SUPPLY UNIT



VOLKSWAGEN

CORRADO (53I)

2.0 i	Petrol	85	10/94 → 07/95	ENGINE: 2E,ADY
2.0 i 16V	Petrol	100	10/94 → 07/95	ENGINE: 9A
2.9 VR6	Petrol	140	10/94 → 07/95	ENGINE: ABV

GOLF III (1H1)

1.6	Petrol	74	01/96 → 08/97	ENGINE: AFT
2.0	Petrol	85	11/91 → 08/97	
2.8 VR6	Petrol	128	01/92 → 08/97	ENGINE: AAA
2.9 VR6 Syncro (1HX1)	Petrol	140	10/94 → 08/97	ENGINE: ABV

GA2032

VOLKSWAGEN
GOLF III Cabriolet (1E7)

1.6	Petrol	74	10/94 → 12/95	ENGINE: AEK
2.0	Petrol	85	07/93 → 05/98	ENGINE: ADY, AGG, AKR

GOLF III Variant (1H5)

1.6	Petrol	74	04/97 → 04/99	ENGINE: AKS
2.0	Petrol	85	07/93 → 04/99	ENGINE: ADY, AGG, AKR
2.9 VR6	Petrol	140	10/94 → 12/97	ENGINE: ABV

PASSAT (3A2, 35I)

1.6	Petrol	74	10/94 → 08/96	
1.8 G60 Syncro	Petrol	118	08/88 → 08/96	
2.0 16V	Petrol	100	08/88 → 09/93	

PASSAT Variant (3A5, 35I)

1.6	Petrol	74	07/94 → 12/95	
1.8 G60 Syncro	Petrol	118	08/88 → 05/97	
2.0 16V	Petrol	100	08/88 → 09/93	

VENTO (1H2)

1.6	Petrol	55	09/92 → 12/97	ENGINE: AEA
1.6	Petrol	74	10/94 → 12/97	ENGINE: AEK-AFT
2.0	Petrol	85	01/92 → 12/97	ENGINE: ADY-AGG-AKR
2.8 VR6	Petrol	128	01/92 → 12/97	ENGINE: AAA

GA2033
**J2 GRUPPO ASPIRAZIONE CARBURANTE
GA(F/R) FUEL SUPPLY UNIT**

CITROËN
BERLINGO (MF)

2.0 HDI 90 (MFRHY)	Diesel	66	06/00 → 11/02	
--------------------	--------	----	---------------	--

BERLINGO Furgonato (M_)

2.0 HDI 90 (MBRHY, MCRHY)	Diesel	66	06/00 → 11/02	
---------------------------	--------	----	---------------	--

GA2033

CITROËN
BERLINGO Furgonato (M_)

2.0 HDI 90 4WD (MBRHY, MCRHY)	Diesel	66	11/00 → 11/02	
-------------------------------	--------	----	---------------	--

XSARA PICASSO (N68)

2.0 HDi	Diesel	66	01/00 →	
---------	--------	----	---------	--

PEUGEOT
RANCH Furgonato (5)

2.0 HDi	Diesel	66	04/00 → 08/02	
---------	--------	----	---------------	--

RANCH MPV / Space wagon (5F)

2.0 HDi	Diesel	66	07/00 → 08/02	
---------	--------	----	---------------	--

GA2035
**J2 GRUPPO ASPIRAZIONE CARBURANTE
GA(F/R) FUEL SUPPLY UNIT**

PEUGEOT
307 Break (3E)

1.4 16V	Petrol	65	06/05 → 06/06	ENGINE: TU3JP4
1.6 16V	Petrol	80	06/05 → 06/06	ENGINE: TU3JP4

307 SW (3H)

1.4 16V	Petrol	65	06/05 → 06/06	ENGINE: TU3JP4
1.6 16V	Petrol	80	06/05 → 06/06	ENGINE: TU3JP4

GA2036

J2 GRUPPO ASPIRAZIONE CARBURANTE
GA(F/R) FUEL SUPPLY UNIT



CITROËN

JUMPY (U6U)

2.0 i 16V Petrol 102 11/06 → ENGINE: EW10J4

PEUGEOT

EXPERT Furgonato (VF3A_, VF3U_, VF3X_)

2.0 16V Petrol 103 01/07 → ENGINE: EW10J4

EXPERT Tepee (VF3V_)

2.0 16V Petrol 103 01/07 → ENGINE: EW10J4

GA2037

J2 GRUPPO ASPIRAZIONE CARBURANTE
GA(R) FUEL SUPPLY UNIT



CITROËN

JUMPY

2.0 i Petrol 103 01/07 → ENGINE: EW10J4

JUMPY Furgonato

2.0 i Petrol 103 01/07 → ENGINE: EW10J4

PEUGEOT

EXPERT Furgonato (VF3A_, VF3U_, VF3X_)

2.0 16V Petrol 103 01/07 → ENGINE: EW10J4

EXPERT Tepee (VF3V_)

2.0 16V Petrol 103 01/07 → ENGINE: EW10J4

GA2038

J2 GRUPPO ASPIRAZIONE CARBURANTE
GA FUEL SUPPLY UNIT



CITROËN

C6 (TD_)

2.7 HDi Diesel 150 09/06 → ENGINE: DT17

GA2039

J2 GRUPPO ASPIRAZIONE CARBURANTE
GA(R) FUEL SUPPLY UNIT



RENAULT

CLIO III (BR0/1, CR0/1)

1.2 Petrol 43 08/06 →

1.2 16V Petrol 58 06/05 →

1.2 16V (BR02, BR0J, BR11, CR02, CR0J, CR11) Petrol 55 06/05 →

1.2 16V (BR0P, CR0P) Petrol 74 05/07 →

1.2 16V (BR0R, BR1D, BR1L, CR0R) Petrol 48 06/05 →

1.4 16V Petrol 72 06/05 →

GA2039

RENAULT
CLIO III (BR0/1, CR0/1)

1.6 16V (BR05, BR0B, BR0Y, BR15, BR1J, BR1M, BR1Y, CR0B...)	Petrol	82	06/05 →
1.6 16V (BR09, BR0T, CR09, CR0T)	Petrol	65	06/05 →
2.0 16V (BR0C, BR0K, CR0C, CR0K)	Petrol	102	09/06 →
2.0 16V Sport	Petrol	145	02/06 →

GA2040
**J2
GA(R) GRUPPO ASPIRAZIONE CARBURANTE
FUEL SUPPLY UNIT**

MINI
MINI (R50, R53)

Works	Petrol	155	12/06 → 09/06
MINI (R56)			
Cooper	Petrol	88	10/06 →
One	Petrol	70	03/07 →

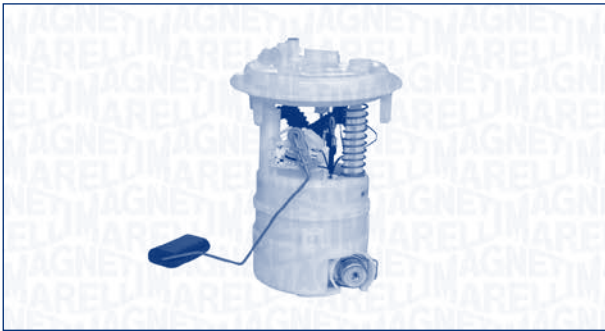
GA2041
**J2
GA(F/R) GRUPPO ASPIRAZIONE CARBURANTE
FUEL SUPPLY UNIT**

CITROËN
C3 I (FC_)

1.1 i	Petrol	44	04/03 → 08/05
1.4 i Bivalent	Petrol/ CNG	54	04/03 → 08/05
1.6 16V	Petrol	80	04/03 → 08/05

C3 Pluriel (HB_)

1.4	Petrol	54	05/03 →
1.6	Petrol	80	05/03 →

GA2042
**J2
GA(R) GRUPPO ASPIRAZIONE CARBURANTE
FUEL SUPPLY UNIT**

CITROËN
C4 I (LC_)

1.4 16V	Petrol	65	06/06 →
1.6 16V	Petrol	80	06/06 →
2.0 16V	Petrol	100	06/06 →
2.0 16V	Petrol	103	06/06 →
2.0 16V	Petrol	130	06/06 →

GA2042



PEUGEOT

307 (3A/C)

1.4 16V	Petrol	65	11/03 →
2.0 16V	Petrol	103	03/05 →
2.0 16V	Petrol	130	06/05 →

307 CC (3B)

1.6 16V	Petrol	80	02/05 →
2.0 16V	Petrol	103	03/05 →
2.0 16V	Petrol	130	10/03 →

GA2043

J2 GRUPPO ASPIRAZIONE CARBURANTE
GA(F/R) FUEL SUPPLY UNIT



PEUGEOT

207 (WA_, WC_)

1.4	Petrol	53	02/06 →	ENGINE: TU3A
1.4 16V	Petrol	65	02/06 →	ENGINE: ET3J4
1.6 16V	Petrol	80	02/06 →	ENGINE: TU5JP4
1.6 16V RC	Petrol	128	02/07 →	ENGINE: EP6DTS
1.6 16V Turbo	Petrol	110	12/06 →	ENGINE: EP6DT
1.6 16V VTi	Petrol	88	02/07 →	ENGINE: EP6

207 CC (WD_)

1.6 16V	Petrol	88	02/07 →	ENGINE: EP6
1.6 16V Turbo	Petrol	110	02/07 →	ENGINE: EP6DT

207 SW (WK_)

1.4	Petrol	54	06/07 →	ENGINE: TU3A
1.6 16V	Petrol	88	06/07 →	ENGINE: EP6

GA2044

J2 GRUPPO ASPIRAZIONE CARBURANTE
GA(F) FUEL SUPPLY UNIT



RENAULT

MODUS / GRAND MODUS (F/JP0_)

1.5 dCi (JP02)	Diesel	76	05/07 →
----------------	--------	----	---------

GA2045

J2 GRUPPO ASPIRAZIONE CARBURANTE
GA(F) FUEL SUPPLY UNIT



FIAT

DUCATO Autobus (244, Z_)

2.0	Petrol	81	04/02 →
-----	--------	----	---------

DUCATO Furgonato (244)

2.0	Petrol	81	04/02 →
-----	--------	----	---------

GA2046

J2 GRUPPO ASPIRAZIONE CARBURANTE
GA(F/R) FUEL SUPPLY UNIT



PEUGEOT

508

1.6 VTi Petrol 88 11/10 →

GA2048

J2 GRUPPO ASPIRAZIONE CARBURANTE
GA(F) FUEL SUPPLY UNIT

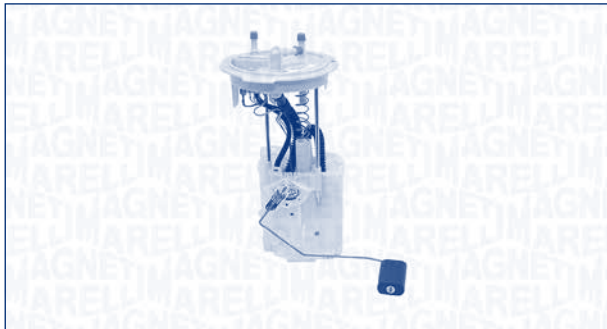

VOLKSWAGEN

PASSAT (3C2)

2.0 TDI 4motion Diesel 103 03/05 → 05/09

GA2047

J2 GRUPPO ASPIRAZIONE CARBURANTE
GA(F) FUEL SUPPLY UNIT



OPEL

ZAFIRA B (A05)

2.0 Petrol 147 07/05 →

GA2049

J2 GRUPPO ASPIRAZIONE CARBURANTE
GA(F) FUEL SUPPLY UNIT



OPEL

ZAFIRA B (A05)

2.0 Petrol 177 01/06 →

GA2050

J2 GRUPPO ASPIRAZIONE CARBURANTE
GA(F/R) FUEL SUPPLY UNIT

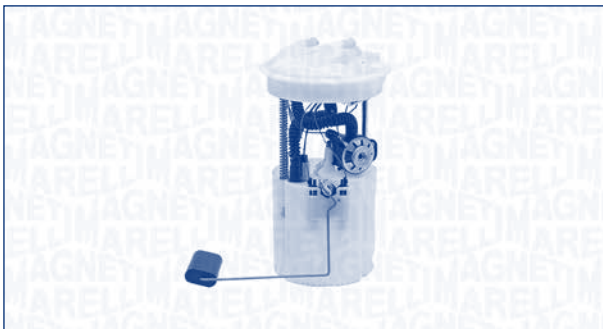

VOLVO

S40 II (MS)

T5 Petrol 162 01/04 →

GA2053

J2 GRUPPO ASPIRAZIONE CARBURANTE
GA(F) FUEL SUPPLY UNIT



DACIA

LODGY

1.6 Petrol 61 03/12 →

GA2051

J2 GRUPPO ASPIRAZIONE CARBURANTE
GA(F/R) FUEL SUPPLY UNIT



CITROËN

C4 II (B7)

1.6 THP 155 Petrol 115 11/09 →

GA2054

J2 GRUPPO ASPIRAZIONE CARBURANTE
GA(F) FUEL SUPPLY UNIT



ALFA ROMEO

166 (936)

2.0 T.Spark (936A3B_) Petrol 110 10/00 → 06/07

2.5 V6 24V (936A21_) Petrol 138 10/00 → 06/07

3.0 V6 24V (936A11_) Petrol 162 10/00 → 06/07

GA2055
J2
GA(F) GRUPPO ASPIRAZIONE CARBURANTE
FUEL SUPPLY UNIT

OPEL
ASTRA H GTC (L08)

2.0 Turbo Petrol 177 08/05 →

ASTRA H TwinTop (L67)

2.0 Turbo Petrol 125 09/05 →

2.0 Turbo Petrol 147 09/05 →

GA2057
J2
GA(F/R) GRUPPO ASPIRAZIONE CARBURANTE
FUEL SUPPLY UNIT

RENAULT
LAGUNA III (BT0/1)

 2.0 16V (BT05,
BT0F, BT0W) Petrol 103 10/07 →

GA2058
J2
GA(F/R) GRUPPO ASPIRAZIONE CARBURANTE
FUEL SUPPLY UNIT

FORD
MONDEO III (B5Y)

1.8 SCi Petrol 96 06/03 → 08/07

GA2059
J2
GA(F) GRUPPO ASPIRAZIONE CARBURANTE
FUEL SUPPLY UNIT

CITROËN
C4 I (LC_)

1.6 16V Bio-Flex BiFuel 80 09/07 →

308 (4A_, 4C_)

1.6 16V Petrol 103 09/07 →

GA2060

J2 GRUPPO ASPIRAZIONE CARBURANTE
GA(F/R) FUEL SUPPLY UNIT



VOLVO

C30

T5 Petrol 169 03/07 → 12/12

S40 II (MS)

T5 Petrol 169 03/07 →

T5 AWD Petrol 169 03/07 →

GA2061

J2 GRUPPO ASPIRAZIONE CARBURANTE
GA(F) FUEL SUPPLY UNIT



ALFA ROMEO

166 (936)

2.4 JTD (936A2B_) Diesel 103 10/00 → 06/07

GA2062

J2 GRUPPO ASPIRAZIONE CARBURANTE
GA(F) FUEL SUPPLY UNIT



LANCIA

THESIS (841AX)

2.0 Turbo (841AXA1B03) Petrol 136 07/02 → 07/09

2.4 (841AXB1B00) Petrol 125 07/02 → 07/09

2.4 JTD Diesel 129 05/03 → 07/09

3.0 V6 (841AXC1101) Petrol 158 07/02 → 07/09

GA2063

J2 GRUPPO ASPIRAZIONE CARBURANTE
GA(F/R) FUEL SUPPLY UNIT



PEUGEOT

508

1.6 THP Petrol 115 11/10 →

GA2064
J2 GRUPPO ASPIRAZIONE CARBURANTE
GA(F/R) FUEL SUPPLY UNIT

CITROËN
C5 III (RD_)

1.6 THP 155 Petrol 115 04/09 →

C5 III Break (TD_)

1.6 THP 155 Petrol 115 04/09 →

GA2066
J2 GRUPPO ASPIRAZIONE CARBURANTE
GA FUEL SUPPLY UNIT

VOLKSWAGEN
CADDY III Furgonato (2KA, 2KH, 2CA, 2CH)

1.9 TDI 4motion Diesel 77 11/08 → 08/10

CADDY III Station wagon (2KB, 2KJ, 2CB, 2CJ)

1.9 TDI 4motion Diesel 77 05/08 → 08/10

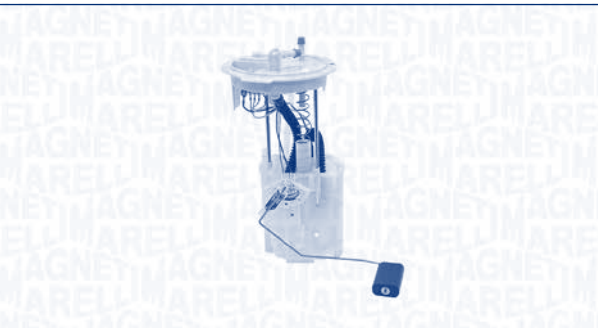
GA2065
J2 GRUPPO ASPIRAZIONE CARBURANTE
GA(F) FUEL SUPPLY UNIT

VOLKSWAGEN
PASSAT Variant (3C5)

2.0 TDI 4motion Diesel 103 08/05 → 05/09

GA2068
J2 GRUPPO ASPIRAZIONE CARBURANTE
GA(F) FUEL SUPPLY UNIT

FIAT
QUBO (225)

1.4 Petrol 54 02/08 →

GA2069

J2 GRUPPO ASPIRAZIONE CARBURANTE
GA(F) FUEL SUPPLY UNIT



DACIA

LODGY

1.5 dCi Diesel 79 01/13 →

GA2070

J2 GRUPPO ASPIRAZIONE CARBURANTE
GA(F/R) FUEL SUPPLY UNIT



LAND ROVER

DISCOVERY II (LJ, LT)

4.0 V8 4x4 Petrol 136 11/98 → 06/04

GA2071

J2 GRUPPO ASPIRAZIONE CARBURANTE
GA(F) FUEL SUPPLY UNIT

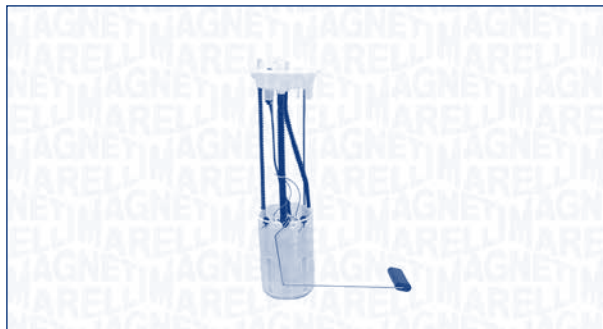

IVECO

DAILY IV Cassone / Furgonato / Promiscuo

65C15 Diesel 107 05/06 →

65C18 Diesel 130 05/06 →

DAILY IV Pianale piatto/Telaio

65C15, 65C15 /P,
65C15 D,
65C15 D/P Diesel 107 05/06 →

65C18 Diesel 130 05/06 →

GA2072

J2 GRUPPO ASPIRAZIONE CARBURANTE
GA(F/R) FUEL SUPPLY UNIT



VOLVO

C30

D5 Diesel 132 10/06 → 12/12

C70 II Cabriolet

D5 Diesel 132 03/06 →

GA2073
J2
GA(F) GRUPPO ASPIRAZIONE CARBURANTE
FUEL SUPPLY UNIT

LANCIA
DELTA III (844)

1.4	Petrol	110	09/08 →
1.4	Petrol	88	09/08 →

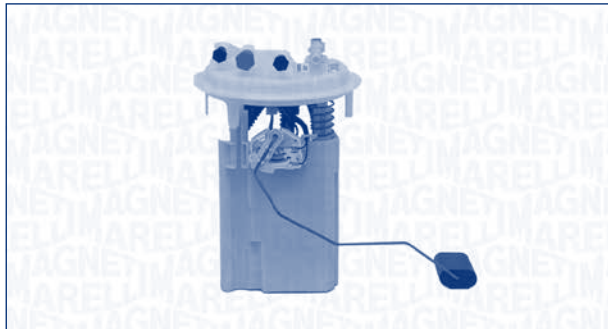
GA2075
J2
GA GRUPPO ASPIRAZIONE CARBURANTE
FUEL SUPPLY UNIT

PEUGEOT
407 Coupé (6C_)

2.7 HDi	Diesel	150	10/05 →
---------	--------	-----	---------

GA2074
J2
GA(F) GRUPPO ASPIRAZIONE CARBURANTE
FUEL SUPPLY UNIT

OPEL
CORSA D

1.6 Turbo	Petrol	141	02/07 →
1.6 Turbo	Petrol	110	02/07 →

GA2076
J2
GA(F) GRUPPO ASPIRAZIONE CARBURANTE
FUEL SUPPLY UNIT

MERCEDES-BENZ
VITO / MIXTO Furgonato (W639)

109 CDI	Diesel	65	09/03 →
---------	--------	----	---------

GA2077

J2 GRUPPO ASPIRAZIONE CARBURANTE
GA(F/R) FUEL SUPPLY UNIT



PEUGEOT

207 (WA_, WC_)

1.6 16V Turbo Petrol 110 02/06 →

GA2078

J2 GRUPPO ASPIRAZIONE CARBURANTE
GA(F) FUEL SUPPLY UNIT



VOLVO

C70 II Cabriolet

T5 Petrol 169 03/07 →

T5 Petrol 162 03/06 →

V50 (MW)

T5 Petrol 162 04/04 →

T5 Petrol 169 03/07 →

GA2080

J2 GRUPPO ASPIRAZIONE CARBURANTE
GA(F/R) FUEL SUPPLY UNIT

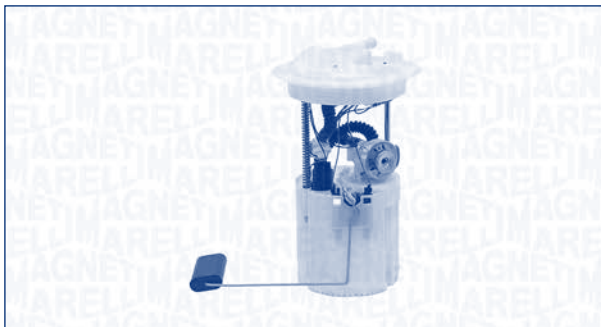

VOLVO

C30

2.4 i Petrol 125 10/06 → 12/12

V50 (MW)

2.4 Petrol 125 04/04 →

GA2081

J2 GRUPPO ASPIRAZIONE CARBURANTE
GA FUEL SUPPLY UNIT



PEUGEOT

607 (9D, 9U)

2.7 HDi 24V Diesel 150 12/04 →

GA2082
J2 GRUPPO ASPIRAZIONE CARBURANTE
GA(F/R) FUEL SUPPLY UNIT

DACIA
DUSTER

1.6 16V 4x4 Petrol 77 06/10 →

GA2083
J2 GRUPPO ASPIRAZIONE CARBURANTE
GA(F/R) FUEL SUPPLY UNIT

DACIA
DUSTER

1.6 16V 4x4 Petrol 77 06/10 →

GA2084
J2 GRUPPO ASPIRAZIONE CARBURANTE
GA(F) FUEL SUPPLY UNIT

FIAT
MULTIPLA (186)

1.6 16V Bipower (186AMB1A) Petrol/CNG 76 04/99 → 06/10

1.6 16V Blupower (186AMA1A) Bifuel 70 04/99 → 06/10

GA2085
J2 GRUPPO ASPIRAZIONE CARBURANTE
GA(F) FUEL SUPPLY UNIT

VOLVO
C30

T5 Petrol 162 10/06 → 12/12

V50 (MW)

T5 AWD Petrol 162 04/04 →

GA2086

J2 GRUPPO ASPIRAZIONE CARBURANTE
GA(F/R) FUEL SUPPLY UNIT



CITROËN

C4 Picasso I (UD_)

1.6 16V	Petrol	110	07/08 →
1.6 THP 140	Petrol	103	07/08 →

DS5

1.6 THP 155	Petrol	115	11/11 →
1.6 THP 200	Petrol	147	11/11 →

PEUGEOT

5008

1.6 16V	Petrol	115	09/09 →
---------	--------	-----	---------

GA2087

J2 GRUPPO ASPIRAZIONE CARBURANTE
GA(F/R) FUEL SUPPLY UNIT



ALFA ROMEO

166 (936)

2.0 V6 (936A3_)	Petrol	151	09/98 → 10/00
-----------------	--------	-----	---------------

GA2087

J2 GRUPPO ASPIRAZIONE CARBURANTE
GA(F/R) FUEL SUPPLY UNIT



LANCIA

KAPPA (838A)

2.0 20V Turbo (838AM1AA)	Petrol	162	06/98 → 10/01
--------------------------	--------	-----	---------------

2.4 JTD (838AL1AA)	Diesel	100	06/98 → 10/01
--------------------	--------	-----	---------------

3.0 24V (838AD1AA, 838AD11A, 838XD1AA, 838ZD1AA)	Petrol	150	08/94 → 10/01
--	--------	-----	---------------

KAPPA Coupé (838)

2.0 20V Turbo (838CM)	Petrol	162	06/98 → 03/01
-----------------------	--------	-----	---------------

KAPPA SW (838B)

2.0 20V Turbo (838BM1AA)	Petrol	162	06/98 → 10/01
--------------------------	--------	-----	---------------

GA2088

J2 GRUPPO ASPIRAZIONE CARBURANTE
GA(F) FUEL SUPPLY UNIT



VOLVO

S40 II (MS)

2.4	Petrol	103	01/04 →
2.4	Petrol	125	01/04 →

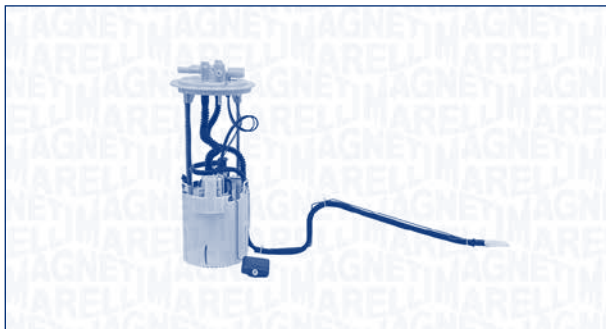
GA2090
J2
GA(F) GRUPPO ASPIRAZIONE CARBURANTE
FUEL SUPPLY UNIT

MERCEDES-BENZ
SPRINTER 3,5-t Autobus (906)

 319 CDI / BlueTEC
 (906.731, 906.733, 906.735) Diesel 140 03/09 →

 319 CDI / BlueTEC 4x4
 (906.731, 906.733, 906.735) Diesel 140 03/09 →

SPRINTER 3,5-t Furgonato (906)

 319 CDI / BlueTEC
 (906.631, 906.633, 906.635, 906.637) Diesel 140 03/09 →

SPRINTER 3,5-t Pianale piatto/Telaio (906)

 319 CDI / BlueTEC
 (906.131, 906.133, 906.135, 906.231...) Diesel 140 03/09 →

SPRINTER 3-t Furgonato (906)

 219 CDI / BlueTEC
 (906.611, 906.613) Diesel 140 03/09 →

SPRINTER 3-t Pianale piatto/Telaio (906)

 219 CDI / BlueTEC
 (906.111, 906.113, 906.211, 906.213) Diesel 140 03/09 →

SPRINTER 4,6-t Furgonato (906)

419 CDI (906.653, 906.655, 906.657) Diesel 140 03/09 →

SPRINTER 4,6-t Pianale piatto/Telaio (906)

419 CDI (906.153, 906.155, 906.253, 906.255) Diesel 140 03/09 →

GA2090

MERCEDES-BENZ
SPRINTER 5-t Furgonato (906)

 519 CDI / BlueTEC
 (906.653, 906.655, 906.657) Diesel 140 03/09 →

SPRINTER 5-t Pianale piatto/Telaio (906)

 519 CDI / BlueTEC
 (906.153, 906.155, 906.253, 906.255) Diesel 140 03/09 →

GA2092
J2
GA(F) GRUPPO ASPIRAZIONE CARBURANTE
FUEL SUPPLY UNIT

OPEL
ASTRA H (L48)

2.0 Turbo Petrol 125 03/04 →

2.0 Turbo Petrol 147 09/04 →

ASTRA H GTC (L08)

2.0 Turbo Petrol 125 03/05 →

2.0 Turbo Petrol 147 03/05 →

ASTRA H Station wagon (L35)

2.0 Turbo Petrol 125 08/04 →

2.0 Turbo Petrol 147 09/04 →

VAUXHALL
ASTRA Mk V (H) 2 volumi /Coda spiovente

2.0 Turbo Petrol 125 01/04 → 05/09

2.0 Turbo Petrol 147 01/04 → 05/09

ASTRA Mk V (H) Sport Hatch

2.0 Turbo Petrol 125 02/05 → 11/10

ASTRA Mk V (H) Station wagon

2.0 Turbo Petrol 125 08/04 → 10/10

2.0 Turbo Petrol 147 08/04 → 10/10

GA2093

J2 GRUPPO ASPIRAZIONE CARBURANTE
GA(F/R) FUEL SUPPLY UNIT



OPEL

ZAFIRA B (A05)

2.2 Petrol 110 07/05 →

GA2095

J2 GRUPPO ASPIRAZIONE CARBURANTE
GA(F/R) FUEL SUPPLY UNIT



RENAULT

KANGOO / GRAND KANGOO (KW0/1_)

1.6 16V (KW0D) Petrol 78 02/08 →

GA2094

J2 GRUPPO ASPIRAZIONE CARBURANTE
GA FUEL SUPPLY UNIT



SAAB

9-5 (YS3E)

2.0 T Petrol 110 09/97 →
2.3 Turbo Petrol 169 10/99 → 09/01

GA2096

J2 GRUPPO ASPIRAZIONE CARBURANTE
GA(F/R) FUEL SUPPLY UNIT



LAND ROVER

RANGE ROVER II (LP)

3.9 4x4 Petrol 140 07/94 → 03/02
4.0 4x4 Petrol 136 06/98 → 03/02
4.6 4x4 Petrol 160 06/98 → 03/02
4.6 4x4 Petrol 165 07/94 → 03/02

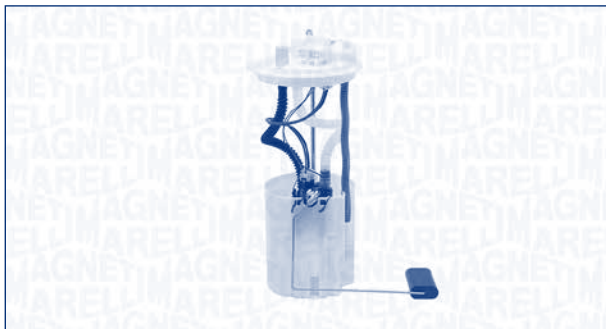
GA2097
J2 GRUPPO ASPIRAZIONE CARBURANTE
GA(F) FUEL SUPPLY UNIT

KW

FIAT
DOBLO Combi (152, 263)

1.3 D Multijet Diesel 66 02/10 →

1.6 D Multijet Diesel 77 02/10 →

2.0 D Multijet Diesel 99 02/10 →

GA2098
J2 GRUPPO ASPIRAZIONE CARBURANTE
GA(F/R) FUEL SUPPLY UNIT

KW

FIAT
IDEA

1.3 D Multijet Diesel 66 10/05 →

GA2099
J2 GRUPPO ASPIRAZIONE CARBURANTE
GA(F/R) FUEL SUPPLY UNIT

KW

LANCIA
LYBRA (839AX)

1.6 16V (839AXA1A) Petrol 76 07/99 → 10/05

1.8 16V (839AXB1A, 839AXG1A) Petrol 96 07/99 → 10/05

2.0 20V (839AXC11, 839AXC1A) Petrol 113 07/99 → 09/00

2.0 20V (839AXH1A) Petrol 110 09/00 → 10/05

LYBRA SW (839BX)

1.6 16V (839BXA1A) Petrol 76 07/99 → 10/05

1.8 16V (839BXB1A, 839BXG1A) Petrol 96 07/99 → 10/05

2.0 20V (839BXC11, 839BXC1A) Petrol 113 07/99 → 09/00

2.0 20V (839BXH1A) Petrol 110 09/00 → 10/05

GA2100

J2 GRUPPO ASPIRAZIONE CARBURANTE
GA(F) FUEL SUPPLY UNIT



OPEL

SIGNUM

2.2 direct Petrol 114 05/03 →

VECTRA C Station wagon

2.2 direct Petrol 114 10/03 →

GA2101

J2 GRUPPO ASPIRAZIONE CARBURANTE
GA(F/R) FUEL SUPPLY UNIT



FIAT

DUCATO Furgonato (250)

100 Multijet 2,2 D Diesel 74 07/06 →

GA2102

J2 GRUPPO ASPIRAZIONE CARBURANTE
GA(F/R) FUEL SUPPLY UNIT



ALFA ROMEO

166 (936)

2.0 T.Spark (936A3A_) Petrol 114 09/98 → 10/00

2.5 V6 24V (936A2_) Petrol 140 09/98 → 10/00

3.0 V6 24V (936A1_) Petrol 166 09/98 → 10/00

GA2103

J2 GRUPPO ASPIRAZIONE CARBURANTE
GA(F/R) FUEL SUPPLY UNIT



OPEL

INSIGNIA

1.6 Petrol 85 07/08 →

1.8 Petrol 103 07/08 →

INSIGNIA Sports Tourer

1.6 Petrol 85 07/08 →

1.8 Petrol 103 07/08 →

INSIGNIA Tre volumi

1.6 Petrol 85 07/08 →

1.8 Petrol 103 07/08 →

GA2104
J2 GRUPPO ASPIRAZIONE CARBURANTE
GA(F/R) FUEL SUPPLY UNIT

KW

CITROËN
C4 II (B7)

1.4 VTi 95 Petrol 70 11/09 →

1.6 VTi 120 Petrol 88 11/09 →

GA2105
J2 GRUPPO ASPIRAZIONE CARBURANTE
GA(F/R) FUEL SUPPLY UNIT

KW

FORD
FOCUS C-MAX

1.8 Petrol 88 10/03 → 03/07

GA2106
J2 GRUPPO ASPIRAZIONE CARBURANTE
GA(F) FUEL SUPPLY UNIT

KW

ALFA ROMEO
166 (936)

2.4 JTD Diesel 129 10/03 → 06/07

 2.4 JTD
 (936A2A_) Diesel 100 09/98 → 10/00

LANCIA
KAPPA SW (838B)

 2.4 JTD
 (838BL1AA) Diesel 100 06/98 → 10/01

GA2107
J2 GRUPPO ASPIRAZIONE CARBURANTE
GA(F) FUEL SUPPLY UNIT

KW

BMW
Z4 (E89)

sDrive 23 i Petrol 150 05/09 →

sDrive 30 i Petrol 190 05/09 →

sDrive 35 i Petrol 225 05/09 →

sDrive 35 is Petrol 250 09/10 →

sDrive20i Petrol 135 09/11 →

sDrive28i Petrol 180 09/11 →

GA2108

J2 GRUPPO ASPIRAZIONE CARBURANTE
GA(F/R) FUEL SUPPLY UNIT



FIAT

MULTIPLA (186)

1.9 JTD (186AXE1A)	Diesel	88	04/02 → 06/10
-----------------------	--------	----	---------------

GA2109

J2 GRUPPO ASPIRAZIONE CARBURANTE
GA(F/R) FUEL SUPPLY UNIT



NISSAN

JUKE (F15)

1.6 DIG-T	Petrol	140	06/10 →
-----------	--------	-----	---------

GA2110

J2 GRUPPO ASPIRAZIONE CARBURANTE
GA(F) FUEL SUPPLY UNIT



ALFA ROMEO

MITO (955)

1.4 TB	Petrol	114	09/08 →
--------	--------	-----	---------

FIAT

PUNTO / GRANDE PUNTO (199)

1.4 Abarth	Petrol	114	12/07 →
1.4 T-Jet	Petrol	88	09/07 →

GA2111

J2 GRUPPO ASPIRAZIONE CARBURANTE
GA(F/R) FUEL SUPPLY UNIT



PEUGEOT

308 SW

1.6 16V	Petrol	88	09/07 →
---------	--------	----	---------

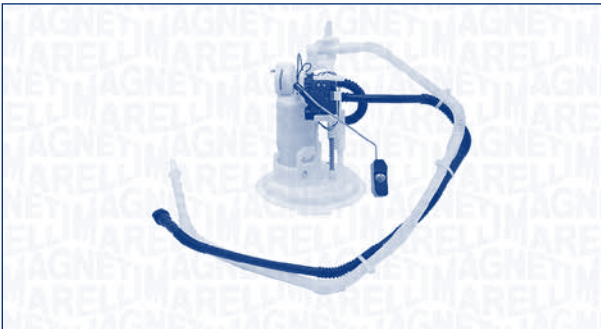
GA2112
J2 GRUPPO ASPIRAZIONE CARBURANTE
GA(F/R) FUEL SUPPLY UNIT

MERCEDES-BENZ
CLASSE C (W204)

C 180 Kompressor (204.046)	Petrol	115	01/07 →
-------------------------------	--------	-----	---------

GA2113
J2 GRUPPO ASPIRAZIONE CARBURANTE
GA FUEL SUPPLY UNIT

VOLVO
C30

1.6	Petrol	74	10/06 → 12/12
-----	--------	----	---------------

S40 II (MS)

1.6	Petrol	74	01/05 →
-----	--------	----	---------

V50 (MW)

1.6	Petrol	74	01/05 →
-----	--------	----	---------

GA2114
J2 GRUPPO ASPIRAZIONE CARBURANTE
GA(F) FUEL SUPPLY UNIT

OPEL
MERIVA B

1.4	Petrol	74	06/10 →
-----	--------	----	---------

GA2115
J2 GRUPPO ASPIRAZIONE CARBURANTE
GA(F) FUEL SUPPLY UNIT

ALFA ROMEO
GIULIETTA (940)

1.4 TB	Petrol	125	04/10 →
--------	--------	-----	---------

1.4 TB	Petrol	88	04/10 →
--------	--------	----	---------

GA2116

J2 GRUPPO ASPIRAZIONE CARBURANTE
GA FUEL SUPPLY UNIT



VOLKSWAGEN

TIGUAN (5N_)

1.4 TSI 4motion Petrol 110 09/07 →

GA2117

J2 GRUPPO ASPIRAZIONE CARBURANTE
GA(F) FUEL SUPPLY UNIT



RENAULT

LAGUNA II (BG0/1_)

2.2 dCi (BG0F) Diesel 110 10/01 →

LAGUNA II Grandtour (KG0/1_)

2.2 dCi (KG0F) Diesel 110 10/01 →

GA2118

J2 GRUPPO ASPIRAZIONE CARBURANTE
GA(R) FUEL SUPPLY UNIT

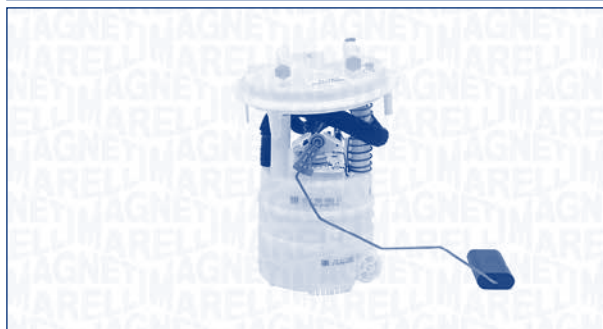

PEUGEOT

3008

1.6 THP Petrol 110 06/09 →

1.6 THP Petrol 115 06/09 →

308 (4A_, 4C_)

1.6 16V Petrol 110 09/07 →

1.6 16V Petrol 115 10/09 →

1.6 GTI Petrol 147 07/10 →

308 CC

1.6 16V Petrol 110 06/09 →

1.6 16V Petrol 115 06/09 →

308 SW

1.6 16V Petrol 110 09/07 →

1.6 16V Petrol 128 03/08 →

1.6 16V Petrol 115 10/09 →

GA2119

J2 GRUPPO ASPIRAZIONE CARBURANTE
GA(F) FUEL SUPPLY UNIT



ALFA ROMEO

147 (937)

1.9 JTD (937AXD1A) Diesel 85 04/01 → 03/10

GA2120
J2
GA GRUPPO ASPIRAZIONE CARBURANTE
FUEL SUPPLY UNIT

mitsubishi
COLT VI (Z3_A, Z2_A)

1.5 DI-D Diesel 50 08/04 → 06/12

1.5 DI-D Diesel 70 08/04 → 06/12

SMART
FORFOUR (454)

1.5 CDI (454.000) Diesel 50 09/04 → 06/06

1.5 CDI (454.001) Diesel 70 09/04 → 06/06

GA2121

RENAULT
LAGUNA III (BT0/1)

2.0 dCi GT Diesel 131 03/08 →

GA2122
J2
GA(F/R) GRUPPO ASPIRAZIONE CARBURANTE
FUEL SUPPLY UNIT

FIAT
DOBLO (119)

1.2 (223AXA1A) Petrol 48 03/01 →

1.6 16V (223AXD1A) Petrol 76 10/01 →

DOBLO Cargo (223)

1.2 (223ZXA1A) Petrol 48 03/01 →

1.6 16V (223ZXD1A) Petrol 76 10/01 →

GA2121
J2
GA GRUPPO ASPIRAZIONE CARBURANTE
FUEL SUPPLY UNIT

RENAULT
LAGUNA III (BT0/1)

2.0 dCi (BT01, BT09, BT12, BT1S) Diesel 110 10/07 →

2.0 dCi (BT08, BT0K, BT00J, BT14, BT1A, BT1D) Diesel 96 10/07 →

2.0 dCi (BT0M, BT0N, BT19) Diesel 127 01/08 →

GA2123
J2
GA(F) GRUPPO ASPIRAZIONE CARBURANTE
FUEL SUPPLY UNIT

HYUNDAI
TUCSON (JM)

2.0 CRDi Diesel 83 08/04 → 03/10

GA2123



HYUNDAI

TUCSON (JM)

2.0 CRDi	Diesel	83	08/04 → 03/10
----------	--------	----	---------------

KIA

SPORTAGE (JE_)

2.0 CRDi	Diesel	83	02/05 →
----------	--------	----	---------

GA2124

J2 GA GRUPPO ASPIRAZIONE CARBURANTE
FUEL SUPPLY UNIT



VOLKSWAGEN

GOLF IV (1J1)

1.9 SDI	Diesel	50	08/97 → 06/05
---------	--------	----	---------------

GA2125

J2 GA GRUPPO ASPIRAZIONE CARBURANTE
FUEL SUPPLY UNIT



OPEL

SIGNUM

1.9 CDTI	Diesel	110	04/04 →
----------	--------	-----	---------

VECTRA C Station wagon

1.9 CDTI	Diesel	110	04/04 →
----------	--------	-----	---------

GA2126

J2 GA(F) GRUPPO ASPIRAZIONE CARBURANTE
FUEL SUPPLY UNIT



LANCIA

DELTA III (844)

1.6 D Multijet	Diesel	88	09/08 →
----------------	--------	----	---------

1.9 D Multijet	Diesel	140	01/09 →
----------------	--------	-----	---------

2.0 D Multijet	Diesel	121	09/08 →
----------------	--------	-----	---------

GA2127

J2 GA(F) GRUPPO ASPIRAZIONE CARBURANTE
FUEL SUPPLY UNIT



FIAT

DUCATO Autobus (250)

100 Multijet 2,2 D	Diesel	74	07/06 →
--------------------	--------	----	---------

DUCATO Pianale piatto/Telaio (250)

100 Multijet 2,2 D	Diesel	74	07/06 →
--------------------	--------	----	---------

GA2128
J2
GA GRUPPO ASPIRAZIONE CARBURANTE
FUEL SUPPLY UNIT

MINI
MINI (R56)

Cooper D	Diesel	82	06/10 →	
One D	Diesel	66	07/10 →	

MINI Cabriolet (R57)

Cooper D	Diesel	82	06/10 →	
----------	--------	----	---------	--

MINI CLUBMAN (R55)

Cooper D	Diesel	82	03/10 →	
One D	Diesel	66	03/10 →	

GA2129
J2
GA(F/R) GRUPPO ASPIRAZIONE CARBURANTE
FUEL SUPPLY UNIT

CITROËN
C3 II

1.4 VTi 95	Petrol	70	11/09 →	
------------	--------	----	---------	--

DS3

1.6 THP 155	Petrol	115	04/10 →	
-------------	--------	-----	---------	--

GA2130
J2
GA GRUPPO ASPIRAZIONE CARBURANTE
FUEL SUPPLY UNIT

MERCEDES-BENZ
VITO / MIXTO Furgonato (W639)

110 CDI	Diesel	70	09/10 →	
113 CDI	Diesel	100	09/10 →	
116 CDI	Diesel	120	09/10 →	
122 CDI	Diesel	165	09/10 →	

VITO Autobus (W639)

110 CDI	Diesel	70	09/10 →	
113 CDI	Diesel	100	09/10 →	
116 CDI	Diesel	120	09/10 →	
122 CDI	Diesel	165	09/10 →	

GA2131
J2
GA(F) GRUPPO ASPIRAZIONE CARBURANTE
FUEL SUPPLY UNIT

FIAT
500 (312)

0.9	Petrol	63	07/10 →	
1.4 Abarth	Petrol	99	08/08 →	
1.4 Abarth	Petrol	132	08/08 →	

500 C (312)

0.9	Petrol	63	09/09 →	
-----	--------	----	---------	--

GA2131



FIAT

DUCATO Autobus (250)

140 Natural Power	Petrol/ CNG	100	04/09 →
-------------------	----------------	-----	---------

DUCATO Furgonato (250)

140 Natural Power	Petrol/ CNG	100	04/09 →
-------------------	----------------	-----	---------

IVECO

DAILY IV Autobus

35S14 G	Petrol/ CNG	100	07/09 →
---------	----------------	-----	---------

DAILY IV Cassone / Furgonato / Promiscuo

35C14 GV, 35C14 GV/P, 35S14 GV, 35S14 GV/P	Petrol/ CNG	100	07/07 →
---	----------------	-----	---------

40C14 GV, 40C14 GV/P	Petrol/ CNG	100	07/07 →
-------------------------	----------------	-----	---------

50C14 GV, 50C14 GV/P	Petrol/ CNG	100	07/07 →
-------------------------	----------------	-----	---------

DAILY IV Pianale piatto/Telaio

35C14 G, 35C14 G/P, 35S14 G, 35S14 G/P, 35C14 GD, 35S14 GD	Petrol/ CNG	100	07/07 →
---	----------------	-----	---------

40C14 G, 40C14 G/P	Petrol/ CNG	100	07/07 →
-----------------------	----------------	-----	---------

50C14 G, 50C14 G/P, 50C14 GD, 50C14 GD/P	Petrol/ CNG	100	07/07 →
--	----------------	-----	---------

65C14 G, 65C14 G/P, 65C14 GD, 65C14 GD/P	Petrol/ CNG	100	07/07 →
--	----------------	-----	---------

GA2132

J2 GA GRUPPO ASPIRAZIONE CARBURANTE FUEL SUPPLY UNIT



RENAULT

AVANTIME (DE0_)

2.0 16V Turbo (DE0U, DE0V)	Petrol	120	11/01 → 05/03
----------------------------	--------	-----	---------------

3.0 V6 (DE04, DE0T)	Petrol	152	09/01 → 05/03
---------------------	--------	-----	---------------

ESPACE III (JE0_)

2.0	Petrol	102	09/01 → 10/02
-----	--------	-----	---------------

2.0 16V (JE0N, JE0L, JE02)	Petrol	103	10/98 → 10/02
----------------------------	--------	-----	---------------

3.0 V6 24V (JE0G, JE0R)	Petrol	140	10/98 → 10/02
-------------------------	--------	-----	---------------

GA2133

J2 GA(F) GRUPPO ASPIRAZIONE CARBURANTE FUEL SUPPLY UNIT



HYUNDAI

TUCSON (JM)

2.0	Petrol	104	08/04 → 03/10
-----	--------	-----	---------------

GA2134
J2
GA(F) **GRUPPO ASPIRAZIONE CARBURANTE**
FUEL SUPPLY UNIT

VOLVO
S60 I

2.0 T	Petrol	132	07/00 → 04/10
2.4 T	Petrol	147	11/00 → 04/10
2.4 T AWD	Petrol	147	11/01 → 04/10
2.4 T5	Petrol	191	04/04 → 04/10
2.5 T	Petrol	154	02/04 → 04/10
2.5 T AWD	Petrol	154	04/04 → 04/10
R 2,5 T AWD	Petrol	221	03/03 → 04/10
T5	Petrol	184	11/00 → 04/10

V70 II (SW)

2.0 T	Petrol	132	07/01 → 08/07
2.3 T5	Petrol	184	03/00 → 08/07
2.4 T	Petrol	147	03/00 → 08/07
2.4 T AWD	Petrol	147	09/01 → 08/07
2.4 T5	Petrol	191	04/04 → 08/07
2.5 T	Petrol	154	04/04 → 08/07
2.5 T AWD	Petrol	154	09/02 → 08/07

XC70 CROSS COUNTRY

2.4 T XC AWD	Petrol	147	03/00 → 09/02
--------------	--------	-----	---------------

GA2136
J2
GA(F) **GRUPPO ASPIRAZIONE CARBURANTE**
FUEL SUPPLY UNIT

IVECO
DAILY IV Cassone / Furgonato / Promiscuo

35C10, 35S10	Diesel	70	05/06 →
35C12 V, 35C12 V/P, 35S12 V, 35S12 V/P	Diesel	85	05/06 →
35C15 V, 35C15 V/P	Diesel	107	05/06 →
35C18 V, 35C18 V/P, 35S18 V, 35S18 V/P	Diesel	130	05/06 →
35S14 C, 35S14 C/P, 35S14 V, 35S14 V/P, 35C14 V, 35C14 V/P	Diesel	100	05/06 →
50C15 V, 50C15 V/P	Diesel	107	05/06 →

DAILY IV Pianale piatto/Telaio

35C10, 35S10	Diesel	70	05/06 →
35C12, 35S12	Diesel	85	05/06 →
35C14, 35S14, 35S14 /P	Diesel	100	05/06 →
35C15	Diesel	107	05/06 →
35C18, 35S18	Diesel	130	05/06 →
50C15	Diesel	107	05/06 →

DAILY IV Ribaltabile

35C10 K	Diesel	70	05/06 →
35C12	Diesel	85	05/06 →
35C15	Diesel	107	05/06 →
35C18	Diesel	130	05/06 →
50C15	Diesel	107	05/06 →

GA2137

J2 GRUPPO ASPIRAZIONE CARBURANTE
GA(F) FUEL SUPPLY UNIT



FORD

C-MAX (DM2)

2.0 Petrol 107 02/07 →

FOCUS II (DA_)

2.0 Petrol 107 05/07 →

FOCUS II Cabriolet

2.0 Petrol 107 05/07 →

FOCUS II Tre volumi (DA_)

2.0 Petrol 107 05/07 →

GA2138

J2 GRUPPO ASPIRAZIONE CARBURANTE
GA FUEL SUPPLY UNIT



AUDI

A3 (8L1)

1.8 T Petrol 132 12/98 → 05/03

TT (8N3)

1.8 T Petrol 110 09/02 → 06/06

1.8 T Petrol 132 10/98 → 06/06

SEAT

LEON (1M1)

1.8 T Cupra R Petrol 154 02/02 → 06/06

1.8 T Cupra R Petrol 165 07/03 → 06/06

GA2140

J2 GRUPPO ASPIRAZIONE CARBURANTE
GA(F) FUEL SUPPLY UNIT



FIAT

CROMA (194)

1.9 D Multijet Diesel 110 06/05 →

1.9 D Multijet Diesel 88 06/05 →

2.4 D Multijet Diesel 147 06/05 →

GA2141

J2 GRUPPO ASPIRAZIONE CARBURANTE
GA FUEL SUPPLY UNIT



TOYOTA

AURIS (NRE15_, ZZE15_, ADE15_, ZRE15_, NDE15_)

1.4 VVTi Petrol 71 03/07 →

1.6 Petrol 97 05/09 →

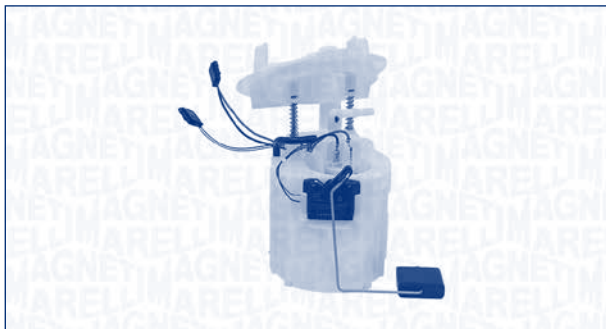
GA2142
J2
GA GRUPPO ASPIRAZIONE CARBURANTE
FUEL SUPPLY UNIT

MERCEDES-BENZ
CLASSE C (W204)

C 200 CGI (204.048)	Petrol	135	01/07 →	
------------------------	--------	-----	---------	--

C 250 CGI (204.047)	Petrol	150	07/09 →	
------------------------	--------	-----	---------	--

CLASSE C T-Model (S204)

C 250 CGI (204.247)	Petrol	150	07/09 →	
------------------------	--------	-----	---------	--

CLASSE E (W212)

E 200 CGI (212.048, 212.148)	Petrol	135	08/09 →	
------------------------------------	--------	-----	---------	--

E 250 CGI (212.047, 212.147)	Petrol	150	01/09 →	
------------------------------------	--------	-----	---------	--

CLASSE E Cabriolet (A207)

E 200 CGI (207.448)	Petrol	135	01/10 →	
------------------------	--------	-----	---------	--

E 250 CGI (207.447)	Petrol	150	01/10 →	
------------------------	--------	-----	---------	--

CLASSE E Coupé (C207)

E 200 CGI (207.348)	Petrol	135	01/10 →	
------------------------	--------	-----	---------	--

E 250 CGI (207.347)	Petrol	150	01/09 →	
------------------------	--------	-----	---------	--

CLASSE E T-Model (S212)

E 200 CGI (212.248)	Petrol	135	11/09 →	
------------------------	--------	-----	---------	--

E 250 CGI (212.247)	Petrol	150	11/09 →	
------------------------	--------	-----	---------	--

GA2143
J2
GA(F/R) GRUPPO ASPIRAZIONE CARBURANTE
FUEL SUPPLY UNIT

CITROËN
C3 II

1.1	Petrol	44	11/09 →	
-----	--------	----	---------	--

1.4	Petrol	54	11/09 →	
-----	--------	----	---------	--

GA2144
J2
GA(F/R) GRUPPO ASPIRAZIONE CARBURANTE
FUEL SUPPLY UNIT

NISSAN
MICRA IV (K13)

1.2	Petrol	59	05/10 →	
-----	--------	----	---------	--

1.2 DIG	Petrol	72	04/11 →	
---------	--------	----	---------	--

GA2145

J2 GRUPPO ASPIRAZIONE CARBURANTE
GA(F/R) FUEL SUPPLY UNIT



SUZUKI

SWIFT III (MZ, EZ)

1.5	Petrol	75	02/05 →
-----	--------	----	---------

GA2146

J2 GRUPPO ASPIRAZIONE CARBURANTE
GA FUEL SUPPLY UNIT



SKODA

FABIA (6Y2)

1.4 TDI	Diesel	55	04/03 → 03/08
1.9 TDI	Diesel	74	01/00 → 03/08

FABIA Combi (6Y5)

1.4 TDI	Diesel	55	04/03 → 12/07
1.9 TDI	Diesel	74	04/00 → 12/07

FABIA Tre volumi (6Y3)

1.4 TDI	Diesel	55	04/03 → 12/07
1.9 TDI	Diesel	74	01/00 → 12/07

GA2147

J2 GRUPPO ASPIRAZIONE CARBURANTE
GA(F/R) FUEL SUPPLY UNIT



HYUNDAI

MATRIX (FC)

1.6	Petrol	76	06/01 → 08/10
1.8	Petrol	90	06/01 → 08/10

GA2148

J2 GRUPPO ASPIRAZIONE CARBURANTE
GA(F) FUEL SUPPLY UNIT



OPEL

ASTRA H (L48)

1.8	Petrol	92	03/04 →
-----	--------	----	---------

ASTRA H GTC (L08)

1.6	Petrol	77	03/05 →
-----	--------	----	---------

ASTRA H Station wagon (L35)

1.4	Petrol	66	08/04 →
-----	--------	----	---------

ASTRA H TwinTop (L67)

1.6	Petrol	85	12/06 →
-----	--------	----	---------

GA2149
J2
GA(F) GRUPPO ASPIRAZIONE CARBURANTE
FUEL SUPPLY UNIT

MERCEDES-BENZ
VIANO (W639)

CDI 2.0	Diesel	80	09/03 →	
CDI 2.2	Diesel	110	09/03 →	
CDI 3.0	Diesel	150	03/06 →	

VITO Autobus (W639)

109 CDI	Diesel	70	09/06 →	
109 CDI	Diesel	65	09/03 →	
115 CDI	Diesel	110	09/03 →	
120 CDI	Diesel	150	07/06 →	

GA2150
J2
GA(F) GRUPPO ASPIRAZIONE CARBURANTE
FUEL SUPPLY UNIT

FIAT
DUCATO Furgonato (250)

120 Multijet 2,3 D	Diesel	88	07/06 →	
160 Multijet 3,0 D	Diesel	116	07/06 →	

GA2151
J2
GA(F) GRUPPO ASPIRAZIONE CARBURANTE
FUEL SUPPLY UNIT

SEAT
Mii (KF1_)

1.0	Petrol	44	10/11 →	
1.0	Petrol	55	10/11 →	

SKODA
CITIGO

1.0	Petrol	44	10/11 →	
1.0	Petrol	55	10/11 →	

VOLKSWAGEN
UP

1.0	Petrol	44	08/11 →	
1.0	Petrol	55	08/11 →	

GA2153
J2
GA(F) GRUPPO ASPIRAZIONE CARBURANTE
FUEL SUPPLY UNIT

NISSAN
ALMERA II (N16)

1.5	Petrol	72	10/02 →	
1.8	Petrol	85	10/02 →	

ALMERA II Hatchback (N16)

1.5	Petrol	72	10/02 →	
1.8	Petrol	85	10/02 →	

GA2154

J2 GRUPPO ASPIRAZIONE CARBURANTE
GA(F) FUEL SUPPLY UNIT



AUDI

A4 Allroad (8KH, B8)

2.0 TFSI quattro Petrol 155 04/09 →

A5 (8T3)

1.8 TFSI Petrol 118 05/09 →

1.8 TFSI Petrol 125 10/07 →

2.0 TFSI Petrol 132 11/08 →

2.0 TFSI Petrol 155 06/08 →

2.0 TFSI quattro Petrol 155 06/08 →

3.2 FSI Petrol 195 06/07 →

3.2 FSI quattro Petrol 195 06/07 →

RS 5 quattro Petrol 331 03/10 →

S5 quattro Petrol 260 06/07 →

A5 Cabriolet (8F7)

1.8 TFSI Petrol 118 09/09 →

2.0 TFSI Petrol 132 03/09 →

2.0 TFSI Petrol 155 03/09 →

2.0 TFSI quattro Petrol 155 03/09 →

3.2 FSI Petrol 195 03/09 →

3.2 FSI quattro Petrol 195 03/09 →

S5 quattro Petrol 245 06/09 →

A5 Sportback (8TA)

1.8 TFSI Petrol 118 11/09 →

2.0 TFSI Petrol 132 09/09 →

2.0 TFSI Petrol 155 09/09 →

2.0 TFSI quattro Petrol 155 09/09 →

3.2 FSI quattro Petrol 195 09/09 →

S5 quattro Petrol 245 01/10 →

GA2155

J2 GRUPPO ASPIRAZIONE CARBURANTE
GA FUEL SUPPLY UNIT



FIAT

BRAVA (182)

1.4 (182.BG) Petrol 55 10/95 → 10/01

BRAVO I (182)

1.4 (182.AG) Petrol 55 10/95 → 10/01

LANCIA

DELTA II (836)

1.4 i.e. (836AF, 836AH) Petrol 51 10/94 → 08/99

GA2156

J2 GRUPPO ASPIRAZIONE CARBURANTE
GA FUEL SUPPLY UNIT



VOLKSWAGEN

PASSAT (3C2)

1.9 TDI Diesel 77 03/05 → 11/08

2.0 TDi Diesel 103 03/05 → 05/09

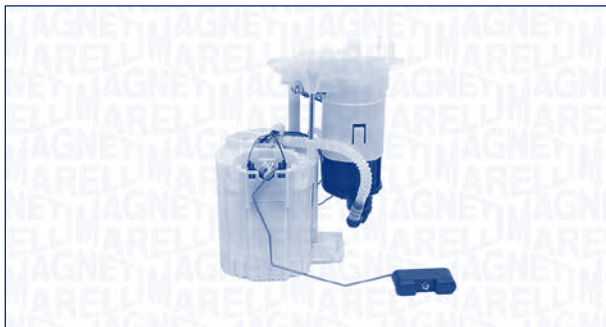
GA2157
J2 GRUPPO ASPIRAZIONE CARBURANTE
GA(F) FUEL SUPPLY UNIT

AUDI
A4 (8K2, B8)

1.8 TFSI	Petrol	118	11/07 →	
1.8 TFSI	Petrol	88	01/08 →	
1.8 TFSI quattro	Petrol	118	09/08 →	
2.0 TFSI	Petrol	132	06/08 →	
2.0 TFSI	Petrol	155	06/08 →	
2.0 TFSI quattro	Petrol	155	06/08 →	
3.2 FSI	Petrol	195	09/08 →	
3.2 FSI quattro	Petrol	195	11/07 →	
S4 quattro	Petrol	245	11/08 →	

A4 Allroad (8KH, B8)

2.0 TDI quattro	Diesel	100	09/09 →	
2.0 TDI quattro	Diesel	105	09/09 →	
2.0 TDI quattro	Diesel	120	04/09 →	
2.0 TDI quattro	Diesel	130	11/11 →	
3.0 TDI quattro	Diesel	180	01/12 →	

A4 Avant (8K5, B8)

1.8 TFSI	Petrol	118	11/07 →	
1.8 TFSI	Petrol	88	04/08 →	
1.8 TFSI quattro	Petrol	118	09/08 →	
2.0 TFSI	Petrol	132	06/08 →	
2.0 TFSI	Petrol	155	06/08 →	
2.0 TFSI quattro	Petrol	155	06/08 →	
3.2 FSI	Petrol	195	09/08 →	
3.2 FSI quattro	Petrol	195	04/08 →	
S4 quattro	Petrol	245	11/08 →	

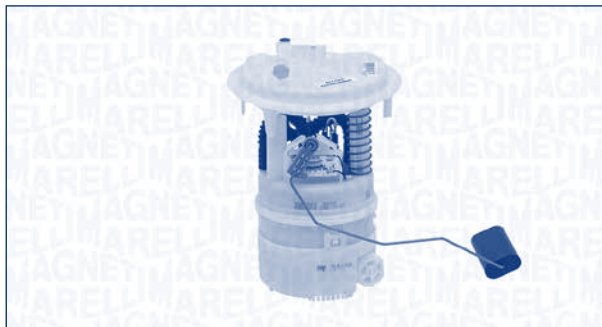
GA2158
J2 GRUPPO ASPIRAZIONE CARBURANTE
GA(F/R) FUEL SUPPLY UNIT

PEUGEOT
308 (4A_, 4C_)

1.4 16V	Petrol	70	09/07 →	
1.6 16V	Petrol	88	09/07 →	

GA2160
J2 GRUPPO ASPIRAZIONE CARBURANTE
GA(F/R) FUEL SUPPLY UNIT

PEUGEOT
205 I (741A/C)

1.6 GTI	Petrol	76	12/84 → 10/87	
1.9 GTI	Petrol	94	10/86 → 10/87	

205 I Cabriolet (741B, 20D)

1.6 CTI	Petrol	76	04/86 → 10/90	
1.9 CTI	Petrol	75	10/87 → 12/94	

205 II (20A/C)

1.6 GTI	Petrol	76	10/87 → 12/89	
1.6 GTI	Petrol	85	10/87 → 12/89	
1.9 GTI	Petrol	88	10/87 → 10/94	
1.9 GTI	Petrol	94	10/87 → 09/98	
1.9 GTI Cat.	Petrol	75	10/87 → 07/94	

GA2162

J2 GRUPPO ASPIRAZIONE CARBURANTE
GA(F/R) FUEL SUPPLY UNIT



NISSAN

QASHQAI / QASHQAI +2 (J10, JJ10)

1.6 Petrol 84 02/07 →

GA2164

J2 GRUPPO ASPIRAZIONE CARBURANTE
GA(F) FUEL SUPPLY UNIT



OPEL

ZAFIRA B (A05)

1.6 Petrol 77 07/05 →

1.8 Petrol 103 07/05 →

GA2165

J2 GRUPPO ASPIRAZIONE CARBURANTE
GA FUEL SUPPLY UNIT



MERCEDES-BENZ

CLASSE E (W212)

E 200 CDI / BlueTEC (212.005, 212.006) Diesel 100 01/09 →

E 220 CDI / BlueTEC (212.001, 212.002) Diesel 125 01/09 →

E 250 CDI / BlueTEC (212.003, 212.004) Diesel 150 01/09 →

E 350 BlueTEC (212.024) Diesel 155 01/09 →

E 350 CDI (212.025) Diesel 170 01/09 →

E 350 CDI 4-matic (212.089) Diesel 170 09/09 →

CLASSE E T-Model (S212)

E 200 CDI / BlueTEC (212.205, 212.206) Diesel 100 11/09 →

E 220 CDI / BlueTEC (212.202, 212.201) Diesel 125 11/09 →

E 250 CDI / BlueTEC (212.203, 212.204) Diesel 150 11/09 →

E 350 BlueTEC (212.224) Diesel 155 11/09 →

E 350 CDI (212.225) Diesel 170 11/09 →

E 350 CDI 4-matic (212.289) Diesel 170 11/09 →

GA2166
J2 **GRUPPO ASPIRAZIONE CARBURANTE**
GA **FUEL SUPPLY UNIT**

MERCEDES-BENZ
CLASSE E (W212)

E 200 CDI / BlueTEC (212.005, 212.006)	Diesel	100	01/09 →	
E 220 CDI / BlueTEC (212.001, 212.002)	Diesel	125	01/09 →	
E 250 CDI / BlueTEC (212.003, 212.004)	Diesel	150	01/09 →	
E 350 BlueTEC (212.024)	Diesel	155	01/09 →	
E 350 CDI (212.025)	Diesel	170	01/09 →	
E 350 CDI 4-matic (212.089)	Diesel	170	09/09 →	

CLASSE E T-Model (S212)

E 200 CDI / BlueTEC (212.205, 212.206)	Diesel	100	11/09 →	
E 220 CDI / BlueTEC (212.202, 212.201)	Diesel	125	11/09 →	
E 250 CDI / BlueTEC (212.203, 212.204)	Diesel	150	11/09 →	
E 350 BlueTEC (212.224)	Diesel	155	11/09 →	
E 350 CDI (212.225)	Diesel	170	11/09 →	
E 350 CDI 4-matic (212.289)	Diesel	170	11/09 →	

GA2167
J2 **GRUPPO ASPIRAZIONE CARBURANTE**
GA **FUEL SUPPLY UNIT**

MERCEDES-BENZ
CLASSE E (W212)

E 200 CDI / BlueTEC (212.005, 212.006)	Diesel	100	01/09 →	
E 220 CDI / BlueTEC (212.001, 212.002)	Diesel	125	01/09 →	
E 250 CDI / BlueTEC (212.003, 212.004)	Diesel	150	01/09 →	
E 350 BlueTEC (212.024)	Diesel	155	01/09 →	
E 350 CDI (212.025)	Diesel	170	01/09 →	
E 350 CDI 4-matic (212.089)	Diesel	170	09/09 →	

CLASSE E T-Model (S212)

E 200 CDI / BlueTEC (212.205, 212.206)	Diesel	100	11/09 →	
E 220 CDI / BlueTEC (212.202, 212.201)	Diesel	125	11/09 →	
E 250 CDI / BlueTEC (212.203, 212.204)	Diesel	150	11/09 →	
E 350 BlueTEC (212.224)	Diesel	155	11/09 →	
E 350 CDI (212.225)	Diesel	170	11/09 →	
E 350 CDI 4-matic (212.289)	Diesel	170	11/09 →	

GA2168

J2 GRUPPO ASPIRAZIONE CARBURANTE
GA FUEL SUPPLY UNIT



MERCEDES-BENZ

CLASSE E (W212)

E 200 CDI / BlueTEC (212.005, 212.006)	Diesel	100	01/09 →	
E 220 CDI / BlueTEC (212.001, 212.002)	Diesel	125	01/09 →	
E 250 CDI / BlueTEC (212.003, 212.004)	Diesel	150	01/09 →	
E 350 BlueTEC (212.024)	Diesel	155	01/09 →	
E 350 CDI (212.025)	Diesel	170	01/09 →	
E 350 CDI 4-matic (212.089)	Diesel	170	09/09 →	

CLASSE E T-Model (S212)

E 200 CDI / BlueTEC (212.205, 212.206)	Diesel	100	11/09 →	
E 220 CDI / BlueTEC (212.202, 212.201)	Diesel	125	11/09 →	
E 250 CDI / BlueTEC (212.203, 212.204)	Diesel	150	11/09 →	
E 350 BlueTEC (212.224)	Diesel	155	11/09 →	
E 350 CDI (212.225)	Diesel	170	11/09 →	
E 350 CDI 4-matic (212.289)	Diesel	170	11/09 →	

GA2169

J2 GRUPPO ASPIRAZIONE CARBURANTE
GA(F) FUEL SUPPLY UNIT



IVECO

DAILY IV Cassone / Furgonato / Promiscuo

29L12 V, 29L12 V/P	Diesel	85	05/06 →	
29L14 C, 9L14 C/P, 29L14 V, 29L14 V/P	Diesel	100	05/06 →	
40C10 V	Diesel	70	05/06 →	
40C12 V, 40C14 V/P	Diesel	85	05/06 →	
40C15 V, 40C15 V/P	Diesel	107	05/06 →	
40C18 V, 40C18 V/P	Diesel	130	05/06 →	
45C15 V	Diesel	107	05/06 →	
45C18	Diesel	130	05/06 →	
50C18 V, 50C18 V/P	Diesel	130	05/06 →	
60C15 V	Diesel	107	05/06 →	
60C18	Diesel	130	05/06 →	

DAILY IV Pianale piatto/Telaio

29L10	Diesel	70	05/06 →	
29L12	Diesel	85	05/06 →	
29L14	Diesel	100	05/06 →	
40C10	Diesel	70	05/06 →	
40C12	Diesel	85	05/06 →	
40C15	Diesel	107	05/06 →	
40C18	Diesel	130	05/06 →	
45C15	Diesel	107	05/06 →	
45C18, 45C18 /P, 45C18 D, 45C18 D/P	Diesel	130	05/06 →	
50C18	Diesel	130	05/06 →	

GA2169

IVECO
DAILY IV Pianale piatto/Telaio

60C15, 60C15/P, 60C15 D, 60C15 D/P	Diesel	107	05/06 →
--	--------	-----	---------

60C18	Diesel	130	05/06 →
-------	--------	-----	---------

DAILY IV Ribaltabile

50C18	Diesel	130	05/06 →
-------	--------	-----	---------

60C15	Diesel	107	05/06 →
-------	--------	-----	---------

60C18	Diesel	130	05/06 →
-------	--------	-----	---------

GA2171
**J2
GA GRUPPO ASPIRAZIONE CARBURANTE
FUEL SUPPLY UNIT**

VOLKSWAGEN
PASSAT (3B3)

1.6	Petrol	75	11/00 → 05/05
-----	--------	----	---------------

1.8 T 20V	Petrol	110	11/00 → 05/05
-----------	--------	-----	---------------

2.0	Petrol	85	11/00 → 05/05
-----	--------	----	---------------

2.0	Petrol	96	11/01 → 05/05
-----	--------	----	---------------

2.0 4motion	Petrol	85	11/00 → 05/05
-------------	--------	----	---------------

2.3 V5	Petrol	125	11/00 → 05/05
--------	--------	-----	---------------

2.3 V5 4motion	Petrol	125	11/00 → 05/05
----------------	--------	-----	---------------

2.8 4motion	Petrol	142	11/00 → 05/05
-------------	--------	-----	---------------

4.0 W8 4motion	Petrol	202	09/01 → 09/04
----------------	--------	-----	---------------

PASSAT Variant (3B6)

1.6	Petrol	75	11/00 → 05/05
-----	--------	----	---------------

1.8 T 20V	Petrol	110	11/00 → 05/05
-----------	--------	-----	---------------

2.0	Petrol	85	11/00 → 05/05
-----	--------	----	---------------

2.0	Petrol	96	11/01 → 05/05
-----	--------	----	---------------

2.0 4motion	Petrol	85	11/00 → 05/05
-------------	--------	----	---------------

2.3 VR5	Petrol	125	11/00 → 05/05
---------	--------	-----	---------------

2.3 VR5 4motion	Petrol	125	11/00 → 05/05
-----------------	--------	-----	---------------

2.8 4motion	Petrol	142	11/00 → 05/05
-------------	--------	-----	---------------

4.0 W8 4motion	Petrol	202	09/01 → 09/04
----------------	--------	-----	---------------

GA2172
**J2
GA(F) GRUPPO ASPIRAZIONE CARBURANTE
FUEL SUPPLY UNIT**

OPEL
INSIGNIA

2.0 Biturbo CDTi	Diesel	140	07/08 →
------------------	--------	-----	---------

2.0 CDTi	Diesel	118	07/08 →
----------	--------	-----	---------

2.0 CDTi	Diesel	81	07/08 →
----------	--------	----	---------

2.0 CDTi	Diesel	96	07/08 →
----------	--------	----	---------

INSIGNIA Sports Tourer

2.0 Biturbo CDTi	Diesel	140	07/08 →
------------------	--------	-----	---------

2.0 CDTi	Diesel	118	07/08 →
----------	--------	-----	---------

2.0 CDTi	Diesel	81	07/08 →
----------	--------	----	---------

2.0 CDTi	Diesel	96	07/08 →
----------	--------	----	---------

INSIGNIA Tre volumi

2.0 Biturbo CDTi	Diesel	140	07/08 →
------------------	--------	-----	---------

2.0 CDTi	Diesel	118	07/08 →
----------	--------	-----	---------

2.0 CDTi	Diesel	81	07/08 →
----------	--------	----	---------

2.0 CDTi	Diesel	96	07/08 →
----------	--------	----	---------

GA2173
**J2
GA(F/R) GRUPPO ASPIRAZIONE CARBURANTE
FUEL SUPPLY UNIT**

RENAULT
LAGUNA II (BG0/1_)

1.6 16V (BG0A, BG0L)	Petrol	79	03/01 →
-------------------------	--------	----	---------

GA2173



RENAULT

LAGUNA II (BG0/1_)

1.6 16V (BG1G, BG1H) Petrol 82 02/05 →

1.8 16V (BG06, BG0J, BG0M) Petrol 85 03/01 →

1.8 16V (BG0B, BG0C, BG0J, BG0M, BG0V) Petrol 89 03/01 →

1.8 16V (BG0B, BG0M) Petrol 88 03/01 →

2.0 16V (BG00, BG0K, BG0P, BG0W) Petrol 99 08/02 →

2.0 16V Turbo (BG0S, BG0Z, BG1L, BG1M) Petrol 120 01/03 →

3.0 V6 24V (BG01, BG02, BG0D, BG0Y) Petrol 152 03/01 →

LAGUNA II Grandtour (KG0/1_)

1.6 16V Petrol 82 02/05 →

1.6 16V (KG0A, KG0L) Petrol 79 03/01 →

1.8 16V Petrol 89 03/01 →

1.8 16V (KG0B, KG0M) Petrol 88 03/01 →

1.8 16V (KG0J) Petrol 85 03/01 →

2.0 16V (KG00, KG0K, KG0W) Petrol 99 08/02 →

2.0 16V Turbo (KG0S, KG0Z, KG1L, KG1M) Petrol 120 01/03 →

3.0 V6 24V (KG0D) Petrol 152 03/01 →

GA2174

**J2 GRUPPO ASPIRAZIONE CARBURANTE
GA(F/R) FUEL SUPPLY UNIT**



FIAT

FIORINO Cassone / Furgonato / Promiscuo (225)

1.3 D Multijet Diesel 55 11/07 →

QUBO (225)

1.3 D Multijet Diesel 55 02/08 →

GA2176

**J2 GRUPPO ASPIRAZIONE CARBURANTE
GA(F) FUEL SUPPLY UNIT**



ALFA ROMEO

MITO (955)

1.4 Petrol 51 05/11 →

FIAT

PUNTO EVO (199)

1.2 Petrol 48 10/09 → 02/12

1.2 Petrol 51 10/09 → 02/12

1.4 Petrol 57 10/09 → 02/12

1.4 LPG Petrol/LPG 57 06/09 → 02/12

1.4 Natural Power BiFuel 57 10/09 → 02/12

PUNTO EVO Furgonato (199)

1.4 Petrol 57 03/09 →

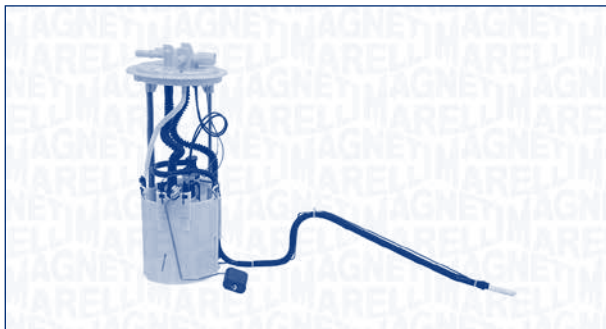
GA2177
J2
GA(F) **GRUPPO ASPIRAZIONE CARBURANTE**
FUEL SUPPLY UNIT

MERCEDES-BENZ
SPRINTER 3,5-t Autobus (906)

 311 CDI (906.731,
906.733, 906.735) Diesel 80 06/06 →

 315 CDI (906.731,
906.733, 906.735) Diesel 110 06/06 →

SPRINTER 3,5-t Furgonato (906)

 309 CDI (906.631, 906.633,
906.635, 906.637) Diesel 65 06/06 →

 311 CDI (906.631, 906.633,
906.635, 906.637) Diesel 80 06/06 →

 315 CDI (906.631, 906.633,
906.635, 906.637) Diesel 110 06/06 →

 318 CDI (906.631, 906.633,
906.635, 906.637) Diesel 135 06/06 →

SPRINTER 3,5-t Pianale piatto/Telaio (906)

 309 CDI (906.131, 906.133,
906.135, 906.231,
906.233...) Diesel 65 06/06 →

 311 CDI (906.131, 906.133,
906.135, 906.231,
906.233...) Diesel 80 06/06 →

 315 CDI (906.131, 906.133,
906.135, 906.231,
906.233...) Diesel 110 06/06 →

GA2177

MERCEDES-BENZ
SPRINTER 3,5-t Pianale piatto/Telaio (906)

 318 CDI (906.131, 906.133,
906.135, 906.231,
906.233...) Diesel 135 06/06 →

SPRINTER 3-t Autobus (906)

 211 CDI (906.711,
906.713) Diesel 80 06/06 →

 215 CDI (906.711,
906.713) Diesel 110 06/06 →

SPRINTER 3-t Furgonato (906)

 209 CDI (906.611,
906.613) Diesel 65 06/06 →

 211 CDI (906.611,
906.613) Diesel 80 06/06 →

 213 CDI (906.611,
906.613) Diesel 95 06/06 →

 215 CDI (906.611,
906.613) Diesel 110 06/06 →

 218 CDI (906.611,
906.613) Diesel 135 06/06 →

SPRINTER 3-t Pianale piatto/Telaio (906)

 209 CDI (906.111,
906.113, 906.211,
906.213) Diesel 65 06/06 →

 211 CDI (906.111,
906.113, 906.211,
906.213) Diesel 80 06/06 →

 213 CDI (906.111,
906.113, 906.211,
906.213) Diesel 95 06/06 →

 215 CDI (906.111,
906.113, 906.211,
906.213) Diesel 110 06/06 →

 218 CDI (906.111,
906.113, 906.211,
906.213) Diesel 135 06/06 →

SPRINTER 5-t Furgonato (906)

 509 CDI (906.653,
906.655, 906.657) Diesel 65 06/06 →

 511 CDI (906.653,
906.655, 906.657) Diesel 80 06/06 →

 515 CDI (906.653,
906.655, 906.657) Diesel 110 06/06 →

GA2177



MERCEDES-BENZ

SPRINTER 5-t Furgonato (906)

518 CDI (906.653, 906.655, 906.657) Diesel 135 06/06 →

SPRINTER 5-t Pianale piatto/Telaio (906)

509 CDI (906.153, 906.155, 906.253, 906.255) Diesel 65 06/06 →

511 CDI (906.153, 906.155, 906.253, 906.255) Diesel 80 06/06 →

515 CDI (906.153, 906.155, 906.253, 906.255) Diesel 110 06/06 →

518 CDI (906.153, 906.155, 906.253, 906.255) Diesel 135 06/06 →

GA2178

J2 GRUPPO ASPIRAZIONE CARBURANTE FUEL SUPPLY UNIT



VOLKSWAGEN

GOLF PLUS (5M1, 521)

1.6 FSI Petrol 85 01/05 → 05/08

GOLF V (1K1)

1.6 FSI Petrol 85 10/03 → 07/08

GA2179

J2 GRUPPO ASPIRAZIONE CARBURANTE FUEL SUPPLY UNIT



RENAULT

TWINGO II (CN0_)

1.2 16V (CN0K, CN0V) Petrol 56 03/07 →

GA2180

J2 GRUPPO ASPIRAZIONE CARBURANTE FUEL SUPPLY UNIT



OPEL

ASTRA H (L48)

1.3 CDTI Diesel 66 08/05 →

1.9 CDTI Diesel 88 06/04 →

1.9 CDTI 16V Diesel 88 04/04 →

ASTRA H GTC (L08)

1.3 CDTI Diesel 66 04/05 →

ASTRA H Station wagon (L35)

1.3 CDTI Diesel 66 08/05 →

1.9 CDTI Diesel 88 09/05 →

1.9 CDTI 16V Diesel 88 08/04 →

VAUXHALL

ASTRA Mk V (H) 2 volumi /Coda spiovente

1.3 CDTI Diesel 66 01/04 → 05/09

ASTRA Mk V (H) Station wagon

1.3 CDTI Diesel 66 08/04 → 03/09

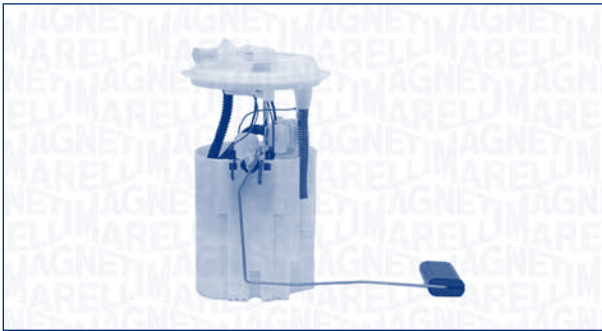
GA2181
J2
GA(F) **GRUPPO ASPIRAZIONE CARBURANTE**
FUEL SUPPLY UNIT

RENAULT
FLUENCE (L30_)

1.6 16V (L301, L30F, L30P, L30R)	Petrol	81	02/10 →
2.0 16V (L30C, L30G, L30T, L30V)	Petrol	103	02/10 →

GRAND SCÉNIC III (JZ0/1_)

1.4 16V (JZ0F)	Petrol	96	02/09 →
1.6 16V (JZ0U)	Petrol	81	02/09 →
2.0 16V (JZ0G)	Petrol	103	02/09 →

MEGANE III 2 volumi /Coda spiovente (BZ0_)

1.4 TCe (BZ0F, BZ1V)	Petrol	96	04/09 →
1.6 16V (BZ0H)	Petrol	74	11/08 →
1.6 16V (BZ1B, BZ1H)	Petrol	81	11/08 →
1.6 16V Bifuel (BZ03)	BiFuel	81	11/08 →
2.0 CVT (BZ0G, BZ1P)	Petrol	103	02/09 →

MEGANE III Coupé (DZ0/1_)

1.4 TCe (DZ0F, DZ1V)	Petrol	96	04/09 →
1.6 16V (DZ0H)	Petrol	74	11/08 →
1.6 16V (DZ0U, DZ1B, DZ1H)	Petrol	81	11/08 →
1.6 16V Bifuel (DZ03, DZ1Y)	BiFuel	81	11/08 →
2.0 CVT (DZ0G, DZ1E)	Petrol	103	05/09 →

MEGANE III Grandtour (KZ0/1)

1.4 TCe (KZ0F, KZ1V)	Petrol	96	05/09 →
1.6 16V (KZ0H)	Petrol	74	05/09 →

GA2181

RENAULT
MEGANE III Grandtour (KZ0/1)

1.6 16V (KZ0U, KZ1B, KZ1U)	Petrol	81	05/09 →
1.6 16V Bifuel (KZ03)	BiFuel	81	11/08 →
2.0 CVT (KZ0G, KZ1P)	Petrol	103	05/09 →

SCÉNIC III (JZ0/1_)

1.4 16V (JZ0F)	Petrol	96	02/09 →
2.0 16V (JZ0G, JZ1E)	Petrol	103	02/09 →

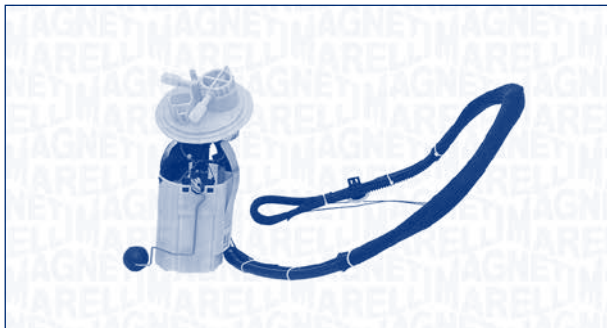
GA2182
J2
GA(F) **GRUPPO ASPIRAZIONE CARBURANTE**
FUEL SUPPLY UNIT

VOLVO
S60 I

2.4 D	Diesel	96	12/01 → 04/10
2.4 D5	Diesel	120	07/01 → 04/10

S80 I (TS, XY)

2.4 D	Diesel	96	10/01 → 07/06
2.4 D5	Diesel	120	08/01 → 07/06

V70 II (SW)

2.4 D	Diesel	96	12/01 → 08/07
2.4 D5	Diesel	120	08/01 → 08/07
2.4 D5 AWD	Diesel	120	03/03 → 08/07

XC70 CROSS COUNTRY

2.4 D5 AWD	Diesel	136	12/05 → 08/07
2.4 D5 XC AWD	Diesel	120	09/02 → 08/07

XC90 I

D5	Diesel	120	10/02 →
----	--------	-----	---------

GA2183

J2 GRUPPO ASPIRAZIONE CARBURANTE
GA(F) FUEL SUPPLY UNIT



VOLKSWAGEN

TIGUAN (5N_)

2.0 TDI 4motion	Diesel	103	09/07 →
2.0 TDI 4motion	Diesel	125	09/07 →

GA2184

J2 GRUPPO ASPIRAZIONE CARBURANTE
GA(F/R) FUEL SUPPLY UNIT



CITROËN

AX (ZA-_)

10	Petrol	37	02/87 → 12/98
10	Petrol	33	07/86 → 12/98
11	Petrol	44	09/86 → 12/97
14	Petrol	55	04/87 → 04/97
1.4 GTi	Petrol	74	06/91 → 12/92
14 4x4	Petrol	55	08/91 → 12/96

PEUGEOT

205 I Cabriolet (741B, 20D)

1.1 CJ	Petrol	44	10/89 → 12/94
1.4 CJ	Petrol	55	05/91 → 12/94
1.6 CJ	Petrol	65	08/92 → 12/94

205 II (20A/C)

1.0	Petrol	33	10/87 → 09/98
1.1	Petrol	44	07/89 → 09/98

GA2184



PEUGEOT

205 II (20A/C)

1.4	Petrol	55	07/88 → 09/98
1.6 Aut.	Petrol	65	05/90 → 09/98

GA2185

J2 GRUPPO ASPIRAZIONE CARBURANTE
GA FUEL SUPPLY UNIT



SKODA

FABIA (6Y2)

1.9 SDI	Diesel	47	12/99 → 03/08
---------	--------	----	---------------

VOLKSWAGEN

POLO (9N_)

1.4 TDI	Diesel	55	10/01 → 06/05
1.9 TDI	Diesel	74	10/01 → 11/09

GA2186

J2 GRUPPO ASPIRAZIONE CARBURANTE
GA FUEL SUPPLY UNIT



VOLKSWAGEN

PASSAT (3C2)

2.0 TDI 16V	Diesel	103	03/05 → 07/10
2.0 TDI 16V 4motion	Diesel	103	03/05 → 08/10

GA2187
J2 GRUPPO ASPIRAZIONE CARBURANTE
GA(F/R) FUEL SUPPLY UNIT

KW

RENAULT
MODUS / GRAND MODUS (F/JP0_)

1.2 (JP0S) Petrol 58 12/04 →

1.2 16V (JP0W) Petrol 74 05/07 →

GA2188
J2 GRUPPO ASPIRAZIONE CARBURANTE
GA(F) FUEL SUPPLY UNIT

KW

OPEL
ZAFIRA B (A05)

1.9 CDTI Diesel 110 07/05 →

1.9 CDTI Diesel 74 07/05 →

1.9 CDTI Diesel 88 07/05 →

VAUXHALL
ZAFIRA Mk II (B) (M75)

1.9 CDTI Diesel 88 07/05 →

1.9 CDTI Diesel 110 07/05 →

GA2189
J2 GRUPPO ASPIRAZIONE CARBURANTE
GA(F/R) FUEL SUPPLY UNIT

KW

HYUNDAI
i30 (FD)

1.4 Petrol 80 10/07 → 11/11

1.4 Petrol 77 10/07 → 11/11

1.6 Petrol 90 10/07 → 11/11

1.6 Petrol 85 10/07 → 11/11

1.6 Petrol 93 02/08 → 11/11

i30 CW (FD)

1.4 Petrol 77 10/07 → 06/12

1.4 Petrol 80 11/09 → 06/12

1.6 Petrol 90 02/08 → 06/12

1.6 Petrol 93 02/08 → 06/12

KIA
CEE'D 2 volumi /Coda spiovente (ED)

1.4 Petrol 80 12/06 →

1.4 Petrol 77 12/06 →

1.6 Petrol 93 02/08 →

CEE'D SW (ED)

1.4 Petrol 80 09/07 →

1.6 Petrol 90 09/07 →

1.6 Petrol 85 09/07 →

1.6 Petrol 93 09/07 →

CERATO (LD)

1.6 Petrol 77 07/04 →

GA2190

J2 GRUPPO ASPIRAZIONE CARBURANTE
GA(F) FUEL SUPPLY UNIT



MERCEDES-BENZ

CLASSE C (W203)

C 200 CDI Diesel 75 02/01 → 02/07

C 200 CDI (203.007) Diesel 90 04/03 → 02/07

C 220 CDI (203.008) Diesel 110 02/03 → 02/07

C 320 CDI (203.020) Diesel 165 01/05 → 02/07

CLASSE C Sportcoupe (CL203)

C 200 CDI (203.707) Diesel 90 03/03 → 05/08

C 220 CDI (203.708) Diesel 110 02/04 → 05/08

CLASSE C T-Model (S203)

C 200 CDI (203.204, 203.207) Diesel 75 03/01 → 08/07

C 200 CDI (203.207) Diesel 90 04/03 → 08/07

C 220 CDI (203.208) Diesel 110 02/04 → 08/07

C 320 CDI (203.220) Diesel 165 06/05 → 08/07

CLASSE CLC (CL203)

CLC 200 CDI (203.707) Diesel 90 05/08 → 06/11

CLC 220 CDI (203.708) Diesel 110 05/08 → 06/11

CLK (C209)

220 CDI (209.308) Diesel 110 01/05 → 05/09

320 CDI (209.320) Diesel 165 01/05 → 05/09

CLK Cabriolet (A209)

CLK 320 CDI (209.420) Diesel 165 03/05 → 03/10

GA2191

J2 GRUPPO ASPIRAZIONE CARBURANTE
GA(F) FUEL SUPPLY UNIT



FIAT

BRAVO II (198)

1.6 D Multijet Diesel 77 03/08 →

1.6 D Multijet Diesel 88 03/08 →

1.9 D Multijet Diesel 110 04/07 →

1.9 D Multijet Diesel 88 04/07 →

STILO (192)

1.9 D Multijet Diesel 110 09/05 → 11/06

1.9 D Multijet Diesel 88 09/05 → 11/06

1.9 JTD Diesel 103 01/04 → 11/06

1.9 JTD (192_XE1A) Diesel 85 10/01 → 11/06

STILO Multi Wagon (192)

1.9 D Multijet Diesel 110 09/05 → 08/08

1.9 D Multijet Diesel 88 09/05 → 08/08

1.9 JTD Diesel 103 01/04 → 08/08

GA2193

J2 GRUPPO ASPIRAZIONE CARBURANTE
GA(F/R) FUEL SUPPLY UNIT



CITROËN

ZX (N2)

1.1 Petrol 44 03/91 → 06/97

1.4 Petrol 55 03/91 → 06/97

GA2193

CITROËN
ZX (N2)

1.4 i	Petrol	55	03/91 → 06/97
1.6 i	Petrol	65	03/91 → 06/97

ZX Break (N2)

1.4 i	Petrol	55	10/93 → 10/97
-------	--------	----	---------------

PEUGEOT
306 (7B, N3, N5)

1.1	Petrol	44	06/94 → 05/01
1.4 SL	Petrol	55	06/94 → 05/01

306 2 volumi /Coda spiovente (7A, 7C, N3, N5)

1.1	Petrol	44	05/93 → 05/01
1.4	Petrol	55	05/93 → 05/01

RANCH MPV / Space wagon (5F)

1.1	Petrol	44	06/96 →
-----	--------	----	---------

GA2194
**J2
GA(F) GRUPPO ASPIRAZIONE CARBURANTE
FUEL SUPPLY UNIT**

NISSAN
ALMERA TINO (V10)

1.8	Petrol	84	08/00 →
1.8	Petrol	85	12/02 →

PRIMERA (P12)

1.6	Petrol	78	03/02 →
1.6	Petrol	80	01/02 →
1.8	Petrol	85	03/02 →
2.0	Petrol	103	03/02 →

PRIMERA Hatchback (P12)

1.6	Petrol	78	07/02 →
1.6	Petrol	80	07/02 →
1.8	Petrol	85	07/02 →
2.0	Petrol	103	07/02 →

GA2194

NISSAN
PRIMERA Station wagon (WP12)

1.6 Visia	Petrol	80	01/02 →
1.8	Petrol	85	03/02 →
2.0	Petrol	103	03/02 →

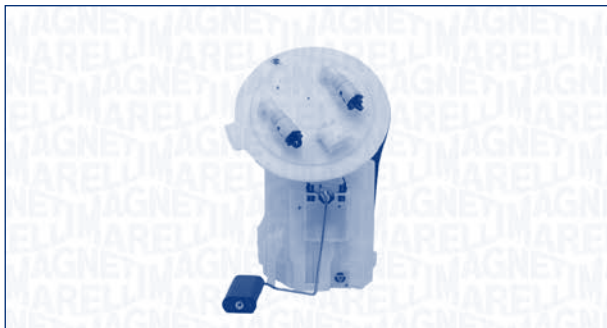
GA2195
**J2
GA(F) GRUPPO ASPIRAZIONE CARBURANTE
FUEL SUPPLY UNIT**

OPEL
ASTRA H (L48)

1.9 CDTI	Diesel	110	09/04 →
1.9 CDTI	Diesel	74	09/05 →

ASTRA H GTC (L08)

1.9 CDTI	Diesel	110	03/05 →
1.9 CDTI	Diesel	74	01/06 →
1.9 CDTI	Diesel	88	09/05 →
1.9 CDTI 16V	Diesel	88	03/05 →

ASTRA H Station wagon (L35)

1.9 CDTI	Diesel	110	09/04 →
1.9 CDTI	Diesel	74	09/05 →

ASTRA H TwinTop (L67)

1.9 CDTI	Diesel	110	09/05 →
----------	--------	-----	---------

VAUXHALL
ASTRA Mk V (H) 2 volumi /Coda spiovente

1.9 CDTI	Diesel	110	01/04 → 05/09
1.9 CDTI	Diesel	88	01/04 → 05/09

ASTRA Mk V (H) Sport Hatch

1.9 CDTI	Diesel	110	02/05 → 11/10
1.9 CDTI	Diesel	88	02/05 → 11/10

ASTRA Mk V (H) Station wagon

1.9 CDTI	Diesel	110	08/04 → 03/09
1.9 CDTI	Diesel	88	08/04 → 03/09

GA2196

J2 GRUPPO ASPIRAZIONE CARBURANTE
GA(F/R) FUEL SUPPLY UNIT



MITSUBISHI

COLT VI (Z3_A, Z2_A)

1.1	Petrol	55	10/04 → 06/12
1.3	Petrol	70	06/04 → 06/12
1.5	Petrol	80	06/04 → 06/12

SMART

FORFOUR (454)

1.1 (454.030)	Petrol	55	01/04 → 06/06
1.3 (454.031)	Petrol	70	01/04 → 06/06
1.5 (454.032)	Petrol	80	01/04 → 06/06

GA2197

J2 GRUPPO ASPIRAZIONE CARBURANTE
GA(F) FUEL SUPPLY UNIT



OPEL

CORSA B (73_, 78_, 79_)

1.2 i	Petrol	33	03/93 → 09/00
1.4 i	Petrol	44	03/93 → 09/00
1.6 i 16V	Petrol	78	09/94 → 09/00

GA2198

J2 GRUPPO ASPIRAZIONE CARBURANTE
GA(F/R) FUEL SUPPLY UNIT



CITROËN

C2 (JM_)

1.1	Petrol	44	09/03 →
1.4	Petrol	54	09/03 →
1.4 16V	Petrol	65	06/06 →
1.6	Petrol	80	09/03 →
1.6 VTS	Petrol	90	01/05 →

PEUGEOT

1007 (KM_)

1.4	Petrol	54	04/05 →
1.4 16V	Petrol	65	10/05 →
1.6 16V	Petrol	80	04/05 →

GA2199

J2 GRUPPO ASPIRAZIONE CARBURANTE
GA(F) FUEL SUPPLY UNIT



HYUNDAI

i20 (PB, PBT)

1.6 CRDi	Diesel	85	09/08 →
----------	--------	----	---------

MERCEDES-BENZ

SPRINTER 3,5-t Autobus (906)

311 CDI 4x4 (906.731, 906.733, 906.735)	Diesel	80	02/08 →
---	--------	----	---------

GA2193

MERCEDES-BENZ
SPRINTER 3,5-t Autobus (906)

318 CDI 4x4 (906.731, 906.733, 906.735)	Diesel	135	02/08 →
---	--------	-----	---------

SPRINTER 3,5-t Furgonato (906)

311 CDI 4x4 (906.631, 906.633, 906.635, 906.637)	Diesel	80	02/08 →
--	--------	----	---------

318 CDI 4x4 (906.631, 906.633, 906.635, 906.637)	Diesel	135	02/08 →
--	--------	-----	---------

SPRINTER 3,5-t Pianale piatto/Telaio (906)

311 CDI 4x4 (906.131, 906.133, 906.135, 906.231...)	Diesel	80	02/08 →
---	--------	----	---------

318 CDI 4x4 (906.131, 906.133, 906.135, 906.231...)	Diesel	135	02/08 →
---	--------	-----	---------

GA2200
**J2
GA(F) GRUPPO ASPIRAZIONE CARBURANTE
FUEL SUPPLY UNIT**

MERCEDES-BENZ
SPRINTER 3,5-t Autobus (906)

310 CDI (906.731, 906.733, 906.735)	Diesel	70	03/09 →
--	--------	----	---------

315 CDI 4x4 (906.731, 906.733, 906.735)	Diesel	110	02/08 →
---	--------	-----	---------

SPRINTER 3,5-t Furgonato (906)

310 CDI (906.631, 906.633, 906.635, 906.637)	Diesel	70	03/09 →
--	--------	----	---------

GA2200

MERCEDES-BENZ
SPRINTER 3,5-t Furgonato (906)

313 CDI (906.631, 906.633, 906.635, 906.637)	Diesel	95	06/06 →
--	--------	----	---------

315 CDI 4x4 (906.631, 906.633, 906.635, 906.637)	Diesel	110	02/08 →
--	--------	-----	---------

316 CDI (906.631, 906.633, 906.635, 906.637)	Diesel	120	03/09 →
--	--------	-----	---------

316 CDI 4x4 (906.631, 906.633, 906.635, 906.637)	Diesel	120	03/09 →
--	--------	-----	---------

SPRINTER 3,5-t Pianale piatto/Telaio (906)

310 CDI (906.131, 906.133, 906.135, 906.231, 906.233...)	Diesel	70	03/09 →
---	--------	----	---------

313 CDI (906.131, 906.133, 906.135, 906.231, 906.233...)	Diesel	95	06/06 →
---	--------	----	---------

315 CDI 4x4 (906.131, 906.133, 906.135, 906.231...)	Diesel	110	02/08 →
--	--------	-----	---------

316 CDI (906.131, 906.133, 906.135, 906.231, 906.233...)	Diesel	120	03/09 →
---	--------	-----	---------

316 CDI 4x4 (906.131, 906.133, 906.135, 906.231...)	Diesel	120	03/09 →
--	--------	-----	---------

SPRINTER 3-t Autobus (906)

210 CDI (906.711, 906.713)	Diesel	70	03/09 →
-------------------------------	--------	----	---------

SPRINTER 3-t Furgonato (906)

210 CDI (906.611, 906.613)	Diesel	70	03/09 →
-------------------------------	--------	----	---------

216 CDI (906.611, 906.613)	Diesel	120	03/09 →
-------------------------------	--------	-----	---------

GA2200



MERCEDES-BENZ

SPRINTER 3-t Pianale piatto/Telaio (906)

210 CDI (906.111, 906.113, 906.211, 906.213)	Diesel	70	03/09 →
--	--------	----	---------

213 CDI (906.111, 906.113, 906.211, 906.213)	Diesel	95	03/09 →
--	--------	----	---------

216 CDI (906.111, 906.113, 906.211, 906.213)	Diesel	120	03/09 →
--	--------	-----	---------

SPRINTER 4,6-t Pianale piatto/Telaio (906)

415 CDI (906.153, 906.155, 906.253, 906.255)	Diesel	110	06/06 →
--	--------	-----	---------

416 CDI (906.153, 906.155, 906.253, 906.255)	Diesel	120	03/09 →
--	--------	-----	---------

418 CDI (906.153, 906.155, 906.253, 906.255)	Diesel	135	06/06 →
--	--------	-----	---------

SPRINTER 5-t Furgonato (906)

510 CDI (906.653, 906.655, 906.657)	Diesel	70	03/09 →
-------------------------------------	--------	----	---------

516 CDI (906.653, 906.655, 906.657)	Diesel	120	03/09 →
-------------------------------------	--------	-----	---------

SPRINTER 5-t Pianale piatto/Telaio (906)

510 CDI (906.153, 906.155, 906.253, 906.255)	Diesel	70	03/09 →
--	--------	----	---------

516 CDI (906.153, 906.155, 906.253, 906.255)	Diesel	120	03/09 →
--	--------	-----	---------

GA2202

**J2
GA(F) GRUPPO ASPIRAZIONE CARBURANTE
FUEL SUPPLY UNIT**



FIAT

DUCATO Autobus (250)

115 Multijet 2,0 D	Diesel	85	06/11 →
--------------------	--------	----	---------

120 Multijet 2,3 D	Diesel	88	07/06 →
--------------------	--------	----	---------

130 Multijet 2,3 D	Diesel	96	01/07 →
--------------------	--------	----	---------

150 Multijet 2,3 D	Diesel	109	06/11 →
--------------------	--------	-----	---------

160 Multijet 3,0 D	Diesel	116	07/06 →
--------------------	--------	-----	---------

3.0 D Multijet	Diesel	130	06/11 →
----------------	--------	-----	---------

DUCATO Furgonato (250)

115 Multijet 2,0 D	Diesel	85	06/11 →
--------------------	--------	----	---------

120 Multijet 2,3 D	Diesel	88	03/10 →
--------------------	--------	----	---------

150 Multijet 2,3 D	Diesel	109	06/11 →
--------------------	--------	-----	---------

3.0 D Multijet	Diesel	130	06/11 →
----------------	--------	-----	---------

DUCATO Pianale piatto/Telaio (250)

115 Multijet 2,0 D	Diesel	85	06/11 →
--------------------	--------	----	---------

120 Multijet 2,3 D	Diesel	88	07/06 →
--------------------	--------	----	---------

120 Multijet 2,3 D	Diesel	88	03/10 →
--------------------	--------	----	---------

130 Multijet 2,3 D	Diesel	96	01/07 →
--------------------	--------	----	---------

150 Multijet 2,3 D	Diesel	109	06/11 →
--------------------	--------	-----	---------

160 Multijet 3,0 D	Diesel	116	07/06 →
--------------------	--------	-----	---------

3.0 D Multijet	Diesel	130	06/11 →
----------------	--------	-----	---------

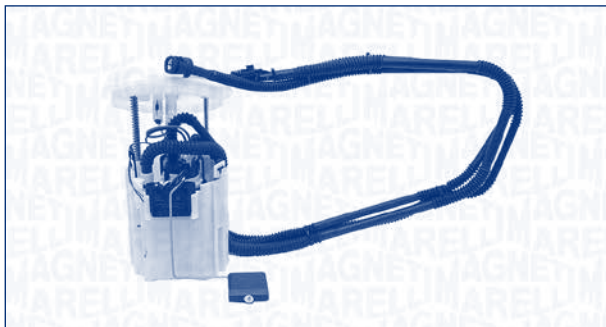
GA2203
J2
GA(F) **GRUPPO ASPIRAZIONE CARBURANTE**
FUEL SUPPLY UNIT

MERCEDES-BENZ
CLASSE C (W204)

 C 200 CDI
 (204.007) Diesel 100 01/07 →

 C 220 CDI
 (204.002) Diesel 125 12/08 →

 C 220 CDI
 (204.008) Diesel 125 01/07 →

 C 250 CDI
 (204.003) Diesel 150 08/08 →

 C 320 CDI
 (204.022) Diesel 165 01/07 →

 C 320 CDI
 4-matic (204.089) Diesel 165 07/07 →

CLASSE C T-Model (S204)

 C 220 CDI
 (204.202) Diesel 125 12/08 →

 C 220 CDI
 (204.208) Diesel 125 08/07 →

 C 320 CDI
 (204.222) Diesel 165 08/07 →

 C 320 CDI
 4-matic (204.289) Diesel 165 08/07 →

CLASSE E Coupé (C207)

 E 220 CDI
 (207.302) Diesel 125 01/10 →

 E 250 CDI
 (207.303) Diesel 150 01/09 →

 E 350 CDI
 (207.322) Diesel 170 01/09 →

CLASSE GLK (X204)

 220 CDI
 (204.902) Diesel 125 12/08 →

 220 CDI 4-matic
 (204.984, 204.997) Diesel 125 12/08 →

GA2203

MERCEDES-BENZ
CLASSE GLK (X204)

 320 CDI 4-matic
 (204.983) Diesel 165 06/08 →

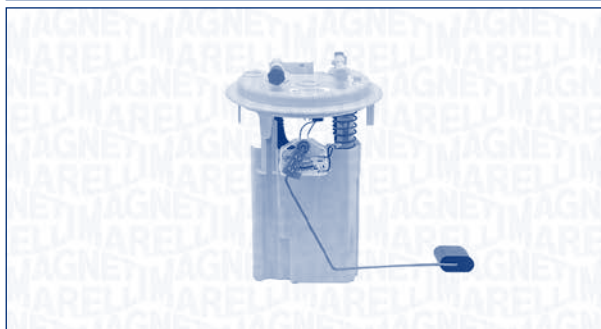
GA2204
J2
GA(F) **GRUPPO ASPIRAZIONE CARBURANTE**
FUEL SUPPLY UNIT

PEUGEOT
206 2 volumi /Coda spiovente (2A/C)

2.0 HDI 90 Diesel 66 12/99 →

206 SW (2E/K)

2.0 HDi Diesel 66 07/02 →

406 Break (8E/F)

2.0 HDi 110 Diesel 80 02/99 → 04/04

2.0 HDi 110 Diesel 79 08/01 → 10/04

2.0 HDI 90 Diesel 66 02/99 → 10/04

GA2205

J2 GRUPPO ASPIRAZIONE CARBURANTE
GA(F) FUEL SUPPLY UNIT



MERCEDES-BENZ

CLASSE A (W168)

A 140 (168.031, 168.131)	Petrol	60	07/97 → 08/04
--------------------------	--------	----	---------------

A 160 (168.033, 168.133)	Petrol	75	07/97 → 08/04
--------------------------	--------	----	---------------

A 190 (168.032, 168.132)	Petrol	92	03/99 → 08/04
--------------------------	--------	----	---------------

GA2207

J2 GRUPPO ASPIRAZIONE CARBURANTE
GA(F) FUEL SUPPLY UNIT



PEUGEOT

106 I (1A, 1C)

1.3	Petrol	72	10/93 → 04/96
-----	--------	----	---------------

1.4	Petrol	55	09/91 → 04/96
-----	--------	----	---------------

1.4	Petrol	69	09/91 → 04/96
-----	--------	----	---------------

1.6	Petrol	65	06/93 → 04/96
-----	--------	----	---------------

1.6	Petrol	76	01/94 → 04/96
-----	--------	----	---------------

GA2208

J2 GRUPPO ASPIRAZIONE CARBURANTE
GA(F) FUEL SUPPLY UNIT



FIAT

IDEA

1.2 16V	Petrol	59	01/04 →
---------	--------	----	---------

1.4 16V	Petrol	70	01/04 →
---------	--------	----	---------

PUNTO (188)

1.2 16V 80 (188.233, .235, .253, .255, .333, .353, .639...)	Petrol	59	09/99 →
---	--------	----	---------

1.4	Petrol	70	09/03 →
-----	--------	----	---------

LANCIA

MUSA (350)

1.4	Petrol	57	09/05 →
-----	--------	----	---------

1.4	Petrol	70	10/04 →
-----	--------	----	---------

YPSILON (843)

1.2	Petrol	59	10/03 → 12/11
-----	--------	----	---------------

1.4 16V	Petrol	70	10/03 → 12/11
---------	--------	----	---------------

GA2210

J2 GRUPPO ASPIRAZIONE CARBURANTE
GA(F) FUEL SUPPLY UNIT

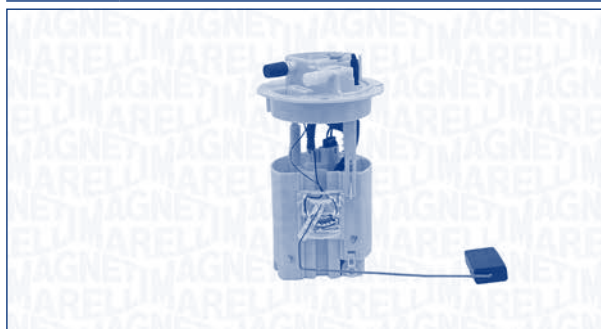

CITROËN

XSARA PICASSO (N68)

2.0 HDi	Diesel	66	12/99 →
---------	--------	----	---------

GA2211
J2
GA GRUPPO ASPIRAZIONE CARBURANTE
FUEL SUPPLY UNIT

KW

VOLKSWAGEN
GOLF V (1K1)

1.9 TDI Diesel 77 10/03 → 11/08

GA2212
J2
GA(F) GRUPPO ASPIRAZIONE CARBURANTE
FUEL SUPPLY UNIT

KW

MERCEDES-BENZ
CLASSE A (W169)

A 160 CDI (169.006, 169.306) Diesel 60 09/04 → 06/12

A 180 CDI (169.007, 169.307) Diesel 80 09/04 → 06/12

A 200 CDI (169.008, 169.308) Diesel 103 09/04 → 06/12

CLASSE B (W245)

B 180 CDI (245.207) Diesel 80 03/05 → 11/11

B 200 CDI (245.208) Diesel 103 03/05 → 11/11

GA2213
J2
GA(F) GRUPPO ASPIRAZIONE CARBURANTE
FUEL SUPPLY UNIT

KW

OPEL
MERIVA

1.4 16V Twinport Petrol 66 07/04 → 05/10

1.4 16V Twinport Petrol/ LPG 66 07/04 → 05/10

1.6 Petrol 64 05/03 → 05/10

1.6 Petrol 77 01/06 → 05/10

1.6 16V Petrol 74 05/03 → 01/06

1.8 Petrol 92 05/03 → 05/10

VAUXHALL
MERIVA Mk I (A)

1.4 16V Twinport Petrol 66 01/03 → 10/09

1.6 i Petrol 64 01/03 → 06/10

1.6 i 16V Petrol 74 01/03 → 09/05

1.8 i 16V Petrol 92 05/03 → 08/05

GA2214
J2
GA(F) GRUPPO ASPIRAZIONE CARBURANTE
FUEL SUPPLY UNIT

KW

AUDI
A4 (8K2, B8)

2.0 TDi Diesel 100 11/07 →

2.0 TDi Diesel 105 11/07 →

2.0 TDi Diesel 120 08/08 →

GA2214



AUDI

A4 (8K2, B8)

2.0 TDi	Diesel	88	06/08 →
2.0 TDi	Diesel	125	01/08 →
2.0 TDi quattro	Diesel	105	11/08 →
2.0 TDi quattro	Diesel	125	01/08 →
2.7 TDi	Diesel	140	11/07 →
3.0 TDi quattro	Diesel	155	06/08 →
3.0 TDi quattro	Diesel	176	11/07 →

A4 Allroad (8KH, B8)

2.0 TDi quattro	Diesel	125	04/09 →
3.0 TDi quattro	Diesel	176	04/09 →
2.0 TDi	Diesel	100	04/08 →
2.0 TDi	Diesel	105	04/08 →
2.0 TDi	Diesel	120	08/08 →
2.0 TDi	Diesel	88	06/08 →
2.0 TDi	Diesel	125	04/08 →
2.0 TDi quattro	Diesel	105	04/08 →

A4 Avant (8K5, B8)

2.0 TDi quattro	Diesel	125	08/08 →
2.7 TDi	Diesel	140	04/08 →
3.0 TDi quattro	Diesel	176	04/08 →

A5 (8T3)

2.0 TDi	Diesel	125	08/08 →
2.0 TDi quattro	Diesel	125	08/08 →
2.7 TDi	Diesel	120	09/07 →
2.7 TDi	Diesel	140	06/07 →
3.0 TDi quattro	Diesel	155	03/08 →
3.0 TDi quattro	Diesel	176	06/07 →

A5 Cabriolet (8F7)

2.0 TDi	Diesel	125	05/09 →
2.7 TDi	Diesel	140	03/09 →
3.0 TDi quattro	Diesel	176	03/09 →

A5 Sportback (8TA)

2.0 TDi	Diesel	105	09/09 →
2.0 TDi	Diesel	125	09/09 →
2.0 TDi quattro	Diesel	125	09/09 →
2.7 TDi	Diesel	140	09/09 →
3.0 TDi quattro	Diesel	176	09/09 →

GA2215

J2 GRUPPO ASPIRAZIONE CARBURANTE
GA(R) FUEL SUPPLY UNIT



CITROËN

C3 Picasso

1.4 VTi 95	Petrol	70	02/09 →
1.6 VTi 120	Petrol	88	02/09 →

PEUGEOT

207 (WA_, WC_)

1.4 16V	Petrol	70	06/07 →
1.4 16V	Petrol	65	02/06 →
1.6 16V VTi	Petrol	88	02/07 →

207 CC (WD_)

1.6 16V	Petrol	88	02/07 →
---------	--------	----	---------

207 SW (WK_)

1.4	Petrol	54	06/07 →
1.4 16V	Petrol	70	06/07 →
1.6 16V	Petrol	88	06/07 →

GA2216

J2 GRUPPO ASPIRAZIONE CARBURANTE
GA(F/R) FUEL SUPPLY UNIT



DAEWOO

MATIZ (KLYA)

0.8	Petrol	38	09/98 →
1.0	Petrol	47	01/03 →

GA2218
J2
GA(F) GRUPPO ASPIRAZIONE CARBURANTE
FUEL SUPPLY UNIT

TOYOTA
COROLLA (ZZE12_, NDE12_, ZDE12_)

1.4 VVT-i Petrol 71 01/02 → 12/06

1.6 VVT-i Petrol 81 01/02 → 12/06

COROLLA Station wagon (_E12J_, _E12T_)

1.4 VVT-i Petrol 71 01/02 → 02/07

1.6 VVT-i Petrol 81 01/02 → 02/07

COROLLA Tre volumi (_E12J_, _E12T_)

1.4 VVT-i Petrol 71 08/02 → 07/07

1.6 VVT-i Petrol 81 08/02 → 07/07

GA2220
J2
GA GRUPPO ASPIRAZIONE CARBURANTE
FUEL SUPPLY UNIT

SEAT
IBIZA IV (6L1)

1.4 16V Petrol 63 05/06 → 11/09

SKODA
FABIA

1.2 Petrol 44 12/06 →

1.2 Petrol 51 01/07 →

1.4 Petrol 63 01/07 →

1.6 Petrol 77 04/07 →

GA2220

SKODA
FABIA Combi

1.2 Petrol 51 10/07 →

1.4 Petrol 63 10/07 →

1.6 Petrol 77 10/07 →

VOLKSWAGEN
POLO (9N_)

1.2 Petrol 44 05/07 → 11/09

1.2 12V Petrol 51 05/07 → 11/09

1.4 16V Petrol 59 05/06 → 11/09

1.8 GTI Petrol 110 09/05 → 11/09

GA2221
J2
GA(R) GRUPPO ASPIRAZIONE CARBURANTE
FUEL SUPPLY UNIT

CITROËN
C3 I (FC_)

1.1 i Petrol 44 02/02 →

1.4 16V Petrol 65 12/03 →

1.4 i Petrol 54 02/02 →

 1.4 i Bivalent Petrol/
CNG 54 02/02 →

1.6 16V Petrol 80 02/02 →

GA2222

J2 GRUPPO ASPIRAZIONE CARBURANTE
GA(F) FUEL SUPPLY UNIT



VOLKSWAGEN

GOLF III (1H1)

1.4	Petrol	44	10/91 → 08/97
1.4	Petrol	40	11/91 → 08/97
1.6	Petrol	55	09/92 → 08/97
1.6	Petrol	74	07/95 → 08/97
1.8	Petrol	55	11/91 → 08/97
1.8	Petrol	66	11/91 → 08/97

1.8 Syncro (1HX1)	Petrol	66	01/93 → 08/97
-------------------	--------	----	---------------

2.0 GTI 16V	Petrol	110	08/92 → 08/97
-------------	--------	-----	---------------

2.0 Syncro (1HX1)	Petrol	85	08/95 → 08/97
-------------------	--------	----	---------------

2.8 VR6	Petrol	128	01/92 → 08/97
---------	--------	-----	---------------

2.9 VR6 Syncro (1HX1)	Petrol	140	10/94 → 08/97
-----------------------	--------	-----	---------------

GOLF III Cabriolet (1E7)

1.6	Petrol	74	10/94 → 05/98
1.8	Petrol	55	07/93 → 05/98
1.8	Petrol	66	07/93 → 05/98
2.0	Petrol	85	07/93 → 05/98

GOLF III Variant (1H5)

1.4	Petrol	44	07/93 → 04/99
1.4	Petrol	40	07/93 → 04/99
1.6	Petrol	74	07/94 → 04/99
1.8	Petrol	55	07/93 → 04/99
1.8	Petrol	66	07/93 → 04/99
2.0	Petrol	85	07/93 → 04/99
2.0 Syncro	Petrol	85	08/95 → 04/99
2.9 VR6	Petrol	140	10/94 → 04/99

VENTO (1H2)

1.4	Petrol	44	11/91 → 09/98
1.4	Petrol	40	11/91 → 09/98
1.6	Petrol	55	09/92 → 09/98
1.6	Petrol	74	10/94 → 09/98

GA2222



VOLKSWAGEN

VENTO (1H2)

1.8	Petrol	55	11/91 → 09/98
1.8	Petrol	66	11/91 → 09/98
2.0	Petrol	85	11/91 → 09/98
2.8 VR6	Petrol	128	01/92 → 09/98

GA2223

J2 GRUPPO ASPIRAZIONE CARBURANTE
GA(F) FUEL SUPPLY UNIT

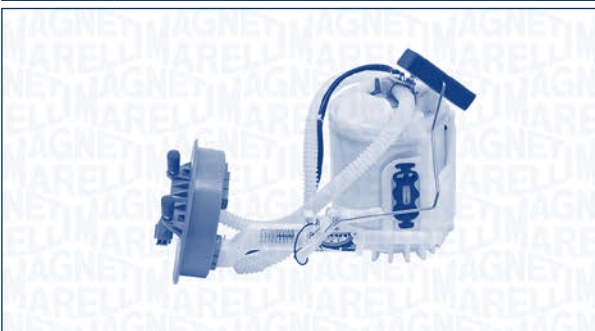

VOLKSWAGEN

GOLF IV Cabriolet (1E7)

1.6	Petrol	74	06/98 → 06/02
2.0	Petrol	85	06/98 → 06/02

PASSAT (3A2, 35I)

2.0	Petrol	85	02/90 → 08/96
2.0 16V	Petrol	110	01/94 → 08/96

PASSAT Variant (3A5, 35I)

2.0	Petrol	85	02/90 → 05/97
2.0 16V	Petrol	110	01/94 → 05/97

POLO (6N1)

100 1.4 16V	Petrol	74	04/96 → 10/99
75 1.6	Petrol	55	10/94 → 10/99

POLO CLASSIC (6KV2)

100 1.6	Petrol	74	12/95 → 09/01
60 1.4	Petrol	44	12/95 → 09/01

SHARAN (7M8, 7M9, 7M6)

1.8 T 20V	Petrol	110	09/97 → 03/10
2.0	Petrol	85	09/95 → 03/10
2.8 VR6	Petrol	128	09/95 → 04/00

TRANSPORTER IV Autobus (70XB, 70XC, 7DB, 7DW)

2.0	Petrol	62	09/90 → 04/03
2.5	Petrol	81	11/90 → 04/03
2.5 Syncro	Petrol	81	11/92 → 04/03
2.8 VR 6	Petrol	103	11/95 → 04/00

GA2223

VOLKSWAGEN
TRANSPORTER IV Furgonato (70XA)

2.5	Petrol	85	08/96 → 04/03
2.5 Syncro	Petrol	85	08/96 → 04/03

TRANSPORTER IV Pianale piatto/Telaio (70XD)

2.0	Petrol	62	07/90 → 04/03
2.5	Petrol	81	11/90 → 04/03
2.5	Petrol	85	08/96 → 04/03
2.5 Syncro	Petrol	85	08/96 → 04/03
2.5 Syncro	Petrol	81	10/92 → 04/03

GA2225
**J2
GA GRUPPO ASPIRAZIONE CARBURANTE
FUEL SUPPLY UNIT**

CITROËN
C1 (PM_, PN_)

1.0	Petrol	50	06/05 →
-----	--------	----	---------

PEUGEOT
107

1.0	Petrol	50	06/05 →
-----	--------	----	---------

TOYOTA
AYGO (WNB1_, KGB1_)

1.0 (KGB10)	Petrol	50	07/05 →
-------------	--------	----	---------

GA2226
**J2
GA(F) GRUPPO ASPIRAZIONE CARBURANTE
FUEL SUPPLY UNIT**

AUDI
A3 (8P1)

1.6 FSI	Petrol	85	08/03 → 09/07
---------	--------	----	---------------

SKODA
OCTAVIA (1U2)

1.8 T	Petrol	110	08/97 → 12/10
1.8 T 4x4	Petrol	110	05/01 → 05/06

OCTAVIA (1Z3)

1.6 FSI	Petrol	85	02/04 → 10/08
---------	--------	----	---------------

OCTAVIA Combi (1U5)

1.6	Petrol	74	07/98 → 12/07
1.8 20V	Petrol	92	07/98 → 07/00
1.8 T	Petrol	110	07/98 → 12/10

VOLKSWAGEN
BORA (1J2)

1.4 16V	Petrol	55	03/00 → 05/05
1.6	Petrol	74	10/98 → 05/05
1.8	Petrol	92	10/98 → 05/05
1.8 4motion	Petrol	92	02/99 → 05/05
2.0	Petrol	85	10/98 → 05/05
2.3 V5	Petrol	110	10/98 → 10/00
2.3 V5 4motion	Petrol	110	12/98 → 10/00
2.8 V6 4motion	Petrol	150	03/99 → 05/05

BORA Station wagon (1J6)

1.6	Petrol	74	05/99 → 05/05
2.0	Petrol	85	05/99 → 05/05
2.3 V5	Petrol	110	05/99 → 10/00
2.3 V5 4motion	Petrol	110	05/99 → 10/00

GOLF IV (1J1)

1.4 16V	Petrol	55	08/97 → 06/05
1.6	Petrol	74	08/97 → 05/04
1.8	Petrol	92	08/97 → 06/05
1.8 T	Petrol	110	08/97 → 06/05
2.0	Petrol	85	07/98 → 05/04
2.3 V5	Petrol	110	08/97 → 10/00

GA2226



VOLKSWAGEN

LUPO (6X1, 6E1)

1.0	Petrol	37	09/98 → 07/05
1.4 16V	Petrol	55	09/98 → 07/05

NEW BEETLE (9C1, 1C1)

1.6	Petrol	75	06/00 → 09/10
1.6	Petrol	74	10/99 → 09/00
1.8 T	Petrol	110	10/99 → 09/10
2.0	Petrol	85	01/98 → 09/10
2.3 V5	Petrol	125	10/00 → 09/10

GA2227

J2 GRUPPO ASPIRAZIONE CARBURANTE
GA(R) FUEL SUPPLY UNIT



RENAULT

CLIO II (BB0/1/2_, CB0/1/2_)

1.2	Petrol	55	06/01 → 10/03
1.2 (BB0A, BB0F, BB10, BB1K, BB28, BB2D, BB2H, CB0A...)	Petrol	43	09/98 →
1.2 (BB0A, CB0A)	Petrol	44	03/99 → 05/01
1.4 (B/CB0C)	Petrol	55	09/98 → 05/05
1.4 16V (B/CB0L)	Petrol	70	10/99 → 09/04
1.6 (B/CB0D)	Petrol	66	09/98 → 05/05

CLIO II Furgonato (SB0/1/2_)

1.1 (SB0A, SB0F, SB1K, SB2D)	Petrol	43	09/98 →
1.2 (SB0A, SB0F, SB10)	Petrol	44	03/99 → 10/03

GA2229

J2 GRUPPO ASPIRAZIONE CARBURANTE
GA(F/R) FUEL SUPPLY UNIT



FIAT

500 (312)

1.2	Petrol	51	10/07 →
1.2 LPG	Petrol/LPG	51	12/10 →
1.4	Petrol	74	10/07 →

500 C (312)

1.2	Petrol	51	09/09 →
1.4	Petrol	74	09/09 →

PANDA (169)

1.1	Petrol	40	09/03 →
1.2	Petrol	44	09/03 →
1.2	Petrol	51	03/10 →
1.2 LPG	Petrol/LPG	44	04/09 →
1.2 LPG	Petrol/LPG	51	11/10 →
1.4	Petrol	74	10/06 →

PANDA Van (169)

1.2	Petrol	44	09/04 →
1.2	Petrol	51	09/10 →
1.2 LPG	Petrol/LPG	51	09/10 →

FORD

KA (RU8)

1.2	Petrol	51	10/08 →
-----	--------	----	---------

GA2230
**J2
GA**
**GRUPPO ASPIRAZIONE CARBURANTE
FUEL SUPPLY UNIT**

KW

SEAT
CORDOBA (6K2)

1.0	Petrol	37	06/99 → 10/02	CHASSIS: 6KX400000 →
-----	--------	----	---------------	-------------------------

1.4	Petrol	44	06/99 → 10/02	CHASSIS: 6KX400000 →
-----	--------	----	---------------	-------------------------

1.4 16V	Petrol	55	05/00 → 10/02	
---------	--------	----	---------------	--

1.4 16V	Petrol	74	02/00 → 10/02	
---------	--------	----	---------------	--

1.6	Petrol	74	06/99 → 10/02	
-----	--------	----	---------------	--

1.8 T 20V Cupra	Petrol	115	07/00 → 10/02	
-----------------	--------	-----	---------------	--

CORDOBA Vario (6K5)

1.4	Petrol	44	06/99 → 12/02	
-----	--------	----	---------------	--

1.4 16V	Petrol	55	06/99 → 12/02	
---------	--------	----	---------------	--

1.6	Petrol	74	06/99 → 12/02	
-----	--------	----	---------------	--

IBIZA III (6K1)

1.0	Petrol	37	08/99 → 02/02	
-----	--------	----	---------------	--

1.4	Petrol	44	08/99 → 02/02	
-----	--------	----	---------------	--

1.4 16V	Petrol	55	05/00 → 02/02	
---------	--------	----	---------------	--

1.4 16V	Petrol	74	08/99 → 02/02	
---------	--------	----	---------------	--

1.6	Petrol	74	08/99 → 02/02	
-----	--------	----	---------------	--

1.8 T 20V Cupra	Petrol	115	07/00 → 02/02	
-----------------	--------	-----	---------------	--

IBIZA IV (6L1)

1.4 16V	Petrol	74	02/02 → 11/09	
---------	--------	----	---------------	--

VOLKSWAGEN
POLO (6N1)

120 1.6 16V GTI	Petrol	88	09/98 → 10/99	
-----------------	--------	----	---------------	--

45 1.0	Petrol	33	10/94 → 09/96	
--------	--------	----	---------------	--

55 1.3	Petrol	40	10/94 → 07/95	
--------	--------	----	---------------	--

POLO (6N2)

1.0	Petrol	37	10/99 → 09/01	
-----	--------	----	---------------	--

1.4	Petrol	40	10/99 → 09/01	
-----	--------	----	---------------	--

1.4	Petrol	44	10/99 → 09/01	
-----	--------	----	---------------	--

1.4 16V	Petrol	55	10/99 → 09/01	
---------	--------	----	---------------	--

1.4 16V	Petrol	74	10/99 → 09/01	
---------	--------	----	---------------	--

1.6 16V GTI	Petrol	92	10/99 → 09/01	
-------------	--------	----	---------------	--

GA2230

KW

VOLKSWAGEN
POLO (86C, 80)

1.0 Cat.	Petrol	33	08/89 → 09/94	
----------	--------	----	---------------	--

1.3 Cat.	Petrol	55	10/89 → 03/91	
----------	--------	----	---------------	--

POLO (9N_)

1.2	Petrol	40	01/02 → 05/07	ENGINE: AWY, BMD
-----	--------	----	---------------	------------------

1.2 12V	Petrol	47	10/01 → 07/07	CHASSIS: → 6N2010000
---------	--------	----	---------------	-------------------------

1.4 16V	Petrol	74	10/01 → 05/08	
---------	--------	----	---------------	--

1.4 16V	Petrol	55	10/01 → 05/08	ENGINE: AUA, BBY
---------	--------	----	---------------	------------------

POLO CLASSIC (6KV2)

75 1.4 16V	Petrol	55	10/99 → 09/01	
------------	--------	----	---------------	--

POLO CLASSIC (86C, 80)

1.0	Petrol	33	01/85 → 09/94	
-----	--------	----	---------------	--

1.3 Cat.	Petrol	40	07/87 → 09/94	
----------	--------	----	---------------	--

POLO Coupé (86C, 80)

1.0 Cat.	Petrol	33	08/89 → 09/94	
----------	--------	----	---------------	--

1.3	Petrol	57	03/91 → 09/94	
-----	--------	----	---------------	--

1.3 Cat.	Petrol	55	10/89 → 09/94	
----------	--------	----	---------------	--

POLO Furgonato (6NF)

1.0	Petrol	33	10/94 → 12/99	
-----	--------	----	---------------	--

POLO Furgonato (86CF)

1.0	Petrol	33	08/92 → 07/94	
-----	--------	----	---------------	--

POLO Variant (6KV5)

1.4	Petrol	40	12/98 → 09/01	
-----	--------	----	---------------	--

1.4	Petrol	44	05/97 → 09/01	
-----	--------	----	---------------	--

1.4 16V	Petrol	55	10/99 → 09/01	
---------	--------	----	---------------	--

1.6	Petrol	74	05/97 → 09/01	
-----	--------	----	---------------	--

GA2231
**J2
GA(F/R)**
**GRUPPO ASPIRAZIONE CARBURANTE
FUEL SUPPLY UNIT**

KW

BMW
5 (F10, F18)

520i	Petrol	120	09/11 →	
------	--------	-----	---------	--

GA2231



BMW

5 (F10, F18)

520i	Petrol	135	09/11 →
528 i	Petrol	190	03/10 →
528i	Petrol	180	09/11 →

5 Touring (F11)

520i	Petrol	135	09/11 →
528i	Petrol	180	09/11 →

GA2232

J2 GA(F/R) GRUPPO ASPIRAZIONE CARBURANTE FUEL SUPPLY UNIT



BMW

5 (F10, F18)

535 i	Petrol	225	03/10 →
535 i xDrive	Petrol	225	03/10 →

5 Gran Turismo (F07)

535 i	Petrol	225	10/09 →
535 i xDrive	Petrol	225	09/10 →

GA2233

J2 GA GRUPPO ASPIRAZIONE CARBURANTE FUEL SUPPLY UNIT

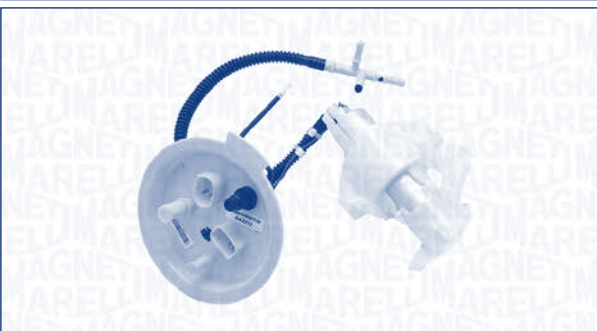

BMW

5 (F10, F18)

520 d	Diesel	135	03/10 →
-------	--------	-----	---------

GA2234

J2 GA(F) GRUPPO ASPIRAZIONE CARBURANTE FUEL SUPPLY UNIT



FORD

FIESTA VI

1.25	Petrol	44	06/08 →	ENGINE: STJB,STJA
1.25	Petrol	60	06/08 →	ENGINE: SNJB,SNJA
1.4	Petrol	71	06/08 →	ENGINE: SPJA,SPJC
1.4 LPG	Petrol/LPG	71	01/09 →	ENGINE: RTJA,RTJB

GA2235
J2
GA(F) GRUPPO ASPIRAZIONE CARBURANTE
FUEL SUPPLY UNIT

FORD
FOCUS C-MAX

1.6	Petrol	74	10/03 → 03/07	ENGINE: HWDA,HWDB
1.8	Petrol	88	10/03 → 03/07	ENGINE: CSDA,CSDB
1.8 Flexifuel	Petrol/ Ethanol	92	01/06 → 03/07	ENGINE: Q7DA

FOCUS II (DA_)

1.6	Petrol	74	11/04 →	ENGINE: HWDA,HWDB,SHDA
1.8 Flexifuel	Petrol/ Ethanol	92	01/06 →	ENGINE: Q7DA

FOCUS II Station wagon (DA_)

1.6	Petrol	74	11/04 →	ENGINE: HWDA,HWDB,SHDA
1.8 Flexifuel	Petrol/ Ethanol	92	01/06 →	ENGINE: Q7DA
2.0	Petrol	107	11/04 →	ENGINE: AODA,AODB

GA2236
J2
GA(F) GRUPPO ASPIRAZIONE CARBURANTE
FUEL SUPPLY UNIT

FORD
FIESTA V (JH_, JD_)

1.25 16V	Petrol	51	03/03 → 06/08	ENGINE: M7JA,M7JB
1.25 16V	Petrol	55	12/02 → 06/08	ENGINE: FUJA,FUJB
1.3	Petrol	44	11/01 → 06/08	ENGINE: BAJA
1.3	Petrol	51	11/01 → 06/08	ENGINE: A9JA,A9JB
1.4 16V	Petrol	59	11/01 → 06/08	ENGINE: FXJA,FXJB
1.6 16V	Petrol	74	11/01 → 06/08	ENGINE: FYJA,FYJB

FIESTA Van

1.3	Petrol	51	10/03 → 09/08	ENGINE: A9JA,A9JB
-----	--------	----	---------------	-------------------

FUSION (JU_)

1.25	Petrol	55	03/05 → 06/12	ENGINE: FUJA,FUJB
1.4	Petrol	59	10/02 → 06/12	ENGINE: FXJA,FXJB,FXJC
1.6	Petrol	74	10/02 → 06/12	ENGINE: FYJA,FYJB

GA2237
J2
GA(F) GRUPPO ASPIRAZIONE CARBURANTE
FUEL SUPPLY UNIT

FORD
C-MAX II

1.6	Petrol	63	12/10 →	ENGINE: XTDA
-----	--------	----	---------	--------------

FOCUS III

1.6 Ti	Petrol	63	08/11 →	ENGINE: XTDA
--------	--------	----	---------	--------------

GA2238

J2 GRUPPO ASPIRAZIONE CARBURANTE
GA(F/R) FUEL SUPPLY UNIT

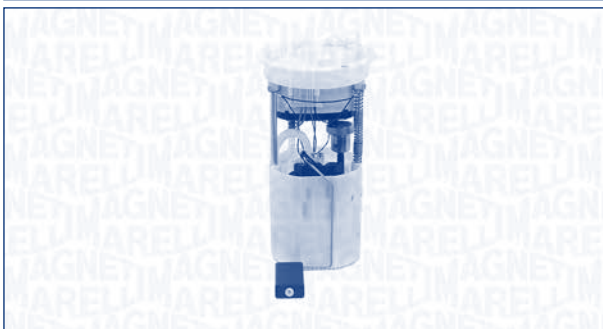

KW



FORD

GALAXY (WA6)

2.0	Petrol	107	05/06 →	ENGINE: AOWB,AOWA
2.3	Petrol	118	07/07 →	ENGINE: SEWA

MONDEO IV (BA7)

1.6 Ti	Petrol	81	03/07 →	ENGINE: RHBA
1.6 Ti	Petrol	92	03/07 →	ENGINE: PNBA
2.0	Petrol	107	03/07 →	ENGINE: AOBC,AOBA,TBBA

MONDEO IV Tre volumi (BA7)

1.6 Ti	Petrol	92	03/07 →	ENGINE: PNBA
2.0	Petrol	107	03/07 →	ENGINE: AOBC,AOBA,TBBA

MONDEO IV Turnier (BA7)

1.6 Ti	Petrol	81	03/07 →	ENGINE: RHBA
1.6 Ti	Petrol	92	03/07 →	ENGINE: PNBA
2.0	Petrol	107	03/07 →	ENGINE: AOBC,AOBA,TBBA

S-MAX (WA6)

2.0	Petrol	107	05/06 →	ENGINE: AOWB,AOWA
-----	--------	-----	---------	----------------------

SUA130

J2 GRUPPO ASPIRAZIONE CARBURANTE
GA FUEL SUPPLY UNIT



KW



FIAT

PUNTO (176)

55 1.1	Petrol	40	09/93 → 09/99
60 1.2	Petrol	43	01/94 → 09/99
60 1.2	Petrol	44	03/94 → 09/99

PUNTO (188)

1.2 Natural Power	BiFuel	44	09/03 →
-------------------	--------	----	---------

PUNTO Cabriolet (176C)

60 1.2	Petrol	43	04/94 → 06/00
60 1.2	Petrol	44	05/95 → 06/00

PUNTO Van (176L)

1.1	Petrol	40	04/96 → 02/00
-----	--------	----	---------------

LANCIA

Y (840A)

1.1 (840AE)	Petrol	40	11/95 → 09/03
1.2 (840AA, 840AF1A)	Petrol	44	03/96 → 09/03
1.2 16V (840AG1A)	Petrol	59	10/00 → 09/03
1.4 12V (840AC)	Petrol	55	03/96 → 09/03

SUA133
J2
GA **GRUPPO ASPIRAZIONE CARBURANTE**
FUEL SUPPLY UNIT

FIAT
BARCETTA (183)

1.8 16V	Petrol	96	04/95 → 05/05
---------	--------	----	---------------

PUNTO (176)

1.2 16V	Petrol	63	04/97 → 09/99
---------	--------	----	---------------

1.6	Petrol	65	01/94 → 04/97
-----	--------	----	---------------

75 1.2	Petrol	54	12/93 → 09/99
--------	--------	----	---------------

PUNTO Cabriolet (176C)

85 16V 1.2	Petrol	63	04/97 → 06/00
------------	--------	----	---------------

90 1.6	Petrol	65	04/94 → 04/97
--------	--------	----	---------------

LANCIA
Y (840A)

1.2 16V (840AD)	Petrol	63	04/97 → 09/03
-----------------	--------	----	---------------

SUA142

CITROËN
XANTIA (X1)

2.0 i 16V	Petrol	110	06/94 → 01/98
-----------	--------	-----	---------------

2.0 i 16V	Petrol	112	03/93 → 01/98
-----------	--------	-----	---------------

2.0 i 16V	Petrol	97	06/95 → 01/98
-----------	--------	----	---------------

2.0 Turbo	Petrol	108	06/95 → 01/98
-----------	--------	-----	---------------

XANTIA Break (X1)

1.8 i	Petrol	66	04/97 → 01/98
-------	--------	----	---------------

1.8 i	Petrol	74	09/95 → 01/98
-------	--------	----	---------------

1.8 i 16V	Petrol	81	04/97 → 01/98
-----------	--------	----	---------------

2.0 i	Petrol	89	09/95 → 01/98
-------	--------	----	---------------

2.0 i 16V	Petrol	97	09/95 → 01/98
-----------	--------	----	---------------

2.0 Turbo	Petrol	108	09/95 → 01/98
-----------	--------	-----	---------------

SUA149
J2
GA **GRUPPO ASPIRAZIONE CARBURANTE**
FUEL SUPPLY UNIT

RENAULT
TWINGO I (C06_)

1.2 (C063, C064)	Petrol	40	03/93 → 10/96
------------------	--------	----	---------------

TWINGO I Furgonato (S06_)

1.2 (S063, S064)	Petrol	40	10/93 → 05/96
------------------	--------	----	---------------

SUA142
J2
GA **GRUPPO ASPIRAZIONE CARBURANTE**
FUEL SUPPLY UNIT

CITROËN
XANTIA (X1)

1.6 i	Petrol	65	03/93 → 01/98
-------	--------	----	---------------

1.8 i	Petrol	66	04/97 → 01/98
-------	--------	----	---------------

1.8 i	Petrol	74	03/93 → 01/98
-------	--------	----	---------------

1.8 i 16V	Petrol	81	06/95 → 01/98
-----------	--------	----	---------------

2.0 i	Petrol	89	03/93 → 01/98
-------	--------	----	---------------

SUA373

J2 GRUPPO ASPIRAZIONE CARBURANTE
GA FUEL SUPPLY UNIT



PEUGEOT

607 (9D, 9U)

2.2 HDi Diesel 98 02/00 →

SUA376

J2 GRUPPO ASPIRAZIONE CARBURANTE
GA FUEL SUPPLY UNIT



PEUGEOT

306 (7B, N3, N5)

1.4 SL	Petrol	55	01/97 → 05/01	ENGINE: TU3JP
1.6	Petrol	72	10/00 → 05/01	ENGINE: TU5JP
1.6 SR	Petrol	65	01/97 → 10/00	ENGINE: TU5JP
1.8 16V	Petrol	81	03/97 → 05/01	ENGINE: XU7JP4
1.8 ST	Petrol	74	01/97 → 05/01	ENGINE: XU7JP4
2.0	Petrol	97	03/97 → 05/01	ENGINE: XU10J4RS

306 2 volumi /Coda spiovente (7A, 7C, N3, N5)

1.6	Petrol	65	01/97 → 10/00	ENGINE: TU5JP
2.0 S16	Petrol	110	01/97 → 05/01	ENGINE: XU10J4RS
2.0 XSi	Petrol	89	01/97 → 05/01	ENGINE: XU10J4RS

306 Break (7E, N3, N5)

1.4	Petrol	55	03/97 → 04/02	ENGINE: TU3JP
1.6	Petrol	65	03/97 → 10/00	ENGINE: TU5JP
1.8	Petrol	74	03/97 → 04/02	ENGINE: XU7JP4
1.8 16V	Petrol	81	03/97 → 04/02	ENGINE: XU7JP4

SUA376



PEUGEOT

306 Break (7E, N3, N5)

2.0 Petrol 97 03/97 → 04/02 ENGINE: XU10J4RS

SUA377

J2 GRUPPO ASPIRAZIONE CARBURANTE
GA FUEL SUPPLY UNIT



CITROËN

BERLINGO (MF)

2.0 HDI 90 (MFRHY) Diesel 66 01/01 →

BERLINGO Furgonato (M_)

2.0 HDI 90 (MBRHY, MCRHY) Diesel 66 01/01 →

XSARA PICASSO (N68)

2.0 HDi Diesel 66 05/00 →

PEUGEOT

RANCH Furgonato (5)

2.0 HDi Diesel 66 01/01 →

RANCH MPV / Space wagon (5F)

2.0 HDi Diesel 66 01/01 →

SUA378
**J2
GA**
**GRUPPO ASPIRAZIONE CARBURANTE
FUEL SUPPLY UNIT**

KW

CITROËN
EVASION (22, U6)

1.8	Petrol	73	05/97 → 12/00	ENGINE: C(XU7JP)
2.0	Petrol	89	06/94 → 12/00	ENGINE: C(XU10J2- XU10J2TE-XU10J4R)

FIAT
ULYSSE (220)

1.8 (220.BB5)	Petrol	73	05/97 → 12/00	ENGINE: C(XU7JP)
2.0 (220.AC5)	Petrol	89	06/94 → 12/00	ENGINE: C(XU10J2- XU10J2TE-XU10J4R)
2.0 16V	Petrol	97	05/98 → 09/00	ENGINE: C(XU10J2- XU10J2TE-XU10J4R)

PEUGEOT
806 (221)

2.0	Petrol	89	06/94 → 12/00	ENGINE: C(XU10J2- XU10J2TE-XU10J4R)
-----	--------	----	---------------	--

SUA380
**J2
GA**
**GRUPPO ASPIRAZIONE CARBURANTE
FUEL SUPPLY UNIT**

KW

PEUGEOT
406 (8B)

1.6	Petrol	65	11/95 → 12/97	ENGINE: I(XU5JP)
-----	--------	----	---------------	------------------

SUA380

KW

PEUGEOT

1.8	Petrol	66	05/97 → 12/97	ENGINE: I(XU7JP)(XU7JP4)
2.0 16V	Petrol	97	11/95 → 12/97	ENGINE: I(10J2TE-XU10J4R)

406 Break (8E/F)

1.8	Petrol	66	05/97 → 12/97	ENGINE: I(XU7JP)(XU7JP4)
-----	--------	----	---------------	-----------------------------

406 Coupé (8C)

2.0 16V	Petrol	97	03/97 → 12/97	ENGINE: I(10J2TE-XU10J4R)
3.0 V6 24V	Petrol	140	03/97 → 12/97	ENGINE: I(ES9J4)

SUA381
**J2
GA**
**GRUPPO ASPIRAZIONE CARBURANTE
FUEL SUPPLY UNIT**

KW

PEUGEOT
406 (8B)

1.6	Petrol	65	01/98 → 05/04	ENGINE: I(XU5JP)
1.8	Petrol	66	01/98 → 05/04	ENGINE: I(XU7JP-XU7JP4)
2.0 16V	Petrol	100	08/00 → 05/04	ENGINE: I(XU10J2TE- XU10J4R)
2.0 16V	Petrol	97	01/98 → 05/04	ENGINE: I(XU10J2TE- XU10J4R)
2.0 16V	Petrol	99	01/99 → 08/00	ENGINE: I(XU10J2TE- XU10J4R)

406 Break (8E/F)

1.8	Petrol	66	01/98 → 10/04	ENGINE: I(XU7JP-XU7JP4)
1.8 16V	Petrol	85	10/00 → 10/04	ENGINE: I(XU7JP-XU7JP4)
2.0 16V	Petrol	100	10/00 → 10/04	ENGINE: I(XU10J2TE- XU10J4R)

SUA381



PEUGEOT

406 Break (8E/F)

2.0 16V	Petrol	99	01/99 → 10/00	ENGINE: I(XU10J2TE-XU10J4R)
---------	--------	----	---------------	-----------------------------

406 Coupé (8C)

2.0 16V	Petrol	100	10/00 → 12/04	ENGINE: I(XU10J2TE-XU10J4R)
---------	--------	-----	---------------	-----------------------------

2.0 16V	Petrol	97	01/98 → 12/04	ENGINE: I(XU10J2TE-XU10J4R)
---------	--------	----	---------------	-----------------------------

2.0 16V	Petrol	99	01/99 → 10/00	ENGINE: I(XU10J2TE-XU10J4R)
---------	--------	----	---------------	-----------------------------

3.0 V6 24V	Petrol	140	01/98 → 12/04	ENGINE: I(ES9J4)
------------	--------	-----	---------------	------------------

SUA390

J2 GA GRUPPO ASPIRAZIONE CARBURANTE FUEL SUPPLY UNIT

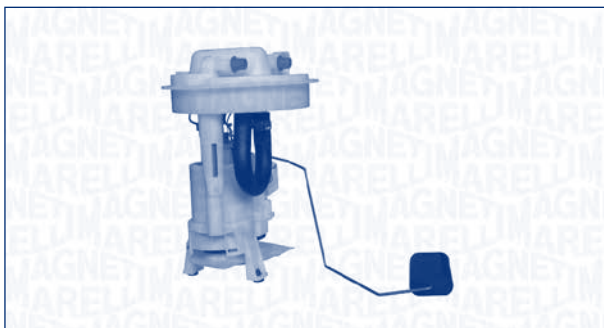

RENAULT

TWINGO I Furgonato (S06_)

1.2 (S063, S064)	Petrol	40	03/93 → 05/96
------------------	--------	----	---------------

1.2 (S066, S068)	Petrol	43	05/96 → 12/96
------------------	--------	----	---------------

SUA393

J2 GA GRUPPO ASPIRAZIONE CARBURANTE FUEL SUPPLY UNIT



RENAULT

CLIO II (BB0/1/2_, CB0/1/2_)

1.4 (B/CB0C)	Petrol	55	09/98 → 05/05	ENGINE: I(E7J)
--------------	--------	----	---------------	----------------

1.6 (B/CB0D)	Petrol	66	09/98 → 05/05	ENGINE: I(K7M)
--------------	--------	----	---------------	----------------

CLIO II Furgonato (SB0/1/2_)

1.1 (SB0A, SB0F, SB1K, SB2D)	Petrol	43	09/98 →	ENGINE: I(D7F)
------------------------------	--------	----	---------	----------------

SUA417

J2 GA GRUPPO ASPIRAZIONE CARBURANTE FUEL SUPPLY UNIT



RENAULT

TWINGO I Furgonato (S06_)

1.2 (S066, S068)	Petrol	43	05/96 →
------------------	--------	----	---------

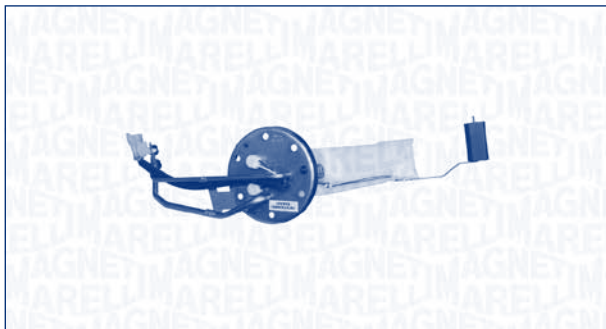
SUA421
J2
GA GRUPPO ASPIRAZIONE CARBURANTE
FUEL SUPPLY UNIT

KW

ROVER
200 (RF)

214 i	Petrol	55	01/97 → 03/00
214 Si	Petrol	76	01/97 → 03/00
216 Si	Petrol	82	01/97 → 03/00
218 K Vi	Petrol	107	01/97 → 03/00

SUA422
J2
GA GRUPPO ASPIRAZIONE CARBURANTE
FUEL SUPPLY UNIT

KW

ROVER
400 Tourer (XW)

2.0 i	Petrol	100	01/97 → 11/98
-------	--------	-----	---------------

SUA431
J2
GA GRUPPO ASPIRAZIONE CARBURANTE
FUEL SUPPLY UNIT

KW

FIAT
SEICENTO (187)

0.9 (187AXA, 187AXA1A)	Petrol	29	01/98 → 12/00
1.1 (187AXB, 187AXB1A)	Petrol	40	01/98 → 12/00

SEICENTO Van (187)

0.9 (187AXA)	Petrol	29	01/98 → 12/00
1.1 (187CXB/C)	Petrol	40	01/98 → 12/00

SUA444
J2
GA GRUPPO ASPIRAZIONE CARBURANTE
FUEL SUPPLY UNIT

KW

SAAB
9000

2.3 -16 CD Turbo	Petrol	147	07/90 → 12/98
2.3 -16 Turbo	Petrol	143	09/90 → 08/93

9000 2 volumi /Coda spiovente

2.3 -16 CS	Petrol	107	07/90 → 12/98
2.3 -16 Turbo	Petrol	143	09/90 → 12/98

SUA446

J2 GA(F/R) GRUPPO ASPIRAZIONE CARBURANTE
FUEL SUPPLY UNIT



SAAB

9-3 (YS3D)

2.0 i	Petrol	96	02/98 → 09/02
2.0 Turbo	Petrol	113	10/98 → 09/02
2.0 Turbo	Petrol	136	02/98 → 09/02
2.3 i	Petrol	110	02/98 → 12/99

9-3 Cabriolet (YS3D)

2.0 i	Petrol	96	02/98 → 12/00
2.0 Turbo	Petrol	136	02/98 → 08/03
2.0 Turbo	Petrol	113	10/98 → 08/03
2.3 i	Petrol	110	02/98 → 12/99

SUA454

J2 GA GRUPPO ASPIRAZIONE CARBURANTE
FUEL SUPPLY UNIT



CITROËN

XSARA (N1)

2.0 HDI 109	Diesel	80	05/01 → 03/05	ENGINE: DW10ATED
2.0 HDI 90	Diesel	66	02/99 → 03/05	ENGINE: DW10TD

XSARA Break (N2)

2.0 HDI 109	Diesel	80	05/01 → 08/05	ENGINE: DW10ATED
2.0 HDI 90	Diesel	66	02/99 → 08/05	ENGINE: DW10TD

SUA454



CITROËN

XSARA Coupé (N0)

2.0 HDI 109	Diesel	80	05/01 → 03/05	ENGINE: DW10ATED
2.0 HDI 90	Diesel	66	02/99 → 03/05	ENGINE: DW10TD

XSARA PICASSO (N68)

2.0 HDi	Diesel	66	05/00 →	ENGINE: DW10TD
---------	--------	----	---------	----------------

SUA455

J2 GA GRUPPO ASPIRAZIONE CARBURANTE
FUEL SUPPLY UNIT



CITROËN

XANTIA (X1)

2.0 i	Petrol	89	02/97 → 01/98
2.0 i 16V	Petrol	110	02/97 → 01/98
2.0 i 16V	Petrol	97	02/97 → 01/98
2.0 Turbo	Petrol	108	02/97 → 01/98

XANTIA (X2)

2.0 i	Petrol	89	01/98 → 04/03
2.0 i 16V	Petrol	97	01/98 → 04/03

XANTIA Break (X1)

2.0 i	Petrol	89	02/97 → 01/98
2.0 i 16V	Petrol	97	02/97 → 01/98

XANTIA Break (X2)

2.0 i	Petrol	89	01/98 → 04/03
2.0 i 16V	Petrol	97	01/98 → 04/03

XSARA (N1)

1.4 i	Petrol	55	05/98 → 03/05	ENGINE: TU3JP
1.6 i	Petrol	65	05/98 → 09/00	ENGINE: TU5JP
1.8 i	Petrol	66	04/97 → 09/00	ENGINE: XU7JB-XU7JP-XU7JP4
1.8 i 16V	Petrol	81	04/97 → 09/00	ENGINE: XU10J2TE
2.0 16V	Petrol	120	04/97 → 09/00	ENGINE: XU10J4RS
2.0 16V	Petrol	100	09/00 → 03/05	ENGINE: XU10J4RS
2.0 16V	Petrol	97	07/98 → 09/00	ENGINE: XU10J4RS

SUA455

CITROËN
XSARA Break (N2)

1.4 i	Petrol	55	05/98 → 08/05	ENGINE: TU3JP
1.8 i	Petrol	66	10/97 → 09/00	ENGINE: XU7JB-XU7JP-XU7JP4
1.8 i 16V	Petrol	81	10/97 → 09/00	ENGINE: XU10J2TE
2.0 16V	Petrol	100	09/00 → 08/05	ENGINE: XU10J4RS
2.0 16V	Petrol	97	07/98 → 09/00	ENGINE: XU10J4RS

XSARA Coupé (N0)

1.8 i 16V	Petrol	81	02/98 → 09/00	ENGINE: XU10J2TE
-----------	--------	----	---------------	------------------

PEUGEOT
306 (7B, N3, N5)

1.6 SR	Petrol	65	01/97 → 10/00	
--------	--------	----	---------------	--

306 Cabriolet (7D, N3, N5)

1.8	Petrol	74	05/98 → 04/02	
1.8 16V	Petrol	81	07/00 → 04/02	
2.0	Petrol	89	05/98 → 04/02	

SUA460
J2 GA GRUPPO ASPIRAZIONE CARBURANTE FUEL SUPPLY UNIT

PEUGEOT
306 (7B, N3, N5)

2.0 HDI 90	Diesel	66	06/99 → 05/01	ENGINE: DW10TD
------------	--------	----	---------------	----------------

306 2 volumi /Coda spiovente (7A, 7C, N3, N5)

2.0 HDI 90	Diesel	66	06/99 → 05/01	ENGINE: DW10TD
------------	--------	----	---------------	----------------

306 Break (7E, N3, N5)

2.0 HDI 90	Diesel	66	06/99 → 12/01	ENGINE: DW10TD
------------	--------	----	---------------	----------------

SUA461
J2 GA GRUPPO ASPIRAZIONE CARBURANTE FUEL SUPPLY UNIT

CITROËN
EVASION (22, U6)

1.8	Petrol	73	05/97 → 12/01	ENGINE: ID(XU7JP)
-----	--------	----	---------------	-------------------

XANTIA (X1)

1.6 i	Petrol	65	01/97 → 01/98	ENGINE: ID(XU5JP)
1.8 i	Petrol	74	01/97 → 01/98	ENGINE: XU7B-XU7JP-XU7JP4

XANTIA Break (X1)

1.8 i	Petrol	74	01/97 → 01/98	ENGINE: XU7B-XU7JP-XU7JP4
-------	--------	----	---------------	---------------------------

FIAT
ULYSSE (220)

1.8 (220.BB5)	Petrol	73	05/97 → 12/01	ENGINE: ID(XU7JP)
---------------	--------	----	---------------	-------------------

SUA462
J2 GA GRUPPO ASPIRAZIONE CARBURANTE FUEL SUPPLY UNIT

PEUGEOT
406 (8B)

2.0 HDi 110	Diesel	80	04/99 → 05/00	
2.0 HDi 90	Diesel	66	04/99 → 05/00	

406 Break (8E/F)

2.0 HDi 110	Diesel	80	04/99 → 05/00	
2.0 HDi 90	Diesel	66	04/99 → 05/00	

SUA463

J2 GRUPPO ASPIRAZIONE CARBURANTE
GA FUEL SUPPLY UNIT

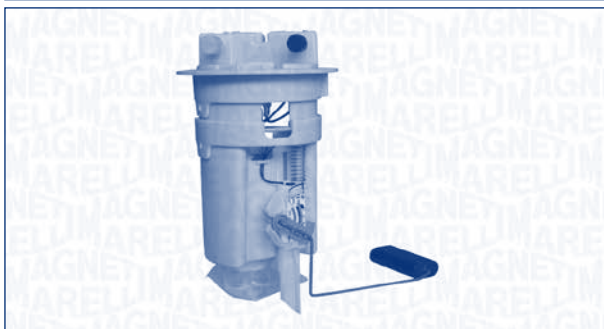

CITROËN

EVASION (22, U6)

2.0 HDi	Diesel	80	08/99 → 06/01	ENGINE: DW10
---------	--------	----	---------------	--------------

JUMPY (U6U)

2.0 HDi 110	Diesel	80	03/00 → 06/01	ENGINE: DW10
-------------	--------	----	---------------	--------------

2.0 HDi 95	Diesel	69	10/99 → 06/01	ENGINE: DW10
------------	--------	----	---------------	--------------

JUMPY Pianale piatto/Telaio (BU_, BV_, BW_, BX_)

2.0 HDi 95	Diesel	69	10/99 → 06/01	ENGINE: DW10
------------	--------	----	---------------	--------------

XANTIA (X2)

2.0 HDI 109	Diesel	80	02/99 → 12/01	ENGINE: DW10TD, DW10ATED
-------------	--------	----	---------------	--------------------------

2.0 HDI 90	Diesel	66	03/99 → 12/01	ENGINE: DW10TD, DW10ATED
------------	--------	----	---------------	--------------------------

XANTIA Break (X2)

2.0 HDI 109	Diesel	80	02/99 → 12/01	ENGINE: DW10TD, DW10ATED
-------------	--------	----	---------------	--------------------------

2.0 HDI 90	Diesel	66	03/99 → 12/01	ENGINE: DW10TD, DW10ATED
------------	--------	----	---------------	--------------------------

FIAT

SCUDO Combinato (220P)

2.0 JTD	Diesel	80	12/99 → 06/01	
---------	--------	----	---------------	--

SCUDO Furgonato (220L)

2.0 JTD	Diesel	69	12/99 → 06/01	
---------	--------	----	---------------	--

ULYSSE (220)

2.0 JTD	Diesel	80	10/99 → 06/01	
---------	--------	----	---------------	--

PEUGEOT

806 (221)

2.0 HDi	Diesel	80	08/99 → 12/00	ENGINE: DW10
---------	--------	----	---------------	--------------

EXPERT (224)

2.0 HDi	Diesel	69	01/03 → 11/03	ENGINE: DW10-HDI
---------	--------	----	---------------	------------------

2.0 HDi	Diesel	80	01/03 →	ENGINE: DW10-HDI
---------	--------	----	---------	------------------

2.0 HDI 16V	Diesel	80	01/03 →	ENGINE: DW10-HDI
-------------	--------	----	---------	------------------

SUA463



PEUGEOT

EXPERT Furgonato (222)

2.0 HDi	Diesel	69	01/03 →	ENGINE: DW10-HDI
---------	--------	----	---------	------------------

2.0 HDi	Diesel	80	01/03 →	ENGINE: DW10-HDI
---------	--------	----	---------	------------------

2.0 HDi	Diesel	80	01/03 →	ENGINE: DW10-HDI
---------	--------	----	---------	------------------

SUA464

J2 GRUPPO ASPIRAZIONE CARBURANTE
GA FUEL SUPPLY UNIT



PEUGEOT

407 (6D_)

1.8	Petrol	85	05/04 →	
-----	--------	----	---------	--

2.0	Petrol	100	05/04 →	
-----	--------	-----	---------	--

2.2	Petrol	116	05/04 →	
-----	--------	-----	---------	--

3.0	Petrol	155	05/04 →	
-----	--------	-----	---------	--

407 SW (6E_)

1.8	Petrol	85	05/04 →	
-----	--------	----	---------	--

2.0	Petrol	100	05/04 →	
-----	--------	-----	---------	--

2.2	Petrol	116	05/04 →	
-----	--------	-----	---------	--

3.0	Petrol	155	05/04 →	
-----	--------	-----	---------	--

SUA467
**J2
GA**
**GRUPPO ASPIRAZIONE CARBURANTE
FUEL SUPPLY UNIT**

KW

CITROËN
C8 (EA_, EB_)

2.0 HDi	Diesel	79	07/02 → 12/06
---------	--------	----	---------------

2.2 HDi	Diesel	94	07/02 → 07/06
---------	--------	----	---------------

EVASION (22, U6)

2.0 HDi	Diesel	80	07/01 → 07/02
---------	--------	----	---------------

2.0 HDi 16V	Diesel	80	07/01 → 07/02
-------------	--------	----	---------------

JUMPY (U6U)

2.0 HDi 110	Diesel	80	07/01 → 01/07
-------------	--------	----	---------------

2.0 HDi 95	Diesel	69	07/01 → 01/07
------------	--------	----	---------------

JUMPY Furgonato (BS_, BT_, BY_, BZ_)

2.0 HDi 110	Diesel	80	01/02 → 01/07
-------------	--------	----	---------------

2.0 HDi 95	Diesel	69	07/01 → 01/07
------------	--------	----	---------------

JUMPY Pianale piatto/Telaio (BU_, BV_, BW_, BX_)

2.0 HDi 110 16V	Diesel	80	12/03 → 10/06
-----------------	--------	----	---------------

2.0 HDi 95	Diesel	69	07/01 → 01/07
------------	--------	----	---------------

PEUGEOT
307 Break (3E)

1.6 HDi 110	Diesel	80	02/04 → 05/05
-------------	--------	----	---------------

2.0 HDi 110	Diesel	79	03/02 → 05/05
-------------	--------	----	---------------

2.0 HDi 135	Diesel	100	02/04 → 05/05
-------------	--------	-----	---------------

2.0 HDi 90	Diesel	66	03/02 → 05/05
------------	--------	----	---------------

307 SW (3H)

1.6 HDi 110	Diesel	80	02/04 → 05/05
-------------	--------	----	---------------

2.0 HDi 110	Diesel	79	03/02 → 05/05
-------------	--------	----	---------------

2.0 HDi 135	Diesel	100	02/04 → 05/05
-------------	--------	-----	---------------

2.0 HDi 90	Diesel	66	03/02 → 05/05
------------	--------	----	---------------

806 (221)

2.0 HDi	Diesel	80	07/01 → 08/02
---------	--------	----	---------------

2.0 HDi 16V	Diesel	80	07/01 → 08/02
-------------	--------	----	---------------

807 (E)

2.0 HDi	Diesel	79	06/02 → 12/06
---------	--------	----	---------------

2.2 HDi	Diesel	94	06/02 → 07/06
---------	--------	----	---------------

SUA467

KW

PEUGEOT
EXPERT (224)

2.0 HDi	Diesel	69	07/01 → 11/03
---------	--------	----	---------------

2.0 HDi	Diesel	80	07/01 → 01/07
---------	--------	----	---------------

2.0 HDi 16V	Diesel	80	07/01 → 01/07
-------------	--------	----	---------------

EXPERT Furgonato (222)

2.0 HDi	Diesel	69	07/01 → 01/07
---------	--------	----	---------------

2.0 HDi	Diesel	80	07/01 → 01/07
---------	--------	----	---------------

2.0 HDi	Diesel	80	07/01 → 01/07
---------	--------	----	---------------

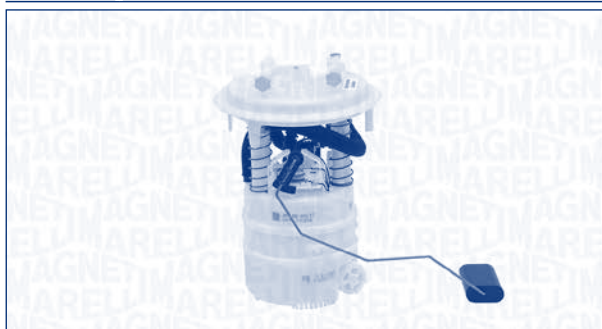
SUA468/1
**J2
GA**
**GRUPPO ASPIRAZIONE CARBURANTE
FUEL SUPPLY UNIT**

KW

PEUGEOT
406 (8B)

1.8 16V	Petrol	85	10/00 → 05/04
---------	--------	----	---------------

406 Break (8E/F)

1.8 16V	Petrol	85	10/00 → 10/04
---------	--------	----	---------------

SUA470

J2 GRUPPO ASPIRAZIONE CARBURANTE
GA FUEL SUPPLY UNIT



DACIA

LOGAN (LS_)

1.4 (LSOA, LSOC, LSOE, LSOG)	Petrol	55	09/04 →	ENGINE: K7J
1.6 (LSOB, LSOD, LSOF, LSOH)	Petrol	64	09/04 →	ENGINE: K7M

SUA472

J2 GRUPPO ASPIRAZIONE CARBURANTE
GA FUEL SUPPLY UNIT



RENAULT

CLIO I (B/C57_, 5/357_)

1.1	Petrol	34	01/91 → 01/93	
1.2 (B/C57R)	Petrol	40	01/91 → 01/93	
1.4	Petrol	59	01/91 → 01/93	
1.4 (B57J, C57J)	Petrol	55	01/91 → 01/93	

SUA471

J2 GRUPPO ASPIRAZIONE CARBURANTE
GA FUEL SUPPLY UNIT



DACIA

LOGAN (LS_)

1.4 (LSOA, LSOC, LSOE, LSOG)	Petrol	55	09/04 →	ENGINE: K7J
1.6 (LSOB, LSOD, LSOF, LSOH)	Petrol	64	09/04 →	ENGINE: K7M

SUA476

J2 GRUPPO ASPIRAZIONE CARBURANTE
GA FUEL SUPPLY UNIT



RENAULT

MODUS / GRAND MODUS (F/JP0_)

1.2 (FP0C, FP0K, FP0P)	Petrol	48	05/05 →	
1.2 (JP0C, JP0K, FP0C, FP0K, FP0P, JP0P, JP0T)	Petrol	55	12/04 →	
1.4 (JP01, JP0J)	Petrol	72	12/04 →	
1.6 (JP03, JP0B, JP0U, JP0Y, JP1G)	Petrol	82	12/04 →	
1.6 (JP0L, JP0V)	Petrol	65	12/04 →	

SUA478
J2
GA **GRUPPO ASPIRAZIONE CARBURANTE**
FUEL SUPPLY UNIT

MERCEDES-BENZ
CLASSE A (W169)

A 150 (169.031, 169.331) Petrol 70 09/04 → 06/12

A 170 (169.032, 169.332) Petrol 85 09/04 → 06/12

A 200 (169.033, 169.333) Petrol 100 09/04 → 06/12

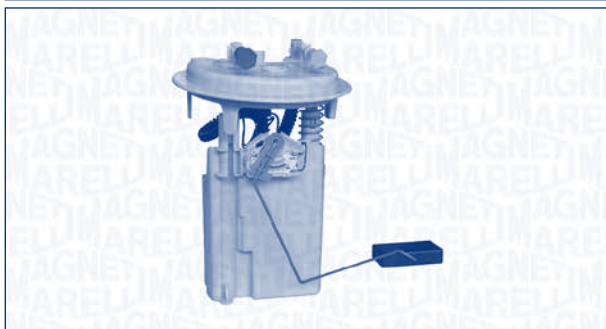
SUA493
J2
GA **GRUPPO ASPIRAZIONE CARBURANTE**
FUEL SUPPLY UNIT

CITROËN
C5 II (RC_)

2.0 HDi (RCRHRH) Diesel 100 09/04 →

2.2 HDi Diesel 125 04/06 →

2.2 HDi (RC4HXE) Diesel 98 09/04 →

C5 II Break (RE_)

2.0 HDi (RERHRH) Diesel 100 09/04 →

2.2 HDi Diesel 125 04/06 →

2.2 HDi (RE4HXE) Diesel 98 09/04 →

SUA493

PEUGEOT
307 (3A/C)

2.0 HDi 110 Diesel 79 08/00 →

2.0 HDi 135 Diesel 100 10/03 →

2.0 HDi 90 Diesel 66 08/00 →

307 Break (3E)

2.0 HDi 135 Diesel 100 02/04 →

307 CC (3B)

2.0 HDi 135 Diesel 100 06/05 →

307 SW (3H)

2.0 HDi 135 Diesel 100 02/04 →

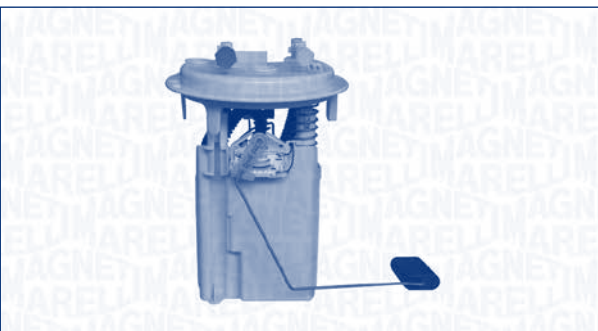
SUA494
J2
GA **GRUPPO ASPIRAZIONE CARBURANTE**
FUEL SUPPLY UNIT

CITROËN
EVASION (22, U6)

2.0 HDi Diesel 80 01/01 → 07/02 ENGINE: DW10

FIAT
SCUDO Combinato (220P)

2.0 JTD Diesel 80 07/01 → 12/06

SCUDO Furgonato (220L)

2.0 JTD Diesel 80 12/02 → 12/06

2.0 JTD Diesel 69 07/01 → 12/06

ULYSSE (179AX)

2.0 JTD Diesel 80 08/02 → 08/06

ULYSSE (220)

2.0 JTD Diesel 80 07/01 → 08/02

LANCIA
ZETA (220)

2.0 JTD (220AN5) Diesel 80 07/01 → 09/02

PEUGEOT
206 2 volumi /Coda spiovente (2A/C)

2.0 HDi 90 Diesel 66 03/02 → ENGINE: DW10TD

SUA494



PEUGEOT

206 SW (2E/K)

2.0 HDi Diesel 66 07/02 → ENGINE: DW10TD

307 (3A/C)

1.4 HDi Diesel 50 10/01 →

307 Break (3E)

1.4 HDi Diesel 50 03/02 →

2.0 HDi 110 Diesel 79 03/02 →

307 SW (3H)

2.0 HDi 110 Diesel 79 03/02 →

406 (8B)

2.2 HDi Diesel 98 01/01 → 05/04

406 Break (8E/F)

2.0 HDi 110 Diesel 80 06/00 → 04/04

2.0 HDI 90 Diesel 66 06/00 → 10/04

2.2 HDi Diesel 98 01/01 → 10/04

406 Coupé (8C)

2.2 HDi Diesel 98 01/01 → 12/04

806 (221)

2.0 HDi Diesel 80 01/01 → 08/02 ENGINE: DW10

2.0 HDI 16V Diesel 80 01/01 → 08/02 ENGINE: DW10

SUA495

J2 GA GRUPPO ASPIRAZIONE CARBURANTE FUEL SUPPLY UNIT

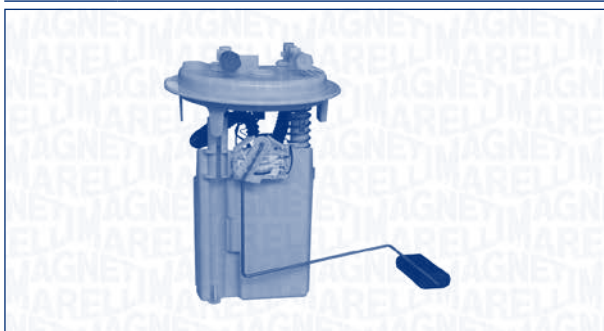

PEUGEOT

206 2 volumi /Coda spiovente (2A/C)

1.4 HDi eco 70 Diesel 50 09/01 →

206 SW (2E/K)

1.4 HDi Diesel 50 07/02 →

SUA521

J2 GA GRUPPO ASPIRAZIONE CARBURANTE FUEL SUPPLY UNIT



FIAT

BRAVA (182)

1.9 JTD 105 Diesel 77 12/98 → 09/01

BRAVO I (182)

1.9 JTD 105 Diesel 77 12/98 → 09/01

MAREA (185)

1.9 JTD 105 Diesel 77 04/99 → 01/01

2.4 JTD 130 Diesel 96 04/99 → 05/02

MAREA Weekend (185)

1.9 JTD 105 Diesel 77 04/99 → 05/02

2.4 JTD 130 Diesel 96 04/99 → 05/02

SUA523

J2 GA GRUPPO ASPIRAZIONE CARBURANTE FUEL SUPPLY UNIT



FIAT

MULTIPLA (186)

1.9 JTD 105 (186AXB1A) Diesel 77 04/99 → 12/00

1.9 JTD 110 Diesel 81 03/01 → 03/02

1.9 JTD 115 Diesel 85 07/02 → 06/10

SUA524
J2 GA GRUPPO ASPIRAZIONE CARBURANTE
FUEL SUPPLY UNIT

FIAT
IDEA

1.3 JTD	Diesel	51	01/04 →
1.9 JTD	Diesel	74	01/04 →

PUNTO (188)

1.3 JTD 16V	Diesel	51	06/03 →
1.9 JTD	Diesel	63	10/01 →
1.9 JTD	Diesel	74	06/03 →

1.9 JTD 80 (188.237, .257, .337, .357)	Diesel	59	09/99 → 06/03
--	--------	----	---------------

PUNTO Van (188AX)

1.3 JTD	Diesel	51	06/03 → 10/05
1.9 JTD	Diesel	63	02/00 → 06/03

LANCIA
MUSA (350)

1.3 D Multijet	Diesel	51	10/04 →
1.9 D Multijet	Diesel	74	10/04 →

YPSILON (843)

1.3 D Multijet	Diesel	55	09/06 → 12/11
1.3 JTD	Diesel	51	10/03 → 09/06

SUA525
J2 GA GRUPPO ASPIRAZIONE CARBURANTE
FUEL SUPPLY UNIT

LANCIA
LYBRA (839AX)

1.9 JTD	Diesel	85	05/01 → 10/05
1.9 JTD (839AXD1A)	Diesel	77	09/99 → 09/00

1.9 JTD (839AXI1A)	Diesel	81	09/00 → 05/01
2.4 JTD	Diesel	110	05/02 → 09/05

2.4 JTD (839AXE1A)	Diesel	99	09/99 → 02/01
-----------------------	--------	----	---------------

2.4 JTD (839AXL1A)	Diesel	103	09/00 → 05/02
-----------------------	--------	-----	---------------

LYBRA SW (839BX)

1.9 JTD	Diesel	85	05/01 → 10/05
1.9 JTD (839BXD1A)	Diesel	77	09/99 → 09/00

1.9 JTD (839BXI1A)	Diesel	81	09/00 → 05/01
2.4 JTD	Diesel	110	05/02 → 09/05

2.4 JTD (839BXE1A)	Diesel	99	10/99 → 09/00
-----------------------	--------	----	---------------

2.4 JTD (839BXL1A)	Diesel	103	09/00 → 05/02
-----------------------	--------	-----	---------------

SUA526

J2 GRUPPO ASPIRAZIONE CARBURANTE
GA FUEL SUPPLY UNIT



ALFA ROMEO

156 (932)

1.9 JTD (932A2B, 932A2C) Diesel 85 12/01 → 09/05

1.9 JTD (932A2B_) Diesel 81 10/00 → 05/01

2.4 JTD (932A1B_) Diesel 103 10/00 → 12/01

2.4 JTD (932AXC) Diesel 110 03/02 → 09/05

156 Sportwagon (932)

1.9 JTD (932B2B, 932B2C) Diesel 85 12/01 → 12/05

1.9 JTD (932B2B_) Diesel 81 10/00 → 05/01

2.4 JTD (932B1B_) Diesel 103 10/00 → 12/01

2.4 JTD (932BXC) Diesel 110 03/02 → 10/05

SUA527

J2 GRUPPO ASPIRAZIONE CARBURANTE
GA FUEL SUPPLY UNIT



FIAT

BRAVA (182)

1.9 JTD Diesel 74 09/00 → 09/01

BRAVO I (182)

1.9 JTD Diesel 74 09/00 → 09/01

MAREA (185)

1.9 JTD 110 Diesel 81 01/01 → 05/02

MAREA Weekend (185)

1.9 JTD 110 Diesel 81 01/01 → 05/02

SUA528

J2 GRUPPO ASPIRAZIONE CARBURANTE
GA FUEL SUPPLY UNIT



FIAT

DUCATO Autobus (230)

2.0 JTD Diesel 62 10/01 → 03/02

2.8 JTD Diesel 94 11/00 → 03/02

2.8 JTD 4x4 Diesel 94 11/00 → 03/02 ENGINE: 814043S

DUCATO Autobus (244, Z_)

2.0 JTD Diesel 62 04/02 → 08/06

2.3 JTD Diesel 81 04/02 → 08/06

2.8 JTD Diesel 94 04/02 → 08/06

2.8 JTD 4x4 Diesel 94 07/02 → 08/06

SUA528

FIAT
DUCATO Furgonato (230L)

2.0 JTD	Diesel	62	10/01 → 03/02	
2.8 JTD	Diesel	94	11/00 → 03/02	
2.8 JTD 4x4	Diesel	94	11/00 → 03/02	ENGINE: 814043S

DUCATO Furgonato (244)

2.0 JTD	Diesel	62	04/02 → 08/06	
2.3 JTD	Diesel	81	04/02 → 08/06	
2.8 JTD	Diesel	94	04/02 → 08/06	
2.8 JTD 4x4	Diesel	94	07/02 → 08/06	

DUCATO Pianale piatto/Telaio (230)

2.8 JTD	Diesel	94	11/00 → 03/02	
---------	--------	----	---------------	--

DUCATO Pianale piatto/Telaio (244)

2.0 JTD	Diesel	62	04/02 → 07/06	
2.3 JTD	Diesel	81	04/02 → 07/06	
2.8 JTD	Diesel	94	04/02 → 07/06	
2.8 JTD 4x4	Diesel	94	10/02 → 07/06	

SUA529
**J2
GA**
**GRUPPO ASPIRAZIONE CARBURANTE
FUEL SUPPLY UNIT**

FIAT
STILO (192)

1.9 D Multijet	Diesel	74	09/05 → 11/06	
1.9 JTD (192_XE1A)	Diesel	85	10/01 → 11/06	ENGINE: 192A1000
1.9 JTD (192_XF1A)	Diesel	59	02/02 → 12/03	

STILO Multi Wagon (192)

1.9 D Multijet	Diesel	74	09/05 → 08/08	
1.9 JTD	Diesel	59	01/03 → 08/08	
1.9 JTD	Diesel	85	01/03 → 08/08	ENGINE: 192A1000

SUA530
**J2
GA**
**GRUPPO ASPIRAZIONE CARBURANTE
FUEL SUPPLY UNIT**

PEUGEOT
406 (8B)

2.0 HDi 110	Diesel	80	03/99 → 05/00	
2.0 HDi 90	Diesel	66	03/99 → 05/00	

406 Break (8E/F)

2.0 HDi 110	Diesel	80	03/99 → 05/00	
2.0 HDi 90	Diesel	66	03/99 → 05/00	

SUA531
**J2
GA**
**GRUPPO ASPIRAZIONE CARBURANTE
FUEL SUPPLY UNIT**

FIAT
DOBLO (119)

1.3 JTD	Diesel	55	09/05 →	
1.9 JTD	Diesel	77	07/03 →	
1.9 JTD (223AXE1A)	Diesel	74	10/01 → 01/04	

DOBLO Cargo (223)

1.3 D Multijet	Diesel	55	10/05 → 01/10	
1.3 JTD 16V	Diesel	51	05/04 → 09/05	
1.9 JTD	Diesel	77	07/03 →	
1.9 JTD (223ZXE1A)	Diesel	74	10/01 → 01/04	

SUA532

J2 GRUPPO ASPIRAZIONE CARBURANTE
GA FUEL SUPPLY UNIT



ALFA ROMEO

147 (937)

1.9 JTD 16V	Diesel	100	10/04 → 03/10
1.9 JTD 16V	Diesel	93	09/03 → 09/04
1.9 JTD 16V	Diesel	103	11/02 → 09/03
1.9 JTDM 16V	Diesel	110	09/04 → 03/10 ENGINE: 937A5000

SUA533

J2 GRUPPO ASPIRAZIONE CARBURANTE
GA FUEL SUPPLY UNIT



ALFA ROMEO

156 (932)

1.9 JTD 16V	Diesel	103	11/02 → 09/05
2.4 JTD	Diesel	129	10/03 → 09/05

156 Sportwagon (932)

1.9 JTD	Diesel	110	03/05 → 12/05
1.9 JTD 16V	Diesel	103	11/02 → 12/05
1.9 JTD 16V Q4	Diesel	110	09/04 → 12/05
2.4 JTD	Diesel	129	10/03 → 12/05

GT (937)

1.9 JTD	Diesel	110	11/03 → 09/10
---------	--------	-----	---------------

SUA534

J2 GRUPPO ASPIRAZIONE CARBURANTE
GA FUEL SUPPLY UNIT



FIAT

DUCATO Furgonato (244)

2.8 JTD Power	Diesel	107	05/04 → 08/06
---------------	--------	-----	---------------

DUCATO Pianale piatto/Telaio (244)

2.8 JTD Power	Diesel	107	05/04 → 07/06
---------------	--------	-----	---------------

SUA535

J2 GRUPPO ASPIRAZIONE CARBURANTE
GA FUEL SUPPLY UNIT



FIAT

DOBLO (119)

1.3 D Multijet	Diesel	62	10/05 →
1.9 D Multijet	Diesel	88	10/05 →

SUA536
J2 GA GRUPPO ASPIRAZIONE CARBURANTE
FUEL SUPPLY UNIT

ALFA ROMEO
156 (932)

1.6 16V T.SPARK (932A4)	Petrol	88	09/97 → 09/00	ENGINE: AR67601-AR32102
1.8 16V T.SPARK (932A3)	Petrol	106	09/97 → 09/00	
2.0 16V T.SPARK (932A2)	Petrol	114	09/97 → 09/00	
2.0 Twin Spark	Petrol	118	11/97 → 04/00	
2.5 V6 24V (932A1)	Petrol	140	09/97 → 09/00	

156 Sportwagon (932)

1.6 16V T.SPARK. (932A4)	Petrol	88	05/00 → 09/00	ENGINE: AR67601
1.8 16V T.SPARK (932A3)	Petrol	106	05/00 → 09/00	
2.0 16V T.SPARK (932A2)	Petrol	114	05/00 → 09/00	
2.5 V6 24V (932A1)	Petrol	140	05/00 → 09/00	

SUA537
J2 GA GRUPPO ASPIRAZIONE CARBURANTE
FUEL SUPPLY UNIT

FIAT
BRAVA (182)

1.2 16V 80 Petrol 60 12/98 → 12/02

BRAVO I (182)

1.2 16V 80 Petrol 60 12/98 → 10/00

MAREA (185)

1.2 16V Petrol 60 02/99 → 05/02

MAREA Weekend (185)

1.2 16V Petrol 60 02/99 → 05/02

SUA538
J2 GA GRUPPO ASPIRAZIONE CARBURANTE
FUEL SUPPLY UNIT

ALFA ROMEO
156 (932)

1.6 16V T.SPARK (932A4)	Petrol	88	09/97 → 09/00	ENGINE: AR67601
-------------------------	--------	----	---------------	-----------------

SUA539

J2 GRUPPO ASPIRAZIONE CARBURANTE
GA FUEL SUPPLY UNIT



ALFA ROMEO

147 (937)

1.6 16V T.SPARK (937AXB1A)	Petrol	88	01/01 → 03/02	
1.6 16V T.SPARK ECO (937AXA1A)	Petrol	77	01/01 → 03/02	
1.9 JTD	Diesel	74	06/03 → 10/06	
1.9 JTD (937AXD1A)	Diesel	85	04/01 → 03/05	
1.9 JTDM	Diesel	85	12/05 → 03/10	
1.9 JTDM 8V	Diesel	88	07/05 → 03/10	
2.0 16V T.SPARK (937AXC1_)	Petrol	110	01/01 → 03/02	

SUA540

J2 GRUPPO ASPIRAZIONE CARBURANTE
GA FUEL SUPPLY UNIT



ALFA ROMEO

156 (932)

1.6 16V T.SPARK (932A4)	Petrol	88	08/00 → 02/03	ENGINE: AR32104-AR67601
1.8 16V T.SPARK (932A31_)	Petrol	103	10/00 → 02/03	

SUA540



ALFA ROMEO

156 (932)

2.0 16V T.SPARK (932A21_)	Petrol	110	10/00 → 12/01	
2.5 V6 24V (932A11_)	Petrol	141	12/01 → 02/03	
3.2 GTA (932AXB)	Petrol	184	03/02 → 02/03	

156 Sportwagon (932)

1.6 16V T.SPARK (932A4)	Petrol	88	08/00 → 02/03	ENGINE: AR32104-AR67601
1.8 16V T.SPARK (932B31_)	Petrol	103	10/00 → 02/03	
2.0 16V T.SPARK (932B21_)	Petrol	110	10/00 → 12/01	
2.5 V6 24V (932B11_)	Petrol	141	10/00 → 02/03	
3.2 GTA (932BXB)	Petrol	184	03/02 → 02/03	

SUA541

J2 GRUPPO ASPIRAZIONE CARBURANTE
GA FUEL SUPPLY UNIT



FIAT

BRAVA (182)

1.2 16V 80	Petrol	59	10/00 → 09/01	
------------	--------	----	---------------	--

BRAVO I (182)

1.2 16V 80	Petrol	59	10/00 → 09/01	
------------	--------	----	---------------	--

MAREA (185)

2.0 150 20V	Petrol	110	01/01 → 05/02	
-------------	--------	-----	---------------	--

MAREA Weekend (185)

2.0 150 20V	Petrol	110	01/01 → 05/02	
-------------	--------	-----	---------------	--

SUA542
J2
GA **GRUPPO ASPIRAZIONE CARBURANTE**
FUEL SUPPLY UNIT

LANCIA
Y (840A)

1.2 16V (840AG1A)	Petrol	59	10/00 → 06/03
----------------------	--------	----	---------------

SUA543
J2
GA **GRUPPO ASPIRAZIONE CARBURANTE**
FUEL SUPPLY UNIT

ALFA ROMEO
156 (932)

2.0 JTS (932AXA)	Petrol	122	03/02 → 09/05
------------------	--------	-----	---------------

156 Sportwagon (932)

2.0	Petrol	119	03/02 → 12/05
-----	--------	-----	---------------

2.0 JTS (932BXA)	Petrol	122	03/02 → 12/05
------------------	--------	-----	---------------

GT (937)

2.0 JTS	Petrol	121	11/03 → 09/10
---------	--------	-----	---------------

SUA544
J2
GA **GRUPPO ASPIRAZIONE CARBURANTE**
FUEL SUPPLY UNIT

FIAT
BRAVO II (198)

1.4	Petrol	66	04/07 →
-----	--------	----	---------

STILO (192)

1.2 16V (192_XA1B)	Petrol	59	02/02 → 05/02
-----------------------	--------	----	---------------

1.4 16V	Petrol	66	03/05 → 11/06
---------	--------	----	---------------

1.4 16V	Petrol	70	01/04 → 11/06
---------	--------	----	---------------

1.6 16V (192_XB1A)	Petrol	76	10/01 → 05/02
-----------------------	--------	----	---------------

1.8 16V (192_XC1A)	Petrol	98	10/01 → 05/02
-----------------------	--------	----	---------------

2.4 20V (192_XD1A)	Petrol	125	10/01 → 05/02
-----------------------	--------	-----	---------------

STILO Multi Wagon (192)

1.4 16V	Petrol	66	03/05 → 08/08
---------	--------	----	---------------

1.4 16V	Petrol	70	01/04 → 08/08
---------	--------	----	---------------

1.6 16V	Petrol	76	01/03 → 08/08
---------	--------	----	---------------

1.8 16V	Petrol	98	01/03 → 08/08
---------	--------	----	---------------

SUA545

J2 GA GRUPPO ASPIRAZIONE CARBURANTE
FUEL SUPPLY UNIT



ALFA ROMEO

147 (937)

1.6 16V T.SPARK (937AXB1A)	Petrol	88	03/02 → 03/10	
1.6 16V T.SPARK ECO (937AXA1A)	Petrol	77	03/02 → 03/10	
2.0 16V T.SPARK (937AXC1_)	Petrol	110	03/02 → 03/10	
3.2 GTA	Petrol	184	02/03 → 03/10	

SUA547

J2 GA GRUPPO ASPIRAZIONE CARBURANTE
FUEL SUPPLY UNIT



ALFA ROMEO

156 (932)

1.6 16V T.SPARK (932A4)	Petrol	88	02/03 → 09/05	ENGINE: AR32104
1.8 16V T.SPARK (932A31_)	Petrol	103	02/03 → 09/05	ENGINE: AR32205(M5)
2.5 V6 24V (932A11_)	Petrol	141	02/03 → 09/05	
3.2 GTA (932AXB)	Petrol	184	02/03 → 09/05	

SUA547



ALFA ROMEO

156 Sportwagon (932)

1.6 16V T.SPARK (932A4)	Petrol	88	02/03 → 12/05	ENGINE: AR67601-AR32102-AR32104-AR32103
1.8 16V T.SPARK (932B31_)	Petrol	103	02/03 → 12/05	ENGINE: AR32205(M5)
2.5 V6 24V (932B11_)	Petrol	141	02/03 → 10/05	ENGINE: AR32405(M15)
3.2 GTA (932BXB)	Petrol	184	02/03 → 10/05	

GT (937)

1.8 TS	Petrol	103	11/03 → 09/10	
3.2 GTA	Petrol	176	11/03 → 09/10	

SUA548

J2 GA GRUPPO ASPIRAZIONE CARBURANTE
FUEL SUPPLY UNIT



OPEL

ASTRA H (L48)

1.2	Petrol	59	02/07 → 03/09	
1.4	Petrol	66	03/04 →	
1.6	Petrol	85	12/06 →	
1.6	Petrol	77	03/04 → 03/07	
1.8	Petrol	103	01/06 →	
1.8	Petrol	92	03/04 → 02/09	

ASTRA H GTC (L08)

1.2	Petrol	59	02/07 → 03/09	
1.4	Petrol	66	03/05 →	CHASSIS: →65125614
1.6	Petrol	77	03/05 → 03/08	CHASSIS: →65125614
1.6	Petrol	85	12/06 →	CHASSIS: →65125614
1.8	Petrol	103	01/06 →	
1.8	Petrol	92	03/05 → 03/08	

ASTRA H Station wagon (L35)

1.6	Petrol	77	08/04 → 03/07	
1.6	Petrol	85	02/07 →	

SUA548

KW

OPEL
ASTRA H Station wagon (L35)

1.8	Petrol	103	08/05 →
1.8	Petrol	92	08/04 → 02/09

ASTRA H Tre volumi (L69)

1.6	Petrol	85	02/07 →
-----	--------	----	---------

ASTRA H TwinTop (L67)

1.6	Petrol	77	09/05 → 03/08	CHASSIS: →65125614
1.8	Petrol	103	09/05 →	
1.8	Petrol	92	09/05 → 03/08	

VAUXHALL
ASTRA Mk V (H) 2 volumi /Coda spiovente

1.4	Petrol	66	01/04 → 05/09	
1.6	Petrol	77	01/04 → 03/07	
1.6	Petrol	85	02/07 → 05/09	CHASSIS: →65125614
1.8	Petrol	103	01/04 → 05/09	
1.8	Petrol	92	01/04 → 02/09	

ASTRA Mk V (H) Sport Hatch

1.6	Petrol	77	08/05 → 03/08	CHASSIS: →65125614
1.8	Petrol	92	05/05 → 02/09	

ASTRA Mk V (H) Station wagon

1.4	Petrol	66	08/04 → 03/09
1.6	Petrol	77	08/04 → 03/07
1.6	Petrol	85	08/07 → 03/09
1.8	Petrol	92	10/04 → 02/09

ASTRA TwinTop Mk V (H)

1.6	Petrol	77	09/05 → 03/08	CHASSIS: →65125614
1.6 i 16V	Petrol	85	02/07 → 11/10	CHASSIS: →65125614

SUA549
**J2
GA**
**GRUPPO ASPIRAZIONE CARBURANTE
FUEL SUPPLY UNIT**

KW

OPEL
ASTRA H (L48)

2.0 Turbo	Petrol	125	03/04 → 02/09
-----------	--------	-----	---------------

SUA549

KW

OPEL
ASTRA H GTC (L08)

2.0 Turbo	Petrol	125	03/05 → 02/09
-----------	--------	-----	---------------

ASTRA H Station wagon (L35)

2.0 Turbo	Petrol	125	08/04 → 02/09
-----------	--------	-----	---------------

ASTRA H TwinTop (L67)

2.0 Turbo	Petrol	125	09/05 → 02/09
-----------	--------	-----	---------------

VAUXHALL
ASTRA Mk V (H) 2 volumi /Coda spiovente

2.0 Turbo	Petrol	125	01/04 → 02/09
-----------	--------	-----	---------------

ASTRA Mk V (H) Sport Hatch

2.0 Turbo	Petrol	125	05/05 → 02/09
-----------	--------	-----	---------------

ASTRA Mk V (H) Station wagon

2.0 Turbo	Petrol	125	08/04 → 02/09
-----------	--------	-----	---------------

ASTRA TwinTop Mk V (H)

2.0	Petrol	125	02/06 → 11/10
-----	--------	-----	---------------

SUA550
**J2
GA**
**GRUPPO ASPIRAZIONE CARBURANTE
FUEL SUPPLY UNIT**

KW

FIAT
CROMA (194)

1.8 16V	Petrol	103	12/05 →
2.2 16V	Petrol	108	06/05 →

STILO (192)

1.6	Petrol	100	06/05 → 11/06
-----	--------	-----	---------------

SUA551

J2 GRUPPO ASPIRAZIONE CARBURANTE
GA FUEL SUPPLY UNIT



ALFA ROMEO

MITO (955)

1.4 Petrol 58 09/08 →

FIAT

PUNTO / GRANDE PUNTO (199)

1.2 Petrol 48 10/05 →

1.4 Petrol 57 10/05 →

1.4 16V Petrol 70 02/06 →

ESS0003A

J1 POMPA CARBURANTE
PB FUEL PUMP



AUDI

Q7 (4L)

3.0 TDI Diesel 155 03/06 → 05/10

3.0 TDI Diesel 171 03/06 → 05/08

VOLKSWAGEN

TOUAREG (7LA, 7L6, 7L7)

3.0 V6 TDI Diesel 165 11/04 → 05/10

ESS0015A

J1 POMPA CARBURANTE
PB FUEL PUMP

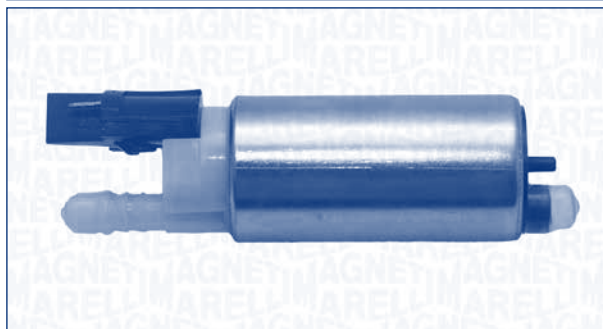

CITROËN

C4 Coupé (LA_)

1.4 16V Petrol 65 11/04 →

1.6 16V Petrol 80 11/04 →

2.0 16V Petrol 100 11/04 →

2.0 16V Petrol 130 11/04 →

C4 I (LC_)

1.4 16V Petrol 65 11/04 →

1.6 16V Petrol 80 11/04 →

2.0 16V Petrol 100 11/04 →

PEUGEOT

307 Break (3E)

1.6 16V Petrol 80 03/02 →

307 CC (3B)

1.6 16V Petrol 80 02/05 →

307 SW (3H)

1.6 16V Petrol 80 03/02 →

ESS0021A

J1 POMPA CARBURANTE
PB FUEL PUMP

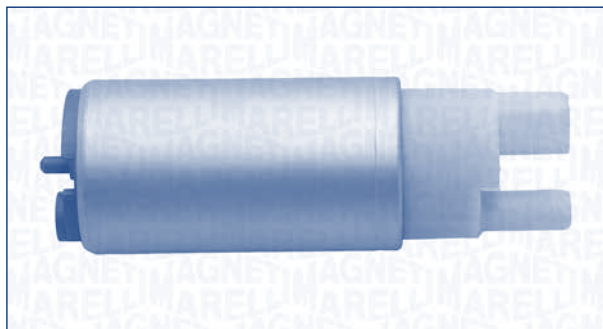

KIA

PICANTO (BA)

1.1 Petrol 48 04/04 →

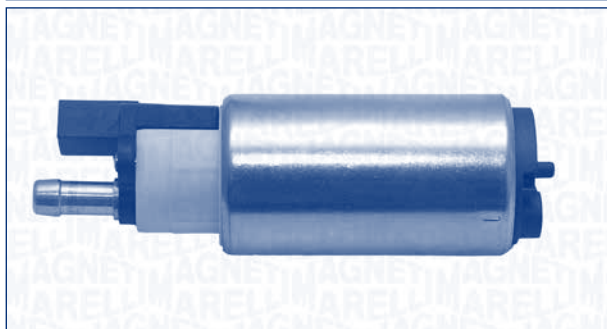
ESS0026A
J1
PB **POMPA CARBURANTE**
FUEL PUMP

TOYOTA
4 RUNNER (RN10_, VZN13_, VZN10_, RN13_)

2.7 i Petrol 112 11/95 → 03/96

3.4 i Petrol 136 11/95 → 03/96

CAMRY (_CV1_, _XV1_, _V1_)

2.2 (SXV10) Petrol 100 06/91 → 08/96

3.0 (VCV10) Petrol 138 06/91 → 08/96

CAMRY (_CV2_, _XV2_)

2.2 Petrol 93 11/00 → 11/01

CAMRY (MCV3_, ACV3_, _XV3_)

3.0 V6 Petrol 137 11/01 → 11/06

CAMRY Station Wagon (_XV1_, _CV1_, _V10)

2.2 (SXV10) Petrol 100 03/92 → 07/96

CARINA E (_T19_)

1.6 16V Petrol 78 10/95 → 09/97

CELICA (ST20_, AT20_)

 1.8 i 16V
(AT200/ST) Petrol 85 11/93 → 11/99

2.0 i 16V Petrol 125 04/96 → 11/99

 2.0 i 16V
(ST202/GT) Petrol 129 11/93 → 11/99

COROLLA (_E10_)

 1.3 XLI 16V
(EE101) Petrol 65 07/92 → 09/95

1.6 Si (AE101_) Petrol 84 09/95 → 04/97

COROLLA Compact (_E10_)

1.8 GT (AE102_) Petrol 86 11/92 → 05/95

COROLLA Wagon (_E11_)

1.8 4WD (AE115_) Petrol 81 04/97 → 10/01

COROLLA Wagon (_E10_)

1.6 Si (AE101_) Petrol 84 07/92 → 04/97

 1.8 16V 4WD
(AE103_) Petrol 81 09/95 → 04/97

PASEO Coupé (EL54)

1.5 16V Petrol 66 08/95 → 07/99

ESS0026A

TOYOTA
PICNIC (_XM10)

2.0 Petrol 90 01/01 → 12/01

RAV 4 I (SXA1_)

2.0 4WD Petrol 95 06/94 → 06/00

RAV 4 I Cabrio (SXA1_)

2.0 16V 4WD Petrol 94 12/97 → 06/00

STARLET (EP91)

1.3 Petrol 55 04/96 → 03/99

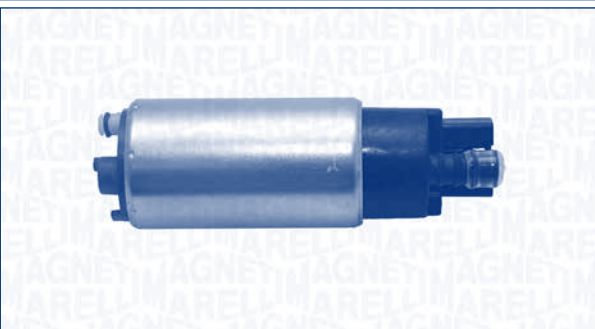
ESS0028A
J1
PB **POMPA CARBURANTE**
FUEL PUMP

FIAT
IDEA

1.2 16V Petrol 59 01/04 →

1.4 Petrol 57 10/05 →

1.4 16V Petrol 70 01/04 →

PUNTO (188)

 1.2 16V 80
(188.233, .235,
.253, .255, .333,
.353, .639...) Petrol 59 09/99 →

1.4 Petrol 70 09/03 →

LANCIA
MUSA (350)

1.4 Petrol 57 09/05 →

1.4 Petrol 70 10/04 →

YPSILON (843)

1.2 Petrol 59 10/03 → 12/11

1.4 Petrol 57 02/06 → 12/11

1.4 16V Petrol 70 10/03 → 12/11

ESS0026A



OPEL

ASTRA H (L48)

1.4	Petrol	66	03/04 →
1.6	Petrol	77	03/04 →
1.6	Petrol	85	12/06 →
1.8	Petrol	103	01/06 →
1.8	Petrol	92	03/04 →

ASTRA H GTC (L08)

1.4	Petrol	66	03/05 →
1.6	Petrol	77	03/05 →
1.6	Petrol	85	12/06 →

ASTRA H Station wagon (L35)

1.4	Petrol	66	08/04 →
1.6	Petrol	77	08/04 →
1.6	Petrol	85	12/06 →
1.8	Petrol	103	08/05 →
1.8	Petrol	92	08/04 →

ASTRA H TwinTop (L67)

1.6	Petrol	77	09/05 →
1.6	Petrol	85	12/06 →
1.8	Petrol	92	09/05 →

CORSA D

1.0	Petrol	44	07/06 →
1.2	Petrol	59	07/06 →
1.4 LPG	Petrol/ LPG	66	07/06 →

ESS0030A

J1 POMPA CARBURANTE
PB FUEL PUMP

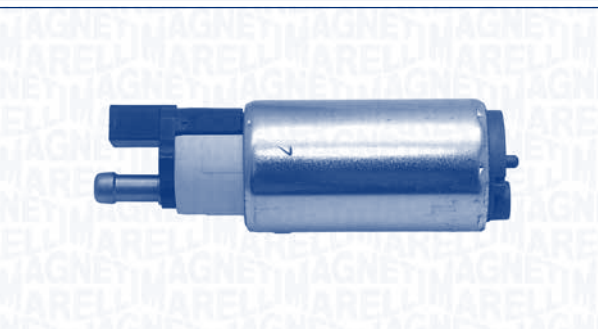

FORD

FIESTA IV (JA_, JB_)

1.25 i 16V	Petrol	55	08/95 → 01/02
1.3 i	Petrol	44	08/95 → 01/02

ESS0031A

J1 POMPA CARBURANTE
PB FUEL PUMP

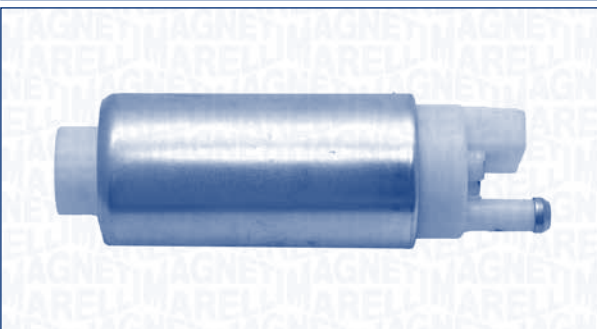

SMART

FORTWO Cabrio (450)

0.8 CDI (450.401, 450.402, 450.403)	Diesel	30	01/04 → 01/07
-------------------------------------	--------	----	---------------

FORTWO Coupé (450)

0.8 CDI (450.300, 450.301, 450.302, 450.303, 450.306)	Diesel	30	01/04 → 01/07
---	--------	----	---------------

ESS0032A

J1 POMPA CARBURANTE
PB FUEL PUMP

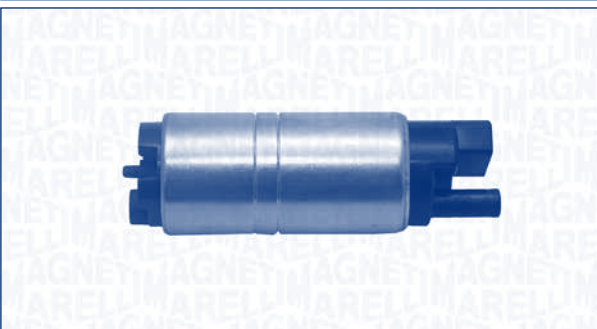

TOYOTA

YARIS (SCP1_, NLP1_, NCP1_)

1.0 16V	Petrol	50	04/99 → 09/05
1.3 16V	Petrol	63	11/99 → 09/05
1.5 VVT-i TS	Petrol	78	04/01 → 09/05

YARIS VERSO (_NLP2_, _NCP2_)

1.3 (NCP22)	Petrol	63	08/99 → 09/05
1.5 (NCP21)	Petrol	78	03/00 → 09/05

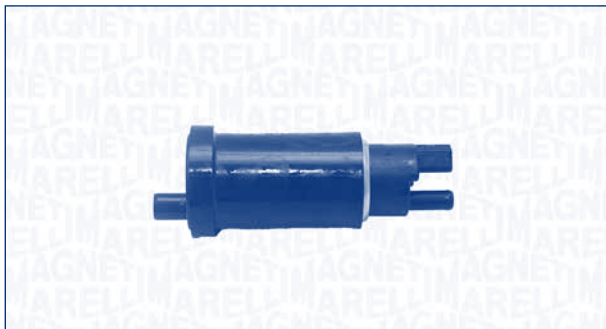
ESS0034A
J1 POMPA CARBURANTE
PB FUEL PUMP

CITROËN
AX (ZA-_)

10	Petrol	33	07/86 → 12/98
10	Petrol	37	02/87 → 12/98
11	Petrol	44	09/86 → 12/97
14	Petrol	55	04/87 → 04/97
14 4x4	Petrol	55	08/91 → 12/96

C15 (VD-_)

1.4 i	Petrol	55	05/91 → 12/96
-------	--------	----	---------------

SAXO (S0, S1)

1.1 X,SX	Petrol	44	05/96 → 09/03
----------	--------	----	---------------

ZX (N2)

1.1	Petrol	44	03/91 → 06/97
-----	--------	----	---------------

PEUGEOT
106 I (1A, 1C)

1.0	Petrol	33	09/91 → 04/96
1.0	Petrol	37	09/91 → 04/96
1.1	Petrol	44	09/91 → 04/96
1.4	Petrol	55	09/91 → 04/96

205 I Cabriolet (741B, 20D)

1.1 CJ	Petrol	44	10/89 → 12/94
1.4 CJ	Petrol	55	05/91 → 12/94

205 II (20A/C)

1.1	Petrol	44	07/89 → 09/98
1.4	Petrol	55	07/88 → 09/98
1.6 Aut.	Petrol	65	05/90 → 09/98

306 (7B, N3, N5)

1.1	Petrol	44	06/94 → 05/01
-----	--------	----	---------------

RANCH MPV / Space wagon (5F)

1.1	Petrol	44	06/96 →
-----	--------	----	---------

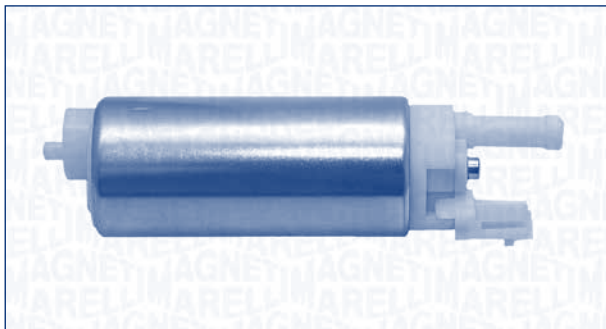
ESS0039A
J1 POMPA CARBURANTE
PB FUEL PUMP

ALFA ROMEO
145 (930)

1.6 i.e.	Petrol	76	10/94 → 12/96
----------	--------	----	---------------

146 (930)

1.6 i.e.	Petrol	76	12/94 → 12/96
----------	--------	----	---------------

FIAT
TEMPRA (159)

1.6 i.e. (159.AJ)	Petrol	66	06/94 → 08/96
1.8 i.e. (159.AN)	Petrol	77	03/92 → 08/96
1.8 i.e. (159.AN)	Petrol	81	03/90 → 08/96
1.8 i.e. (159.AV)	Petrol	76	09/93 → 08/96
1.8 i.e. (159.AZ)	Petrol	66	09/93 → 08/96
1.8 i.e. (159.BY)	Petrol	74	10/94 → 08/96
2.0 i.e. (159.AP)	Petrol	83	10/90 → 08/96

TEMPRA S.W. (159)

1.6 i.e. (159.AJ)	Petrol	66	06/94 → 08/96
1.8 i.e. (159.AN)	Petrol	81	03/90 → 08/96
1.8 i.e. (159.AV)	Petrol	76	09/93 → 08/96
1.8 i.e. (159.AZ)	Petrol	66	09/93 → 08/96
1.8 i.e. (159.BY)	Petrol	74	10/94 → 08/96
2.0 i.e. (159.AP)	Petrol	83	01/91 → 03/95

TIPO (160)

1.6 i.e.	Petrol	66	02/88 → 05/91
1.8 i.e.	Petrol	66	09/93 → 04/95
1.8 i.e. (160.ED)	Petrol	76	04/93 → 04/95
1.8 i.e. (160.EQ, 160.AM)	Petrol	74	10/94 → 10/95
2.0 16V (160.AV)	Petrol	107	07/91 → 04/95
2.0 i.e. (160.AT, 160.AJ)	Petrol	83	03/90 → 04/95
2.0 i.e. 16V Sport (160.EF)	Petrol	102	03/93 → 04/95

ESS0039A



LANCIA

DEDRA (835)

1.6 LE (835EB) Cat.	Petrol	66	07/94 → 07/99
---------------------	--------	----	---------------

2.0 HF Integrale (835AP)	Petrol	124	11/90 → 07/94
--------------------------	--------	-----	---------------

2.0 i.e. Turbo (835AR)	Petrol	119	04/91 → 07/99
------------------------	--------	-----	---------------

2.0 i.e. Turbo Integrale (835AO)	Petrol	121	05/90 → 07/94
----------------------------------	--------	-----	---------------

2.0 Turbo (835AQ)	Petrol	130	11/90 → 06/94
-------------------	--------	-----	---------------

DEDRA SW (835)

1.6 (835EB)	Petrol	66	10/94 → 07/99
-------------	--------	----	---------------

DELTA I (831AB0)

1.6 GT i.e. (831AB.010)	Petrol	66	05/87 → 08/92
-------------------------	--------	----	---------------

DELTA II (836)

2.0 16V (836AA, 836CA)	Petrol	102	06/93 → 08/99
------------------------	--------	-----	---------------

LAND ROVER

RANGE ROVER I (AE, AN, HAA, HAB, HAM, HBM, RE, RN)

3.5 4x4	Petrol	107	01/87 → 09/90
---------	--------	-----	---------------

3.5 Vogue 4x4	Petrol	120	10/85 → 09/90
---------------	--------	-----	---------------

3.9 4x4 Cat.	Petrol	127	11/88 → 07/94
--------------	--------	-----	---------------

3.9 Vogue SEI 4x4	Petrol	134	11/88 → 07/94
-------------------	--------	-----	---------------

4.3 Vogue LSE 4x4	Petrol	149	09/92 → 07/94
-------------------	--------	-----	---------------

OPEL

FRONTERA A (5_MWL4)

2.2 i (54MWL4)	Petrol	100	03/95 → 10/98
----------------	--------	-----	---------------

2.4 i (53MWL4)	Petrol	92	03/92 → 10/98
----------------	--------	----	---------------

FRONTERA A Sport (5_SUD2)

2.0 i (52SUD2, 55SUD2)	Petrol	85	03/92 → 10/98
------------------------	--------	----	---------------

FRONTERA B (6B_)

2.2 i (6B_ZC, 6B_VF, 6B_66, 6B_76)	Petrol	100	10/98 →
------------------------------------	--------	-----	---------

3.2 i (6B1VF, 6B1_6)	Petrol	151	10/98 →
----------------------	--------	-----	---------

ROVER

800 (XS)

820 16 V I/SI (XS)	Petrol	103	10/86 → 10/88
--------------------	--------	-----	---------------

820 I/SI (RS)	Petrol	100	01/92 → 02/99
---------------	--------	-----	---------------

820 SI (XS)	Petrol	98	10/88 → 12/91
-------------	--------	----	---------------

820e	Petrol	88	10/86 → 10/91
------	--------	----	---------------

ESS0039A



ROVER

800 (XS)

825 SI/Sterling (XS)	Petrol	127	01/87 → 12/91
----------------------	--------	-----	---------------

825 SI/Sterling (XS) Cat.	Petrol	110	10/86 → 12/91
---------------------------	--------	-----	---------------

827 SI/Sterling (XS)	Petrol	130	02/88 → 12/91
----------------------	--------	-----	---------------

827 SI/Sterling (XS) Cat.	Petrol	124	02/88 → 02/99
---------------------------	--------	-----	---------------

800 2 volumi /Coda spiovente (XS)

820 I/SI (XS)	Petrol	100	01/93 → 02/99
---------------	--------	-----	---------------

820 I/SI (XS)	Petrol	103	10/88 → 12/91
---------------	--------	-----	---------------

820 SI (XS)	Petrol	98	10/88 → 12/91
-------------	--------	----	---------------

827 Vitesse (XS) Cat.	Petrol	124	10/88 → 12/91
-----------------------	--------	-----	---------------

827 Vitesse/SLI	Petrol	130	10/88 → 12/91
-----------------	--------	-----	---------------

ESS0040A

J1	POMPA CARBURANTE FUEL PUMP
PB	



FIAT

PALIO (178BX)

1.0	Petrol	45	04/96 →
-----	--------	----	---------

1.6 16V	Petrol	74	04/96 →
---------	--------	----	---------

PALIO Weekend (178DX)

1.2 (178DX.G1A)	Petrol	54	04/96 → 02/01
-----------------	--------	----	---------------

1.6 16V (178DX.D1A)	Petrol	74	04/96 → 02/01
---------------------	--------	----	---------------

1.6 16V (178DYC1A06)	Petrol	76	02/01 →
----------------------	--------	----	---------

SIENA (178_)

1.2	Petrol	54	09/98 →
-----	--------	----	---------

1.6 16V	Petrol	78	09/98 →
---------	--------	----	---------

STRADA Pick-up (178E)

1.2	Petrol	54	06/99 →
-----	--------	----	---------

ESS0042A
J1 POMPA CARBURANTE
PB FUEL PUMP

KW

SEAT
CORDOBA (6K1, 6K2)

1.4 i Petrol 44 06/94 → 06/99

1.6 i Petrol 55 02/93 → 06/99

1.6 i Petrol 55 05/94 → 06/99

CORDOBA Vario (6K5)

1.6 i Petrol 55 05/97 → 06/99

IBIZA II (6K1)

1.3 i Petrol 40 03/93 → 08/99

1.6 i Petrol 55 09/94 → 06/99

TOLEDO I (1L)

1.6 i Petrol 54 09/96 → 03/99

1.6 i Petrol 55 09/96 → 03/99

1.8 i Petrol 66 09/96 → 12/96

VOLKSWAGEN
CADDY II Station wagon (9K9B)

1.6 Petrol 55 11/95 → 05/97

GOLF III (1H1)

1.8 Syncro (1HX1) Petrol 66 01/93 → 08/97

PASSAT (3A2, 35I)

1.8 Petrol 55 02/92 → 08/96

1.8 Petrol 66 02/92 → 08/96

PASSAT Variant (3A5, 35I)

1.8 Petrol 55 02/92 → 05/97

1.8 Petrol 66 02/92 → 05/97

POLO (6N1)

55 1.3 Petrol 40 10/94 → 07/95

POLO CLASSIC (6KV2)

75 1.6 Petrol 55 11/95 → 09/97

90 1.8 Petrol 66 01/97 → 09/01

POLO Furgonato (6NF)

1.0 Petrol 33 10/94 → 12/99

POLO Variant (6KV5)

1.8 Petrol 66 05/97 → 09/01

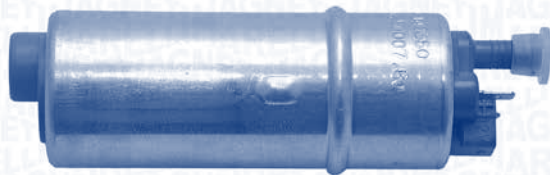
ESS0076A
J1 POMPA CARBURANTE
PB FUEL PUMP

KW

BMW
X5 (E53)

4.8 is Petrol 265 04/04 →

X5 (E70)

4.8 i xDrive Petrol 261 02/07 → 09/08

LAND ROVER
RANGE ROVER III (LM)

4.4 4x4 Petrol 210 03/02 → 08/12

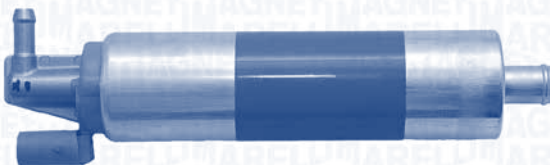
ESS0077A
J1 POMPA CARBURANTE
PB FUEL PUMP

KW

MERCEDES-BENZ
CLASSE S (W221)

 S 320 CDI
 (221.022,
 221.122) Diesel 173 12/05 → 06/09

CLS (C219)

 CLS 320 CDI
 (219.322) Diesel 165 01/05 → 12/10

ESS0079A

J1 POMPA CARBURANTE
PB FUEL PUMP

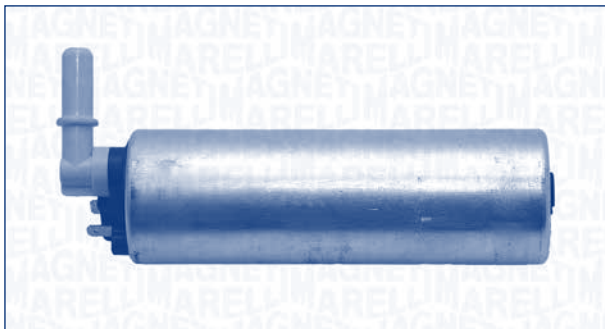

BMW

X5 (E70)

3.0 d	Diesel	173	02/07 → 09/08
3.0 sd	Diesel	210	09/07 → 02/09

ESS0080A

J1 POMPA CARBURANTE
PB FUEL PUMP



AUDI

A4 (8D2, B5)

1.9 TDI	Diesel	55	12/95 → 11/00
---------	--------	----	---------------

A4 (8E2, B6)

1.9 TDI	Diesel	96	11/00 → 12/04
---------	--------	----	---------------

A4 (8EC, B7)

1.9 TDI	Diesel	85	11/04 → 06/08
---------	--------	----	---------------

2.0 TDi	Diesel	100	11/04 → 06/08
---------	--------	-----	---------------

2.5 TDI	Diesel	120	11/04 → 05/06
---------	--------	-----	---------------

A5 (8T3)

2.7 TDI	Diesel	140	06/07 →
---------	--------	-----	---------

3.0 TDI quattro	Diesel	176	06/07 →
-----------------	--------	-----	---------

A6 (4A, C4)

1.9 TDI	Diesel	66	06/94 → 10/97
---------	--------	----	---------------

ESS0080A



AUDI

A6 (4B2, C5)

1.9 TDI	Diesel	81	04/97 → 10/00
---------	--------	----	---------------

2.5 TDI	Diesel	110	07/97 → 01/05
---------	--------	-----	---------------

Q5 (8R)

2.0 TDI quattro	Diesel	125	11/08 →
-----------------	--------	-----	---------

3.0 TDI quattro	Diesel	176	11/08 →
-----------------	--------	-----	---------

ESS0081A

J1 POMPA CARBURANTE
PB FUEL PUMP

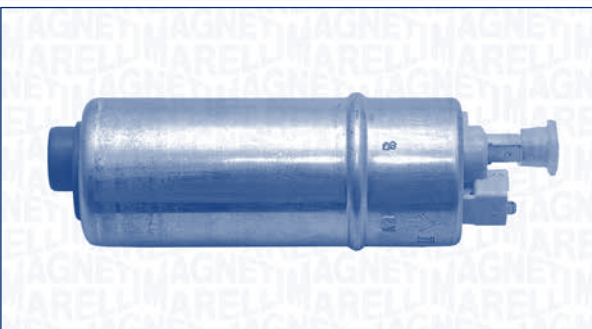

LAND ROVER

RANGE ROVER III (LM)

4.4 4x4	Petrol	225	05/05 → 08/12
---------	--------	-----	---------------

ESS0090A

J1 POMPA CARBURANTE
PB FUEL PUMP

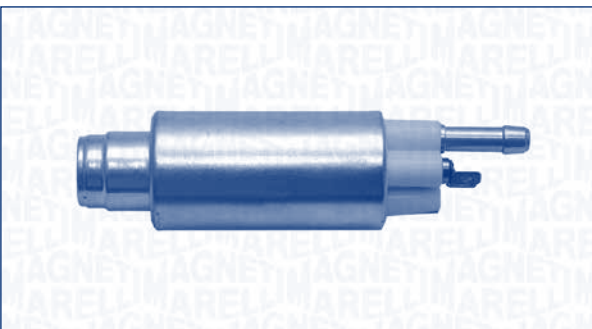

RENAULT

CLIO I (B/C/S57_, 5/357_)

1.2 (B/C/S577)	Petrol	40	01/96 → 12/96
----------------	--------	----	---------------

ESS0090A

RENAULT
CLIO I (B/C57_, 5/357_)

1.2 (B/C/S57A, B/C57S, 5/357F, 5/357J, 5/357L, 5/357R)	Petrol	43	05/90 → 09/98
--	--------	----	---------------

1.2 (B/C57R)	Petrol	40	01/91 → 06/96
--------------	--------	----	---------------

1.4 (B/C57T, B/C57Y)	Petrol	58	01/91 → 09/98
----------------------	--------	----	---------------

1.4 (B57J, C57J)	Petrol	55	01/91 → 09/98
------------------	--------	----	---------------

1.8 (B/C57C, B/C57U)	Petrol	65	01/91 → 09/98
----------------------	--------	----	---------------

CLIO I Furgonato (S57_)

1.2	Petrol	40	01/91 → 09/98
-----	--------	----	---------------

1.2	Petrol	44	01/91 → 09/98
-----	--------	----	---------------

LAGUNA I (B56_, 556_)

1.8 (B56A/B)	Petrol	66	11/93 → 03/01
--------------	--------	----	---------------

1.8 (B56S/T/O)	Petrol	66	08/95 → 03/01
----------------	--------	----	---------------

1.8 (B56Z)	Petrol	69	08/95 → 03/01
------------	--------	----	---------------

LAGUNA I Grandtour (K56_)

1.8 (K56S/T/O)	Petrol	66	09/95 → 03/01
----------------	--------	----	---------------

1.8 (K56Z)	Petrol	69	09/95 → 03/01
------------	--------	----	---------------

MEGANE I (BA0/1_)

1.4 e (BA0E, BA0V)	Petrol	55	01/96 → 08/03
--------------------	--------	----	---------------

RAPID Furgonato (F40_, G40_)

1.2 (F406, G40A)	Petrol	40	09/91 → 03/98
------------------	--------	----	---------------

1.4 (F40D)	Petrol	58	01/94 → 03/98
------------	--------	----	---------------

1.4 (F40U, F40V)	Petrol	55	09/91 → 03/98
------------------	--------	----	---------------

TWINGO I (C06_)

1.2 (C063, C064)	Petrol	40	03/93 → 10/96
------------------	--------	----	---------------

TWINGO I Furgonato (S06_)

1.2 (S063, S064)	Petrol	40	03/93 → 05/96
------------------	--------	----	---------------

VOLVO
440 K (445)

1.8	Petrol	66	08/91 → 07/96
-----	--------	----	---------------

460 L (464)

1.8	Petrol	66	08/91 → 07/96
-----	--------	----	---------------

ESS0092A

J1	POMPA CARBURANTE
PB	FUEL PUMP

CITROËN
BERLINGO (MF)

1.8 i (MFLFX)	Petrol	66	05/97 →
---------------	--------	----	---------

1.8i4WD (MFLFX)	Petrol	66	04/97 →
-----------------	--------	----	---------

PEUGEOT
406 (8B)

1.8	Petrol	66	05/97 → 05/04
-----	--------	----	---------------

1.9 D	Diesel	55	10/96 → 05/04
-------	--------	----	---------------

3.0 V6	Petrol	152	03/00 → 05/04
--------	--------	-----	---------------

RANCH MPV / Space wagon (5F)

1.8	Petrol	66	05/97 →
-----	--------	----	---------

ROVER
200 (RF)

214 Si	Petrol	76	11/95 → 03/00
--------	--------	----	---------------

216 Si	Petrol	82	11/95 → 03/00
--------	--------	----	---------------

218 K Vi	Petrol	107	11/95 → 03/00
----------	--------	-----	---------------

ESS0095A

J1	POMPA CARBURANTE
PB	FUEL PUMP

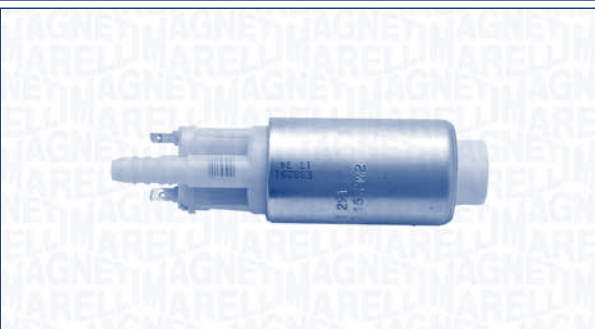
CITROËN
EVASION (22, U6)

1.8	Petrol	73	05/97 → 07/02
-----	--------	----	---------------

2.0	Petrol	89	06/94 → 07/02
-----	--------	----	---------------

ESS0095A



KW



CITROËN

EVASION (22, U6)

2.0 Turbo C.T. Petrol 108 06/94 → 07/02

JUMPER Autobus (230P)

2.0 Petrol 80 02/94 → 04/02

JUMPER Furgonato (230L)

2.0 Petrol 80 03/94 → 04/02

JUMPER Pianale piatto/Telaio (230)

2.0 Petrol 80 03/94 → 04/02

XANTIA (X1)

1.6 i Petrol 65 03/93 → 01/98

1.8 i Petrol 66 04/97 → 01/98

1.8 i Petrol 74 03/93 → 01/98

1.8 i 16V Petrol 81 06/95 → 01/98

2.0 i Petrol 89 03/93 → 01/98

2.0 i 16V Petrol 110 06/94 → 01/98

2.0 i 16V Petrol 112 03/93 → 01/98

2.0 i 16V Petrol 97 06/95 → 01/98

2.0 Turbo Petrol 108 06/95 → 01/98

XANTIA Break (X1)

1.8 i Petrol 66 04/97 → 01/98

1.8 i Petrol 74 06/95 → 01/98

1.8 i 16V Petrol 81 06/95 → 01/98

2.0 i Petrol 89 06/95 → 01/98

2.0 i 16V Petrol 97 06/95 → 01/98

2.0 Turbo Petrol 108 06/95 → 01/98

XM (Y4)

2.0 i 16V Petrol 97 05/94 → 10/00

2.0 Turbo Petrol 108 05/94 → 10/00

3.0 V6 Petrol 123 05/94 → 10/00

3.0 V6 Petrol 140 04/97 → 10/00

3.0 V6 24V Petrol 147 05/94 → 10/00

XM Break (Y4)

2.0 i 16V Petrol 97 05/94 → 10/00

3.0 V6 Petrol 123 05/94 → 10/00

3.0 V6 Petrol 140 04/97 → 10/00

FIAT

BARCETTA (183)

1.8 16V Petrol 96 04/95 → 05/05

BRAVA (182)

1.6 16V (182.BH) Petrol 66 10/95 → 10/01

1.8 GT 16V (182.BC) Petrol 83 10/95 → 10/01

BRAVO I (182)

1.6 16V (182.AH) Petrol 66 10/95 → 10/01

1.8 GT (182.AC) Petrol 83 10/95 → 10/01

ESS0095A



KW



FIAT

MAREA (185)

1.6 100 16V Bipower Petrol/CNG 76 04/99 → 05/02

PUNTO (176)

1.2 16V Petrol 63 04/97 → 09/99

1.6 Petrol 65 01/94 → 04/97

60 1.2 Petrol 44 03/94 → 09/99

75 1.2 Petrol 54 10/93 → 09/99

PUNTO (188)

1.2 60 (188.030, .050, .130, .150, .230, .250) Petrol 44 09/99 →

PUNTO Cabriolet (176C)

60 1.2 Petrol 43 04/94 → 06/00

60 1.2 Petrol 44 05/95 → 06/00

85 16V 1.2 Petrol 63 04/97 → 06/00

90 1.6 Petrol 65 04/94 → 04/97

PUNTO Van (188AX)

1.2 60 Petrol 44 02/00 → 10/09

ULYSSE (220)

1.8 (220.BB5) Petrol 73 05/97 → 08/02

2.0 (220.AC5) Petrol 89 06/94 → 08/02

2.0 Turbo (220.AD5) Petrol 108 06/94 → 08/02

LANCIA

DEDRA (835)

2.0 16V (835ED) Petrol 102 07/94 → 07/99

DEDRA SW (835)

2.0 16V (835ED) Petrol 102 07/94 → 07/99

2.0 Integrale (835ED) Petrol 102 07/94 → 07/99

DELTA II (836)

1.6 i.e. (836AD) Petrol 55 06/93 → 08/99

1.8 i.e. (836AE) Petrol 76 06/93 → 08/99

1.8 i.e. (836AG, 836AL) Petrol 66 07/94 → 08/99

Y (840A)

1.2 (840AA, 840AF1A) Petrol 44 03/96 → 09/03

1.2 16V (840AD) Petrol 63 04/97 → 09/03

ESS0095A

PEUGEOT
106 I (1A, 1C)

1.3	Petrol	72	10/93 → 04/96
1.4	Petrol	69	09/91 → 04/96
1.6	Petrol	65	06/93 → 04/96
1.6	Petrol	76	01/94 → 04/96

605 (6B)

2.0	Petrol	89	06/89 → 09/99
2.0 16V	Petrol	97	07/94 → 09/99
2.0 Turbo	Petrol	108	07/91 → 09/99
2.0 Turbo	Petrol	104	07/92 → 09/99
3.0	Petrol	123	10/89 → 09/99
3.0 SV 24	Petrol	147	08/89 → 09/99
3.0 V6	Petrol	140	04/97 → 09/99

806 (221)

2.0	Petrol	89	06/94 → 08/02
2.0 16V	Petrol	97	05/98 → 09/00
2.0 Turbo	Petrol	108	06/94 → 08/02

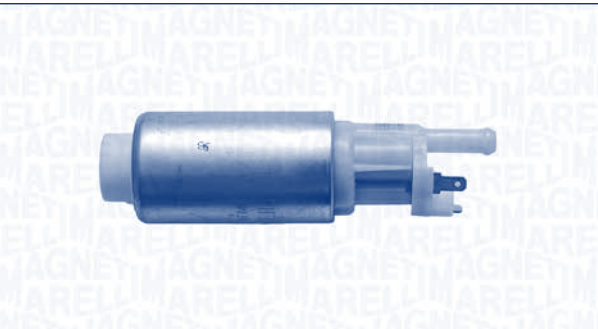
ESS0096A
**J1
PB** **POMPA CARBURANTE
FUEL PUMP**

CHRYSLER
LE BARON

2.5 i	Petrol	75	09/86 → 12/94
-------	--------	----	---------------

LE BARON Cabriolet

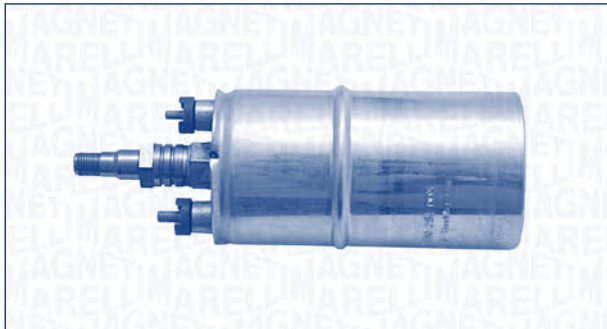
2.5 i	Petrol	75	09/86 → 12/93
-------	--------	----	---------------

ESS0103A
**J1
PB** **POMPA CARBURANTE
FUEL PUMP**

AUDI
100 (43, C2)

2.1	Petrol	100	03/77 → 07/82
-----	--------	-----	---------------

100 (44, 44Q, C3)

1.8 Cat.	Petrol	66	03/85 → 11/90
1.8 quattro Cat.	Petrol	66	08/85 → 11/90
2.0	Petrol	83	08/86 → 11/87
2.0 Cat.	Petrol	85	01/88 → 11/90
2.1	Petrol	100	08/82 → 07/84
2.2	Petrol	101	08/84 → 12/88
2.2	Petrol	85	10/84 → 09/86
2.2 Cat.	Petrol	101	06/89 → 11/90
2.2 E quattro	Petrol	88	08/85 → 07/86
2.2 E Turbo quattro	Petrol	121	08/86 → 11/90
2.2 quattro	Petrol	101	08/84 → 12/88
2.2 quattro Cat.	Petrol	101	06/89 → 11/90
2.2 Turbo	Petrol	121	08/86 → 11/90
2.3 E	Petrol	100	10/86 → 11/90
2.3 E quattro	Petrol	100	08/86 → 11/90

200 (43)

2.1 5E	Petrol	100	10/79 → 09/82
--------	--------	-----	---------------

200 (44, 44Q)

2.1 5E	Petrol	100	08/83 → 07/84
2.1 Turbo	Petrol	134	08/83 → 01/88
2.1 Turbo quattro	Petrol	134	08/83 → 09/86
2.2	Petrol	101	08/84 → 07/85
2.2 Turbo	Petrol	121	08/85 → 09/91
2.2 Turbo	Petrol	147	02/88 → 12/90
2.2 Turbo quattro	Petrol	121	01/85 → 12/91
2.2 Turbo quattro	Petrol	147	02/88 → 11/90

200 Avant (44, 44Q)

2.1 Turbo quattro	Petrol	134	09/83 → 01/88
2.2 Turbo	Petrol	121	08/85 → 09/91
2.2 Turbo quattro	Petrol	121	09/83 → 12/90
2.2 Turbo quattro	Petrol	147	02/88 → 12/91

ESS0103A



AUDI

QUATTRO (85)

2.1 Turbo	Petrol	147	07/80 → 07/87
-----------	--------	-----	---------------

ESS0105A

**J1
PB** POMPA CARBURANTE
FUEL PUMP

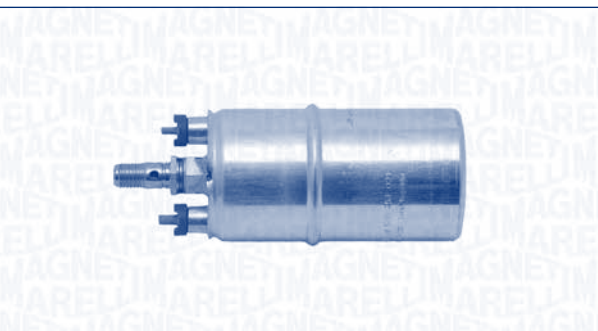

VOLKSWAGEN

JETTA II (19E, 1G2, 165)

1.8	Petrol	79	08/85 → 10/87
-----	--------	----	---------------

ESS0109A

**J1
PB** POMPA CARBURANTE
FUEL PUMP

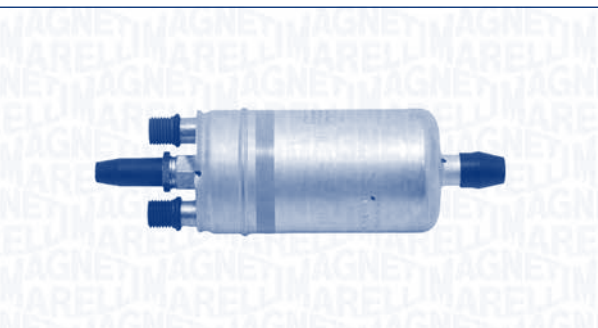

AUDI

CABRIOLET (8G7, B4)

2.0 E	Petrol	85	01/93 → 07/98
2.6	Petrol	110	06/93 → 08/00
2.8	Petrol	128	11/92 → 08/00

ESS0112A

**J1
PB** POMPA CARBURANTE
FUEL PUMP

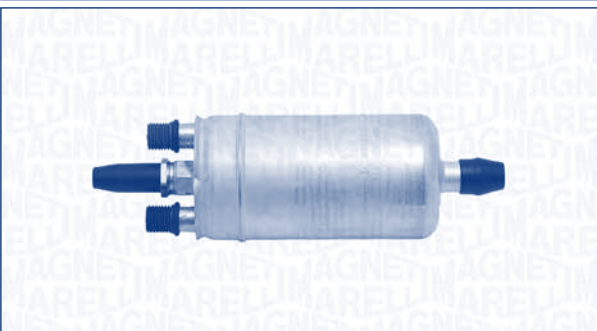

AUDI

100 (43, C2)

2.1	Petrol	85	10/77 → 07/82
-----	--------	----	---------------

100 Avant (43, C2)

2.1	Petrol	100	07/77 → 02/83
-----	--------	-----	---------------

2.1	Petrol	85	07/77 → 02/83
-----	--------	----	---------------

80 (81, 85, B2)

1.6 GLE	Petrol	81	01/79 → 12/86
---------	--------	----	---------------

1.8 GTE	Petrol	82	10/84 → 08/86
---------	--------	----	---------------

1.8 GTE quattro (85Q)	Petrol	81	03/85 → 08/86
-----------------------	--------	----	---------------

1.8 GTE quattro (85Q)	Petrol	82	08/84 → 08/86
-----------------------	--------	----	---------------

2.0	Petrol	85	10/83 → 09/84
-----	--------	----	---------------

2.0 quattro (85Q)	Petrol	85	10/83 → 09/84
-------------------	--------	----	---------------

2.2 quattro	Petrol	96	08/82 → 07/84
-------------	--------	----	---------------

2.2 quattro (85Q)	Petrol	100	08/82 → 07/84
-------------------	--------	-----	---------------

80 (89, 89Q, 8A, B3)

1.6	Petrol	75	08/90 → 10/91
-----	--------	----	---------------

1.8	Petrol	83	09/86 → 07/88
-----	--------	----	---------------

1.8 E	Petrol	82	06/86 → 08/91
-------	--------	----	---------------

1.8 S	Petrol	66	09/86 → 10/91
-------	--------	----	---------------

2.0	Petrol	82	10/90 → 08/91
-----	--------	----	---------------

2.0 E	Petrol	83	08/88 → 10/90
-------	--------	----	---------------

2.0 E 16V	Petrol	101	03/90 → 09/91
-----------	--------	-----	---------------

90 (81, 85, B2)

2.0	Petrol	85	10/84 → 03/87
-----	--------	----	---------------

2.2	Petrol	100	10/84 → 03/87
-----	--------	-----	---------------

2.2	Petrol	85	01/85 → 03/87
-----	--------	----	---------------

2.2 E quattro	Petrol	100	11/84 → 03/87
---------------	--------	-----	---------------

2.2 E quattro	Petrol	88	08/85 → 03/87
---------------	--------	----	---------------

ESS0112A

AUDI
90 (89, 89Q, 8A, B3)

2.0	Petrol	85	07/88 → 09/91
2.0 20 V	Petrol	118	08/89 → 07/91
2.2 E	Petrol	100	04/87 → 07/91
2.3 E	Petrol	100	04/87 → 07/91
2.3 E	Petrol	98	04/87 → 09/91
2.3 E 20V	Petrol	123	04/90 → 07/91
2.3 E 20V	Petrol	125	08/88 → 07/91

COUPE (81, 85)

1.8 GT	Petrol	79	08/86 → 10/87
1.8 GT	Petrol	82	08/86 → 10/88
2.0	Petrol	85	09/83 → 07/86
2.1 GT	Petrol	96	09/82 → 10/87
2.2 GT	Petrol	100	09/84 → 10/88
2.2 GT	Petrol	85	07/81 → 10/87
2.2 quattro	Petrol	100	10/84 → 10/88
2.2 quattro	Petrol	88	08/85 → 10/88
2.3	Petrol	100	01/87 → 10/88
2.3 quattro	Petrol	100	01/87 → 10/88

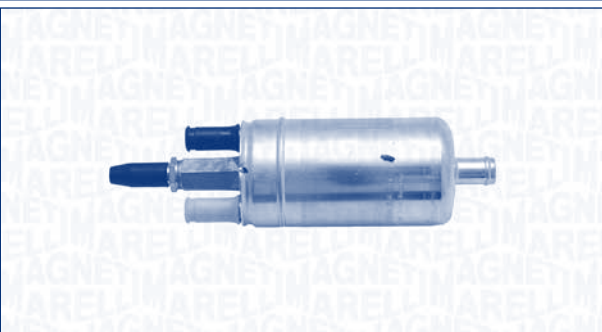
ESS0117A
**J1
PB** **POMPA CARBURANTE
FUEL PUMP**

FORD
SIERRA 2 volumi /Coda spiovente (GBC)

2.0 4x4	Petrol	150	01/86 → 12/86	ENGINE: N5B
---------	--------	-----	---------------	-------------

SIERRA Station wagon (BNG)

2.8 4x4	Petrol	110	01/87 → 08/88	ENGINE: PRG
---------	--------	-----	---------------	-------------

RENAULT
30 (127_)

2.6 TX (1278)	Petrol	105	10/78 → 12/83
---------------	--------	-----	---------------

5 (122_)

1.4 Turbo (8220)	Petrol	118	06/80 → 01/85
------------------	--------	-----	---------------

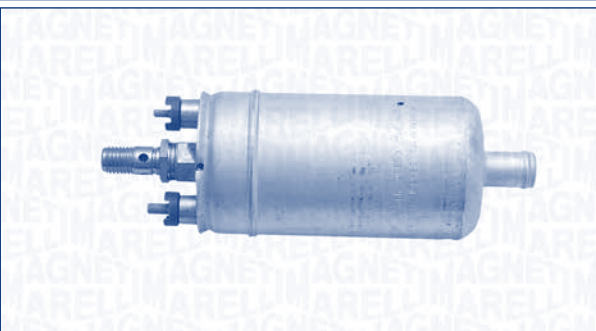
ESS0118A
**J1
PB** **POMPA CARBURANTE
FUEL PUMP**

FERRARI
208/308

208 Turbo	Petrol	162	06/82 → 10/89
308 GTB Qv	Petrol	177	09/82 → 06/85
308 GTS Qv	Petrol	177	09/82 → 06/85

328 GTB

3.2	Petrol	199	09/85 → 09/89
-----	--------	-----	---------------

328 GTS

3.2	Petrol	199	09/85 → 09/89
-----	--------	-----	---------------

412 i

4.9	Petrol	250	04/85 → 12/88
-----	--------	-----	---------------

512 BB

4.9	Petrol	237	07/81 → 08/84
-----	--------	-----	---------------

MONDIAL

3.2 Quattrovalvole	Petrol	199	10/85 → 12/88
--------------------	--------	-----	---------------

MONDIAL Cabriolet

3.2 Quattrovalvole	Petrol	199	09/85 → 12/88
--------------------	--------	-----	---------------

TESTAROSSA

5.0	Petrol	272	08/86 → 10/91
5.0	Petrol	287	05/84 → 12/91

ESS0122A

J1 POMPA CARBURANTE
PB FUEL PUMP

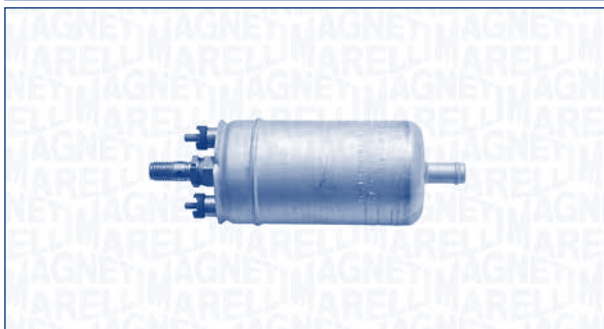

PORSCHE

911

3.0 SC Petrol 150 08/80 → 07/83

911 Cabriolet

3.0 SC Petrol 150 08/82 → 07/83

ESS0124A

J1 POMPA CARBURANTE
PB FUEL PUMP

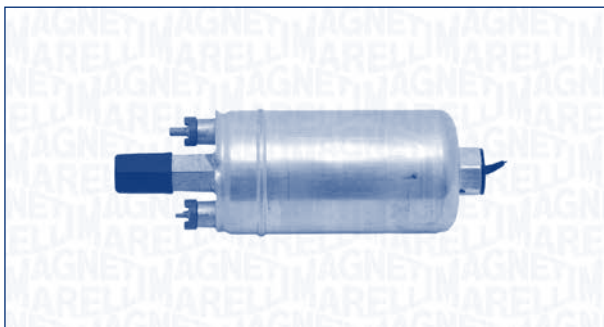

PORSCHE

911

3.3 SC Turbo Petrol 221 09/77 → 06/87

3.3 Turbo Petrol 221 06/86 → 08/89

911 (964)

3.3 Turbo Petrol 235 08/90 → 09/93

3.6 Turbo Petrol 265 01/93 → 09/93

ESS0126A

J1 POMPA CARBURANTE
PB FUEL PUMP

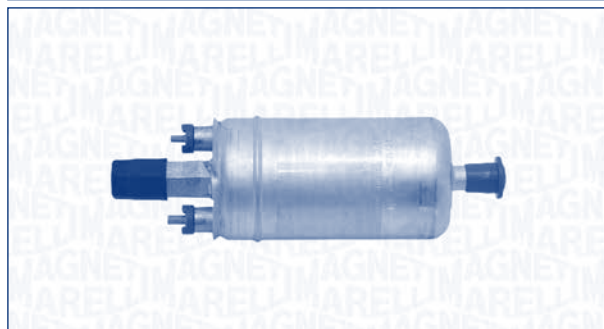

MERCEDES-BENZ

KOMBI Station wagon (S123)

280 TE (123.093) Petrol 136 09/77 → 11/85

Tre volumi (W123)

280 E Petrol 130 08/76 → 08/81

280 E (123.033) Petrol 136 02/76 → 11/85

PEUGEOT

504 Coupé

2.7 Petrol 106 10/77 → 08/84

604 (561A_)

2.7 TI,STI Petrol 106 08/77 → 05/83

PORSCHE

911

2.7 Petrol 121 09/75 → 06/77

3.0 SC Carrera Petrol 132 07/77 → 06/80

3.0 SC Carrera Petrol 147 09/75 → 06/77

911 Targa

2.7 Petrol 121 09/75 → 06/77

3.0 SC Carrera Petrol 132 07/77 → 06/80

3.0 SC Carrera Petrol 147 09/75 → 06/77

924

2.0 Petrol 92 11/75 → 08/89

2.0 Turbo Petrol 125 11/78 → 06/80

ESS0128A
J1 **POMPA CARBURANTE**
PB **FUEL PUMP**

KW

VOLVO
850 (LS)

2.0	Petrol	93	08/94 → 12/96
2.0	Petrol	105	06/91 → 12/96
2.5	Petrol	106	08/94 → 12/96
2.5	Petrol	125	08/91 → 12/96
2.5	Petrol	103	06/91 → 07/94

850 Station wagon (LW)

2.0	Petrol	93	08/94 → 12/96
-----	--------	----	---------------

ESS0129A

KW

BMW
3 (E30)

325 i	Petrol	126	09/83 → 11/89
325 i X	Petrol	125	12/86 → 08/91
325 i X	Petrol	126	03/86 → 12/87
M3 2.3	Petrol	143	07/86 → 06/91
M3 2.3	Petrol	158	06/89 → 06/91

3 Cabriolet (E30)

318 i	Petrol	83	09/90 → 10/93
320 i	Petrol	95	04/86 → 10/93
325 i	Petrol	125	09/87 → 10/93
325 i	Petrol	126	12/85 → 12/87
316 i	Petrol	73	09/91 → 06/94
316 i	Petrol	75	09/91 → 06/94

3 Touring (E30)

318 i	Petrol	83	04/89 → 06/94
318 i	Petrol	85	09/87 → 06/91
320 i	Petrol	95	01/88 → 12/91
325 i	Petrol	125	07/87 → 03/93
325 i X	Petrol	125	06/88 → 10/93

ESS0129A
J1 **POMPA CARBURANTE**
PB **FUEL PUMP**

KW

BMW
3 (E30)

316 i	Petrol	73	09/87 → 06/91
316 i	Petrol	75	07/88 → 06/91
318 i	Petrol	83	09/87 → 06/91
318 i	Petrol	85	09/87 → 06/91
318 is	Petrol	100	09/89 → 08/91
320 i	Petrol	95	12/85 → 06/91
320 is	Petrol	141	05/88 → 12/90
325 e 2.7	Petrol	90	10/83 → 12/88
325 i	Petrol	125	12/86 → 06/91

ESS0130A
J1 **POMPA CARBURANTE**
PB **FUEL PUMP**

KW

RENAULT
19 I (B/C53_)

1.4	Petrol	59	01/88 → 12/92
1.7 (B/C53B)	Petrol	54	09/88 → 04/92

19 I Chamade (L53_)

1.4 (L532, L53P)	Petrol	43	07/88 → 04/92
1.7 (L53B)	Petrol	54	10/89 → 04/92

19 II (B/C53_)

1.4 (B/C532)	Petrol	43	04/92 → 12/95
1.8 (5/353A)	Petrol	66	04/92 → 12/95

ESS0130A



RENAULT

19 II Cabriolet (D53_, 853_)

1.8 (D53Y) Petrol 65 04/92 → 06/96

CLIO I (B/C57_, 5/357_)

1.4 Petrol 59 01/91 → 09/98

RAPID Furgonato (F40_, G40_)

1.4 (F407) Cat. Petrol 43 08/88 → 03/98

ESS0131A

J1 **POMPA CARBURANTE**
PB **FUEL PUMP**



RENAULT

19 II (B/C53_)

1.8 (B/C53Y) Petrol 65 04/92 → 12/95

19 II Chamade (L53_)

1.4 (532) Petrol 43 04/92 → 12/95

1.4 (L535) Petrol 55 11/93 → 12/95

1.7 (L53B) Petrol 54 04/92 → 12/95

1.8 (453A/F) Petrol 66 04/92 → 12/95

1.8 (L53Y) Petrol 65 04/92 → 12/95

ESS0133A

J1 **POMPA CARBURANTE**
PB **FUEL PUMP**



VOLVO

S60 I

2.0 T Petrol 132 07/00 → 04/10

2.4 Petrol 103 11/00 → 04/10

2.4 T5 Petrol 191 04/04 → 04/10

2.5 T AWD Petrol 154 04/04 → 04/10

V70 II (SW)

2.4 Petrol 103 03/00 → 08/07

ESS0134A

J1 **POMPA CARBURANTE**
PB **FUEL PUMP**



BMW

5 (E34)

518 i Petrol 83 08/89 → 09/95

518 i Petrol 85 08/89 → 09/95

520 i Petrol 95 01/88 → 08/91

520 i 24V Petrol 110 09/89 → 09/95

525 i Petrol 125 01/88 → 08/91

525 i 24V Petrol 141 09/89 → 09/95

525 iX 24V Petrol 141 10/91 → 09/95

530 i Petrol 138 01/88 → 08/91

535 i Petrol 155 01/88 → 09/95

540 i V8 Petrol 210 09/92 → 09/95

ESS0134A

BMW
5 (E34)

M 3.6	Petrol	232	10/88 → 05/92
M 3.6 Cat.	Petrol	232	10/88 → 05/92
M 3.8	Petrol	250	03/92 → 09/95

5 Touring (E34)

518 g	BiFuel	85	11/95 → 06/96
518 i	Petrol	83	03/93 → 09/94
518 i	Petrol	85	09/94 → 01/97
520 i	Petrol	110	11/91 → 01/97
525 i	Petrol	141	11/91 → 01/97
525 ix	Petrol	141	02/92 → 01/97

7 (E32)

730 i,iL	Petrol	138	12/86 → 09/94
730 i,iL	Petrol	145	12/86 → 09/94
735 i,iL	Petrol	155	09/86 → 09/92
735 i,iL	Petrol	162	09/86 → 12/87
740 i,iL V8	Petrol	210	04/92 → 09/94

ESS0138A

**J1
PB** **POMPA CARBURANTE
FUEL PUMP**

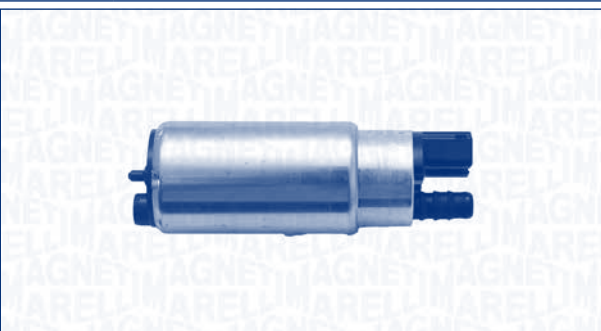
VOLVO
C70 I Cabriolet

2.0	Petrol	132	03/98 → 10/05
2.0 T	Petrol	120	03/00 → 10/05
2.0 T	Petrol	166	03/98 → 10/05
2.3 T5	Petrol	180	07/02 → 10/05
2.3 T5	Petrol	176	03/98 → 10/05
2.4 T	Petrol	147	07/02 → 10/05
2.5	Petrol	125	06/98 → 10/05

C70 I Coupé

2.0	Petrol	132	03/97 → 09/02
2.0 T	Petrol	120	03/00 → 09/02
2.3 T-5	Petrol	176	03/97 → 09/02

ESS0138A

VOLVO
C70 I Coupé

2.5	Petrol	121	03/99 → 09/02
2.5	Petrol	125	05/99 → 09/02
2.5 T	Petrol	142	03/97 → 09/02

S70 (LS)

2.0	Petrol	120	01/97 → 11/00
2.5	Petrol	121	06/98 → 11/00
2.5 Bifuel	Petrol/ CNG	106	10/98 → 11/00

ESS0143A

**J1
PB** **POMPA CARBURANTE
FUEL PUMP**

NISSAN
MICRA II (K11)

1.0 i 16V	Petrol	40	08/92 → 09/00
1.3 i 16V	Petrol	55	08/92 → 09/00
1.4 i 16V	Petrol	60	09/00 → 02/03

PRIMERA Traveller (WP11)

1.8 16V	Petrol	84	08/99 → 12/01
2.0 16V	Petrol	103	08/99 → 12/01
2.0 16V	Petrol	96	04/98 → 12/01

ESS0144A

J1 POMPA CARBURANTE
PB FUEL PUMP

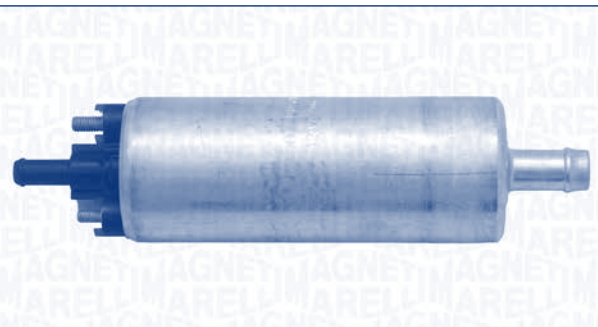

RENAULT

11 (B/C37_)

1.7 (B/C37F) Petrol 55 10/84 → 12/88

25 (B29_)

2.0 12V Petrol 103 06/88 → 12/93

2.0 12V (B294) Petrol 99 06/89 → 12/92

2.2 (B29B) Petrol 79 09/86 → 12/92

2.2 (B29E) Petrol 89 04/84 → 12/89

9 (L42_)

1.7 (L42F) Petrol 54 10/86 → 12/88

SUPER 5 (B/C40_)

1.7 (B/C408) Petrol 54 10/86 → 03/95

1.7 i (C409) Petrol 69 10/86 → 08/91

ESS0162A



VOLVO

740 Kombi (745)

2.0 Petrol 82 08/89 → 07/91 ENGINE: B200F

2.3 Petrol 114 08/88 → 07/90 ENGINE: B234F

2.3 Petrol 87 01/88 → 10/90 ENGINE: B230F

940 (944)

2.0 Petrol 82 01/92 → 07/94 ENGINE: B200F

940 Kombi (945)

2.0 Petrol 82 01/92 → 07/94 ENGINE: B200F

ESS0164A

J1 POMPA CARBURANTE
PB FUEL PUMP

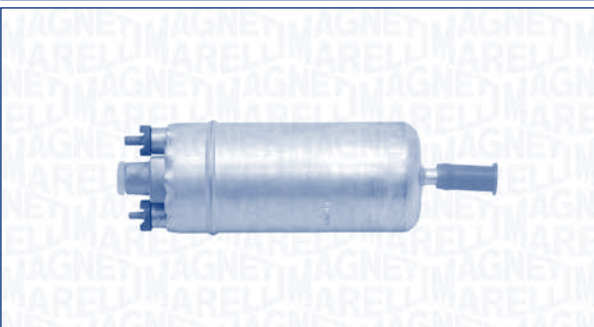

RENAULT

MASTER II Furgonato (FD)

2.5 D Diesel 59 07/98 → 01/01

ESS0162A

J1 POMPA CARBURANTE
PB FUEL PUMP

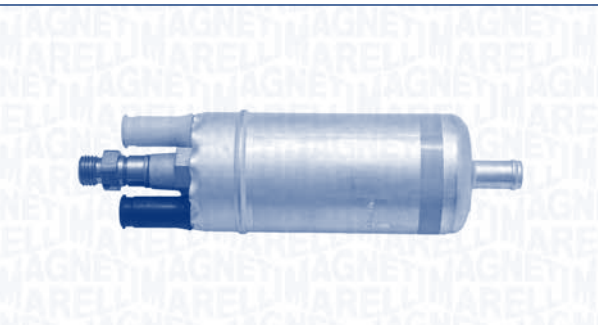

VOLVO

240 (P242, P244)

2.3 Petrol 83 08/86 → 07/87 ENGINE: B230F

240 Kombi (P245)

2.3 Cat. Petrol 100 08/91 → 07/92 ENGINE: B230F

740 (744)

2.0 Petrol 82 09/90 → 08/92 ENGINE: B200F

ESS0165A

J1 POMPA CARBURANTE
PB FUEL PUMP

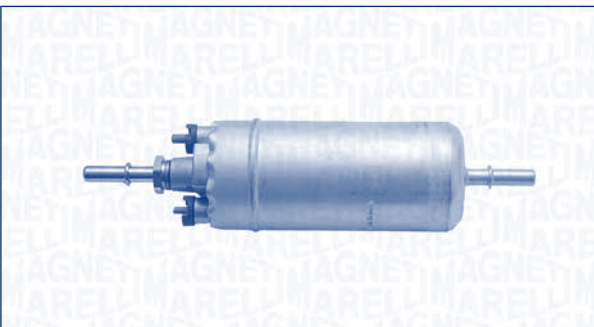

HYUNDAI

SANTA FÉ I (SM)

2.0 CRDi Diesel 83 08/01 → 03/06

2.0 CRDi 4x4 Diesel 83 04/01 → 03/06

ESS0165A

HYUNDAI
TRAJET (FO)

2.0 CRDi Diesel 83 04/01 → 07/08

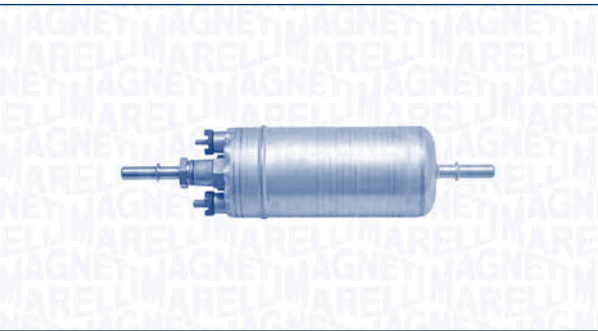
ESS0167A
**J1
PB** **POMPA CARBURANTE
FUEL PUMP**

FIAT
STRADA Pick-up (178E)

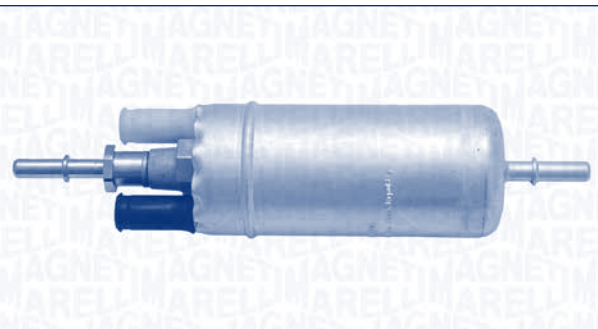
1.9 JTD Diesel 59 04/03 →

ESS0168A
**J1
PB** **POMPA CARBURANTE
FUEL PUMP**

FORD
MONDEO III (B5Y)

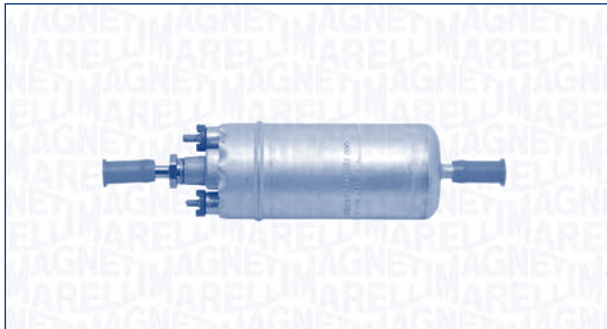
2.0 16V DI / TDDi / TDCi Diesel 66 11/00 → 08/07

2.0 16V TDDi / TDCi Diesel 85 11/00 → 08/07

ESS0169A
**J1
PB** **POMPA CARBURANTE
FUEL PUMP**

HYUNDAI
SANTA FÉ I (SM)

2.0 CRDi Diesel 83 08/01 → 03/06 ENGINE: D4EA

2.0 CRDi 4x4 Diesel 83 04/01 → 03/06 ENGINE: D4EA

2.0 CRDi 4x4 Diesel 92 08/03 → 03/06

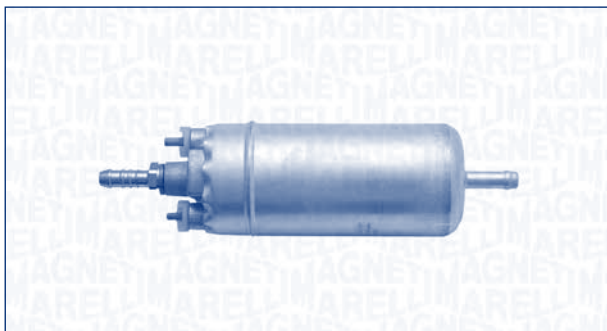
2.0 CRDi Trazione integrale Diesel 107 11/03 → 02/06 ENGINE: D4EA

ESS0170A
**J1
PB** **POMPA CARBURANTE
FUEL PUMP**

AUDI
A3 Cabriolet (8P7)

2.0 TDi Diesel 103 04/08 → 05/13

VOLKSWAGEN
GOLF PLUS (5M1, 521)

2.0 TDi Diesel 81 01/09 →

GOLF VI Cabriolet (517)

2.0 TDi Diesel 103 11/11 →

MULTIVAN V (7HM, 7HN, 7HF, 7EF, 7EM, 7EN)

2.0 BiTDI Diesel 132 09/09 →

2.0 BITDI 4motion Diesel 132 09/09 →

2.0 TDi Diesel 103 09/09 →

2.0 TDi Diesel 62 09/09 →

ESS0170A



VOLKSWAGEN

MULTIVAN V (7HM, 7HN, 7HF, 7EF, 7EM, 7EN)

2.0 TDi	Diesel	75	09/09 →
2.0 TDi	Diesel	84	05/11 →
2.0 TDi 4motion	Diesel	103	09/09 →

SCIROCCO (137, 138)

2.0 TDi	Diesel	100	11/10 →
2.0 TDi	Diesel	103	08/08 →
2.0 TDi	Diesel	125	05/09 →

TRANSPORTER V Autobus (7HB, 7HJ, 7EB, 7EJ, 7EF)

2.0 BiTDI	Diesel	132	09/09 →
2.0 BiTDI 4motion	Diesel	132	09/09 →
2.0 TDi	Diesel	103	09/09 →
2.0 TDi	Diesel	62	09/09 →
2.0 TDi	Diesel	75	09/09 →
2.0 TDi	Diesel	84	05/11 →
2.0 TDi 4motion	Diesel	103	09/09 →

TRANSPORTER V Furgonato (7HA, 7HH, 7EA, 7EH)

2.0 BiTDI	Diesel	132	09/09 →
2.0 BiTDI 4motion	Diesel	132	09/09 →
2.0 TDi	Diesel	103	09/09 →
2.0 TDi	Diesel	62	09/09 →
2.0 TDi	Diesel	75	09/09 →
2.0 TDi	Diesel	100	05/10 →
2.0 TDi	Diesel	84	05/11 →
2.0 TDi 4motion	Diesel	103	09/09 →
2.0 TDi 4motion	Diesel	100	05/10 →

TRANSPORTER V Pianale piatto/Telaio (7JD, 7JE, 7JL, 7JY, 7JZ)

2.0 BiTDI	Diesel	132	09/09 →
2.0 BiTDI 4motion	Diesel	132	09/09 →
2.0 TDi	Diesel	103	09/09 →
2.0 TDi	Diesel	62	09/09 →
2.0 TDi	Diesel	75	09/09 →
2.0 TDi	Diesel	100	05/10 →
2.0 TDi 4motion	Diesel	103	09/09 →
2.0 TDi 4motion	Diesel	100	05/10 →

ESS0171A

J1 POMPA CARBURANTE
PB FUEL PUMP



BMW

3 (E21)

318 i	Petrol	77	11/79 → 08/82
320 i	Petrol	92	06/75 → 08/82
323 i	Petrol	105	01/78 → 08/82

3 (E30)

318 i	Petrol	77	09/82 → 08/87
-------	--------	----	---------------

5 (E28)

520 i	Petrol	92	06/81 → 12/87
-------	--------	----	---------------

PEUGEOT

505 (551A)

2.0 TI,STI	Petrol	81	08/79 → 10/86
2.2	Petrol	85	05/81 → 10/84

VOLKSWAGEN

CADDY I (14)

1.8	Petrol	70	08/85 → 07/92
-----	--------	----	---------------

GOLF I (17)

1.6 GTI	Petrol	81	08/76 → 07/82
1.8 GTI	Petrol	82	08/82 → 12/83

GOLF I Cabriolet (155)

1.6	Petrol	81	08/79 → 07/82
1.8	Petrol	70	08/83 → 04/93
1.8	Petrol	82	08/82 → 12/89

JETTA I (16)

1.6 GLI	Petrol	81	08/78 → 07/82
---------	--------	----	---------------

PASSAT Variant (33)

1.6 i	Petrol	81	06/78 → 07/80
-------	--------	----	---------------

SCIROCCO (53B)

1.6	Petrol	81	08/80 → 07/82
1.8	Petrol	70	11/85 → 07/92
1.8	Petrol	82	08/82 → 12/89
1.8 16V	Petrol	102	10/85 → 07/89
1.8 16V	Petrol	95	03/86 → 07/92

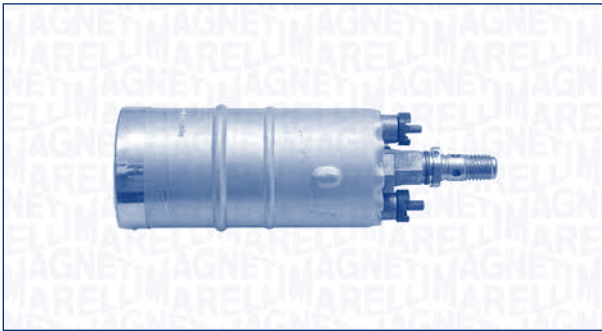
ESS0172A
J1 POMPA CARBURANTE
PB FUEL PUMP

FERRARI
456 GT/GTA

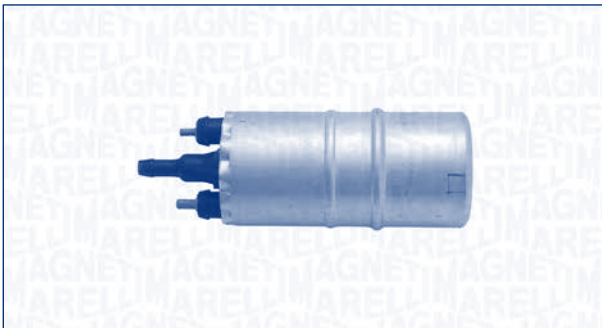
5.5 (F116) Petrol 325 01/93 → 06/04

ESS0173A
J1 POMPA CARBURANTE
PB FUEL PUMP

FIAT
CROMA (154)

2000 i.e. (154.AD) Petrol 88 03/87 → 09/92

2000 i.e. (154.AM) Petrol 83 03/86 → 09/90

2000 i.e. (154.AM, 154.LM) Petrol 85 10/87 → 08/96

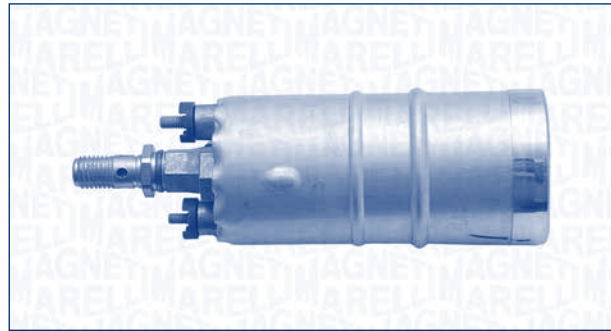
2000 i.e. Turbo (154.AM) Petrol 114 12/85 → 06/90

ESS0174A
J1 POMPA CARBURANTE
PB FUEL PUMP

ALFA ROMEO
155 (167)

2.0 T.S. 16V (167.A2G) Petrol 110 03/95 → 12/97

2.5 V6 (167.A1) Petrol 121 02/92 → 09/96

2.5 V6 (167.A1C, 167.A1E) Petrol 120 10/92 → 12/97

164 (164)

2.0 T.S. (164.A2C, 164.A2L) Petrol 105 06/87 → 09/92

3.0 V6 (164.A) Petrol 141 06/87 → 09/92

GTV (916C_)

2.0 V6 Turbo (916.C2A) Petrol 148 06/95 → 09/98

3.0 V6 24V (916.C1B_) Petrol 160 10/00 → 10/05

FIAT
CROMA (154)

2000 i.e. Turbo (154.AM, 154.LM) Petrol 110 06/87 → 08/96

2500 TDE Diesel 77 12/91 → 08/96

LANCIA
THEMA (834)

2000 i.e. 16V Turbo (834AL) Petrol 130 04/89 → 05/92

THEMA SW (834)

2000 Turbo Petrol 110 01/89 → 03/92

ESS273/1

J1 POMPA CARBURANTE
PB FUEL PUMP

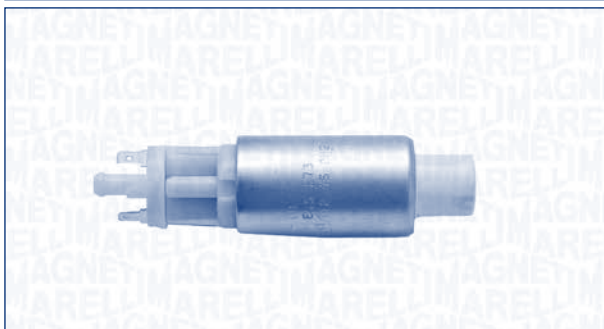

FIAT

CINQUECENTO (170)

0.9 i.e. S (170AF, 170CF)	Petrol	29	07/91 → 07/99
------------------------------	--------	----	---------------

1.1 Sporting (170AH)	Petrol	40	10/94 → 01/98
-------------------------	--------	----	---------------

PANDA (141A_)

900	Petrol	29	04/92 → 12/96
-----	--------	----	---------------

1100	Petrol	37	05/91 → 12/99
------	--------	----	---------------

1100	Petrol	40	02/95 → 09/03
------	--------	----	---------------

1000 i.e. Cat.	Petrol	33	10/87 → 08/98
----------------	--------	----	---------------

1100 4x4	Petrol	40	02/95 → 07/04
----------	--------	----	---------------

1100 Trekking 4x4	Petrol	37	10/91 → 07/04
-------------------	--------	----	---------------

PANDA Van (141_)

1000 i.e	Petrol	33	08/92 → 02/04
----------	--------	----	---------------

PUNTO (176)

55 1.1	Petrol	40	09/93 → 09/99
--------	--------	----	---------------

60 1.2	Petrol	43	01/94 → 09/99
--------	--------	----	---------------

PUNTO Cabriolet (176C)

60 1.2	Petrol	44	05/95 → 06/00
--------	--------	----	---------------

PUNTO Van (176L)

1.1	Petrol	40	04/96 → 02/00
-----	--------	----	---------------

UNO (146A/E)

45 i.e. 1.0	Petrol	33	04/84 → 10/95
-------------	--------	----	---------------

ESS452

J1 POMPA CARBURANTE
PB FUEL PUMP

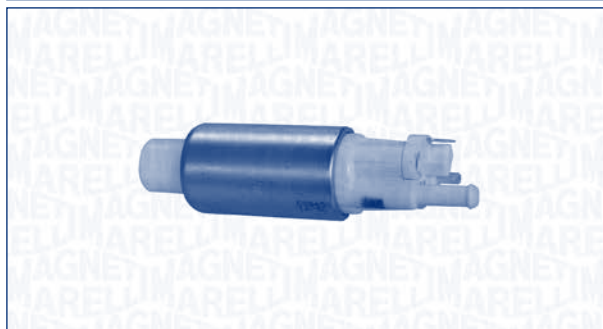

FIAT

PUNTO (176)

75 1.2	Petrol	54	12/93 → 09/99
--------	--------	----	---------------

LANCIA

DEDRA (835)

1.8 i.e. (835FA)	Petrol	74	07/94 → 07/99
------------------	--------	----	---------------

DEDRA SW (835)

1.8 i.e. (835FA)	Petrol	74	07/94 → 07/99
------------------	--------	----	---------------

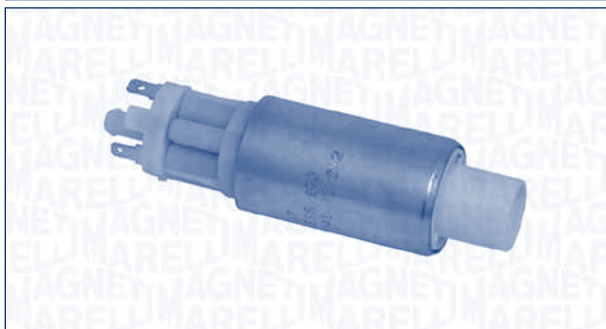
ESS514
**J1
PB**
**POMPA CARBURANTE
FUEL PUMP**

KW

CITROËN
AX (ZA-_)

10	Petrol	37	07/92 → 12/98
11	Petrol	44	10/89 → 12/97
14	Petrol	55	08/88 → 08/93
14 4x4	Petrol	55	08/91 → 08/93

BX (XB-_)

14	Petrol	55	01/89 → 02/93
----	--------	----	---------------

BX Break (XB-_)

14	Petrol	55	01/89 → 02/93
----	--------	----	---------------

C15 (VD-_)

1.1 i	Petrol	44	07/88 → 12/96
-------	--------	----	---------------

XM (Y3)

2.0 i	Petrol	79	11/91 → 04/94
-------	--------	----	---------------

XM Break (Y3)

2.0 i (Y3A)	Petrol	79	11/91 → 04/94
-------------	--------	----	---------------

FIAT
BRAVA (182)

1.4 (182.BG)	Petrol	55	10/95 → 10/98
--------------	--------	----	---------------

BRAVO I (182)

1.4 (182.AG)	Petrol	55	10/95 → 10/98
--------------	--------	----	---------------

FIORINO Furgonato (146)

75 i.e. 1.6	Petrol	55	06/95 → 05/01
-------------	--------	----	---------------

FIORINO Pick up (146)

1.4	Petrol	49	06/95 → 05/01
1.6	Petrol	55	06/95 → 05/01

PANDA (141A_)

1100	Petrol	37	05/91 → 12/92
1000 4x4	Petrol	33	05/86 → 12/94
1100 Trekking 4x4	Petrol	37	10/91 → 12/92

REGATA (138)

75 i.e. 1.5	Petrol	55	05/87 → 07/89
-------------	--------	----	---------------

REGATA Weekend

75 1.5 i.e. Cat.	Petrol	55	05/87 → 07/89
------------------	--------	----	---------------

ESS514

KW

FIAT
RITMO II (138A)

90 1.6 i.e.	Petrol	66	12/85 → 12/87
-------------	--------	----	---------------

TEMPRA (159)

1.4 i.e. (159.AC, 159.AX)	Petrol	51	03/92 → 08/96
1.6 i.e. (159.AE)	Petrol	57	06/90 → 07/92
1.6 i.e. (159.AJ)	Petrol	63	06/94 → 08/96
1.6 i.e. (159.AS, 159.AT)	Petrol	55	06/92 → 08/96

TEMPRA S.W. (159)

1.4 i.e. (159.AC, 159.AX)	Petrol	51	10/92 → 08/96
1.6 i.e. (159.AE)	Petrol	57	10/90 → 08/96
1.6 i.e. (159.AS, 159.AT)	Petrol	55	10/92 → 08/96

TIPO (160)

1.4 i.e. (160.AP, 160.AD, 160.EA)	Petrol	51	05/89 → 04/95
1.6 i.e. (160.AF)	Petrol	57	07/90 → 01/93

UNO (146A/E)

50 i.e. 1.1	Petrol	36	06/92 → 12/93
70 i.e. 1.4	Petrol	51	09/89 → 12/93
75 i.e. 1.5	Petrol	55	10/85 → 12/93

INNOCENTI
ELBA (146)

1.4 i.e. (146EN, 146EQ)	Petrol	49	09/94 → 12/96
1.6 i.e. (146EO, 146ER)	Petrol	55	09/94 → 12/96

LANCIA
DEDRA (835)

1.6 i.e. (835AB)	Petrol	57	08/89 → 03/93
1.6 i.e. (835AN)	Petrol	55	04/93 → 10/94

DELTA II (836)

1.4 i.e. (836AF, 836AH)	Petrol	51	10/94 → 08/95
1.6 i.e. (836AD)	Petrol	55	06/93 → 08/95

Y10

1.0	Petrol	41	01/95 → 10/95
1.0 4WD	Petrol	37	07/89 → 10/95
1.0 Cat.	Petrol	33	10/87 → 09/92
1.1	Petrol	42	08/89 → 06/92
1.1 4WD	Petrol	42	08/89 → 06/92
1.1 i.e. Cat.	Petrol	42	09/90 → 06/92

ESS514



LANCIA

Y (840A)

1.4 12V (840AC) Petrol 55 03/96 → 06/00

PEUGEOT

205 II (20A/C)

1.0 Petrol 33 10/87 → 09/98

ESS518

J1 POMPA CARBURANTE
PB FUEL PUMP



BMW

7 (E38)

728 i,iL Petrol 142 08/95 → 11/01

730 i,iL Petrol 155 10/94 → 11/01

730 i,iL Petrol 160 10/94 → 11/01

735 i,iL Petrol 173 01/96 → 11/01

740 i,iL Petrol 210 10/94 → 11/01

740 i,iL Petrol 210 01/96 → 11/01

750 i,iL Petrol 240 12/94 → 11/01

ESS519

J1 POMPA CARBURANTE
PB FUEL PUMP

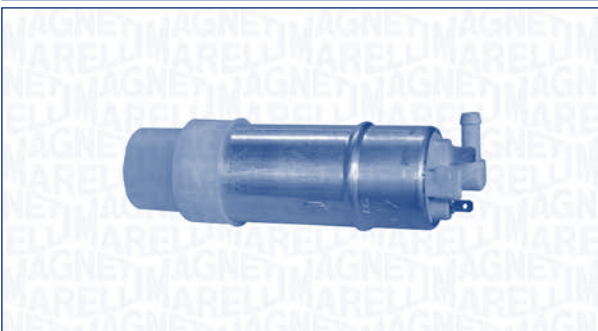

BMW

5 (E34)

520 i 24V Petrol 110 09/89 → 09/95

5 (E39)

520 i Petrol 125 09/00 → 06/03

520 i Petrol 100 04/99 → 06/03

520 i Petrol 110 01/96 → 09/00

523 i Petrol 125 11/95 → 09/00

525 i Petrol 141 09/00 → 06/03

528 i Petrol 142 11/95 → 09/00

530 i Petrol 170 09/00 → 06/03

535 i Petrol 180 04/99 → 06/03

5 Touring (E39)

520 i Petrol 125 09/00 → 05/04

520 i Petrol 100 04/99 → 05/04

525 i Petrol 141 09/00 → 05/04

528 i Petrol 142 01/97 → 09/00

530 i Petrol 170 09/00 → 05/04

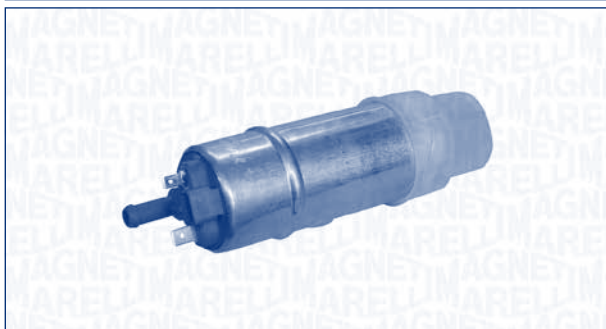
ESS522
J1 | **POMPA CARBURANTE**
PB | **FUEL PUMP**

BMW
X5 (E53)

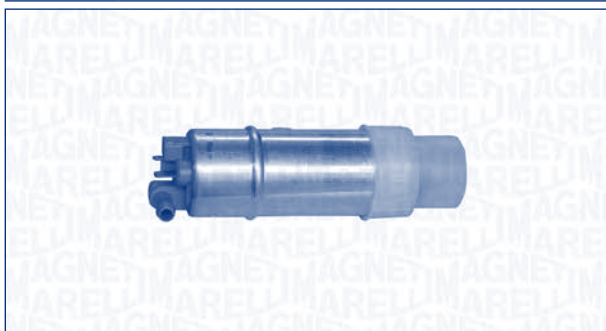
3.0 i	Petrol	163	05/00 →	
3.0 i	Petrol	170	05/00 →	
4.4 i	Petrol	210	05/00 →	
4.4 i	Petrol	235	12/03 →	
4.6 is	Petrol	255	02/02 →	

ESS523
J1 | **POMPA CARBURANTE**
PB | **FUEL PUMP**

BMW
7 (E65, E66, E67)

730 i,Li	Petrol	170	03/03 →	
735 i,Li	Petrol	200	11/01 →	
745 i,Li	Petrol	245	11/01 →	

ESS524
J1 | **POMPA CARBURANTE**
PB | **FUEL PUMP**

BMW
3 (E36)

316 i	Petrol	75	07/93 → 02/98	
316 i	Petrol	73	09/90 → 12/90	
316 i	Petrol	75	09/90 → 12/90	
318 is	Petrol	103	06/93 → 09/97	
318 is	Petrol	103	12/95 → 02/98	
320 i	Petrol	110	09/90 → 02/98	
323 i 2.5	Petrol	125	03/95 → 02/98	
328 i	Petrol	142	01/95 → 02/98	

3 Cabriolet (E36)

320 i	Petrol	110	12/93 → 04/99	
323 i	Petrol	125	06/95 → 04/99	
325 i	Petrol	141	03/93 → 03/95	
328 i	Petrol	142	03/95 → 04/99	
316 g	BiFuel	75	03/94 → 08/00	
316 i	Petrol	77	12/98 → 08/00	
316 i	Petrol	75	03/94 → 08/00	
318 ti	Petrol	103	11/94 → 08/95	
318 ti	Petrol	103	12/95 → 08/00	

3 Compact (E36)

323 ti	Petrol	125	08/97 → 08/00	
--------	--------	-----	---------------	--

3 Coupé (E36)

316 i	Petrol	75	09/93 → 04/99	
318 is	Petrol	103	06/93 → 10/95	
318 is	Petrol	103	12/95 → 04/99	
320 i	Petrol	110	03/92 → 04/99	
323 i	Petrol	125	03/95 → 04/99	
328 i	Petrol	142	01/95 → 04/99	

3 Touring (E36)

316 i	Petrol	75	01/96 → 10/99	
320 i	Petrol	110	01/95 → 10/99	
323 i	Petrol	125	09/95 → 10/99	
328 i	Petrol	142	01/95 → 10/99	

ESS528

J1
PBPOMPA CARBURANTE
FUEL PUMP

KW



MERCEDES-BENZ

190 (W201)

2.6	Petrol	118	08/86 → 08/88	
E 2.0	Petrol	93	10/82 → 08/89	
E 2.0 (201.024)	Petrol	90	10/82 → 08/89	ENGINE: M102961
E 2.3-16	Petrol	125	09/85 → 12/87	
E 2.3-16	Petrol	130	09/85 → 08/88	
E 2.3-16 (201.034)	Petrol	136	04/84 → 01/87	
E 2.5-16	Petrol	143	03/89 → 04/90	
E 2.5-16	Petrol	150	09/88 → 08/93	
E 2.6	Petrol	122	09/86 → 12/89	
E 2.6 (201.029)	Petrol	118	09/86 → 08/89	ENGINE: M103942
E Evolution II 2.5	Petrol	173	05/90 → 08/93	

CABRIOLET (A124)

300 CE-24 (124.061)	Petrol	162	04/92 → 06/93	
---------------------	--------	-----	---------------	--

CLASSE C (W202)

C 280 (202.028)	Petrol	142	05/93 → 05/97	
C 36 AMG (202.028)	Petrol	206	05/94 → 05/97	

CLASSE E (W124)

E 280 (124.028)	Petrol	145	06/93 → 06/95	
E 280 (124.029)	Petrol	142	06/93 → 06/95	
E 300 4-matic (124.230)	Petrol	132	06/93 → 06/95	CHASSIS: A368937 →
E 320 (124.032)	Petrol	162	06/93 → 06/95	
E 420 (124.034)	Petrol	205	06/93 → 06/95	CHASSIS: → C226335
E 500 (124.036)	Petrol	235	06/93 → 06/95	
E 60 AMG (124.036)	Petrol	280	05/94 → 06/95	

CLASSE E (W210)

E 200 (210.035)	Petrol	100	06/95 → 08/00	
E 230 (210.037)	Petrol	110	06/95 → 06/97	

ESS528



KW



MERCEDES-BENZ

CLASSE E Cabriolet (A124)

E 320 (124.066)	Petrol	162	06/93 → 03/98	ENGINE: M104992
E 36 AMG (124.066)	Petrol	200	05/94 → 03/98	CHASSIS: → C226335

CLASSE E Coupé (C124)

E 220 (124.042)	Petrol	110	06/93 → 06/97	CHASSIS: C226336 →
E 320 (124.052)	Petrol	162	06/93 → 06/97	CHASSIS: → C226335
E 36 AMG (124.052)	Petrol	195	06/93 → 02/94	CHASSIS: → C226335
E 36 AMG (124.052)	Petrol	200	05/94 → 06/96	CHASSIS: → C226335

CLASSE E Station wagon (S124)

E 200 T (124.079)	Petrol	100	06/93 → 05/96	
E 220 T (124.082)	Petrol	110	06/93 → 05/96	
E 280 T (124.088)	Petrol	142	06/93 → 05/96	
E 280 T (124.088)	Petrol	145	06/93 → 05/96	
E 300 T 4-matic (124.290)	Petrol	132	06/93 → 06/95	
E 320 T (124.092)	Petrol	162	06/93 → 05/96	
E 36 T AMG (124.092)	Petrol	200	05/94 → 05/96	

CLASSE E Station wagon (S210)

E 200 T (210.235)	Petrol	100	06/96 → 08/00	
E 230 T (210.237)	Petrol	110	06/96 → 06/97	

CLASSE S (W140)

3.2	Petrol	162	10/95 → 08/98	CHASSIS: → A220200
300 SE 2.8 (140.028)	Petrol	145	01/93 → 05/93	CHASSIS: → A220200
300 SE,SEL/ S320 (140.032, 140.033)	Petrol	170	03/91 → 09/98	CHASSIS: → A220200
400 SE,SEL/ S420 (140.042, 140.043)	Petrol	210	02/91 → 09/98	CHASSIS: → A220200
500 SE,SEL (140.050, 140.051)	Petrol	240	02/91 → 05/93	CHASSIS: → A220200
600 SE,SEL (140.056, 140.057)	Petrol	300	04/91 → 12/92	CHASSIS: → A220200
S 280 (140.028)	Petrol	142	05/93 → 09/98	CHASSIS: → A220200
S 350 Turbo-D (140.134)	Diesel	110	05/93 → 06/96	CHASSIS: → A220200
S 420 (140.042)	Petrol	205	05/93 → 09/98	CHASSIS: → A220200
S 500 (140.050, 140.051)	Petrol	235	05/93 → 09/98	CHASSIS: → A220200

ESS528

MERCEDES-BENZ
CLASSE S (W140)

S 600 (140.056, 140.057)	Petrol	290	01/93 → 09/98	ENGINE: M120980-M120982
--------------------------	--------	-----	---------------	-------------------------

CLASSE S Coupé (C126)

420 SEC (126.046)	Petrol	150	10/85 → 06/91	
420 SEC (126.046)	Petrol	160	10/85 → 12/87	
420 SEC (126.046)	Petrol	165	10/85 → 06/91	
500 SEC (126.044)	Petrol	164	10/85 → 06/91	
500 SEC (126.044)	Petrol	180	09/85 → 06/91	
500 SEC (126.044)	Petrol	185	08/87 → 06/91	
500 SEC (126.044)	Petrol	195	09/85 → 06/91	
500 SEC Cat.	Petrol	185	06/89 → 06/91	
560 SEC (126.045)	Petrol	178	10/85 → 06/91	
560 SEC (126.045)	Petrol	200	10/85 → 12/87	
560 SEC (126.045)	Petrol	205	10/85 → 06/91	
560 SEC (126.045)	Petrol	220	10/85 → 08/87	

CLASSE S Coupé (C140)

SEC/CL 420 (140.063)	Petrol	205	10/94 → 02/99	ENGINE: M119971-M119981
SEC/CL 500 (140.070)	Petrol	235	10/92 → 02/99	ENGINE: M119970
SEC/CL 600 (140.076)	Petrol	290	09/92 → 05/96	ENGINE: M120980-M120982

COUPE (C124)

220 CE (124.042)	Petrol	110	10/92 → 05/93	CHASSIS: C226336 →
300 CE (124.050)	Petrol	132	03/87 → 05/93	
320 CE (124.052)	Petrol	162	10/92 → 05/93	CHASSIS: → C226335

KOMBI Station wagon (S124)

200 TE	Petrol	90	09/88 → 12/89	
200 TE (124.079)	Petrol	100	05/86 → 06/93	
200 TE (124.081)	Petrol	87	09/88 → 08/92	
220 TE (124.082)	Petrol	110	10/92 → 05/93	
230 TE (124.083)	Petrol	100	09/85 → 08/92	
230 TE (124.083)	Petrol	97	09/85 → 08/92	

ESS528

MERCEDES-BENZ
KOMBI Station wagon (S124)

230 TE (124.083) Cat.	Petrol	97	06/89 → 08/92	
260 TE FGST.	Petrol	118	09/89 → 08/92	
260 TE FGST.	Petrol	122	09/85 → 12/89	
280 TE (124.088)	Petrol	145	10/92 → 06/93	
300 TE (124.090)	Petrol	132	01/86 → 08/92	
300 TE (124.090)	Petrol	138	01/86 → 12/89	
300 TE 4-matic (124.290)	Petrol	132	08/89 → 06/93	
300 TE 4-matic (124.290)	Petrol	138	09/86 → 08/89	
300 TE-24 (124.091)	Petrol	162	09/89 → 08/92	
320 TE (124.092)	Petrol	162	10/92 → 06/93	

SL (R129)

280 (129.058)	Petrol	142	08/93 → 05/98	
300 SL (129.060)	Petrol	140	03/89 → 06/93	
300 SL-24 (129.061)	Petrol	170	03/89 → 06/93	
320 (129.063)	Petrol	170	09/93 → 05/98	
500 (129.067)	Petrol	235	09/92 → 05/98	
500 SL (129.066)	Petrol	240	09/89 → 08/92	
600 (129.076)	Petrol	290	07/92 → 09/95	ENGINE: M120981

Tre volumi (W124)

200 E (124.021)	Petrol	87	09/88 → 08/92	
200 E (124.021)	Petrol	90	09/88 → 12/89	
230 E (124.023)	Petrol	100	01/85 → 06/93	
230 E (124.023)	Petrol	97	12/84 → 03/92	
230 E (124.023) Cat.	Petrol	97	06/89 → 06/93	
260 E (124.026)	Petrol	118	09/85 → 08/92	CHASSIS: A368937 →
260 E (124.026)	Petrol	122	09/85 → 12/89	CHASSIS: A368937 →
260 E 4-matic (124.226)	Petrol	118	09/86 → 08/92	CHASSIS: A368937 →
260 E 4-matic (124.226)	Petrol	122	12/86 → 12/89	CHASSIS: A368937 →
280 E (124.028)	Petrol	145	10/92 → 06/93	
300 E	Petrol	138	01/85 → 12/85	CHASSIS: A368937 →
300 E	Petrol	138	06/85 → 08/92	CHASSIS: A368937 →
300 E (124.030)	Petrol	132	08/85 → 08/92	CHASSIS: A368937 →
300 E 4-matic	Petrol	138	09/86 → 02/92	CHASSIS: A368937 →
300 E 4-matic (124.230)	Petrol	132	09/86 → 06/93	CHASSIS: A368937 →

ESS528



KW



MERCEDES-BENZ

Tre volumi (W124)

300 E-24 (124.031)	Petrol	162	09/88 → 08/92	
320 E (124.032)	Petrol	162	10/92 → 06/93	
400 E 4.2 (124.034)	Petrol	205	10/92 → 06/93	CHASSIS: → C226335
500 E (124.036)	Petrol	240	01/91 → 06/93	
500 E AMG 6.0	Petrol	275	01/92 → 06/93	

ESS529

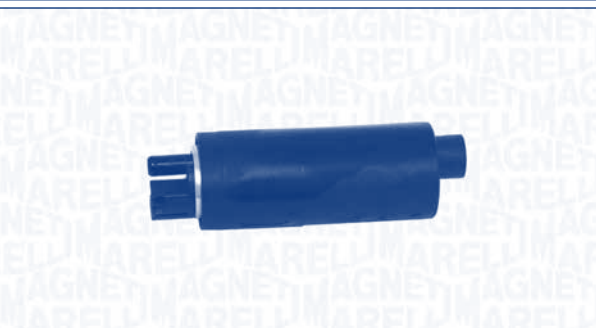
J1
PBPOMPA CARBURANTE
FUEL PUMP

KW



AUDI

100 (4A, C4)

2.0 E	Petrol	85	12/92 → 06/94	ENGINE: ABK
2.6	Petrol	102	07/93 → 06/94	
2.6	Petrol	110	03/92 → 06/94	
2.6 quattro	Petrol	110	04/92 → 06/94	
2.8 E quattro	Petrol	128	12/90 → 06/94	
S4 Turbo quattro	Petrol	169	06/92 → 06/94	
S4 V8 quattro	Petrol	206	10/92 → 06/94	

100 Avant (4A, C4)

2.0 E	Petrol	85	12/92 → 06/94	ENGINE: ABK
2.6	Petrol	102	07/93 → 06/94	
2.6	Petrol	110	06/92 → 06/94	
2.6 quattro	Petrol	110	07/92 → 06/94	
2.8 E	Petrol	128	09/91 → 06/94	
2.8 E quattro	Petrol	128	09/91 → 06/94	

200 Avant (44, 44Q)

2.2 20V Turbo quattro	Petrol	162	07/89 → 11/90	
-----------------------	--------	-----	---------------	--

80 (8C, B4)

1.6 E	Petrol	74	06/93 → 12/94	
2.0 E	Petrol	85	09/91 → 12/94	
2.0 E quattro	Petrol	85	09/91 → 12/94	
2.6	Petrol	110	07/92 → 12/94	

ESS529



KW



AUDI

80 (8C, B4)

2.6 quattro	Petrol	110	06/92 → 12/94	
2.8	Petrol	128	09/91 → 12/94	
2.8 quattro	Petrol	128	09/91 → 12/94	
S2 quattro	Petrol	169	02/93 → 12/94	

80 Avant (8C, B4)

1.6 E	Petrol	74	06/93 → 07/95	
2.0 E	Petrol	85	07/92 → 07/95	
2.0 quattro	Petrol	79	11/93 → 07/95	
2.6	Petrol	110	07/92 → 05/95	
2.6 quattro	Petrol	110	07/92 → 07/95	
2.8	Petrol	128	07/92 → 05/95	
2.8 quattro	Petrol	128	08/92 → 07/95	
S2 quattro	Petrol	169	06/94 → 07/95	

A6 (4A, C4)

1.8	Petrol	92	12/95 → 10/97	
1.8 quattro	Petrol	92	12/95 → 10/97	
2.0	Petrol	85	06/94 → 08/96	
2.6	Petrol	110	06/94 → 10/97	
2.6	Petrol	102	06/94 → 10/97	
2.6 quattro	Petrol	110	06/94 → 10/97	
2.8	Petrol	128	06/94 → 10/97	
2.8	Petrol	142	12/95 → 10/97	
2.8 quattro	Petrol	128	06/94 → 10/97	
2.8 quattro	Petrol	142	12/95 → 10/97	
S6 4.2 quattro	Petrol	213	08/94 → 07/97	
S6 Turbo quattro	Petrol	169	06/94 → 07/97	

A6 Avant (4A, C4)

1.8	Petrol	92	12/95 → 10/97	
1.8 quattro	Petrol	92	06/96 → 10/97	
2.0	Petrol	85	06/94 → 06/96	
2.0 16V	Petrol	103	06/96 → 10/97	
2.6	Petrol	102	06/94 → 07/96	
2.6	Petrol	110	06/94 → 06/96	
2.8	Petrol	128	06/94 → 07/96	
2.8	Petrol	142	12/95 → 10/97	
2.8 quattro	Petrol	128	06/94 → 10/97	
2.8 quattro	Petrol	142	06/96 → 10/97	
S6 4.2 quattro	Petrol	213	08/94 → 07/97	
S6 Turbo quattro	Petrol	169	06/94 → 07/97	

COUPE (89, 8B)

2.0 20 V quattro	Petrol	118	07/90 → 07/91	
2.3 20V quattro	Petrol	123	07/90 → 07/91	
2.3 20V quattro	Petrol	125	07/90 → 07/91	
2.6 quattro	Petrol	110	08/92 → 12/95	

ESS529

AUDI
COUPE (89, 8B)

2.8 quattro	Petrol	128	08/91 → 12/95
S2 quattro	Petrol	162	09/90 → 09/92
S2 quattro	Petrol	169	10/92 → 12/95

V8 (44_, 4C_)

3.6 quattro	Petrol	180	04/93 → 11/93
3.6 quattro	Petrol	184	10/88 → 11/93
4.2 quattro	Petrol	206	10/91 → 11/93

ESS530
**J1
PB**
**POMPA CARBURANTE
FUEL PUMP**

OPEL
ASTRA F (56_, 57_)

1.4	Petrol	60	09/92 → 02/98
1.4 i 16V	Petrol	66	03/96 → 02/98
1.4 Si	Petrol	60	03/92 → 02/98
1.6 i 16V	Petrol	74	08/94 → 02/98
1.6 Si	Petrol	74	05/92 → 12/94
1.8 i	Petrol	66	03/92 → 02/98
1.8 i 16V	Petrol	85	11/94 → 08/98
1.8 i 16V	Petrol	92	08/93 → 10/94
2.0 i	Petrol	85	03/92 → 02/98
2.0 i 16V	Petrol	100	02/95 → 02/98

ASTRA F 2 volumi /Coda spiovente (53_, 54_, 58_, 59_)

1.4	Petrol	60	09/92 → 01/98
1.4 i 16V	Petrol	66	03/96 → 01/98
1.4 Si	Petrol	60	03/92 → 01/98
1.6 i 16V	Petrol	74	08/94 → 01/98
1.6 Si	Petrol	74	03/92 → 12/94
1.8 i	Petrol	66	09/91 → 01/98
1.8 i 16V	Petrol	85	09/94 → 01/98
1.8 i 16V	Petrol	92	08/93 → 08/94
2.0 GSI 16V	Petrol	110	09/91 → 01/98

ESS530

OPEL
ASTRA F 2 volumi /Coda spiovente (53_, 54_, 58_, 59_)

2.0 i	Petrol	85	09/91 → 01/98
2.0 i 16V	Petrol	100	02/95 → 01/98

ASTRA F Cabriolet (53_B)

1.4 i 16V	Petrol	66	03/96 → 02/98
1.4 Si	Petrol	60	05/93 → 02/98
1.8 i 16V	Petrol	85	11/94 → 08/98
2.0 i	Petrol	85	03/93 → 10/94

ASTRA F CLASSIC 2 volumi /Coda spiovente

1.6 i 16V	Petrol	74	01/98 → 08/00
-----------	--------	----	---------------

ASTRA F CLASSIC Station wagon

1.6 i 16V	Petrol	74	01/98 → 08/00
-----------	--------	----	---------------

ASTRA F CLASSIC Tre volumi

1.6 i 16V	Petrol	74	01/98 → 08/00
-----------	--------	----	---------------

ASTRA F Station wagon (51_, 52_)

1.4	Petrol	60	09/92 → 01/98
1.4 i 16V	Petrol	66	03/96 → 01/98
1.4 Si	Petrol	60	03/92 → 01/98
1.6 i 16V	Petrol	74	08/94 → 01/98
1.6 Si	Petrol	74	03/92 → 12/94
1.8 i	Petrol	66	09/91 → 01/98
1.8 i 16V	Petrol	85	08/94 → 01/98
1.8 i 16V	Petrol	92	08/93 → 01/98
2.0 i	Petrol	85	09/91 → 07/94
2.0 i 16V	Petrol	100	02/95 → 01/98
2.0 i 16V	Petrol	110	03/93 → 01/98

ASTRA G 2 volumi /Coda spiovente (F48_, F08_)

1.4 16V	Petrol	66	02/98 → 09/00	ENGINE: X14XE
---------	--------	----	---------------	---------------

ASTRA G Station wagon (F35_)

1.4 16V	Petrol	66	06/98 → 09/00	ENGINE: X14XE
---------	--------	----	---------------	---------------

ASTRA G Tre volumi (F69_)

1.4 16V	Petrol	66	09/98 → 09/00	ENGINE: X14XE
---------	--------	----	---------------	---------------

CALIBRA A (85_)

2.0 i	Petrol	85	06/90 → 03/97
2.0 i 16V	Petrol	110	06/90 → 02/94
2.0 i 16V	Petrol	100	02/94 → 08/96
2.0 i 16V 4x4	Petrol	110	06/90 → 02/94
2.0 i 16V 4x4	Petrol	100	02/94 → 08/96
2.0 i 4x4	Petrol	85	06/90 → 03/97
2.0 i Turbo 4x4	Petrol	150	03/92 → 03/97
2.5 i V6	Petrol	125	04/93 → 03/97

COMBO (71_)

1.4 16V	Petrol	66	08/99 → 10/01	ENGINE: C14SEL
---------	--------	----	---------------	----------------

CORSA A 2 volumi /Coda spiovente (93_, 94_, 98_, 99_)

1.6 GSI	Petrol	72	09/89 → 03/93
---------	--------	----	---------------

ESS530



KW



OPEL

OMEGA A (16_, 17_, 19_)

1.8	Petrol	85	09/86 → 03/94	CHASSIS: K1000099 →
2.0	Petrol	73	09/90 → 02/92	CHASSIS: K1000099 →
2.0	Petrol	74	09/90 → 02/92	CHASSIS: K1000099 →
2.0	Petrol	90	09/86 → 03/94	CHASSIS: K1000099 →
2.0 i	Petrol	85	09/86 → 03/94	CHASSIS: K1000099 →
2.4 i	Petrol	92	09/88 → 03/94	CHASSIS: K1000099 →
2.6 i	Petrol	110	09/90 → 03/94	CHASSIS: K1000099 →
3.0 (3000)	Petrol	130	03/87 → 12/89	CHASSIS: K1000099 →
3.0 24V (3000)	Petrol	147	09/89 → 03/94	CHASSIS: K1000099 →
3.0 24V (3000)	Petrol	150	09/89 → 03/94	CHASSIS: K1000099 →

OMEGA A Station wagon (66_, 67_)

1.8	Petrol	85	09/86 → 03/94	CHASSIS: K1000099 →
2.0	Petrol	74	09/90 → 02/92	CHASSIS: K1000099 →
2.0	Petrol	90	09/86 → 03/94	CHASSIS: K1000099 →
2.0 i	Petrol	73	09/90 → 02/92	CHASSIS: K1000099 →
2.0 i	Petrol	85	09/86 → 03/94	CHASSIS: K1000099 →
2.4 i	Petrol	92	09/88 → 03/94	CHASSIS: K1000099 →
2.6 i	Petrol	110	09/90 → 03/94	CHASSIS: K1000099 →
3.0	Petrol	115	03/87 → 12/87	CHASSIS: K1000099 →
3.0	Petrol	130	03/87 → 12/89	CHASSIS: K1000099 →
3.0 24V	Petrol	147	09/89 → 03/94	CHASSIS: K1000099 →
3.0 24V Omega 3000	Petrol	150	08/89 → 03/94	CHASSIS: K1000099 →
3.0 Cat.	Petrol	130	12/87 → 03/94	CHASSIS: K1000099 →

OMEGA B (25_, 26_, 27_)

2.6 V6	Petrol	132	09/00 → 07/03	
3.2 V6	Petrol	160	02/01 → 07/03	

OMEGA B Station wagon (21_, 22_, 23_)

2.6 V6	Petrol	132	09/00 → 07/03	
3.2 V6	Petrol	160	02/01 → 07/03	

SENATOR B (29_)

2.6 i	Petrol	110	09/90 → 09/93	CHASSIS: K1000099 →
3.0	Petrol	115	09/87 → 09/93	CHASSIS: K1000099 →
3.0	Petrol	130	01/88 → 12/89	CHASSIS: K1000099 →
3.0 24V	Petrol	150	09/89 → 09/93	CHASSIS: K1000099 →

VECTRA A (86_, 87_)

2.0	Petrol	74	09/88 → 09/89	
2.0 i	Petrol	95	09/88 → 09/92	
2.0 i	Petrol	85	09/88 → 10/90	
2.0 i 16V	Petrol	100	06/94 → 08/95	
2.0 i 16V 4x4	Petrol	100	06/94 → 08/95	
2.0 i Turbo 4x4	Petrol	150	06/94 → 08/95	CHASSIS: S1008893 →
2.5 CD 4x4	Petrol	125	01/93 → 08/95	
2.5 V6	Petrol	125	02/93 → 08/95	

ESS530



KW



OPEL

VECTRA A (86_, 87_)

2000 16V 4x4	Petrol	110	08/89 → 10/90	CHASSIS: S1008893 →
2000/GT 16V	Petrol	110	08/89 → 06/94	

VECTRA A 2 volumi /Coda spiovente (88_, 89_)

2.0	Petrol	74	08/88 → 09/89	
2.0 i	Petrol	85	09/88 → 10/90	
2.0 i 16V	Petrol	100	06/94 → 08/95	
2.0 i 16V	Petrol	110	08/89 → 10/90	ENGINE: 20XEJ
2.0 i GT	Petrol	95	09/88 → 08/95	
2.5 V6	Petrol	125	02/93 → 08/95	

ZAFIRA A (F75_)

1.6 16V	Petrol	74	04/99 → 08/99	ENGINE: X16XEL
---------	--------	----	---------------	----------------

VAUXHALL

ASTRA Mk III (F)

1.4 i	Petrol	60	04/92 → 02/98	
1.6 i	Petrol	74	05/92 → 12/94	
2.0 i	Petrol	85	03/92 → 02/98	

ASTRA Mk III (F) 2 volumi /Coda spiovente

1.4 i	Petrol	60	03/92 → 02/98	
1.6 i	Petrol	74	03/92 → 02/98	
2.0 i	Petrol	85	09/91 → 02/98	
2.0 i 16V	Petrol	110	09/91 → 02/98	ENGINE: C20XE

ASTRA Mk III (F) Cabriolet

1.4 i	Petrol	60	05/93 → 02/98	
2.0 i	Petrol	85	03/93 → 10/94	

ASTRA Mk III (F) Station wagon

1.4 i	Petrol	60	02/92 → 02/98	
1.6 Si	Petrol	74	02/92 → 12/94	
2.0 i	Petrol	85	09/91 → 02/98	

ASTRA Mk IV (G) 2 volumi /Coda spiovente

1.4 16V	Petrol	66	02/98 → 08/00	ENGINE: X14XE
1.6 16V	Petrol	74	02/98 → 08/00	ENGINE: X16XEL

ASTRA Mk IV (G) Tre volumi

1.4 16V	Petrol	66	09/98 → 08/00	ENGINE: X14XE
1.6 16V	Petrol	74	09/98 → 08/00	ENGINE: X16XEL

CARLTON Mk III

1.8 i	Petrol	85	09/86 → 03/94	CHASSIS: K1000099 →
2.0 i	Petrol	90	09/86 → 03/94	CHASSIS: K1000099 →
3.0 3000	Petrol	130	03/87 → 09/90	CHASSIS: K1000099 →
3.0 3000 24V	Petrol	150	09/89 → 03/94	CHASSIS: K1000099 →

CARLTON Mk III Station wagon

1.8 i	Petrol	85	09/86 → 03/94	CHASSIS: K1000099 →
2.0 i	Petrol	90	09/86 → 03/94	CHASSIS: K1000099 →

CAVALIER Mk III (87)

2.0 i	Petrol	85	09/88 → 10/90	
-------	--------	----	---------------	--

ESS530

VAUXHALL
CAVALIER Mk III (87)

2.0 i 16V	Petrol	110	09/88 → 11/95	
2.0 i 16V 4x4	Petrol	110	09/88 → 11/95	CHASSIS: S1008893 →
2.0 i 4x4	Petrol	85	01/91 → 10/92	
2.0 i 4x4	Petrol	95	09/88 → 09/92	CHASSIS: S1008893 →
2.0 i Cat.	Petrol	85	09/90 → 11/95	
2.0 i Turbo 4x4	Petrol	150	08/92 → 11/94	CHASSIS: S1008893 →
2.0 SRi	Petrol	95	09/88 → 09/92	
2.0 SRi 16V	Petrol	100	09/93 → 11/95	
2.5 V6	Petrol	125	08/88 → 06/94	

CAVALIER Mk III 2 volumi /Coda spiovente

2.0 i	Petrol	85	09/88 → 10/92	
2.0 i 16V	Petrol	100	09/93 → 11/95	
2.0 i 16V	Petrol	110	09/88 → 11/95	
2.0 i 16V 4x4	Petrol	110	01/92 → 11/93	
2.0 i 4x4	Petrol	95	09/88 → 09/92	
2.0 i 4x4	Petrol	85	01/91 → 10/92	
2.0 i Cat.	Petrol	85	09/90 → 11/95	
2.0 SRi	Petrol	95	09/88 → 09/92	
2.5 V6	Petrol	125	09/88 → 06/94	

OMEGA (B)

2.6 V6	Petrol	132	08/00 → 07/03	
3.2 V6	Petrol	160	02/01 → 07/03	

OMEGA (B) Station wagon

2.2 16V	Petrol	106	08/00 → 06/03	ENGINE: Z22XE
2.6 V6	Petrol	132	08/00 → 06/03	
3.2 V6	Petrol	160	02/01 → 06/03	

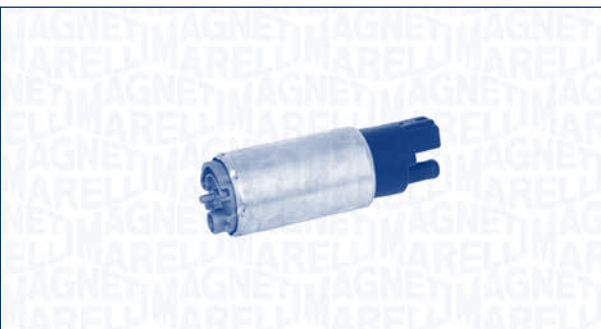
ESS531
**J1
PB** **POMPA CARBURANTE
FUEL PUMP**

ALFA ROMEO
155 (167)

1.7 T.S.	Petrol	83	04/93 → 04/96	
----------	--------	----	---------------	--

ESS531

ALFA ROMEO
155 (167)

1.7 T.S. (167.A4D, 167.A4H)	Petrol	85	04/93 → 04/96	
1.8 T.S.	Petrol	95	02/92 → 06/93	
1.8 T.S. Sport (167.A4A, 167.A4C, 167.A4E)	Petrol	93	01/92 → 04/96	
2.0 T.S. (167.A2)	Petrol	106	02/92 → 04/93	
2.0 T.S. (167.A2A)	Petrol	104	03/93 → 02/95	
2.0 T.S. 16V (167.A2G)	Petrol	110	03/95 → 10/97	
2.5 V6 (167.A1)	Petrol	121	02/92 → 04/96	
2.5 V6 (167.A1C, 167.A1E)	Petrol	120	04/96 → 10/97	

GTV (916C_)

2.0 T.SPARK 16V (916.C2_, 916C2C00)	Petrol	110	06/95 → 04/98	
-------------------------------------	--------	-----	---------------	--

FIAT
COUPE (FA/175)

2.0 16V	Petrol	102	03/94 → 08/96	
---------	--------	-----	---------------	--

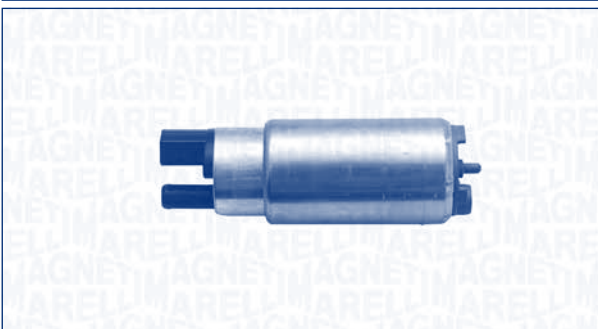
ESS532
**J1
PB** **POMPA CARBURANTE
FUEL PUMP**

OPEL
ASTRA G 2 volumi /Coda spiovente (F48_, F08_)

1.2 16V	Petrol	48	02/98 → 09/00	
1.2 16V	Petrol	55	09/00 → 09/03	
1.4 16V	Petrol	66	02/98 → 01/04	
1.6	Petrol	62	09/00 → 01/04	
1.6	Petrol	76	02/03 → 01/04	
1.6 16V	Petrol	74	02/98 → 01/04	
1.8 16V	Petrol	85	02/98 → 08/00	

ESS532

KW

OPEL
ASTRA G 2 volumi /Coda spiovente (F48_, F08_)

1.8 16V	Petrol	92	09/00 → 01/04
2.0 16V	Petrol	100	02/98 → 01/04
2.0 16V OPC	Petrol	118	11/99 → 09/02

ASTRA G Cabriolet (F67)

1.6	Petrol	76	02/03 → 08/05
1.6 16V	Petrol	74	03/01 → 08/05
1.8 16V	Petrol	92	03/01 → 08/05

ASTRA G Coupé (F07_)

1.6 16V	Petrol	76	02/03 → 02/05
1.8 16V	Petrol	85	03/00 → 08/00
1.8 16V	Petrol	92	09/00 → 02/05

ASTRA G Furgonato (F70)

1.6	Petrol	62	09/00 → 06/04
-----	--------	----	---------------

ASTRA G Station wagon (F35_)

1.2 16V	Petrol	48	02/98 → 09/00
1.2 16V	Petrol	55	09/00 → 09/03
1.4 16V	Petrol	66	06/98 → 06/04
1.6	Petrol	62	09/00 → 06/04
1.6	Petrol	76	02/03 → 06/04
1.6 16V	Petrol	74	02/98 → 06/04
1.8 16V	Petrol	85	02/98 → 08/00
1.8 16V	Petrol	92	09/00 → 06/04
2.0 16V	Petrol	100	02/98 → 06/04

ASTRA G Tre volumi (F69_)

1.2 16V	Petrol	48	09/98 → 09/00
1.2 16V	Petrol	55	09/00 → 09/03
1.4 16V	Petrol	66	09/98 → 01/04
1.6	Petrol	62	09/00 → 01/04
1.6	Petrol	76	02/03 → 01/04
1.6 16V	Petrol	74	09/98 → 01/04
1.8 16V	Petrol	85	09/98 → 08/00
1.8 16V	Petrol	92	06/00 → 01/04
2.0 16V	Petrol	100	09/98 → 01/04

COMBO (71_)

1.4	Petrol	60	08/94 → 10/01
1.4 16V	Petrol	66	08/99 → 10/01

COMBO Cassone / Furgonato / Promiscuo

1.6	Petrol	64	10/01 → 08/04
-----	--------	----	---------------

COMBO Tour

1.6	Petrol	64	10/01 → 08/04
-----	--------	----	---------------

CORSA B (73_, 78_, 79_)

1.2 i 16V	Petrol	48	03/98 → 08/00
1.4 i 16V	Petrol	63	02/98 → 08/00
1.4 i 16V	Petrol	66	09/94 → 08/99

ESS532

KW

OPEL
CORSA B (73_, 78_, 79_)

1.4 Si	Petrol	60	03/93 → 08/00
1.6 GSI 16V	Petrol	80	03/93 → 08/00
1.6 i 16V	Petrol	74	05/98 → 08/00
1.6 i 16V	Petrol	78	09/94 → 08/99

OMEGA B (25_, 26_, 27_)

2.0	Petrol	85	03/94 → 08/98	CHASSIS: X1093314 →
2.0	Petrol	85	03/94 → 08/98	CHASSIS: X1093314 →
2.0 16V	Petrol	100	03/94 → 08/99	CHASSIS: X1093314 →
2.2 16V	Petrol	106	09/99 → 07/03	
2.5 V6	Petrol	125	03/94 → 09/00	CHASSIS: X1093314 →
3.0 V6	Petrol	155	04/94 → 02/01	CHASSIS: X1093314 →, → Y1999999

OMEGA B Station wagon (21_, 22_, 23_)

2.0	Petrol	85	03/94 → 08/98	CHASSIS: X1093314 →
2.0 16V	Petrol	100	03/94 → 08/99	CHASSIS: X1093314 →
2.2 16V	Petrol	106	09/99 → 07/03	
2.5 V6	Petrol	125	03/94 → 09/00	CHASSIS: X1093314 →
3.0 V6	Petrol	155	04/94 → 02/01	CHASSIS: X1093314 →, → Y1999999

TIGRA (95_)

1.4 16V	Petrol	63	08/97 → 08/99
1.4 16V	Petrol	66	08/94 → 08/99
1.6 16V	Petrol	74	08/97 → 08/98
1.6 16V	Petrol	78	08/94 → 08/98

VECTRA B (36_)

1.6 i 16V	Petrol	74	10/95 → 04/02	ENGINE: X16XEL-Y16XE
1.8 i 16V	Petrol	85	10/95 → 09/00	ENGINE: X18XE
2.0 i	Petrol	82	10/95 → 02/02	
2.0 i 16V	Petrol	100	10/95 → 09/00	
2.2 i 16V	Petrol	108	09/00 → 04/02	
2.5 i V6	Petrol	125	10/95 → 09/00	
2.6 i V6	Petrol	125	09/00 → 04/02	
i 500 2.5	Petrol	143	05/98 → 09/00	

VECTRA B 2 volumi /Coda spiovente (38_)

1.6 i 16V	Petrol	74	10/95 → 07/02	ENGINE: X16XEL-Y16XE
1.8 i 16V	Petrol	85	10/95 → 09/00	ENGINE: X18XE
2.0 i	Petrol	82	10/95 → 02/02	
2.0 i 16V	Petrol	100	10/95 → 09/00	
2.2 i 16V	Petrol	108	09/00 → 07/03	
2.5	Petrol	144	10/99 → 06/00	

ESS532

OPEL
VECTRA B 2 volumi /Coda spiovente (38_)

2.5 i V6	Petrol	125	10/95 → 09/00	
2.6 i V6	Petrol	125	09/00 → 09/02	

VECTRA B Station wagon (31_)

2.0 i	Petrol	82	11/96 → 02/02	
2.2 i 16V	Petrol	108	09/00 → 07/03	
2.6 i V6	Petrol	125	09/00 → 09/02	
i 500 2.5	Petrol	143	05/98 → 06/00	

ZAFIRA A (F75_)

1.6 16V	Petrol	74	08/99 → 06/05	ENGINE: Z16XE
1.8 16V	Petrol	92	09/00 → 06/05	
1.8 16V	Petrol	85	04/99 → 08/00	

VAUXHALL
ASTRA Mk IV (G) 2 volumi /Coda spiovente

1.2 16V	Petrol	55	09/00 → 05/05	
1.2 16V	Petrol	48	02/98 → 08/00	
1.4 16V	Petrol	66	02/98 → 05/05	
1.6	Petrol	62	09/00 → 05/05	
1.6 16V	Petrol	74	02/98 → 08/00	
1.8 16V	Petrol	92	09/00 → 05/05	
1.8 16V	Petrol	85	02/98 → 08/00	
2.0 16V	Petrol	100	02/98 → 05/05	

ASTRA Mk IV (G) Cabriolet

1.6 16V	Petrol	74	03/01 → 08/05	
1.8 16V	Petrol	92	03/01 → 08/05	

ASTRA Mk IV (G) Coupé (F67)

1.8 16V	Petrol	92	09/00 → 08/05	
1.8 16V	Petrol	85	03/00 → 08/00	

ASTRA Mk IV (G) Station wagon

1.2 16V	Petrol	55	09/00 → 05/05	
1.2 16V	Petrol	48	02/98 → 08/00	
1.4 16V	Petrol	66	02/98 → 08/00	
1.6	Petrol	62	03/98 → 04/04	
1.6 16V	Petrol	74	03/98 → 08/00	
1.8 16V	Petrol	92	09/00 → 05/05	
1.8 16V	Petrol	85	02/98 → 08/00	
2.0 16V	Petrol	100	02/98 → 05/05	

ASTRA Mk IV (G) Tre volumi

1.2 16V	Petrol	55	09/00 → 05/05	
1.2 16V	Petrol	48	09/98 → 08/00	
1.4 16V	Petrol	66	09/98 → 08/00	
1.6	Petrol	62	09/00 → 05/05	
1.6 16V	Petrol	74	09/98 → 08/00	
1.8 16V	Petrol	92	02/98 → 07/04	
1.8 16V	Petrol	85	02/98 → 08/00	

ESS532

OPEL
ASTRA Mk IV (G) Tre volumi

2.0 16V	Petrol	100	09/98 → 05/05	
---------	--------	-----	---------------	--

ASTRAVAN Mk IV (G)

1.6 i	Petrol	62	09/00 → 08/05	
-------	--------	----	---------------	--

COMBO Mk I (B)

1.4	Petrol	60	08/94 → 10/01	
-----	--------	----	---------------	--

COMBO Mk II (C) Cassone / Furgonato / Promiscuo (F25)

1.6	Petrol	62	09/01 → 08/04	
1.6	Petrol	64	10/01 → 08/04	

CORSA Cabriolet

1.4 i 16V	Petrol	66	01/98 → 01/99	
-----------	--------	----	---------------	--

CORSA Mk I (B)

1.2 i 16V	Petrol	48	03/98 → 08/00	
-----------	--------	----	---------------	--

OMEGA (B)

2.0	Petrol	85	09/95 → 09/96	CHASSIS: X1093314 →
2.2 16V	Petrol	106	01/94 → 06/03	

OMEGA (B) Station wagon

2.2 16V	Petrol	106	02/94 → 06/03	ENGINE: Y22XE
---------	--------	-----	---------------	---------------

TIGRA Mk I (F07)

1.4 16V	Petrol	66	08/94 → 08/99	
1.6 16V	Petrol	78	08/94 → 08/99	

VECTRA (B)

1.6 i 16V	Petrol	74	08/95 → 08/00	ENGINE: X16XEL-Y16XE
1.8 i 16V	Petrol	85	10/95 → 08/99	ENGINE: X18XE
2.0 i 16V	Petrol	100	10/95 → 01/01	
2.5 i GSi	Petrol	143	03/98 → 07/00	
2.5 i V6	Petrol	125	09/95 → 08/00	

VECTRA (B) 2 volumi /Coda spiovente

1.6 i 16V	Petrol	74	08/95 → 08/00	ENGINE: X16XEL-Y16XE
1.8 i 16V	Petrol	85	10/95 → 08/99	ENGINE: X18XE
2.0 i 16V	Petrol	100	10/95 → 01/01	
2.5 i GSi	Petrol	143	03/98 → 07/00	
2.5 i V6	Petrol	125	09/95 → 08/00	

VECTRA (B) Station wagon

1.6 i 16V	Petrol	74	11/96 → 08/00	ENGINE: X16XEL-Y16XE
1.8 i 16V	Petrol	85	11/96 → 08/99	ENGINE: X18XE
2.0 i 16V	Petrol	100	10/95 → 01/01	
2.5 i GSi	Petrol	143	05/98 → 09/99	
2.5 i V6	Petrol	125	11/96 → 08/00	

ZAFIRA Mk I (A) (F75)

1.6 16V	Petrol	74	04/99 → 08/99	
---------	--------	----	---------------	--

ESS532



OPEL

ZAFIRA Mk I (A) (F75)

1.8 16V	Petrol	85	05/99 → 08/00
1.8 16V	Petrol	92	09/00 → 06/05

ESS533

J1 POMPA CARBURANTE
PB FUEL PUMP

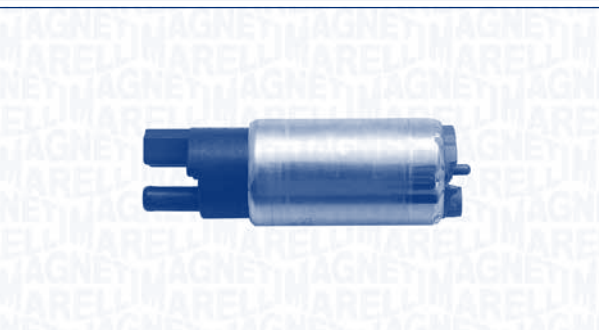

DACIA

SUPERNOVA

1.4	Petrol	55	04/00 → 03/03
-----	--------	----	---------------

ESS534

J1 POMPA CARBURANTE
PB FUEL PUMP

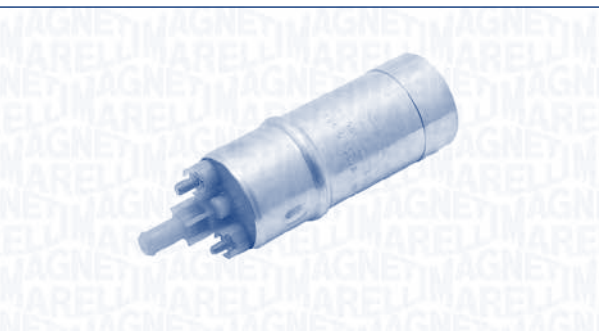

FIAT

DUCATO Autobus (230)

2.0 4x4	Petrol	80	11/94 → 11/01
2.0 Panorama/ Combinato	Petrol	80	03/94 → 04/02

DUCATO Furgonato (230L)

2.0	Petrol	80	03/94 → 04/02
-----	--------	----	---------------

DUCATO Pianale piatto/Telaio (230)

2.0	Petrol	80	06/98 → 04/02
-----	--------	----	---------------

ESS534



LANCIA

THEMA (834)

2000 i.e. (834BV)	Petrol	85	09/87 → 05/92
3000 V6 (834GD, 834FD)	Petrol	126	08/92 → 07/94

THEMA SW (834)

2000 16V (834FA)	Petrol	112	05/92 → 07/94
3000 V6 (834GD, 834FD)	Petrol	126	09/92 → 07/94

ESS535

J1 POMPA CARBURANTE
PB FUEL PUMP

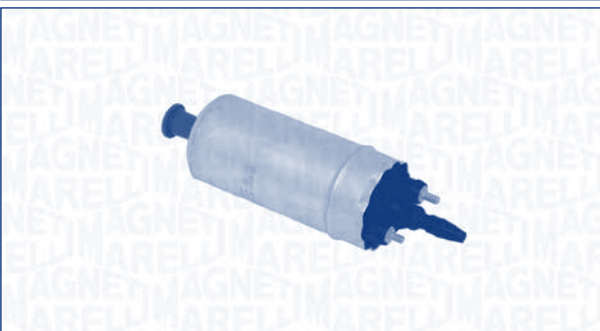

RENAULT

ESPACE III (JE0_)

2.2 dCi (JE0K)	Diesel	95	10/00 → 10/02
----------------	--------	----	---------------

KANGOO (KC0/1_)

1.9 dCi 4x4	Diesel	62	10/03 →
1.9 dCi 4x4 (KC0V)	Diesel	59	10/01 →

KANGOO Express (FC0/1_)

1.9 dCi 4x4 (FC0V)	Diesel	59	10/01 →
1.9 dCi 4x4 (FC0V)	Diesel	62	07/03 →
1.9 dTi (FC0U)	Diesel	59	02/00 →

LAGUNA II (BG0/1_)

1.9 dCi	Diesel	79	03/01 →
1.9 dCi (BG0E)	Diesel	77	06/01 →
1.9 dCi (BG0R)	Diesel	74	10/01 →

LAGUNA II Grandtour (KG0/1_)

1.9 dCi	Diesel	79	03/01 →
1.9 dCi (KG0E)	Diesel	77	06/01 →
1.9 dCi (KG0E, KG0R)	Diesel	74	10/01 →

ESS535

RENAULT
MASTER II Furgonato (FD)

2.2 dCi 90 Diesel 66 09/00 →

MEGANE I (BA0/1_)

1.9 dCi Diesel 77 03/99 → 08/03

 1.9 dCi Diesel 75 02/01 → 08/03
(BA05, BA1F)

MEGANE I Classic (LA0/1_)

 1.9 dCi Diesel 75 02/01 → 08/03
(LA05, LA1F)

MEGANE I Coach (DA0/1_)

1.9 dCi Diesel 77 03/99 → 09/00

 1.9 dCi Diesel 75 02/01 → 08/03
(DA05, DA1F)

MEGANE I Grandtour (KA0/1_)

 1.9 dCi 3 Diesel 75 02/01 → 08/03
(KA05, KA1F)

SCÉNIC I (JA0/1_)

 1.9 dCi Diesel 75 10/00 → 08/03
(JA05, JA1F)

1.9 dCi RX4 Diesel 75 11/00 → 08/03

SUZUKI
GRAND VITARA I (FT, GT)

2.0 HDi 110 16V Diesel 80 07/01 → 09/05

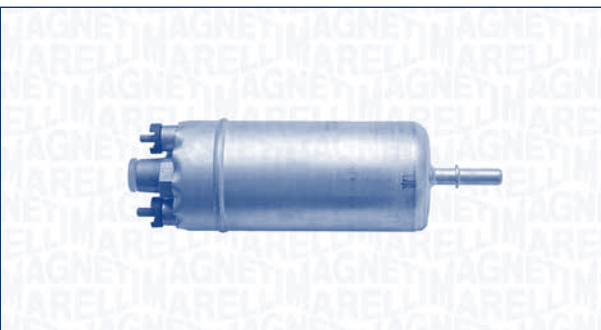
ESS536
**J1
PB**
**POMPA CARBURANTE
FUEL PUMP**

IVECO
DAILY III Cassone / Furgonato / Promiscuo

 29 L 10 V Diesel 70 09/02 →
(ALJA43A2, ALJA42A2, ALJA41A2)

ESS536

IVECO
DAILY III Cassone / Furgonato / Promiscuo

 35 S 13 V,35 C Diesel 92 05/99 →
13 V

40 C 13 Diesel 92 05/99 → 04/06

50 C 13 Diesel 92 05/99 →

DAILY III Pianale piatto/Telaio

 29 L 10 Diesel 70 09/02 →
(ALJAV1A1, ALJA41AA, ALJA41A1, AHJA64A1...)

35 S 13,35 C 13 Diesel 92 05/99 →

40 C 13 Diesel 92 05/99 → 04/06

50 C 13 Diesel 92 05/99 →

DAILY IV Cassone / Furgonato / Promiscuo

35C10, 35S10 Diesel 70 05/06 →

DAILY IV Pianale piatto/Telaio

35C10, 35S10 Diesel 70 05/06 →

DAILY IV Ribaltabile

35C10 K Diesel 70 05/06 →

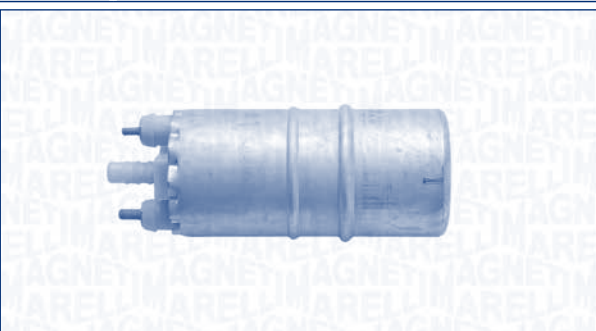
ESS537
**J1
PB**
**POMPA CARBURANTE
FUEL PUMP**

FIAT
PUNTO (188)

 1.9 JTD 80 Diesel 59 09/99 →
(188.237, .257, .337, .357)

LANCIA
KAPPA (838A)

 2.4 JTD Diesel 100 06/98 → 10/01
(838AL1AA)

ESS537



LANCIA

KAPPA SW (838B)

2.4 JTD (838BL1AA)	Diesel	100	06/98 → 10/01
-----------------------	--------	-----	---------------

PB507

J1 POMPA CARBURANTE
PB FUEL PUMP



CITROËN

ZX (N2)

2.0 i 16V	Petrol	110	06/94 → 06/97
-----------	--------	-----	---------------

PEUGEOT

306 2 volumi /Coda spiovente (7A, 7C, N3, N5)

1.4	Petrol	55	05/93 → 04/97
-----	--------	----	---------------

PI024

J1 POMPA CARBURANTE
PB FUEL PUMP

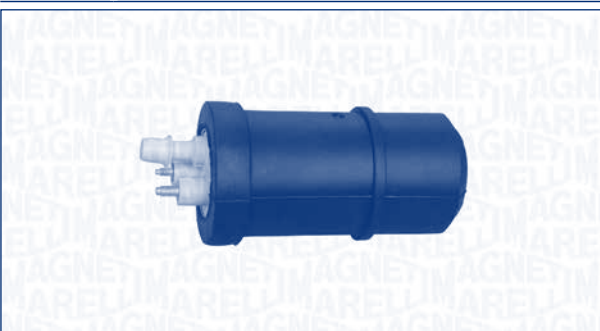

ALFA ROMEO

33 (905)

1.7 i.e. (905.A3D)	Petrol	77	09/88 → 12/89
--------------------	--------	----	---------------

33 (907A)

1.4 i.e. (907.A3A, 907.A3B)	Petrol	65	06/91 → 09/94
--------------------------------	--------	----	---------------

PI024



ALFA ROMEO

33 (907A)

1.4 i.e. (907.A3A, 907.A3B)	Petrol	66	06/91 → 09/94
--------------------------------	--------	----	---------------

1.5 i.e.	Petrol	71	01/90 → 09/94
----------	--------	----	---------------

33 (907A)

1.7 16V (907.A1B)	Petrol	101	01/90 → 03/92
-------------------	--------	-----	---------------

1.5 i.e. (907A2A)	Petrol	74	07/90 → 08/91
-------------------	--------	----	---------------

1.7 16V (907.A1C)	Petrol	95	01/90 → 09/94
-------------------	--------	----	---------------

1.7 16V (907.A1C)	Petrol	97	01/90 → 03/92
-------------------	--------	----	---------------

1.7 16V 4x4 (907.A1G)	Petrol	97	01/90 → 09/94
--------------------------	--------	----	---------------

1.7 i.e. (907.A1A)	Petrol	77	04/92 → 09/94
--------------------	--------	----	---------------

1.7 i.e. (907.A1A)	Petrol	79	01/90 → 09/94
--------------------	--------	----	---------------

1.7 i.e. 4x4	Petrol	79	01/90 → 03/92
--------------	--------	----	---------------

33 Sportwagon (905A)

1.7 i.e.	Petrol	77	09/88 → 12/89
----------	--------	----	---------------

33 Sportwagon (907B)

1.4 i.e.	Petrol	65	06/91 → 09/94
----------	--------	----	---------------

1.4 i.e.	Petrol	66	06/91 → 09/94
----------	--------	----	---------------

1.4 i.e. 4x4	Petrol	66	06/91 → 09/94
--------------	--------	----	---------------

1.5 i.e.	Petrol	71	01/90 → 09/94
----------	--------	----	---------------

1.7 16V	Petrol	101	01/90 → 03/92
---------	--------	-----	---------------

1.7 16V (907.B1G)	Petrol	95	01/90 → 09/94
-------------------	--------	----	---------------

1.7 16V (907.B1G)	Petrol	97	01/90 → 09/94
-------------------	--------	----	---------------

1.7 16V 4x4 (907.B1H)	Petrol	95	01/90 → 09/94
--------------------------	--------	----	---------------

1.7 16V 4x4 (907.B1H)	Petrol	97	01/90 → 03/92
--------------------------	--------	----	---------------

1.7 i.e. (907.B1A)	Petrol	77	04/92 → 09/94
--------------------	--------	----	---------------

1.7 i.e. (907.B1A)	Petrol	79	01/90 → 03/92
--------------------	--------	----	---------------

1.7 i.e. 4x4 (907.B1E)	Petrol	79	01/90 → 03/92
---------------------------	--------	----	---------------

75 (162B)

1.6 (162.B2B, 162.B2C) Cat.	Petrol	81	05/89 → 02/92
--------------------------------	--------	----	---------------

1.8 (162.B1H)	Petrol	90	08/89 → 02/92
---------------	--------	----	---------------

1.8 (162.B1L, 162.B1F)	Petrol	88	09/88 → 02/92
---------------------------	--------	----	---------------

2.0 T.S (162.B4A) Cat.	Petrol	109	05/85 → 02/92
---------------------------	--------	-----	---------------

2.0 T.S. (162.4CB, 162.B4, 162.B4A)	Petrol	107	01/87 → 02/92
--	--------	-----	---------------

2.5 V6 (162.B3)	Petrol	115	05/85 → 08/86
-----------------	--------	-----	---------------

2.5 V6 Cat.	Petrol	113	09/86 → 04/89
-------------	--------	-----	---------------

3.0 V6 (162.B6A)	Petrol	136	01/87 → 12/90
------------------	--------	-----	---------------

PI024

ALFA ROMEO
75 (162B)

3.0 V6 (162.B6A) Cat.	Petrol	136	01/87 → 02/92
--------------------------	--------	-----	---------------

3.0 V6 (162.B6C)	Petrol	141	02/90 → 02/92
------------------	--------	-----	---------------

GIULIETTA (116)

2.0 Turbo	Petrol	125	07/83 → 06/84
-----------	--------	-----	---------------

GTV (116)

2.0 Turbodelta	Petrol	111	01/78 → 12/80
----------------	--------	-----	---------------

SPIDER (102)

2000	Petrol	85	08/83 → 12/61
------	--------	----	---------------

SPIDER (115)

2000	Petrol	85	08/86 → 12/90
------	--------	----	---------------

2000 Veloce	Petrol	93	01/77 → 12/93
-------------	--------	----	---------------

BMW
2500-3.3 (E3)

3.0 si	Petrol	143	10/75 → 04/77
--------	--------	-----	---------------

3.2 Li	Petrol	147	10/75 → 04/77
--------	--------	-----	---------------

3 (E30)

318 i	Petrol	83	09/87 → 06/91
-------	--------	----	---------------

318 i	Petrol	85	09/87 → 06/91
-------	--------	----	---------------

320 i	Petrol	92	09/82 → 12/85
-------	--------	----	---------------

320 i	Petrol	95	12/85 → 06/91
-------	--------	----	---------------

323 i	Petrol	102	09/82 → 08/83
-------	--------	-----	---------------

323 i	Petrol	110	09/83 → 08/86
-------	--------	-----	---------------

325 e 2.7	Petrol	90	10/83 → 12/88
-----------	--------	----	---------------

325 e 2.7	Petrol	95	01/85 → 08/87
-----------	--------	----	---------------

325 i	Petrol	125	12/86 → 06/91
-------	--------	-----	---------------

325 i	Petrol	126	09/83 → 11/89
-------	--------	-----	---------------

325 i X	Petrol	125	12/86 → 08/91
---------	--------	-----	---------------

325 i X	Petrol	126	03/86 → 12/87
---------	--------	-----	---------------

M3 2.3	Petrol	147	02/87 → 05/89
--------	--------	-----	---------------

M3 2.3	Petrol	143	07/86 → 06/91
--------	--------	-----	---------------

M3 2.3	Petrol	158	06/89 → 06/91
--------	--------	-----	---------------

3 Cabriolet (E30)

320 i	Petrol	95	04/86 → 10/93
-------	--------	----	---------------

325 i	Petrol	125	09/87 → 10/93
-------	--------	-----	---------------

325 i	Petrol	126	12/85 → 12/87
-------	--------	-----	---------------

M3 2.3	Petrol	143	06/88 → 06/91
--------	--------	-----	---------------

3 Touring (E30)

318 i	Petrol	85	09/87 → 06/91
-------	--------	----	---------------

325 i	Petrol	125	07/87 → 03/93
-------	--------	-----	---------------

325 i X	Petrol	125	06/88 → 10/93
---------	--------	-----	---------------

5 (E12)

528 i	Petrol	130	04/77 → 05/81
-------	--------	-----	---------------

528 i	Petrol	135	04/77 → 05/81
-------	--------	-----	---------------

PI024

BMW
5 (E28)

518 i	Petrol	77	09/83 → 12/87
-------	--------	----	---------------

520 i	Petrol	92	06/81 → 12/87
-------	--------	----	---------------

525 e	Petrol	92	05/83 → 12/87
-------	--------	----	---------------

525 e	Petrol	95	12/84 → 12/87
-------	--------	----	---------------

525 i	Petrol	110	06/81 → 12/87
-------	--------	-----	---------------

528 i	Petrol	135	06/81 → 12/87
-------	--------	-----	---------------

535 i, M 535 i	Petrol	136	01/85 → 12/87
----------------	--------	-----	---------------

535 i, M 535 i	Petrol	141	01/85 → 12/87
----------------	--------	-----	---------------

535 i, M 535 i	Petrol	160	01/85 → 12/87
----------------	--------	-----	---------------

6 (E24)

628 CSi	Petrol	135	09/79 → 08/87
---------	--------	-----	---------------

633 CSi	Petrol	145	09/78 → 08/84
---------	--------	-----	---------------

633 CSi	Petrol	147	04/76 → 09/78
---------	--------	-----	---------------

635 CSi	Petrol	136	01/85 → 05/89
---------	--------	-----	---------------

635 CSi	Petrol	155	08/87 → 05/89
---------	--------	-----	---------------

635 CSi	Petrol	160	11/81 → 10/89
---------	--------	-----	---------------

M 635 CSi	Petrol	211	03/84 → 05/89
-----------	--------	-----	---------------

7 (E23)

728 i	Petrol	135	07/78 → 08/86
-------	--------	-----	---------------

733 i	Petrol	145	05/77 → 08/86
-------	--------	-----	---------------

735 i	Petrol	160	09/79 → 08/86
-------	--------	-----	---------------

Z1

2.5	Petrol	125	06/88 → 06/91
-----	--------	-----	---------------

CITROËN
BX (XB-_)

16	Petrol	76	03/86 → 02/93
----	--------	----	---------------

16	Petrol	55	09/88 → 02/93
----	--------	----	---------------

19 GTi	Petrol	90	07/86 → 02/93
--------	--------	----	---------------

19 GTi 16V	Petrol	108	03/88 → 02/93
------------	--------	-----	---------------

BX Break (XB-_)

16	Petrol	76	03/86 → 12/94
----	--------	----	---------------

16	Petrol	55	09/88 → 12/94
----	--------	----	---------------

19 Cat.	Petrol	75	07/86 → 12/94
---------	--------	----	---------------

CX I (MA)

2400 GTi	Petrol	94	06/77 → 06/82
----------	--------	----	---------------

2400 GTi	Petrol	96	06/77 → 06/82
----------	--------	----	---------------

25 GTi Turbo 2	Petrol	122	06/84 → 08/85
----------------	--------	-----	---------------

25 TRi	Petrol	100	07/83 → 08/85
--------	--------	-----	---------------

CX I Break (MA)

2400	Petrol	85	08/76 → 06/80
------	--------	----	---------------

2400 GTi	Petrol	94	07/82 → 06/83
----------	--------	----	---------------

25 TRi	Petrol	100	07/83 → 08/85
--------	--------	-----	---------------

PI024



KW



CITROËN

CX II

25 GTi	Petrol	89	05/86 → 12/92
25 GTi Turbo 2	Petrol	122	08/85 → 12/92
25 TRi	Petrol	100	08/85 → 12/92

CX II Break

25 i	Petrol	89	05/86 → 12/92
25 TRi	Petrol	100	08/85 → 12/92

VISA

16 GTI	Petrol	83	06/86 → 03/91
16 GTI	Petrol	76	01/85 → 06/86

XM Break (Y4)

2.0 i 16V	Petrol	97	05/94 → 10/00
-----------	--------	----	---------------

FIAT

REGATA (138)

75 i.e. 1.5	Petrol	55	07/85 → 07/89
-------------	--------	----	---------------

RITMO II (138A)

125TC Abarth 2.0	Petrol	92	12/82 → 12/87
130TC Abarth 2.0	Petrol	96	04/83 → 12/87
75 1.5 Cat.	Petrol	55	09/85 → 12/88

JAGUAR

XJ Coupé

5.3 H.E.	Petrol	194	01/86 → 12/89
----------	--------	-----	---------------

XJSC Convertible

5.3 H.E.	Petrol	194	07/85 → 05/92
----------	--------	-----	---------------

OPEL

CALIBRA A (85_)

2.0 i	Petrol	85	06/90 → 07/97
2.0 i 16V	Petrol	100	02/94 → 07/97
2.0 i 16V	Petrol	110	06/90 → 02/94
2.0 i 16V 4x4	Petrol	100	02/94 → 07/97
2.0 i 16V 4x4	Petrol	110	06/90 → 02/94
2.0 i 4x4	Petrol	85	06/90 → 07/97
2.0 i Turbo 4x4	Petrol	150	03/92 → 07/97
2.5 i V6	Petrol	125	04/93 → 07/97

CORSA A 2 volumi /Coda spiovente (93_, 94_, 98_, 99_)

1.4 Si	Petrol	60	09/91 → 03/93
1.6 GSi	Petrol	74	05/88 → 03/92

KADETT E 2 volumi /Coda spiovente (33_, 34_, 43_, 44_)

2.0 GSi 16V	Petrol	115	12/87 → 08/91
-------------	--------	-----	---------------

KADETT E Furgonato (37_, 47_)

1.6 i	Petrol	55	08/89 → 09/93
-------	--------	----	---------------

PI024



KW



OPEL

OMEGA A (16_, 17_, 19_)

1.8	Petrol	85	09/86 → 03/94
2.0	Petrol	90	09/86 → 03/94
2.0	Petrol	73	09/90 → 03/94
2.0	Petrol	74	09/90 → 03/94
2.0 i	Petrol	85	09/86 → 03/94
2.4 i	Petrol	92	09/88 → 03/94
2.6 i	Petrol	110	09/90 → 03/94
3.0 (3000)	Petrol	115	03/87 → 12/87
3.0 (3000)	Petrol	130	03/87 → 09/90
3.0 24V (3000)	Petrol	147	09/89 → 03/94
3.0 24V (3000)	Petrol	150	09/89 → 03/94
3.0 24V Evolution500	Petrol	169	03/91 → 07/92

OMEGA A Station wagon (66_, 67_)

1.8	Petrol	85	09/86 → 03/94
2.0	Petrol	90	09/86 → 03/94
2.0	Petrol	74	09/90 → 03/94
2.0 i	Petrol	85	09/86 → 03/94
2.0 i	Petrol	73	09/90 → 03/94
2.4 i	Petrol	92	09/88 → 03/94
2.6 i	Petrol	110	09/90 → 03/94
3.0	Petrol	130	03/87 → 09/90
3.0	Petrol	115	03/87 → 03/94
3.0 24V	Petrol	147	09/89 → 03/94
3.0 Cat.	Petrol	130	03/87 → 03/94

SENATOR B (29_)

2.5 i	Petrol	103	09/90 → 09/93
3.0	Petrol	115	09/87 → 09/93
3.0	Petrol	130	01/88 → 09/90

VECTRA A (86_, 87_)

2.0	Petrol	74	09/88 → 09/89
2.0 i	Petrol	85	09/88 → 10/90
2.0 i	Petrol	95	09/88 → 09/92
2.0 i 4x4	Petrol	95	01/89 → 09/92
2.0 i 4x4	Petrol	85	01/89 → 10/90
2.0 i Turbo 4x4	Petrol	150	06/94 → 11/95
2000 16V 4x4	Petrol	110	01/89 → 10/90
2000/GT 16V	Petrol	110	01/89 → 06/94

VECTRA A 2 volumi /Coda spiovente (88_, 89_)

2.0	Petrol	74	04/88 → 09/89
2.0 i	Petrol	85	09/88 → 10/90
2.0 i 16V	Petrol	110	02/89 → 10/90
2.0 i GT	Petrol	95	09/88 → 11/95

PI024

PEUGEOT
309 I (10C, 10A)

1.9 GTI	Petrol	88	07/88 → 07/89
1.9 GTI	Petrol	94	10/86 → 07/89

PORSCHE
914

2.0	Petrol	74	01/72 → 12/75
-----	--------	----	---------------

RENAULT
11 (B/C37_)

1.4 (B/C372, B/C37C)	Petrol	44	03/83 → 12/88
1.4 (B/C373)	Petrol	50	03/83 → 12/85
1.4 (B/C373)	Petrol	53	05/83 → 12/85
1.4 (B/C373, B/C37R)	Petrol	49	03/83 → 12/88
1.4 Turbo (B/C375)	Petrol	77	04/84 → 12/86
1.4 Turbo (B/C375)	Petrol	85	10/86 → 12/88
1.7 (B/C376)	Petrol	59	10/83 → 12/87
1.7 (B/C37D)	Petrol	64	06/87 → 12/88
1.7 (B/C37L)	Petrol	54	10/86 → 12/88
1.7 (B/C37N)	Petrol	65	10/86 → 12/88

18 (134_)

1.6 Turbo (1345)	Petrol	80	10/80 → 09/82
1.6 Turbo (1345)	Petrol	92	10/82 → 07/86
1.6 Turbo Inj.	Petrol	82	09/82 → 07/86

18 Variable (135_)

2.0	Petrol	121	04/11 → 07/86
-----	--------	-----	---------------

19 I (B/C53_)

1.7	Petrol	79	06/89 → 04/92
1.7 (B/C53B)	Petrol	54	09/88 → 04/92
1.7 (B/C53C)	Petrol	66	09/88 → 04/92
1.8 16V (B/C53D)	Petrol	99	06/89 → 04/92

19 I Chamade (L53_)

1.7 (L53C)	Petrol	66	07/88 → 04/92
1.7 (L53F)	Petrol	79	08/88 → 12/92
1.8 16V (L53D)	Petrol	99	10/89 → 04/92

19 II (B/C53_)

1.4	Petrol	59	01/92 → 12/95
1.4 (B/C532)	Petrol	43	04/92 → 12/95
1.4 (B/C535)	Petrol	55	01/92 → 12/95
1.7 (B/C53B)	Petrol	54	04/92 → 12/95
1.7 (B/C53C)	Petrol	66	04/92 → 12/95

PI024

RENAULT
19 II (B/C53_)

1.8 (5/353F, B/C538)	Petrol	79	05/94 → 12/95
1.8 (B/C538)	Petrol	81	04/92 → 05/94
1.8 (B/C53Y)	Petrol	65	04/92 → 12/95
1.8 16V (B/C53D)	Petrol	99	04/92 → 12/95

19 II Chamade (L53_)

1.4	Petrol	59	10/94 → 11/95
1.4 (532)	Petrol	43	04/92 → 12/95
1.7 (L53B)	Petrol	54	04/92 → 12/95
1.7 (L53C)	Petrol	66	04/92 → 12/95
1.8 (453A/F)	Petrol	66	04/92 → 12/95
1.8 (L538)	Petrol	81	04/92 → 05/94
1.8 (L53V, L538)	Petrol	79	05/94 → 12/95
1.8 (L53Y)	Petrol	65	04/92 → 12/95
1.8 16V (L53D)	Petrol	99	04/92 → 12/95

21 (B48_)

1.7 (B48E)	Petrol	66	09/89 → 06/94
1.7 (B48F)	Petrol	54	09/89 → 10/92
2.0 (B48R/Y)	Petrol	99	02/90 → 10/92
2.2 (B48K)	Petrol	79	09/89 → 06/94

25 (B29_)

2.0 12V	Petrol	103	06/88 → 12/93
2.0 12V (B294)	Petrol	99	06/89 → 12/92
2.2 (B29B)	Petrol	79	09/86 → 12/92

9 (L42_)

1.4 Turbo	Petrol	85	12/86 → 12/89
1.7 (L426)	Petrol	59	09/84 → 12/88

9 (L42_)

1.7 (L42L)	Petrol	55	10/86 → 12/88
------------	--------	----	---------------

ESPACE I (J11_)

2.2 (J117)	Petrol	79	07/86 → 12/90
------------	--------	----	---------------

FUEGO (136_)

1.6 Turbo (1365)	Petrol	97	08/83 → 10/85
------------------	--------	----	---------------

RAPID Furgonato (F40_, G40_)

1.4 (F407) Cat.	Petrol	43	08/88 → 03/98
1.4 (F40M)	Petrol	44	03/86 → 08/91
1.4 (F40U, F40V)	Petrol	55	09/91 → 03/98

SUPER 5 (B/C40_)

1.4 (B/C40J)	Petrol	49	06/87 → 07/89
1.4 (B/C40M)	Petrol	44	06/87 → 08/90

TRAFIC Furgonato (TXX)

2.2 4x4	Petrol	70	05/89 → 06/94
---------	--------	----	---------------

PI024



ROVER

2000-3500 2 volumi /Coda spiovente (SD1)

3500 Vitesse	Petrol	142	10/82 → 10/86
--------------	--------	-----	---------------

SEAT

IBIZA I (021A)

1.2	Petrol	47	11/84 → 12/93
-----	--------	----	---------------

1.2	Petrol	44	11/84 → 12/93
-----	--------	----	---------------

1.2 i	Petrol	52	01/89 → 05/93
-------	--------	----	---------------

1.5 i	Petrol	65	10/86 → 05/93
-------	--------	----	---------------

1.5 i Cat.	Petrol	66	10/86 → 05/93
------------	--------	----	---------------

1.7	Petrol	72	01/91 → 05/93
-----	--------	----	---------------

1.7	Petrol	76	01/91 → 05/93
-----	--------	----	---------------

MALAGA (023A)

1.5 i	Petrol	74	01/87 → 12/93
-------	--------	----	---------------

1.5 i Cat.	Petrol	66	10/86 → 12/93
------------	--------	----	---------------

VAUXHALL

ASTRA Mk II 2 volumi /Coda spiovente

1.8 GTE	Petrol	82	09/84 → 08/91
---------	--------	----	---------------

CARLTON Mk II

1.8 S	Petrol	65	12/82 → 08/86
-------	--------	----	---------------

CAVALIER Mk II

2.0 i	Petrol	85	09/86 → 08/88
-------	--------	----	---------------

ROYALE

3.0	Petrol	132	10/79 → 10/82
-----	--------	-----	---------------

VOLKSWAGEN

TRANSPORTER III Autobus

1.9	Petrol	44	08/82 → 07/92
-----	--------	----	---------------

2.1	Petrol	70	08/85 → 07/92
-----	--------	----	---------------

2.1 Cat.	Petrol	70	06/89 → 07/92
----------	--------	----	---------------

2.1 i	Petrol	68	07/89 → 07/92
-------	--------	----	---------------

TRANSPORTER III Furgonato

1.9	Petrol	44	10/82 → 07/92
-----	--------	----	---------------

2.1	Petrol	70	02/86 → 07/92
-----	--------	----	---------------

2.1 i	Petrol	68	07/89 → 07/92
-------	--------	----	---------------

TRANSPORTER III Pianale piatto/Telaio

1.9	Petrol	44	09/82 → 07/92
-----	--------	----	---------------

2.1 i	Petrol	68	07/89 → 07/92
-------	--------	----	---------------

PI025

**J1
PB POMPA CARBURANTE
FUEL PUMP**

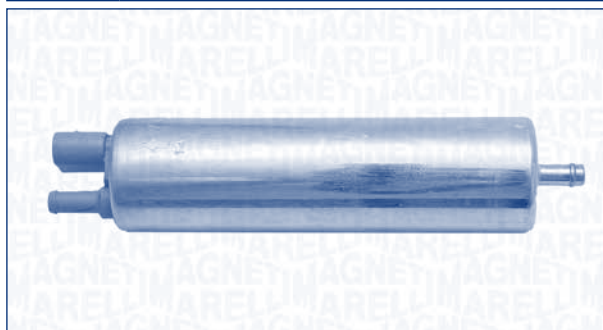

BMW

3 (E46)

318 d	Diesel	85	09/01 → 03/03
-------	--------	----	---------------

320 d	Diesel	100	04/98 → 09/01
-------	--------	-----	---------------

320 d	Diesel	110	09/01 → 02/05
-------	--------	-----	---------------

330 d	Diesel	135	10/99 → 02/05
-------	--------	-----	---------------

330 xd	Diesel	135	06/00 → 02/05
--------	--------	-----	---------------

3 (E90)

318 d	Diesel	90	09/05 → 12/11
-------	--------	----	---------------

3 Compact (E46)

320 td	Diesel	110	09/01 → 02/05
--------	--------	-----	---------------

3 Touring (E46)

320 d	Diesel	110	09/01 → 02/05
-------	--------	-----	---------------

330 d	Diesel	135	10/99 → 02/05
-------	--------	-----	---------------

330 xd	Diesel	135	06/00 → 02/05
--------	--------	-----	---------------

5 (E39)

530 d	Diesel	142	09/00 → 06/03
-------	--------	-----	---------------

530 d	Diesel	135	08/98 → 09/00
-------	--------	-----	---------------

5 Touring (E39)

530 d	Diesel	142	09/00 → 05/04
-------	--------	-----	---------------

530 d	Diesel	135	08/98 → 09/00
-------	--------	-----	---------------

7 (E38)

730 d	Diesel	135	08/98 → 04/00
-------	--------	-----	---------------

730 d	Diesel	142	04/00 → 11/01
-------	--------	-----	---------------

X5 (E53)

3.0 d	Diesel	135	05/01 →
-------	--------	-----	---------

3.0 d	Diesel	160	12/03 →
-------	--------	-----	---------

LAND ROVER

FREELANDER (LN)

2.0 Td4 4x4	Diesel	80	03/01 → 10/06
-------------	--------	----	---------------

RANGE ROVER III (LM)

3.0 TD 6 4x4	Diesel	130	03/02 → 08/12
--------------	--------	-----	---------------

OPEL

OMEGA B (25_, 26_, 27_)

2.5 DTi	Diesel	110	09/01 → 07/03
---------	--------	-----	---------------

PI025

OPEL
OMEGA B Station wagon (21_, 22_, 23_)

2.5 DTi	Diesel	110	09/01 → 07/03
---------	--------	-----	---------------

ROVER
75 (RJ)

2.0 CDT	Diesel	85	02/99 → 05/05
---------	--------	----	---------------

75 Tourer (RJ)

2.0 CDT	Diesel	85	08/01 → 05/05
---------	--------	----	---------------

PI026
**J1
PB**
**POMPA CARBURANTE
FUEL PUMP**

MERCEDES-BENZ
CLASSE C (W202)

C 180 (202.018)	Petrol	90	03/93 → 05/00
-----------------	--------	----	---------------

C 180 (202.018)	Petrol	89	11/94 → 05/00
-----------------	--------	----	---------------

C 200 (202.020)	Petrol	100	01/94 → 05/00
-----------------	--------	-----	---------------

C 200 Kompressor (202.025)	Petrol	132	10/95 → 05/00
----------------------------------	--------	-----	---------------

C 220 (202.022)	Petrol	110	03/93 → 05/00
-----------------	--------	-----	---------------

C 230 Kompressor (202.024)	Petrol	142	10/95 → 05/00
----------------------------------	--------	-----	---------------

C 280 (202.028)	Petrol	142	05/93 → 05/00
-----------------	--------	-----	---------------

CLASSE C Station wagon (S202)

C 180 T (202.078)	Petrol	90	06/96 → 09/00
----------------------	--------	----	---------------

C 200 T (202.080)	Petrol	100	06/96 → 03/01
----------------------	--------	-----	---------------

C 200 T Kompressor (202.082)	Petrol	141	11/96 → 03/01
------------------------------------	--------	-----	---------------

PI026

MERCEDES-BENZ
CLASSE C Station wagon (S202)

C 230 T Kompressor (202.085)	Petrol	142	06/97 → 09/00
------------------------------------	--------	-----	---------------

CLK (C208)

200 (208.335)	Petrol	100	06/97 → 06/02
---------------	--------	-----	---------------

CLK Cabriolet (A208)

200 (208.435)	Petrol	100	03/98 → 03/02
---------------	--------	-----	---------------

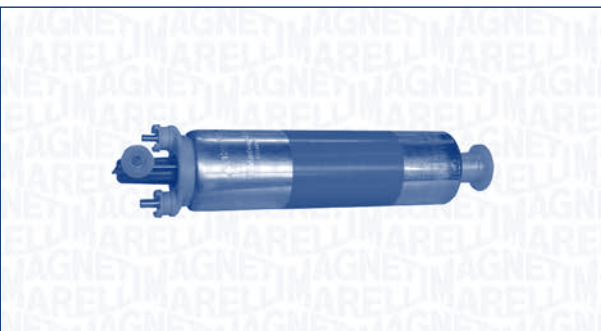
PI027
**J1
PB**
**POMPA CARBURANTE
FUEL PUMP**

MERCEDES-BENZ
CLASSE E (W124)

E 280 (124.028)	Petrol	145	09/94 → 06/95
-----------------	--------	-----	---------------

E 280 (124.029)	Petrol	142	09/94 → 06/95
-----------------	--------	-----	---------------

E 300 4-matic (124.230)	Petrol	132	09/94 → 06/95
----------------------------	--------	-----	---------------

E 320 (124.032)	Petrol	162	09/94 → 06/95
-----------------	--------	-----	---------------

E 420 (124.034)	Petrol	205	09/94 → 06/95
-----------------	--------	-----	---------------

E 500 (124.036)	Petrol	235	09/94 → 06/95
-----------------	--------	-----	---------------

CLASSE E (W210)

E 240 (210.061)	Petrol	125	06/97 → 08/00
-----------------	--------	-----	---------------

E 280 (210.053)	Petrol	142	01/96 → 06/97
-----------------	--------	-----	---------------

E 420 (210.072)	Petrol	205	01/96 → 06/97
-----------------	--------	-----	---------------

E 430 (210.070)	Petrol	205	06/97 → 03/02
-----------------	--------	-----	---------------

E 430 4-matic (210.083)	Petrol	205	05/99 → 03/02
----------------------------	--------	-----	---------------

E 55 AMG (210.074)	Petrol	260	08/97 → 03/02
-----------------------	--------	-----	---------------

E 55 AMG 4-matic (210.074)	Petrol	260	03/01 → 03/02
-------------------------------	--------	-----	---------------

PI027



KW



MERCEDES-BENZ

CLASSE E Cabriolet (A124)

E 320 (124.066) Petrol 162 09/94 → 03/98

E 36 AMG (124.066) Petrol 200 09/94 → 03/98

CLASSE E Coupé (C124)

E 320 (124.052) Petrol 162 09/94 → 06/97

E 36 AMG (124.052) Petrol 200 09/94 → 06/97

CLASSE E Station wagon (S124)

E 280 T (124.088) Petrol 142 09/94 → 06/96

E 280 T (124.088) Petrol 145 09/94 → 06/96

E 300 T 4-matic (124.290) Petrol 132 09/94 → 06/96

E 300 TE-24 AMG (124.091) Petrol 162 09/94 → 06/96

E 320 T (124.092) Petrol 162 09/94 → 06/96

E 36 T AMG (124.092) Petrol 200 09/94 → 06/96

CLASSE E Station wagon (S210)

E 240 T (210.261) Petrol 125 06/97 → 03/03

E 240 T (210.262) Petrol 125 08/00 → 03/03

E 280 T (210.263) Petrol 150 12/96 → 03/03

E 420 T (210.272) Petrol 205 06/96 → 06/97

E 430 T (210.270) Petrol 205 06/97 → 03/03

E 430 T 4-matic (210.283) Petrol 205 05/99 → 03/03

E 55 T AMG (210.274) Petrol 260 08/97 → 03/03

E 55 T AMG 4-matic (210.283) Petrol 260 03/01 → 03/03

CLASSE G (W461)

230 GE (461) Petrol 92 09/94 →

CLASSE G (W463)

300 GE (463.227, 463.228) Petrol 125 06/90 →

300 GE (463.227, 463.228) Petrol 128 06/90 →

G 320 (463.230, 463.231) Petrol 155 09/94 → 12/97

G 320 (463.232, 463.233, 463.244, 463.245) Petrol 158 07/97 →

PI027



KW



MERCEDES-BENZ

CLASSE G (W463)

G 500 (463.247, 463.248, 463.249, 463.240, 463.421) Petrol 218 04/98 →

CLASSE S (W140)

300 SE 2.8 (140.028) Petrol 145 11/94 → 10/98

300 SE,SEL/S320 (140.032, 140.033) Petrol 170 11/94 → 10/98

400 SE,SEL/S420 (140.042, 140.043) Petrol 210 11/94 → 10/98

500 SE,SEL (140.050, 140.051) Petrol 240 11/94 → 10/98

S 280 (140.028) Petrol 142 11/94 → 10/98

S 420 (140.042) Petrol 205 11/94 → 10/98

S 500 (140.050, 140.051) Petrol 235 11/94 → 10/98

S 600 (140.056, 140.057) Petrol 290 11/94 → 10/98

CLASSE S (W220)

S 280 (220.063, 220.163) Petrol 150 10/98 → 08/05

S 320 (220.065, 220.165) Petrol 165 10/98 → 08/05

S 430 (220.070, 220.170) Petrol 205 10/98 → 08/05

S 500 (220.075, 220.175, 220.875) Petrol 225 10/98 → 08/05

CLASSE S Coupé (C140)

SEC/CL 420 (140.063) Petrol 205 11/94 → 02/99

SEC/CL 500 (140.070) Petrol 235 11/94 → 02/99

SEC/CL 600 (140.076) Petrol 290 11/94 → 02/99

SL (R129)

280 (129.058) Petrol 142 09/94 → 10/01

280 (129.059) Petrol 150 05/98 → 10/01

320 (129.063) Petrol 170 09/94 → 10/01

320 (129.064) Petrol 165 05/98 → 10/01

500 (129.067) Petrol 235 09/94 → 12/94

PI027

MERCEDES-BENZ
SL (R129)

500 (129.068)	Petrol	225	05/98 → 10/01
60AMG (129.067)	Petrol	280	05/97 → 10/01
600 (129.076)	Petrol	290	07/92 → 10/01

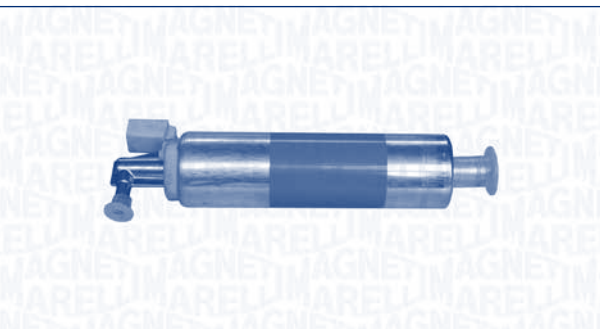
PI028
**J1
PB +
POMPA CARBURANTE
FUEL PUMP**

MERCEDES-BENZ
CLASSE S (W220)

S 350 (220.067, 220.167)	Petrol	180	09/02 → 08/05
S 350 4-matic (220.087, 220.187)	Petrol	180	06/03 → 08/05
S 430 4-matic (220.083, 220.183)	Petrol	205	09/02 → 08/05
S 500 4-matic (220.084, 220.184)	Petrol	225	09/02 → 08/05

SL (R230)

500 (230.475)	Petrol	225	10/01 → 01/12
---------------	--------	-----	---------------

ESS0045A
**J1
PB +
CESTELLO
POMPA CARBURANTE (CON VASO
ANTIROLLIO)
FUEL PUMP**

AUDI
A3 (8P1)

1.6 FSI	Petrol	85	08/03 → 09/07
---------	--------	----	---------------

FORD
GALAXY (WGR)

2.0 i	Petrol	85	11/95 → 05/06
2.3 16V	Petrol	103	09/01 → 05/06
2.8 i V6	Petrol	128	11/95 → 04/00
2.8 i V6 4x4	Petrol	128	04/96 → 04/00
2.8 V6	Petrol	150	04/00 → 05/06

SEAT
AROSA (6H)

1.4 TDI	Diesel	55	01/00 → 06/04
---------	--------	----	---------------

SKODA
OCTAVIA (1Z3)

1.6 FSI	Petrol	85	02/04 → 10/08
2.0 TDI 16V	Diesel	103	02/04 →

VOLKSWAGEN
BORA (1J2)

1.4 16V	Petrol	55	03/00 → 05/05
---------	--------	----	---------------

GOLF IV (1J1)

1.4 16V	Petrol	55	08/97 → 06/05
1.6	Petrol	74	08/97 → 05/04
1.8	Petrol	92	08/97 → 06/05
1.8 T	Petrol	110	08/97 → 06/05
2.0	Petrol	85	07/98 → 05/04
2.3 V5	Petrol	110	08/97 → 10/00

LUPO (6X1, 6E1)

1.0	Petrol	37	09/98 → 07/05
1.4 16V	Petrol	55	09/98 → 07/05
1.4 16V	Petrol	74	08/99 → 07/05

NEW BEETLE (9C1, 1C1)

1.6	Petrol	75	06/00 → 09/10
2.3 V5	Petrol	125	10/00 → 09/10

ESS0014A

J1
POMPA CARBURANTE KIT
PB/KIT FUEL PUMP KIT



CITROËN

XM (Y3)

2.0 i	Petrol	89	05/89 → 06/94
2.0 i Turbo	Petrol	104	09/92 → 06/94
3.0 V6	Petrol	123	05/89 → 06/94
3.0 V6 24V	Petrol	147	07/90 → 06/94

XM Break (Y3)

2.0 i	Petrol	89	11/91 → 04/94
2.0 Turbo	Petrol	104	09/92 → 04/94
3.0 V6	Petrol	123	11/91 → 04/94

ZX (N2)

1.4 i	Petrol	55	03/91 → 06/97
1.6 i	Petrol	65	03/91 → 06/97
1.8 i	Petrol	74	07/92 → 06/97
1.8 i 16V	Petrol	81	01/96 → 06/97
1.9 i	Petrol	88	03/91 → 06/97
2.0 i	Petrol	89	07/92 → 06/97
2.0 i 16V	Petrol	112	07/92 → 10/94

ZX Break (N2)

1.4 i	Petrol	55	10/93 → 10/97
1.6 i	Petrol	65	10/93 → 10/97
1.8 i	Petrol	74	10/93 → 10/97
1.8 i 16V	Petrol	81	01/96 → 02/98

FORD

ESCORT VII (GAL, AAL, ABL)

1.4	Petrol	55	01/95 → 10/98
1.6 16V	Petrol	66	01/95 → 10/98
1.6 i 16V	Petrol	65	01/95 → 08/95
1.8 16V	Petrol	77	01/95 → 08/95
1.8 16V	Petrol	85	01/95 → 10/98
RS 2000	Petrol	110	02/95 → 02/98

ESCORT VII Cabriolet (ALL)

1.4	Petrol	55	02/95 → 08/98
1.6 16V XR3i	Petrol	65	02/95 → 12/96
1.6 16V XR3i	Petrol	66	02/95 → 09/99

ESS0014A



FORD

ESCORT VII Cabriolet (ALL)

1.8 16V XR3i	Petrol	77	02/95 → 08/98
1.8 16V XR3i	Petrol	85	10/95 → 08/98
1.8 16V XR3i	Petrol	96	02/95 → 08/00

ESCORT VII Station wagon (GAL, ANL)

1.4	Petrol	55	01/95 → 02/99
1.6 16V	Petrol	66	01/95 → 02/99
1.6 i 16V	Petrol	65	01/95 → 08/95
1.8 16V	Petrol	77	01/95 → 08/95
1.8 16V	Petrol	85	01/95 → 02/99

ESCORT VII Tre volumi (GAL, AFL)

1.4	Petrol	55	01/95 → 02/99
1.6 i 16V	Petrol	65	01/95 → 08/95
1.6 i 16V	Petrol	66	01/95 → 02/99
1.8 16V	Petrol	77	01/95 → 08/95
1.8 16V	Petrol	85	01/95 → 02/99

ORION III (GAL)

1.6 i 16V	Petrol	66	07/92 → 12/93
1.8 i 16V	Petrol	77	02/92 → 12/93

SCORPIO I (GAE, GGE)

2.4 i	Petrol	92	10/88 → 02/92
2.4 i Cat.	Petrol	92	10/88 → 09/94
2.9 i	Petrol	107	09/86 → 09/94
2.9 i	Petrol	110	09/86 → 09/94
2.9 i 24V	Petrol	143	04/91 → 09/94
2.9 i Cat.	Petrol	107	10/87 → 09/94

SCORPIO I Station wagon (GGE)

2.4 i	Petrol	92	09/91 → 09/94
2.9 24V	Petrol	143	08/93 → 09/94
2.9 i	Petrol	107	09/91 → 09/94

SCORPIO I Tre volumi (GGE)

2.4 i	Petrol	92	10/88 → 10/94
2.9 i 24V	Petrol	143	04/91 → 09/94

SIERRA (GBG, GB4)

2.0 i	Petrol	74	01/87 → 12/89
2.9 i	Petrol	110	08/88 → 02/93

SIERRA 2 volumi /Coda spiovente (GBC, GBG)

2.0 i	Petrol	74	01/87 → 02/93
2.0 i	Petrol	92	06/89 → 02/93

SIERRA Station wagon (BNG)

2.0 i	Petrol	74	01/87 → 02/93
2.0 i	Petrol	85	01/87 → 02/93
2.0 i	Petrol	88	05/89 → 02/93
2.0 i	Petrol	92	05/89 → 02/93
2.0 i Cat.	Petrol	74	01/87 → 02/93

ESS0014A

FORD
SIERRA Station wagon (BNG)

2.9 i Petrol 110 08/88 → 02/93

TRANSIT Autobus (E_ _)

2.0 i (EBL, EDL, EGL, ESS, EUS) Petrol 72 09/91 → 07/94

2.9 i Petrol 107 01/91 → 09/94

TRANSIT Pianale piatto/Telaio (E_ _)

2.0 (EME/L/S, ENE/L/S) Petrol 72 09/91 → 08/94

JEEP
CHEROKEE (XJ)

2.5 i 4x4 Petrol 90 12/91 → 09/01

4.0 i Petrol 135 12/91 → 09/01

4.0 i Petrol 136 01/88 → 09/01

WRANGLER I (YJ, SJ_)

2.5 Petrol 89 12/91 → 08/96

4.0 Petrol 131 12/91 → 08/96

PEUGEOT
306 (7B, N3, N5)

1.4 SL Petrol 55 06/94 → 05/01

1.6 SR Petrol 65 06/94 → 10/00

1.8 ST Petrol 74 06/94 → 05/01

2.0 S16 Petrol 110 06/94 → 05/01

2.0 S16 Petrol 112 06/94 → 05/01

2.0 ST Petrol 89 07/94 → 05/01

306 2 volumi /Coda spiovente (7A, 7C, N3, N5)

1.4 Petrol 55 05/93 → 05/01

1.6 Petrol 65 05/93 → 10/00

1.8 Petrol 74 05/93 → 05/01

2.0 S16 Petrol 110 06/94 → 05/01

2.0 S16 Petrol 112 05/93 → 05/01

2.0 XSi Petrol 89 05/93 → 05/01

306 Cabriolet (7D, N3, N5)

1.8 Petrol 74 03/94 → 04/02

2.0 Petrol 89 03/94 → 04/02

ROVER
100 / METRO (XP)

114 GSi Petrol 76 10/94 → 10/95

114 GTI 16V Petrol 76 08/91 → 12/98

114 GTI/GT 16V Cat. Petrol 66 03/90 → 12/98

100 Cabriolet (XP)

114 Petrol 75 03/97 → 10/98

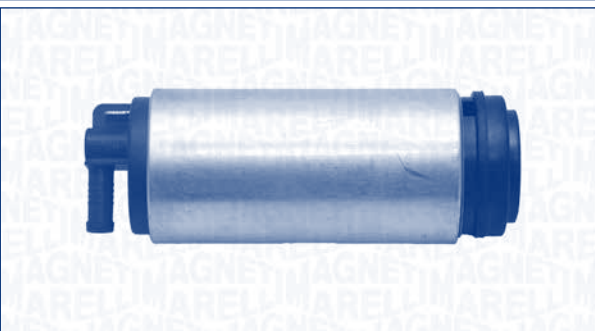
ESS0016A
J1 **POMPA CARBURANTE KIT**
PB/KIT **FUEL PUMP KIT**

AUDI
A2 (8Z0)

1.4 Petrol 55 02/00 → 08/05

1.6 FSI Petrol 81 05/02 → 08/05

A3 (8L1)

1.6 Petrol 75 08/00 → 05/03

1.8 T Petrol 132 12/98 → 05/03

1.8 T quattro Petrol 110 12/96 → 05/03

TT (8N3)

1.8 T Petrol 132 10/98 → 06/06

TT Roadster (8N9)

1.8 T Petrol 110 01/01 → 06/06

1.8 T Petrol 132 10/99 → 06/06

SEAT
ALHAMBRA (7V8, 7V9)

1.8 T 20V Petrol 110 10/97 → 03/10

2.8 V6 Petrol 150 06/00 → 03/10

2.8 V6 4motion Petrol 150 06/00 → 03/10

AROSA (6H)

1.4 16V Petrol 74 01/00 → 06/04

IBIZA IV (6L1)

1.2 Petrol 47 02/02 → 06/06

1.4 16V Petrol 55 02/02 → 12/07

1.4 16V Petrol 74 02/02 → 11/09

LEON (1M1)

1.4 16V Petrol 55 11/99 → 06/06

1.6 Petrol 74 11/99 → 06/06

1.6 16 V Petrol 77 09/00 → 06/06

1.8 20V Petrol 92 11/99 → 06/06

1.8 20V T Petrol 132 11/99 → 06/06

1.8 20V T 4 Petrol 132 11/99 → 06/06

2.8 Cupra 4 Petrol 150 02/01 → 06/06

TOLEDO II (1M2)

1.4 16V Petrol 55 07/99 → 05/06

1.6 Petrol 74 04/99 → 09/00

ESS0016A



KW



SEAT

TOLEDO II (1M2)

1.6 16V	Petrol	77	09/00 → 05/06
1.8 20V	Petrol	92	04/99 → 05/06
1.8 20VT	Petrol	132	05/01 → 05/06
2.3 V5 20V	Petrol	125	05/01 → 05/06

SKODA

FABIA (6Y2)

1.0	Petrol	37	12/99 → 08/02
1.2	Petrol	40	08/02 → 03/08
1.2	Petrol	47	01/03 → 03/08
1.4	Petrol	44	08/00 → 08/02
1.4	Petrol	50	08/99 → 05/03
1.4 16V	Petrol	55	12/99 → 03/08
1.4 16V	Petrol	74	12/99 → 03/08
2.0	Petrol	85	12/99 → 03/08

FABIA Combi (6Y5)

1.2	Petrol	47	01/03 → 12/07
1.4	Petrol	44	04/00 → 03/03
1.4	Petrol	50	04/00 → 05/03
1.4 16V	Petrol	55	05/00 → 12/07
1.4 16V	Petrol	74	04/00 → 12/07
2.0	Petrol	85	04/00 → 12/07

FABIA Praktik

1.2	Petrol	47	01/03 → 12/07
-----	--------	----	---------------

FABIA Tre volumi (6Y3)

1.2	Petrol	40	07/01 → 12/07
1.2	Petrol	47	01/03 → 12/07
1.4	Petrol	44	04/00 → 08/02
1.4	Petrol	50	07/01 → 05/03
1.4 16V	Petrol	55	10/99 → 12/07
1.4 16V	Petrol	74	12/99 → 12/07
2.0	Petrol	85	12/99 → 12/07

OCTAVIA (1U2)

1.4	Petrol	44	04/99 → 03/01
1.4 16V	Petrol	55	09/00 → 12/10
1.6	Petrol	75	11/00 → 12/10
1.8 T	Petrol	110	08/97 → 12/10
1.8 T 4x4	Petrol	110	05/01 → 05/06
2.0	Petrol	85	04/99 → 05/07
RS 1.8 T	Petrol	132	05/01 → 01/06

OCTAVIA Combi (1U5)

1.4 16V	Petrol	55	08/00 → 12/10
1.6	Petrol	74	07/98 → 12/07
1.6	Petrol	55	07/98 → 09/04
1.6	Petrol	75	09/00 → 12/10

ESS0016A



KW



SKODA

OCTAVIA Combi (1U5)

1.8 20V	Petrol	92	07/98 → 07/00
1.8 T	Petrol	110	07/98 → 12/10
1.8 T 4x4	Petrol	110	05/01 → 05/06
2.0	Petrol	85	04/99 → 05/07
2.0 4x4	Petrol	85	08/00 → 09/04
2.0 4x4	Petrol	88	01/00 → 12/10
RS 1.8 T	Petrol	132	08/02 → 01/06

SUPERB (3U4)

1.8 T	Petrol	110	12/01 → 03/08
2.0	Petrol	85	12/01 → 03/08
2.8 V6	Petrol	142	12/01 → 03/08

VOLKSWAGEN

BORA (1J2)

1.6	Petrol	74	10/98 → 05/05
1.8	Petrol	92	10/98 → 05/05
1.8 4motion	Petrol	92	02/99 → 05/05
2.0	Petrol	85	10/98 → 05/05
2.3 V5	Petrol	110	10/98 → 10/00
2.3 V5 4motion	Petrol	110	12/98 → 10/00
2.8 V6 4motion	Petrol	150	03/99 → 05/05

BORA Station wagon (1J6)

1.6	Petrol	74	05/99 → 05/05
2.0	Petrol	85	05/99 → 05/05
2.3 V5	Petrol	110	05/99 → 10/00
2.3 V5 4motion	Petrol	110	05/99 → 10/00

NEW BEETLE (9C1, 1C1)

1.6	Petrol	74	10/99 → 09/00
1.8 T	Petrol	110	10/99 → 09/10
2.0	Petrol	85	01/98 → 09/10

PASSAT (3B3)

1.6	Petrol	75	11/00 → 05/05
1.8 T 20V	Petrol	110	11/00 → 05/05
2.0	Petrol	85	11/00 → 05/05
2.0	Petrol	96	11/01 → 05/05
2.3 V5	Petrol	125	11/00 → 05/05

PASSAT Variant (3B6)

1.6	Petrol	75	11/00 → 05/05
1.8 T 20V	Petrol	110	11/00 → 05/05
2.0	Petrol	85	11/00 → 05/05
2.0	Petrol	96	11/01 → 05/05
2.3 VR5	Petrol	125	11/00 → 05/05

ESS0016A

VOLKSWAGEN
SHARAN (7M8, 7M9, 7M6)

1.8 T 20V	Petrol	110	09/97 → 03/10
2.0	Petrol	85	09/95 → 03/10
2.8 V6 24V	Petrol	150	04/00 → 03/10
2.8 V6 24V 4motion	Petrol	150	04/00 → 03/10
2.8 VR6	Petrol	128	09/95 → 04/00

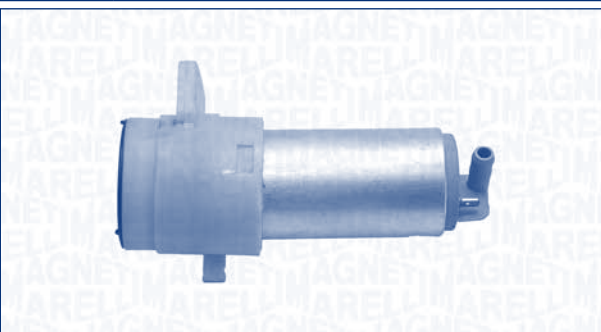
ESS0018A
**J1
PB/KIT** **POMPA CARBURANTE KIT
FUEL PUMP KIT**

FORD
GALAXY (WGR)

2.0 i	Petrol	85	11/95 → 05/06
2.8 i V6	Petrol	128	11/95 → 04/00
2.8 i V6 4x4	Petrol	128	04/96 → 04/00

SEAT
CORDOBA (6K2)

1.8 T 20V Cupra	Petrol	115	07/00 → 10/02
-----------------	--------	-----	---------------

CORDOBA (6L2)

1.4 TDI	Diesel	55	10/02 → 12/05
1.6	Petrol	74	04/03 → 11/09

IBIZA II (6K1)

1.8 i 16V	Petrol	95	11/93 → 08/96
-----------	--------	----	---------------

VOLKSWAGEN
GOLF III (1H1)

1.4	Petrol	44	10/91 → 08/97
1.6	Petrol	55	09/92 → 08/97
1.6	Petrol	74	07/95 → 08/97
2.0	Petrol	85	11/91 → 08/97
2.0 GTI 16V	Petrol	110	08/92 → 08/97
2.8 VR6	Petrol	128	01/92 → 08/97

ESS0018A

VOLKSWAGEN
GOLF III Cabriolet (1E7)

1.6	Petrol	74	10/94 → 05/98
2.0	Petrol	85	07/93 → 05/98

GOLF III Variant (1H5)

1.4	Petrol	44	07/93 → 04/99
1.6	Petrol	74	07/94 → 04/99
2.0	Petrol	85	07/93 → 04/99

GOLF IV Cabriolet (1E7)

1.6	Petrol	74	06/98 → 06/02
2.0	Petrol	85	06/98 → 06/02

PASSAT (3A2, 35I)

1.6	Petrol	74	10/94 → 08/96
2.0	Petrol	85	02/90 → 08/96
2.0 16V	Petrol	110	01/94 → 08/96

PASSAT Variant (3A5, 35I)

1.6	Petrol	74	07/94 → 12/95
2.0	Petrol	85	02/90 → 05/97
2.0 16V	Petrol	110	01/94 → 05/97

POLO (6N1)

100 1.4 16V	Petrol	74	04/96 → 10/99
75 1.6	Petrol	55	10/94 → 10/99

POLO CLASSIC (6KV2)

100 1.6	Petrol	74	12/95 → 09/01
60 1.4	Petrol	44	12/95 → 09/01

TRANSPORTER IV Autobus (70XB, 70XC, 7DB, 7DW)

2.0	Petrol	62	09/90 → 04/03
2.5	Petrol	81	11/90 → 04/03
2.5 Syncro	Petrol	81	11/92 → 04/03
2.8 VR 6	Petrol	103	11/95 → 04/00

TRANSPORTER IV Furgonato (70XA)

2.5	Petrol	85	08/96 → 04/03
2.5 Syncro	Petrol	85	08/96 → 04/03

TRANSPORTER IV Pianale piatto/Telaio (70XD)

2.0	Petrol	62	07/90 → 04/03
2.5	Petrol	81	11/90 → 04/03
2.5	Petrol	85	08/96 → 04/03
2.5 Syncro	Petrol	81	10/92 → 04/03
2.5 Syncro	Petrol	85	08/96 → 04/03

VENTO (1H2)

1.4	Petrol	44	11/91 → 09/98
1.4	Petrol	40	11/91 → 09/98
1.6	Petrol	55	09/92 → 09/98
1.6	Petrol	74	10/94 → 09/98
2.0	Petrol	85	11/91 → 09/98
2.8 VR6	Petrol	128	01/92 → 09/98

ESS0019A

J1 POMPA CARBURANTE KIT
PB/KIT FUEL PUMP KIT

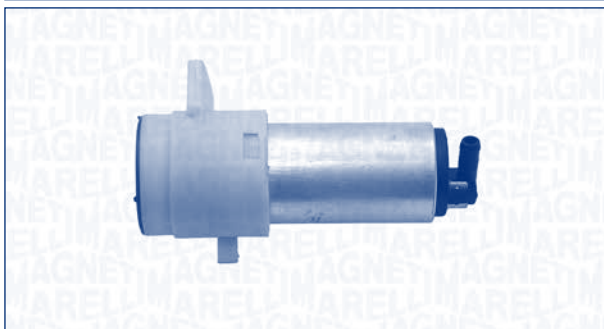

SEAT

CORDOBA (6K1, 6K2)

1.8 i Petrol 66 02/93 → 06/99

IBIZA II (6K1)

1.0 Petrol 33 03/93 → 09/96

1.0 i Petrol 37 09/96 → 08/99

1.4 i Petrol 44 09/93 → 08/99

1.6 i Petrol 55 03/93 → 08/99

1.8 i Petrol 66 03/93 → 08/99

2.0 i Petrol 85 03/93 → 08/99

TOLEDO I (1L)

1.6 i Petrol 54 05/91 → 03/99

1.6 i Petrol 55 01/93 → 03/99

1.8 16V Petrol 92 05/91 → 03/99

1.8 16V Petrol 98 05/91 → 03/99

1.8 i Petrol 65 05/91 → 12/96

1.8 i Petrol 66 11/93 → 12/96

2.0 i Petrol 85 05/91 → 03/99

2.0 i 16V Petrol 110 11/93 → 03/99

VOLKSWAGEN

CADDY II Furgonato (9K9A)

75 1.6 Petrol 55 11/95 → 09/00

75 1.6 Petrol 55 11/95 → 05/97

GOLF III (1H1)

1.4 Petrol 40 11/91 → 08/97

1.8 Petrol 55 11/91 → 08/97

1.8 Petrol 66 11/91 → 08/97

GOLF III Cabriolet (1E7)

1.8 Petrol 55 07/93 → 05/98

1.8 Petrol 66 07/93 → 05/98

GOLF III Variant (1H5)

1.4 Petrol 40 07/93 → 04/99

1.8 Petrol 55 07/93 → 04/99

1.8 Petrol 66 07/93 → 04/99

ESS0019A



VOLKSWAGEN

PASSAT (3A2, 35I)

1.8 Petrol 55 08/90 → 08/96

1.8 Petrol 66 02/88 → 08/96

PASSAT Variant (3A5, 35I)

1.8 Petrol 55 08/90 → 05/97

1.8 Petrol 66 02/88 → 05/97

POLO (6N1)

45 1.0 Petrol 33 10/94 → 09/96

55 1.4 Petrol 40 08/95 → 10/99

60 1.4 Petrol 44 07/95 → 10/99

POLO CLASSIC (6KV2)

75 1.6 Petrol 55 11/95 → 09/01

POLO Variant (6KV5)

1.4 Petrol 44 05/97 → 09/01

1.6 Petrol 55 05/97 → 09/01

VENTO (1H2)

1.8 Petrol 55 11/91 → 09/98

1.8 Petrol 66 11/91 → 09/98

ESS0020A

J1 POMPA CARBURANTE KIT
PB/KIT FUEL PUMP KIT



LAND ROVER

FREELANDER (LN)

2.0 Td4 4x4 Diesel 82 11/00 → 10/06

VOLKSWAGEN

PASSAT (3B3)

1.9 TDI Diesel 74 11/00 → 05/05

PASSAT Variant (3B6)

1.9 TDI Diesel 96 11/00 → 05/05

1.9 TDI Diesel 74 11/00 → 05/05

ESS0025A
J1 POMPA CARBURANTE KIT
PB/KIT FUEL PUMP KIT

ALFA ROMEO
GTV (916C_)

1.8 16V (916C3) Petrol 106 05/98 → 10/05

FIAT
COUPE (FA/175)

2.0 16V Turbo Petrol 140 11/93 → 08/96

ESS0027A
J1 POMPA CARBURANTE KIT
PB/KIT FUEL PUMP KIT

TOYOTA
YARIS (SCP9_, NSP9_, KSP9_, NCP9_, ZSP9_)

1.0 VVT-i Petrol 51 08/05 →

1.3 VVT-i Petrol 64 08/05 →

1.8 VVTi Petrol 98 01/07 →

ESS0057A
J1 POMPA CARBURANTE KIT
PB/KIT FUEL PUMP KIT

OPEL
AGILA (A) (H00)

1.2 16V Petrol 55 09/00 → 12/07

1.2 16V Twinport Petrol 59 07/04 → 12/07

OMEGA A (16_, 17_, 19_)

3.6 24V Lotus Petrol 277 08/90 → 09/92

ZAFIRA A (F75_)

 1.6 CNG Petrol/
CNG 71 09/01 → 06/05

ZAFIRA B (A05)

 1.6 CNG Petrol/
CNG 69 01/06 →

VAUXHALL
AGILA Mk I (A)

1.0 12V Petrol 43 09/00 → 08/05

1.0 12V Petrol 44 02/00 → 11/06

1.2 16V Petrol 55 09/00 → 03/08

1.2 16V Twinport Petrol 59 07/04 → 11/06

ESS0059A

J1 POMPA CARBURANTE KIT
PB/KIT FUEL PUMP KIT



BMW

3 (E46)

318 d	Diesel	85	03/03 → 02/05
318 d	Diesel	85	09/01 → 03/03
320 d	Diesel	100	04/98 → 09/01
320 d	Diesel	110	09/01 → 02/05
330 d	Diesel	135	10/99 → 02/05
330 d	Diesel	150	03/03 → 02/05
330 xd	Diesel	135	06/00 → 02/05
330 xd	Diesel	150	03/03 → 02/05

3 Cabriolet (E46)

320 Cd	Diesel	110	02/05 →
--------	--------	-----	---------

3 Compact (E46)

318 td	Diesel	85	03/03 → 02/05
320 td	Diesel	110	09/01 → 02/05

3 Coupé (E46)

320 Cd	Diesel	110	11/03 →
330 Cd	Diesel	150	03/03 →

3 Touring (E46)

318 d	Diesel	85	03/02 → 02/05
318 d	Diesel	85	03/03 → 02/05
320 d	Diesel	100	03/00 → 09/01
320 d	Diesel	110	09/01 → 02/05
330 d	Diesel	135	10/99 → 02/05
330 xd	Diesel	135	06/00 → 02/05

ESS0061A

J1 POMPA CARBURANTE KIT
PB/KIT FUEL PUMP KIT



BMW

X3 (F25)

xDrive 20i	Petrol	135	09/11 →
xDrive 28 i	Petrol	190	04/11 →
xDrive 28 i	Petrol	180	08/11 →
xDrive 35 i	Petrol	225	09/10 →

X5 (E70)

3.0 si	Petrol	200	02/07 → 09/08
4.8 i xDrive	Petrol	261	02/07 → 09/08
xDrive 30 i	Petrol	200	09/08 → 03/10
xDrive 35 i	Petrol	225	09/10 →
xDrive 48 i	Petrol	261	09/08 →

X6 (E71, E72)

35 i	Petrol	225	05/08 →
xDrive 35 i	Petrol	225	09/08 →

ESS0066A

J1 POMPA CARBURANTE KIT
PB/KIT FUEL PUMP KIT



ALFA ROMEO

145 (930)

1.9 JTD	Diesel	77	02/99 → 01/01
---------	--------	----	---------------

146 (930)

1.9 JTD	Diesel	77	02/99 → 01/01
---------	--------	----	---------------

ESS0066A

ALFA ROMEO
156 (932)

1.9 JTD (932A2B, 932A2C)	Diesel	85	05/01 → 09/05
1.9 JTD (932A2B_)	Diesel	81	10/00 → 05/01
1.9 JTD (932B2)	Diesel	77	09/97 → 10/00
2.4 JTD (932A1B_)	Diesel	103	10/00 → 09/05
2.4 JTD (932AXC)	Diesel	110	03/02 → 09/05
2.4 JTD (932B1)	Diesel	100	09/97 → 09/03

156 Sportwagon (932)

1.9 JTD (932B2)	Diesel	77	05/00 → 10/00
1.9 JTD (932B2B, 932B2C)	Diesel	85	05/01 → 05/06
1.9 JTD (932B2B_)	Diesel	81	10/00 → 05/01
2.4 JTD (932B1)	Diesel	100	05/00 → 09/03
2.4 JTD (932B1B_)	Diesel	103	10/00 → 05/06
2.4 JTD (932BXC)	Diesel	110	03/02 → 05/06

166 (936)

2.4 JTD	Diesel	110	04/02 → 06/07
2.4 JTD	Diesel	129	10/03 → 06/07
2.4 JTD	Diesel	132	07/06 → 06/07
2.4 JTD	Diesel	136	07/05 → 06/07
2.4 JTD (936A2A_)	Diesel	100	09/98 → 10/00
2.4 JTD (936A2B_)	Diesel	103	10/00 → 06/07

CITROËN
JUMPER Autobus

2.2 HDi 100	Diesel	74	04/06 →
2.2 HDi 120	Diesel	88	04/06 →
3.0 HDi 160	Diesel	116	09/06 →

JUMPER Autobus (230P)

2.8 HDi	Diesel	94	09/00 → 04/02
2.8 HDi 4x4	Diesel	94	09/00 → 04/02

JUMPER Autobus (244, Z_)

2.0 HDi	Diesel	62	04/02 →
2.2 HDi	Diesel	74	04/02 →
2.8 HDi	Diesel	94	04/02 →

ESS0066A

CITROËN
JUMPER Furgonato

2.2 HDi 100	Diesel	74	04/06 →
2.2 HDi 120	Diesel	88	04/06 →
3.0 HDi 160	Diesel	116	09/06 →

JUMPER Furgonato (230L)

2.0 HDi	Diesel	62	11/01 → 04/02
2.8 HDi	Diesel	94	09/00 → 04/02
2.8 HDi 4x4	Diesel	94	09/00 → 04/02

JUMPER Furgonato (244)

2.0 HDi	Diesel	62	04/02 →
2.2 HDi	Diesel	74	04/02 →
2.8 HDi	Diesel	107	05/04 →
2.8 HDi	Diesel	94	04/02 →
2.8 HDi 4x4	Diesel	94	04/02 →

JUMPER Pianale piatto/Telaio

2.2 HDi 100	Diesel	74	04/06 →
2.2 HDi 120	Diesel	88	04/06 →
3.0 HDi 160	Diesel	116	09/06 →

JUMPER Pianale piatto/Telaio (230)

2.8 HDi	Diesel	94	09/00 → 04/02
2.8 HDi	Diesel	93	10/00 → 01/02

JUMPER Pianale piatto/Telaio (244)

2.0 HDi	Diesel	62	04/02 →
2.2 HDi	Diesel	74	04/02 →
2.2 HDi	Diesel	74	02/02 → 06/06
2.8 HDi	Diesel	107	05/04 →
2.8 HDi	Diesel	94	04/02 →
2.8 HDi 4x4	Diesel	94	02/02 → 06/06

FIAT
BRAVA (182)

1.9 JTD	Diesel	74	09/00 → 10/01
1.9 JTD 105	Diesel	77	12/98 → 10/01

BRAVO I (182)

1.9 JTD	Diesel	74	09/00 → 10/01
1.9 JTD 105	Diesel	77	12/98 → 10/01

DOBLO (119)

1.9 JTD (223AXE1A)	Diesel	74	10/01 →
-----------------------	--------	----	---------

DOBLO Cargo (223)

1.3 JTD 16V	Diesel	51	05/04 → 12/06
1.9 JTD	Diesel	77	07/03 →
1.9 JTD (223ZXE1A)	Diesel	74	10/01 →
1.9 JTD Multijet	Diesel	88	12/06 →

ESS0066A



KW



FIAT

DUCATO Autobus (230)

2.0 JTD	Diesel	62	10/01 → 04/02
2.8 JTD	Diesel	94	11/00 → 04/02
2.8 JTD 4x4	Diesel	94	11/00 → 04/02
2.8 TDI	Diesel	90	10/97 → 04/02
2.8 TDI 4x4	Diesel	90	07/99 → 04/02

DUCATO Autobus (244, Z_)

2.0 JTD	Diesel	62	04/02 →
2.3 JTD	Diesel	81	04/02 →
2.8 JTD	Diesel	94	04/02 →
2.8 JTD 4x4	Diesel	94	07/02 →

DUCATO Autobus (250)

100 Multijet 2,2 D	Diesel	74	07/06 →
120 Multijet 2,3 D	Diesel	88	07/06 →

DUCATO Furgonato (230L)

2.0 JTD	Diesel	62	10/01 → 04/02
2.8 JTD	Diesel	94	11/00 → 04/02
2.8 JTD 4x4	Diesel	94	11/00 → 04/02
2.8 TDI	Diesel	90	10/97 → 04/02
2.8 TDI 4x4	Diesel	90	06/99 → 04/02

DUCATO Furgonato (244)

2.0 JTD	Diesel	62	04/02 →
2.3 JTD	Diesel	81	04/02 →
2.8 JTD	Diesel	94	04/02 →
2.8 JTD 4x4	Diesel	94	07/02 →

DUCATO Furgonato (250)

120 Multijet 2,3 D	Diesel	88	07/06 →
--------------------	--------	----	---------

DUCATO Pianale piatto/Telaio (230)

2.8 iDTD 4x4	Diesel	90	05/98 → 09/01
2.8 JTD	Diesel	94	11/00 → 04/02
2.8 TDI	Diesel	90	12/98 → 04/02

DUCATO Pianale piatto/Telaio (244)

2.0 JTD	Diesel	62	04/02 → 07/06
2.3 JTD	Diesel	81	04/02 → 07/06
2.8 JTD	Diesel	94	04/02 → 07/06
2.8 JTD 4x4	Diesel	94	10/02 → 07/06

DUCATO Pianale piatto/Telaio (250)

120 Multijet 2,3 D	Diesel	88	07/06 →
--------------------	--------	----	---------

MAREA (185)

1.9 JTD 105	Diesel	77	04/99 → 01/01
1.9 JTD 110	Diesel	81	01/01 → 05/02
2.4 JTD 130	Diesel	96	04/99 → 05/02

MAREA Weekend (185)

1.9 JTD 105	Diesel	77	04/99 → 05/02
1.9 JTD 110	Diesel	81	01/01 → 05/02

ESS0066A



KW



HONDA

ACCORD VII Tourer (CM)

2.0 (CM1)	Petrol	114	04/03 →
-----------	--------	-----	---------

LANCIA

KAPPA (838A)

2.4 JTD (838AL1AA)	Diesel	100	06/98 → 10/01
--------------------	--------	-----	---------------

KAPPA SW (838B)

2.4 JTD (838BL1AA)	Diesel	100	06/98 → 10/01
--------------------	--------	-----	---------------

LYBRA (839AX)

1.9 JTD	Diesel	85	05/01 → 10/05
---------	--------	----	---------------

1.9 JTD (839AXD1A)	Diesel	77	07/99 → 09/00
--------------------	--------	----	---------------

1.9 JTD (839AXI1A)	Diesel	81	09/00 → 05/01
--------------------	--------	----	---------------

2.4 JTD	Diesel	110	05/02 → 10/05
---------	--------	-----	---------------

2.4 JTD (839AXE1A)	Diesel	99	07/99 → 02/01
--------------------	--------	----	---------------

2.4 JTD (839AXL1A)	Diesel	103	09/00 → 05/02
--------------------	--------	-----	---------------

LYBRA SW (839BX)

1.9 JTD	Diesel	85	05/01 → 10/05
---------	--------	----	---------------

1.9 JTD (839BXD1A)	Diesel	77	07/99 → 09/00
--------------------	--------	----	---------------

1.9 JTD (839BXI1A)	Diesel	81	09/00 → 05/01
--------------------	--------	----	---------------

2.4 JTD	Diesel	110	05/02 → 10/05
---------	--------	-----	---------------

2.4 JTD (839BXE1A)	Diesel	99	10/99 → 09/00
--------------------	--------	----	---------------

2.4 JTD (839BXL1A)	Diesel	103	09/00 → 10/05
--------------------	--------	-----	---------------

THEISIS (841AX)

2.4 D Multijet	Diesel	136	04/06 → 07/09
----------------	--------	-----	---------------

2.4 JTD	Diesel	129	05/03 → 07/09
---------	--------	-----	---------------

2.4 JTD (841AXD1B02)	Diesel	110	07/02 → 07/09
----------------------	--------	-----	---------------

PEUGEOT

BOXER Autobus (230P)

2.8 HDi	Diesel	94	11/00 → 04/02
---------	--------	----	---------------

2.8 HDi	Diesel	93	10/00 → 11/01
---------	--------	----	---------------

2.8 HDi 4x4	Diesel	94	10/00 → 04/02
-------------	--------	----	---------------

BOXER Autobus (244, Z_)

2.0 HDi	Diesel	62	04/02 →
---------	--------	----	---------

2.2 HDi	Diesel	74	04/02 →
---------	--------	----	---------

2.8 HDi	Diesel	94	04/02 →
---------	--------	----	---------

ESS0066A

PEUGEOT
BOXER Autobus (244, Z_)

2.8 HDi 4x4 Diesel 94 04/02 →

BOXER Furgonato (230L)

2.8 HDi Diesel 94 11/00 → 04/02

2.8 HDi Diesel 93 10/00 → 11/01

2.8 HDi 4x4 Diesel 94 10/00 → 04/02

2.0 HDi Diesel 62 04/02 →

2.2 HDi Diesel 74 04/02 →

2.8 HDi Diesel 94 04/02 →

2.8 HDi Diesel 107 04/04 →

2.8 HDi 4x4 Diesel 94 04/02 →

BOXER Pianale piatto/Telaio (244)

2.0 HDi Diesel 62 04/02 →

2.2 HDi Diesel 74 04/02 →

2.8 HDi Diesel 94 04/02 →

2.8 HDi Diesel 107 04/04 →

2.8 HDi 4x4 Diesel 94 04/02 →

BOXER Pianale piatto/Telaio (ZCT_)

2.8 HDi Diesel 94 11/00 → 04/02

2.8 HDi Diesel 93 10/00 → 11/01

ESS0068A
**J1 POMPA CARBURANTE KIT
PB/KIT FUEL PUMP KIT**

IVECO
DAILY IV Cassone / Furgonato / Promiscuo

35C11 V, 35S11 V Diesel 78 07/07 →

 35C12 V,
35C12 V/P,
35S12 V,
35S12 V/P

Diesel 85 05/06 →

ESS0068A

IVECO
DAILY IV Cassone / Furgonato / Promiscuo

 35C13 V,
35C13 V/P,
35S13 V,
35S13 V/P Diesel 93 07/07 →

 35C15 V,
35C15 V/P Diesel 107 05/06 →

 35C18 V,
35C18 V/P,
35S18 V,
35S18 V/P Diesel 130 05/06 →

 40C15 V,
40C15 V/P Diesel 107 05/06 →

 50C15 V,
50C15 V/P Diesel 107 05/06 →

 50C18 V,
50C18 V/P Diesel 130 05/06 →

60C18 Diesel 130 05/06 →

65C15 Diesel 107 05/06 →

DAILY IV Pianale piatto/Telaio

 35C11,
35S11, 35S11 D,
35S11 /P Diesel 78 07/07 →

35C12, 35S12 Diesel 85 05/06 →

 35C13, 35C13 /P,
35S13 D,
35S13, 35S13 /P Diesel 93 07/07 →

35C15 Diesel 107 05/06 →

35C18, 35S18 Diesel 130 05/06 →

40C15 Diesel 107 05/06 →

50C15 Diesel 107 05/06 →

50C18 Diesel 130 05/06 →

60C18 Diesel 130 05/06 →

 65C15, 65C15 /P,
65C15 D,
65C15 D/P Diesel 107 05/06 →

DAILY IV Ribaltabile

35C10 K Diesel 70 05/06 →

 35C11 K,
35C11 DK,
35S11 K,
35S11 DK Diesel 78 07/07 →

ESS0068A



IVECO

DAILY IV Ribaltabile

35C13 K, 35C13 DK, 35S13 K, 35S13 DK	Diesel	93	07/07 →
---	--------	----	---------

35C15	Diesel	107	05/06 →
-------	--------	-----	---------

35C18	Diesel	130	05/06 →
-------	--------	-----	---------

50C15	Diesel	107	05/06 →
-------	--------	-----	---------

50C18	Diesel	130	05/06 →
-------	--------	-----	---------

60C18	Diesel	130	05/06 →
-------	--------	-----	---------

ESS0070A

**J1 POMPA CARBURANTE KIT
PB/KIT FUEL PUMP KIT**



OPEL

CORSA C Furgonato (F08, W5L)

1.3 CDTI 16V	Diesel	51	08/05 →
--------------	--------	----	---------

MERIVA

1.3 CDTI	Diesel	51	04/05 → 05/10
----------	--------	----	---------------

1.3 CDTI	Diesel	55	09/03 → 05/10
----------	--------	----	---------------

TIGRA TwinTop

1.3 CDTI	Diesel	51	06/04 →
----------	--------	----	---------

CORSA Mk II (C) (W5L, F08)

1.3 CDTI 16V	Diesel	52	08/00 → 09/06
--------------	--------	----	---------------

VAUXHALL

CORSAVAN Mk II (C)

1.3 CDTI 16V	Diesel	52	04/04 → 06/06
--------------	--------	----	---------------

MERIVA Mk I (A)

1.3 CDTI	Diesel	55	01/03 → 10/09
----------	--------	----	---------------

TIGRA TwinTop

1.3 CDTI	Diesel	51	06/04 → 08/09
----------	--------	----	---------------

ESS0071A

**J1 POMPA CARBURANTE KIT
PB/KIT FUEL PUMP KIT**



AUDI

A4 (8D2, B5)

1.6	Petrol	74	11/94 → 10/00
-----	--------	----	---------------

1.6	Petrol	75	07/00 → 11/00
-----	--------	----	---------------

1.8	Petrol	92	01/95 → 11/00
-----	--------	----	---------------

1.8 T	Petrol	110	01/95 → 11/00
-------	--------	-----	---------------

1.8 T	Petrol	132	12/97 → 11/00
-------	--------	-----	---------------

2.4	Petrol	120	08/97 → 11/00
-----	--------	-----	---------------

2.4	Petrol	121	03/97 → 11/00
-----	--------	-----	---------------

2.6	Petrol	110	01/95 → 11/00
-----	--------	-----	---------------

2.8	Petrol	128	09/95 → 07/97
-----	--------	-----	---------------

2.8	Petrol	142	10/96 → 11/00
-----	--------	-----	---------------

S4 quattro	Petrol	195	09/97 → 09/01
------------	--------	-----	---------------

A4 (8E2, B6)

1.6	Petrol	75	11/00 → 12/04
-----	--------	----	---------------

A4 (8EC, B7)

1.6	Petrol	75	11/04 → 06/08
-----	--------	----	---------------

A4 Avant (8D5, B5)

1.6	Petrol	74	11/94 → 09/01
-----	--------	----	---------------

1.6	Petrol	75	07/00 → 09/01
-----	--------	----	---------------

1.8	Petrol	92	02/96 → 09/01
-----	--------	----	---------------

1.8 T	Petrol	110	03/96 → 09/01
-------	--------	-----	---------------

1.8 T	Petrol	132	12/97 → 09/01
-------	--------	-----	---------------

2.4	Petrol	120	08/97 → 09/01
-----	--------	-----	---------------

2.4	Petrol	121	03/97 → 09/01
-----	--------	-----	---------------

2.4 quattro	Petrol	120	08/97 → 09/01
-------------	--------	-----	---------------

2.6	Petrol	110	02/96 → 09/01
-----	--------	-----	---------------

2.8	Petrol	128	03/96 → 09/96
-----	--------	-----	---------------

2.8	Petrol	142	10/96 → 09/01
-----	--------	-----	---------------

S4 quattro	Petrol	195	09/97 → 09/01
------------	--------	-----	---------------

A4 Avant (8E5, B6)

1.6	Petrol	75	09/01 → 12/04
-----	--------	----	---------------

A4 Avant (8ED, B7)

1.6	Petrol	75	11/04 → 06/08
-----	--------	----	---------------

ESS0072A
J1
POMPA CARBURANTE KIT
PB/KIT FUEL PUMP KIT

AUDI
A6 (4B2, C5)

1.8	Petrol	92	07/97 → 01/05
1.8 T quattro	Petrol	110	02/97 → 01/05
1.8 T quattro	Petrol	132	12/97 → 01/05
2.4	Petrol	100	07/98 → 01/05
2.4 quattro	Petrol	125	08/01 → 01/05
2.4 quattro	Petrol	115	08/98 → 07/99
2.4 quattro	Petrol	120	02/97 → 01/05
2.4 quattro	Petrol	121	02/97 → 01/05
2.7 T	Petrol	169	02/99 → 01/05
2.7 T quattro	Petrol	169	12/97 → 01/05
2.8 quattro	Petrol	142	02/97 → 01/05
3.0 quattro	Petrol	162	08/01 → 01/05
4.2 quattro	Petrol	220	11/98 → 01/05

A6 Avant (4B5, C5)

1.8 T	Petrol	132	04/99 → 01/05
1.8 T quattro	Petrol	110	12/97 → 01/05
1.8 T quattro	Petrol	132	12/97 → 01/05
2.4 quattro	Petrol	125	08/01 → 01/05
2.4 quattro	Petrol	120	12/97 → 01/05
2.4 quattro	Petrol	121	12/97 → 01/05
2.7 T	Petrol	169	02/99 → 01/05
2.7 T quattro	Petrol	169	12/97 → 01/05
2.8 quattro	Petrol	142	12/97 → 01/05
3.0 quattro	Petrol	162	08/01 → 01/05
4.2 quattro	Petrol	220	11/98 → 01/05

VOLKSWAGEN
PASSAT (3B2)

1.8 Syncro/4motion	Petrol	92	10/96 → 11/00
2.3 VR5 Syncro/4motion	Petrol	110	10/97 → 11/00

ESS0072A

VOLKSWAGEN
PASSAT (3B3)

2.0 4motion	Petrol	85	11/00 → 05/05
2.3 V5 4motion	Petrol	125	11/00 → 05/05
2.8 4motion	Petrol	142	11/00 → 05/05

PASSAT Variant (3B5)

1.8 Syncro/4motion	Petrol	92	06/97 → 11/00
--------------------	--------	----	---------------

2.3 VR5 Syncro/4motion	Petrol	110	10/97 → 11/00
------------------------	--------	-----	---------------

2.8 V6 Syncro/4motion	Petrol	142	06/97 → 11/00
-----------------------	--------	-----	---------------

PASSAT Variant (3B6)

2.0 4motion	Petrol	85	11/00 → 05/05
2.3 VR5 4motion	Petrol	125	11/00 → 05/05
2.8 4motion	Petrol	142	11/00 → 05/05

ESS0073A
J1
POMPA CARBURANTE KIT
PB/KIT FUEL PUMP KIT

AUDI
A3 (8P1)

1.9 TDI	Diesel	77	05/03 → 05/10
2.0 TDi	Diesel	100	05/03 → 08/12
2.0 TDi	Diesel	103	06/05 → 06/08
2.0 TDi	Diesel	125	03/06 → 08/12
2.0 TDi 16V	Diesel	103	05/03 → 08/12
2.0 TDi 16V quattro	Diesel	103	08/04 → 08/12
2.0 TDi quattro	Diesel	100	05/03 → 06/08
2.0 TDi quattro	Diesel	103	01/06 → 06/08
2.0 TDi quattro	Diesel	125	03/06 → 08/12

A3 Cabriolet (8P7)

1.9 TDI	Diesel	77	04/08 → 10/09
---------	--------	----	---------------

ESS0073A



KW



AUDI

A3 Sportback (8PA)

1.9 TDI	Diesel	77	09/04 → 05/10
2.0 TDi	Diesel	103	06/05 → 06/08
2.0 TDi	Diesel	125	03/06 → 03/13
2.0 TDI 16V	Diesel	103	09/04 → 03/13
2.0 TDI 16V quattro	Diesel	103	11/05 → 03/13
2.0 TDI quattro	Diesel	103	01/06 → 06/08
2.0 TDI quattro	Diesel	125	03/06 → 03/13

SEAT

ALTEA (5P1)

1.9 TDI	Diesel	77	04/04 →
2.0 FSI	Petrol	110	05/04 → 03/09
2.0 TDi	Diesel	100	03/04 → 05/09
2.0 TDi	Diesel	103	11/05 →
2.0 TDi	Diesel	125	03/06 →
2.0 TDI 16V	Diesel	103	03/04 →

ALTEA XL (5P5, 5P8)

1.9 TDI	Diesel	77	10/06 →
2.0 TDi	Diesel	103	10/06 →
2.0 TDi	Diesel	125	06/07 →
2.0 TDI 16V	Diesel	103	10/06 →
2.0 TDI 4x4	Diesel	125	06/07 →

LEON (1M1)

1.9 TDI	Diesel	110	02/01 → 06/06
1.9 TDI	Diesel	96	05/03 → 06/06
1.9 TDI	Diesel	74	10/05 → 06/06
1.9 TDI	Diesel	66	11/99 → 06/06
1.9 TDI	Diesel	81	11/99 → 06/06
1.9 TDI Syncro	Diesel	110	05/02 → 06/06

LEON (1P1)

1.9 TDI	Diesel	77	07/05 →
2.0 TDi	Diesel	103	10/05 →
2.0 TDi	Diesel	125	05/06 →
2.0 TDI 16V	Diesel	103	07/05 →

TOLEDO I (1L)

1.9 TDI	Diesel	66	08/95 → 03/99
---------	--------	----	---------------

TOLEDO II (1M2)

1.9 TDI	Diesel	96	05/03 → 05/06
1.9 TDI	Diesel	110	10/00 → 05/06
1.9 TDI	Diesel	66	04/99 → 05/06
1.9 TDI	Diesel	81	04/99 → 05/06

TOLEDO III (5P2)

1.9 TDI	Diesel	77	10/04 → 05/09
2.0 TDI 16V	Diesel	103	04/04 → 05/09

ESS0073A



KW



SKODA

OCTAVIA (1U2)

1.9 SDI	Diesel	50	06/97 → 12/03
1.9 TDI	Diesel	74	10/05 → 12/10
1.9 TDI	Diesel	96	09/02 → 09/04
1.9 TDI	Diesel	81	08/97 → 01/06

OCTAVIA (1Z3)

1.9 TDI	Diesel	77	06/04 → 12/10
2.0 TDi	Diesel	103	11/05 →

OCTAVIA Combi (1U5)

1.9 SDI	Diesel	50	07/98 → 12/03
1.9 TDI	Diesel	66	07/98 → 03/10
1.9 TDI	Diesel	74	08/00 → 12/10
1.9 TDI	Diesel	81	07/98 → 01/06
1.9 TDI	Diesel	96	09/02 → 09/04
1.9 Tdi 4x4	Diesel	66	11/99 → 02/06
1.9 Tdi 4x4	Diesel	74	09/00 → 01/06

OCTAVIA Combi (1Z5)

1.9 TDI	Diesel	77	09/04 → 12/10
1.9 Tdi 4x4	Diesel	77	11/04 → 12/10
2.0 TDi	Diesel	103	11/05 →
2.0 TDI 16V	Diesel	103	02/04 →
2.0 TDI 4x4	Diesel	103	07/06 →

ROOMSTER (5J)

1.9 TDI	Diesel	77	09/06 → 03/10
---------	--------	----	---------------

VOLKSWAGEN

BORA (1J2)

1.9 TDI	Diesel	110	05/00 → 05/05
1.9 TDI	Diesel	96	11/00 → 05/05
1.9 TDI	Diesel	66	10/98 → 06/01
1.9 TDI	Diesel	81	10/98 → 06/01
1.9 TDI	Diesel	85	12/98 → 01/02
1.9 TDI	Diesel	74	09/00 → 05/05
1.9 TDI 4motion	Diesel	110	05/00 → 05/05
1.9 TDI 4motion	Diesel	96	11/00 → 05/05
1.9 TDI 4motion	Diesel	66	02/99 → 06/01
1.9 TDI 4motion	Diesel	85	02/99 → 06/01
1.9 TDI 4motion	Diesel	74	09/00 → 05/05

BORA Station wagon (1J6)

1.9 TDI	Diesel	110	05/01 → 05/05
1.9 TDI	Diesel	96	11/00 → 05/05
1.9 TDI	Diesel	74	09/00 → 05/05
1.9 TDI 4motion	Diesel	85	05/99 → 06/01

EOS (1F7, 1F8)

2.0 TDi	Diesel	103	06/06 → 05/08
---------	--------	-----	---------------

ESS0073A

VOLKSWAGEN
GOLF IV (1J1)

1.9 TDI	Diesel	110	05/00 → 06/05
1.9 TDI	Diesel	96	11/00 → 06/05
1.9 TDI	Diesel	66	10/97 → 05/04
1.9 TDI	Diesel	74	09/00 → 06/05
1.9 TDI	Diesel	81	08/97 → 05/04
1.9 TDI	Diesel	85	12/98 → 06/01
1.9 TDI 4motion	Diesel	110	02/00 → 06/05
1.9 TDI 4motion	Diesel	96	11/00 → 06/05
1.9 TDI 4motion	Diesel	66	07/98 → 04/02
1.9 TDI 4motion	Diesel	85	09/99 → 06/01
1.9 TDI 4motion	Diesel	74	09/00 → 06/05

GOLF IV Variant (1J5)

1.9 TDI	Diesel	96	11/00 → 06/06
1.9 TDI	Diesel	66	05/99 → 05/06
1.9 TDI	Diesel	81	05/99 → 06/01
1.9 TDI	Diesel	85	08/99 → 06/01
1.9 TDI	Diesel	74	09/00 → 06/06
1.9 TDI 4motion	Diesel	96	11/00 → 06/06
1.9 TDI 4motion	Diesel	66	05/99 → 04/02
1.9 TDI 4motion	Diesel	85	05/99 → 06/01
1.9 TDI 4motion	Diesel	74	09/00 → 06/06

GOLF PLUS (5M1, 521)

1.9 TDI	Diesel	66	05/05 → 12/08
2.0 TDI 16V	Diesel	103	01/05 →
1.9 TDI	Diesel	77	01/05 → 01/09
2.0 TDi	Diesel	100	05/05 →
2.0 TDi	Diesel	103	12/05 → 05/09

GOLF V (1K1)

1.9 TDI	Diesel	66	05/04 → 11/08
1.9 TDI	Diesel	77	10/03 → 11/08
1.9 TDI 4motion	Diesel	77	08/04 → 11/08
2.0 SDI	Diesel	55	01/04 → 11/08
2.0 TDi	Diesel	100	10/03 → 11/08
2.0 TDi	Diesel	103	12/04 → 11/08
2.0 TDi	Diesel	125	11/05 → 11/08
2.0 TDI 16V	Diesel	103	10/03 → 11/08
2.0 TDI 16V 4motion	Diesel	103	08/04 → 11/08
2.0 TDI 4motion	Diesel	103	08/04 → 11/08

GOLF V Variant (1K5)

1.9 TDI	Diesel	77	06/07 → 07/09
2.0 TDi	Diesel	103	06/07 → 07/09
2.0 TDI 16V	Diesel	103	06/07 → 07/09

ESS0073A

VOLKSWAGEN
JETTA III (1K2)

1.9 TDI	Diesel	77	08/05 → 10/10
2.0 TDi	Diesel	100	09/05 → 10/10
2.0 TDi	Diesel	103	10/05 → 10/10
2.0 TDi	Diesel	125	10/06 → 10/10
2.0 TDI 16V	Diesel	103	08/05 → 10/10

NEW BEETLE (9C1, 1C1)

1.9 TDI	Diesel	66	01/98 → 06/04
1.9 TDI	Diesel	77	07/05 → 09/10
1.9 TDI	Diesel	74	02/01 → 09/10

NEW BEETLE Cabriolet (1Y7)

1.9 TDI	Diesel	77	07/05 → 09/10
1.9 TDI	Diesel	74	06/03 → 09/10

PASSAT (3C2)

1.9 TDI	Diesel	77	03/05 → 11/08
2.0 TDi	Diesel	103	03/05 → 05/09
2.0 TDi	Diesel	125	08/05 → 07/10
2.0 TDI 4motion	Diesel	103	03/05 → 05/09

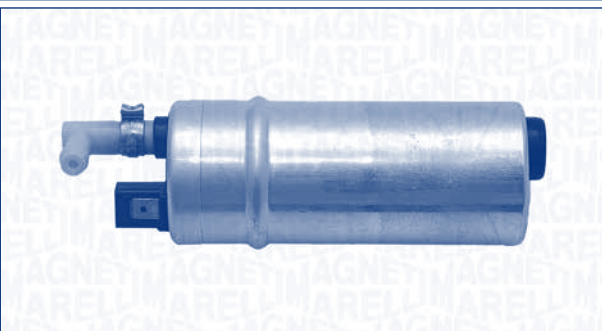
ESS0074A
**J1 POMPA CARBURANTE KIT
PB/KIT FUEL PUMP KIT**

BMW
5 (E39)

520 d	Diesel	100	02/00 → 06/03
525 d	Diesel	120	02/00 → 06/03
525 td	Diesel	85	01/97 → 06/03
525 tds	Diesel	105	01/96 → 06/03
530 d	Diesel	135	08/98 → 09/00

5 Touring (E39)

520 d	Diesel	100	02/00 → 09/03
525 d	Diesel	120	02/00 → 05/04
525 tds	Diesel	105	03/97 → 05/04
530 d	Diesel	135	08/98 → 09/00

ESS0075A

J1 POMPA CARBURANTE KIT
PB/KIT FUEL PUMP KIT

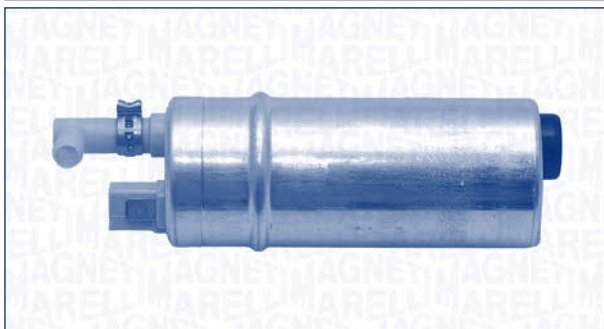

VOLKSWAGEN

FOX (5Z1, 5Z3)

1.4 TDI	Diesel	51	04/05 →
---------	--------	----	---------

PASSAT (362)

2.0 TDi	Diesel	125	08/10 →
---------	--------	-----	---------

2.0 TDI 4motion	Diesel	125	08/10 →
-----------------	--------	-----	---------

PASSAT (3C2)

2.0 BlueTDI	Diesel	105	01/09 → 11/10
-------------	--------	-----	---------------

2.0 TDi	Diesel	100	03/05 → 11/10
---------	--------	-----	---------------

2.0 TDi	Diesel	81	11/08 → 07/10
---------	--------	----	---------------

2.0 TDi	Diesel	88	11/05 → 05/07
---------	--------	----	---------------

2.0 TDI 16V	Diesel	103	03/05 → 07/10
-------------	--------	-----	---------------

2.0 TDI 16V 4motion	Diesel	103	03/05 → 08/10
---------------------	--------	-----	---------------

2.0 TDI 4motion	Diesel	125	05/09 → 07/10
-----------------	--------	-----	---------------

PASSAT CC (357)

2.0 BlueTDI	Diesel	105	05/09 → 11/10
-------------	--------	-----	---------------

2.0 TDi	Diesel	100	06/08 → 05/11
---------	--------	-----	---------------

2.0 TDi	Diesel	103	06/08 → 01/12
---------	--------	-----	---------------

2.0 TDi	Diesel	125	06/08 → 01/12
---------	--------	-----	---------------

2.0 TDI 4motion	Diesel	103	08/09 → 01/12
-----------------	--------	-----	---------------

2.0 TDI 4motion	Diesel	125	11/09 → 01/12
-----------------	--------	-----	---------------

PASSAT Variant (365)

2.0 TDi	Diesel	125	08/10 →
---------	--------	-----	---------

2.0 TDI 4motion	Diesel	125	08/10 →
-----------------	--------	-----	---------

PASSAT Variant (3C5)

1.9 TDI	Diesel	77	08/05 → 11/08
---------	--------	----	---------------

2.0 BlueTDI	Diesel	105	01/09 → 11/10
-------------	--------	-----	---------------

2.0 TDi	Diesel	100	08/05 → 11/10
---------	--------	-----	---------------

2.0 TDi	Diesel	103	08/05 → 05/09
---------	--------	-----	---------------

2.0 TDi	Diesel	125	08/05 → 11/10
---------	--------	-----	---------------

2.0 TDi	Diesel	90	08/05 → 02/06
---------	--------	----	---------------

2.0 TDi	Diesel	81	11/08 → 11/10
---------	--------	----	---------------

2.0 TDI 16V	Diesel	103	08/05 → 11/10
-------------	--------	-----	---------------

2.0 TDI 4motion	Diesel	103	08/05 → 05/09
-----------------	--------	-----	---------------

ESS0075A



VOLKSWAGEN

PASSAT Variant (3C5)

2.0 TDI 4motion	Diesel	125	05/09 → 11/10
-----------------	--------	-----	---------------

TIGUAN (5N_)

2.0 TDi	Diesel	103	03/08 →
---------	--------	-----	---------

2.0 TDI 4motion	Diesel	100	11/07 →
-----------------	--------	-----	---------

2.0 TDI 4motion	Diesel	103	09/07 →
-----------------	--------	-----	---------

2.0 TDI 4motion	Diesel	125	09/07 →
-----------------	--------	-----	---------

ESS0082A

J1 POMPA CARBURANTE KIT
PB/KIT FUEL PUMP KIT



BMW

3 (E46)

316 i	Petrol	77	04/00 → 02/05
-------	--------	----	---------------

316 i	Petrol	77	09/98 → 02/05
-------	--------	----	---------------

316 i	Petrol	85	02/02 → 02/05
-------	--------	----	---------------

318 i	Petrol	105	09/01 → 02/05
-------	--------	-----	---------------

318 i	Petrol	87	02/98 → 09/01
-------	--------	----	---------------

320 i	Petrol	110	03/98 → 09/00
-------	--------	-----	---------------

320 i	Petrol	125	09/00 → 02/05
-------	--------	-----	---------------

323 i	Petrol	125	03/98 → 09/00
-------	--------	-----	---------------

325 i	Petrol	141	09/00 → 02/05
-------	--------	-----	---------------

325 xi	Petrol	141	09/00 → 02/05
--------	--------	-----	---------------

328 i	Petrol	142	02/98 → 06/00
-------	--------	-----	---------------

330 i	Petrol	170	06/00 → 02/05
-------	--------	-----	---------------

330 xi	Petrol	170	06/00 → 02/05
--------	--------	-----	---------------

3 Cabriolet (E46)

318 Ci	Petrol	105	09/01 →
--------	--------	-----	---------

320 Ci	Petrol	125	09/00 →
--------	--------	-----	---------

323 Ci	Petrol	125	04/00 → 09/00
--------	--------	-----	---------------

325 Ci	Petrol	141	09/00 →
--------	--------	-----	---------

330 Ci	Petrol	170	06/00 →
--------	--------	-----	---------

ESS0082A

BMW
3 Compact (E46)

316 ti	Petrol	85	06/01 → 02/05
318 ti	Petrol	105	09/01 → 02/05
325 ti	Petrol	141	06/01 → 02/05

3 Coupé (E46)

316 Ci	Petrol	77	04/00 →
318 Ci	Petrol	105	09/01 →
318 Ci	Petrol	87	11/99 → 09/01
320 Ci	Petrol	110	08/99 → 09/00
320 Ci	Petrol	125	09/00 →
323 Ci	Petrol	125	04/99 → 09/00
325 Ci	Petrol	141	09/00 →
328 Ci	Petrol	142	04/99 → 06/00
330 xi	Petrol	170	06/00 →

3 Touring (E46)

316 i	Petrol	85	03/02 → 02/05
318 i	Petrol	105	09/01 → 02/05
318 i	Petrol	87	10/99 → 09/01
320 i	Petrol	110	10/99 → 09/00
320 i	Petrol	125	09/00 → 02/05
325 i	Petrol	141	09/00 → 02/05
325 xi	Petrol	141	09/00 → 02/05
328 i	Petrol	142	10/99 → 06/00
330 i	Petrol	170	06/00 → 02/05
330 xi	Petrol	170	06/00 → 02/05

ESS0083A

J1 **POMPA CARBURANTE KIT**
PB/KIT **FUEL PUMP KIT**

FORD
ESCORT V (GAL)

1.6	Petrol	77	07/90 → 12/92
1.8 16V XR3i	Petrol	77	02/92 → 12/92
1.8 16V XR3i	Petrol	96	02/92 → 12/92

ESS0083A

FORD
ESCORT V (GAL)

RS 2000	Petrol	110	05/91 → 12/92
---------	--------	-----	---------------

ESCORT V Cabriolet (ALL)

1.6	Petrol	77	07/90 → 12/92
1.8 16V XR3i	Petrol	77	02/92 → 12/92
1.8 16V XR3i	Petrol	96	02/92 → 12/92

ESCORT V Station wagon (GAL, AVL)

1.6	Petrol	77	07/90 → 09/92
1.8 16V	Petrol	77	02/92 → 12/92

ESCORT VI (GAL)

RS Cosworth 4x4	Petrol	162	09/92 → 01/95
-----------------	--------	-----	---------------

MONDEO I (GBP)

2.0 i 16V	Petrol	100	02/93 → 08/96
2.0 i 16V 4x4	Petrol	97	12/94 → 08/96

MONDEO I Station wagon (BNP)

2.0 i 16V	Petrol	100	04/93 → 08/96
2.0 i 16V 4x4	Petrol	100	04/93 → 08/96
2.0 i 16V 4x4	Petrol	97	12/94 → 08/96

MONDEO I Tre volumi (GBP)

2.0 i 16V	Petrol	100	02/93 → 08/96
2.0 i 16V 4x4	Petrol	97	12/94 → 08/96

ORION III (GAL)

1.6 i	Petrol	77	07/90 → 09/92
-------	--------	----	---------------

SIERRA (GBG, GB4)

2.0 4x4	Petrol	92	01/90 → 02/93
2.0 i	Petrol	92	01/90 → 02/93
2.9 4x4	Petrol	107	08/88 → 02/93
2.9 4x4	Petrol	110	08/88 → 02/93

SIERRA Station wagon (BNG)

2.0 4x4	Petrol	88	02/90 → 02/93
2.0 4x4	Petrol	92	05/89 → 02/93
2.9 4x4	Petrol	110	08/88 → 02/93

SAAB
900 I Combi Coupe

2.1 -16	Petrol	100	09/90 → 07/93
---------	--------	-----	---------------

ESS0084A

J1
POMPA CARBURANTE KIT
PB/KIT FUEL PUMP KIT



SAAB

900 I Cabriolet

2.0 -16	Petrol	93	01/90 → 06/94
---------	--------	----	---------------

900 I Combi Coupe

2.0 -16	Petrol	93	01/89 → 08/92
---------	--------	----	---------------

900 II

2.0 -16 Turbo	Petrol	136	07/93 → 02/98
---------------	--------	-----	---------------

2.0 i	Petrol	96	08/94 → 02/98
-------	--------	----	---------------

2.3 -16	Petrol	110	07/93 → 02/98
---------	--------	-----	---------------

2.5 -24 V6	Petrol	125	07/93 → 02/98
------------	--------	-----	---------------

900 II Cabriolet

2.0 -16 Turbo	Petrol	136	12/93 → 02/98
---------------	--------	-----	---------------

2.0 i	Petrol	96	12/93 → 02/98
-------	--------	----	---------------

2.3 -16	Petrol	110	12/93 → 02/98
---------	--------	-----	---------------

2.5 -24 V6	Petrol	125	12/93 → 02/98
------------	--------	-----	---------------

900 II Coupé

2.0 i	Petrol	98	12/93 → 07/94
-------	--------	----	---------------

9000

2.0 -16 CD	Petrol	96	09/93 → 12/98
------------	--------	----	---------------

2.0 -16 CD	Petrol	110	09/93 → 12/98
------------	--------	-----	---------------

2.0 -16 Turbo CD	Petrol	108	09/92 → 12/98
------------------	--------	-----	---------------

2.3 -16 CD Turbo	Petrol	147	07/90 → 12/98
------------------	--------	-----	---------------

2.3 -16 CDE	Petrol	108	09/93 → 12/98
-------------	--------	-----	---------------

2.3 -16 CDE Eco-Power	Petrol	125	09/93 → 12/98
-----------------------	--------	-----	---------------

2.3 -16 Turbo	Petrol	143	09/90 → 08/93
---------------	--------	-----	---------------

3.0 -24 V6 CD/ CDE	Petrol	155	07/94 → 12/98
--------------------	--------	-----	---------------

9000 2 volumi /Coda spiovente

2.0 -16 CS	Petrol	96	09/93 → 12/98
------------	--------	----	---------------

2.0 -16 ND Turbo	Petrol	110	09/93 → 12/98
------------------	--------	-----	---------------

2.3 -16 Aero CS	Petrol	162	02/93 → 12/98
-----------------	--------	-----	---------------

2.3 -16 Aero CS	Petrol	165	02/93 → 12/98
-----------------	--------	-----	---------------

2.3 -16 CSE	Petrol	108	09/93 → 12/98
-------------	--------	-----	---------------

ESS0084A



SAAB

9000 2 volumi /Coda spiovente

2.3 -16 CSE Eco Power	Petrol	125	09/93 → 12/98
-----------------------	--------	-----	---------------

2.3 -16 Turbo	Petrol	143	09/90 → 12/98
---------------	--------	-----	---------------

2.3 -16 Turbo CSE	Petrol	147	09/93 → 12/98
-------------------	--------	-----	---------------

3.0 -24 V6 CS/ CSE	Petrol	155	07/94 → 12/98
--------------------	--------	-----	---------------

9-3 (YS3D)

2.0 i	Petrol	96	02/98 → 09/02
-------	--------	----	---------------

2.0 SE Turbo	Petrol	147	02/98 → 09/02
--------------	--------	-----	---------------

2.0 Turbo	Petrol	151	10/99 → 09/02
-----------	--------	-----	---------------

2.0 Turbo	Petrol	113	10/98 → 09/02
-----------	--------	-----	---------------

2.0 Turbo	Petrol	136	02/98 → 09/02
-----------	--------	-----	---------------

2.3 i	Petrol	110	02/98 → 09/02
-------	--------	-----	---------------

2.3 Turbo	Petrol	165	10/98 → 09/02
-----------	--------	-----	---------------

9-3 Cabriolet (YS3D)

2.0 i	Petrol	96	02/98 → 08/03
-------	--------	----	---------------

2.0 SE Turbo	Petrol	147	02/98 → 08/03
--------------	--------	-----	---------------

2.0 Turbo	Petrol	136	02/98 → 08/03
-----------	--------	-----	---------------

2.0 Turbo	Petrol	113	10/98 → 08/03
-----------	--------	-----	---------------

2.0 Turbo	Petrol	151	10/99 → 08/03
-----------	--------	-----	---------------

2.3 i	Petrol	110	02/98 → 08/03
-------	--------	-----	---------------

2.3 Turbo	Petrol	165	10/99 → 08/03
-----------	--------	-----	---------------

9-5 (YS3E)

2.0 T	Petrol	110	09/97 →
-------	--------	-----	---------

2.3 t	Petrol	125	09/97 →
-------	--------	-----	---------

3.0 V6t	Petrol	147	01/98 →
---------	--------	-----	---------

9-5 Station wagon (YS3E)

2.0 T	Petrol	110	10/98 →
-------	--------	-----	---------

2.0 T	Petrol	141	10/98 →
-------	--------	-----	---------

2.3 t	Petrol	125	10/98 →
-------	--------	-----	---------

3.0 V6t	Petrol	147	10/98 →
---------	--------	-----	---------

ESS0089A
J1
POMPA CARBURANTE KIT
PB/KIT FUEL PUMP KIT

OPEL
ASTRA G Station wagon (F35_)

1.6	Petrol	76	12/02 → 07/09
-----	--------	----	---------------

COMBO Cassone / Furgonato / Promiscuo

1.6 CNG 16V	Petrol/ CNG	69	06/06 →
-------------	----------------	----	---------

CORSA C (F08, F68)

1.0	Petrol	44	06/03 → 12/09
-----	--------	----	---------------

1.0	Petrol	43	09/00 → 12/09
-----	--------	----	---------------

1.2	Petrol	55	09/00 → 12/09
-----	--------	----	---------------

1.2 Twinport	Petrol	59	07/04 → 12/09
--------------	--------	----	---------------

1.4	Petrol	66	09/00 → 12/09
-----	--------	----	---------------

1.4 Twinport	Petrol	66	06/03 → 12/09
--------------	--------	----	---------------

1.8	Petrol	92	09/00 → 12/09
-----	--------	----	---------------

SIGNUM

1.8	Petrol	90	05/03 →
-----	--------	----	---------

2.0 Turbo	Petrol	129	05/03 →
-----------	--------	-----	---------

2.2 direct	Petrol	114	05/03 →
------------	--------	-----	---------

3.2 V6	Petrol	155	05/03 →
--------	--------	-----	---------

TIGRA TwinTop

1.4	Petrol	66	06/04 →
-----	--------	----	---------

1.8	Petrol	92	06/04 →
-----	--------	----	---------

VECTRA C

1.6	Petrol	77	01/06 →
-----	--------	----	---------

1.6 16V	Petrol	74	06/04 →
---------	--------	----	---------

1.8	Petrol	81	04/02 →
-----	--------	----	---------

1.8 16V	Petrol	90	04/02 →
---------	--------	----	---------

2.0 16V Turbo	Petrol	129	03/03 →
---------------	--------	-----	---------

2.2 direct	Petrol	114	10/03 →
------------	--------	-----	---------

3.2 V6	Petrol	155	08/02 →
--------	--------	-----	---------

SAAB
9-3 Station wagon

1.8 i	Petrol	90	03/05 →
-------	--------	----	---------

2.0 T	Petrol	110	03/05 →
-------	--------	-----	---------

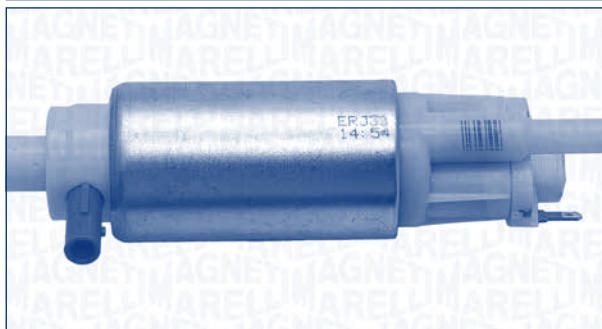
ESS0091A
J1
POMPA CARBURANTE KIT
PB/KIT FUEL PUMP KIT

PEUGEOT
306 (7B, N3, N5)

1.8 16V	Petrol	81	03/97 → 05/01
---------	--------	----	---------------

2.0	Petrol	97	03/97 → 05/01
-----	--------	----	---------------

306 2 volumi /Coda spiovente (7A, 7C, N3, N5)

1.8 16V	Petrol	81	03/97 → 05/01
---------	--------	----	---------------

2.0 16V	Petrol	97	03/97 → 05/01
---------	--------	----	---------------

306 Break (7E, N3, N5)

1.4	Petrol	55	03/97 → 04/02
-----	--------	----	---------------

1.6	Petrol	65	03/97 → 10/00
-----	--------	----	---------------

1.6	Petrol	72	10/00 → 04/02
-----	--------	----	---------------

1.8	Petrol	74	03/97 → 04/02
-----	--------	----	---------------

1.8 16V	Petrol	81	03/97 → 04/02
---------	--------	----	---------------

2.0	Petrol	97	03/97 → 04/02
-----	--------	----	---------------

ESS273
J1
POMPA CARBURANTE KIT
PB/KIT FUEL PUMP KIT

CITROËN
SAXO (S0, S1)

1.0 X	Petrol	37	05/98 → 06/03	ENGINE: TU9M
-------	--------	----	---------------	--------------

1.1 X,SX	Petrol	44	05/96 → 09/03	ENGINE: TU1M
----------	--------	----	---------------	--------------

ESS273



PEUGEOT

106 I (1A, 1C)

1.0	Petrol	33	09/91 → 04/96	ENGINE: TU9M
1.0	Petrol	37	09/91 → 04/96	ENGINE: TU9M
1.1	Petrol	44	09/91 → 04/96	ENGINE: TU1M
1.4	Petrol	69	09/91 → 04/96	
1.4	Petrol	55	09/91 → 04/96	

ESS515

**J1
PB/KIT** **POMPA CARBURANTE KIT
FUEL PUMP KIT**

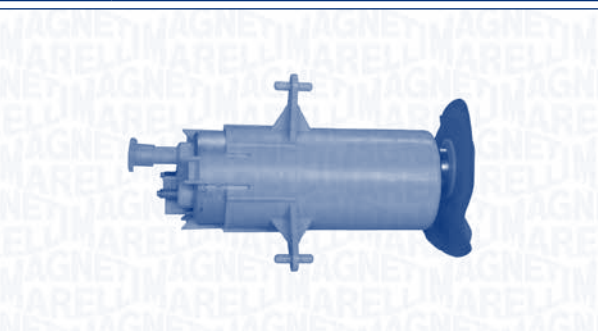

AUDI

A4 (8D2, B5)

1.6	Petrol	74	12/94 → 10/00	ENGINE: ADP-AHL-ANA-ARM
1.6	Petrol	75	07/00 → 11/00	ENGINE: ALZ
1.8	Petrol	85	04/95 → 11/00	ENGINE: AFY
1.8	Petrol	92	01/95 → 11/00	ENGINE: ADR-APT-ARG-AVV
1.8	Petrol	95	01/95 → 11/00	ENGINE: ADR-APT-ARG-AVV
1.8 quattro	Petrol	85	07/95 → 11/00	ENGINE: AFY
1.8 T	Petrol	110	01/95 → 11/00	ENGINE: AEB-ANB-APU-ARK-AWT
1.8 T	Petrol	132	12/97 → 11/00	ENGINE: AJL
1.8 T quattro	Petrol	110	01/95 → 11/00	ENGINE: AEB-ANB-APU-ARK-AWT
1.8 T quattro	Petrol	132	12/97 → 11/00	ENGINE: AJL
2.4	Petrol	121	03/97 → 11/00	ENGINE: AGA-ALF-AML-APS-ARJ
2.4 quattro	Petrol	120	08/97 → 11/00	ENGINE: AGA-ALF-AML-APS-ARJ

ESS515



AUDI

A4 (8D2, B5)

2.6	Petrol	110	01/95 → 11/00	ENGINE: ABC
2.6 quattro	Petrol	110	01/95 → 11/00	ENGINE: ABC
2.8	Petrol	128	09/95 → 07/97	ENGINE: AAH
2.8	Petrol	142	10/96 → 11/00	ENGINE: ACK-ALG-AMX-APR-AQD
2.8 quattro	Petrol	128	01/95 → 07/97	ENGINE: AAH
2.8 quattro	Petrol	142	10/96 → 08/01	ENGINE: ACK-ALG-AMX-APR-AQD
S4 quattro	Petrol	195	09/97 → 09/01	ENGINE: AGB

A4 Avant (8D5, B5)

1.6	Petrol	74	02/96 → 09/01	ENGINE: ADP-AHL-ANA-ARM
1.6	Petrol	75	07/00 → 09/01	ENGINE: ALZ
1.8	Petrol	85	07/95 → 09/01	ENGINE: AFY
1.8	Petrol	92	02/96 → 09/01	ENGINE: ADR-APT-ARG-AVV
1.8 quattro	Petrol	85	07/95 → 09/01	ENGINE: AFY
1.8 quattro	Petrol	92	01/96 → 09/01	ENGINE: ADR-APT-ARG
1.8 T	Petrol	132	12/97 → 09/01	ENGINE: AEB-ANB-APU
1.8 T quattro	Petrol	110	01/96 → 09/01	ENGINE: AEB-ANB-APU-ARK-AWT
2.4	Petrol	120	08/97 → 09/01	ENGINE: AJG
2.4	Petrol	121	03/97 → 09/01	ENGINE: AGA-ALF-AML-APS-ARJ
2.4 quattro	Petrol	121	03/97 → 09/01	ENGINE: AGA-ALF-AML-APS-ARJ
2.6	Petrol	110	02/96 → 09/01	ENGINE: ABC
2.6 quattro	Petrol	110	01/96 → 09/01	ENGINE: ABC
2.8	Petrol	128	03/96 → 09/96	ENGINE: AAH
2.8	Petrol	142	10/96 → 09/01	ENGINE: ACK-ALG-AMX-APR-AQD
2.8 quattro	Petrol	128	01/96 → 09/96	ENGINE: AAH
2.8 quattro	Petrol	142	10/96 → 09/01	ENGINE: ACK-ALG-AMX-APR-AQD

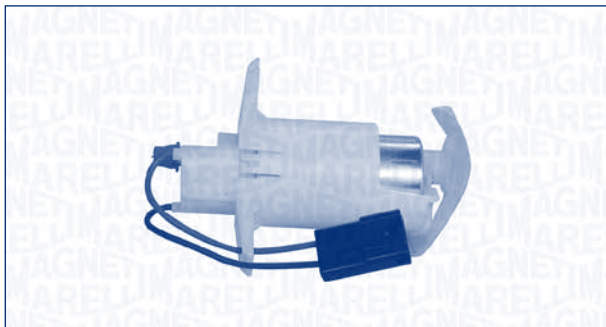
ESS520
J1 **POMPA CARBURANTE KIT**
PB/KIT **FUEL PUMP KIT**

MERCEDES-BENZ
CLASSE M (W163)

ML 230 (163.136)	Petrol	110	02/98 → 06/05
ML 320 (163.154)	Petrol	160	02/98 → 08/02
ML 350	Petrol	173	02/03 → 06/05
ML 350 (163.157)	Petrol	180	08/02 → 06/05
ML 430 (163.172)	Petrol	200	02/98 → 06/05
ML 500 (163.175)	Petrol	215	09/01 → 06/05

ESS525
J1 **POMPA CARBURANTE KIT**
PB/KIT **FUEL PUMP KIT**

OPEL
ASTRA F (56_, 57_)

1.4 i	Petrol	44	09/91 → 02/98
1.6	Petrol	55	09/95 → 02/98
1.6 i	Petrol	55	03/92 → 08/94
1.6 i	Petrol	52	05/93 → 02/96
1.6 i	Petrol	55	08/96 → 08/97
1.8 i	Petrol	66	03/92 → 02/98

ASTRA F 2 volumi /Coda spiovente (53_, 54_, 58_, 59_)

1.4 i	Petrol	44	03/92 → 01/98
1.6	Petrol	55	09/97 → 01/98
1.6 i	Petrol	52	05/93 → 02/96

ESS525

OPEL
ASTRA F 2 volumi /Coda spiovente (53_, 54_, 58_, 59_)

1.6 i	Petrol	55	08/94 → 09/95
1.8 i	Petrol	66	09/91 → 01/98

ASTRA F Cabriolet (53_B)

1.6 i	Petrol	52	03/93 → 02/96
1.6 i	Petrol	55	01/96 → 08/97

ASTRA F CLASSIC 2 volumi /Coda spiovente

1.4 i	Petrol	44	01/98 → 08/00
1.6 i	Petrol	55	01/98 → 08/00

ASTRA F CLASSIC Station wagon

1.4 i	Petrol	44	01/98 → 08/00
1.6 i	Petrol	55	01/98 → 08/00

ASTRA F CLASSIC Tre volumi

1.4 i	Petrol	44	01/98 → 08/00
1.6 i	Petrol	55	01/98 → 08/00

ASTRA F Station wagon (51_, 52_)

1.4 i	Petrol	44	09/91 → 01/98
1.6	Petrol	55	09/95 → 01/98
1.6 i	Petrol	52	05/93 → 02/96
1.6 i	Petrol	55	08/94 → 09/95
1.8 i	Petrol	66	09/91 → 01/98

ASTRA F Van (55_)

1.4 i	Petrol	44	10/91 → 02/98
1.6 i	Petrol	55	10/91 → 04/93
1.6 i	Petrol	52	02/93 → 02/96

ASTRA G 2 volumi /Coda spiovente (F48_, F08_)

1.6	Petrol	55	02/98 → 09/00
-----	--------	----	---------------

ASTRA G Furgonato (F70)

1.6	Petrol	55	01/99 → 09/00
-----	--------	----	---------------

ASTRA G Station wagon (F35_)

1.6	Petrol	55	02/98 → 09/00
-----	--------	----	---------------

ASTRA G Tre volumi (F69_)

1.6	Petrol	55	09/98 → 08/00
-----	--------	----	---------------

COMBO (71_)

1.2	Petrol	33	09/94 → 10/01
1.4	Petrol	44	09/94 → 10/01

CORSA A 2 volumi /Coda spiovente (93_, 94_, 98_, 99_)

1.4 i	Petrol	44	01/90 → 03/93
1.4 i	Petrol	40	01/90 → 03/93
1.6 GSI	Petrol	55	04/89 → 09/92

CORSA A TR (91_, 92_, 96_, 97_)

1.2 i	Petrol	33	09/90 → 03/93
1.4 i	Petrol	44	01/90 → 03/93

ESS525



OPEL

CORSA B (73_, 78_, 79_)

1.2 i	Petrol	33	03/93 → 09/00
1.2 i	Petrol	33	03/93 → 09/00
1.4 i	Petrol	44	03/93 → 09/00

CORSA B Furgonato (73_)

1.4 i	Petrol	44	08/99 → 09/00
-------	--------	----	---------------

KADETT E Combo (38_, 48_)

1.6 i	Petrol	55	08/91 → 07/94
-------	--------	----	---------------

KADETT E Furgonato (37_, 47_)

1.6 i	Petrol	55	08/89 → 08/93
-------	--------	----	---------------

VECTRA A (86_, 87_)

1.6 i	Petrol	55	09/88 → 10/90
1.6 i	Petrol	52	09/93 → 08/95
1.6 i	Petrol	55	09/93 → 08/95
1.8 i Cat.	Petrol	66	03/90 → 11/95

VECTRA A 2 volumi /Coda spiovente (88_, 89_)

1.6 i	Petrol	55	09/93 → 08/95
1.6 i Cat.	Petrol	55	09/88 → 08/95
1.8 i Cat.	Petrol	66	03/90 → 11/95

VAUXHALL

ASTRA Mk III (F)

1.4 i	Petrol	44	04/92 → 02/98
-------	--------	----	---------------

ASTRA Mk III (F) 2 volumi /Coda spiovente

1.4 i	Petrol	44	09/91 → 02/98
1.6 i	Petrol	55	09/91 → 02/98

ASTRA Mk III (F) Station wagon

1.4 i	Petrol	44	09/91 → 02/98
1.6 i	Petrol	55	09/91 → 02/98

ASTRA Mk IV (G) 2 volumi /Coda spiovente

1.6	Petrol	55	02/98 → 09/00
-----	--------	----	---------------

ASTRA Mk IV (G) Station wagon

1.6	Petrol	55	03/98 → 09/00
-----	--------	----	---------------

ASTRA Mk IV (G) Tre volumi

1.6	Petrol	55	09/98 → 09/00
-----	--------	----	---------------

ASTRAVAN Mk III (F)

1.4 i	Petrol	44	09/91 → 10/94
1.6 i	Petrol	55	09/91 → 02/98

ASTRAVAN Mk IV (G)

1.6 i	Petrol	55	08/98 → 09/00
-------	--------	----	---------------

CAVALIER Mk III (87)

1.6 i	Petrol	55	09/88 → 11/95
1.6 i	Petrol	52	09/94 → 11/95
1.8	Petrol	66	09/88 → 10/92
1.8 i Cat.	Petrol	66	03/90 → 11/95

ESS525



VAUXHALL

CAVALIER Mk III 2 volumi /Coda spiovente

1.6 i	Petrol	55	09/88 → 11/95
1.6 i	Petrol	52	09/94 → 11/95
1.8	Petrol	66	09/88 → 10/90
1.8 i Cat.	Petrol	66	03/90 → 11/95

CORSAVAN Mk I (B)

1.4 i	Petrol	44	09/94 → 08/00
-------	--------	----	---------------

SUA484

J1 POMPA CARBURANTE KIT
PB/KIT FUEL PUMP KIT

DAEWOO

ESPERO (KLEJ)

1.8	Petrol	66	02/95 → 09/99
1.8	Petrol	70	02/95 → 06/99
2.0	Petrol	77	02/95 → 06/99

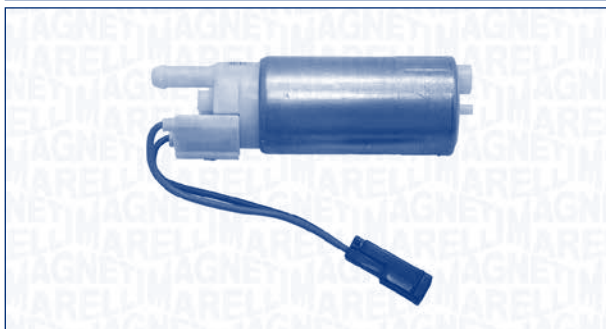
SUA486
J1
POMPA CARBURANTE KIT
PB/KIT FUEL PUMP KIT

FORD
MONDEO I (GBP)

1.6 i 16V	Petrol	65	07/94 → 08/96	ENGINE: EFIZETECZH16
1.6 i 16V	Petrol	66	02/93 → 08/96	ENGINE: EFIZETECZH16
1.8 i 16V	Petrol	82	07/94 → 08/96	ENGINE: EFIZETECZH18
1.8 i 16V	Petrol	85	02/93 → 08/96	ENGINE: EFIZETECZH18
1.8 i 16V 4x4	Petrol	85	02/93 → 08/96	ENGINE: EFIZETECZH18
2.0 i 16V	Petrol	100	02/93 → 08/96	ENGINE: EFIZETECZH20
2.0 i 16V	Petrol	97	12/94 → 08/96	ENGINE: EFIZETECZH20
2.0 i 16V 4x4	Petrol	97	12/94 → 08/96	ENGINE: EFIZETECZH20
2.5 i 24V	Petrol	125	07/94 → 08/96	ENGINE: EFIV624VDURANTEC

MONDEO I Station wagon (BNP)

1.6 i 16V	Petrol	65	07/94 → 08/96	ENGINE: EFIZETECZH16
1.6 i 16V	Petrol	66	04/93 → 08/96	ENGINE: EFIZETECZH16
1.8 i 16V	Petrol	82	07/94 → 08/96	ENGINE: EFIZETECZH18
1.8 i 16V	Petrol	85	04/93 → 08/96	ENGINE: EFIZETECZH18
1.8 i 16V 4x4	Petrol	85	04/93 → 08/96	ENGINE: EFIZETECZH18
2.0 i 16V	Petrol	100	04/93 → 08/96	ENGINE: EFIZETECZH20
2.0 i 16V	Petrol	97	01/93 → 08/96	ENGINE: EFIZETECZH20

SUA486

FORD
MONDEO I Station wagon (BNP)

2.0 i 16V 4x4	Petrol	100	04/93 → 08/96	ENGINE: EFIZETECZH20
2.0 i 16V 4x4	Petrol	97	12/94 → 08/96	ENGINE: EFIZETECZH20
2.5 i 24V	Petrol	125	07/94 → 08/96	ENGINE: EFIV624VDURANTEC

MONDEO I Tre volumi (GBP)

1.6 i 16V	Petrol	65	07/94 → 08/96	ENGINE: EFIZETECZH16
1.6 i 16V	Petrol	66	02/93 → 08/96	ENGINE: EFIZETECZH16
1.8 i 16V	Petrol	82	01/94 → 08/96	ENGINE: EFIZETECZH18
1.8 i 16V	Petrol	85	02/93 → 08/96	ENGINE: EFIZETECZH18
2.0 i 16V	Petrol	100	02/93 → 08/96	ENGINE: EFIZETECZH20
2.0 i 16V 4x4	Petrol	97	12/94 → 08/96	ENGINE: EFIZETECZH20
2.5 i 24V	Petrol	125	07/94 → 08/96	ENGINE: EFIV624VDURANTEC

SUA487
J1
POMPA CARBURANTE KIT
PB/KIT FUEL PUMP KIT

FORD
ESCORT VII (GAL, AAL, ABL)

1.3	Petrol	44	05/97 → 10/98	ENGINE: EFIHCSBL
1.4	Petrol	55	05/97 → 10/98	ENGINE: EFICVHPTEHL
1.6 16V	Petrol	66	05/97 → 10/98	ENGINE: EFIZETECZH
1.6 16V 4x4	Petrol	66	05/97 → 10/98	ENGINE: EFIZETECZH

SUA487



KW



FORD

ESCORT VII (GAL, AAL, ABL)

1.8 16V	Petrol	85	05/97 → 10/98	ENGINE: EFIZETECZH18
---------	--------	----	---------------	-------------------------

ESCORT VII Cabriolet (ALL)

1.4	Petrol	55	05/97 → 08/98	ENGINE: EFICVHPTEHL14
-----	--------	----	---------------	--------------------------

1.6 16V XR3i	Petrol	66	05/97 → 08/99	ENGINE: EFIZETECZH18
--------------	--------	----	---------------	-------------------------

1.8 16V XR3i	Petrol	77	05/97 → 08/98	ENGINE: EFIZETECZH
--------------	--------	----	---------------	--------------------

1.8 16V XR3i	Petrol	85	05/97 → 08/98	ENGINE: EFIZETECZH
--------------	--------	----	---------------	--------------------

1.8 16V XR3i	Petrol	96	05/97 → 08/99	ENGINE: EFIZETECZH
--------------	--------	----	---------------	--------------------

ESCORT VII Station wagon (GAL, ANL)

1.3	Petrol	44	05/97 → 10/98	ENGINE: EFIHCSBL13
-----	--------	----	---------------	--------------------

1.4	Petrol	55	05/97 → 02/99	ENGINE: EFICVHPTEHL14
-----	--------	----	---------------	--------------------------

1.6 16V	Petrol	66	05/97 → 02/99	ENGINE: EFIZETECZH18
---------	--------	----	---------------	-------------------------

1.8 16V	Petrol	85	05/97 → 02/99	ENGINE: EFIZETECZH18
---------	--------	----	---------------	-------------------------

ESCORT VII Tre volumi (GAL, AFL)

1.3	Petrol	44	05/97 → 02/99	ENGINE: EFIHCSBL13
-----	--------	----	---------------	--------------------

1.4	Petrol	55	05/97 → 02/99	ENGINE: EFICVHPTEHL14
-----	--------	----	---------------	--------------------------

1.6 i 16V	Petrol	66	05/97 → 02/99	ENGINE: EFIZETECZH16
-----------	--------	----	---------------	-------------------------

1.8 16V	Petrol	85	05/97 → 02/99	ENGINE: EFIZETECZH18
---------	--------	----	---------------	-------------------------

FIESTA III (GFJ)

1.0	Petrol	33	04/93 → 12/95	ENGINE: EFIHCSBL10
-----	--------	----	---------------	--------------------

1.4 Cat.	Petrol	54	04/93 → 12/95	ENGINE: EFICVHHL14
----------	--------	----	---------------	--------------------

1.6	Petrol	65	04/93 → 01/94	ENGINE: EFIZETECZH16
-----	--------	----	---------------	-------------------------

1.6 i 16V	Petrol	65	01/94 → 12/95	ENGINE: EFIZETECZH16
-----------	--------	----	---------------	-------------------------

1.8 16V	Petrol	77	02/92 → 12/95	ENGINE: EFIZETECZH18
---------	--------	----	---------------	-------------------------

1.8 XR2i 16V	Petrol	96	02/92 → 12/95	ENGINE: EFIZETECZH18
--------------	--------	----	---------------	-------------------------

FIESTA IV (JA_, JB_)

1.0 i	Petrol	38	02/97 → 09/99	ENGINE: EFIHCSBL10
-------	--------	----	---------------	--------------------

1.0 i	Petrol	48	09/99 → 01/02	ENGINE: EFIHCSBL10
-------	--------	----	---------------	--------------------

SUA487



KW



FORD

FIESTA IV (JA_, JB_)

1.25 i 16V	Petrol	55	08/95 → 01/02	ENGINE: EFIZETECZH12
------------	--------	----	---------------	-------------------------

1.3 i	Petrol	37	08/95 → 01/02	ENGINE: EFIHCSBL13
-------	--------	----	---------------	--------------------

1.3 i	Petrol	44	08/95 → 01/02	ENGINE: EFIHCSBL13
-------	--------	----	---------------	--------------------

1.6 16V Sport	Petrol	76	02/00 → 01/02	ENGINE: EFIZETECZH16
---------------	--------	----	---------------	-------------------------

KA (RB_)

1.3 i	Petrol	36	06/98 → 11/08	ENGINE: EFIHCS
-------	--------	----	---------------	----------------

PUMA (EC_)

1.4 16V	Petrol	66	11/97 → 10/00	
---------	--------	----	---------------	--

ST 160	Petrol	118	06/99 → 06/02	ENGINE: EFIZETECZH17
--------	--------	-----	---------------	-------------------------

TRANSIT Furgonato (E_ _)

2.0 (EAL, EAS)	Petrol	84	06/94 → 03/00	ENGINE: EFIDOHCDL20
----------------	--------	----	---------------	------------------------

TRANSIT Pianale piatto/Telaio (E_ _)

2.0 (EME/L/S, ENE/L/S)	Petrol	84	08/94 → 03/00	ENGINE: EFIDOHCDL20
---------------------------	--------	----	---------------	------------------------

SUA507

J1	POMPA CARBURANTE KIT
PB/KIT	FUEL PUMP KIT



KW



OPEL

ASTRA G 2 volumi /Coda spiovente (F48_, F08_)

1.2 16V	Petrol	55	09/00 → 01/05	
---------	--------	----	---------------	--

1.2 16V	Petrol	48	02/98 → 09/00	
---------	--------	----	---------------	--

1.4 16V	Petrol	66	02/98 → 01/05	
---------	--------	----	---------------	--

1.6	Petrol	62	09/00 → 01/05	
-----	--------	----	---------------	--

2.0 16V OPC	Petrol	118	11/99 → 09/02	
-------------	--------	-----	---------------	--

SUA507

OPEL
CORSA B (73_, 78_, 79_)

1.2 i 16V	Petrol	48	03/98 → 09/00	
1.4 i 16V	Petrol	63	08/97 → 09/00	
1.4 i 16V	Petrol	66	09/94 → 09/00	
1.4 Si	Petrol	60	03/93 → 09/00	
1.6 GSi 16V	Petrol	80	03/93 → 09/00	
1.6 i 16V	Petrol	74	08/97 → 09/00	
1.6 i 16V	Petrol	78	09/94 → 09/00	

TIGRA (95_)

1.4 16V	Petrol	66	07/94 → 12/00	
1.6 16V	Petrol	74	08/97 → 08/98	
1.6 16V	Petrol	78	07/94 → 08/98	

Tavole di comparazione OE/IAM
OE/IAM cross reference guide
Gegenüberstellung OE/IAM
Table de correspondance OE/IAM
Tabla de equivalencias OE/IAM
Tabela de equivalências OE/IAM
Πίνακας αντιστοιχιών OE/IAM
Tabela porównawcza OE/IAM
Кросс-таблица с OE/IAM номерами
OE/IAM çapraz referans tablosu



OE/IAM

LONG

SHORT

GRUPPO A - GROUP A

A3 | CENTRALINA CONTROLLO CAMBIO
TRANSMISSION CONTROL UNIT

FCA

51806811 216200012400 **CFC328F.02**

MAGNETI MARELLI

CFC328F02 216200012400 **CFC328F.02**

MEAT & DORIA

70086 216200012400 **CFC328F.02**

SIDAT

243186 216200012400 **CFC328F.02**
A1 | CENTRALINA CONTROLLO MOTORE
ENGINE CONTROL UNIT

FCA

46761567 216160036006 **IAW49F.B2**46769432 216160034003 **IAW49F.B1**46820324 216160050706 **IAW59F.M7/6**46820325 216160044407 **IAW59F.M1/2**46823490 216160045702 **IAW4EF.B3**46826655 216160046102 **IAW4EF.B5**51757344 217160000203 **MJD6JFP1**51759028 216160105403 **IAW5NF.T9/1**51775008 217160000505 **MJD6JFS1**51775009 217160000605 **MJD6JFS3**51779336 217160004403 **MJD6F3D2**51784559 217160002004 **MJD6F3M3**51786118 216160129501 **IAW4AF.G3/1**51788361 216160057904 **IAW5NF.S5/1**51788362 216160061904 **IAW5NF.S8/2**51793104 216160109809 **IAW5SF3.M1/4**51793106 216160062708 **IAW4AF.M9/2**51793107 216160106905 **IAW5AF.P4/4**51793108 216160107206 **IAW5AF.PE/2**51793109 216160062806 **IAW4AF.M8/1**51793110 216160107306 **IAW5AF.N8/4**51793111 216160112602 **IAW 4AF.S3/2**51793113 216160112502 **IAW4AF.SS/2**51793116 216100142854 **IAW4AF.S2/3**51795235 217160020600 **MJD6F3Y2**51795237 217160009203 **MJD6JFM5**51796238 217160015200 **MJD6F3D5**51796242 217160011505 **MJD6F3PB**51796243 217160001604 **MJD6F3P5**51796244 217160008604 **MJD6F3D4**

OE/IAM

LONG

SHORT

A1 | CENTRALINA CONTROLLO MOTORE
ENGINE CONTROL UNIT

FCA

51798639 216160065106 **IAW5AF.P3/3**51798644 216160121501 **IAW5SF3.M9**51798646 216160137101 **IAW5AF.SK**51798647 216160129401 **IAW4EF.G4/1**51798651 216160109908 **IAW5SF3.M2/3**51804525 216160129501 **IAW4AF.G3/1**51804530 216160130202 **IAW5SF.MD**51805371 217160020000 **MJD6F3D4/1**51805376 217160008704 **MJD6F3A5**51806498 217160001908 **MJD6F3P7**51806501 217160008800 **MJD6F3P6**51811060 216160144402 **IAW5SF8.MR**51812866 217160011301 **MJD6F3H1**51818292 217160017400 **MJD6F3B2**51819335 216160106905 **IAW5AF.P4/4**51819336 216160107306 **IAW5AF.N8/4**51819338 216160062708 **IAW4AF.M9/2**51819346 216160144402 **IAW5SF8.MR**51819351 216160109809 **IAW5SF3.M1/4**51825023 217160019001 **MJD6F3Y5**51825024 217160024000 **MJD6F3P7/1**51825027 217160024300 **MJD6F3P8**51827440 216160109908 **IAW5SF3.M2/3**51827446 216160065106 **IAW5AF.P3/3**51829540 217160012703 **MJD6F3B1**51832289 217160023001 **MJD6F3M5**51832290 217160024601 **MJD6F3PB/1**51832292 217160022902 **MJD6F3M3/3**51832294 217160024501 **MJD6F3P5/1**51839150 217160019202 **MJD6F3D1**51847332 216009984700 **IAW5SF9.MS**51854480 217160022902 **MJD6F3M3/3**51868981 216160102319 **IAW5SF8.M4/1**51875964 216009706805 **IAW5SF9.MS1**51880191 216100142854 **IAW4AF.S2/3**51880192 216160137101 **IAW5AF.SK**51899838 216160102319 **IAW5SF8.M4/1**51903154 216160102319 **IAW5SF8.M4/1**51933482 216160102319 **IAW5SF8.M4/1**55180280 217160004201 **MJD6JFS4**55181148 216160053403 **IAW59F.VG**55186425 216160105403 **IAW5NF.T9/1**55187373 216160062806 **IAW4AF.M8/1**

OE/IAM	MAGNETI MARELLI	
	LONG	SHORT
A1	CENTRALINA CONTROLLO MOTORE ENGINE CONTROL UNIT	
FCA		
55187374	216160062503	IAW4AF.PP
55187469	216160102003	IAW4AF.G1/1
55187475	216160052710	IAW5NF.T1/1
55189584	216160105403	IAW5NF.T9/1
55189590	216160105403	IAW5NF.T9/1
55192636	216160107102	IAW5AF.SP
55192637	216160057703	IAW5AF.S2
55193434	216160107003	IAW5AF.SM/1
55193435	216160057804	IAW5AF.S1/1
55193438	216160046806	IAW59F.SC/1
55195167	216160111401	IAW4AF.G2
55195817	217160000404	MJD6JFP3
55201832	216160122501	IAW5SF.MB
71736339	216160037607	IAW59F.M3/7
71736340	216160044306	IAW59F.M5/1
71736344	216160060406	IAW59F.E4/1
71740039	216160038909	IAW59F.M2/1
71747978	216160111401	IAW4AF.G2
9657010180	230016452127	IAW48P2.34/2
MAGNETI MARELLI		
IAW1AP10	230016264407	IAW1AP.10
IAW1AP20/2	230016206737	IAW1AP.20/2
IAW1AP40	230016315447	IAW1AP.40
IAW1AP40/3	230016254567	IAW1AP.40/3
IAW1AP81	230016340597	IAW1AP.81
IAW1AP81/1	230016301797	IAW1AP.81/1
IAW1AP82/1	230016413447	IAW1AP.82/1
IAW1AP84/1	230016415447	IAW1AP.84/1
IAW48P231/1	230016394097	IAW48P2.31/1
IAW48P2316	230016939007	IAW48P2.316
IAW48P2317	230016932007	IAW48P2.317
IAW48P234/2	230016452127	IAW48P2.34/2
IAW48P236/1	230016454107	IAW48P2.36/1
IAW48P239/1	230016381077	IAW48P2.39/1
IAW48P270	230016449097	IAW48P2.70
IAW48P276	230016495077	IAW48P2.76
IAW48P280/1	230016448087	IAW48P2.80/1
IAW48P33J	230016488067	IAW48P3.3J
IAW49FB1	216160034003	IAW49F.B1
IAW49FB2	216160036006	IAW49F.B2
IAW4AFG1/1	216160102003	IAW4AF.G1/1
IAW4AFG2	216160111401	IAW4AF.G2
IAW4AFG3/1	216160129501	IAW4AF.G3/1

OE/IAM	MAGNETI MARELLI	
	LONG	SHORT
A1	CENTRALINA CONTROLLO MOTORE ENGINE CONTROL UNIT	
MAGNETI MARELLI		
IAW4AFM8/1	216160062806	IAW4AF.M8/1
IAW4AFM9/2	216160062708	IAW4AF.M9/2
IAW4AFPP	216160062503	IAW4AF.PP
IAW4AFS2/3	216100142854	IAW4AF.S2/3
IAW4AFS3/2	216160112602	IAW 4AF.S3/2
IAW4AFS31	216160112602	IAW 4AF.S3/2
IAW4AFSS/2	216160112502	IAW4AF.SS/2
IAW4EFB3	216160045702	IAW4EF.B3
IAW4EFB5	216160046102	IAW4EF.B5
IAW4EFG4/1	216160129401	IAW4EF.G4/1
IAW59FE4/1	216160060406	IAW59F.E4/1
IAW59FM1/2	216160044407	IAW59F.M1/2
IAW59FM1R	216160044407	IAW59F.M1/2
IAW59FM2/1	216160038909	IAW59F.M2/1
IAW59FM3/7	216160037607	IAW59F.M3/7
IAW59FM5/1	216160044306	IAW59F.M5/1
IAW59FM7/6	216160050706	IAW59F.M7/6
IAW59FSC/1	216160046806	IAW59F.SC/1
IAW59FVG	216160053403	IAW59F.VG
IAW5AFN8/4	216160107306	IAW5AF.N8/4
IAW5AFP3/3	216160065106	IAW5AF.P3/3
IAW5AFP4/4	216160106905	IAW5AF.P4/4
IAW5AFPE/2	216160107206	IAW5AF.PE/2
IAW5AFS1/1	216160057804	IAW5AF.S1/1
IAW5AFS2	216160057703	IAW5AF.S2
IAW5AFSK	216160137101	IAW5AF.SK
IAW5AFSM/1	216160107003	IAW5AF.SM/1
IAW5AFSP	216160107102	IAW5AF.SP
IAW5NFS5/1	216160057904	IAW5NF.S5/1
IAW5NFS8/2	216160061904	IAW5NF.S8/2
IAW5NFT1/1	216160052710	IAW5NF.T1/1
IAW5NFT9/1	216160105403	IAW5NF.T9/1
IAW5SF3M1/4	216160109809	IAW5SF3.M1/4
IAW5SF3M2/3	216160109908	IAW5SF3.M2/3
IAW5SF3M9	216160121501	IAW5SF3.M9
IAW5SF8M4/1	216160102319	IAW5SF8.M4/1
IAW5SF8MR	216160144402	IAW5SF8.MR
IAW5SF9MS	216009984700	IAW5SF9.MS
IAW5SF9MS1	216009706805	IAW5SF9.MS1
IAW5SFMB	216160122501	IAW5SF.MB
IAW5SFMD	216160130202	IAW5SF.MD
IAW6LPA02	230016704087	IAW6LPA.02
IAW8P10/2	230016239447	IAW8P.10/2

OE/IAM

MAGNETI
MARELLI

LONG

SHORT

A1 CENTRALINA CONTROLLO MOTORE
ENGINE CONTROL UNIT**MAGNETI MARELLI**

IAW8P10/3	230016238457	IAW8P.10/3
IAW8P14/1	230016269437	IAW8P.14/1
IAW8P1A/2	230016391407	IAW8P1.A/2
MJD6F3A5	217160008704	MJD6F3A5
MJD6F3B1	217160012703	MJD6F3B1
MJD6F3B2	217160017400	MJD6F3B2
MJD6F3D1	217160019202	MJD6F3D1
MJD6F3D2	217160004403	MJD6F3D2
MJD6F3D4	217160008604	MJD6F3D4
MJD6F3D4/1	217160020000	MJD6F3D4/1
MJD6F3D5	217160015200	MJD6F3D5
MJD6F3H1	217160011301	MJD6F3H1
MJD6F3M3	217160002004	MJD6F3M3
MJD6F3M3/3	217160022902	MJD6F3M3/3
MJD6F3M5	217160023001	MJD6F3M5
MJD6F3P5	217160001604	MJD6F3P5
MJD6F3P5/1	217160024501	MJD6F3P5/1
MJD6F3P6	217160008800	MJD6F3P6
MJD6F3P7	217160001908	MJD6F3P7
MJD6F3P7/1	217160024000	MJD6F3P7/1
MJD6F3P8	217160024300	MJD6F3P8
MJD6F3PB	217160011505	MJD6F3PB
MJD6F3PB/1	217160024601	MJD6F3PB/1
MJD6F3Y2	217160020600	MJD6F3Y2
MJD6F3Y5	217160019001	MJD6F3Y5
MJD6JFM5	217160009203	MJD6JFM5
MJD6JFP1	217160000203	MJD6JFP1
MJD6JFP3	217160000404	MJD6JFP3
MJD6JFS1	217160000505	MJD6JFS1
MJD6JFS3	217160000605	MJD6JFS3
MJD6JFS4	217160004201	MJD6JFS4

MEAT & DORIA

70002	216160038909	IAW59F.M2/1
70003	216160037607	IAW59F.M3/7
70004	216160060406	IAW59F.E4/1
70005	216160044306	IAW59F.M5/1
70006	216160062806	IAW4AF.M8/1
70007	216160050706	IAW59F.M7/6
70008	216160065106	IAW5AF.P3/3
70009	216160106905	IAW5AF.P4/4
70010	216160107003	IAW5AF.SM/1
70011	216160107102	IAW5AF.SP
70012	216160107306	IAW5AF.N8/4

OE/IAM

MAGNETI
MARELLI

LONG

SHORT

A1 CENTRALINA CONTROLLO MOTORE
ENGINE CONTROL UNIT**MEAT & DORIA**

70013	216160109809	IAW5SF3.M1/4
70014	216160046806	IAW59F.SC/1
70016	217160000203	MJD6JFP1
70018	217160000404	MJD6JFP3
70019	217160000505	MJD6JFS1
70020	217160000605	MJD6JFS3
70021	217160001604	MJD6F3P5
70022	217160001908	MJD6F3P7
70023	217160002004	MJD6F3M3
70026	217160004201	MJD6JFS4
70027	217160004403	MJD6F3D2
70030	217160008604	MJD6F3D4
70031	217160008704	MJD6F3A5
70033	217160009203	MJD6JFM5
70034	217160011301	MJD6F3H1
70035	217160011505	MJD6F3PB
70036	217160012703	MJD6F3B1
70039	217160015200	MJD6F3D5
70040	217160017400	MJD6F3B2
70042	217160019001	MJD6F3Y5
70043	217160019202	MJD6F3D1
70044	217160020000	MJD6F3D4/1
70045	217160020600	MJD6F3Y2
70046	217160022902	MJD6F3M3/3
70047	217160023001	MJD6F3M5
70049	217160008800	MJD6F3P6
70050	217160024300	MJD6F3P8
70051	217160024501	MJD6F3P5/1
70052	217160024601	MJD6F3PB/1
70056	230016449097	IAW48P2.70
70058	216160062708	IAW4AF.M9/2
70059	216160112502	IAW4AF.SS/2
70060	216160044407	IAW59F.M1/2
70062	216160053403	IAW59F.VG
70063	216160105403	IAW5NF.T9/1
70064	216160122501	IAW5SF.MB
70066	216160109908	IAW5SF3.M2/3
70068	216160057703	IAW5AF.S2
70069	216160137101	IAW5AF.SK
70070	216160107206	IAW5AF.PE/2
70071	216100142854	IAW4AF.S2/3
70072	216160061904	IAW5NF.S8/2
70073	216160057904	IAW5NF.S5/1

OE/IAM	MAGNETI MARELLI	
	LONG	SHORT
A1	CENTRALINA CONTROLLO MOTORE ENGINE CONTROL UNIT	
MEAT & DORIA		
70074	216009706805	IAW5SF9.MS1
70075	216009984700	IAW5SF9.MS
70079	216160036006	IAW49F.B2
70080	216160057804	IAW5AF.S1/1
70081	216160112602	IAW 4AF.S3/2
70082	216160121501	IAW5SF3.M9
70083	216160129401	IAW4EF.G4/1
70084	216160130202	IAW5SF.MD
70085	216160144402	IAW5SF8.MR
70090	230016704087	IAW6LPA.02
70100	216160052710	IAW5NF.T1/1
PSA		
193805	230016264407	IAW1AP.10
193818	230016449097	IAW48P2.70
193833	230016448087	IAW48P2.80/1
193917	230016381077	IAW48P2.39/1
1938E3	230016932007	IAW48P2.317
9628993580	230016315447	IAW1AP.40
9634872080	230016254567	IAW1AP.40/3
9639907880	230016301797	IAW1AP.81/1
9639907980	230016340597	IAW1AP.81
9639908080	230016413447	IAW1AP.82/1
9639908280	230016415447	IAW1AP.84/1
9640304480	230016264407	IAW1AP.10
9643280780	230016206737	IAW1AP.20/2
9645243180	230016449097	IAW48P2.70
9647276480	230016488067	IAW48P3.3J
9648663580	230016381077	IAW48P2.39/1
9649139980	230016394097	IAW48P2.31/1
9649140580	230016454107	IAW48P2.36/1
9651184380	230016448087	IAW48P2.80/1
9652488080	230016495077	IAW48P2.76
9654708480	230016238457	IAW8P.10/3
9654708580	230016239447	IAW8P.10/2
9654708880	230016269437	IAW8P.14/1
9654710980	230016391407	IAW8P1.A/2
9657010180	230016452127	IAW48P2.34/2
9659024080	230016704087	IAW6LPA.02
9664157780	230016939007	IAW48P2.316
9664157880	230016932007	IAW48P2.317
19293J	230016315447	IAW1AP.40
19294E	230016239447	IAW8P.10/2
19294F	230016238457	IAW8P.10/3

OE/IAM	MAGNETI MARELLI	
	LONG	SHORT
A1	CENTRALINA CONTROLLO MOTORE ENGINE CONTROL UNIT	
PSA		
1929LC	230016391407	IAW8P1.A/2
1929QP	230016413447	IAW1AP.82/1
1929RF	230016301797	IAW1AP.81/1
1929RH	230016254567	IAW1AP.40/3
1929RY	230016340597	IAW1AP.81
1929TK	230016415447	IAW1AP.84/1
1929VL	230016269437	IAW8P.14/1
1929XW	230016939007	IAW48P2.316
1938G9	230016206737	IAW1AP.20/2
1938KN	230016488067	IAW48P3.3J
1938RV	230016454107	IAW48P2.36/1
1938TN	230016394097	IAW48P2.31/1
1938VG	230016452127	IAW48P2.34/2
1938Y9	230016495077	IAW48P2.76
1942C8	230016704087	IAW6LPA.02
SIDAT		
243101	216160038909	IAW59F.M2/1
243102	216160037607	IAW59F.M3/7
243103	216160044306	IAW59F.M5/1
243104	216160050706	IAW59F.M7/6
243105	216160065106	IAW5AF.P3/3
243106	216160106905	IAW5AF.P4/4
243107	216160107102	IAW5AF.SP
243108	216160107306	IAW5AF.N8/4
243110	217160000203	MJD6JFP1
243112	217160000404	MJD6JFP3
243113	217160000505	MJD6JFS1
243114	216160060406	IAW59F.E4/1
243115	216160062806	IAW4AF.M8/1
243116	216160107003	IAW5AF.SM/1
243117	216160109809	IAW5SF3.M1/4
243118	216160046806	IAW59F.SC/1
243120	217160000605	MJD6JFS3
243121	217160001604	MJD6F3P5
243122	217160001908	MJD6F3P7
243123	217160002004	MJD6F3M3
243126	217160004201	MJD6JFS4
243127	217160004403	MJD6F3D2
243130	217160008604	MJD6F3D4
243131	217160008704	MJD6F3A5
243132	217160008800	MJD6F3P6
243133	217160009203	MJD6JFM5
243134	217160011301	MJD6F3H1

OE/IAM	MAGNETI MARELLI	
	LONG	SHORT
A1	CENTRALINA CONTROLLO MOTORE ENGINE CONTROL UNIT	
SIDAT		
243135	217160011505	MJD6F3PB
243136	217160012703	MJD6F3B1
243139	217160015200	MJD6F3D5
243140	217160017400	MJD6F3B2
243142	217160019001	MJD6F3Y5
243143	217160019202	MJD6F3D1
243144	217160020000	MJD6F3D4/1
243145	217160020600	MJD6F3Y2
243146	217160022902	MJD6F3M3/3
243147	217160023001	MJD6F3M5
243150	217160024300	MJD6F3P8
243151	217160024501	MJD6F3P5/1
243152	217160024601	MJD6F3PB/1
243156	230016449097	IAW48P2.70
243158	216160062708	IAW4AF.M9/2
243159	216160112502	IAW4AF.SS/2
243160	216160044407	IAW59F.M1/2
243162	216160053403	IAW59F.VG
243163	216160105403	IAW5NF.T9/1
243164	216160122501	IAW5SF.MB
243166	216160109908	IAW5SF3.M2/3
243168	216160057703	IAW5AF.S2
243169	216160137101	IAW5AF.SK
243170	216160107206	IAW5AF.PE/2
243171	216100142854	IAW4AF.S2/3
243172	216160061904	IAW5NF.S8/2
243173	216160057904	IAW5NF.S5/1
243174	216009706805	IAW5SF9.MS1
243175	216009984700	IAW5SF9.MS
243179	216160036006	IAW49F.B2
243180	216160057804	IAW5AF.S1/1
243181	216160112602	IAW 4AF.S3/2
243182	216160121501	IAW5SF3.M9
243183	216160129401	IAW4EF.G4/1
243184	216160130202	IAW5SF.MD
243185	216160144402	IAW5SF8.MR
243190	230016704087	IAW6LPA.02
243200	216160052710	IAW5NF.T1/1

OE/IAM	MAGNETI MARELLI	
	LONG	SHORT
A2	CENTRALINA CONTROLLO MOTORE RIGENERATA ENGINE CONTROL UNIT REMANUFACTURED	
FCA		
71722026	246160050706	IAW59FM7R
71722076	246160037607	IAW59FM3R/1
71784737	246160037607	IAW59FM3R/1
71784752	246160044306	IAW59FM5R/1
71785511	246160046806	IAW59F.SCR
71787347	246160038909	IAW59FM2R/1
MAGNETI MARELLI		
IAW59FM2R/1	246160038909	IAW59FM2R/1
IAW59FM3R/1	246160037607	IAW59FM3R/1
IAW59FM5R/1	246160044306	IAW59FM5R/1
IAW59FM7R	246160050706	IAW59FM7R
IAW59FSCR	246160046806	IAW59F.SCR

GRUPPO B - GROUP B

B1	ATTUATORE CONTROLLO MINIMO IDLE SPEED CONTROL ACTUATOR KIT	
BOSCH		
0280140553	820003393010	B3393
0280140570	820003394010	B3394
0280140571	820003393010	B3393
F00099M200	219244290500	B02
F00099M401	820003385010	B3385
F00099M431	230016079057	B04
DAEWOO		
93740918	820003368010	B3368
93744675	820003396010	B3396
96434613	820003396010	B3396
DELPHI		
CV1000011B1	820003253010	B3253
CV1000211B1	820003215010	B3215
CV1017512B1	219244070501	B01
CV1017612B1	219244270500	B12
CV1017712B1	219244290500	B02
CV1017812B1	219244370500	B18
CV1017912B1	230016079047	B03
CV1018112B1	230016079077	B14
CV1018312B1	230016079087	B13
CV1018512B1	230016079167	B24/00
CV1018912B1	801001301601	B32/01
CV1019112B1	230016079057	B04
CV1019412B1	230016079247	B32/00
CV1019512B1	801011185901	B36

OE/IAM	MAGNETI MARELLI	
	LONG	SHORT
B1	ATTUATORE CONTROLLO MINIMO IDLE SPEED CONTROL ACTUATOR KIT	
DELPHI		
CV1020012B1	230016079107	B17
CV1020112B1	230016079197	B27
ERA		
556000	820003398010	B3398
556002	820003253010	B3253
556003	820003215010	B3215
556005	820003397010	B3397
556008	211080050500	B06
556009	219244070501	B01
556010	801011185901	B36
556012	820003355010	B3355
556014	230016079207	B28/00
556015	820003391011	B3391
556016	820003388010	B3388
556030	230016079057	B04
556031	230016079107	B17
556032	801000776401	B22/1
556033	230016079197	B27
556034	230016079247	B32/00
556035	820003390011	B3390
556036	801000774001	B23/00
556038	820003354010	B3354
556039	801001185201	B35/00
556040	801001184401	B33
556041	820003385010	B3385
556042	801001301601	B32/01
556043	230016079167	B24/00
556044	219244290500	B02
556045	219244270500	B12
556046	230016079087	B13
556047	219244370500	B18
556048	820003368010	B3368
556053	230016079047	B03
556054	820003389010	B3389
556055	230016079077	B14
556057	820003395010	B3395
556072	820003393010	B3393
556073	820003396010	B3396
556075	820003394010	B3394
556097	230016079227	B30/01
556000B	820003398010	B3398
556005B	820003397010	B3397
556015B	820003391011	B3391

OE/IAM	MAGNETI MARELLI	
	LONG	SHORT
B1	ATTUATORE CONTROLLO MINIMO IDLE SPEED CONTROL ACTUATOR KIT	
ERA		
556035B	820003390011	B3390
556057B	820003395010	B3395
556072B	820003393010	B3393
556073B	820003396010	B3396
FCA		
7789627	820003393010	B3393
9944470	219244070501	B01
9945035	219244270500	B12
9945635	219244290500	B02
9945776	219244370500	B18
60576708	211080050500	B06
60608904	820003392010	B3392
60811197	820003393010	B3393
96069888	230016079057	B04
9564448480	230016079057	B04
FORD		
1014398	820003398010	B3398
1063996	820003398010	B3398
7084580	820003398010	B3398
95BF9F715AB	820003398010	B3398
95BF9F715AC	820003398010	B3398
95XF9F715AA	820003398010	B3398
GENERAL MOTORS		
17059602	820003396010	B3396
90411546	820003397010	B3397
HELLA		
6NW009141001	820003397010	B3397
6NW009141031	820003398010	B3398
6NW009141091	820003392010	B3392
6NW009141201	230016079047	B03
6NW009141211	230016079057	B04
6NW009141251	230016079107	B17
6NW009141261	820003389010	B3389
6NW009141271	801001185201	B35/00
6NW009141281	801001184401	B33
6NW009141291	820003388010	B3388
6NW009141301	801011185901	B36
6NW009141311	230016079167	B24/00
6NW009141321	230016079197	B27
6NW009141331	230016079227	B30/01
6NW009141341	801000776401	B22/1
6NW009141351	230016079247	B32/00
6NW009141361	801001301601	B32/01

OE/IAM	MAGNETI MARELLI	
	LONG	SHORT
B1	ATTUATORE CONTROLLO MINIMO IDLE SPEED CONTROL ACTUATOR KIT	
HELLA		
6NW009141391	820003391011	B3391
6NW009141401	219244290500	B02
6NW009141411	219244270500	B12
6NW009141431	230016079087	B13
6NW009141441	230016079077	B14
6NW009141451	820003385010	B3385
6NW009141471	801000774001	B23/00
6NW009141481	820003395010	B3395
6NW009141501	219244370500	B18
6NW009141581	820003397010	B3397
6NW009141761	820003387010	B3387
HITACHI		
AESP1062B	820003398010	B3398
AESP20713A	820003397010	B3397
AESP20715	820003392010	B3392
GL326716	820003392010	B3392
HYUNDAI		
3515033000	820003394010	B3394
3515033010	820003394010	B3394
INTERMOTOR		
14802	820003397010	B3397
14836	820003398010	B3398
14854	820003392010	B3392
14856	820003390011	B3390
14858	820003395010	B3395
14872	820003391011	B3391
LUCAS ELECTRICAL		
FDB1011	820003391011	B3391
FDB947	820003397010	B3397
FDB978	820003398010	B3398
FDB993	820003392010	B3392
FDB995	820003390011	B3390
FDB997	820003395010	B3395
MAGNETI MARELLI		
B03	230016079047	B03
B04	230016079057	B04
B13	230016079087	B13
B14	230016079077	B14
B17	230016079107	B17
B22/1	801000776401	B22/1
B23/00	801000774001	B23/00
B24/00	230016079167	B24/00
B27	230016079197	B27

OE/IAM	MAGNETI MARELLI	
	LONG	SHORT
B1	ATTUATORE CONTROLLO MINIMO IDLE SPEED CONTROL ACTUATOR KIT	
MAGNETI MARELLI		
B28/00	230016079207	B28/00
B30/01	230016079227	B30/01
B31/2	801000800401	B31/2
B32/00	230016079247	B32/00
B32/01	801001301601	B32/01
B33	801001184401	B33
B35/00	801001185201	B35/00
B36	801011185901	B36
MEAT & DORIA		
4334	801011185901	B36
4700	801001185201	B35/00
84005	219244270500	B12
84006	820003253010	B3253
84007	219244370500	B18
84010	219244070501	B01
84011	219244290500	B02
84012	230016079057	B04
84013	230016079087	B13
84014	230016079077	B14
84017	230016079107	B17
84018	230016079047	B03
84022	801000776401	B22/1
84024	230016079167	B24/00
84026	211080050500	B06
84027	230016079197	B27
84030	230016079207	B28/00
84031	820003395010	B3395
84035	230016079247	B32/00
84036	820003390011	B3390
84037	801000774001	B23/00
84039	820003355010	B3355
84040	820003354010	B3354
84041	820003215010	B3215
84044	820003368010	B3368
84045	801001184401	B33
84048	820003391011	B3391
84049	230016079227	B30/01
84050	820003385010	B3385
84051	801001301601	B32/01
84052	820003387010	B3387
84053	820003388010	B3388
84054	820003389010	B3389
84060	820003396010	B3396

OE/IAM	MAGNETI MARELLI	
	LONG	SHORT
B1	ATTUATORE CONTROLLO MINIMO IDLE SPEED CONTROL ACTUATOR KIT	
MEAT & DORIA		
84061	801000800401	B31/2
85013	820003398010	B3398
85014	820003397010	B3397
85015	820003392010	B3392
85032	820003393010	B3393
85034	820003394010	B3394
OPEL		
817253	820003253010	B3253
817255	820003253010	B3253
817256	820003215010	B3215
817523	820003253010	B3253
826550	820003215010	B3215
837102	820003397010	B3397
90411546	820003397010	B3397
PIERBURG		
40750152	820003391011	B3391
402003010	820003397010	B3397
402003320	820003398010	B3398
402003560	820003392010	B3392
407501020	230016079057	B04
407501500	820003253010	B3253
407501520	820003391011	B3391
705432040	230016079077	B14
705432090	219244290500	B02
PSA		
034595	801000800401	B31/2
9564448480	230016079057	B04
9564463480	230016079047	B03
9624800480	230016079167	B24/00
19201F	230016079167	B24/00
19201F	820003387010	B3387
19202Q	230016079107	B17
19204X	801000776401	B22/1
19205F	230016079197	B27
19206W	230016079247	B32/00
19208X	801001184401	B33
19209L	801001301601	B32/01
19209V	230016079227	B30/01
1920AH	801001185201	B35/00
1920AQ	820003388010	B3388
1920CA	820003389010	B3389
1920CV	801011185901	B36
1920N1	230016079057	B04

OE/IAM	MAGNETI MARELLI	
	LONG	SHORT
B1	ATTUATORE CONTROLLO MINIMO IDLE SPEED CONTROL ACTUATOR KIT	
PSA		
1920Q8	230016079047	B03
1920V7	230016079087	B13
1920W6	230016079077	B14
1920X9	820003385010	B3385
RENAULT		
7700102539	230016079207	B28/00
7701042403	801000774001	B23/00
7701042784	230016079207	B28/00
7701044401	820003395010	B3395
7701047909	820003355010	B3355
7701204054	230016079047	B03
7701206370	820003354010	B3354
7702217296	820003390011	B3390
SIDAT		
39525	820003398010	B3398
87003	219244270500	B12
87004	820003253010	B3253
87005	219244370500	B18
87007	219244070501	B01
87008	219244290500	B02
87009	230016079057	B04
87010	230016079087	B13
87011	230016079077	B14
87012	230016079107	B17
87013	230016079047	B03
87016	801000776401	B22/1
87017	230016079167	B24/00
87018	211080050500	B06
87019	230016079197	B27
87021	230016079207	B28/00
87022	820003395010	B3395
87026	230016079247	B32/00
87027	820003390011	B3390
87028	801000774001	B23/00
87030	820003355010	B3355
87031	820003354010	B3354
87032	820003215010	B3215
87033	801001185201	B35/00
87034	801011185901	B36
87035	820003368010	B3368
87036	801001184401	B33
87039	820003391011	B3391
87040	230016079227	B30/01

OE/IAM	MAGNETI MARELLI	
	LONG	SHORT
B1	ATTUATORE CONTROLLO MINIMO IDLE SPEED CONTROL ACTUATOR KIT	
SIDAT		
87041	820003385010	B3385
87042	801001301601	B32/01
87044	820003388010	B3388
87045	820003389010	B3389
87053	820003397010	B3397
87054	820003392010	B3392
87070	820003393010	B3393
87072	820003394010	B3394
87091	820003396010	B3396
87092	801000800401	B31/2
SIEMENS VDO		
5WK90631X	820003397010	B3397
A95214	820003253010	B3253
A95262	230016079047	B03
A95269	230016079057	B04
A95273	219244070501	B01
A96156	820003389010	B3389
A96159	820003388010	B3388
A97101	820003387010	B3387
A97110	230016079227	B30/01
A97122	801001301601	B32/01
C95105	820003391011	B3391
C95128	219244290500	B02
C95136	219244270500	B12
C95166	820003215010	B3215
C95177	230016079207	B28/00
C95196	219244370500	B18
C95197	820003385010	B3385
D95103	820003390011	B3390
D95129	801000774001	B23/00
D95134	820003395010	B3395
D95174	820003355010	B3355
D95177	820003354010	B3354
X10739002001	820003397010	B3397
X10739002003	820003398010	B3398
X10739002006	820003392010	B3392
STANDARD		
14788	219244290500	B02
14791	219244070501	B01
EIC044	219244290500	B02
SWAG		
50926248	820003398010	B3398

OE/IAM	MAGNETI MARELLI	
	LONG	SHORT
B1	ATTUATORE CONTROLLO MINIMO IDLE SPEED CONTROL ACTUATOR KIT	
VAG		
078133455	820003391011	B3391

B2	CABLAGGIO PER 54DTS3 CABLE FOR THROTTLE BODY 54DTS3	
FCA		
504388760	806009814008	KBLCF01
MAGNETI MARELLI		
54DTS3I	806009814008	KBLCF01

B2	COLLETTORE CONTROLLO MOTORE ENGINE COLLECTOR BODY	
FCA		
55190238	802007771809	CAD191
55202680	802007771809	CAD191
55206459	802007771809	CAD191
55210201	802007771809	CAD191
MAGNETI MARELLI		
CAD191	802007771809	CAD191
OPEL		
5850119	802007771809	CAD191
5850158	802007771809	CAD191
93179055	802007771809	CAD191
PIERBURG		
700373120	802007771809	CAD191

B3	CORPO FARFALLATO THROTTLE BODY	
BOSCH		
0280750042	802000000011	TB0011
0280750085	802000000015	TB0015
0280750137	802000000013	TB0013
F01C600027	802000000009	TB0009
DELPHI		
AT1002012B1	802001291204	36SXF E1/4
AT1002212B1	802007638901	46SXF7
AT1002412B1	802007715701	46SXF8
CV1018612B1	802000000012	TB0012
ERA		
556120	802001957505	44SMF9/1
556122	802000000003	TB0003
556132	802001897107	48CPD4
556138	802000000012	TB0012

OE/IAM	MAGNETI MARELLI	
	LONG	SHORT
B3	CORPO FARFALLATO THROTTLE BODY	
FCA		
46425923	211535000503	40SXF1
46533515	802000000011	TB0011
46781327	802001301004	36SXF5/1
51785231	802007632009	40CDSF1
51814492	802009105203	40DFP1
55186521	802001897107	48CPD4
55187316	802000000013	TB0013
55192787	802001957505	44SMF9/1
55196350	802001897107	48CPD4
55199970	802001924506	48CPD1
55199971	802001897107	48CPD4
55200820	802009196601	48CPD6
55200822	802007824703	48CPD8
55202620	802008041301	48CPD9
55215486	802009525507	48CPD6G
55255919	802009105203	40DFP1
71718821	802007715701	46SXF8
71718959	802001291204	36SXF1/4
71718989	802007972401	46SXF11
71718994	802007638901	46SXF7
71730302	806001680202	KIT48SMF5
71732365	806001680202	KIT48SMF5
71732618	802001783002	36SMF6
71736817	802007638901	46SXF7
71737116	802007715701	46SXF8
71740011	802007715701	46SXF8
71788073	802000000013	TB0013
71788736	802007506203	40SMF10/1
77363298	802001291204	36SXF1/4
77363331	802007972401	46SXF11
77363462	802000000009	TB0009
77363793	802001957505	44SMF9/1
77363827	802007506203	40SMF10/1
77364870	802001957505	44SMF9/1
77366849	805012024500	40GTE3F
504134412	805008008501	57SMI1
504351131	802009814008	54DTS3I
504385629	802010473903	54DTE3I
9659041880	802007883802	50CDSP3
9664960080	802009362601	50CAD281

OE/IAM	MAGNETI MARELLI	
	LONG	SHORT
B3	CORPO FARFALLATO THROTTLE BODY	
FORD		
1562092	802007506203	40SMF10/1
1576655	802007889313	50CDDF4/1
3M5Q9E926AB	802001479213	50CDSP3/F
3M5Q9E926CD	802007889313	50CDDF4/1
6G9Q9E926AE	802007855509	50CDSF5
9S519E926AA	802007506203	40SMF10/1
HELLA		
8UK007623131	802001291204	36SXF1/4
8UK007623141	802007715701	46SXF8
8UK007623151	802001301004	36SXF5/1
8UK007623161	211535000503	40SXF1
8UK007623171	802007506203	40SMF10/1
8UK007623181	802001957505	44SMF9/1
IVECO		
504351131	802009814008	54DTS3I
KIA		
3510027410	802000000003	TB0003
MAGNETI MARELLI		
18385	802000813301	18385
36SMF6	802001783002	36SMF6
36SXF1/4	802001291204	36SXF1/4
36SXF5/1	802001301004	36SXF5/1
36SXR31	802001122505	36SXR31
40CDSF1	802007632009	40CDSF1
40DFP1	802009105203	40DFP1
40GTE3F	805012024500	40GTE3F
40SMF10/1	802007506203	40SMF10/1
40SXF1	211535000503	40SXF1
42SXPP31	802001121211	42SXPP31
44GTE3P	802009522503	44GTE3P
44SMF9/1	802001957505	44SMF9/1
46SXF11	802007972401	46SXF11
46SXF7	802007638901	46SXF7
46SXF8	802007715701	46SXF8
48CPD1	802001924506	48CPD1
48CPD4	802001897107	48CPD4
48CPD6	802009196601	48CPD6
48CPD6G	802009525507	48CPD6G
48CPD8	802007824703	48CPD8
48CPD9	802008041301	48CPD9
50CAD281	802009362601	50CAD281
50CDDF4/1	802007889313	50CDDF4/1
50CDDP1	802001383309	50CDDP1

OE/IAM

MAGNETI
MARELLI

LONG

SHORT

B3 CORPO FARFALLATO
THROTTLE BODY**MAGNETI MARELLI**

50CDDP8	802008600903	50CDDP8
50CDDP9	802009289501	50CDDP9
50CDSF5	802007855509	50CDSF5
50CDSP3	802007883802	50CDSP3
50CDSP3/F	802001479213	50CDSP3/F
50CDSP6	802007981603	50CDSP6
50SMP1	802001500013	50SMP1
52SXP31	802001181005	52SXP31
54DTE3I	802010473903	54DTE3I
54DTS3I	802009814008	54DTS3I
57SMI1	805008008501	57SMI1
60CPM	802001957705	60CPM
60CPM1	802001183909	60CPM1
60CPM2	802001985303	60CPM2
60XR32	802000813003	60XR32
60XR9	802000812402	60XR9
KIT48SMF5	806001680202	KIT48SMF5

MEAT & DORIA

88187	802009814008	54DTS3I
89001	802001291204	36SXF1/4
89003	802000000010	TB0010
89010	802000000005	TB0005
89012	802000000004	TB0004
89013	802000000001	TB0001
89014	802000000006	TB0006
89015	802000000007	TB0007
89016	802000000008	TB0008
89027	802000000011	TB0011
89033	802000000012	TB0012
89044	802007715701	46SXF8
89058	802001783002	36SMF6
89059	802001957505	44SMF9/1
89060	802007506203	40SMF10/1
89061	806001680202	KIT48SMF5
89062	802007638901	46SXF7
89063	802007972401	46SXF11
89064	211535000503	40SXF1
89065	802001301004	36SXF5/1
89070	802009289501	50CDDP9
89072	802000000014	TB0014
89074	802001924506	48CPD1
89077	802007824703	48CPD8
89084	802009196601	48CPD6

OE/IAM

MAGNETI
MARELLI

LONG

SHORT

B3 CORPO FARFALLATO
THROTTLE BODY**MEAT & DORIA**

89085	802009525507	48CPD6G
89106	802001897107	48CPD4
89107	802001500013	50SMP1
89108	802001957705	60CPM
89109	802001985303	60CPM2
89110	802009522503	44GTE3P
89111	802001183909	60CPM1
89122	802000000003	TB0003
89124	802000000002	TB0002
89125	802000000015	TB0015
89151	802000813301	18385
89152	802001122505	36SXR31
89185	802009105203	40DFP1
89068R	802000000013	TB0013
89069R	802000000009	TB0009

NISSAN

161190U000	802000000007	TB0007
161190U400	802000000004	TB0004
1611941B02	802000000006	TB0006
1611944B00	802000000005	TB0005
1611972B00	802000000008	TB0008
1611972B60	802000000001	TB0001
161190U000	802000000007	TB0007
161190U400	802000000004	TB0004

OPEL

825233	802000000012	TB0012
825248	802000000012	TB0012
825265	802000000002	TB0002
5825227	802000000014	TB0014
5825241	802001924506	48CPD1
5825246	802007632009	40CDSF1
5825257	802000000002	TB0002
5828246	802001897107	48CPD4
9128518	802000000012	TB0012
9196357	802000000012	TB0012
93171626	802000000014	TB0014
93178706	802001924506	48CPD1
93179062	802001897107	48CPD4
93184874	802007632009	40CDSF1
97376266	802000000002	TB0002
98105210	802000000002	TB0002

OE/IAM	 LONG SHORT	
--------	-------------------------------------	--

B3	CORPO FARFALLATO THROTTLE BODY
-----------	---

PIERBURG		
71431909	802000000012	TB0012
700806080	802000000002	TB0002
700806160	802000000002	TB0002
700806180	802000000002	TB0002
703703030	802000000010	TB0010
714319090	802000000012	TB0012
714319550	802000000012	TB0012
714319570	802000000012	TB0012
714319580	802000000012	TB0012
714439030	802000000014	TB0014
PSA		
163615	802001985303	60CPM2
163632	802001957705	60CPM
163667	802009522503	44GTE3P
447280	802000000015	TB0015
0345E6	802007883802	50CDSP3
9635884080	802000000015	TB0015
9636175680	802001181005	52SXP31
9636215180	802001183909	60CPM1
9647925480	802001500013	50SMP1
9653289480	802001985303	60CPM2
9653909680	802001957705	60CPM
9659041880	802007883802	50CDSP3
9660110780	802007981603	50CDSP6
9664960080	802009362601	50CAD281
9684269380	802009289501	50CDDP9
9685879480	802009522503	44GTE3P
0345E8	802007981603	50CDSP6
0348E8	802007981603	50CDSP6
0345E9	802008600903	50CDDP8
0348E9	802008600903	50CDDP8
0345A8	802001383309	50CDDP1
0345F0	802009289501	50CDDP9
0345F2	802009362601	50CAD281
1628NT	802001181005	52SXP31
1635N0	802001985303	60CPM2
1635P6	802001121211	42SXPP31
1635Q4	802001183909	60CPM1
1635Q9	802000000015	TB0015
1635W2	802001500013	50SMP1
963511818A	802001121211	42SXPP31
963570788A	802001181005	52SXP31

OE/IAM	 LONG SHORT	
--------	-------------------------------------	--

B3	CORPO FARFALLATO THROTTLE BODY
-----------	---

RENAULT		
7700105042	802000813301	18385
7700108120	802001122505	36SXR31
7700113286	802000812402	60XR9
7700871215	802000812402	60XR9
7700875078	802000813003	60XR32
7701051585	802001546904	SMR00102Y
8200060868	802000813003	60XR32
SAAB		
825310	802001897107	48CPD4
SIDAT		
83907	802009814008	54DTS3I
88001	802001291204	36SXF1/4
88003	802000000010	TB0010
88010	802000000005	TB0005
88012	802000000004	TB0004
88013	802000000001	TB0001
88014	802000000006	TB0006
88015	802000000007	TB0007
88016	802000000008	TB0008
88027	802000000011	TB0011
88033	802000000012	TB0012
88044	802007715701	46SXF8
88058	802001783002	36SMF6
88059	802001957505	44SMF9/1
88060	802007506203	40SMF10/1
88061	806001680202	KIT48SMF5
88062	802007638901	46SXF7
88063	802007972401	46SXF11
88064	211535000503	40SXF1
88065	802001301004	36SXF5/1
88068	802000000013	TB0013
88069	802000000009	TB0009
88070	802009289501	50CDDP9
88072	802000000014	TB0014
88074	802001924506	48CPD1
88077	802007824703	48CPD8
88084	802009196601	48CPD6
88085	802009525507	48CPD6G
88090	802001897107	48CPD4
88091	802001957705	60CPM
88092	802001985303	60CPM2
88093	802009522503	44GTE3P
88094	802001183909	60CPM1

OE/IAM			
		LONG	SHORT
B3	CORPO FARFALLATO THROTTLE BODY		
SIDAT			
88096	802000000003	TB0003	
88098	802000000002	TB0002	
88105	802001500013	50SMP1	
88116	802000000015	TB0015	
88137	802000813301	18385	
88138	802001122505	36SXR31	
88175	802009105203	40DFP1	
SIEMENS VDO			
408237130002	802000000010	TB0010	
408237130002Z	802000000010	TB0010	
A2C59513664	802000000012	TB0012	
A2C59515171	802000000003	TB0003	
VAG			
030133064D	802000000010	TB0010	

B2	KIT ELETTROVALVOLA CANISTER CANISTER VALVE KIT		
ERA			
556052	806001508801	KIT EC2/1	
FCA			
46553965	806001508801	KIT EC2/1	
71718105	806001508801	KIT EC2/1	
71753129	806009849501	KITEC1/02	
MAGNETI MARELLI			
KITEC1/02	806009849501	KITEC1/02	
KITEC2/1	806001508801	KIT EC2/1	
MEAT & DORIA			
84055	806001508801	KIT EC2/1	
SIDAT			
83971	806001508801	KIT EC2/1	

B3	REGOLATORE ARIA MOTORE CONTROL FLAP - AIR SUPPLY		
BMW			
7810752	802000000019	TB0019	
13547810752	802000000019	TB0019	
DELPHI			
CV1019212B1	802000000017	TB0017	
FCA			
46807152	802000000016	TB0016	
46817373	802000000018	TB0018	
46823851	802000000017	TB0017	

OE/IAM			
		LONG	SHORT
B3	REGOLATORE ARIA MOTORE CONTROL FLAP - AIR SUPPLY		
PIERBURG			
702044020	802000000019	TB0019	
714378060	802000000016	TB0016	
714400050	802000000018	TB0018	
714431050	802000000017	TB0017	
SIDAT			
88141	802000000018	TB0018	
88142	802000000016	TB0016	
88143	802000000017	TB0017	
88155	802000000019	TB0019	

B4	SENSORE MASSA ARIA AIR MASS SENSOR		
BOSCH			
0281002461	213719752010	AMM19752	
0986284007	213719752010	AMM19752	
DELPHI			
AF1007812B1	213719752010	AMM19752	
AF1018212B1	213719652010	AMM19652	
AF1018312B1	213719770010	AMM19770	
ERA			
558010	213719671010	AMM19671	
558012	213719670010	AMM19670	
558014	213719666010	AMM19666	
558025	213719769010	AMM19769	
558026	213719672010	AMM19672	
558040	213719667010	AMM19667	
558050	213719780010	AMM19780	
558073	213719752010	AMM19752	
558102	213719669010	AMM19669	
558118	213719770010	AMM19770	
558169	213719674010	AMM19674	
MF015	213719765010	AMM19765	
MF051	213719652010	AMM19652	
FACET			
101191	213719752010	AMM19752	
FCA			
9658127480	213719656010	AMM19656	
FEBI BILSTEIN			
31412	213719752010	AMM19752	

OE/IAM	MAGNETI MARELLI	
	LONG	SHORT
B4	SENSORE MASSA ARIA AIR MASS SENSOR	
FORD		
1054419	213719780010	AMM19780
1129009	213719664010	AMM19664
1148059	213719765010	AMM19765
1209109	213719752010	AMM19752
1255117	213719654010	AMM19654
1337337	213719665010	AMM19665
1348614	213719765010	AMM19765
1348615	213719651010	AMM19651
1365122	213719655010	AMM19655
1376235	213719656010	AMM19656
1480570	213719764010	AMM19764
1516668	213719770010	AMM19770
4515688	213719652010	AMM19652
6848046	213719766010	AMM19766
6848047	213719657010	AMM19657
2S6Q12B579AA	213719765010	AMM19765
2S6Q12B579AB	213719765010	AMM19765
2S6Q12B579BB	213719651010	AMM19651
3L3A128579BA	213719652010	AMM19652
3M2112B529AA	213719752010	AMM19752
3M5A12B579BB	213719654010	AMM19654
4M5112B579CC	213719655010	AMM19655
6C1112B579AA	213719656010	AMM19656
7M5112B579BB	213719764010	AMM19764
8V2112B579AA	213719770010	AMM19770
92FB12B579AA	213719766010	AMM19766
92FB12B579BA	213719766010	AMM19766
93BB12B579BA	213719657010	AMM19657
XS7F12B579AA	213719664010	AMM19664
XS7F12B579BA	213719665010	AMM19665
HELLA		
009142221	213719769010	AMM19769
009142451	213719769010	AMM19769
8ET009142221	213719769010	AMM19769
8ET009142291	213719780010	AMM19780
8ET009142391	213719765010	AMM19765
8ET009142451	213719769010	AMM19769
8ET009142571	213719752010	AMM19752
8ET009142591	213719652010	AMM19652

OE/IAM	MAGNETI MARELLI	
	LONG	SHORT
B4	SENSORE MASSA ARIA AIR MASS SENSOR	
HITACHI		
2505081	213719652010	AMM19652
AFH6010A	213719672010	AMM19672
AFH6010B	213719666010	AMM19666
AFH6010C	213719670010	AMM19670
AFH7008B	213719669010	AMM19669
AFH7008C	213719667010	AMM19667
AFH7008D	213719671010	AMM19671
AFH7025G	213719769010	AMM19769
AFH70M83	213719770010	AMM19770
AFH7501A	213719674010	AMM19674
LAND ROVER		
MHK501040	213719656010	AMM19656
MAPCO		
42814	213719752010	AMM19752
MEAT & DORIA		
86043	213719666010	AMM19666
86044	213719671010	AMM19671
86049	213719672010	AMM19672
86051	213719780010	AMM19780
86058	213719769010	AMM19769
86080	213719670010	AMM19670
86099	213719752010	AMM19752
86121	213719765010	AMM19765
86129	213719667010	AMM19667
86152	213719674010	AMM19674
86170	213719652010	AMM19652
86269	213719669010	AMM19669
86298	213719770010	AMM19770
METZGER		
0891055	213719752010	AMM19752
0891072	213719752010	AMM19752
PIERBURG		
722184150	213719674010	AMM19674
722184200	213719780010	AMM19780
722184230	213719652010	AMM19652
722184240	213719656010	AMM19656
722184250	213719764010	AMM19764
722184260	213719664010	AMM19664
722184270	213719665010	AMM19665
722184290	213719651010	AMM19651
722184300	213719655010	AMM19655
722184320	213719657010	AMM19657
722184330	213719766010	AMM19766

OE/IAM	MAGNETI MARELLI	
	LONG	SHORT
B4	SENSORE MASSA ARIA AIR MASS SENSOR	
PIERBURG		
722184400	213719666010	AMM19666
722184410	213719670010	AMM19670
722184530	213719669010	AMM19669
722684080	213719752010	AMM19752
728342060	213719654010	AMM19654
PSA		
9642212180	213719765010	AMM19765
9657127480	213719656010	AMM19656
1920EK	213719765010	AMM19765
1920KQ	213719656010	AMM19656
SIDAT		
38614	213719780010	AMM19780
38620	213719672010	AMM19672
38622	213719666010	AMM19666
38624	213719671010	AMM19671
38641	213719670010	AMM19670
38660	213719667010	AMM19667
38667	213719765010	AMM19765
38668	213719752010	AMM19752
38746	213719669010	AMM19669
38826	213719652010	AMM19652
38827	213719674010	AMM19674
38894	213719770010	AMM19770
38610-2	213719769010	AMM19769
SIEMENS VDO		
5WK9631Z	213719765010	AMM19765
A2C59513542	213719752010	AMM19752
A2C59514878	213719652010	AMM19652
SWAG		
30931412	213719752010	AMM19752
VAG		
058133471	213719666010	AMM19666
000VT5077	213719752010	AMM19752
037906461B	213719672010	AMM19672
059906461D	213719769010	AMM19769
059906461DX	213719769010	AMM19769
059906461G	213719769010	AMM19769
059906461GX	213719769010	AMM19769
059906461M	213719769010	AMM19769
059906461MX	213719769010	AMM19769
06A906461B	213719670010	AMM19670
06C133471A	213719674010	AMM19674
074906461B	213719752010	AMM19752

OE/IAM	MAGNETI MARELLI	
	LONG	SHORT
B4	SENSORE MASSA ARIA AIR MASS SENSOR	
VAG		
078133471A	213719669010	AMM19669
078133471C	213719667010	AMM19667
078133471E	213719671010	AMM19671
VEMO		
V10721038	213719752010	AMM19752
VOLVO		
30757655	213719770010	AMM19770
30777415	213719656010	AMM19656

OE/IAM	MAGNETI MARELLI	
	LONG	SHORT
B5	SENSORE PEDALE ACCELERATORE ACCELERATOR PEDAL SENSOR	
BOSCH		
0281002278	805000006010	PAS006
0281002298	805000004010	PAS004
0281002334	805000005010	PAS005
0281002506	805000003010	PAS003
FCA		
46825442	805000003010	PAS003
51785804	805000003010	PAS003
GENERAL MOTORS		
9157998	805000001010	PAS001
9193186	805000001010	PAS001
HELLA		
010946041	805000001010	PAS001
6PV008112005	805000001010	PAS001
6PV008112006	805000001010	PAS001
6PV008112007	805000001010	PAS001
6PV008112008	805000001010	PAS001
6PV010946041	805000001010	PAS001
MERCEDES-BENZ		
9013000404	805000005010	PAS005
OPEL		
848003	805000001010	PAS001
848028	805000002010	PAS002
848119	805000006010	PAS006
848179	805000004010	PAS004
9117961	805000006010	PAS006
9118160	805000004010	PAS004
9128851	805000006010	PAS006
9157998	805000001010	PAS001
9193186	805000001010	PAS001
13305804	805000002010	PAS002
90581208	805000004010	PAS004

OE/IAM	MAGNETI MARELLI	
	LONG	SHORT
B5	SENSORE PEDALE ACCELERATORE ACCELERATOR PEDAL SENSOR	
SIDAT		
84428	805000001010	PAS001
430330023	805000002010	PAS002
VAUXHALL		
9157998	805000001010	PAS001
9193186	805000001010	PAS001

OE/IAM	MAGNETI MARELLI	
	LONG	SHORT
B6	SENSORE POSIZIONE FARFALLA THROTTLE POSITION SENSOR	
BMW		
13541717603	215810606200	SVF012
13631710559	215810606000	SVF010
13631717603	215810606200	SVF012
BOSCH		
0280120300	215810605900	SVF009
0280120310	215810606000	SVF010
0280120316	215810606200	SVF012
0280120327	215810606000	SVF010
0280122001	215810606500	SVF015
0280122004	215810606500	SVF015
0280122008	215810606500	SVF015
0280122014	215810606600	SVF016
0280122016	215810606600	SVF016
F00099S002	219244300500	KITPF1C
F00099S004	215810606300	SVF013
F00099S006	810007726502	CA0077265/1
DELPHI		
SS1042511B1	215810606300	SVF013
SS1042911B1	215810606400	SVF014
ERA		
550145	215810606400	SVF014
550146	215810606300	SVF013
550149	219244240500	KITPF2C
550150	219244300500	KITPF1C
550193	215810605500	SVF005
550238	230016080057	PF90/018
550269	810007726502	CA0077265/1
550270	230016080067	PF16080067
550301	215810606600	SVF016
550399	215810606100	SVF011
550511	810000550401	CA0005504
550146B	215810606300	SVF013
550301B	215810606600	SVF016

OE/IAM	MAGNETI MARELLI	
	LONG	SHORT
B6	SENSORE POSIZIONE FARFALLA THROTTLE POSITION SENSOR	
FACET		
105001	219244240500	KITPF2C
105002	215810606500	SVF015
105032	215810606000	SVF010
105064	215810605600	SVF006
105079	215810606000	SVF010
105083	219244300500	KITPF1C
105084	215810605900	SVF009
105086	215810606600	SVF016
105091	215810606200	SVF012
FCA		
121517	215810606000	SVF010
4430294	215810605900	SVF009
7637025	215810606500	SVF015
7706580	215810605900	SVF009
9944468	219244240500	KITPF2C
9945634	219244300500	KITPF1C
9946862	215810606500	SVF015
60512672	215810605900	SVF009
60549359	215810606500	SVF015
60808043	215810606500	SVF015
60811198	215810606500	SVF015
71738921	215800192960	IPF2C
77065800	215810605900	SVF009
77065804	215810605900	SVF009
90549359	215810606500	SVF015
605126720	215810605900	SVF009
605493590	215810606500	SVF015
960389388	215810606500	SVF015
9565855480	230016080057	PF90/018
9603893880	215810606500	SVF015
9625148180	230016080067	PF16080067
195001102200	215810605900	SVF009
FEBI BILSTEIN		
14784	215810606200	SVF012
14787	215810605900	SVF009
17732	215810606400	SVF014
FORD		
1001591	215810605500	SVF005
1071403	215810605800	SVF008
6854778	215810605000	SVF001
7173046	215810605600	SVF006
87SF9B989CA	215810605000	SVF001
95BF9B989DA	215810605500	SVF005

OE/IAM	MAGNETI MARELLI	
	LONG	SHORT
B6	SENSORE POSIZIONE FARFALLA THROTTLE POSITION SENSOR	
FORD		
95BF9B989JB	215810605600	SVF006
988F9B989BB	215810605800	SVF008
GENERAL MOTORS		
17080671	215810606300	SVF013
17080681	215810606300	SVF013
17087653	215810606300	SVF013
17103174	215810606300	SVF013
17106681	215810606300	SVF013
17111815	215810606300	SVF013
17112688	215810606300	SVF013
17113070	215810606300	SVF013
90281020	215810606200	SVF012
90281520	215810606200	SVF012
94580175	215810606300	SVF013
HELLA		
6PX008476001	215810605900	SVF009
6PX008476051	215810606000	SVF010
6PX008476061	215810606200	SVF012
6PX008476121	215810606400	SVF014
6PX008476131	215810606300	SVF013
6PX008476231	215810606500	SVF015
6PX008476251	215810606600	SVF016
6PX008476361	215810606600	SVF016
6PX008476371	215810606200	SVF012
6PX008476461	219244300500	KITPF1C
HONDA		
37890PDFE01	215810606600	SVF016
HYUNDAI		
3517022001	215810606500	SVF015
3517022010	215810606500	SVF015
3517022600	215810606600	SVF016
3517037100	215810606100	SVF011
INTERMOTOR		
19900	215810605900	SVF009
19903	215810606000	SVF010
19904	215810606200	SVF012
19906	215810606000	SVF010
19910	215810606300	SVF013
19936	215810606600	SVF016

OE/IAM	MAGNETI MARELLI	
	LONG	SHORT
B6	SENSORE POSIZIONE FARFALLA THROTTLE POSITION SENSOR	
KIA		
0K01118911	215810606500	SVF015
0K24718911	215810606500	SVF015
0K30A18911	215810606500	SVF015
LAND ROVER		
ERR7322	215810606600	SVF016
LUCAS ELECTRICAL		
LRX125	215810605900	SVF009
SEB185	215810606200	SVF012
SEB190	215810606000	SVF010
SEB847	215810606300	SVF013
SEB856	215810606600	SVF016
MAGNETI MARELLI		
CA0005504	810000550401	CA0005504
CA0019296A	215800192960	IPF2C
CA0077265/1	810007726502	CA0077265/1
CP90/011	230016036007	CP90/011
IPF2C	215800192960	IPF2C
KITPF1C	219244300500	KITPF1C
KITPF2C	219244240500	KITPF2C
PF16080067	230016080067	PF16080067
PF90/018	230016080057	PF90/018
WTP077	215800192960	IPF2C
MEAT & DORIA		
83001	219244240500	KITPF2C
83003	215810605900	SVF009
83007	215810606300	SVF013
83008	215810606400	SVF014
83016	215810606200	SVF012
83027	215810606000	SVF010
83030	230016080057	PF90/018
83043	810000550401	CA0005504
83045	215810606600	SVF016
83050	219244300500	KITPF1C
83065	215810605500	SVF005
83105	810007726502	CA0077265/1
83106	230016080067	PF16080067
83110	215810606100	SVF011
METZGER		
0904022	215810606100	SVF011
NISSAN		
226201F700	215810606600	SVF016

OE/IAM	MAGNETI MARELLI	
	LONG	SHORT
B6	SENSORE POSIZIONE FARFALLA THROTTLE POSITION SENSOR	
OPEL		
817204	215810606400	SVF014
825463	215810606500	SVF015
825482	215810606300	SVF013
825483	215810606300	SVF013
825484	215810606300	SVF013
826288	215810606200	SVF012
826924	215810606500	SVF015
5826473	215810606600	SVF016
17080671	215810606300	SVF013
17087653	215810606300	SVF013
17106681	215810606300	SVF013
17106682	215810606400	SVF014
90323839	215810606500	SVF015
90486133	215810606500	SVF015
90530439	215810606600	SVF016
90541502	215810606600	SVF016
94580175	215810606300	SVF013
PIERBURG		
40200320	215810606300	SVF013
40200324	215810606500	SVF015
402003020	219244300500	KITPF1C
402003030	219244240500	KITPF2C
402003040	215810606400	SVF014
402003070	215810605600	SVF006
402003110	215810605000	SVF001
402003150	215810605800	SVF008
402003180	215810605500	SVF005
402003200	215810606300	SVF013
402003240	215810606500	SVF015
402003250	215810606000	SVF010
402003370	215810605900	SVF009
402003420	215810606200	SVF012
402003530	215810606600	SVF016
PSA		
500799	810000550401	CA0005504
72408124	215810606500	SVF015
72408125	215810606500	SVF015
91519925	215810606000	SVF010
96015940	215810606000	SVF010
96038938	215810606500	SVF015
96081740	215810606000	SVF010
9151992580	215810606000	SVF010
9564463180	219244240500	KITPF2C

OE/IAM	MAGNETI MARELLI	
	LONG	SHORT
B6	SENSORE POSIZIONE FARFALLA THROTTLE POSITION SENSOR	
PSA		
9565855480	230016080057	PF90/018
9601594080	215810606000	SVF010
9605319980	230016036007	CP90/011
9608174080	215810606000	SVF010
9625148180	230016080067	PF16080067
1920E7	230016036007	CP90/011
16281E	810000550401	CA0005504
1628A3	215810606000	SVF010
1628G4	215810606000	SVF010
1628L1	215810606500	SVF015
1635Z9	810007726502	CA0077265/1
1920N0	230016080057	PF90/018
1920T8	230016080067	PF16080067
1920Z4	215810606500	SVF015
RENAULT		
7701034407	215810606500	SVF015
7701044753	810000550401	CA0005504
7701047921	215810606500	SVF015
7701070837	219244240500	KITPF2C
7701204055	219244240500	KITPF2C
SAAB		
750161	215810605900	SVF009
885719	215810606500	SVF015
4661062	215810606500	SVF015
7501612	215810605900	SVF009
8857195	215810606500	SVF015
9181538	215810606600	SVF016
9393463	215810605900	SVF009
SIDAT		
84102	219244240500	KITPF2C
84103	215810606500	SVF015
84104	215810605900	SVF009
84107	215810606300	SVF013
84108	215810606400	SVF014
84114	215810606200	SVF012
84117	215810605900	SVF009
84119	230016080057	PF90/018
84120	810000550401	CA0005504
84121	215810606600	SVF016
84122	219244300500	KITPF1C
84123	215810605500	SVF005
84140	810007726502	CA0077265/1
84141	230016080067	PF16080067

GRUPPI B-C - GROUPS B-C

OE/IAM	MAGNETI MARELLI	
	LONG	SHORT
B6	SENSORE POSIZIONE FARFALLA THROTTLE POSITION SENSOR	
SIDAT		
84145	215810606100	SVF011
75932002	215810606000	SVF010
SWAG		
40914784	215810606200	SVF012
TOPRAN		
205629	215810606300	SVF013
TOYOTA		
8945205010	215810606500	SVF015
VAG		
035906111	215810605900	SVF009
94460611600	215810606500	SVF015
94460611601	215810606500	SVF015
99660611600	215810606600	SVF016
VEMO		
20720408	215810606000	SVF010
20720409	215810606200	SVF012
40720311	215810606300	SVF013
40720384	215810606600	SVF016
50720011	215810605900	SVF009
VOLVO		
1336385	215810606500	SVF015
3450030	215810606500	SVF015
13363858	215810606500	SVF015

B2	TUBO CONN. CANISTER TUBE CONNECTING CANISTER VALVE	
MAGNETI MARELLI		
AD0000536A	806000536010	KITBLOW
KITBLOW	806000536010	KITBLOW
PSA		
1635P2	806000536010	KITBLOW

B2	VALVOLA DI REGOLAZIONE IDLE CONTROL VALVE	
ERA		
556022	820003390010	VAE3390
556026	820003391010	VAE3391
FORD		
1086369	820003391010	VAE3391
1113127	820003390010	VAE3390
1S4U9F715BC	820003390010	VAE3390
XS6U9F715AA	820003391010	VAE3391

OE/IAM	MAGNETI MARELLI	
	LONG	SHORT
B2	VALVOLA DI REGOLAZIONE IDLE CONTROL VALVE	
HELLA		
009141021	820003391010	VAE3391
009141561	820003390010	VAE3390
6NW009141021	820003391010	VAE3391
6NW009141561	820003390010	VAE3390
HITACHI		
AESP1062A	820003391010	VAE3391
MEAT & DORIA		
85023	820003391010	VAE3391
85028	820003390010	VAE3390
PIERBURG		
402003630	820003391010	VAE3391
SIDAT		
87061	820003391010	VAE3391
87066	820003390010	VAE3390
SIEMENS VDO		
H002	820003391010	VAE3391
VEMO		
V257700021	820003391010	VAE3391
V25770004	820003390010	VAE3390

GRUPPO C - GROUP C		
	INIETTORE FUEL INJECTOR	
BLUE PRINT		
ADG02801	805000000003	FEI0003
BOSCH		
0280156154	805000000014	FEI0014
0280156155	805000000011	FEI0011
0280156156	805000000009	FEI0009
0280156323	230016209077	IPM001
0280156324	230016209087	IPM002
0280158105	805000000007	FEI0007
0280158171	805000347507	IWP058
0280158181	805000000004	FEI0004
0280158200	805000000017	FEI0017
0280158207	805000000013	FEI0013
0280158218	805000000006	FEI0006
0280158257	805001143004	IWP092
0280158501	805000000004	FEI0004
CHEVROLET		
96620255	805000000003	FEI0003

OE/IAM	MAGNETI MARELLI	
	LONG	SHORT
INIETTORE FUEL INJECTOR		
DAEWOO		
96351840	805000000003	FEI0003
96518620	805000000003	FEI0003
96620255	805000000003	FEI0003
ERA		
780000	805000000014	FEI0014
780008	805000000003	FEI0003
FCA		
7751313	214310000110	IWP001/1
46433547	214310002310	IWP023
46451791	214310004510	IWP045
46522035	214310006400	IWP064
46791211	805001230403	IWP116/1
60657179	214310000610	IWP006
71718655	805001230403	IWP116/1
71718998	214310006400	IWP064
71719037	214310000110	IWP001/1
71719101	214310002310	IWP023
71729224	805001230403	IWP116/1
71737174	805001843601	IWP164
71792994	805001800302	IWP160
77363790	805001800302	IWP160
504328430	805009297100	IPM019
FORD		
1004144	805000346108	IWP022
1038777	805000000012	FEI0012
1071994	805000000017	FEI0017
1149486	805000000011	FEI0011
1149646	805000136213	IWP119
1149958	805000000014	FEI0014
1221551	805000000008	FEI0008
1222310	805000000017	FEI0017
1355925	805000000009	FEI0009
1361203	805000000007	FEI0007
1429840	805000000017	FEI0017
1538984	805000000013	FEI0013
1562024	805000000010	FEI0010
1575142	805000000006	FEI0006
4378509	805000000005	FEI0005
1L5G9F593BA	805000000011	FEI0011
1L5Z9F593AA	805000000011	FEI0011
1L5Z9F593BA	805000000011	FEI0011
1S7G9F593GA	805000000014	FEI0014
2M2E9F593A7B	805000000005	FEI0005

OE/IAM	MAGNETI MARELLI	
	LONG	SHORT
INIETTORE FUEL INJECTOR		
FORD		
2N1U9F593JA	805000000008	FEI0008
2N1U9F593KA	805000136213	IWP119
3M4G9F593BA	805000000009	FEI0009
7L5G9F593AB	805000000007	FEI0007
8A6G9F593AA	805000000013	FEI0013
97MF9F593BA	805000000012	FEI0012
98MF9F593BA	805000000017	FEI0017
98MF9F593BB	805000000017	FEI0017
98MF9F593BC	805000000017	FEI0017
9M5N9F593AA	805000000006	FEI0006
9S519F593DA	805000000010	FEI0010
VP8A6U9F593AA	805000000013	FEI0013
INTERMOTOR		
31079	805000000008	FEI0008
31084	805000000012	FEI0012
31085	805000000007	FEI0007
31088	805000000005	FEI0005
31090	805000000010	FEI0010
31091	805000000006	FEI0006
31092	805000000009	FEI0009
MAGNETI MARELLI		
50102602Y	805501026020	IWP143
IPM001	230016209077	IPM001
IPM002	230016209087	IPM002
IPM012	805001754001	IPM012
IPM019	805009297100	IPM019
IWP001/1	214310000110	IWP001/1
IWP006	214310000610	IWP006
IWP022	805000346108	IWP022
IWP023	214310002310	IWP023
IWP024	805501007020	IWP024
IWP042	805001446001	IWP042
IWP044	805501008020	IWP044
IWP045	214310004510	IWP045
IWP049/1	805000347304	IWP049/1
IWP058	805000347507	IWP058
IWP064	214310006400	IWP064
IWP091	805001138503	IWP091
IWP092	805001143004	IWP092
IWP095	805001230403	IWP116/1
IWP098	805001399403	IWP098
IWP099	805001388502	IWP099
IWP116/1	805001230403	IWP116/1

OE/IAM

MAGNETI
MARELLI

LONG

SHORT

INIETTORE
FUEL INJECTOR**MAGNETI MARELLI**

IWP119	805000136213	IWP119
IWP123	805001372104	IWP123
IWP142	805001571701	IWP142
IWP160	805001800302	IWP160
IWP163	805001836801	IWP163
IWP164	805001843601	IWP164

MAZDA

FSJ213250	805000000014	FEI0014
L30113250A	805000000014	FEI0014
L30913250A	805000000009	FEI0009
LF0113250A	805000000011	FEI0011

MEAT & DORIA

75112001	214310000110	IWP001/1
75112006	214310000610	IWP006
75112022	805000346108	IWP022
75112023	214310002310	IWP023
75112045	214310004510	IWP045
75112049	805000347304	IWP049/1
75112064	214310006400	IWP064
75112092	805001143004	IWP092
75112095	805001230403	IWP116/1
75112098	805001399403	IWP098
75112099	805001388502	IWP099
75112119	805000136213	IWP119
75112123	805001372104	IWP123
75112142	805001571701	IWP142
75112160	805001800302	IWP160
75112163	805001836801	IWP163
75112164	805001843601	IWP164
75112201	230016209077	IPM001
75112202	230016209087	IPM002
75112212	805001754001	IPM012
75112242	805001446001	IWP042
75112258	805000347507	IWP058
75114207	805000000013	FEI0013
75114255	805000000003	FEI0003
75114501	805000000004	FEI0004
75116154	805000000014	FEI0014
75117168	805000000002	FEI0002
75117801	805000000001	FEI0001

OPEL

5817425	805000000004	FEI0004
24420543	805000000004	FEI0004

OE/IAM

MAGNETI
MARELLI

LONG

SHORT

INIETTORE
FUEL INJECTOR**PSA**

1984E0	805000000002	FEI0002
9624721880	805000347304	IWP049/1
9625587380	230016209077	IPM001
9625587580	230016209087	IPM002
9627771580	214310000610	IWP006
9648148580	805001754001	IPM012
1984C2	230016209077	IPM001
1984C8	805000347304	IWP049/1
1984C9	230016209087	IPM002
1984F4	805001754001	IPM012

RENAULT

7700874112	805000000001	FEI0001
8200025248	805001388502	IWP099
8200028797	805001446001	IWP042
8200058379	805001399403	IWP098
8200128959	805001571701	IWP142
8200207049	805001446001	IWP042
8200242376	805501026020	IWP143
8200603801	805000000001	FEI0001

SIDAT

81172	230016209077	IPM001
81173	805001800302	IWP160
81174	230016209087	IPM002
81213	805000000001	FEI0001
81214	805001388502	IWP099
81219	805001843601	IWP164
81221	214310000110	IWP001/1
81222	214310000610	IWP006
81223	805000346108	IWP022
81224	214310002310	IWP023
81225	214310004510	IWP045
81226	805000347304	IWP049/1
81227	214310006400	IWP064
81228	805001143004	IWP092
81229	805001230403	IWP116/1
81230	805001399403	IWP098
81231	805000136213	IWP119
81232	805001372104	IWP123
81233	805001571701	IWP142
81234	805001836801	IWP163
81235	805001754001	IPM012
81236	805001446001	IWP042
81237	805000347507	IWP058

OE/IAM	MAGNETI MARELLI	
	LONG	SHORT
INIETTORE FUEL INJECTOR		
SIDAT		
81242	805000000003	FEI0003
81243	805000000004	FEI0004
81251	805000000014	FEI0014
81253	805000000002	FEI0002
81306	805000000013	FEI0013
SIEMENS VDO		
873774	805000000001	FEI0001
01F002A	805000000002	FEI0002
H00101F002A	805000000002	FEI0002
VAG		
269980312	805501007020	IWP024
279980311	805501008020	IWP044
021906031D	805000346108	IWP022
032906031A	214310002310	IWP023
036906031AC	805001836801	IWP163
036906031C	805000347507	IWP058
036906031G	805001143004	IWP092
036906031Q	805001138503	IWP091
036906031T	805001372104	IWP123
VALEO		
348001	805000000002	FEI0002
VOLVO		
30711782	805000000014	FEI0014
30757500	805000000009	FEI0009

KIT INIETTORE FUEL INJECTOR KIT		
FCA		
7078993	805001442401	KIT IWP065
7082831	805001442401	KIT IWP065
46481318	805001442401	KIT IWP065
MAGNETI MARELLI		
KITIWP065	805001442401	KIT IWP065

GRUPPO D - GROUP D		
SENSORE PRESSIONE ASSOLUTA MAP SENSOR		
BERU		
0824311005	215810006000	APS40
SPR204	215810006000	APS40

OE/IAM	MAGNETI MARELLI	
	LONG	SHORT
SENSORE PRESSIONE ASSOLUTA MAP SENSOR		
BLUE PRINT		
ADG074205	215810006500	APS45
ADH274202	215810009300	APS73
BMW		
2244674	215810006200	APS42
2246977	215810005000	APS30
7787142	215810005200	APS32
13617787142	215810005200	APS32
13622244674	215810006200	APS42
13622246977	215810005000	APS30
BOSCH		
0261230004	215810004900	APS29
0261230007	215810004900	APS29
0261230008	215810004900	APS29
0261230012	215810009600	APS76
0261230013	215810007400	APS54
0261230020	215810004400	APS24
0261230029	215810005100	APS31
0261230030	806001723701	KITLDF6T
0261230035	215810007900	APS59
0261230037	215810004900	APS29
0261230038	215810004900	APS29
0261230041	215810008200	APS62
0261230043	215810009700	APS77
0261230044	215810003900	APS19
0261230046	215810007700	APS57
0261230049	215810004300	APS23
0261230052	215810007500	APS55
0261230058	215810008200	APS62
0261230081	215810009000	APS70
0261230082	215810009000	APS70
0261230090	215810004200	APS22
0261230119	215810009800	APS78
0261230120	215810009800	APS78
0261230135	215810006700	APS47
0261230136	215810009100	APS71
0261230189	215810005300	APS33
0261230190	215810005300	APS33
0261230191	215810008000	APS60
0261230192	215810008000	APS60
0261230266	215810006000	APS40
0261230267	215810006000	APS40
0281002177	215810005900	APS39
0281002178	215810005900	APS39

OE/IAM

MAGNETI
MARELLI

LONG

SHORT

SENSORE PRESSIONE ASSOLUTA
MAP SENSOR**BOSCH**

0281002205	215810008400	APS64
0281002215	215810005100	APS31
0281002241	215810006800	APS48
0281002242	215810006800	APS48
0281002399	215810006000	APS40
0281002400	215810006000	APS40
0281002438	215810004600	APS26
0281002487	215810007300	APS53
0281002510	215810004300	APS23
0281002514	215810007000	APS50
0281002552	215810004300	APS23
0281002573	215810007100	APS51
0281002593	215810005700	APS37
0281002709	215810008700	APS67
0281002740	215810006600	APS46
0281002783	215810008300	APS63
0281002784	215810008300	APS63
0281002845	215810004500	APS25
0281002903	215810006900	APS49
0281002958	215810006600	APS46
0281002961	215810006600	APS46
0281002998	215810005600	APS36
0281002999	215810005600	APS36
0281006028	215810005600	APS36
0281006029	215810005600	APS36
0281006158	215810006900	APS49
F00099M003	215810001604	PRT03/04
F00099P003	215810001604	PRT03/04
F00099P169	215810006500	APS45
F00099P218	806001535002	KITTPRT05/2

BOUGICORD

002399	215810006000	APS40
--------	--------------	--------------

CHEVROLET

96482570	215810008500	APS65
----------	--------------	--------------

DACIA

223657266R	215810005700	APS37
------------	--------------	--------------

DAEWOO

12614970	215810006400	APS44
16137039	215810006500	APS45
16212460	215810006400	APS44

OE/IAM

MAGNETI
MARELLI

LONG

SHORT

SENSORE PRESSIONE ASSOLUTA
MAP SENSOR**DELPHI**

PS1000211B1	215810006400	APS44
PS10028	215810009300	APS73
PS1007511B1	215810006500	APS45
PS1008611B1	215810006300	APS43
PS1009412B1	215810001604	PRT03/04

DENSO

0798003260	215810006200	APS42
0798004480	215810005500	APS35
0798005410	215810009400	APS74
0798005600	215810005800	APS38
0798007450	215810005800	APS38

ERA

550080	215810001604	PRT03/04
550097	215810004300	APS23
550098	806001723701	KITLDF6T
550125	806001535002	KITTPRT05/2
550131	215810009600	APS76
550132	215810005900	APS39
550133	215810009700	APS77
550136	215810008200	APS62
550137	215810005100	APS31
550140	215810006500	APS45
550141	215810006400	APS44
550142	215810008000	APS60
550143	215810005300	APS33
550157	215810003900	APS19
550158	215810003400	APS14
550173	215810005700	APS37
550244	215810004500	APS25
550257	215810007900	APS59
550261	215810004200	APS22
550266	215810004600	APS26
550276	215810009300	APS73
550303	215810007500	APS55
550325	215810007400	APS54
550360	215810005100	APS31
550362	215810004400	APS24
550392	215810008500	APS65
550395	215810007600	APS56
550412	215810009800	APS78
550421	215810009900	APS79
550462	215810007800	APS58
550569	215810005800	APS38

OE/IAM	MAGNETI MARELLI	
	LONG	SHORT

SENSORE PRESSIONE ASSOLUTA MAP SENSOR		
--	--	--

ERA		
550605	215810009000	APS70
550606	215810006000	APS40
550665	215810005500	APS35
550666	215810005200	APS32
550668	215810008700	APS67
550669	215810009100	APS71
550687	215810007700	APS57
550702	215810007000	APS50
550739	215810008400	APS64
550740	215810004800	APS28
550741	215810006300	APS43
550753	215810005600	APS36
550755	215810008300	APS63
550806	215810006600	APS46
550133B	215810009700	APS77
550140B	215810006500	APS45
550141B	215810006400	APS44
550142B	215810008000	APS60
550143B	215810005300	APS33
550173B	215810005700	APS37
550266B	215810004600	APS26
550325B	215810007400	APS54
550362B	215810004400	APS24
550665B	215810005500	APS35
550666B	215810005200	APS32
55325B	215810007400	APS54

FACET		
-------	--	--

103001	215810006500	APS45
103003	215810001604	PRT03/04
103006	215810006100	APS41
103010	215810009600	APS76
103011	215810006400	APS44
103012	215810005900	APS39
103013	215810005100	APS31
103015	215810004900	APS29
103020	215810003100	APS11
103022	215810007300	APS53
103024	215810006300	APS43
103026	215810009400	APS74
103029	215810006200	APS42
103030	215810005500	APS35
103032	215810009300	APS73
103034	215810005800	APS38

OE/IAM	MAGNETI MARELLI	
	LONG	SHORT

SENSORE PRESSIONE ASSOLUTA MAP SENSOR		
--	--	--

FACET		
103051	215810004800	APS28
103053	215810004400	APS24
103055	215810004300	APS23
103056	215810008200	APS62
103058	215810003500	APS15
103059	215810003400	APS14
103064	215810005400	APS34
103077	215810003200	APS12
103078	215810004200	APS22
103080	215810009700	APS77
103081	806001535002	KITTPRT05/2
103082	215810004500	APS25
103083	215810006000	APS40
103086	215810003800	APS18
103087	215810008900	APS69
103091	806001723701	KITLDF6T
103093	215810003700	APS17
103097	215810003300	APS13
103100	215810003900	APS19
103102	215810008000	APS60
103106	215810005300	APS33
103114	215810004600	APS26
103115	215810007700	APS57
103116	215810005200	APS32
103117	215810005000	APS30
103125	215810008100	APS61
103132	215810009500	APS75
103133	215810007500	APS55
103136	215810007800	APS58
103157	215810009000	APS70
103164	215810006700	APS47
103167	215810008700	APS67
103177	215810006600	APS46
103205	215810004000	APS20

FAE		
-----	--	--

15001	215810006500	APS45
15011	215810008200	APS62
15014	215810004900	APS29
15017	215810005500	APS35
15018	215810004800	APS28
15021	215810007500	APS55
15023	215810005400	APS34
15025	215810005300	APS33

OE/IAM	MAGNETI MARELLI	
	LONG	SHORT
SENSORE PRESSIONE ASSOLUTA MAP SENSOR		
FAE		
15028	215810005200	APS32
15029	215810005000	APS30
15037	215810006000	APS40
15040	215810009500	APS75
15042	215810009000	APS70
15045	215810008700	APS67
15046	215810005800	APS38
15051	215810006200	APS42
15052	215810007700	APS57
15053	215810004600	APS26
15059	215810004400	APS24
15064	215810008100	APS61
15066	215810008900	APS69
15074	215810008000	APS60
15076	215810009300	APS73
15078	215810009400	APS74
15079	215810006300	APS43
15091	215810006700	APS47
15092	215810006600	APS46
15094	215810008400	APS64
15097	215810007000	APS50
15108	215810007800	APS58
15113	215810009900	APS79
15116	215810007600	APS56
15119	215810007400	APS54
15122	215810008500	APS65
15128	215810009800	APS78
16106	215810008300	APS63
FCA		
272880	215810005600	APS36
5234313	215810006500	APS45
7529274	215810004900	APS29
7696064	215810006500	APS45
33000153	215810006500	APS45
46468682	215810005100	APS31
46474585	215810007900	APS59
46531222	215810001604	PRT03/04
46769979	215810007500	APS55
46811235	215810004300	APS23
55194788	215810008300	APS63
55200301	215810008300	APS63
55206796	215810004300	APS23
55206797	215810004500	APS25

OE/IAM	MAGNETI MARELLI	
	LONG	SHORT
SENSORE PRESSIONE ASSOLUTA MAP SENSOR		
FCA		
55207677	215810006900	APS49
55218298	215810005600	APS36
55219294	215810004300	APS23
55219298	215810005600	APS36
60575356	215810001604	PRT03/04
60811067	215810001604	PRT03/04
60811534	215810006500	APS45
60814507	215810001604	PRT03/04
71714218	806001535002	KITTPRT05/2
71732447	806001723701	KITLDF6T
71739292	215810006400	APS44
71755054	230016070077	PRT03E/04
77363792	215810007500	APS55
77364869	806001723701	KITLDF6T
99455421	215810008400	APS64
500351377	215810007000	APS50
504247741	215810006900	APS49
552182980	215810005600	APS36
9618261580	215810009600	APS76
9631716680	215810005500	APS35
9639381480	215810009700	APS77
9639418980	215810008200	APS62
9639469280	215810005800	APS38
9649396580	215810007800	APS58
FEBI BILSTEIN		
37056	215810005300	APS33
FORD		
1023008	215810003400	APS14
1087424	215810003700	APS17
1110963	215810003800	APS18
1111222	215810005900	APS39
1113276	215810003200	APS12
1119939	215810003900	APS19
1127268	215810003500	APS15
1141598	215810003300	APS13
1144420	215810003100	APS11
1231463	215810005800	APS38
1256481	215810005800	APS38
1338678	215810009800	APS78
1367813	215810004200	APS22
1427942	215810007800	APS58
1438809	215810007800	APS58
1439900	215810003900	APS19

OE/IAM	MAGNETI MARELLI	
	LONG	SHORT

SENSORE PRESSIONE ASSOLUTA MAP SENSOR		
--	--	--

FORD		
1468879	215810005800	APS38
1490907	215810003300	APS13
1503280	215810004000	APS20
1516717	215810009900	APS79
1879414	215810003200	APS12
1M5F9S428AB	215810003100	APS11
1S4A9F479BA	215810003200	APS12
1S7A9F479AB	215810003900	APS19
1S7A9F479AC	215810003900	APS19
2S6A9F479BA	215810003300	APS13
2S6A9F479BB	215810003300	APS13
2S6A9F479CB	215810009900	APS79
4M519F479AA	215810009800	APS78
6C119F479AB	215810004000	APS20
6G9Q9F479AB	215810007800	APS58
6M5Y9F479AA	215810004200	APS22
97VB9F479BA	215810003400	APS14
98AB9S428AB	215810003500	APS15
99VW9E928AA	215810005900	APS39
XS6F9F479AB	215810003700	APS17
YS6A9F479AA	215810003800	APS18

GENERAL MOTORS		
----------------	--	--

1235084	215810005600	APS36
9109593	215810004300	APS23
9389131	215810006500	APS45
12569240	215810006500	APS45
12614970	215810006400	APS44
16137039	215810006500	APS45
16172899	215810006100	APS41
16212460	215810006400	APS44
16235939	215810006300	APS43
16255839	215810004800	APS28
16258659	215810006400	APS44
55206797	215810004500	APS25
55219294	215810004300	APS23
55219298	215810005600	APS36
90063543	215810006400	APS44
90467558	215810006200	APS42
91167213	215810005400	APS34
93160018	215810006400	APS44
93168455	215810006600	APS46
93171579	215810005000	APS30
93171659	215810007700	APS57

OE/IAM	MAGNETI MARELLI	
	LONG	SHORT

SENSORE PRESSIONE ASSOLUTA MAP SENSOR		
--	--	--

GENERAL MOTORS		
93177414	215810004300	APS23
93190052	215810004300	APS23
93194115	215810004300	APS23
93232415	215810007400	APS54
96482570	215810008500	APS65
97180655	215810006300	APS43

HELLA		
-------	--	--

009400111	215810004300	APS23
6PP009400001	215810006100	APS41
6PP009400011	215810006400	APS44
6PP009400021	215810004900	APS29
6PP009400071	215810006500	APS45
6PP009400081	215810003400	APS14
6PP009400111	215810004300	APS23
6PP009400171	215810004800	APS28
6PP009400191	215810008200	APS62
6PP009400201	215810005400	APS34
6PP009400221	215810006500	APS45
6PP009400301	215810009700	APS77
6PP009400321	215810005200	APS32
6PP009400351	215810009400	APS74
6PP009400361	215810009500	APS75
6PP009400371	215810009300	APS73
6PP009400401	215810004600	APS26
6PP009400411	215810005500	APS35
6PP009400431	215810006300	APS43
6PP009400441	215810008700	APS67
6PP009400451	215810005100	APS31
6PP009400471	215810006000	APS40
6PP009400481	215810005900	APS39
6PP009400521	215810005800	APS38
6PP009400541	215810009000	APS70
6PP009400561	215810005000	APS30
6PP009400581	215810008100	APS61
6PP009400721	215810007800	APS58

HONDA		
-------	--	--

37830P05A01	215810009300	APS73
37830P0GS00	215810009300	APS73
37830P7AN11	215810009300	APS73
37830PAAS00	215810009300	APS73
37830PDFE01	215810004400	APS24
37830PGKA01	215810009400	APS74

OE/IAM

MAGNETI
MARELLI

LONG

SHORT

SENSORE PRESSIONE ASSOLUTA
MAP SENSOR

HYUNDAI

3933024750 215810006500 **APS45**3933026300 215810007400 **APS54**

INTERMOTOR

15835 215810005400 **APS34**16800 215810006500 **APS45**16811 215810006100 **APS41**16813 215810009600 **APS76**16814 215810006400 **APS44**16815 215810005900 **APS39**16816 215810005100 **APS31**16818 215810004900 **APS29**16822 215810006300 **APS43**16823 215810006200 **APS42**16824 215810005500 **APS35**16825 215810005800 **APS38**16826 215810004800 **APS28**16827 215810004400 **APS24**16830 215810008200 **APS62**16841 215810008000 **APS60**16842 215810004600 **APS26**16843 215810007700 **APS57**16844 215810005200 **APS32**16845 215810005000 **APS30**16850 215810009700 **APS77**16855 215810005300 **APS33**16857 215810009500 **APS75**16858 215810007500 **APS55**16863 215810009300 **APS73**16870 215810006000 **APS40**16886 215810009800 **APS78**16896 215810006700 **APS47**16898 215810006600 **APS46**

ISUZU

8162124600 215810006400 **APS44**

IVECO

500351377 215810007000 **APS50**

JAGUAR

AJ812337 215810003300 **APS13**AJ85329 215810003300 **APS13**

KIA

0K30E18211A 215810007600 **APS56**0K95018211 215810006500 **APS45**

OE/IAM

MAGNETI
MARELLI

LONG

SHORT

SENSORE PRESSIONE ASSOLUTA
MAP SENSOR

LAND ROVER

ERR3561 215810006200 **APS42**MHK100820L 215810008900 **APS69**MHK101060L 215810005000 **APS30**WKW000060 215810007700 **APS57**WKW000070 215810007700 **APS57**

LUCAS ELECTRICAL

SEB1541 215810007700 **APS57**SEB1552 215810006700 **APS47**SEB175 215810006500 **APS45**SEB912 215810006100 **APS41**SEB914 215810009600 **APS76**SEB915 215810006400 **APS44**SEB916 215810005900 **APS39**SEB917 215810005100 **APS31**SEB919 215810004900 **APS29**SEB923 215810006300 **APS43**SEB924 215810006200 **APS42**SEB925 215810005500 **APS35**SEB926 215810005800 **APS38**SEB927 215810004800 **APS28**SEB928 215810004400 **APS24**SEB931 215810008200 **APS62**SEB936 215810005400 **APS34**SEB943 215810004600 **APS26**SEB944 215810007700 **APS57**SEB945 215810005200 **APS32**SEB946 215810005000 **APS30**SEB950 215810009700 **APS77**SEB955 215810005300 **APS33**

MAGNETI MARELLI

KITLDF6T 806001723701 **KITLDF6T**KITTPRT05/2 806001535002 **KITTPRT05/2**PRT03/04 215810001604 **PRT03/04**PRT03E/04 230016070077 **PRT03E/04**

MAZDA

C20118211A 215810003300 **APS13**

MEAT & DORIA

82051 215810001604 **PRT03/04**82052 215810006500 **APS45**82101 215810009600 **APS76**82117 215810006400 **APS44**82119 806001535002 **KITTPRT05/2**82120 806001723701 **KITLDF6T**

OE/IAM	MAGNETI MARELLI	
	LONG	SHORT
SENSORE PRESSIONE ASSOLUTA MAP SENSOR		
MEAT & DORIA		
82121	215810005900	APS39
82123	215810004300	APS23
82126	215810005100	APS31
82130	215810007900	APS59
82134	215810004900	APS29
82135	215810008200	APS62
82145	215810009700	APS77
82153	215810009000	APS70
82154	215810005300	APS33
82159	215810006000	APS40
82160	230016070077	PRT03E/04
82167	215810007700	APS57
82197	215810004400	APS24
82210	215810006100	APS41
82211	215810004500	APS25
82220	215810003900	APS19
82221	215810008100	APS61
82222	215810009500	APS75
82225	215810008000	APS60
82228	215810008900	APS69
82249	215810008300	APS63
82251	215810003400	APS14
82252	215810008700	APS67
82282	215810008500	APS65
82285	215810009300	APS73
82286	215810007500	APS55
82293	215810007600	APS56
82294	215810009900	APS79
82295	215810007800	APS58
82296	215810007400	APS54
82297	215810008400	APS64
82299	215810009400	APS74
82300	215810009100	APS71
82304	215810009800	APS78
82308	215810005600	APS36
82309	215810006700	APS47
MERCEDES-BENZ		
0041533028	215810005300	APS33
0041533228	215810005300	APS33
0041533328	215810008000	APS60
0051535028	215810005300	APS33
0051537228	215810008000	APS60
0061531328	215810005300	APS33

OE/IAM	MAGNETI MARELLI	
	LONG	SHORT
SENSORE PRESSIONE ASSOLUTA MAP SENSOR		
MERCEDES-BENZ		
0061531428	215810008000	APS60
0061539728	215810005300	APS33
0061539828	215810008000	APS60
6110700149	215810006800	APS48
6110780149	215810006800	APS48
A6110780149	215810006800	APS48
METZGER		
0905252	215810009300	APS73
0905262	215810009900	APS79
0905313	215810006000	APS40
0905336	215810008000	APS60
0905353	215810006600	APS46
0905368	215810006700	APS47
0906095	215810007800	APS58
MG		
MHK101060	215810005000	APS30
MINI		
7540508	215810006700	APS47
12140872648	215810008900	APS69
12140872679	215810008100	APS61
13627539811	215810009100	APS71
13627540508	215810006700	APS47
MTE-THOMSON		
7134	215810005100	APS31
NISSAN		
8200155613	215810004300	APS23
2236500QAA	215810004300	APS23
2236500QAB	215810005400	APS34
22365BN701	215810004300	APS23
OPEL		
815701	215810006500	APS45
851365	215810004600	APS26
1235083	215810004300	APS23
1235084	215810005600	APS36
1235258	215810004300	APS23
1238788	215810006500	APS45
4401593	215810004300	APS23
4409668	215810006400	APS44
4709264	215810004300	APS23
6235631	215810004300	APS23
6238120	215810006400	APS44
6238159	215810006400	APS44
6238166	215810006300	APS43

OE/IAM

MAGNETI
MARELLI

LONG

SHORT

SENSORE PRESSIONE ASSOLUTA
MAP SENSOR

OPEL

6238332	215810006200	APS42
6238927	215810006500	APS45
6335606	215810007300	APS53
12614970	215810006400	APS44
16212460	215810006400	APS44
24420761	215810004600	APS26
55219298	215810005600	APS36
55566049	215810006900	APS49
93190052	215810004300	APS23
97287868	215810007300	APS53

PIERBURG

718222010	215810006500	APS45
718222030	806001723701	KITLDF6T
718222040	215810004300	APS23
718222050	215810008200	APS62
718222080	215810005100	APS31
718222100	215810004900	APS29
718222110	215810003700	APS17
718222140	215810004600	APS26
718222170	215810004400	APS24
718222190	215810009600	APS76
718222210	215810009700	APS77
718222220	215810001604	PRT03/04
718222250	215810006400	APS44

PSA

457403	215810008200	APS62
457405	215810008200	APS62
467680	215810009700	APS77
594607	215810006500	APS45
594609	215810006500	APS45
96107893	215810004900	APS29
96182615	215810009600	APS76
96317166	215810005500	APS35
96354934	215810008200	APS62
96365830	215810009700	APS77
96390274	215810005800	APS38
96393814	215810009700	APS77
96394189	215810008200	APS62
96394191	215810008200	APS62
96493965	215810007800	APS58
9609992380	215810001604	PRT03/04
9610789380	215810004900	APS29
9613102380	230016070077	PRT03E/04

OE/IAM

MAGNETI
MARELLI

LONG

SHORT

SENSORE PRESSIONE ASSOLUTA
MAP SENSOR

PSA

9631716680	215810005500	APS35
9635493480	215810008200	APS62
9636583080	215810009700	APS77
9639027480	215810005800	APS38
9639381480	215810009700	APS77
9639418980	215810008200	APS62
9639419180	215810008200	APS62
9639469280	215810005800	APS38
9649396580	215810007800	APS58
19200E	215810009600	APS76
19204S	215810006500	APS45
19207T	215810005500	APS35
19209H	215810009600	APS76
1920AC	215810008200	APS62
1920AJ	215810009700	APS77
1920CW	215810006400	APS44
1920CZ	215810005800	APS38
1920FC	215810006500	APS45
1920J7	215810001604	PRT03/04
1920K8	215810004900	APS29
1920KN	215810009500	APS75
1920KZ	215810006700	APS47
1920LG	215810007800	APS58
1920LW	215810009100	APS71
1920X0	215810009600	APS76
V753981180	215810009100	APS71
V754050880	215810006700	APS47

RENAULT

7700106644	215810006400	APS44
7700106886	215810004800	APS28
7700111957	215810005400	APS34
7700706876	215810006500	APS45
7701062395	215810006600	APS46
8200146271	215810007100	APS51
8200155613	215810004300	APS23
8200194432	215810007100	APS51
8200225971	215810005700	APS37
8200292433	215810006600	APS46
8200375080	215810008700	APS67
8200375977	215810008700	APS67
8200685363	215810006600	APS46
8200750883	215810007100	APS51
8933000153	215810006500	APS45

OE/IAM	MAGNETI MARELLI	
	LONG	SHORT
SENSORE PRESSIONE ASSOLUTA MAP SENSOR		
RENAULT		
9618261580	215810009600	APS76
9635493480	215810008200	APS62
9639418980	215810008200	APS62
223650754R	215810008700	APS67
ROVER		
MHK100590	215810009300	APS73
MHK100640	215810008400	APS64
MHK101040	215810008100	APS61
MHK101060	215810005000	APS30
MHK101606L	215810005000	APS30
SAAB		
5167895	215810004400	APS24
9132374	215810006100	APS41
55576178	215810006900	APS49
SIDAT		
84201	215810001604	PRT03/04
84202	215810006500	APS45
84206	215810009600	APS76
84208	215810006400	APS44
84210	806001535002	KITTPRT05/2
84211	806001723701	KITLDF6T
84212	215810005900	APS39
84213	215810004300	APS23
84215	215810005100	APS31
84216	215810007900	APS59
84218	215810004900	APS29
84219	215810008200	APS62
84222	215810009700	APS77
84230	215810009000	APS70
84231	215810005300	APS33
84233	215810006300	APS43
84234	215810006200	APS42
84235	215810006000	APS40
84236	230016070077	PRT03E/04
84237	215810005500	APS35
84238	215810005800	APS38
84239	215810005400	APS34
84242	215810004600	APS26
84243	215810007700	APS57
84244	215810005200	APS32
84245	215810005000	APS30
84247	215810004800	APS28
84251	215810004400	APS24

OE/IAM	MAGNETI MARELLI	
	LONG	SHORT
SENSORE PRESSIONE ASSOLUTA MAP SENSOR		
SIDAT		
84255	215810006100	APS41
84256	215810004500	APS25
84258	215810003900	APS19
84259	215810008100	APS61
84260	215810009500	APS75
84263	215810008000	APS60
84266	215810008900	APS69
84275	215810008300	APS63
84277	215810003400	APS14
84278	215810008700	APS67
84285	215810008500	APS65
84287	215810009300	APS73
84288	215810007500	APS55
84293	215810007600	APS56
84294	215810009900	APS79
84295	215810007800	APS58
84296	215810007400	APS54
84297	215810008400	APS64
84299	215810009400	APS74
84300	215810009100	APS71
84304	215810009800	APS78
84308	215810005600	APS36
84309	215810006700	APS47
84320	215810006600	APS46
SIEMENS VDO		
A2C59515231	215810006400	APS44
SMART		
0003121V00200000	215810004300	APS23
0003121V00300000	215810004300	APS23
3121V0030000000	215810004300	APS23
SUZUKI		
1859067JA0	215810008700	APS67
1859067JA0000	215810008700	APS67
1859069K00	215810005800	APS38
1859069K00000	215810005800	APS38
1859073J00	215810005800	APS38
1859073J00000	215810005800	APS38
SWAG		
81930677	215810009500	APS75
TOPRAN		
111420	215810006000	APS40
206952	215810006500	APS45
401623	215810005300	APS33

OE/IAM	MAGNETI MARELLI	
	LONG	SHORT
SENSORE PRESSIONE ASSOLUTA MAP SENSOR		
TOYOTA		
8942152010	215810009500	APS75
VAG		
038906051	215810005900	APS39
046130385	215810006200	APS42
062906051	215810005900	APS39
270600001	215810004400	APS24
377906051	215810004900	APS29
2379063111	215810004900	APS29
036906051G	215810009000	APS70
038906051B	215810006000	APS40
03G906051D	215810006000	APS40
046130385A	215810006200	APS42
2E0906051A	215810005300	APS33
3A0906051	215810004900	APS29
UE75265	215810004900	APS29
VEMO		
10720981	215810004900	APS29
30720153	215810005300	APS33
40720381	215810006300	APS43
40720382	215810006200	APS42
V10721039	215810006000	APS40
V20720518	215810007700	APS57
V24720100	215810007500	APS55
V26720008	215810009300	APS73
V40720323	215810006500	APS45
VOLVO		
1275170	215810006200	APS42
1378162	215810006500	APS45
3411400	215810006500	APS45
8670292	215810005800	APS38
8677288	215810004200	APS22
8699449	215810005100	APS31
9125462	215810005100	APS31
30658184	215810003900	APS19
30711659	215810003300	APS13
30889795	215810004800	APS28
31216185	215810005800	APS38

OE/IAM	MAGNETI MARELLI	
	LONG	SHORT
SENSORE PRESSIONE SCARICO EXHAUST PRESSURE SENSOR		
BOSCH		
0281002770	215910000100	SPS001
0281002771	215910000100	SPS001
0281006082	215910000400	SPS004
0281006083	215910000400	SPS004
ERA		
550565	215910000100	SPS001
FAE		
16104	215910000100	SPS001
16109	215910000400	SPS004
FCA		
55198717	215910000100	SPS001
HELLA		
6PP009409081	215910000400	SPS004
METZGER		
0905344	215910000100	SPS001
0905375	215910000400	SPS004
OPEL		
55198717	215910000100	SPS001
93187247	215910000100	SPS001
93194121	215910000100	SPS001
SIDAT		
84317	215910000400	SPS004
SUZUKI		
13800T79J5	215910000100	SPS001
1859079J50	215910000100	SPS001
1859079J50000	215910000100	SPS001
18590T79J5	215910000100	SPS001
VAG		
059906051C	215910000400	SPS004

GRUPPO E - GROUP E

REGOLATORE PRESSIONE CARBURANTE FUEL PRESSURE REGULATOR		
BMW		
13531721992	213000000006	RP06A
13531726385	213000000005	RP05A
BOSCH		
0280160234	213000000003	RP03A
0280160236	213000000003	RP03A
0280160502	213000000006	RP06A
0280160503	213000000006	RP06A
0280160504	213000000005	RP05A

OE/IAM	MAGNETI MARELLI	
	LONG	SHORT
REGOLATORE PRESSIONE CARBURANTE FUEL PRESSURE REGULATOR		
BOSCH		
0280160509	213000000008	RP08A
0280160512	213000000001	RP01A
0280160513	213000000001	RP01A
0280160516	213000000002	RP02A
0280160517	213000000002	RP02A
0280160551	213000000008	RP08A
0280160575	213000000002	RP02A
0280160585	213000000008	RP08A
0280160587	213000000001	RP01A
0280160601	213000000004	RP04A
0986580681	213000000007	RP07A
F000DR0213	213000000008	RP08A
F000DR0219	213000000008	RP08A
FCA		
5894037	219244340502	RPM40
7555041	213180012001	RP7/01
9634529280	219244730510	RPM67
FORD		
1000404	213000000008	RP08A
1053950	213000000004	RP04A
96MF9C968BA	213000000008	RP08A
96MF9C968CA	213000000008	RP08A
988F9C968AA	213000000004	RP04A
INTERMOTOR		
16512	213000000003	RP03A
16521	213000000002	RP02A
JAGUAR		
EBC2606	213000000003	RP03A
LUCAS ELECTRICAL		
FDB1019	213000000002	RP02A
FDB940	213000000003	RP03A
MAGNETI MARELLI		
BE0002394CCOM	219000023942	DPR04
DPR04	219000023942	DPR04
RP7/01	213180012001	RP7/01
RPM36	219244330511	RPM36
RPM40	219244340502	RPM40
RPM58	230016052057	RPM58
RPM67	219244730510	RPM67
WFR061	219000023942	DPR04

OE/IAM	MAGNETI MARELLI	
	LONG	SHORT
REGOLATORE PRESSIONE CARBURANTE FUEL PRESSURE REGULATOR		
MEAT & DORIA		
75012	213000000001	RP01A
75013	213000000002	RP02A
75014	213000000005	RP05A
75015	219244730510	RPM67
75016	213000000008	RP08A
75017	213000000004	RP04A
75020	213000000006	RP06A
75022	213000000007	RP07A
75076	213000000003	RP03A
MERCEDES-BENZ		
0000781589	213000000001	RP01A
PIERBURG		
72154801	213000000005	RP05A
72154851	213000000005	RP05A
72160501	213000000002	RP02A
72160551	213000000002	RP02A
721548500	213000000006	RP06A
721548510	213000000005	RP05A
PSA		
198505	219244730510	RPM67
198508	219244330511	RPM36
590406	219244340502	RPM40
9627389980	230016052057	RPM58
9629690880	219244330511	RPM36
9634529280	219244730510	RPM67
RENAULT		
7700266768	213000000003	RP03A
SIDAT		
89002	213000000001	RP01A
89003	213000000002	RP02A
89004	213000000005	RP05A
89005	219244730510	RPM67
89006	213000000008	RP08A
89007	213000000004	RP04A
89010	213000000006	RP06A
89012	213000000007	RP07A
89022	213000000003	RP03A
SMART		
0003097V002	213000000001	RP01A
SSANGYONG		
0000781889	213000000001	RP01A
SUZUKI		
1561064G00	213000000007	RP07A

OE/IAM		MAGNETI MARELLI	
		LONG	SHORT
REGOLATORE PRESSIONE CARBURANTE <i>FUEL PRESSURE REGULATOR</i>			
VAG			
078133534	213000000002	RP02A	
034133534N	213000000003	RP03A	
078133534A	213000000002	RP02A	
078133534C	213000000002	RP02A	
VOLVO			
9404583	219000023942	DPR04	

OE/IAM		MAGNETI MARELLI	
		LONG	SHORT
REGOLATORE PRESSIONE CARBURANTE KIT <i>FUEL PRESSURE REGULATOR KIT</i>			
FCA			
5894036	219244330501	KITRPM36	
5894036	219244330511	RPM36	
5894037	219244340501	KITRPM40	
MAGNETI MARELLI			
KITRPM36	219244330501	KITRPM36	
KITRPM40	219244340501	KITRPM40	
PSA			
590406	219244340501	KITRPM40	
9609836680	219244330501	KITRPM36	

GRUPPO F - GROUP F

OE/IAM		MAGNETI MARELLI	
		LONG	SHORT
F1 KIT SENSORE TEMPERATURA ACQUA <i>WATER TEMPERATURE SENSOR KIT</i>			
FACET			
73318	816001633701	816001633701	
FCA			
71716685	816001633701	816001633701	
71719393	816001633701	816001633701	
MAGNETI MARELLI			
816001633701	816001633701	816001633701	
MEAT & DORIA			
82232	816001633701	816001633701	
SIDAT			
82481	816001633701	816001633701	

OE/IAM		MAGNETI MARELLI	
		LONG	SHORT
F1 SENSORE TEMPERATURA ACQUA <i>WATER TEMPERATURE SENSOR</i>			
BOSCH			
0280130084	171925011010	SZA101	
DELPHI			
TS1022612B1	171925011060	SZA106	
TS1022712B1	215810021003	WTS05-1	
TS1022912B1	171925011070	SZA107	
TS1023012B1	171925011010	SZA101	
TS1023212B1	171925011020	SZA102	
ERA			
330110	171925011020	SZA102	
330120	215810021003	WTS05-1	
330122	171925011010	SZA101	
330124	171925011070	SZA107	
330495	171925011050	SZA105	
330555	171925011040	SZA104	
330559	171925011080	SZA108	
330560	171925011060	SZA106	
FACET			
73114	171925011020	SZA102	
73143	215810021003	WTS05-1	
73148	171925011010	SZA101	
73157	171925011070	SZA107	
73220	171925011040	SZA104	
73271	171925011080	SZA108	
73273	171925011060	SZA106	
73286	171925011050	SZA105	
FCA			
7547977	171925011030	SZA103	
46414596	171925011040	SZA104	
46449499	171925011070	SZA107	
46474599	171925011060	SZA106	
46477022	215810021003	WTS05-1	
46520915	171925011080	SZA108	
46753479	171925011050	SZA105	
470079800	171925011030	SZA103	
470079800	215810021003	WTS05-1	
9621387180	171925011010	SZA101	
FORD			
1639283	215810021003	WTS05-1	
46477022	215810021003	WTS05-1	
60806379	215810021003	WTS05-1	
V86HF12A648AA	171925011030	SZA103	

OE/IAM
**MAGNETI
MARELLI**

LONG

SHORT

F1 **SENSORE TEMPERATURA ACQUA**
WATER TEMPERATURE SENSOR
HELLA

6PT009107431	171925011010	SZA101
6PT009107571	171925011040	SZA104
6PT009309291	171925011030	SZA103
6PT009309581	171925011050	SZA105

MAGNETI MARELLI

WTS05-1	215810021003	WTS05-1
---------	--------------	----------------

MEAT & DORIA

82012	171925011010	SZA101
82013	171925011020	SZA102
82041	215810021003	WTS05-1
82054	171925011070	SZA107
82091	171925011040	SZA104
82125	171925011050	SZA105
82127	171925011080	SZA108
82216	171925011060	SZA106

PSA

9564949380	171925011020	SZA102
9613147080	171925011010	SZA101
1920C4	171925011020	SZA102
1920K9	171925011010	SZA101

SIDAT

82485	171925011060	SZA106
82528	171925011080	SZA108
82529	171925011050	SZA105
82549	171925011040	SZA104
82569	171925011070	SZA107
82577	215810021003	WTS05-1
82596	171925011020	SZA102
82597	171925011010	SZA101

VALEO

700014	171925011020	SZA102
700015	171925011010	SZA101
700021	215810021003	WTS05-1
700024	171925011040	SZA104

F2 **SENSORE TEMPERATURA ARIA**
AIR TEMPERATURE SENSOR
BBT

DS0701	215810400401	ATS10
--------	--------------	--------------

BERU

0824111003	215810400901	ATS15
0824111004	215810400501	ATS11
0824111007	215810400801	ATS14

OE/IAM
**MAGNETI
MARELLI**

LONG

SHORT

F2 **SENSORE TEMPERATURA ARIA**
AIR TEMPERATURE SENSOR
BMW

13621718736	215810400201	ATS08
13621725323	215810400501	ATS11
13621730035	215810400301	ATS09
13622243946	215810400901	ATS15

BOSCH

0261230042	215810400401	ATS10
0261230280	215810401401	ATS20
0280130060	215810400201	ATS08
0280130083	215810400201	ATS08
0280130085	215810401301	ATS19
0280130086	215810401301	ATS19
0280130116	215810400701	ATS13
0281002437	215810401401	ATS20
0281002680	215810401401	ATS20
0281002976	215810401001	ATS16
0281002977	215810401001	ATS16
0281006076	215810401401	ATS20
0281006118	215810401401	ATS20
1287213607	215810401501	ATS21

BUGIAD

BTS65258	215810400801	ATS14
----------	--------------	--------------

CALORSTAT BY VERNET

AS0001	215810400801	ATS14
--------	--------------	--------------

DAEWOO

0005422818	215810401501	ATS21
------------	--------------	--------------

DELPHI

TS1021912B1	215810020902	ATS04-1
TS1022112B1	230016073067	IATS04/01
TS10265	215810401701	ATS23

ERA

550271	215810401401	ATS20
550364	215810400401	ATS10
550383	215810401601	ATS22
550386	230016073067	IATS04/01
550406	215810400801	ATS14
550407	215810400801	ATS14
550495	215810401301	ATS19
550553	215810020902	ATS04-1
550685	215810400701	ATS13
550686	215810401501	ATS21
550691	215810400201	ATS08
550700	215810400601	ATS12
550734	215810401401	ATS20

OE/IAM

MAGNETI
MARELLI

LONG

SHORT

F2 SENSORE TEMPERATURA ARIA
AIR TEMPERATURE SENSOR**ERA**550685B 215810400701 **ATS13**550686B 215810401501 **ATS21****FACET**103075 215810401001 **ATS16**103092 215810400401 **ATS10**104001 215810401301 **ATS19**104005 230016073067 **IATS04/01**104006 215810400701 **ATS13**104008 215810400601 **ATS12**104013 215810401201 **ATS18**104014 215810401501 **ATS21**104015 215810400801 **ATS14**104016 215810020902 **ATS04-1**104021 215810401601 **ATS22**104033 215810401101 **ATS17****FAE**15007 215810401001 **ATS16**15036 215810401401 **ATS20**15044 215810400401 **ATS10**33165 215810400501 **ATS11**33166 215810400901 **ATS15**33170 215810400801 **ATS14**33225 215810401101 **ATS17**33226 215810401301 **ATS19**33227 215810400701 **ATS13**33228 215810401201 **ATS18**33504 215810401501 **ATS21**33505 215810400601 **ATS12**33509 215810401601 **ATS22**33515 215810401701 **ATS23**33535 215810400201 **ATS08**33536 215810400301 **ATS09****FCA**7547976 215810020902 **ATS04-1**7686599 215810400201 **ATS08**9942901 219244250500 **KITATS05**46769978 215810400401 **ATS10**50406437 215810400401 **ATS10**55221403 215810400401 **ATS10**60606033 215810401101 **ATS17**60806471 215810020902 **ATS04-1**73503657 215810401401 **ATS20**470079700 215810020902 **ATS04-1**

OE/IAM

MAGNETI
MARELLI

LONG

SHORT

F2 SENSORE TEMPERATURA ARIA
AIR TEMPERATURE SENSOR**FCA**504088431 215810401401 **ATS20**504245257 215810401401 **ATS20**735036570 215810401401 **ATS20**9463327680 230016073067 **IATS04/01**9655432780 215810401601 **ATS22**9664612580 215810401601 **ATS22****FEBI BILSTEIN**30981 215810401601 **ATS22****FORD**1003742 215810401201 **ATS18**1251249 215810401601 **ATS22**1331461 215810401601 **ATS22**1333818 215810401601 **ATS22**1348613 215810401601 **ATS22**1359930 215810401601 **ATS22**1423736 215810401601 **ATS22**1530145 215810401601 **ATS22**1639284 215810020902 **ATS04-1**6492297 215810401801 **ATS24**6820218 215810401801 **ATS24**3M5A12A697AB 215810401601 **ATS22**3M5A12A697AC 215810401601 **ATS22**3M5A12A697AD 215810401601 **ATS22**91GB10K936AA 215810401801 **ATS24**93BB10K936AA 215810401801 **ATS24**YB0174/4 215810020902 **ATS04-1****GENERAL MOTORS**9158595 215810401401 **ATS20**9196671 215810401401 **ATS20**9543901 215810401401 **ATS20**12129596 215810401101 **ATS17**24459853 215810401401 **ATS20**90423637 215810400401 **ATS10**90499898 215810400601 **ATS12**93170309 215810400401 **ATS10**93171176 215810401401 **ATS20**96279856 215810400801 **ATS14****HELLA**6PP009400291 215810401401 **ATS20**6PT009104021 215810400801 **ATS14**6PT009109041 215810400201 **ATS08**6PT009109061 215810400601 **ATS12**6PT009109141 215810400901 **ATS15**

OE/IAM		 LONG SHORT	
F2	SENSORE TEMPERATURA ARIA <i>AIR TEMPERATURE SENSOR</i>		
HELLA			
6PT009109151	215810400501	ATS11	
INTERMOTOR			
16852	215810400401	ATS10	
16869	215810401401	ATS20	
55703	215810400801	ATS14	
55715	215810400501	ATS11	
55716	215810400901	ATS15	
55717	215810401101	ATS17	
55718	215810400601	ATS12	
55719	215810401701	ATS23	
55721	215810400201	ATS08	
55722	215810400301	ATS09	
55723	215810401301	ATS19	
55724	215810400701	ATS13	
LAND ROVER			
6670669	215810400901	ATS15	
NSC50050	215810400901	ATS15	
LUCAS ELECTRICAL			
SEB1086	215810401401	ATS20	
SEB952	215810400401	ATS10	
SNB818	215810400801	ATS14	
SNB985	215810400501	ATS11	
SNB986	215810400901	ATS15	
SNB987	215810401101	ATS17	
SNB988	215810400601	ATS12	
SNB989	215810401701	ATS23	
SNB991	215810400201	ATS08	
SNB992	215810400301	ATS09	
SNB993	215810401301	ATS19	
SNB994	215810400701	ATS13	
MAGNETI MARELLI			
ATS04-1	215810020902	ATS04-1	
IATS04	230016073047	IATS04	
IATS04/01	230016073067	IATS04/01	
KITATS05	219244250500	KITATS05	
MEAT & DORIA			
82042	215810020902	ATS04-1	
82046	215810400801	ATS14	
82122	215810401301	ATS19	
82143	215810401401	ATS20	
82148	215810400401	ATS10	
82174	215810400701	ATS13	
82177	230016073067	IATS04/01	

OE/IAM		 LONG SHORT	
F2	SENSORE TEMPERATURA ARIA <i>AIR TEMPERATURE SENSOR</i>		
MEAT & DORIA			
82181	215810401201	ATS18	
82182	215810401501	ATS21	
82183	215810401101	ATS17	
82184	215810400601	ATS12	
82202	215810400501	ATS11	
82203	215810400901	ATS15	
82207	215810400201	ATS08	
82208	215810400301	ATS09	
82288	215810401601	ATS22	
82301	215810401001	ATS16	
MERCEDES-BENZ			
0005422818	215810401501	ATS21	
0061532028	215810401501	ATS21	
0061538028	215810401501	ATS21	
6511530028	215810401501	ATS21	
METZGER			
0905158	215810401601	ATS22	
0906054	215810400401	ATS10	
MEYLE			
1009050024	215810400701	ATS13	
1009190028	215810401701	ATS23	
MG			
NNK000050	215810400901	ATS15	
NSC50050	215810400901	ATS15	
MTE-THOMSON			
5031	215810401101	ATS17	
5036	215810400201	ATS08	
5038	215810400801	ATS14	
5043	215810400301	ATS09	
5063	215810401301	ATS19	
5068	215810400701	ATS13	
5072	215810401501	ATS21	
5086	215810400801	ATS14	
5091	215810400501	ATS11	
OPEL			
1235029	215810401401	ATS20	
1238079	215810401101	ATS17	
1238244	215810400401	ATS10	
6238210	215810401401	ATS20	
6238331	215810400601	ATS12	
9158595	215810401401	ATS20	
9196671	215810401401	ATS20	
24459853	215810401401	ATS20	

OE/IAM

MAGNETI
MARELLI

LONG

SHORT

F2 SENSORE TEMPERATURA ARIA
AIR TEMPERATURE SENSOR**OPEL**

55568175	215810401401	ATS20
90423637	215810400401	ATS10
93170309	215810400401	ATS10
93171176	215810401401	ATS20

PIERBURG

718222120	215810400401	ATS10
-----------	--------------	-------

PSA

163639	215810401401	ATS20
163661	215810401401	ATS20
9942901	219244250500	KITATS05
96554327	215810401601	ATS22
9620182880	230016073047	IATS04
9625191780	230016073067	IATS04/01
19204G	230016073067	IATS04/01
19208Y	230016073067	IATS04/01
19209F	230016073067	IATS04/01
1920GF	215810401601	ATS22
1920JL	215810401601	ATS22
1920PJ	215810401601	ATS22

RENAULT

994290	219244250500	KITATS05
7700737572	215810400801	ATS14

ROVER

210002488	215810400901	ATS15
NNK000050	215810400901	ATS15
NSC50050	215810400901	ATS15

SAAB

5341409	215810401401	ATS20
24459853	215810401401	ATS20
90423637	215810400401	ATS10
93170309	215810400401	ATS10
93171176	215810401401	ATS20

SIDAT

82451	215810401601	ATS22
82489	215810400301	ATS09
82490	215810400201	ATS08
82494	215810400901	ATS15
82495	215810400501	ATS11
82507	215810400601	ATS12
82508	215810401101	ATS17
82509	215810401501	ATS21
82510	215810401201	ATS18
82514	230016073067	IATS04/01

OE/IAM

MAGNETI
MARELLI

LONG

SHORT

F2 SENSORE TEMPERATURA ARIA
AIR TEMPERATURE SENSOR**SIDAT**

82517	215810400701	ATS13
82530	215810401301	ATS19
82572	215810400801	ATS14
82576	215810020902	ATS04-1
84220	215810401401	ATS20
84225	215810400401	ATS10
84301	215810401001	ATS16

SMART

0005422818	215810401501	ATS21
0061532028	215810401501	ATS21
0061538028	215810401501	ATS21
6511530028	215810401501	ATS21
0003119V002	215810401501	ATS21
0003119V00200000	215810401501	ATS21
0003119V002000000	215810401501	ATS21

SSANGYONG

0005422818	215810401501	ATS21
------------	--------------	-------

STANDARD

55734	215810401601	ATS22
-------	--------------	-------

SWAG

62930981	215810401601	ATS22
----------	--------------	-------

TOPRAN

302695	215810401601	ATS22
--------	--------------	-------

TOYOTA

SU00100647	215810401601	ATS22
SU00100792	215810401601	ATS22
SU00100839	215810401601	ATS22

VAG

028906081	215810401201	ATS18
058905379	215810401301	ATS19
078906161	215810400201	ATS08
95560618000	215810400401	ATS10
99360611400	215810401301	ATS19
99660618000	215810400401	ATS10
03G906051E	215810401001	ATS16
03G906051L	215810401001	ATS16
06B905379	215810400701	ATS13
06B905379A	215810400701	ATS13
06B905379B	215810400701	ATS13
06B905379C	215810400701	ATS13
06B905379D	215810400701	ATS13
06B998124	215810400701	ATS13
1J0919379A	215810401701	ATS23

OE/IAM	MAGNETI MARELLI	
	LONG	SHORT
F2	SENSORE TEMPERATURA ARIA AIR TEMPERATURE SENSOR	
VAG		
2D0905379A	215810401501	ATS21
2R0906051C	215810401401	ATS20
VEMO		
10720945	215810400701	ATS13
10720956	215810401701	ATS23
20720456	215810400901	ATS15
20720457	215810400501	ATS11
30720103	215810401501	ATS21
40720325	215810401101	ATS17
40720338	215810400601	ATS12
46720003	215810400801	ATS14
V22720088	215810401601	ATS22
V24700099	215810401401	ATS20
V25721085	215810401801	ATS24
V40720433	215810400401	ATS10
VOLVO		
30777255	215810401601	ATS22
31216702	215810401601	ATS22

OE/IAM	MAGNETI MARELLI	
	LONG	SHORT
F3	SENSORE TEMPERATURA OLIO OIL TEMPERATURE SENSOR	
BMW		
1433076	171916011130	SGA113
13621433076	171916011130	SGA113
23017838935	171916011130	SGA113
BOSCH		
0280130081	171916911160	SGA116
0280130082	171916911160	SGA116
DELPHI		
TS1024812B1	171916911160	SGA116
ERA		
330530	171916911140	SGA114
FACET		
73225	171916911160	SGA116
73248	171916911140	SGA114
73255	171916911150	SGA115
73272	171916011130	SGA113
FAE		
33145	171916911150	SGA115
33155	171916011130	SGA113
33460	171916911160	SGA116
33595	171916911140	SGA114

OE/IAM	MAGNETI MARELLI	
	LONG	SHORT
F3	SENSORE TEMPERATURA OLIO OIL TEMPERATURE SENSOR	
GENERAL MOTORS		
93180124	171916911160	SGA116
HELLA		
6PT009107101	171916011130	SGA113
HERTH+BUSS ELPARTS		
70511513	171916011130	SGA113
JAGUAR		
LHE1600AA	171916911140	SGA114
LAND ROVER		
MEK000030L	171916011130	SGA113
MEK100170L	171916011130	SGA113
MEK500130	171916011130	SGA113
NSC100870L	171916011130	SGA113
LUCAS ELECTRICAL		
SNB848	171916911140	SGA114
SNB947	171916011130	SGA113
MEAT & DORIA		
82095	171916911140	SGA114
82115	171916911160	SGA116
82129	171916011130	SGA113
MG		
MEK100060	171916911140	SGA114
MTE-THOMSON		
4102	171916911150	SGA115
NISSAN		
2263000QAH	171916911160	SGA116
226300M200	171916911160	SGA116
226301W400	171916911160	SGA116
2263043Y00	171916911160	SGA116
2263044B10	171916911160	SGA116
2263044B20	171916911160	SGA116
2263099B10	171916911160	SGA116
RENAULT		
7701058398	171916911160	SGA116
ROVER		
GTR206	171916911140	SGA114
GTR270	171916011130	SGA113
MEK000030	171916011130	SGA113
MEK100060	171916911140	SGA114
MEK100170	171916011130	SGA113
MEK500130	171916011130	SGA113
NSC100870	171916011130	SGA113

OE/IAM		 LONG SHORT	
F3	SENSORE TEMPERATURA OLIO OIL TEMPERATURE SENSOR		
SIDAT			
82480	171916911150	SGA115	
82526	171916011130	SGA113	
82532	171916911160	SGA116	
82545	171916911140	SGA114	
STANDARD			
55478	171916011130	SGA113	
55522	171916911140	SGA114	
TOPRAN			
500521	171916011130	SGA113	
VAG			
059919563	171916911150	SGA115	
VEMO			
20720440	171916011130	SGA113	

F1	SENSORE TEMPERATURA REFRIGERANTE COOLANT TEMPERATURE SENSOR		
BERU			
0824111011	171916011040	SPA104	
0824121020	171916011360	SPA136	
0824121073	171916011430	SPA143	
0824121075	171916011600	SPA160	
0824121076	171916011510	SPA151	
0824121077	171916011340	SPA134	
0824121081	171916011100	SPA110	
0824121082	171916011400	SPA140	
0824121108	171916011210	SPA121	
0824121116	171916011680	SPA168	
0824121164	171916011190	SPA119	
0824121175	171916011590	SPA159	
0824121264	171916011350	SPA135	
ST002	171916011360	SPA136	
ST013	171916011430	SPA143	
ST017	171916011510	SPA151	
ST018	171916011340	SPA134	
ST028	171916011040	SPA104	
ST030	171916011100	SPA110	
ST031	171916011400	SPA140	
ST036	171916011040	SPA104	
ST060	171916011210	SPA121	
ST068	171916011680	SPA168	
ST107	171916011190	SPA119	
ST121	171916011590	SPA159	
ST249	171916011350	SPA135	

OE/IAM		 LONG SHORT	
F1	SENSORE TEMPERATURA REFRIGERANTE COOLANT TEMPERATURE SENSOR		
BERU			
ST264	171916011030	SPA103	
BLUE PRINT			
ADH27201	171916011550	SPA155	
ADK87211	171916011450	SPA145	
BMW			
1284397	171916011040	SPA104	
1401945	171916011040	SPA104	
1709966	171916011040	SPA104	
1730034	171916011320	SPA132	
12621288156	171916011210	SPA121	
12621288158	171916011210	SPA121	
13621284397	171916011040	SPA104	
13621288158	171916011210	SPA121	
13621401945	171916011040	SPA104	
13621433077	171916011120	SPA112	
13621707366	171916011210	SPA121	
13621709966	171916011040	SPA104	
13621730034	171916011320	SPA132	
13622242184	171916011640	SPA164	
13627788077	171916011120	SPA112	
13631730034	171916011320	SPA132	
13641288158	171916011640	SPA164	
BOSCH			
0280130014	171916011150	SPA115	
0280130023	171916011310	SPA131	
0280130025	171916011040	SPA104	
0280130026	171916011040	SPA104	
0280130032	171916011290	SPA129	
0280130033	171916011040	SPA104	
0280130037	171916011210	SPA121	
0280130040	171916011430	SPA143	
0280130041	171916011430	SPA143	
0280130046	171916011370	SPA137	
0280130053	171916011250	SPA125	
0280130054	171916011250	SPA125	
0280130055	171916011640	SPA164	
0280130057	171916011370	SPA137	
0280130058	171916011370	SPA137	
0280130063	171916011260	SPA126	
0280130064	171916011260	SPA126	
0280130065	171916011260	SPA126	
0280130066	171916011340	SPA134	
0280130068	171916011040	SPA104	

OE/IAM	 LONG SHORT	
--------	-------------------------------------	--

F1	SENSORE TEMPERATURA REFRIGERANTE COOLANT TEMPERATURE SENSOR	
-----------	--	--

BOSCH		
0280130069	171916011290	SPA129
0280130071	171916011500	SPA150
0280130072	171916011500	SPA150
0280130075	171916011240	SPA124
0280130077	171916011040	SPA104
0280130093	171916011030	SPA103
0280130094	171916011030	SPA103
0280130107	171916011040	SPA104
0280130122	171916011030	SPA103
0281002169	171916011030	SPA103
0281002170	171916011030	SPA103
0281002209	171916011030	SPA103
0281002259	171916011280	SPA128
0281002473	171916011030	SPA103
0986280404090	171916011070	SPA107
BOUGICORD		
144332	171916011070	SPA107
145565	171916011160	SPA116
145566	171916011133	SPA113
BUGIAD		
BTS65265	171916011360	SPA136
BTS65270	171916011400	SPA140
BTS65274	171916011600	SPA160
BTS65287	171916011190	SPA119
BTS65288	171916011510	SPA151
BTS65291	171916011030	SPA103
BTS65302	171916011280	SPA128
BTS65304	171916011150	SPA115
BTS65306	171916011590	SPA159
CALORSTAT BY VERNET		
WS2581	171916011400	SPA140
WS2590	171916011640	SPA164
WS2595	171916011440	SPA144
WS2598	171916011030	SPA103
WS2605	171916011590	SPA159
WS2609	171916011720	SPA172
WS2663	171916011540	SPA154
WS2675	171916011250	SPA125
WS2677	171916011700	SPA170
WS2683	171916011200	SPA120
WS2690	171916011680	SPA168
WS2691	171916011310	SPA131
WS2698	171916011630	SPA163

OE/IAM	 LONG SHORT	
--------	-------------------------------------	--

F1	SENSORE TEMPERATURA REFRIGERANTE COOLANT TEMPERATURE SENSOR	
-----------	--	--

CALORSTAT BY VERNET		
WS3000	171916011120	SPA112
WS3002	171916011370	SPA137
WS3010	171916011550	SPA155
CHEVROLET		
1338359	171916011460	SPA146
12191170	171916011150	SPA115
25036898	171916011150	SPA115
55206393	171916011460	SPA146
96182634	171916011150	SPA115
DACIA		
7700105087	171916011690	SPA169
8200561449	171916011080	SPA108
DAEWOO		
12191170	171916011150	SPA115
15404280	171916011150	SPA115
25036898	171916011150	SPA115
96181508	171916011150	SPA115
96182634	171916011150	SPA115
DAIHATSU		
8942287101000	171916011420	SPA142
8942287202000	171916011420	SPA142
DELPHI		
15423547	171916011030	SPA103
TS10180	171916011550	SPA155
TS1018011B1	171916011550	SPA155
TS1024012B1	171916011700	SPA170
TS1024712B1	171916011510	SPA151
TS10253	171916011030	SPA103
TS10269	171916011630	SPA163
DENSO		
1797000480	171916011620	SPA162
1797000500	171916011520	SPA152
ERA		
330082	171916011010	SPA101
330115	171916011210	SPA121
330121	171916011640	SPA164
330127	171916011430	SPA143
330128	171916011400	SPA140
330130	171916011680	SPA168
330133	171916011290	SPA129
330136	171916011250	SPA125
330137	171916011030	SPA103
330144	171916011700	SPA170

OE/IAM		 LONG SHORT	
F1	SENSORE TEMPERATURA REFRIGERANTE COOLANT TEMPERATURE SENSOR		
ERA			
330334	171916011360	SPA136	
330497	171916011590	SPA159	
330502	171916011720	SPA172	
330550	171916011510	SPA151	
330551	171916011670	SPA167	
330583	171916011370	SPA137	
330584	171916011133	SPA113	
330619	171916011420	SPA142	
330624	171916011070	SPA107	
330652	171916011350	SPA135	
330770	171916011450	SPA145	
26930343	171916011540	SPA154	
330598B	171916011540	SPA154	
330598HQ	171916011540	SPA154	
330605B	171916011410	SPA141	
330605HQ	171916011410	SPA141	
330606B	171916011330	SPA133	
330606HQ	171916011330	SPA133	
FACET			
73000	171916011010	SPA101	
73086	171916011050	SPA105	
73098	171916011150	SPA115	
73101	171916011060	SPA106	
73126	171916011210	SPA121	
73127	171916011310	SPA131	
73128	171916011040	SPA104	
73146	171916011100	SPA110	
73147	171916011640	SPA164	
73151	171916011360	SPA136	
73155	171916011260	SPA126	
73155	171916011370	SPA137	
73171	171916011430	SPA143	
73172	171916011400	SPA140	
73177	171916011680	SPA168	
73178	171916011320	SPA132	
73191	171916011600	SPA160	
73192	171916011290	SPA129	
73198	171916011550	SPA155	
73199	171916011240	SPA124	
73226	171916011220	SPA122	
73229	171916011250	SPA125	
73230	171916011420	SPA142	
73232	171916011440	SPA144	

OE/IAM		 LONG SHORT	
F1	SENSORE TEMPERATURA REFRIGERANTE COOLANT TEMPERATURE SENSOR		
FACET			
73234	171916011160	SPA116	
73239	171916011030	SPA103	
73243	171916011200	SPA120	
73244	171916011640	SPA164	
73251	171916011690	SPA169	
73252	171916011080	SPA108	
73258	171916011090	SPA109	
73259	171916011650	SPA165	
73260	171916011590	SPA159	
73262	171916011340	SPA134	
73263	171916011280	SPA128	
73276	171916011070	SPA107	
73278	171916011110	SPA111	
73279	171916011120	SPA112	
73280	171916011300	SPA130	
73283	171916011230	SPA123	
73284	171916011700	SPA170	
73291	171916011670	SPA167	
73292	171916011720	SPA172	
73294	171916011133	SPA113	
73295	171916011580	SPA158	
73299	171916011570	SPA157	
73300	171916011630	SPA163	
73302	171916011530	SPA153	
73303	171916011350	SPA135	
73304	171916011390	SPA139	
73323	171916011620	SPA162	
73326	171916011560	SPA156	
73327	171916011270	SPA127	
73328	171916011610	SPA161	
73334	171916011450	SPA145	
73341	171916011470	SPA147	
73347	171916011520	SPA152	
73357	171916011460	SPA146	
FAE			
32425	171916011390	SPA139	
32426	171916011580	SPA158	
32700	171916011230	SPA123	
32710	171916011630	SPA163	
33020	171916011310	SPA131	
33030	171916011210	SPA121	
33060	171916011600	SPA160	
33080	171916011260	SPA126	

OE/IAM		 LONG SHORT	
F1	SENSORE TEMPERATURA REFRIGERANTE COOLANT TEMPERATURE SENSOR		
FAE			
33090	171916011290	SPA129	
33110	171916011500	SPA150	
33130	171916011370	SPA137	
33140	171916011430	SPA143	
33150	171916011340	SPA134	
33167	171916011120	SPA112	
33240	171916011170	SPA117	
33245	171916011450	SPA145	
33250	171916011680	SPA168	
33255	171916011620	SPA162	
33290	171916011360	SPA136	
33310	171916011420	SPA142	
33330	171916011150	SPA115	
33355	171916011380	SPA138	
33390	171916011240	SPA124	
33410	171916011250	SPA125	
33420	171916011190	SPA119	
33425	171916011700	SPA170	
33430	171916011510	SPA151	
33450	171916011550	SPA155	
33455	171916011570	SPA157	
33456	171916011520	SPA152	
33470	171916011220	SPA122	
33480	171916011030	SPA103	
33485	171916011030	SPA103	
33490	171916011030	SPA103	
33495	171916011460	SPA146	
33555	171916011300	SPA130	
33590	171916011320	SPA132	
33600	171916011640	SPA164	
33650	171916011400	SPA140	
33685	171916011710	SPA171	
33690	171916011280	SPA128	
33704	171916011560	SPA156	
33706	171916011720	SPA172	
33707	171916011610	SPA161	
33735	171916011160	SPA116	
33736	171916011530	SPA153	
33746	171916011133	SPA113	
33770	171916011200	SPA120	
33780	171916011650	SPA165	
33782	171916011590	SPA159	
33785	171916011440	SPA144	

OE/IAM		 LONG SHORT	
F1	SENSORE TEMPERATURA REFRIGERANTE COOLANT TEMPERATURE SENSOR		
FAE			
33795	171916011670	SPA167	
33810	171916011690	SPA169	
33820	171916011350	SPA135	
33840	171916011470	SPA147	
3306003	171916011600	SPA160	
3315001	171916011340	SPA134	
3378001	171916011650	SPA165	
3378201	171916011590	SPA159	
FCA			
121720	171916011290	SPA129	
4393601	171916011310	SPA131	
4448131	171916011010	SPA101	
5226504	171916011370	SPA137	
5972332	171916011040	SPA104	
6081220	171916011640	SPA164	
6081224	171916011640	SPA164	
7588802	171916011010	SPA101	
7588882	171916011010	SPA101	
7647004	171916011290	SPA129	
7669143	171916011340	SPA134	
7738223	171916011640	SPA164	
7770239	171916011040	SPA104	
7778980	171916011150	SPA115	
9946866	171916011040	SPA104	
46469865	171916011030	SPA103	
46472179	171916011030	SPA103	
55187822	171916011030	SPA103	
55190791	171916011560	SPA156	
55190792	171916011560	SPA156	
55199579	171916011150	SPA115	
55206393	171916011460	SPA146	
60513205	171916011040	SPA104	
60523383	171916011310	SPA131	
60528383	171916011310	SPA131	
60534312	171916011290	SPA129	
60800167	171916011040	SPA104	
60800522	171916011290	SPA129	
60808142	171916011040	SPA104	
60811520	171916011150	SPA115	
60814175	171916011030	SPA103	
60814715	171916011030	SPA103	
71739856	171916011030	SPA103	
71741090	171916011030	SPA103	

OE/IAM	MAGNETI MARELLI	
	LONG	SHORT
F1	SENSORE TEMPERATURA REFRIGERANTE COOLANT TEMPERATURE SENSOR	
FCA		
76470040	171916011290	SPA129
77363465	171916011560	SPA156
98424793	171916011040	SPA104
99455420	171916011030	SPA103
500382599	171916011030	SPA103
605233830	171916011310	SPA131
605343120	171916011290	SPA129
1953211010	171916011040	SPA104
7401346030	171916011290	SPA129
9601842680	171916011020	SPA102
9628454680	171916011070	SPA107
9631000880	171916011670	SPA167
9632562080	171916011720	SPA172
9636777180	171916011070	SPA107
9636777280	171916011670	SPA167
9654414180	171916011720	SPA172
119111101000	171916011310	SPA131
195051110100	171916011290	SPA129
1953211010000	171916011040	SPA104
FEBI BILSTEIN		
07015	171916011360	SPA136
17695	171916011040	SPA104
22882	171916011400	SPA140
30673	171916011270	SPA127
33628	171916011450	SPA145
FORD		
1047284	171916011160	SPA116
1079267	171916011580	SPA158
1087327	171916011540	SPA154
1089854	171916011530	SPA153
1100619	171916011090	SPA109
1100736	171916011110	SPA111
1104480	171916011540	SPA154
1121670	171916011480	SPA148
1124770	171916011090	SPA109
1204700	171916011720	SPA172
1231943	171916011720	SPA172
1320256	171916011480	SPA148
1331294	171916011100	SPA110
1342631	171916011720	SPA172
1459209	171916011110	SPA111
1483838	171916011480	SPA148
1552452	171916011580	SPA158

OE/IAM	MAGNETI MARELLI	
	LONG	SHORT
F1	SENSORE TEMPERATURA REFRIGERANTE COOLANT TEMPERATURE SENSOR	
FORD		
1557880	171916011480	SPA148
1626262	171916011510	SPA151
1669948	171916011100	SPA110
1669949	171916011050	SPA105
1770525	171916011480	SPA148
1957002	171916011310	SPA131
3405645	171916011680	SPA168
3465427	171916011680	SPA168
3601374	171916011680	SPA168
3857955	171916011133	SPA113
3929104	171916011160	SPA116
3936774	171916011410	SPA141
3999215	171916011330	SPA133
4074917	171916011580	SPA158
4323633	171916011700	SPA170
4337456	171916011700	SPA170
4537712	171916011160	SPA116
5040463	171916011133	SPA113
5042970	171916011700	SPA170
6810428	171916011510	SPA151
7158126	171916011700	SPA170
1L2412A648BA	171916011700	SPA170
2S6Q12A648AA	171916011720	SPA172
2S6Q12A648AB	171916011720	SPA172
6M2110884AA	171916011110	SPA111
8L3A6G004AA	171916011133	SPA113
95VW10884AA	171916011100	SPA110
95VW10884AB	171916011100	SPA110
95VW10884BA	171916011050	SPA105
978F12A648AA	171916011160	SPA116
98FF6G004AC	171916011580	SPA158
98FU10884AA	171916011540	SPA154
98FU10884BA	171916011540	SPA154
9C116G004BA	171916011580	SPA158
9C116G004DA	171916011480	SPA148
9C116G004DD	171916011480	SPA148
D84Y12A648A	171916011510	SPA151
DY303	171916011510	SPA151
E0AE12A648AA	171916011510	SPA151
E0AZ12A648A	171916011510	SPA151
E1AF12A648AA	171916011510	SPA151
E1AZ12648B	171916011510	SPA151
E1AZ12A648A	171916011510	SPA151

OE/IAM		 LONG SHORT	
F1	SENSORE TEMPERATURA REFRIGERANTE COOLANT TEMPERATURE SENSOR		
FORD			
E2AF12A648AA	171916011510	SPA151	
E4AF12A648AA	171916011510	SPA151	
E6DZ12A648A	171916011510	SPA151	
E6DZ19E702A	171916011510	SPA151	
E80Y19E702A	171916011510	SPA151	
F1AF12A648BA	171916011510	SPA151	
F1AZ12A648B	171916011510	SPA151	
F2AF12A648AA	171916011510	SPA151	
F2AZ12A648A	171916011510	SPA151	
F2AZ12A648AA	171916011510	SPA151	
F32Z12A648A	171916011680	SPA168	
F3AF12A648AA	171916011510	SPA151	
F42Z10884A	171916011680	SPA168	
F42Z10884AA	171916011680	SPA168	
F44TZ12A648A	171916011510	SPA151	
F4AF12A648AA	171916011510	SPA151	
F4BZ12A648A	171916011680	SPA168	
F50Y19E702A	171916011510	SPA151	
F5AF12648AB	171916011700	SPA170	
F5AF12A648AA	171916011700	SPA170	
F5AF12A648AB	171916011700	SPA170	
F62F12A648AA	171916011160	SPA116	
F62Z10884A	171916011680	SPA168	
F62Z10884AA	171916011680	SPA168	
F62Z12A648AA	171916011160	SPA116	
F65D6G004AB	171916011133	SPA113	
F65F6G004AB	171916011133	SPA113	
F6DZ19E702A	171916011510	SPA151	
F77F10884BB	171916011410	SPA141	
F77Z12A648AA	171916011160	SPA116	
F83F10884AA	171916011330	SPA133	
F8CZ12A648AA	171916011160	SPA116	
XM2110884BA	171916011110	SPA111	
XM218A570BA	171916011090	SPA109	
XS6F12A648BA	171916011530	SPA153	
XS7F6G004AB	171916011480	SPA148	
XS7F6G004AC	171916011480	SPA148	
XS7F6G004AD	171916011480	SPA148	
XU3F12A648AA	171916011160	SPA116	

OE/IAM		 LONG SHORT	
F1	SENSORE TEMPERATURA REFRIGERANTE COOLANT TEMPERATURE SENSOR		
GENERAL MOTORS			
9108329	171916011690	SPA169	
9109810	171916011600	SPA160	
9110578	171916011690	SPA169	
9112723	171916011690	SPA169	
09117449	171916011280	SPA128	
9117449	171916011280	SPA128	
9193163	171916011710	SPA171	
9198691	171916011030	SPA103	
9275979	171916011310	SPA131	
10016110	171916011370	SPA137	
12146897	171916011150	SPA115	
12191170	171916011150	SPA115	
12566778	171916011030	SPA103	
12611420	171916011150	SPA115	
12639899	171916011030	SPA103	
15326388	171916011150	SPA115	
15369305	171916011150	SPA115	
15393755	171916011030	SPA103	
15404280	171916011150	SPA115	
19022018	171916011680	SPA168	
25036898	171916011150	SPA115	
25037062	171916011150	SPA115	
25183414	171916011030	SPA103	
55206393	171916011460	SPA146	
55566146	171916011030	SPA103	
90080939	171916011040	SPA104	
90183892	171916011290	SPA129	
90187326	171916011290	SPA129	
90410792	171916011040	SPA104	
90410793	171916011290	SPA129	
90464954	171916011230	SPA123	
90487859	171916011640	SPA164	
90510182	171916011290	SPA129	
90510183	171916011040	SPA104	
90541520	171916011030	SPA103	
90541937	171916011030	SPA103	
90542063	171916011710	SPA171	
90570185	171916011030	SPA103	
90570382	171916011030	SPA103	
90573217	171916011280	SPA128	
91159949	171916011080	SPA108	
91171786	171916011680	SPA168	
91298691	171916011030	SPA103	

OE/IAM	MAGNETI MARELLI	
	LONG	SHORT
F1	SENSORE TEMPERATURA REFRIGERANTE COOLANT TEMPERATURE SENSOR	
GENERAL MOTORS		
92017805	171916011040	SPA104
93174208	171916011710	SPA171
93198313	171916011080	SPA108
93342219	171916011030	SPA103
94205866	171916011040	SPA104
94342011	171916011300	SPA130
94847363	171916011680	SPA168
94853124	171916011680	SPA168
96056758	171916011370	SPA137
96060084	171916011310	SPA131
96062513	171916011680	SPA168
96065716	171916011680	SPA168
96182634	171916011150	SPA115
96868950	171916011030	SPA103
97227219	171916011030	SPA103
HELLA		
009107131	171916011080	SPA108
009107141	171916011090	SPA109
009107241	171916011050	SPA105
009107361	171916011040	SPA104
009107421	171916011100	SPA110
009107551	171916011060	SPA106
009107611	171916011030	SPA103
009309161	171916011070	SPA107
009309331	171916011110	SPA111
6PT009104001	171916011600	SPA160
6PT009107041	171916011190	SPA119
6PT009107071	171916011320	SPA132
6PT009107111	171916011120	SPA112
6PT009107121	171916011420	SPA142
6PT009107131	171916011080	SPA108
6PT009107141	171916011090	SPA109
6PT009107151	171916011010	SPA101
6PT009107241	171916011050	SPA105
6PT009107271	171916011150	SPA115
6PT009107351	171916011210	SPA121
6PT009107361	171916011040	SPA104
6PT009107421	171916011100	SPA110
6PT009107441	171916011370	SPA137
6PT009107461	171916011400	SPA140
6PT009107481	171916011680	SPA168
6PT009107501	171916011290	SPA129
6PT009107511	171916011550	SPA155

OE/IAM	MAGNETI MARELLI	
	LONG	SHORT
F1	SENSORE TEMPERATURA REFRIGERANTE COOLANT TEMPERATURE SENSOR	
HELLA		
6PT009107521	171916011370	SPA137
6PT009107531	171916011500	SPA150
6PT009107541	171916011590	SPA159
6PT009107551	171916011060	SPA106
6PT009107611	171916011030	SPA103
6PT009107721	171916011300	SPA130
6PT009107751	171916011360	SPA136
6PT009309101	171916011070	SPA107
6PT009309241	171916011560	SPA156
6PT009309261	171916011320	SPA132
6PT009309301	171916011600	SPA160
6PT009309331	171916011110	SPA111
6PT009309381	171916011540	SPA154
6PT009309391	171916011720	SPA172
6PT009309401	171916011700	SPA170
6PT009309561	171916011160	SPA116
6PT009309591	171916011350	SPA135
6PT009309631	171916011510	SPA151
HERTH+BUSS ELPARTS		
70511110	171916011040	SPA104
70511260	171916011150	SPA115
70511261	171916011060	SPA106
70511263	171916011100	SPA110
70511507	171916011440	SPA144
70511509	171916011050	SPA105
70511511	171916011090	SPA109
70511512	171916011590	SPA159
70511516	171916011360	SPA136
70511517	171916011030	SPA103
HONDA		
37870PJ7003	171916011550	SPA155
37870PK2005	171916011550	SPA155
37870PK2015	171916011550	SPA155
37870PLC004	171916011570	SPA157
37870PLZD00	171916011030	SPA103
37870PNA003	171916011570	SPA157
37870RAAA01	171916011570	SPA157
37870RBDE01	171916011030	SPA103
37870RTA005	171916011520	SPA152
37870RWCA01	171916011520	SPA152
37870RZA007	171916011520	SPA152
48160P6K004	171916011550	SPA155

OE/IAM	MAGNETI MARELLI	
	LONG	SHORT
F1	SENSORE TEMPERATURA REFRIGERANTE COOLANT TEMPERATURE SENSOR	
HYUNDAI		
3922022010	171916011040	SPA104
3922035710	171916011420	SPA142
3922038020	171916011380	SPA138
3922038030	171916011380	SPA138
3923026700	171916011380	SPA138
INTERMOTOR		
55104	171916011400	SPA140
55120	171916011600	SPA160
55121	171916011370	SPA137
55122	171916011170	SPA117
55123	171916011680	SPA168
55125	171916011360	SPA136
55126	171916011420	SPA142
55130	171916011240	SPA124
55132	171916011550	SPA155
55134	171916011150	SPA115
55162	171916011690	SPA169
55163	171916011120	SPA112
55164	171916011670	SPA167
55165	171916011720	SPA172
55167	171916011133	SPA113
55170	171916011630	SPA163
55171	171916011530	SPA153
55455	171916011290	SPA129
55460	171916011310	SPA131
55470	171916011210	SPA121
55471	171916011250	SPA125
55473	171916011320	SPA132
55502	171916011260	SPA126
55504	171916011430	SPA143
55507	171916011510	SPA151
55508	171916011700	SPA170
55516	171916011500	SPA150
55518	171916011220	SPA122
55519	171916011200	SPA120
55526	171916011030	SPA103
55530	171916011160	SPA116
55538	171916011350	SPA135
55556	171916011450	SPA145
55571	171916011460	SPA146
ISUZU		
8942058660	171916011040	SPA104

OE/IAM	MAGNETI MARELLI	
	LONG	SHORT
F1	SENSORE TEMPERATURA REFRIGERANTE COOLANT TEMPERATURE SENSOR	
IVECO		
4414600	171916011010	SPA101
5972332	171916011040	SPA104
98424793	171916011040	SPA104
JAGUAR		
EAC5713	171916011290	SPA129
JDE10862	171916011480	SPA148
JDE3422	171916011480	SPA148
JDE8253	171916011480	SPA148
LNA1600AA	171916011680	SPA168
LRA1600BA	171916011160	SPA116
KIA		
3922038020	171916011380	SPA138
3922038030	171916011380	SPA138
3923026700	171916011380	SPA138
0K01118840	171916011370	SPA137
0K0541884X	171916011370	SPA137
0K95B18840	171916011370	SPA137
K857418840	171916011370	SPA137
LADA		
21013808600	171916011010	SPA101
LAND ROVER		
ERR2081	171916011040	SPA104
STC2299	171916011640	SPA164
LEXUS		
8942233020	171916011270	SPA127
8942235010	171916011680	SPA168
LUCAS ELECTRICAL		
SNB1008	171916011350	SPA135
SNB232	171916011160	SPA116
SNB806	171916011430	SPA143
SNB808	171916011310	SPA131
SNB810	171916011290	SPA129
SNB811	171916011640	SPA164
SNB820	171916011340	SPA134
SNB822	171916011210	SPA121
SNB828	171916011360	SPA136
SNB829	171916011600	SPA160
SNB833	171916011510	SPA151
SNB834	171916011700	SPA170
SNB835	171916011500	SPA150
SNB837	171916011150	SPA115
SNB838	171916011370	SPA137
SNB842	171916011680	SPA168

OE/IAM	MAGNETI MARELLI	
	LONG	SHORT
F1	SENSORE TEMPERATURA REFRIGERANTE COOLANT TEMPERATURE SENSOR	
LUCAS ELECTRICAL		
SNB846	171916011030	SPA103
SNB847	171916011640	SPA164
SNB850	171916011280	SPA128
SNB856	171916011400	SPA140
SNB859	171916011320	SPA132
SNB860	171916011550	SPA155
SNB861	171916011250	SPA125
SNB862	171916011420	SPA142
SNB919	171916011240	SPA124
SNB928	171916011170	SPA117
SNB938	171916011440	SPA144
SNB939	171916011590	SPA159
SNB942	171916011310	SPA131
SNB949	171916011260	SPA126
SNB952	171916011220	SPA122
SNB953	171916011200	SPA120
SNB971	171916011690	SPA169
SNB972	171916011120	SPA112
SNB973	171916011670	SPA167
SNB974	171916011720	SPA172
SNB976	171916011133	SPA113
SNB978	171916011630	SPA163
SNB979	171916011530	SPA153
MAZDA		
1E0018510	171916011700	SPA170
B3C818840	171916011680	SPA168
B3C818840A	171916011680	SPA168
B59318840A	171916011680	SPA168
C20118140Z01	171916011700	SPA170
FS1518840	171916011680	SPA168
FSB918840	171916011160	SPA116
GY0118840A	171916011700	SPA170
L35G18840	171916011160	SPA116
LF0118840	171916011160	SPA116
LF0118840A	171916011160	SPA116
N39118840	171916011680	SPA168
NF0218840	171916011680	SPA168
Y40218840	171916011720	SPA172
Y40218840A	171916011720	SPA172
Y70218840	171916011680	SPA168
ZZM118707	171916011700	SPA170

OE/IAM	MAGNETI MARELLI	
	LONG	SHORT
F1	SENSORE TEMPERATURA REFRIGERANTE COOLANT TEMPERATURE SENSOR	
MEAT & DORIA		
82015	171916011290	SPA129
82016	171916011210	SPA121
82017	171916011430	SPA143
82026	171916011310	SPA131
82032	171916011680	SPA168
82034	171916011260	SPA126
82035	171916011340	SPA134
82036	171916011500	SPA150
82037	171916011060	SPA106
82038	171916011050	SPA105
82044	171916011600	SPA160
82050	171916011100	SPA110
82059	171916011240	SPA124
82062	171916011250	SPA125
82065	171916011420	SPA142
82068	171916011510	SPA151
82070	171916011170	SPA117
82072	171916011360	SPA136
82076	171916011150	SPA115
82081	171916011400	SPA140
82083	171916011320	SPA132
82087	171916011190	SPA119
82092	171916011030	SPA103
82093	171916011280	SPA128
82097	171916011640	SPA164
82102	171916011220	SPA122
82103	171916011590	SPA159
82105	171916011090	SPA109
82106	171916011650	SPA165
82107	171916011160	SPA116
82108	171916011700	SPA170
82128	171916011110	SPA111
82132	171916011720	SPA172
82138	171916011080	SPA108
82139	171916011670	SPA167
82186	171916011440	SPA144
82187	171916011690	SPA169
82188	171916011070	SPA107
82189	171916011120	SPA112
82190	171916011630	SPA163
82192	171916011570	SPA157
82194	171916011620	SPA162
82214	171916011200	SPA120

OE/IAM	MAGNETI MARELLI	
	LONG	SHORT
F1	SENSORE TEMPERATURA REFRIGERANTE COOLANT TEMPERATURE SENSOR	
MEAT & DORIA		
82215	171916011530	SPA153
82234	171916011610	SPA161
82235	171916011380	SPA138
82237	171916011710	SPA171
82238	171916011560	SPA156
82239	171916011350	SPA135
82241	171916011470	SPA147
82264	171916011520	SPA152
82265	171916011270	SPA127
82269	171916011450	SPA145
82271	171916011390	SPA139
82272	171916011580	SPA158
82273	171916011230	SPA123
82274	171916011300	SPA130
82303	171916011460	SPA146
MERCEDES-BENZ		
0005425118	171916011630	SPA163
0085423217	171916011360	SPA136
135427817	171916011110	SPA111
A0135427817	171916011110	SPA111
METZGER		
0905058	171916011550	SPA155
0905126	171916011700	SPA170
0905133	171916011030	SPA103
0905160	171916011350	SPA135
0905165	171916011510	SPA151
0905175	171916011310	SPA131
0905263	171916011540	SPA154
0905275	171916011450	SPA145
0905328	171916011480	SPA148
MEYLE		
0140540035	171916011360	SPA136
1008000056	171916011400	SPA140
1008000062	171916011590	SPA159
1009190043	171916011590	SPA159
MINI		
13627535068	171916011610	SPA161
13627791951	171916011680	SPA168
MITSUBISHI		
M883623	171916011690	SPA169
MD177572	171916011420	SPA142
MD182467	171916011420	SPA142
MD770573	171916011270	SPA127

OE/IAM	MAGNETI MARELLI	
	LONG	SHORT
F1	SENSORE TEMPERATURA REFRIGERANTE COOLANT TEMPERATURE SENSOR	
MITSUBISHI		
MN980152	171916011110	SPA111
MN980264	171916011110	SPA111
MR985034	171916011420	SPA142
MTE-THOMSON		
3157	171916011550	SPA155
4000	171916011500	SPA150
4001	171916011310	SPA131
4003	171916011360	SPA136
4005	171916011030	SPA103
4011	171916011240	SPA124
4013	171916011650	SPA165
4015	171916011260	SPA126
4016	171916011440	SPA144
4020	171916011420	SPA142
4021	171916011210	SPA121
4024	171916011430	SPA143
4027	171916011680	SPA168
4032	171916011190	SPA119
4037	171916011700	SPA170
4038	171916011600	SPA160
4041	171916011510	SPA151
4045	171916011370	SPA137
4047	171916011250	SPA125
4048	171916011340	SPA134
4050	171916011150	SPA115
4052	171916011290	SPA129
4057	171916011160	SPA116
4059	171916011640	SPA164
4060	171916011590	SPA159
4067	171916011530	SPA153
4070	171916011700	SPA170
4074	171916011400	SPA140
4078	171916011030	SPA103
4080	171916011220	SPA122
4082	171916011670	SPA167
4083	171916011720	SPA172
4085	171916011630	SPA163
4087	171916011350	SPA135
4096	171916011200	SPA120
4097	171916011570	SPA157
4111	171916011610	SPA161

OE/IAM	MAGNETI MARELLI	
	LONG	SHORT
F1	SENSORE TEMPERATURA REFRIGERANTE COOLANT TEMPERATURE SENSOR	
NISSAN		
2263051E00	171916011370	SPA137
2263037950	171916011260	SPA126
2263099310	171916011500	SPA150
2263051E10	171916011370	SPA137
11023G7000	171916011310	SPA131
11023V0700	171916011310	SPA131
2263000Q1C	171916011080	SPA108
2263000QAB	171916011080	SPA108
2263000QAD	171916011690	SPA169
2263000QAF	171916011690	SPA169
2263001P01	171916011370	SPA137
2263010G00	171916011310	SPA131
2263070J00	171916011260	SPA126
2263071L00	171916011500	SPA150
2263099B00	171916011500	SPA150
22630BN702	171916011690	SPA169
22630D5900	171916011370	SPA137
22630G2402	171916011310	SPA131
22630G2404	171916011310	SPA131
22630N4200	171916011310	SPA131
22630P8100	171916011310	SPA131
22630S1E10	171916011260	SPA126
22630V5010	171916011370	SPA137
22630V9400	171916011370	SPA137
OPEL		
850413	171916011150	SPA115
852185	171916011290	SPA129
1338179	171916011030	SPA103
1338357	171916011030	SPA103
1338441	171916011150	SPA115
1338444	171916011040	SPA104
1338446	171916011290	SPA129
1338449	171916011300	SPA130
1338451	171916011040	SPA104
1338452	171916011290	SPA129
1338457	171916011290	SPA129
1338458	171916011040	SPA104
1338461	171916011030	SPA103
1338467	171916011030	SPA103
1338469	171916011280	SPA128
1338477	171916011150	SPA115
1338511	171916011030	SPA103
1341856	171916011150	SPA115

OE/IAM	MAGNETI MARELLI	
	LONG	SHORT
F1	SENSORE TEMPERATURA REFRIGERANTE COOLANT TEMPERATURE SENSOR	
OPEL		
1342567	171916011030	SPA103
4400329	171916011690	SPA169
4401810	171916011600	SPA160
4401811	171916011080	SPA108
4402578	171916011690	SPA169
4404723	171916011690	SPA169
4408333	171916011080	SPA108
4434334	171916011080	SPA108
4801922	171916011030	SPA103
4810250	171916011150	SPA115
4818227	171916011030	SPA103
6235605	171916011030	SPA103
6238179	171916011030	SPA103
6238266	171916011030	SPA103
6238317	171916011040	SPA104
6238356	171916011230	SPA123
6238422	171916011030	SPA103
6238935	171916011030	SPA103
6238938	171916011150	SPA115
6338486	171916011030	SPA103
9193163	171916011710	SPA171
9198691	171916011030	SPA103
15393755	171916011030	SPA103
55206393	171916011460	SPA146
90410792	171916011040	SPA104
90410793	171916011290	SPA129
90542063	171916011710	SPA171
90573217	171916011280	SPA128
93174208	171916011710	SPA171
93198313	171916011080	SPA108
97227219	171916011030	SPA103
PSA		
24246	171916011040	SPA104
024262	171916011290	SPA129
1338E2	171916011720	SPA172
133809	171916011020	SPA102
133857	171916011040	SPA104
133875	171916011200	SPA120
133888	171916011070	SPA107
133891	171916011200	SPA120
133897	171916011670	SPA167
5502644	171916011310	SPA131
91.514.549	171916011040	SPA104

OE/IAM	MAGNETI MARELLI	
	LONG	SHORT
F1	SENSORE TEMPERATURA REFRIGERANTE COOLANT TEMPERATURE SENSOR	
PSA		
96310010	171916011670	SPA167
96368023	171916011070	SPA107
96368027	171916011670	SPA167
96566364	171916011610	SPA161
7401346030	171916011290	SPA129
9623870180	171916011200	SPA120
9632562480	171916011720	SPA172
9636777180	171916011070	SPA107
9654414180	171916011720	SPA172
9655414180	171916011720	SPA172
6541E7	171916011720	SPA172
0242.46	171916011040	SPA104
1338.57	171916011040	SPA104
1338.A7	171916011070	SPA107
1338.C7	171916011030	SPA103
1338A6	171916011670	SPA167
1338A7	171916011070	SPA107
1338C1	171916011720	SPA172
1338C7	171916011030	SPA103
1338F3	171916011610	SPA161
1338F8	171916011610	SPA161
1338F9	171916011030	SPA103
1338G4	171916011420	SPA142
1338G9	171916011460	SPA146
19203F	171916011640	SPA164
1920KP	171916011620	SPA162
6541J0	171916011720	SPA172
RENAULT		
6001545356	171916011690	SPA169
7700101968	171916011080	SPA108
7700103348	171916011080	SPA108
7700111502	171916011690	SPA169
7700113867	171916011080	SPA108
7700582688	171916011310	SPA131
7700737571	171916011600	SPA160
7700867792	171916011690	SPA169
7700869343	171916011600	SPA160
7701053991	171916011150	SPA115
8200720768	171916011470	SPA147
9623870180	171916011200	SPA120
9636777280	171916011670	SPA167

OE/IAM	MAGNETI MARELLI	
	LONG	SHORT
F1	SENSORE TEMPERATURA REFRIGERANTE COOLANT TEMPERATURE SENSOR	
ROVER		
GTR204	171916011040	SPA104
GTR210	171916011550	SPA155
MEK100070	171916011550	SPA155
MEK100120	171916011550	SPA155
MVK10002	171916011640	SPA164
SAAB		
4503132	171916011040	SPA104
4660585	171916011030	SPA103
4770228	171916011040	SPA104
4772208	171916011030	SPA103
4772307	171916011030	SPA103
4773586	171916011030	SPA103
5341391	171916011030	SPA103
5959283	171916011030	SPA103
9136284	171916011240	SPA124
9137803	171916011240	SPA124
9177213	171916011030	SPA103
9198691	171916011030	SPA103
9357021	171916011040	SPA104
9542861	171916011030	SPA103
9543406	171916011030	SPA103
12566778	171916011030	SPA103
15393755	171916011030	SPA103
24436779	171916011030	SPA103
90542063	171916011030	SPA103
90570185	171916011030	SPA103
SIDAT		
82299	171916011460	SPA146
82387	171916011510	SPA151
82389	171916011170	SPA117
82391	171916011360	SPA136
82394	171916011150	SPA115
82457	171916011300	SPA130
82458	171916011580	SPA158
82459	171916011390	SPA139
82461	171916011450	SPA145
82465	171916011270	SPA127
82466	171916011520	SPA152
82473	171916011470	SPA147
82474	171916011350	SPA135
82475	171916011560	SPA156
82476	171916011710	SPA171
82478	171916011380	SPA138

OE/AM	MAGNETI MARELLI	
	LONG	SHORT
F1	SENSORE TEMPERATURA REFRIGERANTE COOLANT TEMPERATURE SENSOR	
SIDAT		
82479	171916011610	SPA161
82486	171916011530	SPA153
82497	171916011620	SPA162
82498	171916011133	SPA113
82499	171916011570	SPA157
82501	171916011630	SPA163
82502	171916011120	SPA112
82503	171916011070	SPA107
82504	171916011690	SPA169
82505	171916011440	SPA144
82522	171916011670	SPA167
82523	171916011080	SPA108
82525	171916011720	SPA172
82527	171916011110	SPA111
82536	171916011700	SPA170
82537	171916011160	SPA116
82538	171916011090	SPA109
82540	171916011590	SPA159
82541	171916011220	SPA122
82544	171916011640	SPA164
82547	171916011280	SPA128
82548	171916011030	SPA103
82552	171916011190	SPA119
82555	171916011320	SPA132
82560	171916011420	SPA142
82563	171916011250	SPA125
82566	171916011240	SPA124
82574	171916011600	SPA160
82579	171916011500	SPA150
82580	171916011340	SPA134
82581	171916011260	SPA126
82582	171916011040	SPA104
82583	171916011680	SPA168
82585	171916011550	SPA155
82586	171916011310	SPA131
82587	171916011370	SPA137
82592	171916011430	SPA143
82593	171916011210	SPA121
82594	171916011290	SPA129
82699	171916011050	SPA105
82701	171916011100	SPA110
82702	171916011060	SPA106
82886	171916011400	SPA140

OE/AM	MAGNETI MARELLI	
	LONG	SHORT
F1	SENSORE TEMPERATURA REFRIGERANTE COOLANT TEMPERATURE SENSOR	
SIDAT		
82891	171916011200	SPA120
82893	171916011650	SPA165
82896	171916011230	SPA123
SIEMENS VDO		
5WK90081	171916011320	SPA132
A2C53312548	171916011630	SPA163
SMART		
0009050700	171916011630	SPA163
0003118V002	171916011630	SPA163
0003118V002000000	171916011630	SPA163
STANDARD		
52975	171916011300	SPA130
55138	171916011230	SPA123
55146	171916011440	SPA144
55147	171916011590	SPA159
55168	171916011580	SPA158
55169	171916011480	SPA148
55501	171916011370	SPA137
55505	171916011340	SPA134
55512	171916011640	SPA164
55520	171916011640	SPA164
55524	171916011280	SPA128
55536	171916011570	SPA157
55546	171916011270	SPA127
700016	171916011600	SPA160
SUBARU		
22630KA020	171916011680	SPA168
SUZUKI		
1365078E00	171916011680	SPA168
1365078E00000	171916011680	SPA168
1365051G10	171916011680	SPA168
1365051G10000	171916011680	SPA168
1365054G00	171916011450	SPA145
1365054G00000	171916011450	SPA145
1365057F00	171916011170	SPA117
1365061B00	171916011680	SPA168
1365061B00000	171916011680	SPA168
1365064B00	171916011220	SPA122
1365064B00000	171916011220	SPA122
1365071C00	171916011680	SPA168
1365071C00000	171916011680	SPA168
1365073J00	171916011720	SPA172
1365084CT0	171916011690	SPA169

OE/IAM	MAGNETI MARELLI	
	LONG	SHORT
F1	SENSORE TEMPERATURA REFRIGERANTE COOLANT TEMPERATURE SENSOR	
SUZUKI		
1366084A00	171916011690	SPA169
SWAG		
81930673	171916011270	SPA127
TOPRAN		
100686	171916011210	SPA121
109245	171916011590	SPA159
109627	171916011440	SPA144
201677	171916011150	SPA115
206234	171916011280	SPA128
206726	171916011710	SPA171
302139	171916011160	SPA116
302716	171916011580	SPA158
302720	171916011510	SPA151
302723	171916011133	SPA113
400870	171916011360	SPA136
500520	171916011320	SPA132
500927	171916011120	SPA112
721090	171916011670	SPA167
TOYOTA		
8942202020	171916011070	SPA107
8942206010	171916011620	SPA162
8942220010	171916011680	SPA168
8942233020	171916011270	SPA127
8942233030	171916011620	SPA162
8942235010	171916011680	SPA168
8942947010	171916011620	SPA162
894220H010	171916011620	SPA162
SU00100639	171916011720	SPA172
VAG		
004435008	171916011040	SPA104
004435010	171916011310	SPA131
0004448131	171916011010	SPA101
025906041	171916011040	SPA104
026906161	171916011430	SPA143
034906161	171916011250	SPA125
059919501	171916011590	SPA159
113906161	171916011190	SPA119
0269061612	171916011250	SPA125
357919501	171916011400	SPA140
92860612600	171916011290	SPA129
95510612500	171916011110	SPA111
95510612501	171916011110	SPA111
99760641000	171916011110	SPA111

OE/IAM	MAGNETI MARELLI	
	LONG	SHORT
F1	SENSORE TEMPERATURA REFRIGERANTE COOLANT TEMPERATURE SENSOR	
VAG		
025906041A	171916011060	SPA106
035919369M	171916011210	SPA121
058919501A	171916011440	SPA144
059919501A	171916011090	SPA109
06A919501	171916011110	SPA111
06A919501A	171916011110	SPA111
078919501B	171916011650	SPA165
078919501C	171916011090	SPA109
251919501A	171916011050	SPA105
251919501D	171916011050	SPA105
357919501A	171916011100	SPA110
357919501B	171916011400	SPA140
4A0919501A	171916011590	SPA159
6U0919501	171916011040	SPA104
6U0919501B	171916011100	SPA110
J8942220010	171916011680	SPA168
X03952640	171916011040	SPA104
VALEO		
700000	171916011020	SPA102
700002	171916011010	SPA101
700012	171916011100	SPA110
700013	171916011400	SPA140
700018	171916011150	SPA115
700019	171916011040	SPA104
700022	171916011640	SPA164
700025	171916011440	SPA144
700026	171916011160	SPA116
700028	171916011030	SPA103
700036	171916011050	SPA105
700038	171916011430	SPA143
VEMO		
10720912	171916011440	SPA144
10720952	171916011400	SPA140
10990907	171916011590	SPA159
20720436	171916011640	SPA164
20720438	171916011320	SPA132
20720441	171916011120	SPA112
25720041	171916011133	SPA113
25720046	171916011160	SPA116
25720047	171916011700	SPA170
25720049	171916011720	SPA172
30720124	171916011630	SPA163
40720322	171916011150	SPA115

OE/IAM	MAGNETI MARELLI	
	LONG	SHORT
F1	SENSORE TEMPERATURA REFRIGERANTE COOLANT TEMPERATURE SENSOR	
VEMO		
V107209091	171916011060	SPA106
V107209101	171916011100	SPA110
V20720443	171916011040	SPA104
V22720026	171916011070	SPA107
V25721025	171916011510	SPA151
V26720002	171916011550	SPA155
V30-09-0023	171916011680	SPA168
V40720320	171916011030	SPA103
V40720332	171916011030	SPA103
V46720002	171916011080	SPA108
V95720024	171916011350	SPA135
VOLVO		
1346030	171916011290	SPA129
3344169	171916011600	SPA160
3345511	171916011600	SPA160
3433477	171916011290	SPA129
8653103	171916011680	SPA168
9125463	171916011390	SPA139
9186008	171916011350	SPA135
13323969	171916011040	SPA104
13460308	171916011290	SPA129
30757235	171916011720	SPA172
30874172	171916011680	SPA168
30874182	171916011420	SPA142
30883623	171916011690	SPA169
34334771	171916011290	SPA129

F2	TERMOCONTATTO - VENTOLA RADIATORE FAN TEMPERATURE SWITCH	
BERU		
0824121123	510033742001	SSA042
0824121124	510033742001	SSA042
0824121135	510033742001	SSA042
FACET		
75117	510033742001	SSA042
FEBI BILSTEIN		
04777	510033742001	SSA042
GENERAL MOTORS		
90242277	510033742001	SSA042
90277288	510033742001	SSA042
90506496	510033742001	SSA042

OE/IAM	MAGNETI MARELLI	
	LONG	SHORT
F2	TERMOCONTATTO - VENTOLA RADIATORE FAN TEMPERATURE SWITCH	
HELLA		
007807001	510033742001	SSA042
6ZT007807001	510033742001	SSA042
HERTH+BUSS ELPARTS		
70511104	510033742001	SSA042
MEAT & DORIA		
82639	510033742001	SSA042
OPEL		
1341011	510033742001	SSA042
1341017	510033742001	SSA042
1341047	510033742001	SSA042
90242277	510033742001	SSA042
SIDAT		
82790	510033742001	SSA042
VALEO		
819830	510033742001	SSA042
VEMO		
V40991042	510033742001	SSA042

GRUPPO G - GROUP G

	INTERRUTTORE PRESSIONE OLIO OIL PRESSURE SWITCH	
BERU		
0824331025	510050010200	SAA102
BOSCH		
0344101082	510050010200	SAA102
0986344082	510050010200	SAA102
0986344032090	510050010200	SAA102
0986344044090	510050010200	SAA102
0986344056090	510050010200	SAA102
0986344058090	510050010200	SAA102
0986344082090	510050010200	SAA102
BREMI		
10755/41	510050010200	SAA102
10755/41SB	510050010200	SAA102
10755/45	510050010400	SAA104
10755/45SB	510050010400	SAA104
ERA		
330004	510050010200	SAA102
330320	510050010500	SAA105
330337	510050010400	SAA104
330366	510050010300	SAA103

OE/IAM	MAGNETI MARELLI	
	LONG	SHORT
INTERRUTTORE PRESSIONE OLIO OIL PRESSURE SWITCH		
FACET		
70008	510050010200	SAA102
70045	510050010400	SAA104
70139	510050010500	SAA105
70141	510050010300	SAA103
FAE		
1107	510050010200	SAA102
1291	510050010400	SAA104
FCA		
55354325	510050010300	SAA103
FEBI BILSTEIN		
08470	510050010200	SAA102
08485	510050010400	SAA104
GENERAL MOTORS		
55354325	510050010300	SAA103
93190643	510050010300	SAA103
HELLA		
003259411	510050010200	SAA102
003259441	510050010400	SAA104
008280001	510050010500	SAA105
008780011	510050010300	SAA103
6ZL003259411	510050010200	SAA102
6ZL003259417	510050010200	SAA102
6ZL003259441	510050010400	SAA104
6ZL003259447	510050010400	SAA104
6ZL008280001	510050010500	SAA105
6ZL008780011	510050010300	SAA103
HERTH+BUSS ELPARTS		
70541019	510050010200	SAA102
70541049	510050010400	SAA104
70541070	510050010500	SAA105
70541077	510050010300	SAA103
MEAT & DORIA		
72007	510050010200	SAA102
72010	510050010400	SAA104
72014	510050010300	SAA103
72032	510050010500	SAA105
OPEL		
1238696	510050010300	SAA103
1252555	510050010300	SAA103
1252573	510050010300	SAA103
55581588	510050010300	SAA103
90534902	510050010300	SAA103
93190643	510050010300	SAA103

OE/IAM	MAGNETI MARELLI	
	LONG	SHORT
INTERRUTTORE PRESSIONE OLIO OIL PRESSURE SWITCH		
SIDAT		
82001	510050010200	SAA102
82014	510050010300	SAA103
82027	510050010500	SAA105
82031	510050010400	SAA104
VAG		
056919081	510050010400	SAA104
56919081	510050010400	SAA104
056919081	510050010400	SAA104
021919081C	510050010200	SAA102
036919081A	510050010500	SAA105
036919081D	510050010500	SAA105
056919081B	510050010200	SAA102
056919081C	510050010200	SAA102
056919081E	510050010400	SAA104
06A919081C	510050010500	SAA105
VAUXHALL		
93190643	510050010300	SAA103
VEMO		
V40730006	510050010300	SAA103
VOLVO		
1257137	510050010200	SAA102

MANOCONTATTO OIL PRESSURE SWITCH		
ERA		
330340	171901011010	SAA101
FACET		
70096	171901011010	SAA101
FCA		
7706596	171901011010	SAA101
55202374	171901011010	SAA101
500312468	171901011010	SAA101
HELLA		
6ZL003259601	171901011010	SAA101
MEAT & DORIA		
72026	171901011010	SAA101
SIDAT		
82007	171901011010	SAA101

OE/IAM

MAGNETI
MARELLI

LONG

SHORT

SENSORE PRESSIONE OLIO
OIL PRESSURE SWITCH**BOSCH**

0344101086	510050011200	SAA112
0984344040	510050010700	SAA107
0986345000	510050011000	SAA110
0986345001	510050011000	SAA110
0986345005	510050011000	SAA110
0986345009	510050010900	SAA109
0986345011	510050010600	SAA106
0986345012	510050011000	SAA110
0986345017	510050011100	SAA111

BREMI

1075029	510050011200	SAA112
---------	--------------	---------------

DAIHATSU

8353030060	510050011000	SAA110
8353087102	510050011000	SAA110
8353087201	510050011000	SAA110
8353087701	510050011000	SAA110
8353087702	510050011000	SAA110
8353087703	510050011000	SAA110
8353087706	510050011000	SAA110
8353030060000	510050011000	SAA110
8353060030000	510050011000	SAA110
8353087103000	510050011000	SAA110
8353087201000	510050011000	SAA110
8353087205000	510050011000	SAA110
8353087702000	510050011000	SAA110
8353087703000	510050011000	SAA110

ERA

330001	510050010700	SAA107
330005	510050011200	SAA112
330006	510050010600	SAA106
330007	510050010900	SAA109
330008	510050011000	SAA110
330009	510050011100	SAA111
330026	510050011800	SAA118
330028	510050011300	SAA113
330029	510050011500	SAA115
330030	510050011700	SAA117
330014B	510050010800	SAA108
330014HQ	510050010800	SAA108

OE/IAM

MAGNETI
MARELLI

LONG

SHORT

SENSORE PRESSIONE OLIO
OIL PRESSURE SWITCH**FACET**

70001	510050010700	SAA107
70011	510050011200	SAA112
70014	510050010600	SAA106
70015	510050010900	SAA109
70016	510050011000	SAA110
70031	510050010800	SAA108
70035	510050011100	SAA111
70130	510050011800	SAA118
70145	510050011300	SAA113
70146	510050011500	SAA115

FAE

10610	510050010600	SAA106
11200	510050010700	SAA107
11610	510050011100	SAA111
12040	510050010800	SAA108
12220	510050011200	SAA112
12230	510050010900	SAA109
12240	510050011000	SAA110
12610	510050011300	SAA113
12613	510050011500	SAA115
12640	510050011800	SAA118

FCA

4151243	510050010700	SAA107
4151564	510050010700	SAA107
4152127	510050010700	SAA107
4304418	510050010700	SAA107
4305685	510050010700	SAA107
4431182	510050010700	SAA107
4431183	510050010700	SAA107
4459908	510050010700	SAA107
4473333	510050010700	SAA107
4998770	510050010700	SAA107
5107603	510050010700	SAA107
5107683	510050010700	SAA107
5927407	510050010700	SAA107
71742590	510050011100	SAA111
79058146	510050010700	SAA107
92701368	510050010700	SAA107
553321200	510050011000	SAA110
553321205	510050011000	SAA110
6553306205	510050011000	SAA110
6553321200	510050011000	SAA110
6553321205	510050011000	SAA110

OE/IAM	MAGNETI MARELLI	
	LONG	SHORT
SENSORE PRESSIONE OLIO OIL PRESSURE SWITCH		
FCA		
9631846480	510050011800	SAA118
9659173880	510050011300	SAA113
FEBI BILSTEIN		
24436	510050011300	SAA113
26579	510050011500	SAA115
FORD		
0409160	510050011200	SAA112
1027970	510050011200	SAA112
1053881	510050011300	SAA113
1053882	510050011300	SAA113
1066811	510050011200	SAA112
1084764	510050011300	SAA113
1095149	510050011300	SAA113
1096320	510050011700	SAA117
1116647	510050011500	SAA115
1145966	510050011800	SAA118
1226188	510050011500	SAA115
1309298	510050011300	SAA113
1363198	510050011300	SAA113
1363512	510050011500	SAA115
1414897	510050011200	SAA112
1486742	510050011800	SAA118
1647828	510050011200	SAA112
3466716	510050011200	SAA112
6062916	510050011200	SAA112
6080608	510050011200	SAA112
6086163	510050011200	SAA112
6090246	510050010800	SAA108
6163243	510050010800	SAA108
6170902	510050011200	SAA112
6499475	510050011200	SAA112
6513125	510050011200	SAA112
6539971	510050011200	SAA112
6703036	510050010800	SAA108
6716335	510050011200	SAA112
1S7A9278AA	510050011500	SAA115
2S6Q9278AA	510050011800	SAA118
2S6Q9278AB	510050011800	SAA118
3M519278AA	510050011500	SAA115
3M519278AB	510050011500	SAA115
3S719278AB	510050011300	SAA113
3S719279A	510050011300	SAA113
81AB9278AA	510050011200	SAA112

OE/IAM	MAGNETI MARELLI	
	LONG	SHORT
SENSORE PRESSIONE OLIO OIL PRESSURE SWITCH		
FORD		
81AB9278BA	510050011200	SAA112
81AE9278BA	510050011200	SAA112
86AB9278AA	510050011200	SAA112
86AB9278BA	510050011200	SAA112
86AB9278BB	510050011200	SAA112
90AB3278AB	510050011200	SAA112
90AB9278AA	510050011200	SAA112
90AB9278AB	510050011200	SAA112
92BB9278AA	510050011200	SAA112
92VB9278AA	510050010800	SAA108
98AB9278AA	510050011300	SAA113
98AB9278CA	510050011300	SAA113
98FB9278AA	510050011200	SAA112
D0HZ9278A	510050011200	SAA112
D4AZ9278A	510050011200	SAA112
D8HZ9278A	510050011200	SAA112
F5RZ9278A	510050011200	SAA112
XS2Z9278AA	510050011300	SAA113
GENERAL MOTORS		
04024251	510050011000	SAA110
91112377	510050011100	SAA111
94021127	510050011000	SAA110
94118755	510050010900	SAA109
94312940	510050010900	SAA109
94841821	510050011100	SAA111
94845488	510050011000	SAA110
94846169	510050011100	SAA111
94847544	510050011000	SAA110
94851293	510050011000	SAA110
96052138	510050011100	SAA111
96053621	510050011100	SAA111
HELLA		
6ZF007391001	510050010900	SAA109
6ZF007394001	510050011100	SAA111
6ZL003259321	510050011000	SAA110
6ZL003259711	510050011300	SAA113
6ZL009600041	510050011800	SAA118
6ZL009600081	510050011500	SAA115
6ZL009600091	510050010600	SAA106
6ZL009600101	510050011200	SAA112

OE/IAM

MAGNETI
MARELLI

LONG

SHORT

SENSORE PRESSIONE OLIO
OIL PRESSURE SWITCH**HONDA**

37200611154	510050010600	SAA106
37200657154	510050010600	SAA106
37240657003	510050010600	SAA106
37240657305	510050010600	SAA106
37600611154	510050010600	SAA106
37240P13003	510050010600	SAA106
37240P13014	510050010600	SAA106
37240PA6004	510050010600	SAA106
37240PCX003	510050010600	SAA106
37240PD2003	510050010900	SAA109
37240PD2004	510050010900	SAA109
37240PD4003	510050010900	SAA109
37240PT0003	510050010900	SAA109
37240PT0004	510050010900	SAA109
37240PT0013	510050010900	SAA109
37240PT0014	510050010900	SAA109
37240PT0023	510050010900	SAA109

HYUNDAI

3475045001	510050010600	SAA106
------------	--------------	---------------

KIA

9461073011	510050011100	SAA111
0K71E18501	510050011100	SAA111
0K90018501C	510050011100	SAA111
0K90118501	510050011100	SAA111
KK15018501C	510050011000	SAA110
KK15018501D	510050011000	SAA110
KK15118501	510050011000	SAA110

MARUTI

3782082001	510050010600	SAA106
------------	--------------	---------------

MAZDA

022218501	510050010600	SAA106
022318501	510050010600	SAA106
023318501	510050010600	SAA106
060018501	510050010600	SAA106
081318501	510050010600	SAA106
134518501	510050011100	SAA111
022218501A	510050010600	SAA106
022298501A	510050010600	SAA106
081318501A	510050010600	SAA106
086618501A	510050011000	SAA110
1E0018501	510050011200	SAA112
1E0018501A	510050011200	SAA112
269118501A	510050011000	SAA110

OE/IAM

MAGNETI
MARELLI

LONG

SHORT

SENSORE PRESSIONE OLIO
OIL PRESSURE SWITCH**MAZDA**

B36618501	510050011100	SAA111
B36718501	510050011100	SAA111
D27Z9278A	510050011000	SAA110
E50318501	510050011000	SAA110
E5D318501	510050011000	SAA110
E5D318510	510050011000	SAA110
FEJK18501	510050011000	SAA110
FS1118501A	510050011100	SAA111
FS111850X	510050011100	SAA111
JE4818501A	510050011100	SAA111
JF0118501	510050011000	SAA110
LF0118501	510050011500	SAA115
R20718501	510050010600	SAA106
Y40118501	510050011800	SAA118
Y40118501A	510050011800	SAA118

MEAT & DORIA

72000	510050011100	SAA111
72001	510050010600	SAA106
72002	510050010900	SAA109
72016	510050011300	SAA113
72017	510050011500	SAA115
72018	510050011700	SAA117
72020	510050011200	SAA112
72031	510050011800	SAA118
72033	510050011000	SAA110
72034	510050010700	SAA107

MINI

12617536724	510050011800	SAA118
12617568481	510050011800	SAA118

MINI

1258A002	510050011100	SAA111
MC840119	510050011100	SAA111
MC840219	510050011100	SAA111
MD001481	510050011100	SAA111
MD001482	510050011100	SAA111
MD001483	510050011100	SAA111
MD017430	510050011100	SAA111
MD021566	510050011100	SAA111
MD021567	510050011100	SAA111
MD138993	510050011100	SAA111

NISSAN

252406F901	510050011800	SAA118
------------	--------------	---------------

OE/IAM	MAGNETI MARELLI	
	LONG	SHORT
SENSORE PRESSIONE OLIO OIL PRESSURE SWITCH		
OPEL		
1252567	510050011000	SAA110
PSA		
9661477580	510050011800	SAA118
1131C5	510050011800	SAA118
1131J2	510050011300	SAA113
1131K5	510050011800	SAA118
RENAULT		
9631846480	510050011800	SAA118
ROVER		
GPS124	510050010600	SAA106
GPS177	510050010900	SAA109
GPS178	510050010600	SAA106
GPS184	510050010600	SAA106
SIDAT		
82002	510050010700	SAA107
82003	510050010900	SAA109
82004	510050010600	SAA106
82005	510050011000	SAA110
82006	510050011100	SAA111
82009	510050011500	SAA115
82010	510050011200	SAA112
82012	510050011700	SAA117
82020	510050011800	SAA118
82021	510050011300	SAA113
STANDARD		
50570	510050010700	SAA107
50590	510050011200	SAA112
50591	510050011300	SAA113
50750	510050010600	SAA106
51163	510050011500	SAA115
51174	510050011800	SAA118
SUBARU		
429957000	510050011100	SAA111
829956100	510050011100	SAA111
829956101	510050011100	SAA111
25240KA020	510050011100	SAA111
25240KA040	510050011100	SAA111
25240KA080	510050011100	SAA111
SUZUKI		
3782077E90	510050011000	SAA110
1658267G00000	510050011800	SAA118
1658286CT0	510050011800	SAA118

OE/IAM	MAGNETI MARELLI	
	LONG	SHORT
SENSORE PRESSIONE OLIO OIL PRESSURE SWITCH		
TOYOTA		
8353002030	510050011100	SAA111
8353002040	510050011800	SAA118
8353010010	510050011100	SAA111
8353010020	510050011100	SAA111
8353012010	510050011100	SAA111
8353012020	510050011100	SAA111
8353012040	510050011100	SAA111
8353014010	510050011100	SAA111
8353014020	510050011100	SAA111
8353014030	510050011100	SAA111
8353014040	510050011100	SAA111
8353014050	510050011100	SAA111
8353028030	510050011100	SAA111
8353030010	510050011000	SAA110
8353030020	510050011000	SAA110
8353030021	510050011000	SAA110
8353030022	510050011000	SAA110
8353030030	510050011100	SAA111
8353030040	510050011000	SAA110
8353030041	510050011100	SAA111
8353030042	510050011000	SAA110
8353030043	510050011100	SAA111
8353030050	510050011000	SAA110
8353030060	510050011000	SAA110
8353030080	510050011100	SAA111
8353030250	510050011000	SAA110
8353036010	510050011000	SAA110
8353036011	510050011000	SAA110
8353036017	510050011000	SAA110
8353060040	510050011100	SAA111
8553002030	510050011100	SAA111
8864530250	510050011000	SAA110
SU00100591	510050011800	SAA118
VAG		
0003933681	510050010700	SAA107
3933681	510050010700	SAA107
00A919081	510050010700	SAA107
CA94200004	510050010700	SAA107
EA94200004	510050010700	SAA107
HB94200030	510050010700	SAA107
J8353014030	510050011100	SAA111
J8353030060	510050011000	SAA110
SE020942000A	510050010700	SAA107

OE/IAM

MAGNETI
MARELLI

LONG

SHORT

SENSORE PRESSIONE OLIO
OIL PRESSURE SWITCH

VOLVO

8653814	510050011800	SAA118
30711658	510050011500	SAA115
30725229	510050011800	SAA118
30757396	510050011500	SAA115
31259226	510050011800	SAA118

GRUPPO H - GROUP H

H4

SENSORE ACQUA CARBURANTE
WATER SENSOR - FUEL SYSTEM

FCA

77363659	510030001010	SAF001
----------	--------------	--------

MEAT & DORIA

9284	510030001010	SAF001
------	--------------	--------

SIDAT

81175	510030001010	SAF001
-------	--------------	--------

H3

SENSORE DETONAZIONE
KNOCK SENSOR

BLUE PRINT

ADG07213	064836024010	SAD024
ADG07214	064836009010	SAD009
ADG07216	064836027010	SAD027
ADS77209	064836010010	SAD010

BOSCH

0261231004	064836019010	SAD019
0261231005	064836019010	SAD019
0261231007	064836013010	SAD013
0261231033	064836013010	SAD013
0261231036	064836021010	SAD021
0261231038	064836019010	SAD019
0261231039	064836019010	SAD019
0261231044	064836002010	SAD002
0261231045	064836028010	SAD028
0261231046	064836028010	SAD028
0261231047	064836002010	SAD002
0261231048	064836002010	SAD002
0261231066	064836005010	SAD005
0261231067	064836005010	SAD005
0261231070	064836013010	SAD013
0261231071	064836013010	SAD013
0261231091	064836013010	SAD013
0261231092	064836005010	SAD005

OE/IAM

MAGNETI
MARELLI

LONG

SHORT

H3

SENSORE DETONAZIONE
KNOCK SENSOR

BOSCH

0261231095	064836009010	SAD009
0261231105	064836013010	SAD013
0261231106	064836013010	SAD013
0261231108	064836028010	SAD028
0261231109	064836008010	SAD008
0261231110	064836018010	SAD018
0261231111	064836018010	SAD018
0261231128	064836030010	SAD030
0261231130	064836008010	SAD008
0261231131	064836016010	SAD016
0261231144	064836003010	SAD003
0261231146	064836031010	SAD031
0261231147	064836031010	SAD031
0261231148	064836016010	SAD016
0261231173	064836026010	SAD026
0261231174	064836004010	SAD004
0261231176	064836026010	SAD026
0261231188	064836028010	SAD028
0261231189	064836028010	SAD028
0261231193	064836025010	SAD025
0986JG0835	064836010010	SAD010

BUGIAD

BSP20704	064836028010	SAD028
----------	--------------	--------

CHEVROLET

96253545	064836024010	SAD024
----------	--------------	--------

DACIA

8200639103	064836035010	SAD035
8200680689	064836035010	SAD035

DAEWOO

0031538928	064836033010	SAD033
96253545	064836024010	SAD024
96253615	064836009010	SAD009

DELPHI

AS1009211B1	064836010010	SAD010
AS1013412B1	064836027010	SAD027

ERA

550044	064836035010	SAD035
550045	064836033010	SAD033
550054	064836027010	SAD027
550106	064836031010	SAD031
550154	064836012010	SAD012
550198	064836015010	SAD015
550207	064836019010	SAD019

OE/AM	 LONG SHORT	
-------	-------------------------------------	--

H3	SENSORE DETONAZIONE KNOCK SENSOR	
----	-------------------------------------	--

ERA		
550211	064836033010	SAD033
550212	064836007010	SAD007
550230	064836009010	SAD009
550236	064836021010	SAD021
550246	064836002010	SAD002
550274	064836040010	SAD040
550284	064836024010	SAD024
550285	064836006010	SAD006
550286	064836013010	SAD013
550294	064836037010	SAD037
550295	064836036010	SAD036
550296	064836038010	SAD038
550298	064836041010	SAD041
550305	064836026010	SAD026
550424	064836030010	SAD030
550425	064836008010	SAD008
550436	064836039010	SAD039
550468	064836014010	SAD014
550567	064836025010	SAD025
550595	064836010010	SAD010
550597	064836003010	SAD003
550611	064836029010	SAD029
550624	064836016010	SAD016
550675	064836005010	SAD005
550676	064836004010	SAD004
550054B	064836027010	SAD027
550106B	064836031010	SAD031
550207B	064836019010	SAD019
550236B	064836021010	SAD021
550305B	064836026010	SAD026
550425B	064836008010	SAD008
550595B	064836010010	SAD010
550597B	064836003010	SAD003

FACET		
--------------	--	--

93001	064836028010	SAD028
93002	064836013010	SAD013
93004	064836008010	SAD008
93006	064836026010	SAD026
93009	064836025010	SAD025
93012	064836004010	SAD004
93013	064836019010	SAD019
93015	064836002010	SAD002
93016	064836005010	SAD005

OE/AM	 LONG SHORT	
-------	-------------------------------------	--

H3	SENSORE DETONAZIONE KNOCK SENSOR	
----	-------------------------------------	--

FACET		
--------------	--	--

93018	064836025010	SAD025
93023	064836009010	SAD009
93030	064836016010	SAD016
93032	064836003010	SAD003
93050	064836012010	SAD012
93052	064836024010	SAD024
93054	064836021010	SAD021
93066	064836007010	SAD007
93069	064836006010	SAD006
93074	064836015010	SAD015
93079	064836027010	SAD027
93091	064836038010	SAD038
93105	064836036010	SAD036
93113	064836029010	SAD029
93135	064836018010	SAD018
93141	064836040010	SAD040
93143	064836030010	SAD030
93144	064836031010	SAD031
93148	064836033010	SAD033
93174	064836039010	SAD039
93187	064836041010	SAD041
93205	064836014010	SAD014
93224	064836035010	SAD035

FAE		
------------	--	--

60100	064836028010	SAD028
60101	064836013010	SAD013
60102	064836008010	SAD008
60104	064836026010	SAD026
60105	064836025010	SAD025
60107	064836004010	SAD004
60108	064836019010	SAD019
60109	064836002010	SAD002
60110	064836005010	SAD005
60111	064836009010	SAD009
60113	064836016010	SAD016
60114	064836003010	SAD003
60130	064836012010	SAD012
60132	064836024010	SAD024
60140	064836007010	SAD007
60145	064836015010	SAD015
60158	064836018010	SAD018
60159	064836030010	SAD030
60160	064836031010	SAD031

OE/IAM

MAGNETI
MARELLI

LONG

SHORT

H3 SENSORE DETONAZIONE
KNOCK SENSOR**FAE**

60161	064836033010	SAD033
60188	064836035010	SAD035
60190	064836021010	SAD021
60212	064836039010	SAD039
60221	064836040010	SAD040
60225	064836027010	SAD027
60230	064836038010	SAD038
60232	064836036010	SAD036
60233	064836041010	SAD041
60237	064836025010	SAD025

FCA

7083326	064836027010	SAD027
7669123	064836013010	SAD013
46469867	064836016010	SAD016
46525288	064836003010	SAD003
46552951	064836016010	SAD016
55186669	064836026010	SAD026
55187820	064836026010	SAD026
55353316	064836033010	SAD033
60548743	064836013010	SAD013
60592752	064836009010	SAD009
60808063	064836013010	SAD013
60810791	064836009010	SAD009
71739674	064836004010	SAD004
76691230	064836013010	SAD013
605487430	064836013010	SAD013
7401367643	064836013010	SAD013
9617755980	064836013010	SAD013
9617756080	064836033010	SAD033
9621334480	064836008010	SAD008
9628648280	064836008010	SAD008
9638423480	064836033010	SAD033

FEBI BILSTEIN

28445	064836027010	SAD027
-------	--------------	---------------

FORD

1029801	064836002010	SAD002
1068159	064836038010	SAD038
1119941	064836036010	SAD036
1132002	064836040010	SAD040
1141998	064836037010	SAD037
1205185	064836031010	SAD031
1357496	064836041010	SAD041
1358032	064836036010	SAD036

OE/IAM

MAGNETI
MARELLI

LONG

SHORT

H3 SENSORE DETONAZIONE
KNOCK SENSOR**FORD**

1362065	064836041010	SAD041
1371593	064836039010	SAD039
1374710	064836041010	SAD041
1N1A12A699AA	064836040010	SAD040
1S7A12A699BA	064836036010	SAD036
1S7A12A699BB	064836036010	SAD036
4M5112A699AA	064836041010	SAD041
4M5112A699AB	064836041010	SAD041
4M5112A699BA	064836041010	SAD041
6M5G12A699AA	064836039010	SAD039
95VW12A699AA	064836002010	SAD002
98MF12A699AB	064836038010	SAD038
98MF12A699BA	064836037010	SAD037
YM2112A699BA	064836031010	SAD031

GENERAL MOTORS

9158720	064836007010	SAD007
10456240	064836027010	SAD027
10456669	064836027010	SAD027
12566845	064836004010	SAD004
24456516	064836015010	SAD015
55353316	064836033010	SAD033
90411972	064836012010	SAD012
90536392	064836015010	SAD015
91159930	064836035010	SAD035
92061913	064836013010	SAD013
93189202	064836004010	SAD004
93198199	064836035010	SAD035
93203180	064836019010	SAD019
93261954	064836028010	SAD028
96253545	064836024010	SAD024
96253615	064836009010	SAD009
96508199	064836012010	SAD012

HELLA

6PG008108321	064836015010	SAD015
6PG009108051	064836012010	SAD012
6PG009108081	064836021010	SAD021
6PG009108091	064836019010	SAD019
6PG009108191	064836033010	SAD033
6PG009108321	064836015010	SAD015
6PG009108381	064836005010	SAD005
6PG009108411	064836031010	SAD031
6PG009108431	064836033010	SAD033
6PG009108511	064836019010	SAD019

OE/IAM		 LONG SHORT	
H3	SENSORE DETONAZIONE KNOCK SENSOR		
HELLA			
6PG009108531	064836012010	SAD012	
6PG009108551	064836015010	SAD015	
6PG009108561	064836031010	SAD031	
6PG009108571	064836033010	SAD033	
6PG009108581	064836028010	SAD028	
6PG009108631	064836009010	SAD009	
6PG009108661	064836024010	SAD024	
6PG009108721	064836027010	SAD027	
HYUNDAI			
3925022003	064836013010	SAD013	
3925022010	064836013010	SAD013	
3925023010	064836006010	SAD006	
3925023500	064836014010	SAD014	
INTERMOTOR			
19506	064836024010	SAD024	
19507	064836008010	SAD008	
19516	064836027010	SAD027	
19519	064836028010	SAD028	
19521	064836003010	SAD003	
19526	064836033010	SAD033	
19527	064836009010	SAD009	
19536	064836031010	SAD031	
19578	064836025010	SAD025	
JAGUAR			
JD61212	064836040010	SAD040	
LRA1692DB	064836037010	SAD037	
KIA			
3925023500	064836014010	SAD014	
0K01D18921	064836006010	SAD006	
0K2CC18921	064836024010	SAD024	
LUCAS ELECTRICAL			
SEB1047	064836019010	SAD019	
SEB1048	064836005010	SAD005	
SEB1049	064836024010	SAD024	
SEB1050	064836008010	SAD008	
SEB1508	064836025010	SAD025	
SEB889	064836013010	SAD013	
MAZDA			
30757381AA	064836036010	SAD036	
AJ0318921	064836037010	SAD037	
C20118921	064836037010	SAD037	
LF0118921	064836036010	SAD036	
LF0118921Z05	064836036010	SAD036	

OE/IAM		 LONG SHORT	
H3	SENSORE DETONAZIONE KNOCK SENSOR		
MAZDA			
LF0218921	064836036010	SAD036	
MERCEDES-BENZ			
0031538628	064836018010	SAD018	
0031538928	064836033010	SAD033	
0041534628	064836028010	SAD028	
0041539028	064836028010	SAD028	
0061533628	064836028010	SAD028	
A0031538928	064836033010	SAD033	
METZGER			
0907003	064836037010	SAD037	
0907006	064836028010	SAD028	
0907007	064836009010	SAD009	
0907013	064836024010	SAD024	
0907016	064836038010	SAD038	
0907030	064836025010	SAD025	
0907078	064836027010	SAD027	
MITSUBISHI			
1865A014	064836029010	SAD029	
E1T52271	064836029010	SAD029	
NISSAN			
7700866055	064836035010	SAD035	
22060000QA	064836035010	SAD035	
2206000Q0A	064836035010	SAD035	
2206000Q0B	064836035010	SAD035	
2206000QAA	064836035010	SAD035	
220607S000	064836029010	SAD029	
22060AU010	064836029010	SAD029	
22060BN700	064836035010	SAD035	
OPEL			
4408303	064836035010	SAD035	
4433885	064836035010	SAD035	
4805506	064836024010	SAD024	
6235703	064836033010	SAD033	
6235712	064836004010	SAD004	
6235746	064836004010	SAD004	
6238099	064836015010	SAD015	
6238181	064836007010	SAD007	
6238221	064836015010	SAD015	
6238312	064836012010	SAD012	
6238353	064836013010	SAD013	
6238370	064836027010	SAD027	
9158720	064836007010	SAD007	
10456240	064836027010	SAD027	

OE/IAM

MAGNETI
MARELLI

LONG

SHORT

H3 | **SENSORE DETONAZIONE**
KNOCK SENSOR**OPEL**

10456669	064836027010	SAD027
24420696	064836026010	SAD026
90536392	064836015010	SAD015
93177171	064836026010	SAD026
93189202	064836004010	SAD004
93399899	064836026010	SAD026
96253545	064836024010	SAD024

PSA

594605	064836013010	SAD013
594610	064836013010	SAD013
594611	064836013010	SAD013
594615	064836013010	SAD013
594616	064836013010	SAD013
594617	064836013010	SAD013
594618	064836013010	SAD013
594619	064836013010	SAD013
594620	064836013010	SAD013
594621	064836028010	SAD028
594622	064836008010	SAD008
594623	064836033010	SAD033
594628	064836030010	SAD030
594630	064836008010	SAD008
594635	064836025010	SAD025
96037068	064836013010	SAD013
96127657	064836013010	SAD013
96127658	064836013010	SAD013
96168084	064836028010	SAD028
96177560	064836033010	SAD033
96213344	064836008010	SAD008
96231343	064836008010	SAD008
96275932	064836030010	SAD030
96286482	064836008010	SAD008
96384234	064836033010	SAD033
96384235	064836030010	SAD030
9603706880	064836013010	SAD013
9616808480	064836028010	SAD028
9617756080	064836033010	SAD033
9623134380	064836008010	SAD008
9627593280	064836030010	SAD030
9638423480	064836033010	SAD033
9638423580	064836030010	SAD030

OE/IAM

MAGNETI
MARELLI

LONG

SHORT

H3 | **SENSORE DETONAZIONE**
KNOCK SENSOR**RENAULT**

7431367644	064836028010	SAD028
7700866055	064836035010	SAD035
7700871678	064836028010	SAD028
7701065379	064836029010	SAD029
8200639103	064836035010	SAD035
8200680689	064836035010	SAD035
9612765780	064836013010	SAD013
9612765880	064836013010	SAD013
9628648280	064836008010	SAD008

SAAB

914241	064836028010	SAD028
9142415	064836028010	SAD028
93189202	064836004010	SAD004

SAGEM

2576032A	064836033010	SAD033
2576032YHEL	064836033010	SAD033

SIDAT

83471	064836010010	SAD010
84001	064836035010	SAD035
84002	064836033010	SAD033
84006	064836012010	SAD012
84008	064836015010	SAD015
84011	064836007010	SAD007
84016	064836009010	SAD009
84018	064836002010	SAD002
84020	064836013010	SAD013
84022	064836008010	SAD008
84025	064836024010	SAD024
84029	064836018010	SAD018
84033	064836006010	SAD006
84037	064836005010	SAD005
84038	064836025010	SAD025
84044	064836029010	SAD029
84050	064836014010	SAD014

SIEMENS VDO

5WK90561	064836012010	SAD012
5WK96063	064836015010	SAD015
G855302990800Z	064836019010	SAD019
S103057001Z	064836012010	SAD012
S103995001Z	064836033010	SAD033
S105722003Z	064836007010	SAD007
S107646001Z	064836031010	SAD031

OE/IAM	MAGNETI MARELLI	
	LONG	SHORT
H3	SENSORE DETONAZIONE KNOCK SENSOR	
SMART		
1321530128	064836029010	SAD029
SSANGYONG		
0031538928	064836033010	SAD033
STANDARD		
19505	064836005010	SAD005
19514	064836037010	SAD037
19515	064836040010	SAD040
19520	064836002010	SAD002
19522	064836012010	SAD012
19523	064836006010	SAD006
19524	064836018010	SAD018
19525	064836030010	SAD030
19532	064836007010	SAD007
19535	064836015010	SAD015
SUBARU		
22060AA070	064836010010	SAD010
SUZUKI		
1864084A00000	064836035010	SAD035
TOPRAN		
111386	064836028010	SAD028
207429	064836007010	SAD007
401624	064836033010	SAD033
TOYOTA		
8961520090	064836025010	SAD025
896150H010	064836025010	SAD025
VAG		
021905377	064836002010	SAD002
030905377	064836005010	SAD005
054905377	064836021010	SAD021
0539053772	064836019010	SAD019
92860614400	064836021010	SAD021
99760612100	064836026010	SAD026
030905377A	064836028010	SAD028
030905377C	064836031010	SAD031
034905377A	064836019010	SAD019
054905377A	064836019010	SAD019
054905377G	064836021010	SAD021
054905377H	064836019010	SAD019
077905377A	064836019010	SAD019
34905377A	064836019010	SAD019

OE/IAM	MAGNETI MARELLI	
	LONG	SHORT
H3	SENSORE DETONAZIONE KNOCK SENSOR	
VAUXHALL		
6238312	064836012010	SAD012
90411972	064836012010	SAD012
VEMO		
V24720094	064836009010	SAD009
V25720007	064836038010	SAD038
V30720096	064836033010	SAD033
V40720334	064836027010	SAD027
V51720001	064836024010	SAD024
V70720015	064836025010	SAD025
VOLVO		
1367643	064836013010	SAD013
30658180	064836036010	SAD036
30711662	064836037010	SAD037
30757381	064836036010	SAD036
30658180A	064836036010	SAD036
30711662A	064836037010	SAD037

H1	SENSORE GIRI / FASE - ALBERO MOTORE CRANKSHAFT POSITION SENSOR	
	BBT	
CSS1300	064848133010	SAG133
CSS1303	064848025010	SAG025
CSS1513	064848157010	SAG157
CSS1515	064848126010	SAG126
CSS1517	064848168010	SAG168
CSS1518	064848164010	SAG164
CSS1521	064848130010	SAG130
CSS1527	064848158010	SAG158
CSS1528	064848036010	SAG036
CSS1529	064848036010	SAG036
CSS1535	064848143010	SAG143
CSS1603	064848108010	SAG108
CSS1604	064848088010	SAG088
CSS309	064848118010	SAG118
CSS314	064848090010	SAG090
CSS319	064848064010	SAG064
CSS704	064848124010	SAG124
CSS705	064848137010	SAG137
CSS710	064848116010	SAG116
CSS713	064848019010	SAG019
CSS900	064848115010	SAG115
CSS901	064848075010	SAG075
CSS902	064848151010	SAG151

OE/IAM	MAGNETI MARELLI	
	LONG	SHORT
H1	SENSORE GIRI / FASE - ALBERO MOTORE CRANKSHAFT POSITION SENSOR	
BBT		
CSS903	064848111010	SAG111
CSS906	064848087010	SAG087
CSS907	064848099010	SAG099
CSS913	064848144010	SAG144
BLUE PRINT		
ADA107203C	064848044010	SAG044
ADA107215	064848044010	SAG044
ADG07210	064848135010	SAG135
ADG07220	064848074010	SAG074
ADG07228	064848054010	SAG054
ADG07239	064848112010	SAG112
ADM57205	064848108010	SAG108
BMW		
7518628	064848151010	SAG151
12141247218	064848099010	SAG099
12141247259	064848099010	SAG099
12141435351	064848151010	SAG151
12141438082	064848151010	SAG151
12141703221	064848115010	SAG115
12141703277	064848111010	SAG111
12141708619	064848032010	SAG032
12141709616	064848144010	SAG144
12141710668	064848045010	SAG045
12141710699	064848045010	SAG045
12141713007	064848073010	SAG073
12141715030	064848073010	SAG073
12141720852	064848073010	SAG073
12141720854	064848073010	SAG073
12141726066	064848087010	SAG087
12141727554	064848062010	SAG062
12141730027	064848075010	SAG075
12141739886	064848104010	SAG104
12141742629	064848061010	SAG061
12147506273	064848151010	SAG151
12147518628	064848151010	SAG151
12521279695	064848045010	SAG045
13627839138	064848061010	SAG061
BOSCH		
0261210003	064848047010	SAG047
0261210028	064848045010	SAG045
0261210029	064848066010	SAG066
0261210030	064848093010	SAG093
0261210060	064848073010	SAG073

OE/IAM	MAGNETI MARELLI	
	LONG	SHORT
H1	SENSORE GIRI / FASE - ALBERO MOTORE CRANKSHAFT POSITION SENSOR	
BOSCH		
0261210062	064848073010	SAG073
0261210090	064848040010	SAG040
0261210094	064848064010	SAG064
0261210096	064848029010	SAG029
0261210099	064848105010	SAG105
0261210104	064848067010	SAG067
0261210119	064848043010	SAG043
0261210127	064848048010	SAG048
0261210133	064848078010	SAG078
0261210139	064848038010	SAG038
0261210140	064848038010	SAG038
0261210141	064848024010	SAG024
0261210145	064848090010	SAG090
0261210146	064848090010	SAG090
0261210147	064848018010	SAG018
0261210150	064848057010	SAG057
0261210151	064848019010	SAG019
0261210160	064848122010	SAG122
0261210161	064848097010	SAG097
0261210165	064848033010	SAG033
0261210167	064848030010	SAG030
0261210169	064848031010	SAG031
0261210170	064848023010	SAG023
0261210177	064848049010	SAG049
0261210178	064848096010	SAG096
0261210179	064848096010	SAG096
0261210188	064848145010	SAG145
0261210189	064848145010	SAG145
0261210192	064848056010	SAG056
0261210193	064848056010	SAG056
0261210203	064848039010	SAG039
0261210219	064848097010	SAG097
0261210227	064848102010	SAG102
0261210257	064848132010	SAG132
0261210258	064848132010	SAG132
0261210269	064848078010	SAG078
0281002096	064848047010	SAG047
0281002102	064848121010	SAG121
0281002108	064848071010	SAG071
0281002121	064848081010	SAG081
0281002123	064848146010	SAG146
0281002124	064848146010	SAG146
0281002138	064848021010	SAG021

OE/IAM		 LONG SHORT	
H1	SENSORE GIRI / FASE - ALBERO MOTORE <i>CRANKSHAFT POSITION SENSOR</i>		
BOSCH			
0281002138	064848021011	SAG021-1	
0281002175	064848114010	SAG114	
0281002191	064848063010	SAG063	
0281002223	064848017010	SAG017	
0281002285	064848060010	SAG060	
0281002315	064848019010	SAG019	
0281002332	064848089010	SAG089	
0281002349	064848052010	SAG052	
0281002486	064848174010	SAG174	
0281002513	064848058010	SAG058	
0281002662	064848069010	SAG069	
0281002778	064848110010	SAG110	
0281210151	064848019010	SAG019	
0986280401	064848059010	SAG059	
0986280402	064848150010	SAG150	
0986280403	064848095010	SAG095	
0986280405	064848158010	SAG158	
0986280406	064848156010	SAG156	
0986280407	064848036010	SAG036	
0986280408	064848164010	SAG164	
0986280410	064848160010	SAG160	
0986280411	064848163010	SAG163	
0986280412	064848153010	SAG153	
0986280416	064848157010	SAG157	
0986280417	064848126010	SAG126	
0986280419	064848168010	SAG168	
0986280424	064848025010	SAG025	
0986280434	064848155010	SAG155	
1237013838	111040211103	CWM02/3	
1237330801	111040211106	CWM02/6	
F00099R101	111040211101	CWM02/1	
BOUGICORD			
141201	064848133010	SAG133	
141204	064848025010	SAG025	
141220	064848080010	SAG080	
141221	064848082010	SAG082	
144303	064848150010	SAG150	
144304	064848150010	SAG150	
144306	064848150010	SAG150	
144307	064848156010	SAG156	
144313	064848150010	SAG150	
144314	064848156010	SAG156	
144327	064848157010	SAG157	

OE/IAM		 LONG SHORT	
H1	SENSORE GIRI / FASE - ALBERO MOTORE <i>CRANKSHAFT POSITION SENSOR</i>		
BOUGICORD			
144329	064848126010	SAG126	
144334	064848168010	SAG168	
144335	064848164010	SAG164	
144336	064848130010	SAG130	
144382	064848167010	SAG167	
144385	064848169010	SAG169	
144408	064848153010	SAG153	
144430	064848095010	SAG095	
144436	064848095010	SAG095	
144441	064848158010	SAG158	
144442	064848036010	SAG036	
144443	064848036010	SAG036	
144444	064848143010	SAG143	
144446	064848159010	SAG159	
144447	064848153010	SAG153	
144448	064848161010	SAG161	
144449	064848128010	SAG128	
144453	064848129010	SAG129	
144454	064848131010	SAG131	
144456	064848160010	SAG160	
144458	064848143010	SAG143	
144533	064848050010	SAG050	
144559	064848155010	SAG155	
145507	064848101010	SAG101	
145513	064848034010	SAG034	
145554	064848109010	SAG109	
146404	064848059010	SAG059	
147204	064848051010	SAG051	
147205	064848118010	SAG118	
147208	064848043010	SAG043	
147210	064848093010	SAG093	
147212	064848090010	SAG090	
147214	064848097010	SAG097	
147217	064848121010	SAG121	
147222	064848057010	SAG057	
CHEVROLET			
96253542	064848106010	SAG106	
96434780	064848106010	SAG106	
DACIA			
6001545512	064848161010	SAG161	
8200033686	064847110010	SAC010	
8200285798	064847110010	SAC010	
8200439315	064848161010	SAG161	

OE/IAM	MAGNETI MARELLI	
	LONG	SHORT
H1	SENSORE GIRI / FASE - ALBERO MOTORE CRANKSHAFT POSITION SENSOR	
DACIA		
8200643171	064848163010	SAG163
8200647554	064848159010	SAG159
8200647554	064848160010	SAG160
DAEWOO		
10456250	064848051010	SAG051
10456515	064848051010	SAG051
0031537228	064848146010	SAG146
0031537428	064848146010	SAG146
96183235	064848098010	SAG098
96253542	064848106010	SAG106
96418382	064848051010	SAG051
96434780	064848106010	SAG106
DELPHI		
SS10133	064848083010	SAG083
SS10152	064848105010	SAG105
SS1020511B1	064848144010	SAG144
SS10513	064848020010	SAG020
SS1071212B1	064848051010	SAG051
SS1072512B1	064848133010	SAG133
SS1072812B1	064848025010	SAG025
SS1073212B1	064848150010	SAG150
SS1073312B1	064848150010	SAG150
SS1073612B1	064848150010	SAG150
SS1074312B1	064848157010	SAG157
SS1074412B1	064848126010	SAG126
SS10746	064848168010	SAG168
SS1074612B1	064848168010	SAG168
SS1074712B1	064848164010	SAG164
SS1074812B1	064848130010	SAG130
SS1075212B1	064848153010	SAG153
SS1075612B1	064848095010	SAG095
SS1075712B1	064848158010	SAG158
SS1075812B1	064848036010	SAG036
SS1075912B1	064848036010	SAG036
SS1078712B1	064848059010	SAG059
SS10802	064848163010	SAG163
SS10803	064848159010	SAG159
SS10804	064848141010	SAG141
SS10805	064848019010	SAG019
SS10806	064848124010	SAG124
SS10807	064848137010	SAG137
SS10808	064848116010	SAG116
SS10810	064848118010	SAG118

OE/IAM	MAGNETI MARELLI	
	LONG	SHORT
H1	SENSORE GIRI / FASE - ALBERO MOTORE CRANKSHAFT POSITION SENSOR	
DELPHI		
SS10822	064848156010	SAG156
SS10823	064848122010	SAG122
SS10824	064848120010	SAG120
SS10888	064848151010	SAG151
SS10889	064848143010	SAG143
SS10891	064848090010	SAG090
SS10892	064848061010	SAG061
SS10893	064848111010	SAG111
SS10894	064848106010	SAG106
SS10895	064848098010	SAG098
SS10896	064848037010	SAG037
SS10897	064848048010	SAG048
SS10898	064848055010	SAG055
SS10904	064848115010	SAG115
DENSO		
0296000630	064848046010	SAG046
ERA		
550000	064848133010	SAG133
550003	064848025010	SAG025
550004	064848150010	SAG150
550005	064848156010	SAG156
550006	064848150010	SAG150
550007	064848156010	SAG156
550011	064848157010	SAG157
550012	064848126010	SAG126
550015	064848164010	SAG164
550016	064848130010	SAG130
550020	064848153010	SAG153
550021	064848158010	SAG158
550022	064848036010	SAG036
550023	064848036010	SAG036
550047	064848028010	SAG028
550048	064848027010	SAG027
550050	064848141010	SAG141
550051	064848159010	SAG159
550052	064848020010	SAG020
550056	064820150010	SEN8M
550058	064848161010	SAG161
550061	064848019010	SAG019
550062	064848122010	SAG122
550063	064848060010	SAG060
550064	111040211103	CWM02/3
550065	064848105010	SAG105

OE/IAM		 LONG SHORT	
H1	SENSORE GIRI / FASE - ALBERO MOTORE CRANKSHAFT POSITION SENSOR		
ERA			
550066	064848129010	SAG129	
550067	111040211101	CWM02/1	
550068	064848093010	SAG093	
550069	111040211106	CWM02/6	
550070	064820171010	SEN8D3	
550071	064820083010	SEN8D	
550072	064848143010	SAG143	
550073	064848107010	SAG107	
550074	111040211105	CWM02/5	
550075	064848128010	SAG128	
550077	064848124010	SAG124	
550078	064848116010	SAG116	
550083	064848067010	SAG067	
550087	064848063010	SAG063	
550088	064848115010	SAG115	
550089	064820084010	SEN8E	
550090	064820088010	SEN8I	
550091	064820167010	SEN8K3	
550092	064820168010	SEN8I3	
550093	111040144501	SEN8U	
550095	111040211102	CWM02/2	
550096	111040211108	CWM02/8	
550099	064848026010	SAG026	
550101	064848134010	SAG134	
550108	064848118010	SAG118	
550109	064848018010	SAG018	
550112	064848097010	SAG097	
550114	064848150010	SAG150	
550124	064848096010	SAG096	
550126	064848117010	SAG117	
550129	064848137010	SAG137	
550134	064848121010	SAG121	
550155	064848051010	SAG051	
550166	064848024010	SAG024	
550168	064848135010	SAG135	
550170	064848098010	SAG098	
550171	064848106010	SAG106	
550172	064848043010	SAG043	
550179	064848095010	SAG095	
550180	064848095010	SAG095	
550182	064848059010	SAG059	
550192	064848021010	SAG021	
550197	064848120010	SAG120	

OE/IAM		 LONG SHORT	
H1	SENSORE GIRI / FASE - ALBERO MOTORE CRANKSHAFT POSITION SENSOR		
ERA			
550200	064848030010	SAG030	
550208	064848084010	SAG084	
550210	064848111010	SAG111	
550214	064848144010	SAG144	
550218	064848075010	SAG075	
550221	064848145010	SAG145	
550225	064848057010	SAG057	
550226	064848146010	SAG146	
550227	064848073010	SAG073	
550228	064848048010	SAG048	
550231	064848081010	SAG081	
550232	064848100010	SAG100	
550255	064848064010	SAG064	
550258	064848068010	SAG068	
550264	064848078010	SAG078	
550275	064848023010	SAG023	
550279	064848089010	SAG089	
550289	064848170010	SAG170	
550308	064848037010	SAG037	
550309	064848174010	SAG174	
550313	064848171010	SAG171	
550314	064848172010	SAG172	
550315	064848167010	SAG167	
550327	064848069010	SAG069	
550345	064848108010	SAG108	
550346	064848072010	SAG072	
550350	064848053010	SAG053	
550352	064848035010	SAG035	
550354	064848088010	SAG088	
550361	064848090010	SAG090	
550370	810001989801	CVM03/1	
550371	064847105010	SAC005	
550372	064848017010	SAG017	
550377	064848140010	SAG140	
550388	064848132010	SAG132	
550404	064848054010	SAG054	
550408	064848094010	SAG094	
550417	064848034010	SAG034	
550438	064848101010	SAG101	
550441	064848136010	SAG136	
550442	064848123010	SAG123	
550451	064848059010	SAG059	
550452	064848138010	SAG138	

OE/IAM		 LONG SHORT	
H1	SENSORE GIRI / FASE - ALBERO MOTORE CRANKSHAFT POSITION SENSOR		
ERA			
550453	064848087010	SAG087	
550456	064848151010	SAG151	
550457	064848099010	SAG099	
550458	064848033010	SAG033	
550467	064848163010	SAG163	
550472	064848169010	SAG169	
550479	064848155010	SAG155	
550483	064848050010	SAG050	
550504	064848127010	SAG127	
550506	064848151010	SAG151	
550537	064848160010	SAG160	
550541	064848046010	SAG046	
550571	064848083010	SAG083	
550578	064848074010	SAG074	
550616	064848103010	SAG103	
550625	064848114010	SAG114	
550628	064848080010	SAG080	
550629	064848082010	SAG082	
550641	064848109010	SAG109	
550670	064848038010	SAG038	
550671	064848049010	SAG049	
550672	064848102010	SAG102	
550673	064848056010	SAG056	
550694	064848071010	SAG071	
550696	064848047010	SAG047	
550699	064848058010	SAG058	
550705	064848055010	SAG055	
550720	064848066010	SAG066	
550800	064848112010	SAG112	
550803	064848041010	SAG041	
550014B	064848168010	SAG168	
550014HQ	064848168010	SAG168	
550021B	064848158010	SAG158	
550047B	064848028010	SAG028	
550051HQ	064848159010	SAG159	
550058B	064848161010	SAG161	
550061B	064848019010	SAG019	
550063B	064848060010	SAG060	
550065B	064848105010	SAG105	
550066B	064848129010	SAG129	
550068B	064848093010	SAG093	
550072B	064848143010	SAG143	
550073B	064848107010	SAG107	

OE/IAM		 LONG SHORT	
H1	SENSORE GIRI / FASE - ALBERO MOTORE CRANKSHAFT POSITION SENSOR		
ERA			
550077B	064848124010	SAG124	
550078B	064848116010	SAG116	
550088B	064848115010	SAG115	
550108B	064848118010	SAG118	
550112B	064848097010	SAG097	
550129B	064848137010	SAG137	
550134B	064848121010	SAG121	
550155B	064848051010	SAG051	
550168B	064848135010	SAG135	
550170B	064848098010	SAG098	
550171B	064848106010	SAG106	
550172B	064848043010	SAG043	
550180B	064848095010	SAG095	
550208B	064848084010	SAG084	
550210B	064848111010	SAG111	
550218B	064848075010	SAG075	
550225B	064848057010	SAG057	
550226B	064848146010	SAG146	
550227B	064848073010	SAG073	
550228B	064848048010	SAG048	
550231B	064848081010	SAG081	
550232B	064848100010	SAG100	
550255B	064848064010	SAG064	
550264B	064848078010	SAG078	
550289B	064848170010	SAG170	
550308B	064848037010	SAG037	
550309B	064848174010	SAG174	
550309HQ	064848174010	SAG174	
550311B	064848176010	SAG176	
550311HQ	064848176010	SAG176	
550312B	064848177010	SAG177	
550312HQ	064848177010	SAG177	
550324B	064848178010	SAG178	
550324HQ	064848178010	SAG178	
550361B	064848090010	SAG090	
550377B	064848140010	SAG140	
550431B	064848175010	SAG175	
550431HQ	064848175010	SAG175	
550451B	064848059010	SAG059	
550452B	064848138010	SAG138	
550453B	064848076010	SAG076	
550456B	064848151010	SAG151	
550457B	064848099010	SAG099	

OE/IAM	 LONG SHORT	
--------	-------------------------------------	--

H1	SENSORE GIRI / FASE - ALBERO MOTORE CRANKSHAFT POSITION SENSOR	
----	---	--

ERA		
550458B	064848033010	SAG033
550471B	064848167010	SAG167
550471HQ	064848167010	SAG167
550504B	064848127010	SAG127
550537B	064848160010	SAG160
550541B	064848046010	SAG046
550571B	064848083010	SAG083
550578B	064848074010	SAG074
550616B	064848103010	SAG103
559155B	064848051010	SAG051

FACET		
--------------	--	--

90001	064820084010	SEN8E
90002	064820088010	SEN8I
90003	064820150010	SEN8M
90005	064820083010	SEN8D
90009	064848059010	SAG059
90010	064848095010	SAG095
90016	064848158010	SAG158
90019	064848128010	SAG128
90021	064848150010	SAG150
90023	064848036010	SAG036
90028	064848026010	SAG026
90035	064848004010	SAG004
90036	064848005010	SAG005
90037	064848006010	SAG006
90044	064848150010	SAG150
90046	064848067010	SAG067
90049	064848062010	SAG062
90053	111040211103	CWM02/3
90054	064848032010	SAG032
90058	064848045010	SAG045
90064	064848073010	SAG073
90068	064848142010	SAG142
90073	064848093010	SAG093
90075	064848076010	SAG076
90082	064848118010	SAG118
90087	064848099010	SAG099
90088	064848040010	SAG040
90094	111040144501	SEN8U
90127	064848156010	SAG156
90130	064848087010	SAG087
90132	064848122010	SAG122
90134	064848029010	SAG029

OE/IAM	 LONG SHORT	
--------	-------------------------------------	--

H1	SENSORE GIRI / FASE - ALBERO MOTORE CRANKSHAFT POSITION SENSOR	
----	---	--

FACET		
--------------	--	--

90140	064848066010	SAG066
90142	064848084010	SAG084
90149	064848141010	SAG141
90156	064848048010	SAG048
90157	111040211101	CWM02/1
90158	064848104010	SAG104
90160	064848021010	SAG021
90160	064848021011	SAG021-1
90162	064848124010	SAG124
90165	064848085010	SAG085
90168	064848043010	SAG043
90172	064848018010	SAG018
90173	064848121010	SAG121
90175	111040211106	CWM02/6
90180	064848081010	SAG081
90182	064848071010	SAG071
90187	064848105010	SAG105
90188	064848007010	SAG007
90194	064848129010	SAG129
90197	064848143010	SAG143
90198	064848114010	SAG114
90199	064848161010	SAG161
90205	064848096010	SAG096
90206	064848097010	SAG097
90207	064848017010	SAG017
90212	064848047010	SAG047
90214	064848038010	SAG038
90219	064848138010	SAG138
90228	064848051010	SAG051
90230	064848055010	SAG055
90235	064848019010	SAG019
90235	064848019010	SAG019
90236	064848116010	SAG116
90237	064848060010	SAG060
90238	064848137010	SAG137
90250	064848030010	SAG030
90254	064848100010	SAG100
90259	064848134010	SAG134
90260	064848157010	SAG157
90265	111040211102	CWM02/2
90267	064848049010	SAG049
90271	064848106010	SAG106
90272	064848098010	SAG098

OE/IAM	MAGNETI MARELLI	
	LONG	SHORT
H1	SENSORE GIRI / FASE - ALBERO MOTORE CRANKSHAFT POSITION SENSOR	
FACET		
90273	064848064010	SAG064
90279	064848135010	SAG135
90280	064848003010	SAG003
90283	064848031010	SAG031
90285	111040211108	CWM02/8
90287	064848065010	SAG065
90292	064848083010	SAG083
90294	064848077010	SAG077
90296	064848057010	SAG057
90297	064848127010	SAG127
90298	064848164010	SAG164
90299	064848130010	SAG130
90301	064848089010	SAG089
90304	064848008010	SAG008
90305	064848126010	SAG126
90307	064848002010	SAG002
90308	064847108010	SAC008
90309	064847107010	SAC007
90314	064848107010	SAG107
90321	064847106010	SAC006
90322	064847109010	SAC009
90323	064848001010	SAG001
90324	064848131010	SAG131
90326	064848174010	SAG174
90327	064848120010	SAG120
90337	064848117010	SAG117
90348	064847110010	SAC010
90349	064848153010	SAG153
90353	064848052010	SAG052
90373	064848086010	SAG086
90378	810001989801	CVM03/1
90381	111040211105	CWM02/5
90382	064848058010	SAG058
90383	064848056010	SAG056
90384	064848039010	SAG039
90389	064848102010	SAG102
90398	064848090010	SAG090
90407	064848025010	SAG025
90439	064848069010	SAG069
90440	064848133010	SAG133
90446	064848145010	SAG145
90447	064848132010	SAG132
90458	064848168010	SAG168

OE/IAM	MAGNETI MARELLI	
	LONG	SHORT
H1	SENSORE GIRI / FASE - ALBERO MOTORE CRANKSHAFT POSITION SENSOR	
FACET		
90461	064848152010	SAG152
90464	064848166010	SAG166
90472	064848144010	SAG144
90478	064848136010	SAG136
90481	064848170010	SAG170
90482	064848146010	SAG146
90485	064848073010	SAG073
90494	064848068010	SAG068
90498	064848171010	SAG171
90509	064848092010	SAG092
90524	064848169010	SAG169
90539	111001178501	CVS02
90540	064848163010	SAG163
90543	064848160010	SAG160
90545	064848103010	SAG103
90559	064848041010	SAG041
90598	064848155010	SAG155
90602	064848167010	SAG167
90620	064848078010	SAG078
90637	064848046010	SAG046
90543K	064848159010	SAG159
90545K	064848143010	SAG143
FAE		
79004	064848059010	SAG059
79008	064848026010	SAG026
79010	064848127010	SAG127
79019	064848085010	SAG085
79021	064848036010	SAG036
79022	064848128010	SAG128
79024	064848158010	SAG158
79026	064848095010	SAG095
79027	064848143010	SAG143
79028	064848159010	SAG159
79030	064848129010	SAG129
79031	064848161010	SAG161
79032	064848114010	SAG114
79033	064848150010	SAG150
79034	064848156010	SAG156
79036	064848062010	SAG062
79038	064848087010	SAG087
79039	064848073010	SAG073
79043	064848093010	SAG093
79045	064848051010	SAG051

OE/IAM		 LONG SHORT	
H1	SENSORE GIRI / FASE - ALBERO MOTORE CRANKSHAFT POSITION SENSOR		
FAE			
79046	064848081010	SAG081	
79047	064848135010	SAG135	
79049	064848105010	SAG105	
79050	064848100010	SAG100	
79053	064848067010	SAG067	
79054	064848048010	SAG048	
79055	064848096010	SAG096	
79057	064848076010	SAG076	
79065	064848142010	SAG142	
79066	064848138010	SAG138	
79068	064848174010	SAG174	
79069	064848116010	SAG116	
79071	064848060010	SAG060	
79073	064848121010	SAG121	
79075	064848137010	SAG137	
79078	064848124010	SAG124	
79084	064848084010	SAG084	
79093	064848019010	SAG019	
79097	064848071010	SAG071	
79103	064848118010	SAG118	
79113	064848107010	SAG107	
79115	064848134010	SAG134	
79116	064848157010	SAG157	
79118	064848164010	SAG164	
79119	064848130010	SAG130	
79122	064848086010	SAG086	
79130	064848077010	SAG077	
79135	064848126010	SAG126	
79139	064848117010	SAG117	
79144	064848036010	SAG036	
79148	064848168010	SAG168	
79154	064848150010	SAG150	
79159	064848153010	SAG153	
79163	064848131010	SAG131	
79170	064848133010	SAG133	
79173	064848025010	SAG025	
79174	064848155010	SAG155	
79182	064848120010	SAG120	
79188	064848146010	SAG146	
79198	064848065010	SAG065	
79200	064848102010	SAG102	
79205	064848083010	SAG083	
79208	064848045010	SAG045	

OE/IAM		 LONG SHORT	
H1	SENSORE GIRI / FASE - ALBERO MOTORE CRANKSHAFT POSITION SENSOR		
FAE			
79214	064848103010	SAG103	
79217	064848160010	SAG160	
79218	064848098010	SAG098	
79220	064848097010	SAG097	
79222	064848058010	SAG058	
79224	064848152010	SAG152	
79225	064848136010	SAG136	
79226	064848151010	SAG151	
79230	064848091010	SAG091	
79244	064848032010	SAG032	
79288	064848167010	SAG167	
79289	064848169010	SAG169	
79297	064848043010	SAG043	
79300	064848172010	SAG172	
79302	064848041010	SAG041	
79304	064848115010	SAG115	
79311	064848056010	SAG056	
79313	064848092010	SAG092	
79314	064848046010	SAG046	
79319	064848161010	SAG161	
79321	064848159010	SAG159	
79339	064848057010	SAG057	
79340	064848170010	SAG170	
79344	064848101010	SAG101	
79346	064848082010	SAG082	
79347	064848080010	SAG080	
79370	064848109010	SAG109	
FCA			
130975	064848066010	SAG066	
4460206	064820083010	SEN8D	
05944390	064820084010	SEN8E	
7547235	064820088010	SEN8I	
7564592	064820150010	SEN8M	
07588435	064820084010	SEN8E	
07589729	064820171010	SEN8D3	
07604582	064820084010	SEN8E	
7616269	064848066010	SAG066	
07646975	064820084010	SEN8E	
7656271	111040144501	SEN8U	
07733001	064820168010	SEN8I3	
07735697	064820171010	SEN8D3	
7756924	064848076010	SAG076	
7766251	064848121010	SAG121	

OE/IAM	MAGNETI MARELLI	
	LONG	SHORT
H1	SENSORE GIRI / FASE - ALBERO MOTORE CRANKSHAFT POSITION SENSOR	
FCA		
7766252	064848067010	SAG067
7766282	064848067010	SAG067
07769111	064820084010	SEN8E
7788905	064848071010	SAG071
7790917	064848043010	SAG043
7799032	064848076010	SAG076
9944264	064848026010	SAG026
46411427	064848048010	SAG048
46412341	064820088010	SEN8I
46442091	111040211101	CWM02/1
46469866	064848122010	SAG122
46470477	064848122010	SAG122
46472687	064848122010	SAG122
46474583	064848097010	SAG097
46477973	064848030010	SAG030
46479975	111040211101	CWM02/1
46538536	111040211102	CWM02/2
46754538	064848097010	SAG097
46754539	064848097010	SAG097
46764212	111040211106	CWM02/6
46774532	111040211103	CWM02/3
46778331	111040211105	CWM02/5
46798345	064848133010	SAG133
46798363	064848102010	SAG102
46802751	111040211108	CWM02/8
46808734	064848039010	SAG039
55187380	810001989801	CVM03/1
55189513	111040211106	CWM02/6
55189518	111040211108	CWM02/8
55206561	064848080010	SAG080
55216242	064848080010	SAG080
55222989	064848082010	SAG082
56027865	064848044010	SAG044
56027866	064848044010	SAG044
56027867	064848044010	SAG044
60512971	064820084010	SEN8E
60569060	064848029010	SAG029
60573739	064848040010	SAG040
60662826	064848039010	SAG039
60808895	111040144501	SEN8U
60808904	064848029010	SAG029
60808986	064848040010	SAG040
60810103	064820168010	SEN8I3

OE/IAM	MAGNETI MARELLI	
	LONG	SHORT
H1	SENSORE GIRI / FASE - ALBERO MOTORE CRANKSHAFT POSITION SENSOR	
FCA		
60814589	064848122010	SAG122
60816746	064848039010	SAG039
71739267	064848083010	SAG083
73502752	064848025010	SAG025
77662510	064848121010	SAG121
77662520	064848067010	SAG067
470069400	064820083010	SEN8D
500343018	064848089010	SAG089
500374763	064848058010	SAG058
504129943	064848110010	SAG110
9606816880	064848150010	SAG150
9622209880	064848150010	SAG150
9632400580	064848157010	SAG157
9635080680	064848028010	SAG028
9635080680	064848027010	SAG027
9637465980	064848164010	SAG164
9637469580	064848164010	SAG164
9643695780	064848169010	SAG169
195271101900	064820084010	SEN8E
56027865AB	064848044010	SAG044
56027865AC	064848044010	SAG044
56027867AB	064848044010	SAG044
56041819AA	064848044010	SAG044
56041820AA	064848044010	SAG044
FEBI BILSTEIN		
18163	064848107010	SAG107
22891	064848163010	SAG163
23799	064848151010	SAG151
23931	064848061010	SAG061
24616	064848019010	SAG019
26335	064848157010	SAG157
27175	064848141010	SAG141
27321	064848087010	SAG087
28119	064848025010	SAG025
31190	064848167010	SAG167
31198	064848168010	SAG168
31200	064848169010	SAG169
31241	064848164010	SAG164
31244	064848126010	SAG126
34302	064848108010	SAG108

OE/IAM	MAGNETI MARELLI	
	LONG	SHORT
H1	SENSORE GIRI / FASE - ALBERO MOTORE CRANKSHAFT POSITION SENSOR	
FORD		
1006990	064848026010	SAG026
1026696	064848034010	SAG034
1048905	064848171010	SAG171
1051046	064848142010	SAG142
1057051	064848171010	SAG171
1062545	064848170010	SAG170
1066382	064848171010	SAG171
1066383	064848170010	SAG170
1079388	064848170010	SAG170
1085854	064848170010	SAG170
1087548	064848170010	SAG170
1094772	064848026010	SAG026
1110834	064848008010	SAG008
1120193	064848065010	SAG065
1136248	064848171010	SAG171
1143723	064848002010	SAG002
1143943	064848176010	SAG176
1148073	064848168010	SAG168
1197901	064848179010	SAG179
1206797	064847105010	SAC005
1231609	064848175010	SAG175
1231925	064848169010	SAG169
1385381	064848001010	SAG001
1517990	064848167010	SAG167
1535716	810001989801	CVM03/1
1564811	810001989801	CVM03/1
1828951	064848109010	SAG109
3023785	064847106010	SAC006
3043996	064847108010	SAC008
3043998	064847109010	SAC009
3702615	064848176010	SAG176
4383679	064847107010	SAC007
4383693	064847107010	SAC007
4429622	064847107010	SAC007
4533778	064848172010	SAG172
4583104	064848172010	SAG172
4617387	064847109010	SAC009
4617388	064847108010	SAC008
4621599	064848003010	SAG003
4628032	064847106010	SAC006
4882780	064847109010	SAC009
4900624	064847108010	SAC008
6191991	064848177010	SAG177

OE/IAM	MAGNETI MARELLI	
	LONG	SHORT
H1	SENSORE GIRI / FASE - ALBERO MOTORE CRANKSHAFT POSITION SENSOR	
FORD		
6193226	064848177010	SAG177
6740816	064848006010	SAG006
6859701	064848004010	SAG004
6859702	064848005010	SAG005
6859704	064848101010	SAG101
7009578	064848007010	SAG007
7072657	064848047010	SAG047
7079284	064848177010	SAG177
7126713	064848177010	SAG177
7151110	064848177010	SAG177
7151111	064848177010	SAG177
7151113	064848177010	SAG177
1M5A6C315AE	064848001010	SAG001
1S7P7M101KA	064847107010	SAC007
2S6Q9E731AA	064848168010	SAG168
2S6T9E731AA	064848172010	SAG172
2S6T9E731AB	064848172010	SAG172
2S717H103AA	064847105010	SAC005
2S7Q6C315AC	064848002010	SAG002
3M5Q9E731AA	064848169010	SAG169
3S5T9E731AA	064848175010	SAG175
5L8E6C315AB	064848003010	SAG003
5S4P7H103AA	064847109010	SAC009
5S4P7M101AA	064847108010	SAC008
6L8P7H103AA	064847106010	SAC006
88WF6C315AD	064848004010	SAG004
89BF6C315AC	064848005010	SAG005
8S4P7H103AA	064847109010	SAC009
8S4P7M101AA	064847108010	SAC008
8S6Q9E731AA	064848167010	SAG167
90BB9E731CA	064848177010	SAG177
90BB9E731CB	064848177010	SAG177
90BB9E731CC	064848177010	SAG177
90BB9E731CD	064848177010	SAG177
948F6C315AA	064848006010	SAG006
94BB9E731AA	064848177010	SAG177
94BB9E731BA	064848177010	SAG177
94BB9E731DA	064848177010	SAG177
95BB9E731BA	064848176010	SAG176
95BB9E731BB	064848176010	SAG176
95VW6C315CA	064848142010	SAG142
95VW7F293AA	064848026010	SAG026
95VW7F293AB	064848026010	SAG026

OE/IAM		 LONG SHORT	
H1	SENSORE GIRI / FASE - ALBERO MOTORE CRANKSHAFT POSITION SENSOR		
FORD			
95VW7F923AA	064848026010	SAG026	
95VW7F923AB	064848026010	SAG026	
95WF6C315AA	064848007010	SAG007	
97BB9E731AB	064848171010	SAG171	
97BB9E731AC	064848171010	SAG171	
97BB9E731AD	064848171010	SAG171	
97BB9E731AE	064848171010	SAG171	
97GT7H103BB	064848034010	SAG034	
98AB9E731AC	064848170010	SAG170	
98AB9E731AD	064848170010	SAG170	
98AB9E731AE	064848170010	SAG170	
98AB9E731AF	064848170010	SAG170	
98AB9E731AG	064848170010	SAG170	
9S519E731BA	810001989801	CVM03/1	
BM516C315BA	064848109010	SAG109	
BM516C315BB	064848109010	SAG109	
F7RP7M101KB	064847107010	SAC007	
F8RP7H103AA	064847106010	SAC006	
FW8421550	064847107010	SAC007	
FW8421550Z01	064847107010	SAC007	
V94DD6C315AA	064848047010	SAG047	
XS4P7H103AB	064847109010	SAC009	
XS4P7M101AB	064847108010	SAC008	
XS7P7M101AB	064847107010	SAC007	
YM2112A545AA	064848065010	SAG065	
YS6A6C315AB	064848008010	SAG008	
Z053D1Y155	064847108010	SAC008	
GENERAL MOTORS			
9110560	064848159010	SAG159	
9115115	064848120010	SAG120	
9118150	064848060010	SAG060	
9118368	064848019010	SAG019	
9177221	064848078010	SAG078	
9201843	064848153010	SAG153	
10456250	064848051010	SAG051	
10456515	064848051010	SAG051	
10456604	064848020010	SAG020	
12567712	064848083010	SAG083	
12855457	064848025010	SAG025	
24576398	064848083010	SAG083	
0031537228	064848146010	SAG146	
0031537428	064848146010	SAG146	
55557326	064848078010	SAG078	

OE/IAM		 LONG SHORT	
H1	SENSORE GIRI / FASE - ALBERO MOTORE CRANKSHAFT POSITION SENSOR		
GENERAL MOTORS			
90213515	064848093010	SAG093	
90451441	064848093010	SAG093	
90483739	064848124010	SAG124	
90492006	064848055010	SAG055	
90506103	064848107010	SAG107	
90520854	064848137010	SAG137	
90520856	064848116010	SAG116	
90532619	064848019010	SAG019	
90540188	064848021010	SAG021	
90540188	064848021011	SAG021-1	
90589767	064848060010	SAG060	
91153898	064848047010	SAG047	
91746421	064848107010	SAG107	
93161272	064848153010	SAG153	
93178045	064848025010	SAG025	
93179391	064848133010	SAG133	
93179803	064847110010	SAC010	
93179850	064848069010	SAG069	
93193372	064848025010	SAG025	
93243251	064848057010	SAG057	
95507625	064847110010	SAC010	
96183235	064848098010	SAG098	
96253542	064848106010	SAG106	
96418382	064848051010	SAG051	
96434780	064848106010	SAG106	
97180388	064848117010	SAG117	
HELLA			
009110491	064848024010	SAG024	
009110491	064848024011	SAG024-1	
009110501	064848023010	SAG023	
009110501	064848023011	SAG023-1	
009121221	064848019010	SAG019	
009146211	064848021010	SAG021	
009146211	064848021011	SAG021-1	
009146251	064848018010	SAG018	
009146341	064848017010	SAG017	
009146611	064847110010	SAC010	
009163031	064848020010	SAG020	
6PU009110001	064848111010	SAG111	
6PU009110111	064848158010	SAG158	
6PU009110141	064848095010	SAG095	
6PU009110151	064848036010	SAG036	
6PU009110171	064848036010	SAG036	

OE/IAM	MAGNETI MARELLI	
	LONG	SHORT
H1	SENSORE GIRI / FASE - ALBERO MOTORE CRANKSHAFT POSITION SENSOR	
HELLA		
6PU009110201	064848093010	SAG093
6PU009110221	064848124010	SAG124
6PU009110241	064848150010	SAG150
6PU009110251	064848150010	SAG150
6PU009110261	064848084010	SAG084
6PU009110271	064848107010	SAG107
6PU009110277	064848107010	SAG107
6PU009110281	064848118010	SAG118
6PU009110341	064848128010	SAG128
6PU009110421	064848144010	SAG144
6PU009110481	064848146010	SAG146
6PU009110491	064848024010	SAG024
6PU009110491	064848024011	SAG024-1
6PU009110501	064848023010	SAG023
6PU009110501	064848023011	SAG023-1
6PU009110511	064848073010	SAG073
6PU009110521	064848073010	SAG073
6PU009110541	064848087010	SAG087
6PU009110551	064848062010	SAG062
6PU009110561	064848099010	SAG099
6PU009110591	064848104010	SAG104
6PU009110601	064848127010	SAG127
6PU009110611	064848142010	SAG142
6PU009110641	064848116010	SAG116
6PU009110681	064848137010	SAG137
6PU009110701	064848129010	SAG129
6PU009110711	064848159010	SAG159
6PU009110721	064848143010	SAG143
6PU009121051	064848115010	SAG115
6PU009121221	064848019010	SAG019
6PU009121241	064848142010	SAG142
6PU009121391	064848153010	SAG153
6PU009121601	064848118010	SAG118
6PU009121701	064848151010	SAG151
6PU009145011	064848026010	SAG026
6PU009146011	064848059010	SAG059
6PU009146021	064848158010	SAG158
6PU009146031	064848128010	SAG128
6PU009146051	064848150010	SAG150
6PU009146101	064848150010	SAG150
6PU009146111	064848141010	SAG141
6PU009146131	064848073010	SAG073
6PU009146151	064848093010	SAG093

OE/IAM	MAGNETI MARELLI	
	LONG	SHORT
H1	SENSORE GIRI / FASE - ALBERO MOTORE CRANKSHAFT POSITION SENSOR	
HELLA		
6PU009146181	064848156010	SAG156
6PU009146191	064848087010	SAG087
6PU009146211	064848021010	SAG021
6PU009146211	064848021011	SAG021-1
6PU009146231	064848085010	SAG085
6PU009146251	064848018010	SAG018
6PU009146261	064848121010	SAG121
6PU009146301	064848114010	SAG114
6PU009146311	064848161010	SAG161
6PU009146331	064848096010	SAG096
6PU009146341	064848017010	SAG017
6PU009146361	064848055010	SAG055
6PU009146381	064848065010	SAG065
6PU009146391	064848049010	SAG049
6PU009146401	064848105010	SAG105
6PU009146421	064848157010	SAG157
6PU009146531	064848090010	SAG090
6PU009146591	064848083010	SAG083
6PU009146611	064847110010	SAC010
6PU009146631	064848122010	SAG122
6PU009146741	064848169010	SAG169
6PU009163031	064848020010	SAG020
6PU009163131	064848138010	SAG138
6PU009163171	064820084010	SEN8E
6PU009163201	064848064010	SAG064
6PU009163281	064848077010	SAG077
6PU009163371	064848120010	SAG120
6PU009163381	064848061010	SAG061
6PU009163391	064848133010	SAG133
6PU009163401	064848025010	SAG025
6PU009163431	064848126010	SAG126
6PU009163451	064848168010	SAG168
6PU009163461	064848164010	SAG164
6PU009163581	064848059010	SAG059
6PU009163591	064848130010	SAG130
6PU009163651	064848163010	SAG163
6PU009163661	064848060010	SAG060
6PU009163701	064848095010	SAG095
6PU009163721	064848128010	SAG128
6PU009163741	064848036010	SAG036
6PU009163761	064848118010	SAG118
6PU009163771	064848084010	SAG084
6PU009163791	064848124010	SAG124

OE/IAM	MAGNETI MARELLI	
	LONG	SHORT
H1	SENSORE GIRI / FASE - ALBERO MOTORE CRANKSHAFT POSITION SENSOR	
HELLA		
6PU009163811	064848116010	SAG116
6PU009163821	064848137010	SAG137
6PU009163831	064848107010	SAG107
6PU009163851	064848160010	SAG160
6PU009163861	064848159010	SAG159
6PU009163871	064848103010	SAG103
6PU009163881	064848143010	SAG143
6PU009163901	064848129010	SAG129
6PU009163911	064848120010	SAG120
HERTH+BUSS ELPARTS		
70610001	064848128010	SAG128
70610002	064848124010	SAG124
70610005	064848143010	SAG143
70610019	064848036010	SAG036
70610031	064848126010	SAG126
70610032	064848157010	SAG157
70610035	064848025010	SAG025
70610038	064848036010	SAG036
70610049	064848130010	SAG130
70610053	064848137010	SAG137
70610101	064848144010	SAG144
70610300	064848115010	SAG115
70630019	064848151010	SAG151
HONDA		
78420P5TG00	064848081010	SAG081
HYUNDAI		
3918022030	064848105010	SAG105
3918022040	064848105010	SAG105
3918022050	064848105010	SAG105
3918022060	064848105010	SAG105
3918022090	064848105010	SAG105
3918022600	064848135010	SAG135
3918023000	064848105010	SAG105
3918026900	064848135010	SAG135
3918027000	064848094010	SAG094
3918037150	064848037010	SAG037
3918037200	064848037010	SAG037
3931002200	064848112010	SAG112
3931002600	064848074010	SAG074
391804A111	064848068010	SAG068

OE/IAM	MAGNETI MARELLI	
	LONG	SHORT
H1	SENSORE GIRI / FASE - ALBERO MOTORE CRANKSHAFT POSITION SENSOR	
INTERMOTOR		
17068	064848044010	SAG044
17083	064848074010	SAG074
18753	064848059010	SAG059
18756	064848095010	SAG095
18757	064848036010	SAG036
18758	064848150010	SAG150
18759	064848150010	SAG150
18764	064848093010	SAG093
18772	064848158010	SAG158
18775	064848128010	SAG128
18781	064848026010	SAG026
18792	064848040010	SAG040
18796	064848156010	SAG156
18802	064848062010	SAG062
18806	064848032010	SAG032
18810	064848045010	SAG045
18812	064848073010	SAG073
18816	064848099010	SAG099
18821	064848087010	SAG087
18824	064848091010	SAG091
18829	064848104010	SAG104
18830	064848121010	SAG121
18832	064848085010	SAG085
18834	064848067010	SAG067
18836	064848048010	SAG048
18841	064848043010	SAG043
18845	064848081010	SAG081
18847	064848071010	SAG071
18856	064848142010	SAG142
18860	064848118010	SAG118
18869	064848066010	SAG066
18872	064848124010	SAG124
18877	064848129010	SAG129
18878	064848143010	SAG143
18879	064848114010	SAG114
18880	064848161010	SAG161
18882	064848096010	SAG096
18883	064848097010	SAG097
18889	064848047010	SAG047
18891	064848038010	SAG038
18894	064848138010	SAG138
18902	064848051010	SAG051
18903	064848055010	SAG055

OE/IAM	MAGNETI MARELLI	
	LONG	SHORT
H1	SENSORE GIRI / FASE - ALBERO MOTORE CRANKSHAFT POSITION SENSOR	
INTERMOTOR		
18907	064848116010	SAG116
18908	064848060010	SAG060
18909	064848137010	SAG137
18918	064848100010	SAG100
18922	064848049010	SAG049
18924	064848106010	SAG106
18925	064848098010	SAG098
18926	064848064010	SAG064
18935	064848065010	SAG065
18938	064848135010	SAG135
18940	064848105010	SAG105
18942	064848019010	SAG019
18943	064848089010	SAG089
18949	064848057010	SAG057
18952	064848157010	SAG157
18954	064848126010	SAG126
18958	064848164010	SAG164
18959	064848130010	SAG130
18961	064848107010	SAG107
18965	064848159010	SAG159
18985	064848134010	SAG134
18989	064848127010	SAG127
18998	064848131010	SAG131
19002	064848117010	SAG117
19012	064848039010	SAG039
19013	064848102010	SAG102
19016	064848090010	SAG090
19019	064848025010	SAG025
19022	064848069010	SAG069
19023	064848133010	SAG133
19035	064848095010	SAG095
19036	064848153010	SAG153
19037	064848036010	SAG036
19038	064848083010	SAG083
19039	064848120010	SAG120
19088	064848103010	SAG103
19095	064848172010	SAG172
19096	064848169010	SAG169
19107	064848078010	SAG078
19125	064848144010	SAG144
19131	064848075010	SAG075
19137	064848092010	SAG092
19140	064848151010	SAG151

OE/IAM	MAGNETI MARELLI	
	LONG	SHORT
H1	SENSORE GIRI / FASE - ALBERO MOTORE CRANKSHAFT POSITION SENSOR	
INTERMOTOR		
19150	064848037010	SAG037
19168	064848111010	SAG111
19171	064848115010	SAG115
19219	064848054010	SAG054
19272	064848108010	SAG108
KIA		
3931002200	064848112010	SAG112
0K08A18891	064848067010	SAG067
0K08A18891A	064848067010	SAG067
0K2A618891	064848066010	SAG066
0K30E18131B	064848054010	SAG054
0K9A018891	064848067010	SAG067
0K9AA18891	064848067010	SAG067
391804A111	064848068010	SAG068
396004X300	064848041010	SAG041
LAND ROVER		
LR021649	064848109010	SAG109
NSC100110L	064848081010	SAG081
NSC100390L	064848091010	SAG091
NSC106100	064848144010	SAG144
LUCAS ELECTRICAL		
740940960	064848059010	SAG059
SEB1001	064848131010	SAG131
SEB1005	064848117010	SAG117
SEB1015	064848039010	SAG039
SEB1016	064848102010	SAG102
SEB1019	064848090010	SAG090
SEB1022	064848025010	SAG025
SEB1025	064848069010	SAG069
SEB1026	064848133010	SAG133
SEB1034	064848168010	SAG168
SEB1038	064848095010	SAG095
SEB1039	064848153010	SAG153
SEB1040	064848036010	SAG036
SEB1041	064848083010	SAG083
SEB1042	064848120010	SAG120
SEB1133	064848151010	SAG151
SEB1177	064848075010	SAG075
SEB1224	064848101010	SAG101
SEB1395	064848169010	SAG169
SEB1440	064848169010	SAG169
SEB149	064848059010	SAG059
SEB150	064848095010	SAG095

OE/IAM	MAGNETI MARELLI	
	LONG	SHORT
H1	SENSORE GIRI / FASE - ALBERO MOTORE CRANKSHAFT POSITION SENSOR	
LUCAS ELECTRICAL		
SEB151	064848158010	SAG158
SEB153	064848128010	SAG128
SEB155	064848150010	SAG150
SEB157	064848036010	SAG036
SEB161	064848026010	SAG026
SEB253	064848099010	SAG099
SEB255	064848087010	SAG087
SEB258	064848040010	SAG040
SEB259	064848062010	SAG062
SEB265	064848093010	SAG093
SEB266	064848073010	SAG073
SEB267	064848104010	SAG104
SEB268	064848085010	SAG085
SEB416	064848142010	SAG142
SEB422	064848156010	SAG156
SEB426	064848048010	SAG048
SEB429	064848124010	SAG124
SEB434	064848121010	SAG121
SEB436	064848081010	SAG081
SEB438	064848129010	SAG129
SEB440	064848143010	SAG143
SEB441	064848114010	SAG114
SEB442	064848161010	SAG161
SEB443	064848096010	SAG096
SEB444	064848097010	SAG097
SEB446	064848138010	SAG138
SEB450	064848116010	SAG116
SEB451	064848060010	SAG060
SEB452	064848137010	SAG137
SEB456	064848055010	SAG055
SEB471	064848067010	SAG067
SEB474	064848118010	SAG118
SEB480	064848071010	SAG071
SEB484	064848051010	SAG051
SEB485	064848019010	SAG019
SEB486	064848064010	SAG064
SEB487	064848106010	SAG106
SEB804	064848150010	SAG150
SEB819	064848032010	SAG032
SEB821	064848045010	SAG045
SEB830	064848043010	SAG043
SEB839	064848066010	SAG066
SEB842	064848047010	SAG047

OE/IAM	MAGNETI MARELLI	
	LONG	SHORT
H1	SENSORE GIRI / FASE - ALBERO MOTORE CRANKSHAFT POSITION SENSOR	
LUCAS ELECTRICAL		
SEB843	064848038010	SAG038
SEB866	064848100010	SAG100
SEB869	064848049010	SAG049
SEB871	064848106010	SAG106
SEB875	064848065010	SAG065
SEB876	064848135010	SAG135
SEB877	064848105010	SAG105
SEB878	064848089010	SAG089
SEB881	064848130010	SAG130
SEB966	064848098010	SAG098
SEB975	064848077010	SAG077
SEB976	064848057010	SAG057
SEB979	064848157010	SAG157
SEB980	064848126010	SAG126
SEB984	064848164010	SAG164
SEB986	064848084010	SAG084
SEB988	064848134010	SAG134
SEB992	064848127010	SAG127
MAGNETI MARELLI		
64820083	064820083010	SEN8D
64820084	064820084010	SEN8E
64820088	064820088010	SEN8I
64820150	064820150010	SEN8M
64820167	064820167010	SEN8K3
64820168	064820168010	SEN8I3
64820171	064820171010	SEN8D3
CVM03/1	810001989801	CVM03/1
CVS02	111001178501	CVS02
MAPCO		
82305	064848160010	SAG160
82307	064848143010	SAG143
MAZDA		
FSD718221B	064848108010	SAG108
RF5C18230	064848092010	SAG092
Y40118221	064848168010	SAG168
ZL0118221A	064848088010	SAG088
MEAT & DORIA		
87003	111040211106	CWM02/6
87004	064820083010	SEN8D
87005	064820084010	SEN8E
87006	064820088010	SEN8I
87009	064820150010	SEN8M
87013	111040144501	SEN8U

OE/IAM		 LONG SHORT	
H1	SENSORE GIRI / FASE - ALBERO MOTORE CRANKSHAFT POSITION SENSOR		
MEAT & DORIA			
87015	064848156010	SAG156	
87022	064848150010	SAG150	
87029	064848095010	SAG095	
87030	064848158010	SAG158	
87035	064848059010	SAG059	
87036	064848128010	SAG128	
87038	064848111010	SAG111	
87042	064848036010	SAG036	
87044	064848093010	SAG093	
87047	064848107010	SAG107	
87051	064848084010	SAG084	
87058	064848144010	SAG144	
87059	064848099010	SAG099	
87063	064848127010	SAG127	
87074	064820168010	SEN813	
87079	064848062010	SAG062	
87083	111040211103	CWM02/3	
87084	064848032010	SAG032	
87088	064848045010	SAG045	
87090	064848073010	SAG073	
87096	064848076010	SAG076	
87099	064848040010	SAG040	
87110	064848087010	SAG087	
87112	064848122010	SAG122	
87115	064848066010	SAG066	
87124	064848067010	SAG067	
87126	064848142010	SAG142	
87130	064848118010	SAG118	
87140	064848029010	SAG029	
87142	064848141010	SAG141	
87144	064848048010	SAG048	
87145	111040211101	CWM02/1	
87146	064848104010	SAG104	
87148	064848021010	SAG021	
87150	064848124010	SAG124	
87152	064848085010	SAG085	
87154	064848043010	SAG043	
87158	064848018010	SAG018	
87159	064848121010	SAG121	
87166	064848081010	SAG081	
87168	064848071010	SAG071	
87174	064848129010	SAG129	
87176	064848159010	SAG159	

OE/IAM		 LONG SHORT	
H1	SENSORE GIRI / FASE - ALBERO MOTORE CRANKSHAFT POSITION SENSOR		
MEAT & DORIA			
87177	064848143010	SAG143	
87178	064848114010	SAG114	
87179	064848161010	SAG161	
87181	064848096010	SAG096	
87182	064848097010	SAG097	
87183	064848017010	SAG017	
87188	064848047010	SAG047	
87190	064848038010	SAG038	
87194	064848138010	SAG138	
87203	064848055010	SAG055	
87206	064848019010	SAG019	
87207	064848116010	SAG116	
87208	064848060010	SAG060	
87209	064848137010	SAG137	
87222	064848105010	SAG105	
87225	064848051010	SAG051	
87230	064848134010	SAG134	
87231	064848157010	SAG157	
87233	064848106010	SAG106	
87234	064848098010	SAG098	
87235	064848064010	SAG064	
87239	064848135010	SAG135	
87241	111040211108	CWM02/8	
87242	064848020010	SAG020	
87244	064848077010	SAG077	
87245	064848164010	SAG164	
87250	064848126010	SAG126	
87251	064848052010	SAG052	
87263	064848024010	SAG024	
87265	064848023010	SAG023	
87267	064848146010	SAG146	
87271	064848078010	SAG078	
87275	064848145010	SAG145	
87280	064848117010	SAG117	
87285	064848130010	SAG130	
87286	111040211102	CWM02/2	
87287	064848026010	SAG026	
87288	064848100010	SAG100	
87293	064848168010	SAG168	
87301	064848049010	SAG049	
87303	064848065010	SAG065	
87304	064848089010	SAG089	
87309	064848091010	SAG091	

OE/IAM	MAGNETI MARELLI	
	LONG	SHORT
H1	SENSORE GIRI / FASE - ALBERO MOTORE CRANKSHAFT POSITION SENSOR	
MEAT & DORIA		
87314	064848083010	SAG083
87315	064848057010	SAG057
87317	064848030010	SAG030
87323	064848131010	SAG131
87324	064848120010	SAG120
87331	810001989801	CVM03/1
87333	111040211105	CWM02/5
87334	064848058010	SAG058
87335	064848039010	SAG039
87337	064848102010	SAG102
87339	064848090010	SAG090
87340	064848025010	SAG025
87344	064848133010	SAG133
87346	064848056010	SAG056
87384	064848086010	SAG086
87394	064848069010	SAG069
87397	064848068010	SAG068
87410	064848031010	SAG031
87424	064848075010	SAG075
87426	064848136010	SAG136
87430	064848163010	SAG163
87438	064848174010	SAG174
87439	064848152010	SAG152
87440	064848094010	SAG094
87441	064848110010	SAG110
87445	064848046010	SAG046
87448	064848092010	SAG092
87451	064848167010	SAG167
87453	064848155010	SAG155
87455	064848169010	SAG169
87466	064848041010	SAG041
87471	064848171010	SAG171
87473	064848170010	SAG170
87475	064848166010	SAG166
87483	111001178501	CVS02
87484	064848160010	SAG160
87485	064848103010	SAG103
87503	064848033010	SAG033
87506	064848074010	SAG074
87515	064848061010	SAG061
87524	064848063010	SAG063
87541	064848037010	SAG037
87542	064848172010	SAG172

OE/IAM	MAGNETI MARELLI	
	LONG	SHORT
H1	SENSORE GIRI / FASE - ALBERO MOTORE CRANKSHAFT POSITION SENSOR	
MEAT & DORIA		
87543	064848108010	SAG108
87544	064848072010	SAG072
87546	064848053010	SAG053
87548	064848035010	SAG035
87549	064848088010	SAG088
87551	064847105010	SAC005
87552	064848132010	SAG132
87555	064848050010	SAG050
87559	064848034010	SAG034
87561	064848123010	SAG123
87572	064848082010	SAG082
87575	064848101010	SAG101
87584	064848109010	SAG109
87592	064848044010	SAG044
87596	064848112010	SAG112
MERCEDES-BENZ		
0031532728	064848023010	SAG023
0031532728	064848023011	SAG023-1
0031532828	064848023010	SAG023
0031532828	064848023011	SAG023-1
0031537228	064848146010	SAG146
0031537428	064848146010	SAG146
0031539528	064848024010	SAG024
0031539528	064848024011	SAG024-1
0031539628	064848024010	SAG024
0031539628	064848024011	SAG024-1
A0031532728	064848023010	SAG023
A0031532728	064848023011	SAG023-1
A0031532828	064848023010	SAG023
A0031532828	064848023011	SAG023-1
A0031539528	064848024010	SAG024
A0031539528	064848024011	SAG024-1
A0031539628	064848024010	SAG024
A0031539628	064848024011	SAG024-1
METZGER		
0902002	064848099010	SAG099
0902003	064848144010	SAG144
0902004	064848111010	SAG111
0902011	064848019010	SAG019
0902013	064848158010	SAG158
0902014	064848036010	SAG036
0902016	064848159010	SAG159
0902018	064848090010	SAG090

OE/IAM	MAGNETI MARELLI	
	LONG	SHORT
H1	SENSORE GIRI / FASE - ALBERO MOTORE CRANKSHAFT POSITION SENSOR	
METZGER		
0902028	064848128010	SAG128
0902032	064848124010	SAG124
0902040	064848121010	SAG121
0902044	064848048010	SAG048
0902051	064848143010	SAG143
0902054	064848116010	SAG116
0902057	064848137010	SAG137
0902059	064848133010	SAG133
0902060	064848025010	SAG025
0902064	064848156010	SAG156
0902067	064848157010	SAG157
0902069	064848126010	SAG126
0902071	064848168010	SAG168
0902072	064848164010	SAG164
0902078	064848105010	SAG105
0902118	064848130010	SAG130
0902145	064848036010	SAG036
0902158	064848169010	SAG169
0902161	064848172010	SAG172
0902163	064848108010	SAG108
0902164	064848072010	SAG072
0902200	064848103010	SAG103
0902206	064848075010	SAG075
0902232	064848037010	SAG037
0902234	064848082010	SAG082
0902244	064848057010	SAG057
0903001	064848151010	SAG151
0903003	064848115010	SAG115
0903094	064848080010	SAG080
0909027	064848028010	SAG028
9092037	064848087010	SAG087
MEYLE		
3148990010	064848115010	SAG115
40148990000	064848028010	SAG028
MG		
NSC100110	064848081010	SAG081
NSC106100	064848144010	SAG144
MINI		
13627808449	064848167010	SAG167

OE/IAM	MAGNETI MARELLI	
	LONG	SHORT
H1	SENSORE GIRI / FASE - ALBERO MOTORE CRANKSHAFT POSITION SENSOR	
MITSUBISHI		
J5T20171	064848072010	SAG072
M883794	064848153010	SAG153
MD321888	064848036010	SAG036
MN980249	064848166010	SAG166
MN980339	064848166010	SAG166
MN980415	064848166010	SAG166
MN982334	064848167010	SAG167
MR560132	064848072010	SAG072
MR560276	064848035010	SAG035
NISSAN		
2263000QAG	064847110010	SAC010
23731BN700	064848161010	SAG161
23731BN701	064847110010	SAC010
23731BN70A	064848161010	SAG161
23731BN70B	064848161010	SAG161
23731DB000	064847110010	SAC010
23731DB00A	064847110010	SAC010
2375000Q0A	064848161010	SAG161
2375000Q0E	064848103010	SAG103
2375000Q0G	064848161010	SAG161
2375000QAD	064848161010	SAG161
2376000QAA	064848153010	SAG153
2376000QAB	064847110010	SAC010
2376000QAC	064848153010	SAG153
2376000QAD	064847110010	SAC010
23796AW300	064848153010	SAG153
2379800Q0B	064848163010	SAG163
259777F405	064848063010	SAG063
OPEL		
1238223	064848120010	SAG120
1238228	064848107010	SAG107
1238241	064848057010	SAG057
1238358	064848093010	SAG093
1238938	064848020010	SAG020
1247679	064848025010	SAG025
4402560	064848159010	SAG159
4413789	064848153010	SAG153
4506177	064848153010	SAG153
4708543	064848025010	SAG025
4808137	064848051010	SAG051
6235607	064848174010	SAG174
6235645	064848025010	SAG025
6235666	064848133010	SAG133

OE/IAM	MAGNETI MARELLI	
	LONG	SHORT
H1	SENSORE GIRI / FASE - ALBERO MOTORE CRANKSHAFT POSITION SENSOR	
OPEL		
6238050	064848069010	SAG069
6238095	064848019010	SAG019
6238098	064848137010	SAG137
6238101	064848060010	SAG060
6238109	064848019010	SAG019
6238118	064848051010	SAG051
6238153	064848117010	SAG117
6238158	064848083010	SAG083
6238186	064848083010	SAG083
6238313	064848093010	SAG093
6238325	064848141010	SAG141
6238333	064848055010	SAG055
6238377	064848107010	SAG107
6238393	064848124010	SAG124
6238395	064848021010	SAG021
6238395	064848021011	SAG021-1
6238423	064848047010	SAG047
6238459	064848116010	SAG116
9110560	064848159010	SAG159
9115115	064848120010	SAG120
9118150	064848060010	SAG060
9118368	064848019010	SAG019
9174621	064848107010	SAG107
9201843	064848153010	SAG153
10456250	064848051010	SAG051
10456515	064848051010	SAG051
10456604	064848020010	SAG020
12567712	064848083010	SAG083
55354601	064848069010	SAG069
90213515	064848093010	SAG093
90451441	064848093010	SAG093
90451442	064848141010	SAG141
90483739	064848124010	SAG124
90492006	064848055010	SAG055
90506103	064848107010	SAG107
90520854	064848137010	SAG137
90520856	064848116010	SAG116
90532619	064848019010	SAG019
90540188	064848021010	SAG021
90540188	064848021011	SAG021-1
90589767	064848060010	SAG060
93178045	064848025010	SAG025
93179391	064848133010	SAG133

OE/IAM	MAGNETI MARELLI	
	LONG	SHORT
H1	SENSORE GIRI / FASE - ALBERO MOTORE CRANKSHAFT POSITION SENSOR	
OPEL		
93179850	064848069010	SAG069
93193372	064848025010	SAG025
93243251	064848057010	SAG057
96418382	064848051010	SAG051
97180388	064848117010	SAG117
97226992	064848174010	SAG174
97378846	064848174010	SAG174
1238223J	064848120010	SAG120
PSA		
1920E2	064848150010	SAG150
591879	064848066010	SAG066
591881	064848150010	SAG150
591884	064848066010	SAG066
591887	064848150010	SAG150
591890	064848150010	SAG150
594009	111040211105	CWM02/5
616024	064848027010	SAG027
616070	064848028010	SAG028
91541075	064848150010	SAG150
96037097	064848150010	SAG150
96067317	064848150010	SAG150
96068168	064848150010	SAG150
96068172	064848150010	SAG150
96085170	064848156010	SAG156
96222098	064848150010	SAG150
96222624	064848156010	SAG156
96324005	064848157010	SAG157
96334757	064848126010	SAG126
96374659	064848164010	SAG164
96399998	064848164010	SAG164
96399999	064848130010	SAG130
9606731780	064848150010	SAG150
9606816880	064848150010	SAG150
9606817280	064848150010	SAG150
9608517080	064848156010	SAG156
9622209880	064848150010	SAG150
9622262480	064848156010	SAG156
9623111980	064848028010	SAG028
9632400580	064848157010	SAG157
9633475780	064848126010	SAG126
9635057280	064848028010	SAG028
9635080680	064848028010	SAG028
9637220880	064848168010	SAG168

OE/IAM	MAGNETI MARELLI	
	LONG	SHORT

H1	SENSORE GIRI / FASE - ALBERO MOTORE CRANKSHAFT POSITION SENSOR	
----	---	--

PSA		
9637465980	064848164010	SAG164
9637466080	064848130010	SAG130
9639999880	064848164010	SAG164
9639999980	064848130010	SAG130
9664387380	064848167010	SAG167
9664893880	064848169010	SAG169
19204A	064848156010	SAG156
19207N	064848157010	SAG157
19207P	064848126010	SAG126
1920AV	064848130010	SAG130
1920AW	064848164010	SAG164
1920C3	064848150010	SAG150
1920CP	064848089010	SAG089
1920EH	064848168010	SAG168
1920F5	064848150010	SAG150
1920GJ	064848169010	SAG169
1920HW	064848152010	SAG152
1920J5	064848156010	SAG156
1920PW	064848167010	SAG167
1920SQ	064848025010	SAG025
1920W9	064848150010	SAG150
1920Y9	064848048010	SAG048
1920Z3	064848156010	SAG156

RENAULT		
---------	--	--

6001545512	064848161010	SAG161
7700100566	064848161010	SAG161
7700100650	064848114010	SAG114
7700101970	064848159010	SAG159
7700101971	064848129010	SAG129
7700103069	064848159010	SAG159
7700103486	064848153010	SAG153
7700108073	064848143010	SAG143
7700108081	064848143010	SAG143
7700109055	064848161010	SAG161
7700273419	064848129010	SAG129
7700300992	064848131010	SAG131
7700418919	064848140010	SAG140
7700720341	064848095010	SAG095
7700725811	064848095010	SAG095
7700728637	064848158010	SAG158
7700728639	064848095010	SAG095
7700732300	064848095010	SAG095
7700739787	064848095010	SAG095

OE/IAM	MAGNETI MARELLI	
	LONG	SHORT

H1	SENSORE GIRI / FASE - ALBERO MOTORE CRANKSHAFT POSITION SENSOR	
----	---	--

RENAULT		
---------	--	--

7700739792	064848095010	SAG095
7700739794	064848158010	SAG158
7700747549	064848128010	SAG128
7700748442	064848158010	SAG158
7700850589	064848128010	SAG128
7701058077	064847110010	SAC010
8200012097	111001178501	CVS02
8200033686	064847110010	SAC010
8200038472	064848153010	SAG153
8200285798	064847110010	SAC010
8200370572	064848153010	SAG153
8200439315	064848161010	SAG161
8200468645	064848159010	SAG159
8200468646	064848129010	SAG129
8200468647	064848143010	SAG143
8200643171	064848163010	SAG163
8200647554	064848160010	SAG160
8200647556	064848103010	SAG103
8200688406	064848161010	SAG161
9622209880	064848150010	SAG150
9623111980	064848027010	SAG027
9635057280	064848028010	SAG028
319359125R	111001178501	CVS02
7700103069A	064848159010	SAG159
7700273419A	064848129010	SAG129
8200370572D	064848153010	SAG153

ROVER		
-------	--	--

ERR6119	064848091010	SAG091
ERR6357	064848091010	SAG091
NSC100110	064848081010	SAG081
NSC100110L	064848081010	SAG081
NSC100390	064848091010	SAG091
NSC100760	064848091010	SAG091
NSC100760SLP	064848091010	SAG091
NSC106100	064848144010	SAG144

SAAB		
------	--	--

4227203	064848093010	SAG093
4772232	064848021010	SAG021
4772232	064848021011	SAG021-1
9177221	064848078010	SAG078
9185232	064848031010	SAG031
9544560	064848021010	SAG021
9544560	064848021011	SAG021-1

OE/IAM	MAGNETI MARELLI	
	LONG	SHORT
H1	SENSORE GIRI / FASE - ALBERO MOTORE CRANKSHAFT POSITION SENSOR	
SAAB		
30561772	064848078010	SAG078
55557326	064848078010	SAG078
90464741	064848021010	SAG021
90464741	064848021011	SAG021-1
90490496	064848031010	SAG031
90540188	064848021010	SAG021
90540188	064848021011	SAG021-1
93179391	064848133010	SAG133
SIDAT		
83001	064848026010	SAG026
83003	064848134010	SAG134
83010	064848118010	SAG118
83011	064848018010	SAG018
83014	064848097010	SAG097
83024	064848096010	SAG096
83025	064848117010	SAG117
83027	064848137010	SAG137
83030	064848051010	SAG051
83031	064848133010	SAG133
83032	064848025010	SAG025
83033	064848150010	SAG150
83034	064848156010	SAG156
83039	064848157010	SAG157
83040	064848126010	SAG126
83042	064848164010	SAG164
83043	064848130010	SAG130
83045	064848158010	SAG158
83054	064848141010	SAG141
83055	064848159010	SAG159
83056	064848020010	SAG020
83058	064820150010	SEN8M
83059	064848161010	SAG161
83060	064848019010	SAG019
83061	064848122010	SAG122
83062	064848060010	SAG060
83063	111040211103	CWM02/3
83064	064848105010	SAG105
83066	064848024010	SAG024
83068	064848135010	SAG135
83069	064848098010	SAG098
83070	064848106010	SAG106
83076	064848095010	SAG095
83078	064848059010	SAG059

OE/IAM	MAGNETI MARELLI	
	LONG	SHORT
H1	SENSORE GIRI / FASE - ALBERO MOTORE CRANKSHAFT POSITION SENSOR	
SIDAT		
83084	064848021010	SAG021
83086	064848076010	SAG076
83087	064848120010	SAG120
83088	064848030010	SAG030
83089	064848084010	SAG084
83090	064848111010	SAG111
83091	064848144010	SAG144
83092	064848075010	SAG075
83093	064848057010	SAG057
83094	064848146010	SAG146
83095	064848073010	SAG073
83096	064848048010	SAG048
83098	064848081010	SAG081
83099	064848100010	SAG100
83105	064848129010	SAG129
83106	111040211101	CWM02/1
83107	064848093010	SAG093
83108	111040211106	CWM02/6
83110	064820083010	SEN8D
83111	064848143010	SAG143
83112	064848107010	SAG107
83113	111040211105	CWM02/5
83114	064848128010	SAG128
83116	064848124010	SAG124
83117	064848116010	SAG116
83119	064848067010	SAG067
83121	064848063010	SAG063
83122	064820084010	SEN8E
83123	064820088010	SEN8I
83125	064820168010	SEN8I3
83126	111040144501	SEN8U
83127	111040211102	CWM02/2
83128	111040211108	CWM02/8
83129	064848099010	SAG099
83130	064848127010	SAG127
83135	064848062010	SAG062
83136	064848040010	SAG040
83140	064848087010	SAG087
83142	064848066010	SAG066
83143	064848142010	SAG142
83144	064848085010	SAG085
83146	064848071010	SAG071
83147	064848114010	SAG114

OE/IAM		 LONG SHORT	
H1	SENSORE GIRI / FASE - ALBERO MOTORE CRANKSHAFT POSITION SENSOR		
SIDAT			
83148	064848017010	SAG017	
83149	064848047010	SAG047	
83150	064848138010	SAG138	
83158	064848077010	SAG077	
83160	064848052010	SAG052	
83163	064848023010	SAG023	
83169	064848089010	SAG089	
83172	064848168010	SAG168	
83173	064848145010	SAG145	
83175	064848064010	SAG064	
83177	064848068010	SAG068	
83182	064848083010	SAG083	
83183	064848131010	SAG131	
83187	064848058010	SAG058	
83188	064848039010	SAG039	
83190	064848090010	SAG090	
83192	064848078010	SAG078	
83193	064848108010	SAG108	
83194	064848072010	SAG072	
83195	064848053010	SAG053	
83197	064848035010	SAG035	
83198	064848088010	SAG088	
83214	064848153010	SAG153	
83217	064847110010	SAC010	
83227	064848121010	SAG121	
83232	064848043010	SAG043	
83262	064848102010	SAG102	
83263	810001989801	CVM03/1	
83268	064848036010	SAG036	
83277	064848032010	SAG032	
83278	064848045010	SAG045	
83298	064848029010	SAG029	
83300	064848104010	SAG104	
83306	064848038010	SAG038	
83311	064848055010	SAG055	
83317	064848027010	SAG027	
83322	064848049010	SAG049	
83324	064848065010	SAG065	
83332	064848056010	SAG056	
83333	064848086010	SAG086	
83342	064848069010	SAG069	
83352	064848031010	SAG031	
83361	064848151010	SAG151	

OE/IAM		 LONG SHORT	
H1	SENSORE GIRI / FASE - ALBERO MOTORE CRANKSHAFT POSITION SENSOR		
SIDAT			
83363	064848136010	SAG136	
83367	064848163010	SAG163	
83370	064848174010	SAG174	
83371	064848152010	SAG152	
83372	064848094010	SAG094	
83373	064848110010	SAG110	
83376	064848046010	SAG046	
83379	064848092010	SAG092	
83382	064848167010	SAG167	
83384	064848155010	SAG155	
83386	064848169010	SAG169	
83397	064848041010	SAG041	
83402	064848171010	SAG171	
83404	064848170010	SAG170	
83406	064848166010	SAG166	
83414	111001178501	CVS02	
83415	064848160010	SAG160	
83416	064848103010	SAG103	
83425	064848033010	SAG033	
83426	064848074010	SAG074	
83429	064848140010	SAG140	
83434	064848061010	SAG061	
83444	064848037010	SAG037	
83445	064848172010	SAG172	
83453	064847105010	SAC005	
83454	064848132010	SAG132	
83455	064848050010	SAG050	
83459	064848034010	SAG034	
83461	064848123010	SAG123	
83465	064848091010	SAG091	
83473	064848080010	SAG080	
83474	064848082010	SAG082	
83476	064848101010	SAG101	
83485	064848109010	SAG109	
83490	064848054010	SAG054	
83492	064848028010	SAG028	
83494	064848044010	SAG044	
83498	064848112010	SAG112	
550310	064848179010	SAG179	
83066-2	064848024011	SAG024-1	
83084-2	064848021011	SAG021-1	
83163-2	064848023011	SAG023-1	

OE/IAM	MAGNETI MARELLI	
	LONG	SHORT
H1	SENSORE GIRI / FASE - ALBERO MOTORE CRANKSHAFT POSITION SENSOR	
SIEMENS VDO		
5WK90051Z	064848075010	SAG075
5WK91711	064848120010	SAG120
5WK96011Z	064848115010	SAG115
5WK96041	064848111010	SAG111
5WK96041Z	064848111010	SAG111
5WK96071	064848107010	SAG107
A2C5318385102	064848103010	SAG103
A2C59511450	064848159010	SAG159
A2C59513358Z	064848163010	SAG163
A2C59513360Z	064848160010	SAG160
A2C59514015	064848103010	SAG103
S101750013A	064848158010	SAG158
S101750013Z	064848158010	SAG158
S101750016A	064848095010	SAG095
S101750016Z	064848095010	SAG095
S101750023A	064848036010	SAG036
S101756003	064848128010	SAG128
S101756003A	064848128010	SAG128
S101756003Z	064848128010	SAG128
S101918001C	064848093010	SAG093
S101918001Z	064848093010	SAG093
S101938001Z	064848141010	SAG141
S101938002	064848124010	SAG124
S101938002Z	064848124010	SAG124
S101938004	064848137010	SAG137
S101938004Z	064848137010	SAG137
S102340005	064848150010	SAG150
S102340005A	064848150010	SAG150
S102340005Z	064848150010	SAG150
S102340006	064848150010	SAG150
S102340006D	064848150010	SAG150
S102340006Z	064848150010	SAG150
S10234006	064848150010	SAG150
S102460001E	064848084010	SAG084
S102460001Z	064848084010	SAG084
S103557002B	064848111010	SAG111
S103557002Z	064848111010	SAG111
S103857001	064848107010	SAG107
S103857002A	064848107010	SAG107
S103857002Z	064848107010	SAG107
S103957001D	064848118010	SAG118
S103957001Z	064848118010	SAG118
S105578001Z	064848116010	SAG116

OE/IAM	MAGNETI MARELLI	
	LONG	SHORT
H1	SENSORE GIRI / FASE - ALBERO MOTORE CRANKSHAFT POSITION SENSOR	
SIEMENS VDO		
S105757001E	064848159010	SAG159
S105757001Z	064848159010	SAG159
S105758001E	064848129010	SAG129
S107230001C	064848144010	SAG144
S107230001Z	064848144010	SAG144
S107306001A	064848143010	SAG143
S107541001Z	064848120010	SAG120
S107644002Z	064848157010	SAG157
S119974001Z	064848129010	SAG129
S119976001Z	064848143010	SAG143
SSANGYONG		
0031537228	064848146010	SAG146
0031537428	064848146010	SAG146
STANDARD		
17012	064848101010	SAG101
17090	064848109010	SAG109
19031	064848168010	SAG168
CS1420	064848101010	SAG101
SUZUKI		
3322085E10	064848025010	SAG025
3322067J10	064848153010	SAG153
3322067J10000	064848153010	SAG153
3322067J11	064848153010	SAG153
3322067J11000	064848153010	SAG153
3322067J12	064848153010	SAG153
3322067J12000	064848153010	SAG153
3322080G00	064848053010	SAG053
3322084A00000	064847110010	SAC010
3322084A10000	064847110010	SAC010
3322085E10000	064848025010	SAG025
33220N86J00	064848025010	SAG025
33220N86J00000	064848025010	SAG025
3544284CT1	064848161010	SAG161
3544284CT1000	064848161010	SAG161
3544286CA0	064848161010	SAG161
3544286CA0000	064848161010	SAG161
3544286CA1	064848161010	SAG161
3544286CA1000	064848161010	SAG161
SWAG		
40918163	064848107010	SAG107
62931200	064848169010	SAG169

OE/IAM	 LONG SHORT	
--------	-------------------------------------	--

H1	SENSORE GIRI / FASE - ALBERO MOTORE CRANKSHAFT POSITION SENSOR
----	---

TOPRAN		
108729	064848178010	SAG178
113466	064848090010	SAG090
205894	064848124010	SAG124
206202	064848019010	SAG019
206693	064848137010	SAG137
206694	064848116010	SAG116
207066	064848025010	SAG025
207067	064848133010	SAG133
500986	064848099010	SAG099
500987	064848151010	SAG151
501295	064848087010	SAG087
501296	064848062010	SAG062
501306	064848061010	SAG061
501441	064848111010	SAG111
501442	064848144010	SAG144
501444	064848115010	SAG115
700756	064848159010	SAG159
721674	064848156010	SAG156
721680	064848130010	SAG130
721681	064848164010	SAG164
721912	064848027010	SAG027
721913	064848028010	SAG028

TOYOTA		
9091905020	064848092010	SAG092
9091905025	064848046010	SAG046
9091905045	064848136010	SAG136
9091905047	064848123010	SAG123
9091905052	064848092010	SAG092
9091905062	064848152010	SAG152
90919W5002	064848152010	SAG152

VAG		
021907319	064848064010	SAG064
022957147	064848065010	SAG065
036906433	064848166010	SAG166
038907319	064848138010	SAG138
045957147	064848134010	SAG134
047906433	064848077010	SAG077
050906433	064848127010	SAG127
60603937	064820167010	SEN8K3
071957147	064848049010	SAG049
078906433	064848038010	SAG038
095927321	064848026010	SAG026
357919149	064848178010	SAG178

OE/IAM	 LONG SHORT	
--------	-------------------------------------	--

H1	SENSORE GIRI / FASE - ALBERO MOTORE CRANKSHAFT POSITION SENSOR
----	---

VAG		
94460611500	064848047010	SAG047
021906433E	064848096010	SAG096
021907319B	064848064010	SAG064
028907319B	064848142010	SAG142
030957147G	064848145010	SAG145
030957147S	064848132010	SAG132
036906433A	064848166010	SAG166
036906433E	064848166010	SAG166
037906433A	064848118010	SAG118
037906433B	064848118010	SAG118
037906433C	064848118010	SAG118
03C906433A	064848155010	SAG155
045907319A	064848134010	SAG134
045957147C	064848134010	SAG134
06A906433A	064848090010	SAG090
06A906433C	064848018010	SAG018
06A906433E	064848090010	SAG090
06A906433F	064848033010	SAG033
06A906433K	064848100010	SAG100
077905381G	064848056010	SAG056
078906433A	064848017010	SAG017
078906433B	064848096010	SAG096
07K907601	064848050010	SAG050
095927321A	064848026010	SAG026
095927321C	064848026010	SAG026

VALEO		
255003	064847110010	SAC010

VAUXHALL		
1238223	064848120010	SAG120
1238938	064848020010	SAG020
6238313	064848093010	SAG093
09115115	064848120010	SAG120
10456604	064848020010	SAG020
90451441	064848093010	SAG093

VEMO		
V10721014	064848090010	SAG090
V10721127	064848132010	SAG132
V20720402	064848111010	SAG111
V20720403	064848144010	SAG144
V20720405	064848099010	SAG099
V20720411	064848115010	SAG115
V20720425	064848062010	SAG062
V20720431	064848075010	SAG075

OE/IAM	MAGNETI MARELLI	
	LONG	SHORT
H1	SENSORE GIRI / FASE - ALBERO MOTORE CRANKSHAFT POSITION SENSOR	
VEMO		
V207204321	064848087010	SAG087
V20720471	064848151010	SAG151
V20720476	064848061010	SAG061
V20729001	064848151010	SAG151
V22720008	064848156010	SAG156
V22720013	064848164010	SAG164
V22720016	064848130010	SAG130
V22720019	064848157010	SAG157
V22720020	064848126010	SAG126
V24720012	064848025010	SAG025
V24720013	064848133010	SAG133
V24720018	064848121010	SAG121
V24720082	064848048010	SAG048
V25721075	064848172010	SAG172
V30720111	064848023010	SAG023
V30720111	064848023011	SAG023-1
V30720117	064848024010	SAG024
V30720117	064848024011	SAG024-1
V40720303	064848124010	SAG124
V40720305	064848107010	SAG107
V40720354	064848021010	SAG021
V40720354	064848021011	SAG021-1
V40720359	064848019010	SAG019
V40720360	064848116010	SAG116
V40720362	064848137010	SAG137
V40720369	064848020010	SAG020
V40720418	064848057010	SAG057
V40720426	064848083010	SAG083
V42720028	064848169010	SAG169
V42720038	064848028010	SAG028
V46720004	064848036010	SAG036
V46720008	064848158010	SAG158
V46720010	064848128010	SAG128
V46720013	064848143010	SAG143
V46720015	064848159010	SAG159
V46720022	064848036010	SAG036
V46720076	064848103010	SAG103
V52720008	064848135010	SAG135
V52720009	064848105010	SAG105
V52720033	064848037010	SAG037

OE/IAM	MAGNETI MARELLI	
	LONG	SHORT
H1	SENSORE GIRI / FASE - ALBERO MOTORE CRANKSHAFT POSITION SENSOR	
VOLVO		
271949	064848059010	SAG059
1270603	064848086010	SAG086
1317030	064848047010	SAG047
1367645	064848066010	SAG066
1389399	064848059010	SAG059
3507941	064848084010	SAG084
3547699	064848084010	SAG084
3547847	064848059010	SAG059
8653703	064848169010	SAG169
13170303	064848047010	SAG047
13676457	064848066010	SAG066
13893995	064848059010	SAG059
30816491	064848085010	SAG085
30865096	064848052010	SAG052
30883794	064848153010	SAG153
31216677	064848167010	SAG167
35079417	064848084010	SAG084
35476693	064848084010	SAG084
35476993	064848084010	SAG084
35478478	064848059010	SAG059
308164912	064848085010	SAG085
8653703A	064848169010	SAG169

H2	SENSORE POSIZIONE ALBERO A CAM CAMSHAFT POSITION SENSOR	
BBT		
CSS701	064847161010	SAC061
CSS716	064847193010	SAC093
CSS904	064847176010	SAC076
BLUE PRINT		
ADC47216C	064847185010	SAC085
ADD67202	064847151010	SAC051
ADH27205C	064847156010	SAC056
ADH27213C	064847169010	SAC069
ADH27217	064847128010	SAC028
ADK87202	064847137010	SAC037
ADN17215C	064847152010	SAC052
BMW		
12141247219	064847150010	SAC050
12141247258	064847150010	SAC050
12141438081	064847176010	SAC076
12141721705	064847117010	SAC017
12141721861	064847117010	SAC017

OE/IAM	 LONG SHORT	
--------	-------------------------------------	--

H2	SENSORE POSIZIONE ALBERO A CAM CAMSHAFT POSITION SENSOR	
----	--	--

BMW		
12141726519	064847142010	SAC042
12141726590	064847142010	SAC042
12141731886	064847134010	SAC034
12141734813	064847134010	SAC034
12147539165	064847176010	SAC076
14141435350	064847176010	SAC076
14141438081	064847176010	SAC076
BOSCH		
0232101024	064847184010	SAC084
0232101025	064847184010	SAC084
0232101026	064847149010	SAC049
0232101031	064847115010	SAC015
0232101035	064847159010	SAC059
0232101036	064847124010	SAC024
0232103007	064847125010	SAC025
0232103009	064847129010	SAC029
0232103015	064847135010	SAC035
0232103019	064847140010	SAC040
0232103020	064847140010	SAC040
0232103024	064847129010	SAC029
0232103025	064847121010	SAC021
0232103033	064847194010	SAC094
0232103034	064847194010	SAC094
0232103036	064847119010	SAC019
0232103039	064847194010	SAC094
0232103040	064847194010	SAC094
0232103041	064847194010	SAC094
0232103042	064847194010	SAC094
0232103043	064847195010	SAC095
0232103048	064847195010	SAC095
0232103050	064847131010	SAC031
0232103051	064847131010	SAC031
0232103052	064847192010	SAC092
0232103064	064847172010	SAC072
0232103069	064847191010	SAC091
0232103097	064847195010	SAC095
0232103109	064847131010	SAC031
0232103110	064847131010	SAC031
0232103114	064847131010	SAC031
0232103115	064847131010	SAC031
0232103120	064847131010	SAC031
0232103121	064847131010	SAC031
0232103127	064847192010	SAC092

OE/IAM	 LONG SHORT	
--------	-------------------------------------	--

H2	SENSORE POSIZIONE ALBERO A CAM CAMSHAFT POSITION SENSOR	
----	--	--

BOSCH		
0261210053	064847142010	SAC042
0261210058	064847117010	SAC017
0281002163	064847188010	SAC088
0281002213	064847188010	SAC088
0281002406	064847194010	SAC094
0281002512	064847138010	SAC038
0281002634	064847154010	SAC054
0986280420	064847114010	SAC014
0986280423	064847182010	SAC082
0986280427	064847200010	SAC100
0986280428	064847173010	SAC073
0986280429	064847175010	SAC075
0986280432	064847111010	SAC011
BOUGICORD		
141202	064847168010	SAC068
141203	064847193010	SAC093
141208	064847168010	SAC068
141209	064847193010	SAC093
141218	064847168010	SAC068
141219	064847193010	SAC093
144308	064847164010	SAC064
144323	064847170010	SAC070
144339	064847200010	SAC100
144410	064847177010	SAC077
144503	064847189010	SAC089
144508	064847173010	SAC073
144509	064847175010	SAC075
144520	064847111010	SAC011
144528	064847114010	SAC014
144556	064847167010	SAC067
144561	064847147010	SAC047
145101	064847182010	SAC082
145544	064847123010	SAC023
147201	064847180010	SAC080
147202	064847157010	SAC057
149801	064847148010	SAC048
CHEVROLET		
10456506	064847136010	SAC036
96253544	064847151010	SAC051
96418393	064847136010	SAC036

OE/IAM

MAGNETI
MARELLI

LONG

SHORT

H2 SENSORE POSIZIONE ALBERO A CAM
CAMSHAFT POSITION SENSOR**DAEWOO**

10456506	064847136010	SAC036
0021539528	064847143010	SAC043
0041530028	064847116010	SAC016
96253544	064847151010	SAC051
96418393	064847136010	SAC036

DAIHATSU

9091905024000	064847186010	SAC086
9091905024000	064847191010	SAC091

DELPHI

SS10132	064847128010	SAC028
SS1051812B1	064847180010	SAC080
SS1071112B1	064847157010	SAC057
SS1072612B1	064847168010	SAC068
SS1072712B1	064847193010	SAC093
SS1073412B1	064847164010	SAC064
SS1074012B1	064847170010	SAC070
SS1074912B1	064847200010	SAC100
SS1076112B1	064847189010	SAC089
SS1076212B1	064847173010	SAC073
SS1076312B1	064847175010	SAC075
SS10800	064847161010	SAC061
SS10814	064847176010	SAC076
SS10816	064847152010	SAC052
SS10820	064847132010	SAC032
SS10884	064847171010	SAC071
SS10885	064847182010	SAC082
SS10886	064847125010	SAC025
SS10902	064847166010	SAC066
SS10903	064847153010	SAC053
SS1251812B1	064847180010	SAC080

DENSO

0296000251	064847166010	SAC066
0296000590	064847186010	SAC086
0296000660	064847160010	SAC060
0296001211	064847190010	SAC090
0296001212	064847190010	SAC090

ERA

550001	064847168010	SAC068
550002	064847193010	SAC093
550010	064847170010	SAC070
550017	064847200010	SAC100
550026	064847189010	SAC089
550027	064847173010	SAC073

OE/IAM

MAGNETI
MARELLI

LONG

SHORT

H2 SENSORE POSIZIONE ALBERO A CAM
CAMSHAFT POSITION SENSOR**ERA**

550028	064847175010	SAC075
550032	064847111010	SAC011
550033	064847114010	SAC014
550034	064847182010	SAC082
550038	064847103010	SAC003
550042	064847197010	SAC097
550046	064847177010	SAC077
550053	064847180010	SAC080
550057	064847188010	SAC088
550059	064847171010	SAC071
550060	064847161010	SAC061
550113	064847149010	SAC049
550115	064847164010	SAC064
550128	064847194010	SAC094
550151	064847183010	SAC083
550153	064847136010	SAC036
550169	064847145010	SAC045
550191	064847124010	SAC024
550201	064847146010	SAC046
550222	064847184010	SAC084
550229	064847148010	SAC048
550235	064847115010	SAC015
550245	064847195010	SAC095
550247	064847132010	SAC032
550252	064847159010	SAC059
550281	064847163010	SAC063
550288	064847194010	SAC094
550290	064847198010	SAC098
550291	064847194010	SAC094
550293	064847120010	SAC020
550307	064847139010	SAC039
550329	064847130010	SAC030
550347	064847137010	SAC037
550348	064847144010	SAC044
550358	064847126010	SAC026
550369	064847143010	SAC043
550380	064847196010	SAC096
550382	064847196010	SAC096
550405	064847151010	SAC051
550430	064847133010	SAC033
550432	064847196010	SAC096
550440	064847186010	SAC086
550450	064847176010	SAC076

OE/IAM		 LONG SHORT	
H2	SENSORE POSIZIONE ALBERO A CAM CAMSHAFT POSITION SENSOR		
ERA			
550461	064847118010	SAC018	
550476	064847147010	SAC047	
550478	064847167010	SAC067	
550490	064847135010	SAC035	
550508	064847116010	SAC016	
550509	064847112010	SAC012	
550520	064847141010	SAC041	
550525	064847130010	SAC030	
550539	064847152010	SAC052	
550573	064847158010	SAC058	
550574	064847162010	SAC062	
550609	064847156010	SAC056	
550610	064847166010	SAC066	
550648	064847157010	SAC057	
550677	064847154010	SAC054	
550688	064847140010	SAC040	
550689	064847138010	SAC038	
550698	064847172010	SAC072	
550765	064847131010	SAC031	
550779	064847121010	SAC021	
550788	064847125010	SAC025	
550790	064847129010	SAC029	
9670930004	064847192010	SAC092	
550034B	064847182010	SAC082	
550128B	064847194010	SAC094	
550169B	064847145010	SAC045	
550191B	064847124010	SAC024	
550201B	064847146010	SAC046	
550222B	064847184010	SAC084	
550229B	064847148010	SAC048	
550245B	064847195010	SAC095	
550247B	064847132010	SAC032	
550252B	064847159010	SAC059	
550281B	064847163010	SAC063	
550291B	064847163010	SAC063	
550292B	064847192010	SAC092	
550292HQ	064847192010	SAC092	
550329B	064847130010	SAC030	
550369B	064847143010	SAC043	
550405B	064847151010	SAC051	
550428B	064847123010	SAC023	
550428HQ	064847123010	SAC023	
550450B	064847176010	SAC076	

OE/IAM		 LONG SHORT	
H2	SENSORE POSIZIONE ALBERO A CAM CAMSHAFT POSITION SENSOR		
ERA			
550539B	064847152010	SAC052	
FACET			
90043	064847102010	SAC002	
90071	064847142010	SAC042	
90085	064847134010	SAC034	
90086	064847150010	SAC050	
90091	064847117010	SAC017	
90105	064847164010	SAC064	
90112	064847143010	SAC043	
90166	064847198010	SAC098	
90189	064847103010	SAC003	
90208	064847149010	SAC049	
90210	064847159010	SAC059	
90211	064847124010	SAC024	
90239	064847129010	SAC029	
90243	064847125010	SAC025	
90263	064847190010	SAC090	
90264	064847153010	SAC053	
90269	064847114010	SAC014	
90277	064847139010	SAC039	
90278	064847145010	SAC045	
90281	064847101010	SAC001	
90286	064847121010	SAC021	
90302	064847104010	SAC004	
90310	064847132010	SAC032	
90311	064847135010	SAC035	
90313	064847136010	SAC036	
90315	064847182010	SAC082	
90316	064847180010	SAC080	
90317	064847171010	SAC071	
90333	064848016010	SAG016	
90335	064847130010	SAC030	
90343	064847163010	SAC063	
90344	064847194010	SAC094	
90351	064847140010	SAC040	
90354	064847148010	SAC048	
90355	064847188010	SAC088	
90361	064847192010	SAC092	
90365	064847184010	SAC084	
90367	064847115010	SAC015	
90367	064847115011	SAC015-1	
90368	064847111010	SAC011	
90380	064847193010	SAC093	

OE/IAM		MAGNETI MARELLI	
		LONG	SHORT
H2	SENSORE POSIZIONE ALBERO A CAM CAMSHAFT POSITION SENSOR		
FACET			
90387	064847131010	SAC031	
90388	064847168010	SAC068	
90449	064847157010	SAC057	
90452	064847195010	SAC095	
90456	064847185010	SAC085	
90460	064847196010	SAC096	
90462	064847170010	SAC070	
90463	064847200010	SAC100	
90466	064847191010	SAC091	
90476	064847138010	SAC038	
90477	064847186010	SAC086	
90480	064847162010	SAC062	
90486	064847165010	SAC065	
90490	064847166010	SAC066	
90497	064847178010	SAC078	
90500	064847160010	SAC060	
90504	064848015010	SAG015	
90551	064847177010	SAC077	
90556	064847158010	SAC058	
90573	064847141010	SAC041	
90598	064847147010	SAC047	
90619	064847195010	SAC095	
FAE			
79040	064847172010	SAC072	
79099	064847143010	SAC043	
79102	064847164010	SAC064	
79106	064847188010	SAC088	
79121	064847180010	SAC080	
79137	064847182010	SAC082	
79138	064847171010	SAC071	
79140	064847148010	SAC048	
79147	064847200010	SAC100	
79150	064847170010	SAC070	
79166	064847161010	SAC061	
79167	064847146010	SAC046	
79168	064847132010	SAC032	
79169	064847135010	SAC035	
79171	064847193010	SAC093	
79172	064847168010	SAC068	
79175	064847173010	SAC073	
79176	064847175010	SAC075	
79192	064847163010	SAC063	
79193	064847157010	SAC057	

OE/IAM		MAGNETI MARELLI	
		LONG	SHORT
H2	SENSORE POSIZIONE ALBERO A CAM CAMSHAFT POSITION SENSOR		
FAE			
79197	064847138010	SAC038	
79203	064847166010	SAC066	
79204	064847186010	SAC086	
79206	064847194010	SAC094	
79209	064847140010	SAC040	
79227	064847129010	SAC029	
79229	064847121010	SAC021	
79234	064847125010	SAC025	
79236	064847145010	SAC045	
79248	064847198010	SAC098	
79283	064847165010	SAC065	
79284	064847160010	SAC060	
79285	064847178010	SAC078	
79293	064847167010	SAC067	
79306	064847177010	SAC077	
79312	064847153010	SAC053	
79337	064847162010	SAC062	
79338	064847195010	SAC095	
79341	064847185010	SAC085	
79342	064847189010	SAC089	
79348	064847158010	SAC058	
79349	064847141010	SAC041	
79358	064847156010	SAC056	
79368	064847133010	SAC033	
FCA			
5114675	064847123010	SAC023	
7777344	064847149010	SAC049	
8024224	064847129010	SAC029	
46432103	064847188010	SAC088	
46469912	064847159010	SAC059	
46481640	064847188010	SAC088	
46520138	064847124010	SAC024	
46786049	064847194010	SAC094	
46798364	064847168010	SAC068	
46798365	064847193010	SAC093	
46798368	064847195010	SAC095	
46811121	064847195010	SAC095	
46811123	064847129010	SAC029	
55187973	064847192010	SAC092	
55190509	064847179010	SAC079	
55201874	064847193010	SAC093	
55201876	064847168010	SAC068	
55216241	064847193010	SAC093	

OE/AM	 LONG SHORT	
-------	-------------------------------------	--

H2	SENSORE POSIZIONE ALBERO A CAM CAMSHAFT POSITION SENSOR	
----	--	--

FCA		
55216243	064847168010	SAC068
55352609	064847162010	SAC062
60586655	064847129010	SAC029
60662825	064847129010	SAC029
60810695	064847129010	SAC029
60814770	064847188010	SAC088
60816861	064847129010	SAC029
71739799	064847157010	SAC057
467860490	064847194010	SAC094
500371540	064847138010	SAC038
504052598	064847154010	SAC054
9613173380	064847164010	SAC064
9629139880	064847170010	SAC070
9663752580	064847196010	SAC096
9665443680	064847196010	SAC096
FEBI BILSTEIN		
18169	064847161010	SAC061
24162	064847176010	SAC076
28386	064847188010	SAC088
32085	064847169010	SAC069
40055	064847162010	SAC062
FORD		
1037465	064847103010	SAC003
1037605	064847120010	SAC020
1072303	064847140010	SAC040
1100749	064848015010	SAG015
1111037	064847104010	SAC004
1119150	064848016010	SAG016
1119942	064847101010	SAC001
1129988	064848016010	SAG016
1219993	064847183010	SAC083
1222677	064847194010	SAC094
1229954	064847196010	SAC096
1255020	064847196010	SAC096
1314032	064847196010	SAC096
1319158	064847192010	SAC092
1347419	064847183010	SAC083
1358343	064847183010	SAC083
1358961	064848015010	SAG015
1367334	064847123010	SAC023
1371595	064847133010	SAC033
1371654	064847190010	SAC090
1424270	064848015010	SAG015

OE/AM	 LONG SHORT	
-------	-------------------------------------	--

H2	SENSORE POSIZIONE ALBERO A CAM CAMSHAFT POSITION SENSOR	
----	--	--

FORD		
1431017	064848015010	SAG015
1490841	064847196010	SAC096
1544172	064847179010	SAC079
1580907	064847196010	SAC096
1685774	064847199010	SAC099
1727897	064847190010	SAC090
1780382	064847183010	SAC083
1781666	064847174010	SAC074
1803502	064847183010	SAC083
1811604	064847183010	SAC083
1826557	064847192010	SAC092
3724887	064847198010	SAC098
4094767	064847198010	SAC098
4469196	064847198010	SAC098
4731642	064847197010	SAC097
7033372	064847102010	SAC002
7103313	064847198010	SAC098
038907319J	064848015010	SAG015
038957147D	064848015010	SAG015
038957147F	064848015010	SAG015
1F1E62B288AA	064847198010	SAC098
1F1E6B288AA	064847198010	SAC098
1F1E6B288AB	064847198010	SAC098
1L2E6B288AA	064847189010	SAC089
1S7F12K073AD	064847101010	SAC001
1S7F6C315AD	064848016010	SAG016
1S7F6D315AA	064848016010	SAG016
2S7G12K073AA	064847194010	SAC094
2S7Q12K073BA	064847183010	SAC083
2S7Q12K073BB	064847183010	SAC083
3M5Q12K073AB	064847196010	SAC096
3M5Q12K073AC	064847196010	SAC096
4M5G12K073AA	064847192010	SAC092
4M5G12K073AB	064847192010	SAC092
5L2E6B288AA	064847189010	SAC089
5L2Z6B288A	064847189010	SAC089
6C1112K073A	064847183010	SAC083
6C1112K073AA	064847183010	SAC083
6C1112K073AB	064847183010	SAC083
6C1112K073AC	064847183010	SAC083
6M216C315AA	064848015010	SAG015
6M216C315BA	064848015010	SAG015
6M216C315CA	064848015010	SAG015

OE/IAM

MAGNETI
MARELLI

LONG

SHORT

H2

SENSORE POSIZIONE ALBERO A CAM
CAMSHAFT POSITION SENSOR

FORD

6M5G12K073AA	064847133010	SAC033
6M5G6C315AA	064847190010	SAC090
6M5G6C315AB	064847190010	SAC090
6M8G12073BA	064847123010	SAC023
6M8G12K073AB	064847123010	SAC023
928F12K073A1E	064847102010	SAC002
95BF12K073AA	064847189010	SAC089
95BF12K073AB	064847103010	SAC003
95VW9P986BA	064847140010	SAC040
978F12K073BA	064847120010	SAC020
9M5Q12K073AA	064847196010	SAC096
9S5112K073AA	064847179010	SAC079
AV6Q12K073AA	064847199010	SAC099
F43E6B288AA	064847198010	SAC098
F8CZ6B288A	064847120010	SAC020
F8CZ6B288AA	064847120010	SAC020
F8ZZ6B288AA	064847120010	SAC020
XM216C315AB	064848015010	SAG015
XM246C315AA	064848015010	SAG015
XS2E6B288AA	064847198010	SAC098
YS6A12K073AB	064847104010	SAC004

GENERAL MOTORS

1238915	064847161010	SAC061
6238111	064847121010	SAC021
9012039	064847146010	SAC046
9041795	064847182010	SAC082
9118140	064847121010	SAC021
9146032	064847121010	SAC021
10456506	064847136010	SAC036
10456585	064847180010	SAC080
10456592	064847163010	SAC063
24435096	064847157010	SAC057
24445139	064847146010	SAC046
25337265	064847157010	SAC057
55216243	064847168010	SAC068
55352609	064847162010	SAC062
90412795	064847182010	SAC082
90458252	064847161010	SAC061
90506101	064847135010	SAC035
90510657	064847125010	SAC025
90520850	064847132010	SAC032
90536064	064847171010	SAC071
91173944	064847137010	SAC037

OE/IAM

MAGNETI
MARELLI

LONG

SHORT

H2

SENSORE POSIZIONE ALBERO A CAM
CAMSHAFT POSITION SENSOR

GENERAL MOTORS

91174659	064847137010	SAC037
91175909	064847137010	SAC037
93171450	064847146010	SAC046
93176039	064847135010	SAC035
93178046	064847193010	SAC093
93179392	064847168010	SAC068
93179513	064847188010	SAC088
93190702	064847168010	SAC068
93190703	064847193010	SAC093
93193371	064847193010	SAC093
93198004	064847177010	SAC077
95253544	064847151010	SAC051
96418393	064847136010	SAC036
97306560	064847194010	SAC094
465926034	064847163010	SAC063

HELLA

009121401	064847114010	SAC014
009121441	064847111010	SAC011
009121501	064847112010	SAC012
009121561	064847115010	SAC015
009121561	064847115011	SAC015-1
009121681	064847183010	SAC083
009167001	064847190010	SAC090
6PU009121031	064847132010	SAC032
6PU009121041	064847171010	SAC071
6PU009121061	064847161010	SAC061
6PU009121062	064847161010	SAC061
6PU009121071	064847116010	SAC016
6PU009121081	064847143010	SAC043
6PU009121131	064847180010	SAC080
6PU009121201	064847164010	SAC064
6PU009121251	064847134010	SAC034
6PU009121261	064847150010	SAC050
6PU009121301	064847142010	SAC042
6PU009121311	064847146010	SAC046
6PU009121321	064847168010	SAC068
6PU009121331	064847193010	SAC093
6PU009121361	064847170010	SAC070
6PU009121381	064847200010	SAC100
6PU009121401	064847114010	SAC014
6PU009121411	064847173010	SAC073
6PU009121421	064847175010	SAC075
6PU009121441	064847111010	SAC011

OE/IAM	 LONG SHORT	
--------	-------------------------------------	--

H2	SENSORE POSIZIONE ALBERO A CAM CAMSHAFT POSITION SENSOR	
----	--	--

HELLA		
-------	--	--

6PU009121461	064847182010	SAC082
6PU009121501	064847112010	SAC012
6PU009121551	064847184010	SAC084
6PU009121561	064847115010	SAC015
6PU009121561	064847115011	SAC015-1
6PU009121641	064847176010	SAC076
6PU009121671	064847171010	SAC071
6PU009121811	064847195010	SAC095
6PU009121871	064847149010	SAC049
6PU009121891	064847138010	SAC038
6PU009121901	064847185010	SAC085
6PU009121911	064847162010	SAC062
6PU009146141	064847142010	SAC042
6PU009146161	064847150010	SAC050
6PU009163841	064847194010	SAC094
6PU009163921	064847192010	SAC092
6PU009168051	064847177010	SAC077

HONDA		
-------	--	--

37500PNB003	064847169010	SAC069
37501PLZD00	064847194010	SAC094
37840P0AA01	064847128010	SAC028
37840PAAA01	064847128010	SAC028
37840PLC000	064847156010	SAC056
37840PLC005	064847156010	SAC056
37840PLC006	064847156010	SAC056
37840RJH006	064847156010	SAC056
37841RBDE01	064847194010	SAC094
37841RBDE010	064847194010	SAC094
37841RBDE010M4	064847194010	SAC094

HYUNDAI		
---------	--	--

3935022040	064847145010	SAC045
3935023010	064847139010	SAC039
393002A000	064847158010	SAC058
393502B000	064847141010	SAC041
393502B010	064847141010	SAC041
393504A000	064847118010	SAC018

INTERMOTOR		
------------	--	--

17087	064847128010	SAC028
17092	064847199010	SAC099
18858	064847142010	SAC042
18862	064847134010	SAC034
18863	064847150010	SAC050
18866	064847164010	SAC064

OE/IAM	 LONG SHORT	
--------	-------------------------------------	--

H2	SENSORE POSIZIONE ALBERO A CAM CAMSHAFT POSITION SENSOR	
----	--	--

INTERMOTOR		
------------	--	--

18887	064847159010	SAC059
18888	064847124010	SAC024
18910	064847129010	SAC029
18914	064847125010	SAC025
18928	064847139010	SAC039
18929	064847145010	SAC045
18934	064847121010	SAC021
18960	064847161010	SAC061
18964	064847198010	SAC098
18991	064847132010	SAC032
18992	064847135010	SAC035
18993	064847136010	SAC036
18994	064847182010	SAC082
18995	064847171010	SAC071
19001	064847130010	SAC030
19003	064847194010	SAC094
19006	064847188010	SAC088
19024	064847180010	SAC080
19032	064847170010	SAC070
19040	064847163010	SAC063
19042	064847184010	SAC084
19043	064847200010	SAC100
19046	064847146010	SAC046
19047	064847193010	SAC093
19057	064847195010	SAC095
19059	064847138010	SAC038
19102	064847156010	SAC056
19104	064847162010	SAC062
19135	064847153010	SAC053
19141	064847176010	SAC076
19154	064847120010	SAC020
19157	064847137010	SAC037
19180	064847151010	SAC051
19190	064847185010	SAC085
19205	064847169010	SAC069
19215	064847152010	SAC052
19269	064847131010	SAC031
19285	064847177010	SAC077
19287	064847155010	SAC055

IVECO		
-------	--	--

500371540	064847138010	SAC038
-----------	--------------	---------------

OE/IAM	MAGNETI MARELLI	
	LONG	SHORT
H2	SENSORE POSIZIONE ALBERO A CAM CAMSHAFT POSITION SENSOR	
KIA		
3931038050	064847130010	SAC030
0K0131813A	064847126010	SAC026
0K0131813X	064847126010	SAC026
393002A000	064847158010	SAC058
393502B000	064847141010	SAC041
393502B010	064847141010	SAC041
LAND ROVER		
LR000634	064847192010	SAC092
LR004492	064847183010	SAC083
LEXUS		
8941150010	064847155010	SAC055
9008019009	064847166010	SAC066
9091905012	064847166010	SAC066
LUCAS ELECTRICAL		
SEB1004	064847130010	SAC030
SEB1006	064847194010	SAC094
SEB1008	064847148010	SAC048
SEB1009	064847188010	SAC088
SEB1027	064847180010	SAC080
SEB1035	064847170010	SAC070
SEB1043	064847163010	SAC063
SEB1046	064847200010	SAC100
SEB1102	064847195010	SAC095
SEB1132	064847146010	SAC046
SEB1141	064847176010	SAC076
SEB1165	064847193010	SAC093
SEB1299	064847179010	SAC079
SEB1592	064847137010	SAC037
SEB401	064847150010	SAC050
SEB402	064847164010	SAC064
SEB408	064847125010	SAC025
SEB410	064847159010	SAC059
SEB460	064847142010	SAC042
SEB461	064847134010	SAC034
SEB465	064847129010	SAC029
SEB491	064847161010	SAC061
SEB841	064847124010	SAC024
SEB872	064847139010	SAC039
SEB873	064847145010	SAC045
SEB874	064847121010	SAC021
SEB884	064847198010	SAC098
SEB971	064847143010	SAC043
SEB994	064847132010	SAC032

OE/IAM	MAGNETI MARELLI	
	LONG	SHORT
H2	SENSORE POSIZIONE ALBERO A CAM CAMSHAFT POSITION SENSOR	
LUCAS ELECTRICAL		
SEB995	064847135010	SAC035
SEB996	064847136010	SAC036
SEB997	064847182010	SAC082
SEB998	064847171010	SAC071
MAZDA		
1E0318194	064847197010	SAC097
Y60118230A	064847196010	SAC096
Y60118230B	064847196010	SAC096
ZJ0118230	064847144010	SAC044
MEAT & DORIA		
87048	064847132010	SAC032
87065	064847171010	SAC071
87128	064847142010	SAC042
87132	064847134010	SAC034
87133	064847150010	SAC050
87134	064847117010	SAC017
87136	064847164010	SAC064
87173	064847103010	SAC003
87184	064847149010	SAC049
87186	064847159010	SAC059
87187	064847124010	SAC024
87213	064847125010	SAC025
87217	064847129010	SAC029
87218	064847194010	SAC094
87219	064847161010	SAC061
87237	064847139010	SAC039
87238	064847145010	SAC045
87252	064847148010	SAC048
87256	064847188010	SAC088
87257	064847115010	SAC015
87269	064847116010	SAC016
87277	064847184010	SAC084
87278	064847114010	SAC014
87279	064847182010	SAC082
87281	064847111010	SAC011
87292	064847200010	SAC100
87295	064847170010	SAC070
87302	064847121010	SAC021
87305	064847198010	SAC098
87316	064847143010	SAC043
87320	064847135010	SAC035
87321	064847136010	SAC036
87326	064847163010	SAC063

OE/IAM		 LONG SHORT	
H2	SENSORE POSIZIONE ALBERO A CAM CAMSHAFT POSITION SENSOR		
MEAT & DORIA			
87327	064847140010	SAC040	
87332	064847193010	SAC093	
87336	064847168010	SAC068	
87379	064847173010	SAC073	
87380	064847175010	SAC075	
87389	064847157010	SAC057	
87390	064847195010	SAC095	
87392	064847138010	SAC038	
87393	064847186010	SAC086	
87402	064847130010	SAC030	
87408	064847180010	SAC080	
87413	064847192010	SAC092	
87415	064847166010	SAC066	
87419	064847146010	SAC046	
87421	064847176010	SAC076	
87425	064847191010	SAC091	
87427	064847162010	SAC062	
87428	064847119010	SAC019	
87434	064847174010	SAC074	
87435	064847112010	SAC012	
87436	064847183010	SAC083	
87442	064847133010	SAC033	
87443	064847144010	SAC044	
87444	064847165010	SAC065	
87446	064847160010	SAC060	
87447	064847178010	SAC078	
87450	064847153010	SAC053	
87458	064847147010	SAC047	
87459	064847167010	SAC067	
87461	064847177010	SAC077	
87464	064847158010	SAC058	
87465	064847141010	SAC041	
87476	064847196010	SAC096	
87477	064847185010	SAC085	
87508	064847154010	SAC054	
87536	064847120010	SAC020	
87545	064847137010	SAC037	
87557	064847126010	SAC026	
87558	064847151010	SAC051	
87562	064847118010	SAC018	
87565	064847172010	SAC072	
87580	064847123010	SAC023	
87594	064847131010	SAC031	

OE/IAM		 LONG SHORT	
H2	SENSORE POSIZIONE ALBERO A CAM CAMSHAFT POSITION SENSOR		
MEAT & DORIA			
87603	064847156010	SAC056	
91508	064847179010	SAC079	
MERCEDES-BENZ			
0009050443	064847131010	SAC031	
0021539528	064847143010	SAC043	
0031539728	064847112010	SAC012	
0041530028	064847116010	SAC016	
0041539628	064847131010	SAC031	
2729050043	064847131010	SAC031	
2729050143	064847131010	SAC031	
A0021539528	064847143010	SAC043	
A0031539128	064847189010	SAC089	
A0031539728	064847112010	SAC012	
A0041530028	064847116010	SAC016	
A0041530028	064847189010	SAC089	
METZGER			
0903002	064847176010	SAC076	
0903007	064847146010	SAC046	
0903027	064847193010	SAC093	
0903035	064847161010	SAC061	
0903039	064847195010	SAC095	
0903043	064847188010	SAC088	
0903048	064847145010	SAC045	
0903054	064847192010	SAC092	
0903078	064847151010	SAC051	
0903085	064847153010	SAC053	
0903093	064847137010	SAC037	
0903096	064847131010	SAC031	
0903105	064847131010	SAC031	
0903113	064847138010	SAC038	
0903115	064847177010	SAC077	
0903116	064847162010	SAC062	
MEYLE			
0148990058	064847131010	SAC031	
MINI			
7791127	064847194010	SAC094	
13627566052	064847172010	SAC072	
13627570191	064847172010	SAC072	
13627588095	064847172010	SAC072	
13627791127	064847194010	SAC094	
MITSUBISHI			
MN980233	064847185010	SAC085	

OE/IAM

MAGNETI
MARELLI

LONG

SHORT

H2 | **SENSORE POSIZIONE ALBERO A CAM**
CAMSHAFT POSITION SENSOR**NISSAN**

227311F710	064847194010	SAC094
2373100Q0A	064847177010	SAC077
2373100Q0C	064847177010	SAC077
237316N202	064847152010	SAC052
237316N206	064847152010	SAC052
237316N20A	064847152010	SAC052
237316N20B	064847152010	SAC052
237316N20C	064847152010	SAC052
237316N20D	064847152010	SAC052
237316N21A	064847152010	SAC052
237318J005	064847152010	SAC052
237318J006	064847152010	SAC052

OPEL

1235268	064847168010	SAC068
1235269	064847193010	SAC093
1235547	064847136010	SAC036
1236308	064847163010	SAC063
1238425	064847171010	SAC071
1238749	064847135010	SAC035
1238915	064847161010	SAC061
1238937	064847180010	SAC080
1247060	064847168010	SAC068
1247432	064847193010	SAC093
4431517	064847177010	SAC077
4432892	064847177010	SAC077
4708542	064847193010	SAC093
6235604	064847194010	SAC094
6235665	064847168010	SAC068
6235667	064847188010	SAC088
6235685	064847192010	SAC092
6235697	064847162010	SAC062
6238000	064847182010	SAC082
6238079	064847132010	SAC032
6238111	064847121010	SAC021
6238117	064847136010	SAC036
6238187	064847161010	SAC061
6238241	064847162010	SAC062
6238282	064847157010	SAC057
6238350	064847125010	SAC025
6238646	064847193010	SAC093
6238939	064847135010	SAC035
9012039	064847146010	SAC046
10456585	064847180010	SAC080

OE/IAM

MAGNETI
MARELLI

LONG

SHORT

H2 | **SENSORE POSIZIONE ALBERO A CAM**
CAMSHAFT POSITION SENSOR**OPEL**

10456592	064847163010	SAC063
24445139	064847146010	SAC046
90412795	064847182010	SAC082
90458252	064847161010	SAC061
90510657	064847125010	SAC025
90520850	064847132010	SAC032
90536064	064847171010	SAC071
93171450	064847146010	SAC046
93178046	064847193010	SAC093
93179513	064847188010	SAC088
93183528	064847192010	SAC092
93190703	064847193010	SAC093
93193371	064847193010	SAC093
93198004	064847177010	SAC077
96418393	064847136010	SAC036
97306560	064847194010	SAC094

PSA

96131733	064847164010	SAC064
96291398	064847170010	SAC070
96305956	064847170010	SAC070
96374991	064847200010	SAC100
9629139880	064847170010	SAC070
9630595680	064847170010	SAC070
9637499180	064847200010	SAC100
9645844080	064847196010	SAC096
9660582080	064847200010	SAC100
9665443480	064847196010	SAC096
19208W	064847170010	SAC070
1920EJ	064847200010	SAC100
1920FY	064847196010	SAC096
1920HV	064847191010	SAC091
1920L1	064847164010	SAC064
1920LS	064847172010	SAC072
1920NP	064847191010	SAC091
1920QN	064847196010	SAC096
1920SR	064847193010	SAC093
1920TS	064847193010	SAC093
V755079880	064847172010	SAC072
V756605280	064847172010	SAC072
V757019180	064847172010	SAC072
V758809580	064847172010	SAC072

OE/IAM	 LONG SHORT	
--------	---------------------------------	--

H2	SENSORE POSIZIONE ALBERO A CAM CAMSHAFT POSITION SENSOR	
----	--	--

RENAULT		
8200454170	064847177010	SAC077
8200567414	064847177010	SAC077
SAAB		
4621363	064847125010	SAC025
93190702	064847168010	SAC068
SIDAT		
38222	064847174010	SAC074
83017	064847164010	SAC064
83020	064847111010	SAC011
83097	064847148010	SAC048
83184	064847163010	SAC063
83200	064847168010	SAC068
83201	064847193010	SAC093
83202	064847170010	SAC070
83203	064847114010	SAC014
83208	064847182010	SAC082
83209	064847103010	SAC003
83213	064847200010	SAC100
83215	064847173010	SAC073
83216	064847175010	SAC075
83218	064847180010	SAC080
83219	064847188010	SAC088
83220	064847171010	SAC071
83221	064847161010	SAC061
83226	064847194010	SAC094
83229	064847183010	SAC083
83230	064847136010	SAC036
83231	064847145010	SAC045
83236	064847124010	SAC024
83239	064847184010	SAC084
83240	064847115010	SAC015
83242	064847195010	SAC095
83243	064847159010	SAC059
83245	064847132010	SAC032
83247	064847149010	SAC049
83250	064847150010	SAC050
83251	064847142010	SAC042
83253	064847129010	SAC029
83255	064847139010	SAC039
83256	064847116010	SAC016
83259	064847135010	SAC035
83264	064847143010	SAC043
83265	064847137010	SAC037

OE/IAM	 LONG SHORT	
--------	---------------------------------	--

H2	SENSORE POSIZIONE ALBERO A CAM CAMSHAFT POSITION SENSOR	
----	--	--

SIDAT		
83266	064847144010	SAC044
83293	064847134010	SAC034
83294	064847117010	SAC017
83313	064847125010	SAC025
83323	064847121010	SAC021
83325	064847198010	SAC098
83331	064847140010	SAC040
83338	064847157010	SAC057
83340	064847138010	SAC038
83341	064847186010	SAC086
83347	064847130010	SAC030
83354	064847192010	SAC092
83355	064847166010	SAC066
83358	064847146010	SAC046
83360	064847176010	SAC076
83362	064847191010	SAC091
83364	064847162010	SAC062
83365	064847119010	SAC019
83368	064847112010	SAC012
83374	064847133010	SAC033
83375	064847165010	SAC065
83377	064847160010	SAC060
83378	064847178010	SAC078
83381	064847153010	SAC053
83389	064847147010	SAC047
83390	064847167010	SAC067
83392	064847177010	SAC077
83395	064847158010	SAC058
83396	064847141010	SAC041
83407	064847196010	SAC096
83408	064847185010	SAC085
83427	064847154010	SAC054
83443	064847120010	SAC020
83457	064847126010	SAC026
83458	064847151010	SAC051
83462	064847118010	SAC018
83464	064847189010	SAC089
83466	064847172010	SAC072
83481	064847123010	SAC023
83496	064847131010	SAC031
83505	064847156010	SAC056
83510	064847169010	SAC069
83511	064847155010	SAC055

OE/AM	MAGNETI MARELLI	
	LONG	SHORT
H2	SENSORE POSIZIONE ALBERO A CAM CAMSHAFT POSITION SENSOR	
SIDAT		
83512	064847152010	SAC052
83513	064847128010	SAC028
87086	064847179010	SAC079
83240-2	064847115011	SAC015-1
SIEMENS VDO		
5WK90551	064847161010	SAC061
5WK90551Z	064847161010	SAC061
5WK90554Z	064847146010	SAC046
5WK96052	064847132010	SAC032
5WK96060	064847171010	SAC071
5WK96060Z	064847171010	SAC071
S105570001Z	064847132010	SAC032
S105778001Z	064847171010	SAC071
SMART		
0003228V002	064847148010	SAC048
0003228V002000000	064847148010	SAC048
0003238V002	064847148010	SAC048
SSANGYONG		
0021539528	064847143010	SAC043
STANDARD		
19078	064847192010	SAC092
19111	064847172010	SAC072
SUBARU		
22056AA101	064847119010	SAC019
3322050G02	064847137010	SAC037
SUZUKI		
3322085E00	064847193010	SAC093
3322085E00000	064847193010	SAC093
3322085E01	064847193010	SAC093
3322050G00	064847137010	SAC037
3322050G00000	064847137010	SAC037
3322050G01	064847137010	SAC037
3322050G01000	064847137010	SAC037
3322050G02	064847137010	SAC037
3322050G02000	064847137010	SAC037
3322079JU0	064847188010	SAC088
3322079JU0000	064847188010	SAC088
3322085E01000	064847193010	SAC093
3322086J10	064847193010	SAC093
3322086J10000	064847193010	SAC093
3322086J20	064847193010	SAC093
3322086J20000	064847193010	SAC093
33220N86J10000	064847193010	SAC093

OE/AM	MAGNETI MARELLI	
	LONG	SHORT
H2	SENSORE POSIZIONE ALBERO A CAM CAMSHAFT POSITION SENSOR	
SUZUKI		
33220N86J20000	064847193010	SAC093
SWAG		
20924162	064847176010	SAC076
40918169	064847161010	SAC061
40928131	064847194010	SAC094
85932085	064847169010	SAC069
TOPRAN		
111392	064847185010	SAC085
206205	064847161010	SAC061
207013	064847146010	SAC046
207068	064847193010	SAC093
207418	064847162010	SAC062
500988	064847176010	SAC076
TOYOTA		
1930003010	064847153010	SAC053
1930074010	064847153010	SAC053
8941150010	064847155010	SAC055
9008019009	064847166010	SAC066
9008019014	064847160010	SAC060
9008019020	064847165010	SAC065
9008019026	064847194010	SAC094
9091905012	064847166010	SAC066
9091905024	064847186010	SAC086
9091905026	064847160010	SAC060
9091905029	064847178010	SAC078
9091905055	064847194010	SAC094
90919W5001	064847191010	SAC091
90919W5003	064847191010	SAC091
VAG		
030907601	064847111010	SAC011
036907601	064847114010	SAC014
057130767	064847194010	SAC094
070907601	064847189010	SAC089
99660610603	064847194010	SAC094
02E927321A	064847114010	SAC014
030907601D	064847111010	SAC011
036907601A	064847114010	SAC014
036907601B	064847114010	SAC014
036907601C	064847114010	SAC014
036907601D	064847114010	SAC014
038907319D	064848015010	SAG015
03C906433B	064847147010	SAC047
03D907601	064847111010	SAC011

OE/IAM	 LONG SHORT	
--------	---------------------	--

H2	SENSORE POSIZIONE ALBERO A CAM CAMSHAFT POSITION SENSOR	
----	--	--

VAG		
03G957147A	064847185010	SAC085
03G957147C	064847185010	SAC085
058905161B	064847184010	SAC084
06A905161A	064847140010	SAC040
06A905161B	064847115010	SAC015
06A905161B	064847115011	SAC015-1
06A905161C	064847115010	SAC015
06A905161C	064847115011	SAC015-1
06B905163A	064847175010	SAC075
06C905163B	064847173010	SAC073
06H905163A	064847147010	SAC047
070907601A	064847189010	SAC089
070907601B	064847189010	SAC089
07K907601A	064847167010	SAC067
VAUXHALL		
90458252	064847161010	SAC061
VEMO		
V10721099	064847114010	SAC014
V10721158	064847185010	SAC085
V20720415	064847134010	SAC034
V20720416	064847142010	SAC042
V20720474	064847176010	SAC076
V24720035	064847195010	SAC095
V24720090	064847188010	SAC088
V26720024	064847156010	SAC056
V30720118	064847116010	SAC016
V30720714	064847131010	SAC031
V40720316	064847161010	SAC061
V40720397	064847146010	SAC046
V40720406	064847193010	SAC093
V40720446	064847162010	SAC062
V46720085	064847177010	SAC077
V51720002	064847145010	SAC045
V70720013	064847165010	SAC065
V70720059	064847153010	SAC053
VOLVO		
1837835	064847196010	SAC096
8627355	064847190010	SAC090
8631533	064847194010	SAC094
30658182	064847192010	SAC092
30711105	064847196010	SAC096
30713485	064847190010	SAC090
30874179	064847130010	SAC030

OE/IAM	 LONG SHORT	
--------	---------------------	--

H2	SENSORE POSIZIONE ALBERO A CAM CAMSHAFT POSITION SENSOR	
----	--	--

VOLVO		
31216443	064847196010	SAC096
31331765	064847190010	SAC090

GRUPPO I - GROUP I

BOBINA D'ACCENSIONE IGNITION COIL

AIRTEX		
5C1243	060810195010	BAE680BA
5C1395	060810199010	BAE680BE
5C1435	060810218010	BAE680BX
5C1620	060810070010	BAE680E
5C1631	060810231010	BAE680CK
5C1748	060810237010	BAE680CQ
5C1771	060810240010	BAE680CT
BBT		
IC03101	060810189010	BAE680AU
IC03102	060810191010	BAE680AW
IC03104	060810169010	BAE680AA
IC03111	060810190010	BAE680AV
IC03112	060810194010	BAE680AZ
IC03113	060810192010	BAE680AX
IC03117	060796015010	BAE960AE
IC03118	060810161010	BAE680S
IC03121	060810171010	BAE680AC
IC03122	060810167010	BAE680Y
IC03123	060810197010	BAE680BC
IC03126	060810197010	BAE680BC
IC03127	060810234010	BAE680CN
IC03128	060810235010	BAE680CO
IC03129	060810161010	BAE680S
IC04114	060810237010	BAE680CQ
IC07102	060801008010	BAE608F
IC07104	060801011010	BAE608I
IC07109	060801012010	BAE608L
IC11100	060801013010	BAE608M
IC13100	060780002010	BAE800B
IC13101	060705604010	BAE506D
IC13102	060705404010	BAE504D
IC13103	060726001010	BZ600A
IC13104	060810090010	BAE680G
IC13105	060792001010	BAE920AX
IC13106	060740302010	BAE403B

OE/IAM

MAGNETI
MARELLI

LONG

SHORT

BOBINA D'ACCENSIONE
IGNITION COIL

BBT

IC13107	060740303010	BAE403C
IC13111	060740304010	BAE403D
IC13114	060794001010	BAE940A
IC15100	060810070010	BAE680E
IC15105	060810193010	BAE680AY
IC15111	060705754010	BAE507BK
IC15112	060705409010	BAE504L
IC15113	060708138010	BAE801AK
IC15118	060708149010	BAE801EK
IC15120	060810168010	BAE680Z
IC15135	060810241010	BAE680CU
IC15138	060810236010	BAE680CP
IC16104	060810140010	BAE680N
IC16111	060810195010	BAE680BA
IC16116	060810231010	BAE680CK
IC16122	060810166010	BAE680X
IC16123	060810225010	BAE680CE
IC16125	060810160010	BAE680R
IC16127	060810199010	BAE680BE
IC16128	060810255010	BAE680DI
IC17103	060810264010	BAE680DR
IC17113	060810202010	BAE680BH
IC17120	060810162010	BAE680T
IC17121	060810163010	BAE680U
IC17122	060810164010	BAE680V
IC17123	060810222010	BAE680CB
IC17130	060810240010	BAE680CT
IC17131	060810223010	BAE680CC
IC18100	060810173010	BAE680AE

BERU

0010100249	060705754010	BAE507BK
0040100022	060810169010	BAE680AA
0040100029	060792001010	BAE920AX
0040100047	060810169010	BAE680AA
0040100048	060810070010	BAE680E
0040100052	060810070010	BAE680E
0040100071	060810070010	BAE680E
0040100079	060794001010	BAE940A
0040100106	060690002010	BK2A
0040100230	060810165010	BAE680W
0040100231	060810242010	BAE680CV
0040100232	060810174010	BAE680AF
40100234	060810175010	BAE680AG

OE/IAM

MAGNETI
MARELLI

LONG

SHORT

BOBINA D'ACCENSIONE
IGNITION COIL

BERU

0040100237	060810173010	BAE680AE
0040100238	060810173010	BAE680AE
0040100239	060810173010	BAE680AE
0040100244	060705604010	BAE506D
0040100248	060705606010	BAE506F
0040100249	060705754010	BAE507BK
0040100250	060705409010	BAE504L
0040100256	060810193010	BAE680AY
0040100259	060801008010	BAE608F
0040100281	060810173010	BAE680AE
0040100283	060780002010	BAE800B
0040100297	060810244010	BAE680CX
0040100303	060810186010	BAE680AR
0040100304	060810179010	BAE680AK
0040100307	060810170010	BAE680AB
0040100308	060810214010	BAE680BT
0040100310	060810245010	BAE680CY
0040100311	060810181010	BAE680AM
0040100312	060810165010	BAE680W
0040100315	060708149010	BAE801EK
0040100317	060708138010	BAE801AK
0040100320	060740302010	BAE403B
0040100321	060740304010	BAE403D
0040100322	060740303010	BAE403C
0040100323	060707038010	BAE700AK
0040100325	060810241010	BAE680CU
0040100330	060705604010	BAE506D
0040100337	060810182010	BAE680AN
0040100338	060810180010	BAE680AL
0040100354	060810168010	BAE680Z
0040100387	060810270010	BAE680DX
0040102019	060810186010	BAE680AR
0040102020	060810090010	BAE680G
0040102021	060810195010	BAE680BA
0040102025	060801013010	BAE608M
0040102026	060801011010	BAE608I
0040102029	060810192010	BAE680AX
0040102030	060810189010	BAE680AU
0040102031	060810194010	BAE680AZ
0040102032	060810190010	BAE680AV
0040102034	060810191010	BAE680AW
0040102037	060810200010	BAE680BF
0040102043	060810191010	BAE680AW

OE/IAM	MAGNETI MARELLI	
	LONG	SHORT
BOBINA D'ACCENSIONE IGNITION COIL		
BERU		
0040102044	060810197010	BAE680BC
0040102059	060810167010	BAE680Y
0040102131	060810258010	BAE680DL
0040402003	060810169010	BAE680AA
0401003370	060810182010	BAE680AN
00401003380	060810180010	BAE680AL
0401020190	060810186010	BAE680AR
00401003240000	060810176010	BAE680AH
00401003580000	060810177010	BAE680AI
00401003590000	060810208010	BAE680BN
00401020550000	060810216010	BAE680BV
00401020560000	060810187010	BAE680AS
ZS029	060792001010	BAE920AX
ZS052	060810070010	BAE680E
ZS071	060810070010	BAE680E
ZS102	060690002010	BK2A
ZS106	060690002010	BK2A
ZS230	060810165010	BAE680W
ZS231	060810242010	BAE680CV
ZS232	060810174010	BAE680AF
ZS237	060810173010	BAE680AE
ZS238	060810173010	BAE680AE
ZS239	060810173010	BAE680AE
ZS244	060705604010	BAE506D
ZS249	060705754010	BAE507BK
ZS250	060705409010	BAE504L
ZS281	060810173010	BAE680AE
ZS283	060780002010	BAE800B
ZS297	060810244010	BAE680CX
ZS304	060810179010	BAE680AK
ZS307	060810170010	BAE680AB
ZS308	060810214010	BAE680BT
ZS310	060810245010	BAE680CY
ZS311	060810181010	BAE680AM
ZS315	060708149010	BAE801EK
ZS320	060740302010	BAE403B
ZS321	060740304010	BAE403D
ZS322	060740303010	BAE403C
ZS323	060707038010	BAE700AK
ZS325	060810241010	BAE680CU
ZS354	060810168010	BAE680Z
ZS387	060810270010	BAE680DX
ZSE003	060810169010	BAE680AA

OE/IAM	MAGNETI MARELLI	
	LONG	SHORT
BOBINA D'ACCENSIONE IGNITION COIL		
BERU		
ZSE019	060810186010	BAE680AR
ZSE029	060810192010	BAE680AX
ZSE030	060810189010	BAE680AU
ZSE031	060810194010	BAE680AZ
ZSE032	060810190010	BAE680AV
ZSE034	060810191010	BAE680AW
ZSE040	060796115010	BAE961AE
ZSE043	060810191010	BAE680AW
ZSE044	060810197010	BAE680BC
ZSE059	060810167010	BAE680Y
ZSE066	060810236010	BAE680CP
ZSE131	060810258010	BAE680DL
ZSE303	060810186010	BAE680AR
BMW		
12131247281	060810170010	BAE680AB
12131712219	060810176010	BAE680AH
12131720166	060810260010	BAE680DN
12131726176	060810260010	BAE680DN
12131726177	060810260010	BAE680DN
12131726178	060810260010	BAE680DN
12131748394	060810260010	BAE680DN
12131748395	060810260010	BAE680DN
12131777666	060810260010	BAE680DN
12137523345	060810210010	BAE680BP
12137548553	060810210010	BAE680BP
12137551260	060810176010	BAE680AH
12137562744	060810212010	BAE680BR
12137571643	060810212010	BAE680BR
12137571644	060810213010	BAE680BS
12137582627	060810213010	BAE680BS
12137594935	060810213010	BAE680BS
12137594936	060810210010	BAE680BP
12137594937	060810212010	BAE680BR
12137594938	060810176010	BAE680AH
12139066468	060810260010	BAE680DN
XXXX7562745	060810213010	BAE680BS
BOSCH		
0221102012	060690002010	BK2A
0221119025	060690002010	BK2A
0221119027	060690002010	BK2A
0221502003	060810242010	BAE680CV
0221503007	060810174010	BAE680AF
0221503014	060810177010	BAE680AI

OE/IAM

MAGNETI
MARELLI

LONG

SHORT

BOBINA D'ACCENSIONE
IGNITION COIL

BOSCH

0221503015	060810178010	BAE680AJ
0221503022	060810179010	BAE680AK
0221503027	060810204010	BAE680BJ
0221503031	060810205010	BAE680BK
0221503033	060810243010	BAE680CW
0221503035	060810244010	BAE680CX
0221503407	060810175010	BAE680AG
0221503417	060810165010	BAE680W
0221503468	060810206010	BAE680BL
0221503469	060810207010	BAE680BM
0221503471	060810208010	BAE680BN
0221503472	060810180010	BAE680AL
0221503473	060810228010	BAE680CH
0221503485	060810270010	BAE680DX
0221503487	060810209010	BAE680BO
0221503489	060810170010	BAE680AB
0221503490	060810220010	BAE680BZ
0221504006	060810245010	BAE680CY
0221504014	060810181010	BAE680AM
0221504017	060810182010	BAE680AN
0221504019	060810263010	BAE680DQ
0221504020	060810183010	BAE680AO
0221504024	060810211010	BAE680BQ
0221504031	060810247010	BAE680DA
0221504035	060810248010	BAE680DB
0221504036	060810224010	BAE680CD
0221504456	060810184010	BAE680AP
0221504460	060740304010	BAE403D
0221504461	060810257010	BAE680DK
0221504464	060810176010	BAE680AH
0221504465	060810210010	BAE680BP
0221504470	060810212010	BAE680BR
0221504471	060810213010	BAE680BS
0221504473	060810257010	BAE680DK
0221504474	060810260010	BAE680DN
0221505423	060810214010	BAE680BT
0221506001	060810249010	BAE680DC
0221506004	060810250010	BAE680DD
0221506007	060810251010	BAE680DE
0221601012	060810200010	BAE680BF
0221603003	060810185010	BAE680AQ
0221603006	060810169010	BAE680AA
0221603010	060810169010	BAE680AA

OE/IAM

MAGNETI
MARELLI

LONG

SHORT

BOBINA D'ACCENSIONE
IGNITION COIL

BOSCH

0221604006	060810215010	BAE680BU
0221604008	060810186010	BAE680AR
0221604010	060810216010	BAE680BV
0221604011	060810216010	BAE680BV
0221604014	060810187010	BAE680AS
0221604025	060810271010	BAE680DY
0221604103	060810188010	BAE680AT
0221604112	060810226010	BAE680CF
0221604115	060810196010	BAE680BB
0221604116	060810196010	BAE680BB
0986221001	060810070010	BAE680E
0986221003	060792001010	BAE920AX
0986221023	060810189010	BAE680AU
0986221024	060810191010	BAE680AW
0986221027	060705604010	BAE506D
0986221028	060705606010	BAE506F
0986221029	060705754010	BAE507BK
0986221033	060708149010	BAE801EK
0986221037	060705404010	BAE504D
0986221038	060726001010	BZ600A
0986221039	060801008010	BAE608F
0986221042	060740302010	BAE403B
0986221043	060740303010	BAE403C
0986221045	060810070010	BAE680E
0986221046	060810241010	BAE680CU
0986221047	060810167010	BAE680Y
0986221048	060810169010	BAE680AA
0986221049	060810192010	BAE680AX
0986221050	060810194010	BAE680AZ
0986221053	060810171010	BAE680AC
0986221056	060810197010	BAE680BC
0986221057	060810234010	BAE680CN
0986221058	060810237010	BAE680CQ
0986221061	060810236010	BAE680CP
1227022000	060810169010	BAE680AA
9220081505	060705409010	BAE504L
0986JG1211	060810195010	BAE680BA
0986JG1213	060810199010	BAE680BE
0986JG1216	060810140010	BAE680N
0986JG1225	060810229010	BAE680CI
F000ZS0103	060780002010	BAE800B
F000ZS0116	060810262010	BAE680DP
F000ZS0210	060810169010	BAE680AA

OE/IAM	MAGNETT MARELLI	
	LONG	SHORT
BOBINA D'ACCENSIONE IGNITION COIL		
BOSCH		
F000ZS0212	060810173010	BAE680AE
F000ZS0221	060810168010	BAE680Z
F000ZS1187	060810169010	BAE680AA
F000ZS9200	060801011010	BAE608I
F005X11781	060801013010	BAE608M
F005X11798	060810202010	BAE680BH
F005X11800	060810231010	BAE680CK
F005X11801	060810225010	BAE680CE
F00ZS0212	060810173010	BAE680AE
ZS-K1X2	060780002010	BAE800B
BOUGICORD		
151408	060810241010	BAE680CU
155001	060810245010	BAE680CY
155003	060810177010	BAE680AI
155008	060810209010	BAE680BO
155011	060810173010	BAE680AE
155012	060810192010	BAE680AX
155015	060708149010	BAE801EK
155016	060810168010	BAE680Z
155017	060780002010	BAE800B
155020	060740303010	BAE403C
155023	060740304010	BAE403D
155028	060810202010	BAE680BH
155039	060801012010	BAE608L
155048	060801013010	BAE608M
155051	060792001010	BAE920AX
155052	060801011010	BAE608I
155054	060810197010	BAE680BC
155056	060705604010	BAE506D
155058	060705404010	BAE504D
155059	060705754010	BAE507BK
155060	060705409010	BAE504L
155065	060705606010	BAE506F
155074	060794001010	BAE940A
155075	060810270010	BAE680DX
155078	060801009010	BAE608G
155081	060726001010	BZ600A
155087	060810195010	BAE680BA
155093	060810162010	BAE680T
155100	060810260010	BAE680DN
155104	060810167010	BAE680Y
155106	060810161010	BAE680S
155107	060801014010	BAE608N

OE/IAM	MAGNETT MARELLI	
	LONG	SHORT
BOBINA D'ACCENSIONE IGNITION COIL		
BOUGICORD		
155110	060810171010	BAE680AC
155113	060810163010	BAE680U
155140	060810222010	BAE680CB
155141	060810223010	BAE680CC
155143	060810236010	BAE680CP
155147	060810233010	BAE680CM
155175	060810227010	BAE680CG
155176	060810225010	BAE680CE
155177	060810164010	BAE680V
155179	060810264010	BAE680DR
155184	060810219010	BAE680BY
156100	060810169010	BAE680AA
156200	060810070010	BAE680E
156300	060801008010	BAE608F
156600	060707038010	BAE700AK
157100	060810090010	BAE680G
157200	060796115010	BAE961AE
157300	060740302010	BAE403B
157400	060810189010	BAE680AU
157500	060810191010	BAE680AW
157700	060810190010	BAE680AV
157800	060810194010	BAE680AZ
BREMI		
11720	060810168010	BAE680Z
11727	060810165010	BAE680W
11730	060810173010	BAE680AE
11731	060810169010	BAE680AA
11801	060690002010	BK2A
11873	060810244010	BAE680CX
11875	060810173010	BAE680AE
11880	060705754010	BAE507BK
11881	060810242010	BAE680CV
11882	060810174010	BAE680AF
11883	060810175010	BAE680AG
11897	060705606010	BAE506F
11898	060705604010	BAE506D
11899	060780002010	BAE800B
11900	060705404010	BAE504D
11909	060690002010	BK2A
11913	060810173010	BAE680AE
11917	060705409010	BAE504L
11929	060792001010	BAE920AX
11937	060810173010	BAE680AE

OE/AM

MAGNETI
MARELLI

LONG

SHORT

BOBINA D'ACCENSIONE
IGNITION COIL**BREMI**

12433	060810191010	BAE680AW
20111	060810070010	BAE680E
20113	060810191010	BAE680AW
20116	060810167010	BAE680Y
20117	060810189010	BAE680AU
20121	060810161010	BAE680S
20122	060810197010	BAE680BC
20125	060810171010	BAE680AC
20129	060810192010	BAE680AX
20131	060810195010	BAE680BA
20136	060801008010	BAE608F
20138	060801013010	BAE608M
20142	060708149010	BAE801EK
20152	060810264010	BAE680DR
20160	060801011010	BAE608I
20162	060810265010	BAE680DS
20164	060810162010	BAE680T
20176	060810270010	BAE680DX
20187	060810090010	BAE680G
20191	060810202010	BAE680BH
20192	060810140010	BAE680N
20198	060810219010	BAE680BY
20200	060708138010	BAE801AK
20317	060810218010	BAE680BX
20323	060810222010	BAE680CB
20331	060810197010	BAE680BC
20337	060810199010	BAE680BE
20339	060810163010	BAE680U
20344	060810164010	BAE680V
20380	060740302010	BAE403B
20386	060810227010	BAE680CG
20400	060810225010	BAE680CE
20443	060810240010	BAE680CT
880013	060810242010	BAE680CV
12465ESM	060810161010	BAE680S
12497T	060810190010	BAE680AV
CADILLAC		
12629037	060810226010	BAE680CF
90584337	060810204010	BAE680BJ

OE/AM

MAGNETI
MARELLI

LONG

SHORT

BOBINA D'ACCENSIONE
IGNITION COIL**CHAMPION**

AMC920A	060792001010	BAE920AX
BAE403B/002	060740302010	BAE403B
BAE403C/002	060740303010	BAE403C
BAE403D/002	060740304010	BAE403D
BAE408AE	060810189010	BAE680AU
BAE408AE/245	060810189010	BAE680AU
BAE504D/002	060705404010	BAE504D
BAE504F/002	060705406010	BAE504F
BAE504L/002	060705409010	BAE504L
BAE506D/002	060705604010	BAE506D
BAE506F/002	060705606010	BAE506F
BAE507AK/002	060705738010	BAE507AK
BAE507BK/002	060705754010	BAE507BK
BAE700AK/002	060707038010	BAE700AK
BAE800B	060780002010	BAE800B
BAE801AK/002	060708138010	BAE801AK
BAE801EK/002	060708149010	BAE801EK
BAE907AE	060810169010	BAE680AA
BAE907AE/245	060810169010	BAE680AA
BAE940A/245	060794001010	BAE940A
BAE960AE/002	060796015010	BAE960AE
BAE961AE/002	060796115010	BAE961AE
BAE965A/245	060801008010	BAE608F

DACIA

6000581617	060810175010	BAE680AG
6001543604	060810168010	BAE680Z
6001544755	060810168010	BAE680Z
7700274008	060810168010	BAE680Z
224336134R	060810168010	BAE680Z

DAEWOO

88921374	060801013010	BAE608M
96350585	060801013010	BAE608M

DELPHI

19005252	060801013010	BAE608M
CE1000012B1	060801008010	BAE608F
CE1000112B1	060801009010	BAE608G
CE10103	060780002010	BAE800B
CE10106	060690002010	BK2A
CE2000912B1	060801012010	BAE608L
CE2001412B1	060810070010	BAE680E
CE2002412B1	060810193010	BAE680AY
CE2004812B1	060810168010	BAE680Z
CE2005412B1	060707038010	BAE700AK

OE/IAM	MAGNETI MARELLI	
	LONG	SHORT

BOBINA D'ACCENSIONE IGNITION COIL		
--------------------------------------	--	--

DELPHI		
CE2005612B1	060740303010	BAE403C
CE2005712B1	060740304010	BAE403D
CE2005812B1	060780002010	BAE800B
CE2006012B1	060705754010	BAE507BK
CE2006112B1	060792001010	BAE920AX
CE2006212B1	060740302010	BAE403B
DC1000012B1	060801010010	BAE608H
DS1000012B1	060801011010	BAE608I
DS2001312B1	060801013010	BAE608M
DS2002611B1	060801014010	BAE608N
GN1001811B1	060810169010	BAE680AA
GN1002411B1	060810261010	BAE680DO
GN1006811B1	060810262010	BAE680DP
GN1017712B1	060810173010	BAE680AE
GN1019512B1	060810167010	BAE680Y
GN1020512B1	060810270010	BAE680DX
GN1020812B1	060810161010	BAE680S
GN1023112B1	060810238010	BAE680CR
GN1023212B1	060810252010	BAE680DF
GN1023412B1	060810239010	BAE680CS
GN1023512B1	060810237010	BAE680CQ
GN1023912B1	060810221010	BAE680CA
GN1024012B1	060810198010	BAE680BD

DENSO		
011220141	060810166010	BAE680X
011220210	060810162010	BAE680T
011220220	060810163010	BAE680U
011220240	060810218010	BAE680BX
011220350	060810164010	BAE680V
30280370	060810219010	BAE680BY
0297000651	060690002010	BK2A
0297002143	060690002010	BK2A
0297005430	060810265010	BAE680DS
0297006700	060810173010	BAE680AE
297006700	060810173010	BAE680AE
0297007951	060810264010	BAE680DR
0297008291	060810070010	BAE680E
0297008391	060810233010	BAE680CM
DIC0100	060810222010	BAE680CB
DIC0101	060810202010	BAE680BH
DIC0102	060810223010	BAE680CC
DIC0103	060810240010	BAE680CT
DIC0104	060810227010	BAE680CG

OE/IAM	MAGNETI MARELLI	
	LONG	SHORT

BOBINA D'ACCENSIONE IGNITION COIL		
--------------------------------------	--	--

DENSO		
DIC0105	060810225010	BAE680CE
DIC0106	060810219010	BAE680BY
ERA		
880003	060810169010	BAE680AA
880005	060810192010	BAE680AX
880006	060810189010	BAE680AU
880007	060810191010	BAE680AW
880008	060780002010	BAE800B
880009	060810070010	BAE680E
880011	060810090010	BAE680G
880012	060705604010	BAE506D
880013	060810242010	BAE680CV
880014	060810174010	BAE680AF
880016	060810193010	BAE680AY
880025	060705606010	BAE506F
880026	060705754010	BAE507BK
880027	060705409010	BAE504L
880033	060796115010	BAE961AE
880038	060740302010	BAE403B
880039	060801008010	BAE608F
880040	060801011010	BAE608I
880042	060726001010	BZ600A
880043	060792001010	BAE920AX
880044	060801013010	BAE608M
880046	060810260010	BAE680DN
880048	060810173010	BAE680AE
880049	060810220010	BAE680BZ
880051	060708149010	BAE801EK
880053	060810262010	BAE680DP
880058	060810168010	BAE680Z
880060	060708138010	BAE801AK
880062	060810179010	BAE680AK
880065	060810190010	BAE680AV
880066	060810194010	BAE680AZ
880068	060740303010	BAE403C
880071	060810202010	BAE680BH
880075	060801009010	BAE608G
880076	060810195010	BAE680BA
880078	060810177010	BAE680AI
880089	060707038010	BAE700AK
880090	060705404010	BAE504D
880091	060794001010	BAE940A
880093	060740304010	BAE403D

OE/IAM	MAGNETI MARELLI	
	LONG	SHORT
BOBINA D'ACCENSIONE IGNITION COIL		
ERA		
880094	060796015010	BAE960AE
880095	060810198010	BAE680BD
880096	060810243010	BAE680CW
880097	060810244010	BAE680CX
880098	060810182010	BAE680AN
880099	060810263010	BAE680DQ
880100	060810200010	BAE680BF
880102	060810245010	BAE680CY
880103	060810270010	BAE680DX
880108	060810181010	BAE680AM
880109	060810175010	BAE680AG
880111	060690002010	BK2A
880122	060810197010	BAE680BC
880123	060810214010	BAE680BT
880126	060810269010	BAE680DW
880132	060810184010	BAE680AP
880133	060810186010	BAE680AR
880134	060810188010	BAE680AT
880140	060810162010	BAE680T
880148	060810166010	BAE680X
880153	060801012010	BAE608L
880155	060810160010	BAE680R
880159	060810140010	BAE680N
880161	060810232010	BAE680CL
880166	060810167010	BAE680Y
880169	060810215010	BAE680BU
880176	060801014010	BAE608N
880188	060810163010	BAE680U
880200	060810212010	BAE680BR
880207	060810261010	BAE680DO
880208	060810170010	BAE680AB
880211	060810241010	BAE680CU
880213	060810187010	BAE680AS
880243	060810222010	BAE680CB
880245	060810223010	BAE680CC
880247	060810219010	BAE680BY
880257	060810227010	BAE680CG
880258	060810225010	BAE680CE
880264	060810229010	BAE680CI
880267	060810171010	BAE680AC
880270	060810161010	BAE680S
880273	060810164010	BAE680V
880274	060810236010	BAE680CP

OE/IAM	MAGNETI MARELLI	
	LONG	SHORT
BOBINA D'ACCENSIONE IGNITION COIL		
ERA		
880276	060810226010	BAE680CF
880278	060810211010	BAE680BQ
880281	060810264010	BAE680DR
880290	060810265010	BAE680DS
880291	060810233010	BAE680CM
880293	060810216010	BAE680BV
880296	060810173010	BAE680AE
880299	060810197010	BAE680BC
880302	060810199010	BAE680BE
880306	060810218010	BAE680BX
880318	060810255010	BAE680DI
880332	060810221010	BAE680CA
880334	060810240010	BAE680CT
880338	060810213010	BAE680BS
880339	060810234010	BAE680CN
880345	060810235010	BAE680CO
880346	060810238010	BAE680CR
880347	060810239010	BAE680CS
880348	060810237010	BAE680CQ
880374	060810224010	BAE680CD
880375	060810248010	BAE680DB
880377	060810258010	BAE680DL
880386	060810252010	BAE680DF
880418	060810271010	BAE680DY
880419	060810257010	BAE680DK
880006HQ	060810189010	BAE680AU
880048B	060810173010	BAE680AE
880071HQ	060810202010	BAE680BH
880243HQ	060810222010	BAE680CB
880245B	060810223010	BAE680CC
880247B	060810219010	BAE680BY
880257B	060810227010	BAE680CG
880257HQ	060810227010	BAE680CG
880258HQ	060810225010	BAE680CE
880281B	060810264010	BAE680DR
880290B	060810265010	BAE680DS
990258B	060810225010	BAE680CE
A88003	060810169010	BAE680AA
A88005	060810192010	BAE680AX
A88007	060810191010	BAE680AW
A88048	060810173010	BAE680AE
A88058	060810168010	BAE680Z
A88065	060810190010	BAE680AV

OE/IAM	MAGNETI MARELLI	
	LONG	SHORT

BOBINA D'ACCENSIONE IGNITION COIL		
--------------------------------------	--	--

ERA		
A88066	060810194010	BAE680AZ
A88071	060810202010	BAE680BH
FACET		
90005	060705404010	BAE504D
96001	060690002010	BK2A
96001	060690002010	BK2A
96002	060705606010	BAE506F
96004	060726001010	BZ600A
96008	060705604010	BAE506D
96018	060810173010	BAE680AE
96035	060810173010	BAE680AE
96038	060690002010	BK2A
96046	060780002010	BAE800B
96048	060705404010	BAE504D
96055	060705754010	BAE507BK
96055	060705754010	BAE507BK
96058	060705606010	BAE506F
96068	060810175010	BAE680AG
96071	060810165010	BAE680W
96088	060810174010	BAE680AF
96089	060810242010	BAE680CV
96096	060708149010	BAE801EK
96097	060810265010	BAE680DS
96114	060810262010	BAE680DP
96121	060810261010	BAE680DO
96128	060705409010	BAE504L
96175	060708138010	BAE801AK
96199	060810173010	BAE680AE
96207	060810170010	BAE680AB
96213	060810184010	BAE680AP
96214	060810245010	BAE680CY
96245	060792001010	BAE920AX
96245	060792001010	BAE920AX
96263	060810173010	BAE680AE
96264	060810173010	BAE680AE
96277	060810168010	BAE680Z
96282	060810181010	BAE680AM
96284	060810090010	BAE680G
96298	060810177010	BAE680AI
96299	060801008010	BAE608F
96314	060810179010	BAE680AK
96317	060810244010	BAE680CX
96323	060794001010	BAE940A

OE/IAM	MAGNETI MARELLI	
	LONG	SHORT

BOBINA D'ACCENSIONE IGNITION COIL		
--------------------------------------	--	--

FACET		
96327	060810190010	BAE680AV
96329	060810191010	BAE680AW
96331	060810167010	BAE680Y
96334	060810197010	BAE680BC
96335	060810161010	BAE680S
96336	060810171010	BAE680AC
96342	060740303010	BAE403C
96348	060810186010	BAE680AR
96350	060801012010	BAE608L
96357	060810231010	BAE680CK
96359	060810202010	BAE680BH
96361	060810222010	BAE680CB
96366	060810223010	BAE680CC
96374	060810189010	BAE680AU
96378	060810216010	BAE680BV
96380	060810269010	BAE680DW
96381	060810270010	BAE680DX
96383	060810221010	BAE680CA
96387	060810237010	BAE680CQ
96389	060810187010	BAE680AS
96418	060810241010	BAE680CU
96429	060810229010	BAE680CI
96432	060810220010	BAE680BZ
96435	060810219010	BAE680BY
96452	060810255010	BAE680DI
96481	060810164010	BAE680V
96486	060810163010	BAE680U
98118	060801013010	BAE608M
98120	060810169010	BAE680AA
470108	060705604010	BAE506D
470158	060705606010	BAE506F
1970146	060780002010	BAE800B
1970275	060708138010	BAE801AK
1970135EPS	060810173010	BAE680AE
1970197EPS	060810265010	BAE680DS
1970377EPS	060810168010	BAE680Z
1990420EPS	060810169010	BAE680AA
470135KW	060810173010	BAE680AE
470197KW	060810265010	BAE680DS
470377KW	060810168010	BAE680Z
490420KW	060810169010	BAE680AA
96001D	060690002010	BK2A
96062S	060810260010	BAE680DN

OE/IAM	MAGNETI MARELLI	
	LONG	SHORT
BOBINA D'ACCENSIONE IGNITION COIL		
FACET		
96199S	060810173010	BAE680AE
96286K	060810249010	BAE680DC
B007	060810192010	BAE680AX
FAE		
80201	060810189010	BAE680AU
80202	060810191010	BAE680AW
80209	060801008010	BAE608F
80213	060810173010	BAE680AE
80218	060810169010	BAE680AA
80222	060810168010	BAE680Z
80237	060810193010	BAE680AY
80242	060810202010	BAE680BH
80270	060810192010	BAE680AX
FCA		
134386	060810175010	BAE680AG
143216	060690002010	BK2A
510897	060690002010	BK2A
4071394	060690002010	BK2A
4384184	060690002010	BK2A
4439396	060726001010	BZ600A
4460205	060690002010	BK2A
7553120	060705606010	BAE506F
7582152	060705604010	BAE506D
7588435	060705404010	BAE504D
7646974	060705606010	BAE506F
7648797	060810175010	BAE680AG
7672018	060780002010	BAE800B
07694335	060705406010	BAE504F
7698431	060705604010	BAE506D
7746151	060705404010	BAE504D
7746152	060705604010	BAE506D
7746153	060705606010	BAE506F
7746154	060705604010	BAE506D
7753777	060705406010	BAE504F
7789346	060792001010	BAE920AX
46403328	060810245010	BAE680CY
46446039	060792001010	BAE920AX
46467542	060810181010	BAE680AM
46469918	060810250010	BAE680DD
46472440	060792001010	BAE920AX
46473849	060810090010	BAE680G
46480361	060792001010	BAE920AX
46543562	060780002010	BAE800B

OE/IAM	MAGNETI MARELLI	
	LONG	SHORT
BOBINA D'ACCENSIONE IGNITION COIL		
FCA		
46548037	060780002010	BAE800B
46776830	060740304010	BAE403D
46777286	060740302010	BAE403B
46777287	060740304010	BAE403D
46777288	060740303010	BAE403C
46794782	060810188010	BAE680AT
55180004	060740302010	BAE403B
55200112	060794001010	BAE940A
55200486	060794001010	BAE940A
55208723	060794001010	BAE940A
55209603	060810211010	BAE680BQ
55213613	060810211010	BAE680BQ
55224494	060810211010	BAE680BQ
55229959	060810224010	BAE680CD
55231256	060810248010	BAE680DB
60558152	060810175010	BAE680AG
60562701	060810184010	BAE680AP
60564142	060810165010	BAE680W
60605306	060810249010	BAE680DC
60666953	060810251010	BAE680DE
0060744199	060690002010	BK2A
60808059	060810165010	BAE680W
60809492	060780002010	BAE800B
60809606	060810175010	BAE680AG
60810690	060810184010	BAE680AP
60815150	060780002010	BAE800B
71739285	060801014010	BAE608N
71742420	060810219010	BAE680BY
76487970	060810175010	BAE680AG
82303852	060690002010	BK2A
477084200	060705406010	BAE504F
571084200	060707038010	BAE700AK
9607405480	060810174010	BAE680AF
9622889780	060810174010	BAE680AF
9633001580	060810198010	BAE680BD
9664401880	060810198010	BAE680BD
GCL110	060690002010	BK2A
FEBI BILSTEIN		
19032	060810169010	BAE680AA
19929	060780002010	BAE800B
21524	060810168010	BAE680Z
21529	060708149010	BAE801EK
21579	060810173010	BAE680AE

OE/IAM	MAGNETI MARELLI	
	LONG	SHORT
BOBINA D'ACCENSIONE IGNITION COIL		
FEBI BILSTEIN		
21666	060810070010	BAE680E
22040	060810191010	BAE680AW
22389	060801008010	BAE608F
22697	060792001010	BAE920AX
22875	060708138010	BAE801AK
23260	060810190010	BAE680AV
24106	060810191010	BAE680AW
24500	060810167010	BAE680Y
26014	060801011010	BAE608I
28108	060801012010	BAE608L
32054	060810240010	BAE680CT
36430	060810221010	BAE680CA
37423	060810239010	BAE680CS
FORD		
1008886	060810173010	BAE680AE
1008887	060810173010	BAE680AE
1010139	060810220010	BAE680BZ
1018139	060810173010	BAE680AE
1018140	060810173010	BAE680AE
1034620	060810220010	BAE680BZ
1052492	060810220010	BAE680BZ
1053904	060810220010	BAE680BZ
1066102	060810220010	BAE680BZ
1067601	060810220010	BAE680BZ
1075786	060810220010	BAE680BZ
1078349	060810220010	BAE680BZ
1119835	060810220010	BAE680BZ
1130402	060810220010	BAE680BZ
1223293	060810215010	BAE680BU
1224925	060810269010	BAE680DW
1314271	060810269010	BAE680DW
1317972	060810220010	BAE680BZ
1319788	060810220010	BAE680BZ
1322402	060810269010	BAE680DW
1350562	060810270010	BAE680DX
1350567	060810209010	BAE680BO
1404981	060810233010	BAE680CM
1458400	060810209010	BAE680BO
1459278	060810270010	BAE680DX
1578771	060810269010	BAE680DW
1619343	060810220010	BAE680BZ
1649067	060810173010	BAE680AE
1682188	060810271010	BAE680DY

OE/IAM	MAGNETI MARELLI	
	LONG	SHORT
BOBINA D'ACCENSIONE IGNITION COIL		
FORD		
1716750	060810233010	BAE680CM
1727629	060810270010	BAE680DX
1754514	060810270010	BAE680DX
1823596	060810270010	BAE680DX
5047437	060810269010	BAE680DW
6181956	060810173010	BAE680AE
6485688	060810214010	BAE680BT
6503277	060810173010	BAE680AE
6503278	060810173010	BAE680AE
6503279	060810173010	BAE680AE
6503280	060810173010	BAE680AE
6503377	060810173010	BAE680AE
6823318	060810173010	BAE680AE
6860288	060810173010	BAE680AE
6860289	060810173010	BAE680AE
17SG12029AC	060810220010	BAE680BZ
1S7G12029AB	060810220010	BAE680BZ
1S7G12029AC	060810220010	BAE680BZ
2S7G12029AB	060810215010	BAE680BU
2S7G12029AC	060810215010	BAE680BU
4M5E12A366AA	060810269010	BAE680DW
4M5G12029ZA	060810270010	BAE680DX
4M5G12029ZB	060810270010	BAE680DX
4M5G12A366BA	060810269010	BAE680DW
4M5G12A366BB	060810269010	BAE680DW
4M5G12A366BC	060810269010	BAE680DW
4M5G12A366BD	060810269010	BAE680DW
4M5U12A366BC	060810269010	BAE680DW
4S7G12029AA	060810209010	BAE680BO
4S7G12029AB	060810209010	BAE680BO
6E5G12A366AD	060810233010	BAE680CM
6E5G12A366AE	060810233010	BAE680CM
88F12029A1A	060810173010	BAE680AE
88SF12029A1A	060810173010	BAE680AE
88SF12029A2A	060810173010	BAE680AE
88SF12029AA	060810173010	BAE680AE
89BF12024A1B	060810173010	BAE680AE
8SF120291A	060810173010	BAE680AE
91XF12029AA	060810214010	BAE680BT
91XF12029BA	060810214010	BAE680BT
928F12029CA	060810173010	BAE680AE
938F12024DA	060810173010	BAE680AE
96FB12257AB	060810173010	BAE680AE

OE/IAM

MAGNETI
MARELLI

LONG

SHORT

BOBINA D'ACCENSIONE
IGNITION COIL

FORD

988F12024AB	060810220010	BAE680BZ
988F12029AA	060810220010	BAE680BZ
988F12029AB	060810220010	BAE680BZ
988F12029AC	060810220010	BAE680BZ
988F12029BA	060810220010	BAE680BZ
98BF12024AB	060810220010	BAE680BZ
A96BF12024A1B	060810173010	BAE680AE
A988F12029AD	060810220010	BAE680BZ
AG9G12A366BB	060810271010	BAE680DY
AM5E12A366AA	060810269010	BAE680DW
AM5E12A366AB	060810269010	BAE680DW
CM5G12029FA	060810270010	BAE680DX
CM5G12029FB	060810270010	BAE680DX
CM5Q12029FC	060810270010	BAE680DX
E8TF12029AA	060810173010	BAE680AE
E8TZ12029A	060810173010	BAE680AE
E9TF12029AA	060810173010	BAE680AE
F1VU12029A1A	060810173010	BAE680AE
F1VU12029A2A	060810173010	BAE680AE
F1VY12029A	060810173010	BAE680AE
F37U12029AA	060810173010	BAE680AE
F37Z12029A	060810173010	BAE680AE
F5LU12029AA	060810173010	BAE680AE
F5LY12029A	060810173010	BAE680AE
F5OU12029AA	060810173010	BAE680AE
F5OY12029B	060810173010	BAE680AE
F5RZ12029C	060810173010	BAE680AE
XS8212029AA	060810220010	BAE680BZ
YM2F12029AD	060810220010	BAE680BZ
YMF212029AB	060810220010	BAE680BZ
YX8212029AA	060810220010	BAE680BZ

GENERAL MOTORS

1104038	060801013010	BAE608M
19005212	060801008010	BAE608F
55561655	060810239010	BAE680CS
94840127	060810265010	BAE680DS
94847392	060810265010	BAE680DS
104577870	060801009010	BAE608G

HELLA

5DA006623721	060810169010	BAE680AA
5DA749475001	060780002010	BAE800B
5DA749475031	060810168010	BAE680Z
5DA749475091	060792001010	BAE920AX

OE/IAM

MAGNETI
MARELLI

LONG

SHORT

BOBINA D'ACCENSIONE
IGNITION COIL

HELLA

5DA749475151	060810173010	BAE680AE
5DA749475171	060810169010	BAE680AA
5DA749475191	060801011010	BAE608I
5DA749475241	060801013010	BAE608M
5DA749475321	060708149010	BAE801EK
5DA749475331	060708138010	BAE801AK
5DA749475411	060810270010	BAE680DX
5DA749475751	060810202010	BAE680BH
5DA749475781	060810070010	BAE680E
5DA749475811	060801008010	BAE608F
5DA749475821	060810169010	BAE680AA
5DA749475891	060810222010	BAE680CB
5DA749475901	060810223010	BAE680CC
5DA749475911	060810240010	BAE680CT
5DA749475921	060810227010	BAE680CG
5DA749475931	060810202010	BAE680BH

HERTH+BUSS ELPARTS

19020004	060690002010	BK2A
19020008	060780002010	BAE800B
19020030	060810168010	BAE680Z
19050001	060810191010	BAE680AW
19050019	060810070010	BAE680E
19050020	060810190010	BAE680AV
19050025	060801008010	BAE608F

HITACHI

AIC4001G	060810199010	BAE680BE
C1Z500	060690002010	BK2A
C1Z500E	060690002010	BK2A
CM11109	060810229010	BAE680CI
CM11109C	060810229010	BAE680CI
CM11109D	060810229010	BAE680CI
CM11202	060810090010	BAE680G
CM11205B	060810195010	BAE680BA
CM11207AC	060810231010	BAE680CK
HEXEXA2408N	060810255010	BAE680DI
HEXEXA4001G	060810199010	BAE680BE
HEXEXM2851G	060810232010	BAE680CL
U08001COIL	060810195010	BAE680BA
U09001COIL	060810231010	BAE680CK
U09007COIL	060810229010	BAE680CI

OE/IAM	MAGNETI MARELLI	
	LONG	SHORT
BOBINA D'ACCENSIONE IGNITION COIL		
HONDA		
30500PTZ005	060810262010	BAE680DP
30510P73A01	060810262010	BAE680DP
30510P73A02	060810262010	BAE680DP
30510PT2006	060810262010	BAE680DP
30520PDFE11	060810263010	BAE680DQ
30520PNA007	060810225010	BAE680CE
30520PRA007	060810225010	BAE680CE
30520PWA003	060810229010	BAE680CI
30520RAA007	060810225010	BAE680CE
30520RCAA02	060810231010	BAE680CK
30520RRA007	060810225010	BAE680CE
HYUNDAI		
2730039800	060810218010	BAE680BX
2730122600	060810162010	BAE680T
2730123700	060810164010	BAE680V
2730126600	060810163010	BAE680U
INFINITI		
2244831U06	060810140010	BAE680N
2244831U16	060810140010	BAE680N
INTERMOTOR		
11080	060690002010	BK2A
11200	060690002010	BK2A
12304	060705754010	BAE507BK
12596	060810168010	BAE680Z
12601	060705604010	BAE506D
12613	060810174010	BAE680AF
12614	060810173010	BAE680AE
12616	060810242010	BAE680CV
12619	060780002010	BAE800B
12646	060708149010	BAE801EK
12647	060810265010	BAE680DS
12662	060705409010	BAE504L
12679	060708138010	BAE801AK
12699	060810173010	BAE680AE
12700	060792001010	BAE920AX
12703	060810173010	BAE680AE
12723	060801008010	BAE608F
12726	060810192010	BAE680AX
12728	060810191010	BAE680AW
12858	060810221010	BAE680CA
12919	060810169010	BAE680AA

OE/IAM	MAGNETI MARELLI	
	LONG	SHORT
BOBINA D'ACCENSIONE IGNITION COIL		
KAGER		
000912	060810169010	BAE680AA
000915	060810191010	BAE680AW
600001	060810192010	BAE680AX
600006	060705604010	BAE506D
600007	060740302010	BAE403B
600009	060810202010	BAE680BH
600020	060810191010	BAE680AW
600026	060810090010	BAE680G
600032	060726001010	BZ600A
600042	060810168010	BAE680Z
600044	060792001010	BAE920AX
600054	060705404010	BAE504D
600059	060810169010	BAE680AA
600073	060740303010	BAE403C
600076	060810190010	BAE680AV
600080	060801008010	BAE608F
600081	060801013010	BAE608M
600082	060780002010	BAE800B
600084	060705606010	BAE506F
600105	060810197010	BAE680BC
600109	060794001010	BAE940A
600111	060740304010	BAE403D
KIA		
2730039800	060810218010	BAE680BX
2730126600	060810163010	BAE680U
0K30E1810X	060810166010	BAE680X
LADA		
21123705010	060810257010	BAE680DK
211203705010	060810257010	BAE680DK
2112370501007	060810257010	BAE680DK
2112370501010	060810257010	BAE680DK
21120370501010	060810257010	BAE680DK
LAND ROVER		
ERR6045	060810175010	BAE680AG
LUCAS ELECTRICAL		
45289	060690002010	BK2A
45291	060690002010	BK2A
11P12	060690002010	BK2A
CL101	060690002010	BK2A
CL74	060690002010	BK2A
DLB101	060690002010	BK2A
DLB105	060690002010	BK2A
DLB233	060705754010	BAE507BK

OE/IAM

MAGNETI
MARELLI

LONG

SHORT

BOBINA D'ACCENSIONE
IGNITION COIL

LUCAS ELECTRICAL

DLB800	060705604010	BAE506D
DLB801	060705606010	BAE506F
DLJ304	060810173010	BAE680AE
DMB1058	060705404010	BAE504D
DMB1081	060810218010	BAE680BX
DMB408	060810168010	BAE680Z
DMB750	060810173010	BAE680AE
DMB751	060810173010	BAE680AE
DMB753	060810173010	BAE680AE
DMB807	060810189010	BAE680AU
DMB808	060810191010	BAE680AW
DMB816	060801008010	BAE608F
DMB852	060810192010	BAE680AX
DMB853	060810193010	BAE680AY
DMB856	060810195010	BAE680BA
DMB891	060810169010	BAE680AA
DMB897	060810270010	BAE680DX
DMB902	060810202010	BAE680BH
DMB907	060810167010	BAE680Y
DMB910	060810161010	BAE680S
DMB914	060810171010	BAE680AC
DMB944	060810222010	BAE680CB
DMB946	060810190010	BAE680AV
DMB95	060810223010	BAE680CC
DMB954	060810223010	BAE680CC

MAGNETI MARELLI

60690002	060690002010	BK2A
60705404	060705404010	BAE504D
60705406	060705406010	BAE504F
60705409	060705409010	BAE504L
60705604	060705604010	BAE506D
60705606	060705606010	BAE506F
60705738	060705738010	BAE507AK
60705754	060705754010	BAE507BK
60707038	060707038010	BAE700AK
60708138	060708138010	BAE801AK
60708149	060708149010	BAE801EK
60726001	060726001010	BZ600A
60740302	060740302010	BAE403B
60740303	060740303010	BAE403C
60740304	060740304010	BAE403D
60780002	060780002010	BAE800B
60792001	060792001010	BAE920AX

OE/IAM

MAGNETI
MARELLI

LONG

SHORT

BOBINA D'ACCENSIONE
IGNITION COIL

MAGNETI MARELLI

0780002010	060780002010	BAE800B
780002010	060780002010	BAE800B
780002010MM	060780002010	BAE800B
BI0021MM	060810070010	BAE680E
BI0022MM	060810175010	BAE680AG
BI003SSM	060780002010	BAE800B

MAPCO

80000	060705404010	BAE504D
80042	060780002010	BAE800B
80043	060705604010	BAE506D
80107	060708138010	BAE801AK
80401	060705754010	BAE507BK
80405	060810070010	BAE680E
80407	060705409010	BAE504L
80540	060801013010	BAE608M
80616	060801008010	BAE608F
80751	060810173010	BAE680AE
80883	060810191010	BAE680AW
80888	060810169010	BAE680AA

MAZDA

18E0518100	060810173010	BAE680AE
18E0518100A	060810173010	BAE680AE
1E031810X	060810220010	BAE680BZ
1E031810XA	060810220010	BAE680BZ
1E041810X	060810220010	BAE680BZ
1E0518100	060810173010	BAE680AE
1E0518100A	060810173010	BAE680AE
1E0518100B	060810220010	BAE680BZ
1F2018100	060810220010	BAE680BZ
C20118100A	060810220010	BAE680BZ
C40118100A	060810270010	BAE680DX
FSD718100	060810173010	BAE680AE
LF0118100	060810220010	BAE680BZ
LF0118100A	060810220010	BAE680BZ
LF0118100AZ05	060810220010	BAE680BZ
YF091810X	060810220010	BAE680BZ
ZZM018100	060810173010	BAE680AE

MEAT & DORIA

10300	060810070010	BAE680E
10301	060810090010	BAE680G
10302	060780002010	BAE800B
10303	060792001010	BAE920AX
10304	060705606010	BAE506F

OE/IAM	MAGNETI MARELLI	
	LONG	SHORT
BOBINA D'ACCENSIONE IGNITION COIL		
MEAT & DORIA		
10305	060705604010	BAE506D
10307	060810169010	BAE680AA
10309	060705406010	BAE504F
10310	060810251010	BAE680DE
10311	060810175010	BAE680AG
10312	060810181010	BAE680AM
10313	060810188010	BAE680AT
10314	060810173010	BAE680AE
10315	060801008010	BAE608F
10316	060801011010	BAE608I
10317	060810185010	BAE680AQ
10319	060810184010	BAE680AP
10322	060801013010	BAE608M
10326	060810177010	BAE680AI
10327	060810178010	BAE680AJ
10328	060810191010	BAE680AW
10331	060740302010	BAE403B
10332	060740303010	BAE403C
10333	060796115010	BAE961AE
10336	060810070010	BAE680E
10337	060810245010	BAE680CY
10338	060810249010	BAE680DC
10339	060740304010	BAE403D
10340	060707038010	BAE700AK
10343	060810174010	BAE680AF
10344	060810262010	BAE680DP
10346	060810165010	BAE680W
10348	060705754010	BAE507BK
10351	060810176010	BAE680AH
10353	060810260010	BAE680DN
10354	060708149010	BAE801EK
10356	060740304010	BAE403D
10357	060810202010	BAE680BH
10362	060810244010	BAE680CX
10365	060810179010	BAE680AK
10373	060810190010	BAE680AV
10374	060810192010	BAE680AX
10375	060810193010	BAE680AY
10377	060801009010	BAE608G
10378	060810250010	BAE680DD
10382	060810170010	BAE680AB
10383	060708138010	BAE801AK
10388	060810242010	BAE680CV

OE/IAM	MAGNETI MARELLI	
	LONG	SHORT
BOBINA D'ACCENSIONE IGNITION COIL		
MEAT & DORIA		
10394	060796015010	BAE960AE
10395	060794001010	BAE940A
10399	060810243010	BAE680CW
10406	060810195010	BAE680BA
10408	060810140010	BAE680N
10413	060810183010	BAE680AO
10414	060810219010	BAE680BY
10415	060810264010	BAE680DR
10423	060810261010	BAE680DO
10425	060810265010	BAE680DS
10443	060810223010	BAE680CC
10444	060810222010	BAE680CB
10449	060810166010	BAE680X
10450	060810164010	BAE680V
10452	060810163010	BAE680U
10453	060810162010	BAE680T
10460	060810167010	BAE680Y
10461	060810182010	BAE680AN
10463	060810180010	BAE680AL
10464	060810221010	BAE680CA
10466	060810200010	BAE680BF
10467	060810199010	BAE680BE
10469	060810206010	BAE680BL
10474	060705409010	BAE504L
10475	060705738010	BAE507AK
10479	060810269010	BAE680DW
10480	060801012010	BAE608L
10481	060801014010	BAE608N
10482	060810186010	BAE680AR
10483	060810208010	BAE680BN
10484	060810209010	BAE680BO
10485	060810197010	BAE680BC
10486	060810214010	BAE680BT
10489	060690002010	BK2A
10490	060810263010	BAE680DQ
10497	060810171010	BAE680AC
10498	060810161010	BAE680S
10500	060810187010	BAE680AS
10506	060810218010	BAE680BX
10507	060810215010	BAE680BU
10514	060810160010	BAE680R
10516	060810232010	BAE680CL
10522	060810204010	BAE680BJ

OE/IAM

MAGNETI
MARELLI

LONG

SHORT

BOBINA D'ACCENSIONE
IGNITION COIL

MEAT & DORIA

10523	060810205010	BAE680BK
10527	060810228010	BAE680CH
10528	060810213010	BAE680BS
10530	060810212010	BAE680BR
10531	060810207010	BAE680BM
10541	060810211010	BAE680BQ
10545	060810224010	BAE680CD
10548	060810226010	BAE680CF
10550	060810198010	BAE680BD
10555	060810216010	BAE680BV
10560	060810227010	BAE680CG
10563	060810225010	BAE680CE
10564	060810210010	BAE680BP
10575	060810233010	BAE680CM
10578	060810236010	BAE680CP
10581	060810229010	BAE680CI
10596	060810196010	BAE680BB
10599	060810234010	BAE680CN
10600	060810237010	BAE680CQ
10602	060810235010	BAE680CO
10603	060810238010	BAE680CR
10604	060810239010	BAE680CS
10610	060810241010	BAE680CU
10615	060810247010	BAE680DA
10616	060810240010	BAE680CT
10628	060810220010	BAE680BZ
10642	060810255010	BAE680DI
10687	060810248010	BAE680DB
10699	060810257010	BAE680DK
10713	060810258010	BAE680DL
10735	060705404010	BAE504D
10752	060810252010	BAE680DF
10762	060810271010	BAE680DY

MERCEDES-BENZ

0001501380	060810243010	BAE680CW
0001502780	060810237010	BAE680CQ
0001587803	060810244010	BAE680CX
1561500080	060810252010	BAE680DF
1561500380	060810252010	BAE680DF
1569060400	060810252010	BAE680DF
A0001501380	060810243010	BAE680CW
A0001502780	060810237010	BAE680CQ
A0001587803	060810244010	BAE680CX

OE/IAM

MAGNETI
MARELLI

LONG

SHORT

BOBINA D'ACCENSIONE
IGNITION COIL

MERCEDES-BENZ

A0009060060	060810238010	BAE680CR
A1561500080	060810252010	BAE680DF
A1561500380	060810252010	BAE680DF
A1569060400	060810252010	BAE680DF

METZGER

0880002	060801008010	BAE608F
0880024	060810193010	BAE680AY
0880073	060810270010	BAE680DX
0880190	060810237010	BAE680CQ
0880200	060810070010	BAE680E
0880350	060780002010	BAE800B
0880356	060740302010	BAE403B

MEYLE

0148850005	060810237010	BAE680CQ
1009050021	060810169010	BAE680AA
2148000001	060780002010	BAE800B
2148850000	060792001010	BAE920AX
2148850004	060740302010	BAE403B
6148850006	060801008010	BAE608F
16148850002	060810070010	BAE680E
31148850002	060810229010	BAE680CI
36148850000	060810195010	BAE680BA
36148850004	060810140010	BAE680N

MINI

12137571643	060810212010	BAE680BR
12137594937	060810212010	BAE680BR

NGK

48002	060810070010	BAE680E
48006	060801008010	BAE608F
48012	060801011010	BAE608I
48028	060708138010	BAE801AK
48034	060740302010	BAE403B
48052	060792001010	BAE920AX
48061	060740303010	BAE403C
48063	060810269010	BAE680DW
48064	060705604010	BAE506D
48107	060810222010	BAE680CB
48123	060705409010	BAE504L
48169	060794001010	BAE940A
48172	060740304010	BAE403D
48336	060810257010	BAE680DK
U1009	060705754010	BAE507BK
U1079	060690002010	BK2A

OE/IAM	MAGNETI MARELLI	
	LONG	SHORT
BOBINA D'ACCENSIONE IGNITION COIL		
NGK		
U2003	060810169010	BAE680AA
U2005	060810173010	BAE680AE
U2007	060810168010	BAE680Z
U2011	060810192010	BAE680AX
U2018	060801013010	BAE608M
U2028	060810241010	BAE680CU
U2048	060810162010	BAE680T
U2051	060810164010	BAE680V
U2060	060810163010	BAE680U
U2061	060810166010	BAE680X
U3001	060780002010	BAE800B
U3008	060708149010	BAE801EK
U4008	060810219010	BAE680BY
U4016	060810264010	BAE680DR
U5002	060810189010	BAE680AU
U5003	060810191010	BAE680AW
U5006	060810167010	BAE680Y
U5011	060810161010	BAE680S
U5013	060810171010	BAE680AC
U5014	060810190010	BAE680AV
U5017	060810194010	BAE680AZ
U5019	060810269010	BAE680DW
U5020	060810197010	BAE680BC
U5027	060810202010	BAE680BH
U5029	060810222010	BAE680CB
U5044	060707038010	BAE700AK
U5052	060810223010	BAE680CC
U5091	060810233010	BAE680CM
U5094	060810236010	BAE680CP
U5099	060810225010	BAE680CE
U5116	060810257010	BAE680DK
NISSAN		
2243351J10	060810261010	BAE680DO
2243353J20	060810261010	BAE680DO
2243355S10	060810261010	BAE680DO
2244800QAA	060810070010	BAE680E
2244800QAC	060810070010	BAE680E
2244800QAE	060810070010	BAE680E
224481F700	060810182010	BAE680AN
224482Y015	060810232010	BAE680CL
2244831U06	060810140010	BAE680N
2244831U16	060810140010	BAE680N
224484M500	060810195010	BAE680BA

OE/IAM	MAGNETI MARELLI	
	LONG	SHORT
BOBINA D'ACCENSIONE IGNITION COIL		
NISSAN		
224484M50A	060810195010	BAE680BA
224486N011	060810070010	BAE680E
224488H300	060810199010	BAE680BE
224488H310	060810199010	BAE680BE
224488H314	060810199010	BAE680BE
224488H315	060810199010	BAE680BE
224489Y600	060810199010	BAE680BE
22448AX001	060810160010	BAE680R
22448ED000	060810255010	BAE680DI
22448ED800	060810187010	BAE680AS
22448ED800EP	060810187010	BAE680AS
22448EN200	060810255010	BAE680DI
22448JA00A	060810255010	BAE680DI
22448JA00C	060810255010	BAE680DI
OPEL		
1103872	060801011010	BAE608I
1103905	060801011010	BAE608I
1208010	060801009010	BAE608G
1208012	060810178010	BAE680AJ
1208015	060810228010	BAE680CH
1208021	060801012010	BAE608L
1208026	060801014010	BAE608N
1208051	060801013010	BAE608M
1208063	060801011010	BAE608I
1208306	060810177010	BAE680AI
1208307	060801008010	BAE608F
1612004	060801010010	BAE608H
4408389	060810070010	BAE680E
9118115	060810204010	BAE680BJ
9153250	060810207010	BAE680BM
9195819	060810205010	BAE680BK
9198834	060810206010	BAE680BL
12580537	060801014010	BAE608N
12583514	060810226010	BAE680CF
12629037	060810226010	BAE680CF
24420584	060810180010	BAE680AL
24420622	060810208010	BAE680BN
55350843	060810228010	BAE680CH
55561655	060810239010	BAE680CS
90173708	060810228010	BAE680CH
90424480	060810206010	BAE680BL
90532618	060810177010	BAE680AI
90543059	060810177010	BAE680AI

OE/IAM	MAGNETI MARELLI	
	LONG	SHORT
BOBINA D'ACCENSIONE IGNITION COIL		
OPEL		
90543253	060810178010	BAE680AJ
90560110	060810178010	BAE680AJ
90564334	060810205010	BAE680BK
90584337	060810204010	BAE680BJ
91159996	060810070010	BAE680E
93161948	060810070010	BAE680E
93172030	060810207010	BAE680BM
93173708	060810228010	BAE680CH
93177212	060810180010	BAE680AL
93180806	060810208010	BAE680BN
PROTON		
PW811201	060810175010	BAE680AG
PSA		
594029	060705409010	BAE504L
594029	060705409010	BAE504L
597010	060690002010	BK2A
597011	060690002010	BK2A
597026	060690002010	BK2A
597028	060690002010	BK2A
597045	060705754010	BAE507BK
597048	060810174010	BAE680AF
597049	060810242010	BAE680CV
597050	060707038010	BAE700AK
597051	060810193010	BAE680AY
597064	060810212010	BAE680BR
597070	060810174010	BAE680AF
597088	060810222010	BAE680CB
1208018	060690002010	BK2A
11115033	060690002010	BK2A
11115043	060690002010	BK2A
11115062	060690002010	BK2A
11115066	060690002010	BK2A
96035284	060705754010	BAE507BK
96062288	060810242010	BAE680CV
96074054	060810174010	BAE680AF
96211048	060810193010	BAE680AY
96228897	060810174010	BAE680AF
9611412080	060707038010	BAE700AK
9651710680	060810221010	BAE680CA
9663278480	060810198010	BAE680BD
9753078080	060705738010	BAE507AK
5970.85	060810221010	BAE680CA
5970A7	060810193010	BAE680AY

OE/IAM	MAGNETI MARELLI	
	LONG	SHORT
BOBINA D'ACCENSIONE IGNITION COIL		
PSA		
5970C0	060810222010	BAE680CB
5970C1	060810222010	BAE680CB
DM212088	060690002010	BK2A
DM21208B	060690002010	BK2A
V756274480	060810212010	BAE680BR
V757164380	060810212010	BAE680BR
V759493780	060810212010	BAE680BR
RENAULT		
0854243200	060690002010	BK2A
0854269800	060690002010	BK2A
6001543604	060810168010	BAE680Z
7700107177	060810070010	BAE680E
7700107269	060708149010	BAE801EK
7700113357	060810070010	BAE680E
7700274008	060810168010	BAE680Z
7700552370	060690002010	BK2A
7700737461	060690002010	BK2A
7700738322	060690002010	BK2A
7700738498	060690002010	BK2A
7700742132	060690002010	BK2A
7700749450	060705409010	BAE504L
7700854306	060708138010	BAE801AK
7700858138	060705409010	BAE504L
7700872265	060708138010	BAE801AK
7700875000	060810070010	BAE680E
7701348252	060690002010	BK2A
7701479027	060810198010	BAE680BD
7702218697	060705409010	BAE504L
7710000925	060810168010	BAE680Z
8200051128	060810241010	BAE680CU
8200084401	060810241010	BAE680CU
8200154186	060810070010	BAE680E
8200208611	060810070010	BAE680E
8200380267	060810070010	BAE680E
8200405098	060810070010	BAE680E
8200568671	060810070010	BAE680E
8200699627	060810247010	BAE680DA
8200702693	060810241010	BAE680CU
8200726341	060810236010	BAE680CP
8200765882	060810070010	BAE680E
8200959964	060810236010	BAE680CP
224332428R	060810258010	BAE680DL
224337085R	060810236010	BAE680CP

OE/IAM	MAGNETI MARELLI	
	LONG	SHORT
BOBINA D'ACCENSIONE IGNITION COIL		
RENAULT		
2526180A	060810070010	BAE680E
7700113357A	060810070010	BAE680E
7700749450-D	060705409010	BAE504L
8200154186A	060810070010	BAE680E
ROVER		
GCL204	060810242010	BAE680CV
NEC100710	060810242010	BAE680CV
SAAB		
12629037	060810226010	BAE680CF
SAGEM		
2790	060690002010	BK2A
2526026	060705754010	BAE507BK
2526030	060705604010	BAE506D
2526034	060705409010	BAE504L
2526039	060810242010	BAE680CV
2526040	060810174010	BAE680AF
2526049	060690002010	BK2A
2526059	060810193010	BAE680AY
215952732	060810070010	BAE680E
2526015A	060705606010	BAE506F
2526026A	060705754010	BAE507BK
2526059A	060810193010	BAE680AY
2526151A	060810168010	BAE680Z
B6168	060705409010	BAE504L
B6186	060705604010	BAE506D
SIDAT		
8330110	060810161010	BAE680S
8530010	060810162010	BAE680T
8530011	060810163010	BAE680U
8530012	060810164010	BAE680V
8530016	060801013010	BAE608M
8530023	060810165010	BAE680W
8530026	060810166010	BAE680X
8530027	060705406010	BAE504F
8530029	060810167010	BAE680Y
8530031	060740304010	BAE403D
8530032	060705604010	BAE506D
8530033	060726001010	BZ600A
8530034	060792001010	BAE920AX
8530035	060705738010	BAE507AK
8530036	060780002010	BAE800B
8530037	060708149010	BAE801EK
8530038	060705754010	BAE507BK

OE/IAM	MAGNETI MARELLI	
	LONG	SHORT
BOBINA D'ACCENSIONE IGNITION COIL		
SIDAT		
8530040	060705404010	BAE504D
8530041	060705606010	BAE506F
8530042	060705409010	BAE504L
8530043	060740302010	BAE403B
8530044	060707038010	BAE700AK
8530045	060740303010	BAE403C
8530058	060810168010	BAE680Z
8530062	060810169010	BAE680AA
8530063	060810170010	BAE680AB
8530064	060690002010	BK2A
8530072	060810171010	BAE680AC
8530081	060810260010	BAE680DN
8530090	060810244010	BAE680CX
8530091	060810173010	BAE680AE
8530095	060810242010	BAE680CV
8530096	060810174010	BAE680AF
8530097	060810175010	BAE680AG
8530102	060810261010	BAE680DO
8530109	060801008010	BAE608F
8530121	060810262010	BAE680DP
8530135	060810269010	BAE680DW
8530141	060810177010	BAE680AI
8530142	060810178010	BAE680AJ
8530143	060810179010	BAE680AK
8530146	060810243010	BAE680CW
8530147	060810180010	BAE680AL
8530149	060810245010	BAE680CY
8530150	060810181010	BAE680AM
8530151	060810182010	BAE680AN
8530152	060810183010	BAE680AO
8530153	060810184010	BAE680AP
8530154	060810176010	BAE680AH
8530158	060810185010	BAE680AQ
8530160	060810186010	BAE680AR
8530161	060810187010	BAE680AS
8530162	060810188010	BAE680AT
8530165	060810189010	BAE680AU
8530166	060801011010	BAE608I
8530168	060810190010	BAE680AV
8530171	060810191010	BAE680AW
8530172	060810192010	BAE680AX
8530173	060810193010	BAE680AY
8530174	060810249010	BAE680DC

OE/IAM	MAGNETI MARELLI	
	LONG	SHORT
BOBINA D'ACCENSIONE IGNITION COIL		
SIDAT		
8530175	060810250010	BAE680DD
8530176	060810251010	BAE680DE
8530177	060810194010	BAE680AZ
8530183	060810090010	BAE680G
8530185	060796015010	BAE960AE
8530188	060810195010	BAE680BA
8530188	060810195010	BAE680BA
8530189	060796115010	BAE961AE
8530190	060794001010	BAE940A
8530194	060810197010	BAE680BC
8530198	060708138010	BAE801AK
8530211	060801009010	BAE608G
8530212	060810160010	BAE680R
8530213	060810199010	BAE680BE
8530213	060810199010	BAE680BE
8530226	060810200010	BAE680BF
8530228	060810202010	BAE680BH
8530241	060810204010	BAE680BJ
8530242	060810205010	BAE680BK
8530243	060810206010	BAE680BL
8530244	060810207010	BAE680BM
8530245	060810208010	BAE680BN
8530246	060810209010	BAE680BO
8530248	060810263010	BAE680DQ
8530249	060810210010	BAE680BP
8530250	060810211010	BAE680BQ
8530251	060810212010	BAE680BR
8530252	060810213010	BAE680BS
8530253	060810214010	BAE680BT
8530254	060810215010	BAE680BU
8530255	060810216010	BAE680BV
8530256	060810196010	BAE680BB
8530268	060801012010	BAE608L
8530270	060801014010	BAE608N
8530289	060810218010	BAE680BX
8530291	060810219010	BAE680BY
8530302	060810220010	BAE680BZ
8530303	060810221010	BAE680CA
8530304	060810222010	BAE680CB
8530305	060810223010	BAE680CC
8530312	060810224010	BAE680CD
8530317	060810225010	BAE680CE
8530324	060810140010	BAE680N

OE/IAM	MAGNETI MARELLI	
	LONG	SHORT
BOBINA D'ACCENSIONE IGNITION COIL		
SIDAT		
8530325	060810264010	BAE680DR
8530326	060810265010	BAE680DS
8530327	060810226010	BAE680CF
8530328	060810198010	BAE680BD
8530332	060810227010	BAE680CG
8530337	060810228010	BAE680CH
8530343	060810229010	BAE680CI
8530356	060810232010	BAE680CL
8530362	060810233010	BAE680CM
8530366	060810234010	BAE680CN
8530368	060810235010	BAE680CO
8530369	060810236010	BAE680CP
8530373	060810237010	BAE680CQ
8530374	060810238010	BAE680CR
8530375	060810239010	BAE680CS
8530406	060810241010	BAE680CU
8530408	060810240010	BAE680CT
8530421	060810255010	BAE680DI
8530435	060810247010	BAE680DA
8530448	060810248010	BAE680DB
8530455	060810257010	BAE680DK
8530456	060810258010	BAE680DL
8530502	060810252010	BAE680DF
8530524	060810271010	BAE680DY
SMART		
0003100V003	060810179010	BAE680AK
0003100V004	060810179010	BAE680AK
0003100V005	060810179010	BAE680AK
Q0003100V003	060810179010	BAE680AK
Q0003100V004	060810179010	BAE680AK
Q0003100V005	060810179010	BAE680AK
STANDARD		
11040	060690002010	BK2A
12602	060705606010	BAE506F
12604	060726001010	BZ600A
12605	060705606010	BAE506F
12659	060810262010	BAE680DP
12711	060810070010	BAE680E
12730	060810090010	BAE680G
12734	060801013010	BAE608M
12735	060810195010	BAE680BA
12740	060796115010	BAE961AE
12741	060740303010	BAE403C

OE/IAM	MAGNETI MARELLI	
	LONG	SHORT
BOBINA D'ACCENSIONE IGNITION COIL		
STANDARD		
12785	060740304010	BAE403D
12789	060794001010	BAE940A
12809	060810160010	BAE680R
12825	060810223010	BAE680CC
12855	060810231010	BAE680CK
12867	060810199010	BAE680BE
12878	060810241010	BAE680CU
12889	060810237010	BAE680CQ
12893	060810229010	BAE680CI
12917	060801011010	BAE608I
IIS010	060810070010	BAE680E
IIS026	060810231010	BAE680CK
IIS027	060810195010	BAE680BA
IIS033	060801008010	BAE608F
IIS035	060740304010	BAE403D
IIS037	060740303010	BAE403C
IIS049	060810090010	BAE680G
IIS056	060740302010	BAE403B
IIS077	060780002010	BAE800B
IIS085	060690002010	BK2A
IIS115	060801011010	BAE608I
IIS117	060792001010	BAE920AX
IIS123	060801013010	BAE608M
IIS145	060705604010	BAE506D
IIS171	060705404010	BAE504D
IIS175	060705606010	BAE506F
IIS185	060794001010	BAE940A
IIS196	060705606010	BAE506F
IIS201	060810160010	BAE680R
IIS234	060810223010	BAE680CC
IIS252	060810199010	BAE680BE
IIS278	060810229010	BAE680CI
IIS289	060810237010	BAE680CQ
SUBARU		
3340083E10	060810219010	BAE680BY
3340062J00	060810219010	BAE680BY
SUZUKI		
3340065G00	060810219010	BAE680BY
3340065G01	060810219010	BAE680BY
3340065G02	060810219010	BAE680BY

OE/IAM	MAGNETI MARELLI	
	LONG	SHORT
BOBINA D'ACCENSIONE IGNITION COIL		
SWAG		
30919032	060810169010	BAE680AA
30922040	060810191010	BAE680AW
30924500	060810167010	BAE680Y
32923260	060810190010	BAE680AV
32924106	060810191010	BAE680AW
40922389	060801008010	BAE608F
40923187	060801008010	BAE608F
40926014	060801011010	BAE608I
40928108	060801012010	BAE608L
50921579	060810173010	BAE680AE
60921524	060810168010	BAE680Z
60921529	060708149010	BAE801EK
60921666	060810070010	BAE680E
60922875	060708138010	BAE801AK
70919929	060780002010	BAE800B
70922697	060792001010	BAE920AX
TOPRAN		
109316	060810169010	BAE680AA
109539	060810192010	BAE680AX
109541	060810191010	BAE680AW
206640	060801008010	BAE608F
TOYOTA		
9008019015	060810222010	BAE680CB
9008019017	060810183010	BAE680AO
9008019019	060810222010	BAE680CB
9008019021	060810202010	BAE680BH
9008019023	060810223010	BAE680CC
9091902135	060810265010	BAE680DS
9091902212	060810264010	BAE680DR
9091902229	060810202010	BAE680BH
9091902238	060810227010	BAE680CG
9091902239	060810222010	BAE680CB
9091902240	060810202010	BAE680BH
9091902243	060810223010	BAE680CC
9091902244	060810223010	BAE680CC
9091902252	060810240010	BAE680CT
9091902258	060810240010	BAE680CT
9091902262	060810222010	BAE680CB
9091902265	060810202010	BAE680BH
9091902266	060810223010	BAE680CC
9091919023	060810223010	BAE680CC
900801901700	060810183010	BAE680AO
90919C2003	060810240010	BAE680CT

OE/IAM	MAGNETI MARELLI	
	LONG	SHORT
BOBINA D'ACCENSIONE IGNITION COIL		
TOYOTA		
90919C2005	060810240010	BAE680CT
90919T2002	060810222010	BAE680CB
90919T2003	060810202010	BAE680BH
90919T2006	060810222010	BAE680CB
90919W2001	060810222010	BAE680CB
TRISCAN		
886013014	060810202010	BAE680BH
886014005	060810195010	BAE680BA
886014006	060810140010	BAE680N
886015009	060740304010	BAE403D
886015010	060740303010	BAE403C
886015011	060810090010	BAE680G
886015012	060740302010	BAE403B
886024012	060801008010	BAE608F
886024015	060801014010	BAE608N
886025004	060810070010	BAE680E
886029020	060810191010	BAE680AW
886029023	060810190010	BAE680AV
886069007	060810219010	BAE680BY
VAG		
3939214	060690002010	BK2A
003962745	060690002010	BK2A
4071394	060690002010	BK2A
022905715	060810197010	BAE680BC
030905106	060810169010	BAE680AA
032905106	060810169010	BAE680AA
036905715	060810189010	BAE680AU
047905104	060796015010	BAE960AE
052905105	060690002010	BK2A
110914010	060690002010	BK2A
111905115	060690002010	BK2A
0221603009	060810169010	BAE680AA
0489051051	060810175010	BAE680AG
37681509010000	060690002010	BK2A
022905100A	060810161010	BAE680S
022905100B	060810197010	BAE680BC
022905100D	060810161010	BAE680S
022905100E	060810197010	BAE680BC
022905100G	060810161010	BAE680S
022905100H	060810197010	BAE680BC
022905100K	060810161010	BAE680S
022905100L	060810197010	BAE680BC
022905100N	060810161010	BAE680S

OE/IAM	MAGNETI MARELLI	
	LONG	SHORT
BOBINA D'ACCENSIONE IGNITION COIL		
VAG		
022905100P	060810197010	BAE680BC
022905100S	060810197010	BAE680BC
022905100T	060810197010	BAE680BC
022905715A	060810197010	BAE680BC
022905715B	060810197010	BAE680BC
022905715C	060810161010	BAE680S
028915000B	060690002010	BK2A
032905106B	060810169010	BAE680AA
032905106D	060810169010	BAE680AA
032905106E	060810169010	BAE680AA
036905100A	060810189010	BAE680AU
036905100B	060810189010	BAE680AU
036905100C	060810189010	BAE680AU
036905100D	060810189010	BAE680AU
036905715A	060810189010	BAE680AU
036905715C	060810189010	BAE680AU
036905715E	060810189010	BAE680AU
036905715F	060810189010	BAE680AU
036905715G	060810189010	BAE680AU
03D905115	060810167010	BAE680Y
03D905115A	060810167010	BAE680Y
03D905115B	060810167010	BAE680Y
03D905115C	060810167010	BAE680Y
03D905115D	060810167010	BAE680Y
03D905115E	060810167010	BAE680Y
03D905115F	060810167010	BAE680Y
03D905115G	060810167010	BAE680Y
03D905715	060810167010	BAE680Y
03D905715A	060810167010	BAE680Y
043905115A	060690002010	BK2A
043905115C	060690002010	BK2A
047905104A	060796115010	BAE961AE
047905104B	060796115010	BAE961AE
04C905110B	060810234010	BAE680CN
04C905110D	060810234010	BAE680CN
04E905110	060810234010	BAE680CN
04E905110A	060810234010	BAE680CN
058905101A	060810185010	BAE680AQ
06A905097	060810192010	BAE680AX
06A905104	060810192010	BAE680AX
06A905115	060810191010	BAE680AW
06A905115A	060810191010	BAE680AW
06A905115B	060810191010	BAE680AW

OE/IAM	MAGNETI MARELLI	
	LONG	SHORT

BOBINA D'ACCENSIONE IGNITION COIL		
--------------------------------------	--	--

VAG		
06A905115C	060810191010	BAE680AW
06A905115D	060810191010	BAE680AW
06B905115D	060810191010	BAE680AW
06B905115G	060810191010	BAE680AW
06B905115H	060810191010	BAE680AW
06B905115J	060810191010	BAE680AW
06B905115L	060810191010	BAE680AW
06B905115M	060810191010	BAE680AW
06B905115N	060810191010	BAE680AW
06B905115P	060810191010	BAE680AW
06B905115Q	060810191010	BAE680AW
06B905115R	060810191010	BAE680AW
06C905115B	060810191010	BAE680AW
06C905115C	060810191010	BAE680AW
06C905115D	060810191010	BAE680AW
06C905115E	060810171010	BAE680AC
06C905115F	060810171010	BAE680AC
06C905115G	060810171010	BAE680AC
06C905115H	060810171010	BAE680AC
06C905115K	060810171010	BAE680AC
06C905115L	060810171010	BAE680AC
06C905115M	060810171010	BAE680AC
06D905115	060810190010	BAE680AV
06D905115A	060810190010	BAE680AV
06D905115C	060810190010	BAE680AV
06D905115D	060810190010	BAE680AV
06D905115F	060810190010	BAE680AV
06D905115G	060810190010	BAE680AV
06D905115J	060810190010	BAE680AV
06D905115K	060810190010	BAE680AV
06E905115	060810190010	BAE680AV
06E905115A	060810190010	BAE680AV
06E905115B	060810190010	BAE680AV
06E905115C	060810190010	BAE680AV
06E905115D	060810190010	BAE680AV
06E905115E	060810190010	BAE680AV
06H905110D	060810235010	BAE680CO
06H905110E	060810235010	BAE680CO
06H905115A	060810196010	BAE680BB
06H905115B	060810196010	BAE680BB
07C905715	060810194010	BAE680AZ
07C905715A	060810194010	BAE680AZ
07K905715C	060810196010	BAE680BB

OE/IAM	MAGNETI MARELLI	
	LONG	SHORT

BOBINA D'ACCENSIONE IGNITION COIL		
--------------------------------------	--	--

VAG		
07K905715F	060810196010	BAE680BB
SE028915000B	060708149010	BAE801EK
VALEO		
245010	060690002010	BK2A
245039	060705754010	BAE507BK
245040	060810174010	BAE680AF
245041	060810242010	BAE680CV
245046	060810193010	BAE680AY
245047	060690002010	BK2A
245052	060705606010	BAE506F
245059	060690002010	BK2A
245068	060705409010	BAE504L
245104	060810070010	BAE680E
245105	060810168010	BAE680Z
245111	060780002010	BAE800B
245116	060740302010	BAE403B
245117	060740303010	BAE403C
245118	060740304010	BAE403D
245122	060705409010	BAE504L
245123	060705404010	BAE504D
245124	060705604010	BAE506D
245127	060707038010	BAE700AK
245129	060708138010	BAE801AK
245134	060792001010	BAE920AX
245135	060794001010	BAE940A
245136	060796015010	BAE960AE
245137	060796115010	BAE961AE
245138	060708149010	BAE801EK
245141	060810189010	BAE680AU
245142	060810191010	BAE680AW
245153	060810184010	BAE680AP
245155	060810245010	BAE680CY
245159	060810169010	BAE680AA
245160	060810173010	BAE680AE
245163	060810167010	BAE680Y
245166	060810175010	BAE680AG
245167	060810262010	BAE680DP
245168	060801008010	BAE608F
245172	060810180010	BAE680AL
245174	060810202010	BAE680BH
245175	060810186010	BAE680AR
245176	060810222010	BAE680CB
245177	060810219010	BAE680BY

OE/IAM	MAGNETI MARELLI	
	LONG	SHORT
BOBINA D'ACCENSIONE IGNITION COIL		
VALEO		
245179	060801011010	BAE608I
245192	060801013010	BAE608M
245204	060810233010	BAE680CM
245205	060810164010	BAE680V
245260	060810199010	BAE680BE
245262	060810162010	BAE680T
245265	060810163010	BAE680U
245275	060810195010	BAE680BA
2526030	060705604010	BAE506D
CD323	060690002010	BK2A
VAUXHALL		
1104038	060801013010	BAE608M
10457075	060801011010	BAE608I
10457804	060801010010	BAE608H
10458316	060801012010	BAE608L
55561655	060810239010	BAE680CS
91159996	060810070010	BAE680E
VEMO		
10700013	060810191010	BAE680AW
10700044	060810169010	BAE680AA
10700046	060810192010	BAE680AX
40700016	060801008010	BAE608F
V10700013	060810191010	BAE680AW
V10700044	060810169010	BAE680AA
V10700054	060810190010	BAE680AV
V10700059	060810167010	BAE680Y
V22700003	060810193010	BAE680AY
V24700003	060780002010	BAE800B
V24700004	060740302010	BAE403B
V30700027	060810237010	BAE680CQ
V46700001	060810070010	BAE680E
VOLVO		
1275174	060810200010	BAE680BF
8677837	060810216010	BAE680BV
9125601	060810186010	BAE680AR
12751740	060810200010	BAE680BF
30713416	060810186010	BAE680AR
30713417	060810216010	BAE680BV
30731416	060810270010	BAE680DX
30731419	060810270010	BAE680DX
31216444	060810270010	BAE680DX
31316353	060810271010	BAE680DY
91256010	060810186010	BAE680AR

OE/IAM	MAGNETI MARELLI	
	LONG	SHORT
BOBINA D'ACCENSIONE IGNITION COIL		
VOLVO		
307134160	060810186010	BAE680AR
307134170	060810216010	BAE680BV
31216444AA	060810270010	BAE680DX

GRUPPO J - GROUP J

J3	COMANDO INDICATORE LIVELLO CARBURANTE FUEL LEVEL SENDER	
AIRTEX		
E10565S	519731359900	SUA512
E10688S	519000058100	SUA581
E10689S	519000057400	SUA574
E10690S	519000057900	SUA579
BMW		
16146765827	519000058300	SUA583
BOSCH		
0580207008	519000058500	SUA585
0580207323	519000058300	SUA583
0580303042	519000058300	SUA583
0986580102	519722509980	SUA138
0986580103	519730059981	SUA141
0986580108	519734009980	SUA386
0986580110	519741659900	SUA394
0986580117	510033531803	SUA230
0986580123	510033625301	SUA351
0986580140	519731309901	SUA465
0986580158	119763009900	SUA424
0986580231	510033762601	SUA265
0986580236	510034000801	SUA278
0986580238	510034066201	SUA287
0986580290	519731139900	SUA383
0986580291	519731149900	SUA384
0986580292	519741659902	SUA411
0986580340	519000057200	SUA572
0986580343	519000059000	SUA590
0986580355	519721499900	SUA405
0986580365	519722019900	SUA456
0986580367	519732019902	SUA517
0986580378	519000057700	SUA577
0986580382	519781129900	SUA519
0986580385	519000057100	SUA571
1582980111	519000057300	SUA573

OE/IAM	 LONG SHORT	
--------	-------------------------------------	--

J3	COMANDO INDICATORE LIVELLO CARBURANTE FUEL LEVEL SENDER
-----------	--

DACIA		
6001548608	519741909900	SUA485
172024535R	519000056100	SUA561
DELPHI		
FG102412B1	519731359900	SUA512
FT1001512B1	519000059200	SUA592
ERA		
775298	519000057700	SUA577
FCA		
7736885	119751759960	SUA129
46523412	119763009900	SUA424
1471937080	519730619980	SUA146
9659634080	519731359900	SUA512
9659634280	519000058700	SUA587
9659634380	519000058800	SUA588
9683833280	519000055300	SUA553
GENERAL MOTORS		
93177717	519000057300	SUA573
HYUNDAI		
311101H800	519000057500	SUA575
KIA		
311101H800	519000057500	SUA575
MEAT & DORIA		
79002	510033445802	SUA319
79004	519722509980	SUA138
79006	519734009980	SUA386
79008	510034066201	SUA287
79009	519731149900	SUA384
79010	519730059981	SUA141
79011	510033531803	SUA230
79012	519730809905	SUA382
79013	519730619980	SUA146
79016	519741659900	SUA394
79019	519751529900	SUA398
79022	119751759960	SUA129
79025	119763009900	SUA424
79054	519731139900	SUA383
79056	519720509900	SUA371
79126	510033762601	SUA265
79127	510033762701	SUA266
79181	519741659902	SUA411
79182	519741659903	SUA412
79189	510033625301	SUA351
79190	519721499900	SUA405

OE/IAM	 LONG SHORT	
--------	-------------------------------------	--

J3	COMANDO INDICATORE LIVELLO CARBURANTE FUEL LEVEL SENDER
-----------	--

MEAT & DORIA		
79200	519000057200	SUA572
79222	519731309901	SUA465
79223	519741779902	SUA511
79263	519741859902	SUA518
79264	519741909900	SUA485
79268	519000057100	SUA571
79269	519722019900	SUA456
79272	519721349901	SUA510
79277	519000059100	SUA591
79278	519000058200	SUA582
79279	519731359900	SUA512
79280	519000058700	SUA587
79281	519000058800	SUA588
79282	519000058900	SUA589
79283	519732019902	SUA517
79284	519741659904	SUA513
79285	519741659905	SUA514
79287	519751569900	SUA516
79288	519781129900	SUA519
79289	519781129903	SUA520
79299	519000056800	SUA568
79300	519000056300	SUA563
79301	519000055200	SUA552
79322	519000057700	SUA577
79324	519000056200	SUA562
79325	519000056000	SUA560
79327	519000058400	SUA584
79328	519000057800	SUA578
79331	519000058300	SUA583
79337	519000055800	SUA558
79338	519000055900	SUA559
79339	519000056700	SUA567
79340	519000056900	SUA569
79341	519000057000	SUA570
79342	519000055700	SUA557
79343	519000056600	SUA566
79350	519000055400	SUA554
79351	519000056100	SUA561
79353	519000055300	SUA553
79369	519000056400	SUA564
79370	519000056500	SUA565
79374	519000057500	SUA575
79376	519000058100	SUA581

OE/AM	MAGNETI MARELLI	
	LONG	SHORT
J3	COMANDO INDICATORE LIVELLO CARBURANTE FUEL LEVEL SENDER	
MEAT & DORIA		
79377	519000057400	SUA574
79378	519000057900	SUA579
79380	519000058600	SUA586
79384	519000057300	SUA573
79387	519000058500	SUA585
MERCEDES-BENZ		
2034701641	519000059000	SUA590
2034702541	519000057200	SUA572
2034702941	519000057200	SUA572
2034705094	519000058100	SUA581
2034705194	519000057400	SUA574
2034705394	519000057900	SUA579
2124700594	519000056900	SUA569
2124700794	519000057000	SUA570
2124701394	519000056600	SUA566
A1684704194	519781689903	SUA509
A2034705094	519000058100	SUA581
A2034705194	519000057400	SUA574
A2034705394	519000057900	SUA579
A203470669	519750039901	SUA515
A2124700594	519000056900	SUA569
A2124700794	519000057000	SUA570
A2124701394	519000056600	SUA566
MINI		
2752312	519751569900	SUA516
NISSAN		
17040JD50A	519000056200	SUA562
17040JD51A	519000057700	SUA577
25060JD00A	519000056800	SUA568
OPEL		
815059	519000057300	SUA573
PIERBURG		
702700070	519721349901	SUA510
702700090	519781129900	SUA519
702700200	519730619980	SUA146
702700230	519730809905	SUA382
702700240	519000056000	SUA560
702700250	519731139900	SUA383
702700260	519731149900	SUA384
702700270	519000058200	SUA582
702700300	519731359900	SUA512
702700310	519000058700	SUA587
702700320	519000058800	SUA588

OE/AM	MAGNETI MARELLI	
	LONG	SHORT
J3	COMANDO INDICATORE LIVELLO CARBURANTE FUEL LEVEL SENDER	
PIERBURG		
702700330	519000058900	SUA589
702700470	519741659904	SUA513
702700650	119751759960	SUA129
702700670	119763009900	SUA424
702700730	519000059100	SUA591
702700740	519781129903	SUA520
702700760	510032299601	SUA188
702700830	510033625301	SUA351
702700860	510034000801	SUA278
702701160	519000057700	SUA577
702701170	519000056200	SUA562
702701190	519000056800	SUA568
702701200	519000057600	SUA576
702701220	519000059200	SUA592
702701390	519000056900	SUA569
702701400	519000057000	SUA570
702701420	519000056600	SUA566
702701450	519000058400	SUA584
702701460	519000057100	SUA571
702701770	519000057800	SUA578
702701800	519000055700	SUA557
702701830	519000056700	SUA567
722466740	519722019900	SUA456
722466760	519732019902	SUA517
722466790	510034066201	SUA287
722466860	510033762601	SUA265
722466870	519741659902	SUA411
722466890	510032241901	SUA187
722466910	519730059981	SUA141
722466940	519731309901	SUA465
PSA		
152511	519734009980	SUA386
152519	519730059981	SUA141
152524	510033531803	SUA230
152531	519730619980	SUA146
152533	519722509980	SUA138
152550	519730809905	SUA382
152553	519720509900	SUA371
152561	519731139900	SUA383
152582	519731149900	SUA384
152732	510033445802	SUA319
152796	510034066201	SUA287
92552015	510033445802	SUA319

OE/IAM	 LONG SHORT	
--------	-------------------------------------	--

J3	COMANDO INDICATORE LIVELLO CARBURANTE FUEL LEVEL SENDER
-----------	--

PSA		
95493438	510032299601	SUA188
96059564	519722509982	SUA139
96596340	519731359900	SUA512
1478937080	519730619980	SUA146
9638566480	519000059100	SUA591
9647083280	519000058200	SUA582
9649418580	519000059100	SUA591
9652382180	519000056000	SUA560
9657601680	519000058400	SUA584
9659634180	519000058900	SUA589
9659634280	519000058700	SUA587
9659634380	519000058800	SUA588
9671721880	519000055400	SUA554
9671722680	519000056700	SUA567
9674461380	519000056400	SUA564
9674465580	519000056500	SUA565
9681285980	519721349900	SUA497
9684995280	519000057100	SUA571
9685472880	519000057800	SUA578
1525E9	519721499900	SUA405
1525CK	519000059100	SUA591
1525CW	519731309901	SUA465
1525EG	519731149900	SUA384
1525ER	519000058200	SUA582
1525GF	519000056000	SUA560
1525GV	519781129903	SUA520
1525GW	519781129900	SUA519
1525JC	519000058400	SUA584
1525JE	519000057100	SUA571
1525JR	519731359900	SUA512
1525JS	519000058900	SUA589
1525JT	519000058700	SUA587
1525JV	519000058800	SUA588
1525LA	519721349901	SUA510
1525QZ	519000055300	SUA553
1525RL	519000057800	SUA578
1525S8	519722019900	SUA456
1525V3	519732019902	SUA517
1525WL	519000056700	SUA567
1525WY	519000055800	SUA558
1525WZ	519000055700	SUA557
1525XA	519000055900	SUA559
1525Y9	519000059100	SUA591

OE/IAM	 LONG SHORT	
--------	-------------------------------------	--

J3	COMANDO INDICATORE LIVELLO CARBURANTE FUEL LEVEL SENDER
-----------	--

RENAULT		
6025304881	519751529900	SUA398
7700416987	519741659900	SUA394
7700667871	510032241901	SUA187
7700742800	510033584202	SUA239
7700759365	510033397701	SUA220
7700784187	510033625301	SUA351
7700801669	510033762601	SUA265
7700801674	510033762701	SUA266
7701349907	510034000801	SUA278
8200128477	519741659903	SUA412
8200128479	519741659902	SUA411
8200263039	519741859902	SUA518
8200368240	519000056300	SUA563
8200588625	519741779902	SUA511
8200722188	519741659905	SUA514
8200722189	519741659904	SUA513
8200725020	519000055200	SUA552
8200841249	519000058600	SUA586
172020054R	519000058500	SUA585
SIDAT		
71002	510033445802	SUA319
71003	519722509982	SUA139
71004	519722509980	SUA138
71006	519734009980	SUA386
71008	510034066201	SUA287
71009	519731149900	SUA384
71010	519730059981	SUA141
71011	510033531803	SUA230
71012	519730809905	SUA382
71013	519730619980	SUA146
71016	519741659900	SUA394
71019	519751529900	SUA398
71022	119751759960	SUA129
71025	119763009900	SUA424
71054	519731139900	SUA383
71056	519720509900	SUA371
71122	510032299601	SUA188
71126	510033762601	SUA265
71127	510033762701	SUA266
71181	519741659902	SUA411
71182	519741659903	SUA412
71184	510034000801	SUA278
71188	510032241901	SUA187

OE/IAM	MAGNETI MARELLI	
	LONG	SHORT
J3	COMANDO INDICATORE LIVELLO CARBURANTE FUEL LEVEL SENDER	
SIDAT		
71189	510033625301	SUA351
71190	519721499900	SUA405
71200	519000057200	SUA572
71201	519000059000	SUA590
71222	519731309901	SUA465
71263	519741859902	SUA518
71264	519741909900	SUA485
71268	519000057100	SUA571
71269	519722019900	SUA456
71272	519721349901	SUA510
71273	519721349900	SUA497
71277	519000059100	SUA591
71278	519000058200	SUA582
71279	519731359900	SUA512
71280	519000058700	SUA587
71281	519000058800	SUA588
71282	519000058900	SUA589
71283	519732019902	SUA517
71284	519741659904	SUA513
71287	519751569900	SUA516
71288	519781129900	SUA519
71289	519781129903	SUA520
71290	519741779902	SUA511
71299	519000056800	SUA568
71300	519000056300	SUA563
71301	519000055200	SUA552
71302	519000059200	SUA592
71311	519000057600	SUA576
71322	519000057700	SUA577
71324	519000056200	SUA562
71325	519000056000	SUA560
71327	519000058400	SUA584
71328	519000057800	SUA578
71331	519000058300	SUA583
71337	519000055800	SUA558
71338	519000055900	SUA559
71339	519000056700	SUA567
71340	519000056900	SUA569
71341	519000057000	SUA570
71342	519000055700	SUA557
71343	519000056600	SUA566
71350	519000055400	SUA554
71351	519000056100	SUA561

OE/IAM	MAGNETI MARELLI	
	LONG	SHORT
J3	COMANDO INDICATORE LIVELLO CARBURANTE FUEL LEVEL SENDER	
SIDAT		
71353	519000055300	SUA553
71369	519000056400	SUA564
71370	519000056500	SUA565
71374	519000057500	SUA575
71376	519000058100	SUA581
71377	519000057400	SUA574
71378	519000057900	SUA579
71380	519000058600	SUA586
71384	519000057300	SUA573
71387	519000058500	SUA585
SIEMENS VDO		
221824085003Z	519000059100	SUA591
A2C53023015	519000059100	SUA591
X10745002003V	510033625301	SUA351
X10745002004V	510033762601	SUA265
X10745002005V	510033762701	SUA266
X10745002006V	510034000801	SUA278
X10745003001V	510034066201	SUA287
X10745003003V	519730059981	SUA141
X10745003011V	519730619980	SUA146
X10745003013V	519731139900	SUA383
X10745003014V	519731149900	SUA384
X10745003017V	519734009980	SUA386
X10745004001V	119751759960	SUA129
X10745004008V	119763009900	SUA424
TI AUTOMOTIVE		
7110100	519000057600	SUA576
7130100	519000059200	SUA592
7213400	519721349900	SUA497
7213401	519721349901	SUA510
7214900	519721499900	SUA405
7220100	519722019900	SUA456
7225000	519722509980	SUA138
7225002	519722509982	SUA139
7300501	519730059981	SUA141
7306100	519730619980	SUA146
7308005	519730809905	SUA382
7311300	519731139900	SUA383
7311400	519731149900	SUA384
7313000	519000058200	SUA582
7313001	519731309901	SUA465
7313500	519731359900	SUA512
7313501	519000058700	SUA587

OE/IAM	MAGNETI MARELLI	
	LONG	SHORT
J3	COMANDO INDICATORE LIVELLO CARBURANTE FUEL LEVEL SENDER	
TI AUTOMOTIVE		
7313502	519000058800	SUA588
7313503	519000058900	SUA589
7313504	519000055300	SUA553
7314000	519000055700	SUA557
7314001	519000055800	SUA558
7314002	519000055900	SUA559
7317000	519000055400	SUA554
7317001	519000056700	SUA567
7320102	519732019902	SUA517
7340000	519734009980	SUA386
7414400	519000056300	SUA563
7416500	519741659900	SUA394
7416502	519741659902	SUA411
7416503	519741659903	SUA412
7416504	519741659904	SUA513
7416505	519741659905	SUA514
7417702	519741779902	SUA511
7417703	519000055200	SUA552
7418502	519741859902	SUA518
7419000	519741909900	SUA485
7419001	519000056100	SUA561
7500301	519750039901	SUA515
7510600	519000056900	SUA569
7510601	519000057000	SUA570
7513200	519000057700	SUA577
7515200	519751529900	SUA398
7515600	519751569900	SUA516
7517500	119751759960	SUA129
7523201	519000056800	SUA568
7530301	519000057200	SUA572
7530303	519000059000	SUA590
7530600	519000056600	SUA566
7540304	519000058100	SUA581
7540305	519000057900	SUA579
7550307	519000057400	SUA574
7630000	119763009900	SUA424
7811200	519781129900	SUA519
7811201	519781129903	SUA520
7811202	519000059100	SUA591
7816803	519781689903	SUA509
322419010	510032241901	SUA187
322996010	510032299601	SUA188
333977010	510033397701	SUA220

OE/IAM	MAGNETI MARELLI	
	LONG	SHORT
J3	COMANDO INDICATORE LIVELLO CARBURANTE FUEL LEVEL SENDER	
TI AUTOMOTIVE		
334458020	510033445802	SUA319
335318030	510033531803	SUA230
335842020	510033584202	SUA239
336253010	510033625301	SUA351
337626010	510033762601	SUA265
337627010	510033762701	SUA266
340008010	510034000801	SUA278
340662010	510034066201	SUA287
9753039933	519000059000	SUA590
9753039961	519000057200	SUA572
96596341080	519000058900	SUA589
7815200CL	519000058400	SUA584
VAG		
5N0919109B	519000057600	SUA576
5N0919673J	519000059200	SUA592
VALEO		
347352	510033445802	SUA319
347354	510033762601	SUA265
347356	510032241901	SUA187
347357	510032299601	SUA188
347358	519722509980	SUA138
347359	519730059981	SUA141
347361	510033625301	SUA351
347363	519730619980	SUA146
347365	510034000801	SUA278
347366	519721499900	SUA405
347369	519720509900	SUA371
347372	519734009980	SUA386
347374	519731149900	SUA384
347377	119751759960	SUA129
347378	119763009900	SUA424
347380	519741659902	SUA411
347381	510033762701	SUA266
347502	519722019900	SUA456
347503	519731359900	SUA512
347504	519732019902	SUA517
347505	519741659904	SUA513
347507	519741779902	SUA511
347511	519741659900	SUA394
347512	519741659903	SUA412
347515	519741909900	SUA485
347516	519731309901	SUA465
347519	519781129903	SUA520

OE/IAM	MAGNETI MARELLI	
	LONG	SHORT
J3	COMANDO INDICATORE LIVELLO CARBURANTE FUEL LEVEL SENDER	
VALEO		
347522	519000057100	SUA571
347524	519000059200	SUA592
347530	519000056200	SUA562

OE/IAM	MAGNETI MARELLI	
	LONG	SHORT
J2	GRUPPO ASPIRAZIONE CARBURANTE FUEL SUPPLY UNIT	
AIRTEX		
E10252M	519700000163	GA2207
E10288M	519700000179	GA2223
E10289M	519700000178	GA2222
E10313M	519700000050	GA2094
E10315M	519700000088	GA2132
E10320M	519700000160	GA2204
E10341M	519700000127	GA2171
E10348M	519700000182	GA2226
E10389M	519700000040	GA2084
E10401M	519700000129	GA2173
E10403M	519700000073	GA2117
E10405M	519700000140	GA2184
E10406M	519700000116	GA2160
E10408M	519700000154	GA2198
E10418M	519700000075	GA2119
E10466M	519700000164	GA2208
E10469M	519700000010	GA2054
E10472M	519700000147	GA2191
E10473M	519700000096	GA2140
E10478M	519700000001	GA2045
E10485M	519700000041	GA2085
E10486M	519700000016	GA2060
E10595M	519700000037	GA2081
E10600M	519700000152	GA2196
E10625M	519700000177	GA2221
E10635M	519700000139	GA2183
E10636M	519700000072	GA2116
E10645M	519700000135	GA2179
E10650M	519700000118	GA2162
E10657M	519700000112	GA2156
E10665M	519700000099	GA2143
E10666M	519700000085	GA2129
E10677M	519700000067	GA2111
E10722M	519700000080	GA2124
E10723M	519700000167	GA2211
E10724M	519700000142	GA2186

OE/IAM	MAGNETI MARELLI	
	LONG	SHORT
J2	GRUPPO ASPIRAZIONE CARBURANTE FUEL SUPPLY UNIT	
AIRTEX		
E10791M	519700000194	GA2238
BMW		
7260648	519700000189	GA2233
16117210635	519700000063	GA2107
16117260640	519700000188	GA2232
16117260644	519700000187	GA2231
16117260648	519700000189	GA2233
BOSCH		
0580200001	519700000024	GA2068
0580200004	519700000070	GA2114
0580200007	519700000059	GA2103
0580200008	519700000087	GA2131
0580200009	519700000071	GA2115
0580200011	519700000029	GA2073
0580200025	519700000137	GA2181
0580200026	519700000137	GA2181
0580200044	519700000059	GA2103
0580200079	519700000070	GA2114
0580200096	519700000066	GA2110
0580200098	519700000132	GA2176
0580200105	519700000107	GA2151
0580202008	519700000110	GA2154
0580202009	519700000110	GA2154
0580202014	519700000113	GA2157
0580202016	519700000110	GA2154
0580202017	519700000110	GA2154
0580203002	519700000032	GA2076
0580203004	519700000105	GA2149
0580203005	519700000105	GA2149
0580203006	519700000155	GA2199
0580203008	519700000156	GA2200
0580203009	519700000156	GA2200
0580203012	519700000133	GA2177
0580203014	519700000046	GA2090
0580203015	519700000046	GA2090
0580203028	519700000128	GA2172
0580203040	519700000053	GA2097
0580203043	519700000092	GA2136
0580203044	519700000027	GA2071
0580203046	519700000125	GA2169
0580203089	519700000086	GA2130
0580203090	519700000086	GA2130
0580203097	519700000083	GA2127

OE/IAM	 LONG SHORT	
--------	-------------------------------------	--

J2	GRUPPO ASPIRAZIONE CARBURANTE FUEL SUPPLY UNIT	
----	---	--

BOSCH		
0580203098	519700000106	GA2150
0580203101	519700000083	GA2127
0580203102	519700000158	GA2202
0580204000	519700000159	GA2203
0580204001	519700000159	GA2203
0580205006	519700000170	GA2214
0580205007	519700000170	GA2214
0580303001	519700000062	GA2106
0580303002	519030309902	SUA521
0580303007	519030309907	SUA523
0580303008	519030309908	SUA524
0580303010	519030309910	SUA525
0580303011	519700000075	GA2119
0580303012	519030309912	SUA526
0580303013	519030309913	SUA527
0580303014	519700000017	GA2061
0580303016	519030309916	SUA528
0580303017	519030309917	SUA529
0580303019	519700000032	GA2076
0580303020	519700000032	GA2076
0580303021	519700000105	GA2149
0580303022	519700000105	GA2149
0580303027	519030309927	SUA530
0580303028	519030309928	SUA531
0580303033	519030309933	SUA532
0580303034	519030309934	SUA533
0580303036	519700000147	GA2191
0580303047	519700000076	GA2120
0580303048	519700000076	GA2120
0580303049	519700000168	GA2212
0580303050	519700000168	GA2212
0580303052	519700000151	GA2195
0580303053	519700000151	GA2195
0580303060	519700000096	GA2140
0580303061	519030309961	SUA534
0580303062	519700000144	GA2188
0580303063	519700000144	GA2188
0580303082	519030309982	SUA535
0580303083	519700000064	GA2108
0580303084	519700000054	GA2098
0580303085	519700000028	GA2072
0580303088	519700000136	GA2180
0580303089	519700000136	GA2180

OE/IAM	 LONG SHORT	
--------	-------------------------------------	--

J2	GRUPPO ASPIRAZIONE CARBURANTE FUEL SUPPLY UNIT	
----	---	--

BOSCH		
0580303092	519700000155	GA2199
0580303094	519700000156	GA2200
0580303098	519700000133	GA2177
0580303099	519700000133	GA2177
0580303104	519700000027	GA2071
0580303105	519700000057	GA2101
0580303110	519700000158	GA2202
0580303116	519700000130	GA2174
0580305003	519700000149	GA2193
0580305007	519700000140	GA2184
0580310002	519700000163	GA2207
0580310014	519700000163	GA2207
0580310015	519700000116	GA2160
0580313012	519031309912	SUA536
0580313015	519700000026	GA2070
0580313020	519700000058	GA2102
0580313021	519700000043	GA2087
0580313022	519031309922	SUA537
0580313023	519700000052	GA2096
0580313039	519031309939	SUA538
0580313053	519700000129	GA2173
0580313067	519700000055	GA2099
0580313073	519031309973	SUA539
0580313075	519031309975	SUA540
0580313076	519700000010	GA2054
0580313078	519700000073	GA2117
0580313079	519031309979	SUA541
0580313081	519700000018	GA2062
0580313092	519031309992	SUA542
0580313107	519031319907	SUA543
0580313108	519700000001	GA2045
0580313120	519700000109	GA2153
0580314003	519700000169	GA2213
0580314010	519031409910	SUA544
0580314016	519031409916	SUA545
0580314020	519700000164	GA2208
0580314033	519700000090	GA2134
0580314034	519031409934	SUA547
0580314038	519700000044	GA2088
0580314039	519700000044	GA2088
0580314040	519700000034	GA2078
0580314042	519700000036	GA2080
0580314043	519700000036	GA2080

OE/AM	MAGNETI MARELLI	
	LONG	SHORT
J2	GRUPPO ASPIRAZIONE CARBURANTE FUEL SUPPLY UNIT	
BOSCH		
0580314052	519700000006	GA2050
0580314053	519700000006	GA2050
0580314058	519700000078	GA2122
0580314062	519700000150	GA2194
0580314063	519700000150	GA2194
0580314082	519031409982	SUA548
0580314084	519031409984	SUA549
0580314107	519031419907	SUA550
0580314114	519700000120	GA2164
0580314115	519700000120	GA2164
0580314116	519700000003	GA2047
0580314117	519700000003	GA2047
0580314134	519700000049	GA2093
0580314135	519700000049	GA2093
0580314137	519031419937	SUA551
0580314141	519700000011	GA2055
0580314142	519700000011	GA2055
0580314157	519700000005	GA2049
0580314158	519700000005	GA2049
0580314169	519700000041	GA2085
0580314170	519700000041	GA2085
0580314173	519700000016	GA2060
0580314174	519700000016	GA2060
0580314195	519700000104	GA2148
0580314196	519700000104	GA2148
0580314197	519700000048	GA2092
0580314198	519700000048	GA2092
0580314221	519700000030	GA2074
0580314223	519700000082	GA2126
0580314224	519700000066	GA2110
0580314258	519700000015	GA2059
0580314393	519700000078	GA2122
0580464081	519700000106	GA2150
0986580149	519700000143	GA2187
0986580163	519700000152	GA2196
0986580177	519700000088	GA2132
0986580217	519732029902	SUA467
0986580374	519700000114	GA2158
0986580376	519700000099	GA2143
0986580377	519700000135	GA2179
0986580386	519700000185	GA2229
0986580411	519700000192	GA2236
0986580412	519700000191	GA2235

OE/AM	MAGNETI MARELLI	
	LONG	SHORT
J2	GRUPPO ASPIRAZIONE CARBURANTE FUEL SUPPLY UNIT	
BOSCH		
0986580932	519700000127	GA2171
0986580947	519700000185	GA2229
0986580950	519700000192	GA2236
0986580951	519700000191	GA2235
0986580970	519700000181	GA2225
1582881013	519700000159	GA2203
1582881054	519700000159	GA2203
1582980105	519700000169	GA2213
1582980106	519700000169	GA2213
1582980134	519700000138	GA2182
1582980293	519700000146	GA2190
1582980294	519700000159	GA2203
DACIA		
6001547604	519745909900	SUA470
6001547605	519746909900	SUA471
172025090R	519700000039	GA2083
172025758R	519700000009	GA2053
172027123R	519700000025	GA2069
172027786R	519700000038	GA2082
DAEWOO		
96320232	519700000172	GA2216
96563403	519700000172	GA2216
M100AF161	519700000172	GA2216
DELPHI		
28088322	519700000063	GA2107
FE1005012B1	519700000143	GA2187
FE1005912B1	519700000152	GA2196
DENSO		
8HUA149	519700000097	GA2141
KS2920105033	519700000174	GA2218
ERA		
775001	519700000055	GA2099
775006	519700000163	GA2207
775022	519700000088	GA2132
775030	519700000172	GA2216
775044	519700000153	GA2197
775047	519700000179	GA2223
775048	519700000182	GA2226
775049	519700000178	GA2222
775063	519700000111	GA2155
775070	519700000062	GA2106
775091	519700000140	GA2184
775132	519700000057	GA2101

OE/IAM		 LONG SHORT	
J2	GRUPPO ASPIRAZIONE CARBURANTE FUEL SUPPLY UNIT		
ERA			
775133	519700000129	GA2173	
775138	519700000050	GA2094	
775151	519700000058	GA2102	
775167	519700000089	GA2133	
775175	519700000043	GA2087	
775179	519700000160	GA2204	
775198	519700000018	GA2062	
775209	519700000164	GA2208	
775210	519700000127	GA2171	
775225	519700000176	GA2220	
775228	519700000040	GA2084	
775232	519700000083	GA2127	
775238	519700000191	GA2235	
775243	519700000142	GA2186	
775245	519700000147	GA2191	
775246	519700000172	GA2216	
775255	519700000114	GA2158	
775256	519700000143	GA2187	
775257	519700000177	GA2221	
775258	519700000105	GA2149	
775261	519700000192	GA2236	
775264	519700000186	GA2230	
775266	519700000096	GA2140	
775283	519700000066	GA2110	
775284	519700000064	GA2108	
775285	519700000168	GA2212	
775286	519700000151	GA2195	
775287	519700000054	GA2098	
775288	519700000136	GA2180	
775289	519700000150	GA2194	
775293	519700000155	GA2199	
775294	519700000156	GA2200	
775296	519700000159	GA2203	
775297	519700000145	GA2189	
775299	519700000134	GA2178	
775306	519700000194	GA2238	
775308	519700000033	GA2077	
775309	519700000087	GA2131	
775312	519700000079	GA2123	
775314	519700000048	GA2092	
775315	519700000118	GA2162	
775316	519700000120	GA2164	
775317	519700000003	GA2047	

OE/IAM		 LONG SHORT	
J2	GRUPPO ASPIRAZIONE CARBURANTE FUEL SUPPLY UNIT		
ERA			
775318	519700000049	GA2093	
775319	519700000011	GA2055	
775320	519700000005	GA2049	
775322	519700000030	GA2074	
775323	519700000104	GA2148	
775324	519700000082	GA2126	
775325	519700000029	GA2073	
775326	519700000024	GA2068	
775330	519700000078	GA2122	
775331	519700000053	GA2097	
775332	519700000125	GA2169	
775333	519700000092	GA2136	
775337	519700000167	GA2211	
775350	519700000042	GA2086	
775351	519700000019	GA2063	
775352	519700000060	GA2104	
775353	519700000098	GA2142	
775354	519700000038	GA2082	
775355	519700000039	GA2083	
775356	519700000099	GA2143	
775357	519700000002	GA2046	
775358	519700000007	GA2051	
775372	519700000059	GA2103	
775431	519700000190	GA2234	
775433	519700000193	GA2237	
775006B	519700000163	GA2207	
775047B	519700000179	GA2223	
775048B	519700000182	GA2226	
775049B	519700000178	GA2222	
775091B	519700000140	GA2184	
775210B	519700000127	GA2171	
775246B	519700000172	GA2216	
775299B	519700000134	GA2178	
FCA			
7752900	119751769963	SUA130	
7785254	119751769962	SUA133	
13281620	519030309916	SUA528	
13281690	519030309916	SUA528	
46427664	119751769962	SUA133	
46448570	519700000111	GA2155	
46451762	519700000111	GA2155	
46456432	519700000111	GA2155	
46472382	519030309908	SUA524	

OE/IAM		 LONG SHORT	
J2	GRUPPO ASPIRAZIONE CARBURANTE FUEL SUPPLY UNIT		
FCA			
46473394	119751769963	SUA130	
46474139	519700000111	GA2155	
46475714	519762029900	GA2015	
46475719	519766029900	GA2021	
46478788	519031309922	SUA537	
46512837	519030309902	SUA521	
46518013	119766009900	SUA431	
46523407	519762019904	GA2018	
46523409	519030309908	SUA524	
46541845	519762019901	GA2014	
46541852	519030309907	SUA523	
46545426	519030309910	SUA525	
46547424	519700000055	GA2099	
46552836	519031309973	SUA539	
46557116	519700000075	GA2119	
46739809	519766119900	GA2022	
46742146	519030309902	SUA521	
46742380	519030309907	SUA523	
46742382	519030309908	SUA524	
46752003	519031309979	SUA541	
46757664	519031309992	SUA542	
46759865	519762029904	GA2020	
46760845	519700000078	GA2122	
46765167	519030309913	SUA527	
46794445	519766429900	GA2023	
46797141	519031309922	SUA537	
46798595	519700000055	GA2099	
46798695	519700000185	GA2229	
46807439	519030309917	SUA529	
46832868	519031309992	SUA542	
46833635	519700000147	GA2191	
46833708	519030309933	SUA532	
46837160	519031309973	SUA539	
46837359	519031409910	SUA544	
46837427	519031309922	SUA537	
46837429	519031309979	SUA541	
46838198	519700000164	GA2208	
46842972	519031309992	SUA542	
51700804	519031409916	SUA545	
51704083	519700000055	GA2099	
51705573	519031409910	SUA544	
51709819	519700000078	GA2122	
51732522	519700000078	GA2122	

OE/IAM		 LONG SHORT	
J2	GRUPPO ASPIRAZIONE CARBURANTE FUEL SUPPLY UNIT		
FCA			
51741423	519031419907	SUA550	
51741424	519700000096	GA2140	
51742230	519700000064	GA2108	
51746634	519030309908	SUA524	
51755697	519030309928	SUA531	
51762999	519030309982	SUA535	
51767877	519700000054	GA2098	
51787161	519700000024	GA2068	
51806334	519700000066	GA2110	
51806983	519700000185	GA2229	
51806984	519700000185	GA2229	
51807373	519700000082	GA2126	
51807864	519700000071	GA2115	
51818016	519700000087	GA2131	
51821294	519700000029	GA2073	
51821919	519700000185	GA2229	
51827144	519700000053	GA2097	
51831894	519700000130	GA2174	
51868771	519700000066	GA2110	
51868774	519700000132	GA2176	
55700362	519031419937	SUA551	
60628082	519031309912	SUA536	
60628994	519700000062	GA2106	
60629694	519700000058	GA2102	
60629829	519700000043	GA2087	
60652212	519031309939	SUA538	
60654915	519700000040	GA2084	
60663978	519700000018	GA2062	
60664013	519700000062	GA2106	
60665419	519031309975	SUA540	
60665961	519700000010	GA2054	
60667034	519030309912	SUA526	
60667035	519700000017	GA2061	
60670832	519700000058	GA2102	
60670833	519700000043	GA2087	
60670834	519700000062	GA2106	
60677545	519031319907	SUA543	
60679991	519030309934	SUA533	
60682368	519031309975	SUA540	
60682369	519700000010	GA2054	
60684359	519031319907	SUA543	
60684991	519031409934	SUA547	
60814872	519700000043	GA2087	

OE/IAM		 LONG SHORT	
J2	GRUPPO ASPIRAZIONE CARBURANTE FUEL SUPPLY UNIT		
FCA			
60814889	519700000062	GA2106	
60815142	519030309902	SUA521	
60815491	519030309902	SUA521	
60815524	519700000058	GA2102	
60815657	519700000062	GA2106	
60816098	519700000058	GA2102	
60816099	519700000043	GA2087	
60816100	519700000062	GA2106	
60816294	519031309922	SUA537	
60846100	519700000062	GA2106	
93181020	519031409984	SUA549	
93184121	519031409984	SUA549	
467608480	519030309928	SUA531	
759320059	519031319907	SUA543	
1328162080	519030309916	SUA528	
1333640080	519700000001	GA2045	
1341606080	519030309961	SUA534	
1347802080	519700000083	GA2127	
1348741080	519700000106	GA2150	
1348830080	519700000057	GA2101	
1349647080	519700000083	GA2127	
1349649080	519700000158	GA2202	
1370416080	519700000083	GA2127	
1462323080	519730609903	SUA378	
4683753590	519031409910	SUA544	
6066703040	519030309912	SUA526	
9064701094	519030309916	SUA528	
9628530280	519730139905	SUA461	
9637812280	519730139909	SUA463	
9638028680	519732029900	SUA494	
9641798380	519700000001	GA2045	
FORD			
1234552	519700000191	GA2235	
1254193	519700000191	GA2235	
1305354	519700000191	GA2235	
1309160	519700000191	GA2235	
1312617	519700000191	GA2235	
1440716	519700000014	GA2058	
1491778	519700000192	GA2236	
1506989	519700000194	GA2238	
1529595	519700000191	GA2235	
1531359	519700000190	GA2234	
1537880	519700000190	GA2234	

OE/IAM		 LONG SHORT	
J2	GRUPPO ASPIRAZIONE CARBURANTE FUEL SUPPLY UNIT		
FORD			
1540961	519700000185	GA2229	
1593800	519700000093	GA2137	
1593803	519700000061	GA2105	
1602781	519700000191	GA2235	
1695909	519700000193	GA2237	
1754799	519700000193	GA2237	
1809972	519700000190	GA2234	
2S619H307CF	519700000192	GA2236	
3M519H307AA	519700000191	GA2235	
3M519H307AB	519700000191	GA2235	
3M519H307AC	519700000191	GA2235	
3M519H307AD	519700000191	GA2235	
3M519H307AE	519700000191	GA2235	
3M519H307AU	519700000191	GA2235	
3M519H307AV	519700000191	GA2235	
3M519H307LP	519700000093	GA2137	
3S719H307EF	519700000014	GA2058	
5M519H307AJ	519700000061	GA2105	
6G919H307AF	519700000194	GA2238	
8V519H307BB	519700000190	GA2234	
8V519H307BC	519700000190	GA2234	
8V619H307CA	519700000190	GA2234	
AV619H307AC	519700000193	GA2237	
AV619H307AD	519700000193	GA2237	
HYUNDAI			
311102E000	519700000089	GA2133	
3111017005	519700000103	GA2147	
311101F980	519700000079	GA2123	
311101H000	519700000145	GA2189	
311101J800	519700000155	GA2199	
311102E900	519700000079	GA2123	
311102E960	519700000079	GA2123	
INTERMOTOR			
31596	519700000182	GA2226	
IVECO			
69500709	519700000027	GA2071	
69500710	519700000092	GA2136	
69503392	519700000125	GA2169	
69503396	519700000092	GA2136	
69503486	519700000087	GA2131	
69503526	519700000125	GA2169	
69503529	519700000027	GA2071	
69503530	519700000092	GA2136	

OE/IAM	MAGNETI MARELLI	
	LONG	SHORT
J2	GRUPPO ASPIRAZIONE CARBURANTE FUEL SUPPLY UNIT	
KIA		
311101F980	519700000079	GA2123
311101H000	519700000145	GA2189
311102E900	519700000079	GA2123
311102E960	519700000079	GA2123
311102H100	519700000145	GA2189
LAND ROVER		
WFX101070	519700000026	GA2070
WFX101400	519700000052	GA2096
WQC000120	519700000026	GA2070
LUCAS ELECTRICAL		
FDB1047	519700000178	GA2222
MEAT & DORIA		
76426	519720139908	SUA455
76429	519730139905	SUA461
76441	519700000182	GA2226
76446	119751769963	SUA130
76453	119751769962	SUA133
76459	519700000111	GA2155
76462	519762029900	GA2015
76466	119766009900	SUA431
76467	519762019904	GA2018
76468	519762019901	GA2014
76476	519700000153	GA2197
76478	519700000163	GA2207
76479	519730139902	SUA376
76481	519730609903	SUA378
76483	519730809901	SUA380
76484	519730689900	GA2002
76485	519730149901	SUA377
76486	519730069981	SUA142
76488	519740659902	SUA393
76489	519740069980	SUA149
76492	519740069905	SUA390
76493	519740669900	SUA417
76494	519762029904	GA2020
76495	519766119900	GA2022
76499	519030309913	SUA527
76500	519700000017	GA2061
76502	519030309916	SUA528
76503	519030309917	SUA529
76505	519031309939	SUA538
76510	519031309975	SUA540
76511	519700000010	GA2054

OE/IAM	MAGNETI MARELLI	
	LONG	SHORT
J2	GRUPPO ASPIRAZIONE CARBURANTE FUEL SUPPLY UNIT	
MEAT & DORIA		
76512	519031309979	SUA541
76513	519700000018	GA2062
76515	519031409910	SUA544
76525	519730139904	SUA460
76526	519732009905	GA2006
76533	519700000172	GA2216
76542	519766029900	GA2021
76551	519031309912	SUA536
76552	519700000058	GA2102
76553	519700000043	GA2087
76554	519031309922	SUA537
76557	519030309902	SUA521
76558	519909815000	GA2032
76560	519030309907	SUA523
76561	519030309908	SUA524
76564	519030309910	SUA525
76565	519700000075	GA2119
76567	519031309973	SUA539
76568	519031309992	SUA542
76569	519030309912	SUA526
76570	519732029902	SUA467
76571	519751089901	SUA422
76572	519751039901	SUA421
76575	519730809902	SUA381
76576	519700000055	GA2099
76580	519745659901	GA2007
76581	519746669900	GA2011
76582	519745659903	GA2008
76583	519746659901	GA2010
76584	519746659900	GA2009
76585	519732009903	GA2005
76586	519732009900	GA2003
76588	519722009900	GA2000
76590	519700000140	GA2184
76591	519700000116	GA2160
76592	519700000062	GA2106
76597	519030309928	SUA531
76610	519766429900	GA2023
76611	519700000078	GA2122
76805	519700000129	GA2173
76807	519700000073	GA2117
76811	519031409916	SUA545
76819	519730089900	SUA373

OE/IAM	 LONG SHORT	
--------	-------------------------------------	--

J2	GRUPPO ASPIRAZIONE CARBURANTE FUEL SUPPLY UNIT
-----------	---

MEAT & DORIA		
76835	519700000080	GA2124
76836	519700000167	GA2211
76839	519722029900	SUA493
76840	519030309933	SUA532
76841	519031319907	SUA543
76843	519700000154	GA2198
76851	519756679900	GA2028
76852	519730689901	GA2033
76853	519700000127	GA2171
76860	519700000088	GA2132
76868	519730309900	SUA464
76869	519740579905	SUA472
76870	519745909900	SUA470
76871	519746779900	SUA476
76872	519746909900	SUA471
76873	519700000152	GA2196
76874	519751699900	SUA478
76877	519700000185	GA2229
76890	519700000160	GA2204
76929	519700000164	GA2208
76933	519031419937	SUA551
76934	519700000096	GA2140
76935	519031409934	SUA547
76936	519030309934	SUA533
76937	519031419907	SUA550
76938	519700000147	GA2191
76940	519030309961	SUA534
76941	519700000001	GA2045
76942	519030309982	SUA535
76946	519700000089	GA2133
76954	519746859900	GA2031
76955	519700000037	GA2081
76956	519700000031	GA2075
76958	519730329900	GA2041
76965	519700000079	GA2123
76969	519700000103	GA2147
76973	519720139907	SUA454
76974	519700000052	GA2096
76979	519700000150	GA2194
76981	519031409982	SUA548
76983	519732029903	SUA495
76984	519700000142	GA2186
76985	519700000112	GA2156

OE/IAM	 LONG SHORT	
--------	-------------------------------------	--

J2	GRUPPO ASPIRAZIONE CARBURANTE FUEL SUPPLY UNIT
-----------	---

MEAT & DORIA		
76986	519700000179	GA2223
76989	519780059906	SUA446
76992	519730339901	GA2035
76993	519724349903	GA2042
76995	519730359900	GA2036
76997	519734359901	GA2037
76998	519780129900	GA2043
76999	519736309901	GA2038
77000	519745859900	GA2039
77004	519750569900	GA2040
77006	519700000176	GA2220
77007	519700000134	GA2178
77012	519700000030	GA2074
77018	519700000141	GA2185
77023	519700000168	GA2212
77024	519700000032	GA2076
77025	519700000133	GA2177
77026	519700000057	GA2101
77027	519700000130	GA2174
77028	519700000135	GA2179
77030	519700000192	GA2236
77045	519700000104	GA2148
77046	519700000120	GA2164
77048	519700000003	GA2047
77049	519700000049	GA2093
77050	519700000005	GA2049
77051	519700000011	GA2055
77052	519722029900	SUA493
77058	519732029900	SUA494
77063	519700000114	GA2158
77064	519700000082	GA2126
77071	519700000105	GA2149
77074	519700000013	GA2057
77086	519700000118	GA2162
77088	519700000083	GA2127
77089	519700000139	GA2183
77091	519700000177	GA2221
77095	519700000072	GA2116
77096	519700000041	GA2085
77097	519700000016	GA2060
77098	519700000143	GA2187
77102	519700000054	GA2098
77103	519700000106	GA2150

OE/AM	MAGNETI MARELLI	
	LONG	SHORT
J2	GRUPPO ASPIRAZIONE CARBURANTE FUEL SUPPLY UNIT	
MEAT & DORIA		
77116	519700000029	GA2073
77118	519700000024	GA2068
77120	519700000053	GA2097
77127	519700000125	GA2169
77128	519700000092	GA2136
77134	519700000087	GA2131
77139	519700000158	GA2202
77141	519700000155	GA2199
77142	519700000169	GA2213
77143	519700000191	GA2235
77144	519700000093	GA2137
77156	519700000069	GA2113
77159	519700000136	GA2180
77161	519700000109	GA2153
77162	519700000044	GA2088
77167	519700000151	GA2195
77168	519700000144	GA2188
77169	519700000064	GA2108
77171	519700000132	GA2176
77180	519700000102	GA2146
77183	519700000040	GA2084
77184	519700000174	GA2218
77185	519700000081	GA2125
77186	519700000056	GA2100
77193	519700000094	GA2138
77198	519700000067	GA2111
77200	519700000099	GA2143
77201	519700000085	GA2129
77204	519700000156	GA2200
77206	519700000159	GA2203
77207	519700000033	GA2077
77208	519700000021	GA2065
77209	519700000004	GA2048
77210	519700000042	GA2086
77220	519700000068	GA2112
77222	519700000051	GA2095
77225	519700000028	GA2072
77226	519700000027	GA2071
77244	519700000002	GA2046
77245	519700000019	GA2063
77246	519700000060	GA2104
77247	519700000007	GA2051
77248	519700000098	GA2142

OE/AM	MAGNETI MARELLI	
	LONG	SHORT
J2	GRUPPO ASPIRAZIONE CARBURANTE FUEL SUPPLY UNIT	
MEAT & DORIA		
77249	519700000122	GA2166
77250	519700000121	GA2165
77251	519700000124	GA2168
77252	519700000123	GA2167
77255	519700000026	GA2070
77276	519700000189	GA2233
77277	519700000187	GA2231
77278	519700000188	GA2232
77279	519700000020	GA2064
77280	519700000038	GA2082
77281	519700000039	GA2083
77282	519700000022	GA2066
77287	519700000086	GA2130
77288	519700000166	GA2210
77290	519700000046	GA2090
77292	519700000170	GA2214
77293	519700000090	GA2134
77295	519700000006	GA2050
77296	519700000036	GA2080
77301	519700000050	GA2094
77305	519700000048	GA2092
77306	519700000146	GA2190
77307	519700000128	GA2172
77308	519700000015	GA2059
77310	519700000071	GA2115
77325	519700000000	GA2044
77328	519700000183	GA2227
77331	519700000145	GA2189
77333	519700000137	GA2181
77342	519700000070	GA2114
77343	519700000059	GA2103
77344	519700000066	GA2110
77348	519700000138	GA2182
77350	519700000181	GA2225
77351	519700000034	GA2078
77352	519700000113	GA2157
77353	519700000110	GA2154
77354	519700000101	GA2145
77374	519700000161	GA2205
77376	519700000076	GA2120
77377	519700000107	GA2151
77406	519700000194	GA2238
76414C	519700000178	GA2222

OE/IAM	MAGNETI MARELLI	
	LONG	SHORT
J2	GRUPPO ASPIRAZIONE CARBURANTE FUEL SUPPLY UNIT	
MERCEDES-BENZ		
1684702894	519700000161	GA2205
1694700494	519751699900	SUA478
1694700594	519700000168	GA2212
1694701294	519700000168	GA2212
2034707394	519700000146	GA2190
2044700394	519700000068	GA2112
2044700594	519700000159	GA2203
2044701294	519700000159	GA2203
2124700194	519700000124	GA2168
2124700494	519700000122	GA2166
2124701094	519700000123	GA2167
2124701594	519700000098	GA2142
2124701894	519700000121	GA2165
6394701194	519700000105	GA2149
6394701494	519700000032	GA2076
6394701594	519700000105	GA2149
6394701794	519700000105	GA2149
6394702094	519700000086	GA2130
9064700994	519700000046	GA2090
9064701894	519700000155	GA2199
9064701994	519700000156	GA2200
9064702194	519700000133	GA2177
9064703094	519700000155	GA2199
9064703194	519700000156	GA2200
9064703494	519700000133	GA2177
9064703694	519700000046	GA2090
A1694700494	519751699900	SUA478
A1694700594	519700000168	GA2212
A1694701294	519700000168	GA2212
A2034707394	519700000146	GA2190
A2044700394	519700000068	GA2112
A2044700594	519700000159	GA2203
A2044701294	519700000159	GA2203
A2124700194	519700000124	GA2168
A2124700494	519700000122	GA2166
A2124701094	519700000123	GA2167
A2124701594	519700000098	GA2142
A2124701894	519700000121	GA2165
A6394701194	519700000105	GA2149
A6394701494	519700000032	GA2076
A6394701594	519700000105	GA2149
A6394701794	519700000105	GA2149
A6394702094	519700000086	GA2130

OE/IAM	MAGNETI MARELLI	
	LONG	SHORT
J2	GRUPPO ASPIRAZIONE CARBURANTE FUEL SUPPLY UNIT	
MERCEDES-BENZ		
A9064700994	519700000046	GA2090
A9064701894	519700000155	GA2199
A9064701994	519700000156	GA2200
A9064702194	519700000133	GA2177
A9064703094	519700000155	GA2199
A9064703194	519700000156	GA2200
A9064703494	519700000133	GA2177
A9064703694	519700000046	GA2090
MINI		
2752287	519750569900	GA2040
7233996	519700000084	GA2128
16117294387	519700000084	GA2128
MITSUBISHI		
MN186225	519700000076	GA2120
MN186226	519700000152	GA2196
MR597291	519700000076	GA2120
SMN186226	519700000152	GA2196
NISSAN		
170401HJ0A	519700000100	GA2144
170401KC0A	519700000065	GA2109
17040AV705	519700000150	GA2194
17040AX000	519756679900	GA2028
17040BN800	519700000109	GA2153
17040BN805	519700000150	GA2194
17040JD01A	519700000118	GA2162
OPEL		
1232368	519700000059	GA2103
1232369	519700000128	GA2172
1232392	519700000128	GA2172
5802006	519700000169	GA2213
5815010	519700000151	GA2195
5815046	519700000120	GA2164
5815055	519700000136	GA2180
5815058	519700000104	GA2148
5815064	519700000030	GA2074
13129983	519700000003	GA2047
13152292	519700000056	GA2100
13157597	519700000169	GA2213
13226970	519700000081	GA2125
13238850	519700000048	GA2092
13268621	519700000070	GA2114
13303514	519700000128	GA2172
15776392	519700000059	GA2103

OE/AM	MAGNETI MARELLI	
	LONG	SHORT
J2	GRUPPO ASPIRAZIONE CARBURANTE FUEL SUPPLY UNIT	
OPEL		
15776410	519700000128	GA2172
93178629	519700000169	GA2213
93181019	519031409982	SUA548
93181020	519031409984	SUA549
93181022	519700000151	GA2195
93184120	519031409982	SUA548
93184121	519031409984	SUA549
93187041	519700000011	GA2055
93187095	519700000120	GA2164
93187096	519700000049	GA2093
93187097	519700000003	GA2047
93187098	519700000144	GA2188
93187099	519700000005	GA2049
93188871	519700000136	GA2180
93188873	519700000048	GA2092
93188874	519700000104	GA2148
93189594	519700000030	GA2074
93277517	519700000153	GA2197
PIEBURG		
70046808	519700000163	GA2207
70046874	519700000037	GA2081
70046882	519700000152	GA2196
70046885	519700000176	GA2220
72281050	519700000161	GA2205
700468080	519700000163	GA2207
700468410	519700000040	GA2084
700468740	519700000037	GA2081
700468750	519700000154	GA2198
700468820	519700000152	GA2196
700468850	519700000176	GA2220
700468860	519700000186	GA2230
700468950	519700000160	GA2204
700661110	519700000192	GA2236
700661160	519700000014	GA2058
700661190	519700000191	GA2235
702550250	519700000080	GA2124
702550260	519700000167	GA2211
702550320	519700000142	GA2186
702552190	519700000089	GA2133
702552210	519700000079	GA2123
702700370	519700000031	GA2075
702700530	519700000135	GA2179
702701020	519700000112	GA2156

OE/AM	MAGNETI MARELLI	
	LONG	SHORT
J2	GRUPPO ASPIRAZIONE CARBURANTE FUEL SUPPLY UNIT	
PIEBURG		
702701030	519700000004	GA2048
702701040	519700000021	GA2065
702701090	519700000102	GA2146
702701100	519700000141	GA2185
702701140	519700000118	GA2162
702701210	519700000072	GA2116
702701230	519700000139	GA2183
702701330	519700000177	GA2221
702701350	519700000121	GA2165
702701360	519700000122	GA2166
702701370	519700000123	GA2167
702701380	519700000124	GA2168
702701410	519700000098	GA2142
702701520	519700000067	GA2111
702701590	519700000187	GA2231
702701600	519700000188	GA2232
702701790	519700000042	GA2086
702701850	519700000019	GA2063
702701870	519700000189	GA2233
702701880	519700000185	GA2229
702701950	519700000101	GA2145
703794000	519700000062	GA2106
703794070	519700000017	GA2061
705656050	519700000132	GA2176
722810500	519700000161	GA2205
728302000	519700000080	GA2124
PSA		
145097	519700000116	GA2160
145099	519700000163	GA2207
145505	519700000163	GA2207
145507	519700000149	GA2193
145508	519700000140	GA2184
145509	519700000116	GA2160
145599	519700000163	GA2207
152530	519730609903	SUA378
152543	519736059900	GA2025
152546	519730809901	SUA380
152555	519720139908	SUA455
152575	519730809902	SUA381
152577	519730139905	SUA461
152595	519730139902	SUA376
96097633	519700000149	GA2193
96102709	519700000163	GA2207

OE/IAM	MAGNETI MARELLI	
	LONG	SHORT
J2	GRUPPO ASPIRAZIONE CARBURANTE FUEL SUPPLY UNIT	
PSA		
96103451	519700000140	GA2184
96103453	519700000116	GA2160
96107921	519730069981	SUA142
96170645	519700000163	GA2207
96174897	519700000163	GA2207
96182649	519700000140	GA2184
96182650	519700000116	GA2160
96304560	519730139909	SUA463
96378122	519730139909	SUA463
96421243	519700000160	GA2204
961082650	519700000116	GA2160
1607402180	519700000171	GA2215
1607402380	519700000177	GA2221
9610345180	519700000116	GA2160
9610345380	519700000116	GA2160
9622348880	519736059900	GA2025
9624610080	519720139908	SUA455
9624610480	519720139908	SUA455
9628530280	519730139905	SUA461
9631944080	519730139902	SUA376
9632672280	519722029900	SUA493
9637991580	519720139907	SUA454
9638028680	519732029900	SUA494
9638028780	519785129901	SUA468/1
9639913680	519720139907	SUA454
9640626980	519722029900	SUA493
9642124180	519785129901	SUA468/1
9642124380	519700000160	GA2204
9649418380	519700000177	GA2221
9657036080	519700000033	GA2077
9658347980	519700000166	GA2210
9659633780	519730359900	GA2036
9659633880	519734359901	GA2037
9659867780	519700000154	GA2198
9670326180	519700000002	GA2046
9670326580	519700000019	GA2063
9671720180	519700000007	GA2051
9681234180	519700000114	GA2158
9681235080	519700000114	GA2158
9683422780	519700000067	GA2111
9684934780	519700000033	GA2077
9685471980	519700000099	GA2143
9685472380	519700000085	GA2129

OE/IAM	MAGNETI MARELLI	
	LONG	SHORT
J2	GRUPPO ASPIRAZIONE CARBURANTE FUEL SUPPLY UNIT	
PSA		
9687223580	519700000020	GA2064
9900055000	519700000149	GA2193
09900063000	519700000163	GA2207
1525A7	519720139908	SUA455
1525AW	519700000015	GA2059
1525C2	519730139906	SUA462
1525CH	519730329900	GA2041
1525CJ	519700000177	GA2221
1525CR	519700000154	GA2198
1525CT	519730309900	SUA464
1525EY	519700000037	GA2081
1525F7	519730149901	SUA377
1525FC	519736309901	GA2038
1525FE	519700000031	GA2075
1525GE	519700000181	GA2225
1525GS	519700000166	GA2210
1525GX	519700000171	GA2215
1525GY	519780129900	GA2043
1525GZ	519700000033	GA2077
1525H2	519730139906	SUA462
1525H4	519730139906	SUA462
1525H8	519730689900	GA2002
1525HG	519730329900	GA2041
1525HH	519700000154	GA2198
1525K8	519730089900	SUA373
1525KH	519724349903	GA2042
1525LE	519730339901	GA2035
1525LR	519700000015	GA2059
1525N7	519732009900	GA2003
1525N9	519785129901	SUA468/1
1525NQ	519700000114	GA2158
1525NT	519700000074	GA2118
1525PZ	519700000033	GA2077
1525Q4	519722009900	GA2000
1525Q5	519722029900	SUA493
1525QA	519700000171	GA2215
1525R2	519730689901	GA2033
1525R3	519720139907	SUA454
1525RH	519700000099	GA2143
1525RJ	519700000085	GA2129
1525RV	519700000042	GA2086
1525S9	519732009905	GA2006
1525SY	519700000067	GA2111

OE/IAM		MAGNETI MARELLI	
		LONG	SHORT
J2	GRUPPO ASPIRAZIONE CARBURANTE FUEL SUPPLY UNIT		
PSA			
1525T2	519730139904	SUA460	
1525T4	519720139907	SUA454	
1525TC	519700000020	GA2064	
1525V4	519732029902	SUA467	
1525VA	519700000163	GA2207	
1525W1	519732029903	SUA495	
1525W5	519722029900	SUA493	
1525W7	519722029900	SUA493	
1525WH	519700000007	GA2051	
1525WK	519700000060	GA2104	
1525XF	519700000019	GA2063	
1525XG	519700000002	GA2046	
1525Y1	519732009903	GA2005	
1525Y2	519785129901	SUA468/1	
1525Y4	519785129901	SUA468/1	
1525Y8	519730329900	GA2041	
1525Z0	519700000177	GA2221	
1525Z1	519730139909	SUA463	
1525Z2	519730139906	SUA462	
1525Z3	519030309927	SUA530	
RENAULT			
6025315873	519700000088	GA2132	
7700416988	519740659902	SUA393	
7700418353	519740669900	SUA417	
7700432007	519745659901	GA2007	
7700820287	519740069980	SUA149	
7700823110	519740579905	SUA472	
7700849037	519740069905	SUA390	
8200004964	519700000129	GA2173	
8200027963	519745659903	GA2008	
8200057324	519746659900	GA2009	
8200058354	519746669900	GA2011	
8200071331	519700000073	GA2117	
8200112805	519746659901	GA2010	
8200159254	519700000183	GA2227	
8200195827	519746779900	SUA476	
8200263038	519746859900	GA2031	
8200290356	519700000143	GA2187	
8200355945	519745859900	GA2039	
8200368239	519700000135	GA2179	
8200667803	519700000143	GA2187	
8200667805	519745859900	GA2039	
8200683203	519700000183	GA2227	

OE/IAM		MAGNETI MARELLI	
		LONG	SHORT
J2	GRUPPO ASPIRAZIONE CARBURANTE FUEL SUPPLY UNIT		
RENAULT			
8200725023	519700000000	GA2044	
8200727736	519746779900	SUA476	
8200889201	519700000051	GA2095	
8200906231	519700000000	GA2044	
8200957882	519700000051	GA2095	
172020029R	519700000137	GA2181	
172020093R	519700000013	GA2057	
172024329R	519700000051	GA2095	
172026517R	519700000077	GA2121	
ROVER			
WFX100631	519751089901	SUA422	
WFX101010	519751039901	SUA421	
WFX101400	519700000052	GA2096	
SAAB			
5196415	519780059906	SUA446	
5328679	519780059904	SUA444	
30587077	519700000050	GA2094	
SIDAT			
72007	119766009900	SUA431	
72008	119751769963	SUA130	
72011	519762019904	GA2018	
72013	519762029900	GA2015	
72015	519762019901	GA2014	
72037	519700000111	GA2155	
72041	519766029900	GA2021	
72057	519700000179	GA2223	
72062	519700000182	GA2226	
72063	519700000178	GA2222	
72074	519762019904	GA2018	
72079	519700000153	GA2197	
72086	519762019904	GA2018	
72087	519030309908	SUA524	
72088	519030309902	SUA521	
72089	519030309907	SUA523	
72131	519700000172	GA2216	
72141	519766429900	GA2023	
72142	519030309913	SUA527	
72143	519031309979	SUA541	
72144	519762029904	GA2020	
72167	519031309922	SUA537	
72170	519031309992	SUA542	
72180	519031309912	SUA536	
72201	519030309912	SUA526	

OE/IAM			
		LONG	SHORT
J2	GRUPPO ASPIRAZIONE CARBURANTE FUEL SUPPLY UNIT		
SIDAT			
72202	519030309916	SUA528	
72203	519030309917	SUA529	
72204	519030309928	SUA531	
72209	519031309975	SUA540	
72213	519031409910	SUA544	
72214	519700000053	GA2097	
72215	519700000024	GA2068	
72239	519030309933	SUA532	
72241	519031319907	SUA543	
72254	519780059904	SUA444	
72255	519780059906	SUA446	
72259	519700000127	GA2171	
72278	519030309908	SUA524	
72285	519031419937	SUA551	
72287	519031409916	SUA545	
72288	519031409934	SUA547	
72289	519030309934	SUA533	
72290	519031419907	SUA550	
72293	519030309961	SUA534	
72295	519030309982	SUA535	
72300	519700000089	GA2133	
72345	519700000134	GA2178	
72378	519700000072	GA2116	
72396	519700000139	GA2183	
72400	519700000068	GA2112	
72410	519700000021	GA2065	
72411	519700000004	GA2048	
72417	519700000051	GA2095	
72420	519700000161	GA2205	
72445	519700000030	GA2074	
72452	519700000174	GA2218	
72453	519700000143	GA2187	
72455	519700000040	GA2084	
72456	519700000081	GA2125	
72457	519700000056	GA2100	
72476	519700000013	GA2057	
72482	519700000094	GA2138	
72489	519700000014	GA2058	
72504	519700000093	GA2137	
72513	519700000191	GA2235	
72516	519700000069	GA2113	
72519	519700000033	GA2077	
72538	519700000155	GA2199	

OE/IAM			
		LONG	SHORT
J2	GRUPPO ASPIRAZIONE CARBURANTE FUEL SUPPLY UNIT		
SIDAT			
72541	519700000159	GA2203	
72542	519700000061	GA2105	
72604	519700000130	GA2174	
72614	519700000132	GA2176	
72615	519700000133	GA2177	
72616	519700000026	GA2070	
72619	519700000169	GA2213	
72627	519700000087	GA2131	
72629	519700000029	GA2073	
72643	519700000103	GA2147	
72644	519700000079	GA2123	
72651	519700000176	GA2220	
72683	519700000190	GA2234	
72684	519700000166	GA2210	
72685	519700000086	GA2130	
72693	519700000146	GA2190	
72704	519700000145	GA2189	
72708	519700000059	GA2103	
72716	519700000000	GA2044	
72722	519700000063	GA2107	
72723	519700000009	GA2053	
72725	519700000025	GA2069	
72730	519700000138	GA2182	
72744	519700000097	GA2141	
72748	519700000077	GA2121	
SIEMENS VDO			
220212007002	519700000141	GA2185	
228216003017	519700000056	GA2100	
228216003043	519700000081	GA2125	
228225020001	519700000179	GA2223	
228225020004	519700000179	GA2223	
228225021001	519700000178	GA2222	
228225021004	519700000178	GA2222	
405058005001	519700000182	GA2226	
405058005011	519700000182	GA2226	
220212007001Z	519700000102	GA2146	
228222015010Z	519700000160	GA2204	
228225020001Z	519700000179	GA2223	
228225020004Z	519700000179	GA2223	
228225021001Z	519700000178	GA2222	
228225021004Z	519700000178	GA2222	
228233001003Z	519700000182	GA2226	
228233002009Z	519700000127	GA2171	

OE/IAM	MAGNETI MARELLI	
	LONG	SHORT
J2	GRUPPO ASPIRAZIONE CARBURANTE FUEL SUPPLY UNIT	
SIEMENS VDO		
228233003001Z	519700000186	GA2230
228233021003Z	519700000176	GA2220
405058005011Z	519700000182	GA2226
A2C51841661	519700000094	GA2138
A2C53006273	519700000166	GA2210
A2C53021868	519700000176	GA2220
A2C53030558	519700000177	GA2221
A2C53166110	519700000134	GA2178
A2C53181202	519700000141	GA2185
A2C53287860Z	519700000194	GA2238
A2C59511690	519700000182	GA2226
A2C59514063	519700000014	GA2058
E405058005011	519700000182	GA2226
X10745003008V	519700000163	GA2207
SMART		
4544700094	519700000152	GA2196
4544700194	519700000076	GA2120
A4544700094	519700000152	GA2196
SUZUKI		
1510062J01	519700000101	GA2145
TI AUTOMOTIVE		
7201307	519720139907	SUA454
7201308	519720139908	SUA455
7203400	519700000114	GA2158
7203401	519722009900	GA2000
7220200	519722029900	SUA493
7243403	519724349903	GA2042
7300601	519730069981	SUA142
7300800	519730089900	SUA373
7301001	519700000163	GA2207
7301100	519700000037	GA2081
7301302	519730139902	SUA376
7301304	519730139904	SUA460
7301305	519730139905	SUA461
7301306	519730139909	SUA463
7301309	519730139906	SUA462
7301401	519730149901	SUA377
7303000	519730309900	SUA464
7303002	519700000020	GA2064
7303100	519700000154	GA2198
7303200	519730329900	GA2041
7303301	519730339901	GA2035
7303500	519730359900	GA2036

OE/IAM	MAGNETI MARELLI	
	LONG	SHORT
J2	GRUPPO ASPIRAZIONE CARBURANTE FUEL SUPPLY UNIT	
TI AUTOMOTIVE		
7303600	519700000067	GA2111
7304000	519700000002	GA2046
7304001	519700000019	GA2063
7305100	519700000099	GA2143
7305101	519700000085	GA2129
7306003	519730609903	SUA378
7306800	519730689900	GA2002
7306801	519730689901	GA2033
7307000	519700000060	GA2104
7307001	519700000007	GA2051
7308001	519730809901	SUA380
7308002	519730809902	SUA381
7320000	519732009900	GA2003
7320003	519732009903	GA2005
7320005	519732009905	GA2006
7320100	519700000160	GA2204
7320200	519732029900	SUA494
7320202	519732029902	SUA467
7320203	519732029903	SUA495
7343501	519734359901	GA2037
7343700	519700000074	GA2118
7360500	519736059900	GA2025
7363001	519736309901	GA2038
7363002	519700000031	GA2075
7400600	519740069980	SUA149
7400605	519740069905	SUA390
7405705	519740579905	SUA472
7406502	519740659902	SUA393
7406600	519740669900	SUA417
7437701	519700000000	GA2044
7456501	519745659901	GA2007
7456503	519745659903	GA2008
7456504	519700000183	GA2227
7457700	519700000143	GA2187
7458500	519745859900	GA2039
7459000	519745909900	SUA470
7464400	519700000135	GA2179
7466500	519746659900	GA2009
7466501	519746659901	GA2010
7466600	519746669900	GA2011
7467702	519746779900	SUA476
7468500	519746859900	GA2031
7469000	519746909900	SUA471

OE/IAM	MAGNETI MARELLI	
	LONG	SHORT
J2	GRUPPO ASPIRAZIONE CARBURANTE FUEL SUPPLY UNIT	
TI AUTOMOTIVE		
7469005	519700000038	GA2082
7469006	519700000039	GA2083
7500601	519700000121	GA2165
7500602	519700000122	GA2166
7500603	519700000123	GA2167
7500604	519700000124	GA2168
7505202	519700000088	GA2132
7505600	519750569900	GA2040
7506900	519700000152	GA2196
7510301	519751039901	SUA421
7510801	519751089901	SUA422
7511004	519700000189	GA2233
7516900	519751699900	SUA478
7517602	119751769962	SUA133
7517603	119751769963	SUA130
7520600	519700000098	GA2142
7521006	519700000187	GA2231
7521007	519700000188	GA2232
7525600	519700000084	GA2128
7561200	519700000065	GA2109
7563200	519700000118	GA2162
7566700	519756679900	GA2028
7620101	519762019901	GA2014
7620200	519762029900	GA2015
7620202	519700000040	GA2084
7620204	519762029904	GA2020
7660000	119766009900	SUA431
7660200	519766029900	GA2021
7661100	519766119900	GA2022
7661101	519762019904	GA2018
7661302	519700000040	GA2084
7664200	519766429900	GA2023
7800202	519700000185	GA2229
7800203	519700000078	GA2122
7800504	519780059904	SUA444
7800505	519700000050	GA2094
7800506	519780059906	SUA446
7800901	519700000176	GA2220
7800902	519700000186	GA2230
7801200	519780129900	GA2043
7801201	519700000033	GA2077
7801403	519700000100	GA2144
7804100	519700000181	GA2225

OE/IAM	MAGNETI MARELLI	
	LONG	SHORT
J2	GRUPPO ASPIRAZIONE CARBURANTE FUEL SUPPLY UNIT	
TI AUTOMOTIVE		
7804200	519700000101	GA2145
7805201	519700000042	GA2086
7810900	519700000080	GA2124
7810901	519700000102	GA2146
7810902	519700000141	GA2185
7810904	519700000167	GA2211
7811900	519700000112	GA2156
7811901	519700000142	GA2186
7851201	519785129901	SUA468/1
7851203	519700000177	GA2221
7851204	519700000171	GA2215
72198150	519909815000	GA2032
08712029900	519700000022	GA2066
09720349900	519700000114	GA2158
09730109901	519700000163	GA2207
09730119900	519700000037	GA2081
09730309902	519700000020	GA2064
09730319900	519700000154	GA2198
09734209601	519700000181	GA2225
09745779900	519700000143	GA2187
09746449900	519700000135	GA2179
09750529902	519700000088	GA2132
09750699900	519700000152	GA2196
09752569900	519700000084	GA2128
09756129900	519700000065	GA2109
0974377990104	519700000000	GA2044
TOYOTA		
7702002130	519700000097	GA2141
7702002380	519700000097	GA2141
770200K070	519700000174	GA2218
772400H010	519700000181	GA2225
VAG		
1H0919051AJ	519700000178	GA2222
1H0919051AK	519700000179	GA2223
1H0919051K	519700000178	GA2222
1H0919051L	519700000179	GA2223
1H0919651L	519909815000	GA2032
1H9919051A	519909815000	GA2032
1H9919051L	519909815000	GA2032
1HM919051J	519909815000	GA2032
1HM919051L	519909815000	GA2032
1HM919051M	519909815000	GA2032
1HO919051AK	519909815000	GA2032

OE/IAM		MAGNETI MARELLI	
		LONG	SHORT
J2	GRUPPO ASPIRAZIONE CARBURANTE FUEL SUPPLY UNIT		
VAG			
1HO919051AL	519909815000	GA2032	
1HO919051L	519909815000	GA2032	
1HO919051M	519909815000	GA2032	
1HO919051P	519909815000	GA2032	
1J0919050B	519700000080	GA2124	
1J0919051D	519700000182	GA2226	
1J0919091C	519700000182	GA2226	
1J0919098H	519700000182	GA2226	
1K0919050AB	519700000167	GA2211	
1K0919050B	519700000167	GA2211	
1K0919050D	519700000167	GA2211	
1K0919050J	519700000167	GA2211	
1K0919050Q	519700000167	GA2211	
1K0919051AE	519700000134	GA2178	
1K0919051BH	519700000134	GA2178	
1S0919051A	519700000107	GA2151	
1S0919051B	519700000107	GA2151	
1S0919087	519700000107	GA2151	
2K0919088E	519700000022	GA2066	
357919051M	519909815000	GA2032	
357919051N	519909815000	GA2032	
3A5919051K	519909815000	GA2032	
3A5919051L	519909815000	GA2032	
3A5919051N	519909815000	GA2032	
3A5919051P	519909815000	GA2032	
3A9919051K	519909815000	GA2032	
3A9919051L	519909815000	GA2032	
3A9919051N	519909815000	GA2032	
3A9919051P	519909815000	GA2032	
3B0919051C	519700000127	GA2171	
3C0919050A	519700000004	GA2048	
3C0919050AA	519700000142	GA2186	
3C0919050C	519700000021	GA2065	
3C0919050D	519700000112	GA2156	
3C0919050E	519700000142	GA2186	
3C0919050F	519700000112	GA2156	
3C0919050G	519700000142	GA2186	
3C0919050P	519700000021	GA2065	
5N0919050F	519700000139	GA2183	
5N0919050G	519700000139	GA2183	
5N0919051G	519700000072	GA2116	
5N0919087E	519700000072	GA2116	
5N0919088D	519700000139	GA2183	

OE/IAM		MAGNETI MARELLI	
		LONG	SHORT
J2	GRUPPO ASPIRAZIONE CARBURANTE FUEL SUPPLY UNIT		
VAG			
5N0919050D	519700000139	GA2183	
5N0919051G	519700000072	GA2116	
6N0919051N	519700000186	GA2230	
6N0919051R	519700000186	GA2230	
6Q0919050	519700000102	GA2146	
6Q0919050A	519700000141	GA2185	
6Q0919050C	519700000141	GA2185	
6Q0919051C	519700000176	GA2220	
6Q0919051D	519700000176	GA2220	
6Q0919051G	519700000176	GA2220	
6Q0919051J	519700000176	GA2220	
8C0919051H	519700000094	GA2138	
8K0919050F	519700000170	GA2214	
8K0919050L	519700000170	GA2214	
8K0919051F	519700000113	GA2157	
8K0919051G	519700000110	GA2154	
8K0919051L	519700000113	GA2157	
8K0919051P	519700000110	GA2154	
8K0919051Q	519700000113	GA2157	
8K0919087	519700000113	GA2157	
8K0919088	519700000170	GA2214	
8L0919051B	519700000182	GA2226	
8X0919051C	519700000182	GA2226	
VALEO			
347017	519700000163	GA2207	
347075	519700000040	GA2084	
VEMO			
V24090012	519700000040	GA2084	
VOLVO			
8616812	519700000090	GA2134	
8621028	519700000138	GA2182	
8629716	519700000006	GA2050	
8629717	519700000034	GA2078	
8629902	519700000006	GA2050	
8629903	519700000034	GA2078	
8629904	519700000036	GA2080	
8638671	519700000044	GA2088	
8638703	519700000036	GA2080	
8683785	519700000090	GA2134	
30636878	519700000138	GA2182	
30647236	519700000034	GA2078	
30671142	519700000090	GA2134	
30678442	519700000006	GA2050	

OE/IAM	MAGNETI MARELLI	
	LONG	SHORT
J2	GRUPPO ASPIRAZIONE CARBURANTE FUEL SUPPLY UNIT	
VOLVO		
30742369	519700000028	GA2072
30761739	519700000138	GA2182
30769064	519700000041	GA2085
30778600	519700000016	GA2060
30778660	519700000044	GA2088
30778661	519700000034	GA2078
30778663	519700000006	GA2050
30778664	519700000036	GA2080
30792391	519700000044	GA2088
30792394	519700000016	GA2060
30792395	519700000036	GA2080
30792396	519700000041	GA2085
30792594	519700000028	GA2072
30792725	519700000044	GA2088
30792726	519700000036	GA2080
30792777	519700000034	GA2078
30792779	519700000006	GA2050
30794758	519700000090	GA2134
31212232	519700000034	GA2078
31261266	519700000036	GA2080
31261425	519700000036	GA2080
31261543	519700000006	GA2050
31305129	519700000069	GA2113
4N519D307L	519700000006	GA2050

OE/IAM	MAGNETI MARELLI	
	LONG	SHORT
J1	POMPA CARBURANTE FUEL PUMP	
AIRTEX		
E10221	219900000092	ESS0092A
E10243	219031409968	ESS529
E10258	219031409997	ESS530
E10351M	219900000042	ESS0042A
E10364	219025499950	ESS528
E10400	219046409989	ESS535
E10436	219900000165	ESS0165A
E10438	219900000174	ESS0174A
E10514	217555130000	ESS514
E10518	219900000021	ESS0021A
E10535	219045349965	ESS532
E10639	219900000003	ESS0003A
E7221	219900000015	ESS0015A
E8229	219045349908	ESS531

OE/IAM	MAGNETI MARELLI	
	LONG	SHORT
J1	POMPA CARBURANTE FUEL PUMP	
BBT		
EFP1305	217750715000	ESS452
EFP1503	219046409989	ESS535
EFP1510	620504010061	PB507
EFP302	219031409968	ESS529
EFP702	219031409997	ESS530
EFP705	219721287530	PI024
BMW		
1115862	219721287530	PI024
1118662	219721287530	PI024
1178751	219721287530	PI024
1179231	219721287530	PI024
1179232	219721287530	PI024
1179415	219972229250	ESS524
1180504	219972229250	ESS524
1182842	219972229250	ESS524
1182985	219972229250	ESS524
1183139	219972229250	ESS524
1183176	219972201302	ESS519
1183216	219972201302	ESS519
6750603	219728217510	PI025
6756000	219728217510	PI025
6756157	219728217510	PI025
6757530	219728217510	PI025
6757531	219728217510	PI025
6757607	219728217510	PI025
6757702	219728217510	PI025
6758498	219728217510	PI025
6758525	219728217510	PI025
6758736	219972229250	ESS524
16116752626	219972201357	ESS522
16116755043	219972201357	ESS522
16116755044	219972201357	ESS522
16116759830	219972201369	ESS523
16116765925	219900000076	ESS0076A
16116768358	219900000076	ESS0076A
16117195471	219900000079	ESS0079A
16117195472	219900000079	ESS0079A
16121115862	219721287530	PI024
16121150201	219900000171	ESS0171A
16121184633	219728217510	PI025
16126751867	219728217510	PI025
16126756157	219728217510	PI025
16141178751	219721287530	PI024

OE/IAM	MAGNETI MARELLI	
	LONG	SHORT
J1	POMPA CARBURANTE FUEL PUMP	
BMW		
16141179232	219721287530	PI024
16141179415	219972229250	ESS524
16141179992	219900000129	ESS0129A
16141180318	219900000134	ESS0134A
16141180504	219972229250	ESS524
16141181294	219900000134	ESS0134A
16141181354	219900000134	ESS0134A
16141181862	219900000134	ESS0134A
16141181864	219900000134	ESS0134A
16141182109	219975009550	ESS518
16141182355	219975009550	ESS518
16141182842	219972229250	ESS524
16141182985	219972229250	ESS524
16141183009	219900000134	ESS0134A
16141183139	219972229250	ESS524
16141183176	219972201302	ESS519
16141183216	219972201302	ESS519
16141183947	219975009550	ESS518
16146752368	219972201302	ESS519
16146755456	219728217510	PI025
16146758736	219972229250	ESS524
BOSCH		
0580254003	219900000103	ESS0103A
0580254021	219900000105	ESS0105A
0580254051	219900000109	ESS0109A
0580254921	219900000112	ESS0112A
0580254941	219900000117	ESS0117A
0580254947	219900000118	ESS0118A
0580254950	219025499950	ESS528
0580254967	219900000122	ESS0122A
0580254979	219900000124	ESS0124A
0580254984	219900000126	ESS0126A
0580305002	219900000034	ESS0034A
0580305006	219900000034	ESS0034A
0580314064	219045399979	ESS534
0580314067	219900000128	ESS0128A
0580314068	219031409968	ESS529
0580314070	219900000129	ESS0129A
0580314073	219900000130	ESS0130A
0580314074	219900000131	ESS0131A
0580314076	219972229250	ESS524
0580314097	219031409997	ESS530
0580314122	219900000133	ESS0133A

OE/IAM	MAGNETI MARELLI	
	LONG	SHORT
J1	POMPA CARBURANTE FUEL PUMP	
BOSCH		
0580314123	219900000134	ESS0134A
0580314152	217555130000	ESS514
0580314153	219900000034	ESS0034A
0580314156	217555130000	ESS514
0580314164	217555130000	ESS514
0580314165	217555130000	ESS514
0580453019	219900000129	ESS0129A
0580453408	219045349908	ESS531
0580453420	219900000138	ESS0138A
0580453465	219045349965	ESS532
0580453485	219900000143	ESS0143A
0580453494	219045349994	ESS533
0580453502	217555130000	ESS514
0580453507	219900000034	ESS0034A
0580453508	217555130000	ESS514
0580453514	217555130000	ESS514
0580453517	217555130000	ESS514
0580453911	219900000144	ESS0144A
0580453966	219031409997	ESS530
0580453976	219031409997	ESS530
0580453979	219045399979	ESS534
0580453984	219031409997	ESS530
0580453985	219031409997	ESS530
0580454007	219900000028	ESS0028A
0580454014	219900000028	ESS0028A
0580454138	219900000138	ESS0138A
0580454140	219045349965	ESS532
0580463010	219721287530	PI024
0580463011	219721287530	PI024
0580463012	219721287530	PI024
0580463013	219721287530	PI024
0580463014	219721287530	PI024
0580463015	219721287530	PI024
0580463016	219721287530	PI024
0580463017	219721287530	PI024
0580464008	219721287530	PI024
0580464013	219721287530	PI024
0580464014	219721287530	PI024
0580464015	219721287530	PI024
0580464019	219721287530	PI024
0580464020	219721287530	PI024
0580464023	219721287530	PI024
0580464032	219721287530	PI024

OE/IAM	 LONG SHORT	
--------	-------------------------------------	--

J1	POMPA CARBURANTE FUEL PUMP
-----------	---------------------------------------

BOSCH		
0580464033	219721287530	PI024
0580464038	219721287530	PI024
0580464041	219900000162	ESS0162A
0580464048	219721287530	PI024
0580464050	219721287530	PI024
0580464055	219721287530	PI024
0580464056	219721287530	PI024
0580464068	219900000162	ESS0162A
0580464070	219721287530	PI024
0580464077	219900000164	ESS0164A
0580464084	219900000165	ESS0165A
0580464085	219721287530	PI024
0580464089	219046409989	ESS535
0580464090	219900000167	ESS0167A
0580464094	219900000167	ESS0167A
0580464096	219900000168	ESS0168A
0580464098	219900000169	ESS0169A
0580464103	219046419903	ESS536
0580464121	219900000170	ESS0170A
0580464122	219900000170	ESS0170A
0580464126	219900000171	ESS0171A
0580464981	219046499981	ESS537
0580464990	219900000172	ESS0172A
0580464996	219900000173	ESS0173A
0580464997	219900000174	ESS0174A
0986580129	219972201302	ESS519
0986580130	219972201357	ESS522
0986580131	219728217510	PI025
0986580350	219730109902	ESS273/1
0986580354	219728126510	PI028
0986580372	219722156500	PI027
0986580512	219900000165	ESS0165A
0986AG1303	219900000026	ESS0026A
F000TE0103	219900000040	ESS0040A
DACIA		
6000591702	219045349994	ESS533
DELPHI		
BCD00101	219721287530	PI024
FE1008412B1	219025499950	ESS528
FE1008812B1	219728217510	PI025
FE2002512B1	620504010061	PB507
FE2002612B1	219900000039	ESS0039A
FH10047	219031409997	ESS530

OE/IAM	 LONG SHORT	
--------	-------------------------------------	--

J1	POMPA CARBURANTE FUEL PUMP
-----------	---------------------------------------

DENSO		
DFP0103	219900000032	ESS0032A
DFP0106	219900000021	ESS0021A
ERA		
770001	219045349908	ESS531
770005	219721287530	PI024
770006	219046499981	ESS537
770009	219046409989	ESS535
770011	217750715000	ESS452
770016	219900000092	ESS0092A
770018	219900000090	ESS0090A
770024	219900000096	ESS0096A
770029	219722156500	PI027
770030	219025499950	ESS528
770031	219728217510	PI025
770037	219900000031	ESS0031A
770042	219045349965	ESS532
770047	219900000042	ESS0042A
770048	217555130000	ESS514
770050	219728126510	PI028
770063	219900000021	ESS0021A
770066	219046419903	ESS536
770069	219972201302	ESS519
770072	219900000134	ESS0134A
770084	219900000171	ESS0171A
770089	219900000129	ESS0129A
770090	219031409968	ESS529
770101	219900000168	ESS0168A
770111	219900000112	ESS0112A
770116	219900000164	ESS0164A
770118	219900000095	ESS0095A
770122	219900000124	ESS0124A
770124	219900000039	ESS0039A
770129	219045399979	ESS534
770130	219900000128	ESS0128A
770131	219900000034	ESS0034A
770132	219900000173	ESS0173A
770133	219900000174	ESS0174A
770137	219900000143	ESS0143A
770139	219972201357	ESS522
770142	219900000172	ESS0172A
770148	219900000165	ESS0165A
770152	219900000080	ESS0080A
770153	219900000138	ESS0138A

OE/AM	MAGNETI MARELLI	
	LONG	SHORT
J1	POMPA CARBURANTE FUEL PUMP	
ERA		
770016B	219900000092	ESS0092A
770047B	219900000042	ESS0042A
770089B	219900000129	ESS0129A
770124B	219900000039	ESS0039A
FCA		
121727	219900000118	ESS0118A
155592	219900000172	ESS0172A
4075445	219900000096	ESS0096A
4419617	219900000096	ESS0096A
4421193	219721287530	PI024
4429209	219721287530	PI024
4460210	219721287530	PI024
4460646	219721287530	PI024
4638624	219900000096	ESS0096A
5968084	219900000173	ESS0173A
5968085	219900000174	ESS0174A
6081037	219721287530	PI024
7153374	219045399979	ESS534
7555130	217555130000	ESS514
7580214	219900000173	ESS0173A
7580215	219900000174	ESS0174A
7635535	219721287530	PI024
7688480	219045399979	ESS534
7747117	219730109902	ESS273/1
7788694	219900000039	ESS0039A
7789626	219045349908	ESS531
7799543	217555130000	ESS514
7799563	217555130000	ESS514
44606460	219721287530	PI024
46443198	219900000040	ESS0040A
46447569	219046499981	ESS537
46473397	219730109902	ESS273/1
46475058	219900000040	ESS0040A
46475717	219900000095	ESS0095A
46742145	219046499981	ESS537
46809220	219900000040	ESS0040A
46809221	219900000040	ESS0040A
46822767	219900000167	ESS0167A
46831949	217750715000	ESS452
50008952	219900000040	ESS0040A
50014453	219900000040	ESS0040A
50017067	219900000040	ESS0040A
60521992	219721287530	PI024

OE/AM	MAGNETI MARELLI	
	LONG	SHORT
J1	POMPA CARBURANTE FUEL PUMP	
FCA		
60537611	219900000144	ESS0144A
60546091	219721287530	PI024
60800164	219900000174	ESS0174A
60805158	219900000174	ESS0174A
60810370	219721287530	PI024
60812839	219045349908	ESS531
71737182	219045399979	ESS534
71737902	217555130000	ESS514
75551300	217555130000	ESS514
75802140	219900000173	ESS0173A
82308678	219721287530	PI024
82350177	219721287530	PI024
82360177	219721287530	PI024
82490847	219900000040	ESS0040A
93828642	219046419903	ESS536
605219920	219721287530	PI024
605460910	219721287530	PI024
11646010210	219721287530	PI024
116460102100	219721287530	PI024
116460402100	219721287530	PI024
119110402100	219721287530	PI024
164100402100	219900000174	ESS0174A
FORD		
1211989	219900000168	ESS0168A
1711133	219900000168	ESS0168A
6150295	219900000117	ESS0117A
1S7U9350DA	219900000168	ESS0168A
1S7U9A407DA	219900000168	ESS0168A
84BB9350AA	219900000117	ESS0117A
VPXS6U9350CB	219900000030	ESS0030A
GENERAL MOTORS		
25117454	219900000039	ESS0039A
25163328	219900000039	ESS0039A
25163464	219900000039	ESS0039A
HYUNDAI		
3111126900	219900000165	ESS0165A
3111126930	219900000169	ESS0169A
INTERMOTOR		
31535	219900000129	ESS0129A
31585	219900000092	ESS0092A
IVECO		
93828642	219046419903	ESS536

OE/AM	MAGNETI MARELLI	
	LONG	SHORT
J1	POMPA CARBURANTE FUEL PUMP	
JAGUAR		
CAC2026	219721287530	PI024
CAC2263	219721287530	PI024
CAC4269	219721287530	PI024
CBC5657	219721287530	PI024
KAGER		
520017	217750715000	ESS452
520021	217555130000	ESS514
520040	219721287530	PI024
520070	219721287530	PI024
520071	219721287530	PI024
520072	219721287530	PI024
520083	219045349908	ESS531
520092	219728217510	PI025
520113	219721287530	PI024
KIA		
3111107000	219900000021	ESS0021A
LAND ROVER		
LR014301	219900000076	ESS0076A
PRC7196*	219900000039	ESS0039A
PRC8318*	219900000039	ESS0039A
PRC9409*	219900000039	ESS0039A
WQB100480	219728217510	PI025
LUCAS ELECTRICAL		
FDB1036	219900000129	ESS0129A
FDB752	219900000092	ESS0092A
MAPCO		
22059	217555130000	ESS514
22301	219721287530	PI024
22711	219045349965	ESS532
22714	219031409997	ESS530
22885	219031409968	ESS529
22980	219721287530	PI024
MEAT & DORIA		
70032	219900000030	ESS0030A
70054	219900000103	ESS0103A
70089	219900000112	ESS0112A
76007	219900000122	ESS0122A
76034	219721287530	PI024
76077	219900000109	ESS0109A
76078	219025499950	ESS528
76099	219722156500	PI027
76102	219900000090	ESS0090A
76179	219045399979	ESS534

OE/AM	MAGNETI MARELLI	
	LONG	SHORT
J1	POMPA CARBURANTE FUEL PUMP	
MEAT & DORIA		
76194	217555130000	ESS514
76201	217750715000	ESS452
76202	219045399979	ESS534
76295	219900000131	ESS0131A
76296	219730109902	ESS273/1
76297	219900000092	ESS0092A
76387	219031409997	ESS530
76391	219900000095	ESS0095A
76393	219900000032	ESS0032A
76395	219900000096	ESS0096A
76402	219900000129	ESS0129A
76403	219972229250	ESS524
76417	219031409968	ESS529
76514	217555130000	ESS514
76599	219728217510	PI025
76616	219900000134	ESS0134A
76617	219900000174	ESS0174A
76808	219046499981	ESS537
76815	219046419903	ESS536
76817	219900000164	ESS0164A
76855	219046409989	ESS535
76862	219972201302	ESS519
76863	219728126510	PI028
76878	219900000021	ESS0021A
76923	219900000124	ESS0124A
76961	219900000128	ESS0128A
76971	219900000031	ESS0031A
76982	219972201357	ESS522
76987	219900000015	ESS0015A
77003	219900000165	ESS0165A
77085	219900000080	ESS0080A
77092	219900000003	ESS0003A
77093	219900000079	ESS0079A
77094	219900000076	ESS0076A
77235	219900000170	ESS0170A
77283	219900000081	ESS0081A
77346	219900000028	ESS0028A
77349	219975009550	ESS518
76387/1	219031409997	ESS530
76387/1M	219031409997	ESS530

OE/IAM

MAGNETI
MARELLI

LONG

SHORT

J1

POMPA CARBURANTE
FUEL PUMP

MERCEDES-BENZ

0020915901	219025499950	ESS528
0020918801	219025499950	ESS528
0030915301	219025499950	ESS528
A0004704994	219722020500	PI026
A0004705494	219722020500	PI026
A0004705994	219722156500	PI027
A0004706094	219722156500	PI027
A0004706394	219722020500	PI026
A0004706794	219722156500	PI027
A0004707894	219722156500	PI027
A0004709594	219722156500	PI027
A0004780001	219722156500	PI027
A0014701294	219728126510	PI028
A0014708794	219900000077	ESS0077A
A0020910701	219900000126	ESS0126A
A0020910801	219900000126	ESS0126A
A0020910901	219900000126	ESS0126A
A0020911301	219900000126	ESS0126A
A0020915901	219025499950	ESS528
A0020918801	219025499950	ESS528
A0030915301	219025499950	ESS528

MEYLE

2009190000	217555130000	ESS514
3149190000	219721287530	PI024

NISSAN

170425F610	219900000143	ESS0143A
170429F500	219900000143	ESS0143A
170429F610	219900000143	ESS0143A

OPEL

815001	219031409997	ESS530
815004	219721287530	PI024
815005	219721287530	PI024
815008	219721287530	PI024
815011	219721287530	PI024
815013	219031409997	ESS530
815031	219031409997	ESS530
815036	219031409997	ESS530
5815000	219728217510	PI025
9119098	219031409997	ESS530
9120218	219045349965	ESS532
9292723	219721287530	PI024
90020443	219721287530	PI024
90136950	219721287530	PI024

OE/IAM

MAGNETI
MARELLI

LONG

SHORT

J1

POMPA CARBURANTE
FUEL PUMP

OPEL

90167397	219721287530	PI024
90292723	219721287530	PI024
90322786	219031409997	ESS530
90349944	219721287530	PI024
90411794	219031409997	ESS530
90411912	219031409997	ESS530
90442231	219031409997	ESS530
90442402	219031409997	ESS530
90541593	219031409997	ESS530
90571033	219031409997	ESS530
93174897	219728217510	PI025
93181358	219031409997	ESS530

PIERBURG

72191350	219900000134	ESS0134A
75011200	219900000003	ESS0003A
75011250	219900000003	ESS0003A
100000120	219900000079	ESS0079A
702550550	219900000042	ESS0042A
702700700	217555130000	ESS514
702701700	219900000128	ESS0128A
718259500	219031409968	ESS529
721287530	219721287530	PI024
721565710	219025499950	ESS528
721659530	219025499950	ESS528
721659700	219900000126	ESS0126A
721659720	219900000112	ESS0112A
721913500	219900000134	ESS0134A
722013020	219972201302	ESS519
722013570	219972201357	ESS522
722020500	219722020500	PI026
722156500	219722156500	PI027
728126510	219728126510	PI028
750007500	219900000076	ESS0076A
750022500	219900000079	ESS0079A
750046500	219900000077	ESS0077A
750051600	219728217510	PI025
750103500	219900000080	ESS0080A
750112500	219900000003	ESS0003A
750133500	219972229250	ESS524
750137510	219900000080	ESS0080A
750138000	219900000081	ESS0081A
750166500	219046409989	ESS535

OE/IAM	MAGNETI MARELLI	
	LONG	SHORT

J1	POMPA CARBURANTE FUEL PUMP
-----------	---------------------------------------

PSA		
145040	219900000126	ESS0126A
145054	219900000171	ESS0171A
145059	219721287530	PI024
145064	219900000124	ESS0124A
145083	219900000144	ESS0144A
145091	217555130000	ESS514
0000145504	219900000034	ESS0034A
145504	219900000034	ESS0034A
0000145504	219900000034	ESS0034A
145505	219900000095	ESS0095A
152552	219900000092	ESS0092A
152594	219900000092	ESS0092A
547166	219721287530	PI024
5471660	219721287530	PI024
34023301	217555130000	ESS514
91538806	219721287530	PI024
91539329	219900000144	ESS0144A
96007671	217555130000	ESS514
96138406	219900000034	ESS0034A
7910246476	219900000126	ESS0126A
9151404980	219721287530	PI024
9153880680	219721287530	PI024
9600767180	217555130000	ESS514
9680352880	219900000015	ESS0015A
9900062000	219900000034	ESS0034A
9999163388	219900000124	ESS0124A
1525KJ	219900000015	ESS0015A
MSS076	219900000095	ESS0095A

RENAULT		
---------	--	--

5010435234	219900000164	ESS0164A
6001000470	219900000117	ESS0117A
6001008001	219721287530	PI024
7700426361	219046409989	ESS535
7700582695	219721287530	PI024
7700687710	219721287530	PI024
7700739914	219900000144	ESS0144A
7700802178	219900000131	ESS0131A
7700802179	219900000131	ESS0131A
7700802180	219900000130	ESS0130A
7700807295	219900000130	ESS0130A
7700808861	219900000130	ESS0130A
7700808949	219900000131	ESS0131A
7700828784	219900000130	ESS0130A

OE/IAM	MAGNETI MARELLI	
	LONG	SHORT

J1	POMPA CARBURANTE FUEL PUMP
-----------	---------------------------------------

RENAULT		
7700828785	219900000131	ESS0131A
7700840871	219900000090	ESS0090A
7700855358	219721287530	PI024
7701062086	219721287530	PI024
7711064162	219900000117	ESS0117A
7910246476	219900000117	ESS0117A
8200639432	219046409989	ESS535
R100119328	219721287530	PI024

ROVER		
-------	--	--

AUU1649	219721287530	PI024
ERJ197	219900000092	ESS0092A
WFX100631	219900000092	ESS0092A
WQB100480	219728217510	PI025

SIDAT		
-------	--	--

70002	217750715000	ESS452
70052	219721287530	PI024
70068	219031409968	ESS529
70069	219721287530	PI024
70070	219721287530	PI024
70076	219728217510	PI025
70079	219046409989	ESS535
70081	219721287530	PI024
70088	219900000126	ESS0126A
70104	219900000021	ESS0021A
70106	219728126510	PI028
70108	219046419903	ESS536
70109	219972201302	ESS519
70112	219900000031	ESS0031A
70116	219900000032	ESS0032A
70118	219046499981	ESS537
70119	219900000164	ESS0164A
70125	219900000131	ESS0131A
70126	219900000130	ESS0130A
70130	219972201357	ESS522
70134	219900000095	ESS0095A
70137	219900000128	ESS0128A
70141	219972229250	ESS524
70143	219900000133	ESS0133A
70145	219900000109	ESS0109A
70146	219900000165	ESS0165A
70147	219900000167	ESS0167A
70149	219900000169	ESS0169A
70152	219900000077	ESS0077A

OE/IAM	MAGNETI MARELLI	
	LONG	SHORT
J1	POMPA CARBURANTE FUEL PUMP	
SIDAT		
70154	219900000079	ESS0079A
70155	219900000003	ESS0003A
70164	219900000090	ESS0090A
70170	219900000080	ESS0080A
70171	219900000076	ESS0076A
70179	219900000028	ESS0028A
70180	219975009550	ESS518
70400	219900000015	ESS0015A
70401	219721287530	PI024
70403	219721287530	PI024
70408	219045349908	ESS531
70412	219721287530	PI024
70414	219721287530	PI024
70432	219721287530	PI024
70438	219721287530	PI024
70460	219900000138	ESS0138A
70465	219045349965	ESS532
70467	219900000081	ESS0081A
70477	219900000170	ESS0170A
70492	219900000103	ESS0103A
70496	219900000042	ESS0042A
70507	219900000034	ESS0034A
70514	217555130000	ESS514
70906	219900000172	ESS0172A
70907	219900000173	ESS0173A
70909	219900000122	ESS0122A
70910	219900000112	ESS0112A
70947	219900000118	ESS0118A
70950	219025499950	ESS528
70966	219031409997	ESS530
70976	219900000124	ESS0124A
70979	219045399979	ESS534
70997	219900000174	ESS0174A
73044	219900000040	ESS0040A
SIEMENS VDO		
228225009001	219900000042	ESS0042A
228225009002	219900000042	ESS0042A
228225009003	219900000042	ESS0042A
228225021003	219900000042	ESS0042A
993784025X	219045349965	ESS532
E22041035	219900000042	ESS0042A
E22041055Z	219900000042	ESS0042A
E22041059	219900000042	ESS0042A

OE/IAM	MAGNETI MARELLI	
	LONG	SHORT
J1	POMPA CARBURANTE FUEL PUMP	
SIEMENS VDO		
E22041059Z	219900000042	ESS0042A
X10736002006	620504010061	PB507
X10736002007	219900000039	ESS0039A
SUZUKI		
1510068DB1LCP	219046409989	ESS535
TI AUTOMOTIVE		
7800200	217555130000	ESS514
72128753	219721287530	PI024
72201302	219972201302	ESS519
72201357	219972201357	ESS522
72201369	219972201369	ESS523
72215650	219722156500	PI027
72229250	219972229250	ESS524
72812651	219728126510	PI028
72821751	219728217510	PI025
75000750	219900000076	ESS0076A
75004650	219900000077	ESS0077A
75009550	219975009550	ESS518
75010350	219900000080	ESS0080A
75013150	219900000079	ESS0079A
75013750	219900000080	ESS0080A
75013751	219900000080	ESS0080A
75013800	219900000081	ESS0081A
000ESS382	219730109902	ESS273/1
AOR164	219900000090	ESS0090A
AOU202	219900000090	ESS0090A
ERJ237	219900000092	ESS0092A
ERJ305	219900000092	ESS0092A
ESS276	219900000095	ESS0095A
ESS287	219900000096	ESS0096A
ESS290	219900000095	ESS0095A
ESS291	219900000095	ESS0095A
ESS452	217750715000	ESS452
GSS284	219900000031	ESS0031A
TTP479	219900000015	ESS0015A
TOYOTA		
2322003040	219900000026	ESS0026A
2322074021	219900000026	ESS0026A
2322111050	219900000026	ESS0026A
2322116490	219900000026	ESS0026A
2322120040	219900000026	ESS0026A
2322123010	219900000032	ESS0032A
2322123020	219900000032	ESS0032A

OE/IAM	MAGNETI MARELLI	
	LONG	SHORT

J1	POMPA CARBURANTE FUEL PUMP
-----------	---------------------------------------

TOYOTA		
2322128020	219900000026	ESS0026A
2322146010	219900000026	ESS0026A
VAG		
002024398	219721287530	PI024
043906091	219721287530	PI024
043906091	219721287530	PI024
251906091	219721287530	PI024
373919051	219900000040	ESS0040A
376919051	219900000040	ESS0040A
441906091	219900000103	ESS0103A
2739190513	219900000040	ESS0040A
3059060911	219721287530	PI024
3259190511	219900000040	ESS0040A
32591905119	219900000040	ESS0040A
91160810200	219900000126	ESS0126A
91160810200	219900000124	ESS0124A
91160810202	219900000122	ESS0122A
92309490635	219721287530	PI024
92860810200	219900000126	ESS0126A
93060811101	219900000124	ESS0124A
93060811300	219900000124	ESS0124A
171906091A	219900000171	ESS0171A
191906092D	219900000105	ESS0105A
1H0919051C	219900000042	ESS0042A
1H0919051Q	219900000042	ESS0042A
1H0919651N	219900000042	ESS0042A
1H9919051E	219900000042	ESS0042A
1K0906089	219900000003	ESS0003A
1K0906089A	219900000170	ESS0170A
1K0906089B	219900000003	ESS0003A
1K0906089C	219900000003	ESS0003A
1L0919051D	219900000042	ESS0042A
2P0201758	219900000164	ESS0164A
377919051AE	219900000040	ESS0040A
3R0906095	219900000080	ESS0080A
441906087E	219031409968	ESS529
441906091C	219031409968	ESS529
441906091C/E/F	219031409968	ESS529
441906091E	219031409968	ESS529
441906091F	219031409968	ESS529
4A0906087A	219031409968	ESS529
547919051AD	219900000040	ESS0040A
5N0906129B	219900000170	ESS0170A

OE/IAM	MAGNETI MARELLI	
	LONG	SHORT

J1	POMPA CARBURANTE FUEL PUMP
-----------	---------------------------------------

VAG		
6L0919051D	219900000042	ESS0042A
6N0919051J	219900000042	ESS0042A
893906091B	219900000112	ESS0112A
893906091E	219900000112	ESS0112A
895906091C	219031409968	ESS529
895906091C/D	219031409968	ESS529
895906091D	219031409968	ESS529
8A0906091A	219031409968	ESS529
8A0906091A/G	219031409968	ESS529
8A0906091G	219031409968	ESS529
8G0906091A	219900000109	ESS0109A
8K0906095A	219900000080	ESS0080A
8K0906095B	219900000080	ESS0080A
VALEO		
247173	219721287530	PI024
347203	219900000092	ESS0092A
347209	219031409968	ESS529
347213	219972229250	ESS524
347214	219900000134	ESS0134A
347220	219972201302	ESS519
347221	219900000131	ESS0131A
347222	219900000130	ESS0130A
347223	219900000128	ESS0128A
347226	217555130000	ESS514
347228	219972201357	ESS522
347229	219972201369	ESS523
347235	217750715000	ESS452
347251	219045349908	ESS531
347302	219900000122	ESS0122A
347304	219721287530	PI024
347310	219025499950	ESS528
347312	219728217510	PI025
347317	219900000003	ESS0003A
347319	219046409989	ESS535
216796943	219721287530	PI024
VEMO		
V24090001	217555130000	ESS514
V24090004	219046499981	ESS537
V30090002	219025499950	ESS528
V40090001	219721287530	PI024
V40090002	219045349965	ESS532
V46090001	219046409989	ESS535
V70090004	219045349908	ESS531

OE/AM	MAGNETI MARELLI	
	LONG	SHORT
J1	POMPA CARBURANTE FUEL PUMP	
VOLVO		
285211	219900000162	ESS0162A
1306932	219900000162	ESS0162A
8621318	219900000133	ESS0133A
9142044	219900000162	ESS0162A
9438759	219900000128	ESS0128A
9447060	219900000138	ESS0138A
9470674	219900000128	ESS0128A
9480152	219900000128	ESS0128A
30794624	219900000133	ESS0133A
AOU202	219900000090	ESS0090A

OE/AM	MAGNETI MARELLI	
	LONG	SHORT
J1	POMPA CARBURANTE (CON VASO ANTIROLLIO) FUEL PUMP	
AIRTEX		
E10297M	219900000045	ESS0045A
ERA		
770041	219900000045	ESS0045A
770041B	219900000045	ESS0045A
FORD		
1094199	219900000045	ESS0045A
1108767	219900000045	ESS0045A
1108768	219900000045	ESS0045A
96VW9H307BB	219900000045	ESS0045A
96VW9H307CB	219900000045	ESS0045A
YM219H307CA	219900000045	ESS0045A
YM219H307DA	219900000045	ESS0045A
LUCAS ELECTRICAL		
FDB778	219900000045	ESS0045A
PIERBURG		
702550540	219900000045	ESS0045A
SIDAT		
70025	219900000045	ESS0045A
SIEMENS VDO		
228230003001	219900000045	ESS0045A
228231001001	219900000045	ESS0045A
228231002001	219900000045	ESS0045A
228233003001	219900000045	ESS0045A
228233004001	219900000045	ESS0045A
228233008003	219900000045	ESS0045A
228233008004	219900000045	ESS0045A
228233008005	219900000045	ESS0045A
228233008006	219900000045	ESS0045A
405058001003	219900000045	ESS0045A

OE/AM	MAGNETI MARELLI	
	LONG	SHORT
J1	POMPA CARBURANTE (CON VASO ANTIROLLIO) FUEL PUMP	
SIEMENS VDO		
405058001002Z	219900000045	ESS0045A
E22041084	219900000045	ESS0045A
E22041095	219900000045	ESS0045A
E22041095Z	219900000045	ESS0045A
VAG		
1GD919051B	219900000045	ESS0045A
1J0919051K	219900000045	ESS0045A
6X0919051C	219900000045	ESS0045A
6X0919051E	219900000045	ESS0045A
6X0919051G	219900000045	ESS0045A
6X0919056	219900000045	ESS0045A
6X0919056E	219900000045	ESS0045A
6X0919056G	219900000045	ESS0045A
6X0919087B	219900000045	ESS0045A
7M0919051H	219900000045	ESS0045A
7M0919051J	219900000045	ESS0045A
7M0919087B	219900000045	ESS0045A
7M3919051	219900000045	ESS0045A
7M3919051A	219900000045	ESS0045A

OE/AM	MAGNETI MARELLI	
	LONG	SHORT
J1	POMPA CARBURANTE KIT FUEL PUMP KIT	
AIRTEX		
E10355	219900000018	ESS0018A
E10356	219900000019	ESS0019A
E10491	219900000074	ESS0074A
E10543	219900000083	ESS0083A
E10611	219900000075	ESS0075A
E10629	219900000072	ESS0072A
BMW		
1183389	219900000074	ESS0074A
16117195463	219900000061	ESS0061A
16117195464	219900000061	ESS0061A
16117195466	219900000061	ESS0061A
16117195467	219900000061	ESS0061A
16117204762	219900000061	ESS0061A
16117204764	219900000061	ESS0061A
16141183178	219900000074	ESS0074A
16141183389	219900000074	ESS0074A
16141184276	219900000082	ESS0082A
16146752499	219900000082	ESS0082A
16146755878	219900000059	ESS0059A
16146766942	219900000082	ESS0082A

OE/IAM	MAGNETI MARELLI	
	LONG	SHORT

J1	POMPA CARBURANTE KIT <i>FUEL PUMP KIT</i>
-----------	---

BOSCH		
0580203041	219900000068	ESS0068A
0580203042	219900000068	ESS0068A
0580203104	219900000068	ESS0068A
0580303003	219900000066	ESS0066A
0580303015	219900000066	ESS0066A
0580303035	219900000066	ESS0066A
0580303046	219900000066	ESS0066A
0580303101	219900000068	ESS0068A
0580303106	219900000068	ESS0068A
0580314079	519780069901	SUA507
0580314154	219978006002	ESS525
0580453427	219900000025	ESS0025A
0580453509	219978006002	ESS525
0986580161	219782099900	ESS515
0986580350	219730109900	ESS273
0986580506	519770019900	SUA484
0986580807	219900000089	ESS0089A
0986580822	219900000057	ESS0057A
0986580965	519770209901	SUA487
1582980083	219900000089	ESS0089A
DAEWOO		
96143350	519770019900	SUA484
96180403	519770019900	SUA484
96180404	519770019900	SUA484
96180483	519770019900	SUA484
96350078	519770019900	SUA484
96351494	519770019900	SUA484
96351495	519770019900	SUA484
96494976	519770019900	SUA484
DELPHI		
FE2001612B1	219900000014	ESS0014A
FE2002112B1	219900000014	ESS0014A
FE2002312B1	219900000014	ESS0014A
DENSO		
2322075040	219900000027	ESS0027A
232200H110	219900000027	ESS0027A
ERA		
770002	219900000025	ESS0025A
770007	219978006002	ESS525
770010	219730109900	ESS273
770022	219900000083	ESS0083A
770043	219900000018	ESS0018A
770045	219900000019	ESS0019A

OE/IAM	MAGNETI MARELLI	
	LONG	SHORT

J1	POMPA CARBURANTE KIT <i>FUEL PUMP KIT</i>
-----------	---

ERA		
770051	219900000074	ESS0074A
770052	219900000071	ESS0071A
770097	219900000091	ESS0091A
770114	219978163004	ESS520
770117	219782099900	ESS515
770120	519770209900	SUA486
770121	219900000014	ESS0014A
770123	219900000089	ESS0089A
770146	219900000073	ESS0073A
770154	219900000072	ESS0072A
770156	219900000057	ESS0057A
770043B	219900000018	ESS0018A
770045B	219900000019	ESS0019A
770051B	219900000074	ESS0074A
770121B	219900000014	ESS0014A
FCA		
4637192	219900000014	ESS0014A
4637193	219900000014	ESS0014A
46480607	219900000025	ESS0025A
46807824	219900000066	ESS0066A
60551969	219900000025	ESS0025A
60628083	219900000066	ESS0066A
60651969	219900000025	ESS0025A
60664014	219900000066	ESS0066A
60664024	219900000066	ESS0066A
60664055	219900000066	ESS0066A
60678456	219900000066	ESS0066A
60678457	219900000066	ESS0066A
83503634	219900000014	ESS0014A
FORD		
1009230	519770209901	SUA487
1009231	519770209901	SUA487
1012215	219900000083	ESS0083A
1017455	519770209901	SUA487
1025247	519770209901	SUA487
1026231	219900000083	ESS0083A
1026232	219900000083	ESS0083A
1027981	519770209901	SUA487
1028808	219900000018	ESS0018A
1047279	519770209901	SUA487
1047280	219900000018	ESS0018A
1052912	219900000083	ESS0083A
1053379	519770209901	SUA487

OE/IAM	MAGNETI MARELLI	
	LONG	SHORT
J1	POMPA CARBURANTE KIT FUEL PUMP KIT	
FORD		
1054409	519770209901	SUA487
1067973	519770209901	SUA487
1073602	519770209901	SUA487
1075526	219900000083	ESS0083A
1092700	219900000083	ESS0083A
1092701	219900000083	ESS0083A
1094664	219900000083	ESS0083A
1112797	519770209900	SUA486
1112813	219900000083	ESS0083A
1118637	519770209900	SUA486
1118640	219900000083	ESS0083A
6697059	519770209900	SUA486
6937974	519770209900	SUA486
6960061	219900000083	ESS0083A
7018450	519770209900	SUA486
7148941	219900000083	ESS0083A
7362847	519770209900	SUA486
91AB9H307	219900000014	ESS0014A
95VW9H307AC	219900000018	ESS0018A
96FP9H307AA	519770209901	SUA487
96FP9H307AB	519770209901	SUA487
96FP9H307AC	519770209901	SUA487
96FP9H307AD	519770209901	SUA487
96FP9H307CA	519770209901	SUA487
96FP9H307CB	519770209901	SUA487
96FP9H307CC	519770209901	SUA487
96FP9H307CD	519770209901	SUA487
96VW9H307AA	219900000018	ESS0018A
98FP9H307AA	519770209901	SUA487
98FP9H307CA	519770209901	SUA487
GENERAL MOTORS		
6442643	219900000014	ESS0014A
6443008	219900000014	ESS0014A
6443037	219900000014	ESS0014A
6443271	219900000014	ESS0014A
6443306	219900000014	ESS0014A
6443308	219900000014	ESS0014A
6448296	219900000014	ESS0014A
6472143	219900000014	ESS0014A
6472148	219900000014	ESS0014A
6472229	219900000014	ESS0014A
6472322	219900000014	ESS0014A
6472373	219900000014	ESS0014A

OE/IAM	MAGNETI MARELLI	
	LONG	SHORT
J1	POMPA CARBURANTE KIT FUEL PUMP KIT	
GENERAL MOTORS		
6472375	219900000014	ESS0014A
6472393	219900000014	ESS0014A
6472451	219900000014	ESS0014A
6472489	219900000014	ESS0014A
6472490	219900000014	ESS0014A
6472524	219900000014	ESS0014A
6472527	219900000014	ESS0014A
6472541	219900000014	ESS0014A
6472987	219900000014	ESS0014A
6472998	219900000014	ESS0014A
6472999	219900000014	ESS0014A
25115155	219900000014	ESS0014A
25115224	219900000014	ESS0014A
25115254	219900000014	ESS0014A
25115260	219900000014	ESS0014A
25115428	219900000014	ESS0014A
25115429	219900000014	ESS0014A
25115466	219900000014	ESS0014A
25115467	219900000014	ESS0014A
25115689	219900000014	ESS0014A
25115767	219900000014	ESS0014A
25115768	219900000014	ESS0014A
25115769	219900000014	ESS0014A
25115978	219900000014	ESS0014A
25115979	219900000014	ESS0014A
25116053	219900000014	ESS0014A
25116156	219900000014	ESS0014A
25116161	219900000014	ESS0014A
25116162	219900000014	ESS0014A
25116163	219900000014	ESS0014A
25116167	219900000014	ESS0014A
25116168	219900000014	ESS0014A
25116296	219900000014	ESS0014A
25116458	219900000014	ESS0014A
INTERMOTOR		
31531	219900000083	ESS0083A
31553	219900000019	ESS0019A
31599	219900000018	ESS0018A
IVECO		
69500352	219900000068	ESS0068A
KAGER		
520078	219978006002	ESS525

OE/IAM	MAGNETI MARELLI	
	LONG	SHORT

J1	POMPA CARBURANTE KIT <i>FUEL PUMP KIT</i>
-----------	---

LAND ROVER

16116754762	219900000020	ESS0020A
16116763817	219900000020	ESS0020A

LUCAS ELECTRICAL

FDB1035	219900000083	ESS0083A
FDB719	219900000083	ESS0083A
FDB720	219900000083	ESS0083A
FDB721	219900000014	ESS0014A
FDB736	219900000019	ESS0019A
FDB769	219900000018	ESS0018A

MEAT & DORIA

70029	219900000018	ESS0018A
76101	219900000091	ESS0091A
76206	219900000083	ESS0083A
76380	219900000014	ESS0014A
76398	219900000019	ESS0019A
76423	219782099900	ESS515
76477	219730109900	ESS273
76574	519770209901	SUA487
76809	219900000016	ESS0016A
76891	519770209900	SUA486
76906	219900000020	ESS0020A
76919	519780069901	SUA507
76960	219978006002	ESS525
76976	219978163004	ESS520
76977	519770019900	SUA484
77083	219900000073	ESS0073A
77084	219900000075	ESS0075A
77263	219900000084	ESS0084A
77265	219900000072	ESS0072A
77274	219900000059	ESS0059A
77312	219900000027	ESS0027A
77372	219900000061	ESS0061A

MERCEDES-BENZ

A1634702894	219978163004	ESS520
A1634703594	219978163004	ESS520
A1634703794	219978163004	ESS520

OPEL

802310	219900000070	ESS0070A
815012	219978006002	ESS525
815019	519780069901	SUA507
815046	219900000089	ESS0089A
815047	219900000089	ESS0089A
816007	219900000089	ESS0089A

OE/IAM	MAGNETI MARELLI	
	LONG	SHORT

J1	POMPA CARBURANTE KIT <i>FUEL PUMP KIT</i>
-----------	---

OPEL

4700684	219900000057	ESS0057A
5815018	219900000070	ESS0070A
5815019	219900000070	ESS0070A
13116998	219900000070	ESS0070A
13116999	219900000070	ESS0070A
90297154	219978006002	ESS525
93171075	219900000089	ESS0089A
93173977	219900000089	ESS0089A
93174221	219900000089	ESS0089A
93183433	219900000089	ESS0089A
93183434	219900000089	ESS0089A
93183804	219900000089	ESS0089A
93184983	219900000089	ESS0089A
93184986	219900000089	ESS0089A
93184987	219900000089	ESS0089A
93185093	219900000089	ESS0089A
93186283	219900000089	ESS0089A
93188233	219900000089	ESS0089A
93188240	219900000089	ESS0089A
93188327	219900000070	ESS0070A

PIERBURG

70255056	219900000019	ESS0019A
72830300	219900000073	ESS0073A
75002100	219900000073	ESS0073A
75006801	219900000073	ESS0073A
75011160	219900000075	ESS0075A
10000070	219900000072	ESS0072A
700468700	219978163004	ESS520
702550560	219900000019	ESS0019A
702550580	219900000018	ESS0018A
702550610	219900000016	ESS0016A
702700910	219900000083	ESS0083A
702700910	219900000084	ESS0084A
702701280	219900000057	ESS0057A
702701430	219900000082	ESS0082A
702701560	219900000066	ESS0066A
702701580	219900000068	ESS0068A
702701660	219900000061	ESS0061A
728303600	219900000073	ESS0073A
728303700	219900000074	ESS0074A
750062500	219900000082	ESS0082A
750107500	219900000072	ESS0072A
750111600	219900000075	ESS0075A

OE/IAM	MAGNETI MARELLI	
	LONG	SHORT
J1	POMPA CARBURANTE KIT FUEL PUMP KIT	
PIERBURG		
750114500	219900000059	ESS0059A
750116500	219900000072	ESS0072A
PSA		
145545	219730109900	ESS273
6443333	219900000014	ESS0014A
152560*	219900000091	ESS0091A
152595*	219900000091	ESS0091A
1525S2	219900000066	ESS0066A
SAAB		
4021358	219900000083	ESS0083A
4021358	219900000084	ESS0084A
4161493	219900000083	ESS0083A
5328885	219900000083	ESS0083A
8822017	219900000083	ESS0083A
8822694	219900000083	ESS0083A
8981664	219900000083	ESS0083A
9321621	219900000083	ESS0083A
9321712	219900000083	ESS0083A
9321878	219900000083	ESS0083A
30587015	219900000083	ESS0083A
93183433	219900000089	ESS0089A
530587077	219900000083	ESS0083A
AOS005	219900000083	ESS0083A
AOS006	219900000083	ESS0083A
SIDAT		
70035	219900000019	ESS0019A
70122	219900000082	ESS0082A
70128	219900000071	ESS0071A
70129	219978163004	ESS520
70407	219900000020	ESS0020A
70416	219900000014	ESS0014A
70427	219900000025	ESS0025A
70430	219900000073	ESS0073A
70431	219900000075	ESS0075A
70434	219900000066	ESS0066A
70439	219900000083	ESS0083A
70446	219900000091	ESS0091A
70449	219900000072	ESS0072A
70452	219900000059	ESS0059A
70485	219900000016	ESS0016A
70502	219900000027	ESS0027A
72101	519770209901	SUA487
72103	519770209900	SUA486

OE/IAM	MAGNETI MARELLI	
	LONG	SHORT
J1	POMPA CARBURANTE KIT FUEL PUMP KIT	
SIEMENS VDO		
993763011	219900000018	ESS0018A
228231003001	219900000016	ESS0016A
228231003002	219900000016	ESS0016A
405052005001Z	219900000074	ESS0074A
993763011Z	219900000018	ESS0018A
E22041027	219900000019	ESS0019A
E22041027Z	219900000019	ESS0019A
E22041030	219900000019	ESS0019A
E22041047Z	219900000018	ESS0018A
E22041077	219900000016	ESS0016A
E22041077Z	219900000016	ESS0016A
X10736002004	219900000014	ESS0014A
TI AUTOMOTIVE		
7301000	219730109900	ESS273
7700100	519770019900	SUA484
7702000	519770209900	SUA486
7702001	519770209901	SUA487
7800601	519780069901	SUA507
7800602	219978006002	ESS525
7800604	219900000057	ESS0057A
7801004	219900000059	ESS0059A
7801007	219900000061	ESS0061A
7810202	219900000066	ESS0066A
7810204	219900000068	ESS0068A
7810600	219900000070	ESS0070A
7816300	219978163004	ESS520
7820900	219782099900	ESS515
7820901	219900000071	ESS0071A
7820902	219900000072	ESS0072A
7820904	219900000073	ESS0073A
7820905	219900000074	ESS0074A
7820906	219900000075	ESS0075A
7820907	219900000071	ESS0071A
75010750	219900000072	ESS0072A
750062500	219900000082	ESS0082A
19750058490	219900000084	ESS0084A
19780108485	219900000082	ESS0082A
19781029902	219900000066	ESS0066A
19781029904	219900000068	ESS0068A
5CA606	219900000083	ESS0083A
7800603CL	219900000089	ESS0089A
BOC109	219900000091	ESS0091A
BOC517	219900000091	ESS0091A

OE/IAM		 LONG SHORT	
J1	POMPA CARBURANTE KIT <i>FUEL PUMP KIT</i>		
TI AUTOMOTIVE			
ERJ286	219900000091	ESS0091A	
ERJ301	219900000091	ESS0091A	
MRJ119	219900000091	ESS0091A	
TTP467	219900000084	ESS0084A	
TTP515	219900000057	ESS0057A	
TOYOTA			
2322021131	219900000027	ESS0027A	
23220OP010	219900000027	ESS0027A	
VAG			
1C0919050	219900000075	ESS0075A	
1C0919050A	219900000075	ESS0075A	
1C0919050B	219900000075	ESS0075A	
1C0919050C	219900000075	ESS0075A	
1C0919050D	219900000075	ESS0075A	
1C0919050E	219900000075	ESS0075A	
1H0906091	219900000018	ESS0018A	
1H0906091D	219900000019	ESS0019A	
1H0919651H	219900000019	ESS0019A	
1J0919050B	219900000073	ESS0073A	
1J0919051C*	219900000016	ESS0016A	
1J0919051E*	219900000016	ESS0016A	
1J0919051H*	219900000016	ESS0016A	
1J0919087C*	219900000016	ESS0016A	
1J0919087D*	219900000016	ESS0016A	
1J0919087H	219900000016	ESS0016A	
1J0919087H*	219900000016	ESS0016A	
1K0919050G	219900000073	ESS0073A	
3C0919050B	219900000073	ESS0073A	
3C0919050D	219900000073	ESS0073A	
3C0919050E	219900000073	ESS0073A	
3C0919050F	219900000073	ESS0073A	
3C0919050G	219900000073	ESS0073A	
4B0906087B	219900000072	ESS0072A	

OE/IAM		 LONG SHORT	
J1	POMPA CARBURANTE KIT <i>FUEL PUMP KIT</i>		
VAG			
4B0906087E	219900000071	ESS0071A	
4B0906091A	219900000020	ESS0020A	
6K0919051C*	219900000016	ESS0016A	
6N0919051M*	219900000016	ESS0016A	
6N0919087F	219900000016	ESS0016A	
6Q0919051*	219900000016	ESS0016A	
6X0919051C*	219900000016	ESS0016A	
6X0919051E*	219900000016	ESS0016A	
6X0919051G*	219900000016	ESS0016A	
6X0919056*	219900000016	ESS0016A	
6X0919056E*	219900000016	ESS0016A	
6X0919056G*	219900000016	ESS0016A	
6X0919087B*	219900000016	ESS0016A	
6X0919087D*	219900000016	ESS0016A	
7M0919051H*	219900000016	ESS0016A	
7M0919051J*	219900000016	ESS0016A	
7M0919087D*	219900000016	ESS0016A	
7M3919051*	219900000016	ESS0016A	
7M3919051A*	219900000016	ESS0016A	
8D0906089	219782099900	ESS515	
8D0906089A	219782099900	ESS515	
8E0906087D	219900000071	ESS0071A	
8E0906087E	219900000072	ESS0072A	
8L0919087A*	219900000016	ESS0016A	
8L0919087E*	219900000016	ESS0016A	
8Z0919051*	219900000016	ESS0016A	
8Z0919051A*	219900000016	ESS0016A	
8Z0919051C*	219900000016	ESS0016A	
E22-041-058Z	219782099900	ESS515	
VALEO			
347215	519780069901	SUA507	
347216	219978006002	ESS525	

ITALY

Viale Aldo Borletti, 61/63
20011 Corbetta (Milano)
Tel. +39 02 928 15 111 • Fax +39 02 97227234

Export

Viale Aldo Borletti, 61/63
20011 Corbetta (Milano) Italy
Tel. +39/02/97227618 • Fax +39/02/97227755

SPAIN

Polígono Industrial G-2 Collsabadell
Ronda de Collsabadell, 1-3
08450, Llinars del Vallès, BCN
Tel. +34/93/8413530 • Fax +34/93/8427257

FRANCE

Z.A. Trappes Elancourt
5-7 rue Albert Einstein - 78190 Trappes
tel +33 (0)1 3016 6960 • Fax +33 (0)1 3016 6961

GERMANY

Salzstrasse 185/1
74076 Heilbronn
Tel. +49/7131/2910 • Fax +49/7131/165236

POLAND

Plac pod Lipami 5
40-476 Katowice
Tel. +48/32/6036107 • Fax +48/32/6036108

RUSSIA

3-j pr. Perowa Polia 8, buildg.11, office 301
111141 Moscow, Russia
Tel: + 7 495 646 24 38

BRAZIL

Rua Manoel da Nóbrega, 350
09380-120 Mauá-São Paulo
Tel. +55/11/2144-1717 • Fax +55/11/2144-1688

ARGENTINA

R. Andonaegui 1035
(C1427BEC) Capital Federal-Buenos Aires
Tel. +54/11/45236612 • Fax +54/11/45236613

CHINA

Building No 5, 88 Maji Road, Waigaoqiao Free Trade Zone,
200131 Pudong Shanghai
Tel. +86/21/58696966-6852 • Fax +86/21/58696907

TURKEY

Büyükdere Cad. Tofaş Han No.145
Zincirlikuyu, 34394 Istanbul-Turkey
Ph: +90 212 217 02 97 • Fax: +90 212 217 02 95

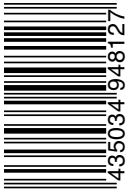

8 435034 948127

12-15 099995901503 Copyright Magneti Marelli After Market Parts and Services S.p.A. 2015

Magneti Marelli After Market Parts and Services S.p.A.

Viale Aldo Borletti, 61/63 - 20011 Corbetta (Milano) Italia - Tel. +39 02 928 15 111 - Fax +39 02 972 27 234
www.magnetimarelli-checkstar.com